

Pro-face

by **Schneider** Electric

Multi Display Adapter User Manual

The information provided in this documentation contains general descriptions and/or technical characteristics of the performance of the products contained herein. This documentation is not intended as a substitute for and is not to be used for determining suitability or reliability of these products for specific user applications. It is the duty of any such user or integrator to perform the appropriate and complete risk analysis, evaluation and testing of the products with respect to the relevant specific application or use thereof. Neither Schneider Electric nor any of its affiliates or subsidiaries (hereinafter, referred to as Schneider Electric) shall be responsible or liable for misuse of the information that is contained herein. If you have any suggestions for improvements or amendments or have found errors in this publication, please notify us.

You agree not to reproduce, other than for your own personal, noncommercial use, all or part of this document on any medium whatsoever without permission of Schneider Electric, given in writing. You also agree not to establish any hypertext links to this document or its content. Schneider Electric does not grant any right or license for the personal and noncommercial use of the document or its content, except for a non-exclusive license to consult it on an "as is" basis, at your own risk. All other rights are reserved.

All pertinent state, regional, and local safety regulations must be observed when installing and using this product. For reasons of safety and to help ensure compliance with documented system data, only the manufacturer should perform repairs to components.

When devices are used for applications with technical safety requirements, the relevant instructions must be followed.

Failure to use Schneider Electric software or approved software with our hardware products may result in injury, harm, or improper operating results.

Failure to observe this information can result in injury or equipment damage.

Copyright © 2019 Schneider Electric Japan Holdings Ltd. All rights reserved.



Table of Contents

	Safety Information	5
	About the Book	7
Chapter 1	Overview	9
	Package Contents and Revision	10
	Certifications and Standards	11
	Federal Communication Commission Radio Frequency Interference Statement - For USA	13
	Hazardous Location Installation - For USA and Canada	14
Chapter 2	Device Connectivity	17
	System Design	18
	About Touch Operation Exclusive Control	21
	Accessories	23
Chapter 3	Parts Identification and Functions	25
	Parts Identification	26
	LED Indications	27
Chapter 4	Specifications	29
	General Specifications	30
	Interface Specifications	32
Chapter 5	Dimensions	35
	External Dimensions	36
	Dimensions with Cables	37
Chapter 6	Installation and Wiring	39
	Installation	40
	DIO Connector	44
	VESA Mount Adapter	45
Chapter 7	Multi Display Adapter Settings	49
7.1	Utility Environment	50
	Operating Systems, Drivers, Utilities	50
7.2	Before Setup	51
	Workflow	52
	Setting Workflow	54
	Installing the MDA Utilities	57
7.3	MDA Configuration Tool	58
	Connection Setting	59
	MDA Setting	61
	Touch Operation Exclusive Control	65
	Window Recorder	66
7.4	Network Setting Tool/MDA Finder	68
	Introduction	69
	Network Setting Tool	70
	MDA Finder	74
Chapter 8	After-sales Service	79
	After-sales Service	79

Safety Information



Important Information

NOTICE

Read these instructions carefully, and look at the equipment to become familiar with the device before trying to install, operate, service, or maintain it. The following special messages may appear throughout this documentation or on the equipment to warn of potential hazards or to call attention to information that clarifies or simplifies a procedure.



The addition of this symbol to a “Danger” or “Warning” safety label indicates that an electrical hazard exists which will result in personal injury if the instructions are not followed.



This is the safety alert symbol. It is used to alert you to potential personal injury hazards. Obey all safety messages that follow this symbol to avoid possible injury or death.

DANGER

DANGER indicates a hazardous situation which, if not avoided, **will result in** death or serious injury.

WARNING

WARNING indicates a hazardous situation which, if not avoided, **could result in** death or serious injury.

CAUTION

CAUTION indicates a hazardous situation which, if not avoided, **could result in** minor or moderate injury.

NOTICE

NOTICE is used to address practices not related to physical injury.

PLEASE NOTE

Electrical equipment should be installed, operated, serviced, and maintained only by qualified personnel. No responsibility is assumed by Schneider Electric for any consequences arising out of the use of this material.

A qualified person is one who has skills and knowledge related to the construction and operation of electrical equipment and its installation, and has received safety training to recognize and avoid the hazards involved.

About the Book



At a Glance

Document Scope

This manual describes how to use this product.

Validity Note

This documentation is valid for this product.

The technical characteristics of the device(s) described in this manual also appear online at <http://www.pro-face.com/>.

The characteristics presented in the present document should be the same as those that appear online. In line with our policy of constant improvement we may revise content over time to improve clarity and accuracy. In the event that you see a difference between the document and online information, use the online information as your reference.

Registered Trademarks

Microsoft and Windows are registered trademarks of Microsoft Corporation in the United States and/or other countries.

Product names used in this manual may be the registered trademarks owned by the respective proprietors.

Related Documents

You can download the manuals related to this product, such as the software manual, from our support site at <http://www.pro-face.com/trans/en/manual/1001.html>.

Product Related Information

In the event this product does not run properly due to whatever reason, it may be difficult or impossible to identify a function. Functions that may present a hazard if not immediately executed, such as a fuel shut-off, must be provided independently of this product. The machine's control system design must take into account the operator being unable to control the machine or making mistakes in the control of the machine.

WARNING

LOSS OF CONTROL

- The designer of any control scheme must consider the potential failure modes of control paths and, for certain critical control functions, provide a means to achieve a safe state during and after a path failure. Examples of critical control functions are emergency stop and overtravel stop, power outage and restart.
- Separate or redundant control paths must be provided for critical control functions.
- System control paths may include communication links. Consideration must be given to the implications of unanticipated transmission delays or failures of the link.
- Observe all accident prevention regulations and local safety guidelines.
- Each implementation of this product must be individually and thoroughly tested for proper operation before being placed into service.
- The machine control system design must take into account the possibility of the backlight no longer functioning and the operator being unable to control the machine, or making errors in the control of the machine.

Failure to follow these instructions can result in death, serious injury, or equipment damage.

For additional information, refer to NEMA ICS 1.1 (latest edition), "Safety Guidelines for the Application, Installation, and Maintenance of Solid State Control" and to NEMA ICS 7.1 (latest edition), "Safety Standards for Construction and Guide for Selection, Installation and Operation of Adjustable-Speed Drive Systems" or their equivalent governing your particular location.

WARNING

UNINTENDED EQUIPMENT OPERATION

The application of this product requires expertise in the design and programming of control systems. Only persons with such expertise should be allowed to program, install, alter, and apply this product.

Follow all local and national safety standards.

Failure to follow these instructions can result in death, serious injury, or equipment damage.

WARNING

UNINTENDED EQUIPMENT OPERATION

- Do not use this product as the only means of control for critical system functions such as motor start/stop or power control.
- Do not use this equipment as the only notification device for critical alarms, such as device overheating or overcurrent.
- Use only the software provided with this product. If you use another software, please confirm the operation and safety before use.

Failure to follow these instructions can result in death, serious injury, or equipment damage.

Chapter 1

Overview

What Is in This Chapter?

This chapter contains the following topics:

Topic	Page
Package Contents and Revision	10
Certifications and Standards	11
Federal Communication Commission Radio Frequency Interference Statement - For USA	13
Hazardous Location Installation - For USA and Canada	14

Package Contents and Revision

Package Contents

NOTE: This product has been carefully packed with special attention to quality. However, should you find anything damaged or missing, please contact customer support immediately.

Verify all items listed here are present in your package:

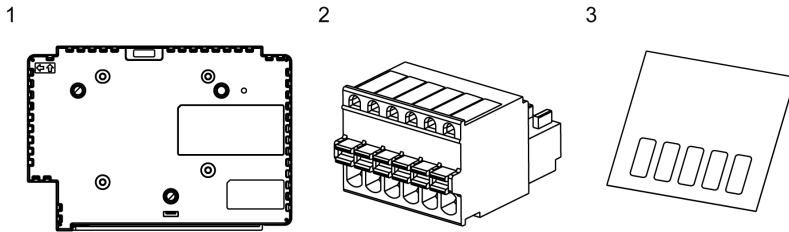

- 1 Multi Display Adapter (model number PFXZCDADEXR1): 1
- 2 DIO Connector: 1
- 3 USB masking sticker (mini-B)*1: 1
- 4 Multi Display Adapter Installation Guide: 1

*1 When using this product with the SP5000 Series Premium Display, you will be unable to use the Premium Display's front USB (mini-B) port. Affix the USB masking sticker to this unused USB port.

Revision

You can identify the product version (PV), revision level (RL), and the software version (SV) from the product label.

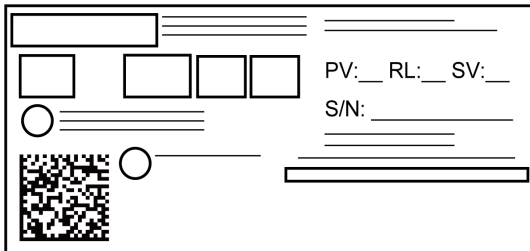

Certifications and Standards

NOTE: The certifications and standards listed below may include those that are not yet acquired for this product. For the latest certifications and standards that this product has acquired, please check the product marking or the following URL.

<http://www.pro-face.com/trans/en/manual/1002.html>

Agency Certifications

Schneider Electric submitted this product for independent testing and qualification by third-party listing agencies. These agencies have certified this product as meeting the following standards.

- Underwriters Laboratories Inc., UL 508 and CSA C22.2 N^o142, Industrial Control Equipment
- Underwriters Laboratories Inc., ANSI/ISA 12.12.01 and CSA C22.2 N^o213, Electrical Equipment for Use in Class I, Division 2 Hazardous (Classified) Locations
- IECEx/ATEX for use in zones 2/22
- EAC certification (Russia, Belarus, Kazakhstan)

Compliance Standards

Europe:

CE

- Directive 2014/35/EU (Low Voltage)
- Directive 2014/30/EU (EMC)
 - Programmable Controllers: EN61131-2
 - EN61000-6-4
 - EN61000-6-2
- Directive 94/9/EC (ATEX)
 - EN60079-0
 - EN60079-15
 - EN60079-31

Australia

- RCM
 - EN61000-6-4

Korea

- KC
 - KN11
 - KN61000-6-2

Qualifications Standards

Schneider Electric voluntarily tested this product to additional standards. The additional tests performed, and the standards under which the tests were conducted, are specifically identified in General Specifications (*see page 30*).

Hazardous Substances

This product is a device for use in factory systems. When using this product in a system, the system should comply with the following standards in regards to the installation environment and handling:

- WEEE, Directive 2012/19/EU
- RoHS, Directive 2011/65/EU and 2015/863/EU
- RoHS China, Standard GB/T 26572
- REACH regulation EC 1907/2006

Unit Disposal

When disposing this product, dispose it in a manner appropriate to, and in accordance with, your country's industrial machinery disposal/recycling standards.

CE Compliance Note

The product described in this manual comply with the European Directives concerning Electromagnetic Compatibility and Low Voltage (CE marking) when used as specified in the relevant documentation, in application for which they are specifically intended, and in connection with approved third-party products.

KC Markings

사용자안내문

기종별	사용자안내문
A급 기기 (업무용 방송통신기자재)	이 기기는 업무용(A급) 전자파적합기기로서 판매자 또는 사용자는 이 점을 주의하시기 바라며, 가정외의 지역에서 사용하는 것을 목적으로 합니다.

Federal Communication Commission Radio Frequency Interference Statement - For USA

FCC Radio Interference Information

This product has been tested and found to comply with the Federal Communications Commission (FCC) limits for a Class A digital device, pursuant to Part 15 of the FCC Rules. These limits are designed to provide reasonable protection against harmful interference in a commercial, industrial or business environment. This product generates, uses, and can radiate radio frequency energy and, if not installed and used in accordance with the instructions, may cause or be subject to interference with radio communications. To minimize the possibility of electromagnetic interference in your application, observe the following two rules:

- Install and operate this product in such a manner that it does not radiate sufficient electromagnetic energy to cause interference in nearby devices.
- Install and test this product to ensure that the electromagnetic energy generated by nearby devices does not interfere with the operation of this product.
- Changes or modifications not expressly approved by the party responsible for compliance could void the user's authority to operate this product.

WARNING

ELECTROMAGNETIC / RADIO INTERFERENCE

Electromagnetic radiation may disrupt the operation of this product leading to unintended equipment operation. If electromagnetic interference is detected:

- Increase the distance between this product and the interfering equipment.
- Reorient this product and the interfering equipment.
- Reroute power and communication lines to this product and the interfering equipment.
- Connect this product and the interfering equipment to different power supplies.
- Always use shielded cables when connecting this product to a peripheral device or another computer.

Failure to follow these instructions can result in death, serious injury, or equipment damage.

Hazardous Location Installation - For USA and Canada

General

This product has been designed with the intention of meeting the requirements of Class I, Division 2 hazardous location application. Division 2 locations are those locations where ignitable concentrations of flammable substances are normally confined, prevented by ventilation, or present in an adjacent Class I, Division 1 location, but where an abnormal situation might result in intermittent exposure to such ignitable concentrations.

While this product is a non-incendive device under ANSI/ISA 12.12.01 and CSA C22.2 N°213, it is not designed for, and should never be used within a Division 1 (normally hazardous) location.

This product is suitable for use in Class I, Division 2, Groups A, B, C, and D hazardous locations or in non-hazardous locations. Before installing or using this product, confirm that the ANSI/ISA 12.12.01 or CSA22.2 N°213 certification appears on the product labeling.

NOTE: Some products are not yet rated as suitable for use in hazardous locations. Always use your product in conformance with the product labeling and this manual.

DANGER

POTENTIAL FOR EXPLOSION

- Suitable for use in Class I, Division 2, Groups A, B, C, and D hazardous locations.
- Substitution of any component may impair suitability for Class I, Division 2.
- Do not disconnect equipment unless power has been switched off or the area is known to be non-hazardous.
- Always confirm that this product is suitable for use in hazardous locations by checking the ANSI/ISA 12.12.01 or CSA C22.2 N°213 certification appears on the product labeling.
- Do not attempt to install, operate, modify, maintain, service, or otherwise alter this product except as permitted in this manual. Unpermitted actions may impair the suitability of this product for Class I, Division 2 operation.

Failure to follow these instructions will result in death or serious injury.

DANGER

POTENTIAL FOR EXPLOSION

- Always confirm the ANSI/ISA 12.12.01 or CSA C22.2 N°213 hazardous location rating of your device before installing or using it in a hazardous location.
- Do not connect or disconnect equipment unless power has been switched off or the area is known to be non-hazardous. This applies to all connections including power, ground, serial, parallel, and network connections.
- Never use unshielded / ungrounded cables in hazardous locations.
- When enclosed, keep enclosure doors and openings closed at all times to avoid the accumulation of foreign matter inside the workstation.

Failure to follow these instructions will result in death or serious injury.

Make sure that this product is properly rated for the location. If the intended location does not presently have a Class, Division and Group rating, then users should consult the appropriate authorities having jurisdiction in order to determine the correct rating for that hazardous location.

Operation and Maintenance

The systems have been designed for compliance with relevant spark ignition tests.

DANGER

POTENTIAL FOR EXPLOSION

In addition to the other instructions in this manual, observe the following rules when installing this product in a hazardous location:

- Wire the equipment in accordance with the National Electrical Code article 501.10 (B) for Class I, Division 2 hazardous locations.

Failure to follow these instructions will result in death or serious injury.

Chapter 2

Device Connectivity

What Is in This Chapter?

This chapter contains the following topics:

Topic	Page
System Design	18
About Touch Operation Exclusive Control	21
Accessories	23

System Design

The Multi Display Adapter attaches to the SP5000 Series Display Module (hereafter referred to as “Display Module”), enabling you to view the host screen from multiple Display Modules on an Ethernet network.

Dedicated utilities are required to configure or change the communication settings between this product and the host, the display settings of the Display Module connected to this product, or network settings (*see page 49*).

NOTE:

- This product does not support wireless LAN communication. Even when attaching a Display Module's wireless LAN model to this product, you need a wired LAN connection between this product and the host.
- Applications that facilitate external touch operations (such as Remote HMI) and operations from touch panel displays other than those by Pro-face are not supported.
- You can connect a maximum three Multi Display Adapters to a single host.
- Recommended Ethernet communication speed: 1000BASE-T (with twisted pair Ethernet cables with a rating of category 5e)
- To prevent interruptions in communication, use an Ethernet cable with a locking tab to confirm that the cable does not disconnect itself from the connector.
- When attaching a Premium Display to the Multi Display Adapter, if you connect a USB HUB from the front USB (Type A), you can configure only one level of cascading connections.
- Using the Advanced Display, if your screens are set up to duplicate (clone), the same resolution is required between displays because the resolution of the Advanced Display is fixed.

The following are example system configurations.

Line Connection

In a line connection, by connecting the Multi Display Adapters together with Ethernet cables, you can cascade your connections (Ethernet HUB not required).

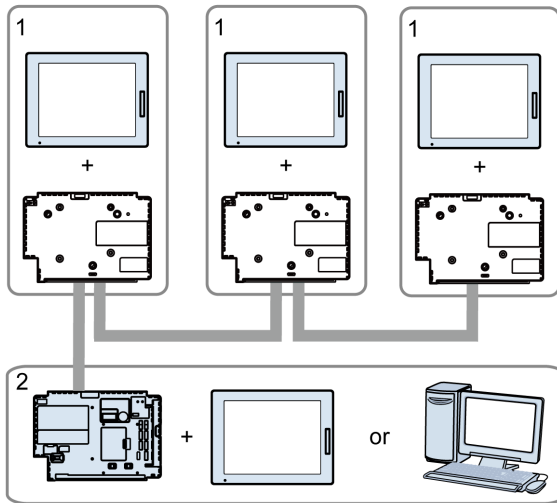

- 1 Multi Display Adapter + Display Module
 2 One of the following:
- Display Module + SP-5B41
 - DC Power Supply Adapter + SP-5B41
 - Pro-face industrial personal computers*1
 - Commercial type personal computers

*1 Except for PE-4000B.

NOTE: With this connection method, turning off one of the three Multi Display Adapters disconnects that Multi Display Adapter, and also any Multi Display Adapters that communicate with the host through the Multi Display Adapter that was turned off.

Example) In the previous diagram, turning off the power for the middle Multi Display Adapter also ends communication between the host and the Multi Display Adapter on the right-hand side.

Star Connection

In a star connection, by connecting the Multi Display Adapters to an Ethernet HUB, even if communication between one of the Multi Display Adapters and the Ethernet HUB is disconnected, communication with the other Multi Display Adapters can still continue.

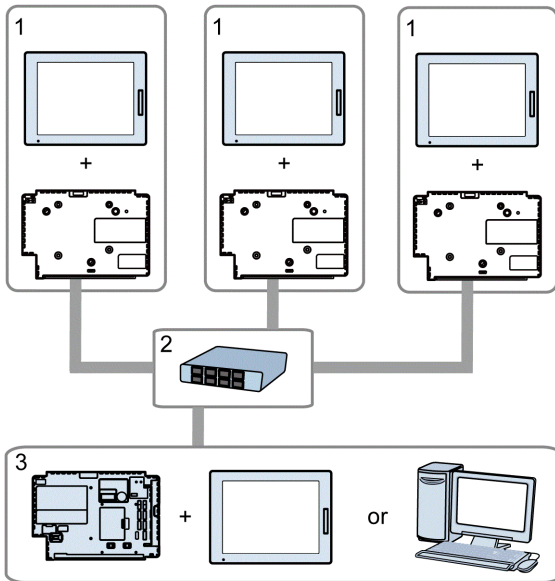

- 1 Multi Display Adapter + Display Module
- 2 Ethernet HUB
- 3 One of the following:
 - Display Module + SP-5B41
 - DC Power Supply Adapter + SP-5B41
 - Pro-face industrial personal computers *1
 - Commercial type personal computers

*1 Except for PE-4000B.

About Touch Operation Exclusive Control

While you are running touch panel operations with one of the displays, you can disable operations with the other displays. For this type of exclusive control, there are two operation modes: First Touch Priority Mode and Excluded Mode.

To define the operation mode settings, use the MDA Configuration Tool (*see page 65*).

First Touch Priority Mode

Provides operation rights to the display with the first touch input detected.

After the first touch input is detected, if the time defined in the MDA Configuration Tool's Release Time setting (*see page 65*) elapses without any further input operations, the exclusive operation is released. Also, the operation right is released if the Multi Display Adapter is disconnected from the network.

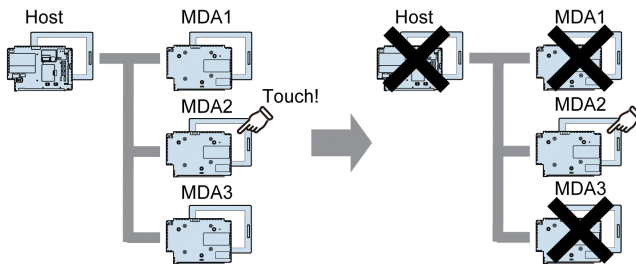

Excluded Mode

Provides operation rights to a specific display only. Also, you can use the Multi Display Adapter's DIO signal (*see page 32*) to move operation rights to another display.

In this mode, exclusive control is possible only with displays connected to the Multi Display Adapter. Touch operation is enabled all the time for displays connected to the host.

When not using DIO signal:

When MDA1 is set up with operation rights, touch panel operations are not possible on MDA2 and MDA3.

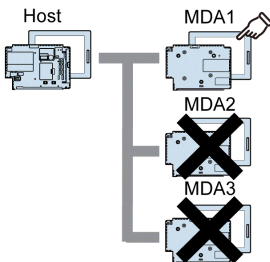

When using DIO signal:

Next is an example of how to transfer operation rights with an external switch and external LED.

Preparation:

Connect an external switch and external LED to each Multi Display Adapter's DIO port.

- Request input: Connect external switch for requesting transfer of operation rights.
- Release input: Connect external switch for releasing operation rights.
- Lamp output: Connect external LED that lights up when operation rights are held.

Action:

1. Press the request switch connected to the Multi Display Adapter for which you want to run touch panel operations.
The Multi Display Adapter connected to the request switch responds with a single buzzer. Also, the Multi Display Adapter that has operation rights responds with a double-buzzer and the connected external LED changes from on to blinking.
2. While the external LED is blinking (and within the time defined in the MDA Configuration Tool's Request Timeout setting) (see page 65), press the release switch on the Multi Display Adapter with operation rights to move the operation rights to the Multi Display Adapter that had its request switch pressed.
If the release switch is not pressed and the Request Timeout elapses, the external LED on the Multi Display Adapter with operation rights changes from blinking, back to on.

Even when MDA1 is set up with exclusive operation rights, you can use switches to move operation rights.

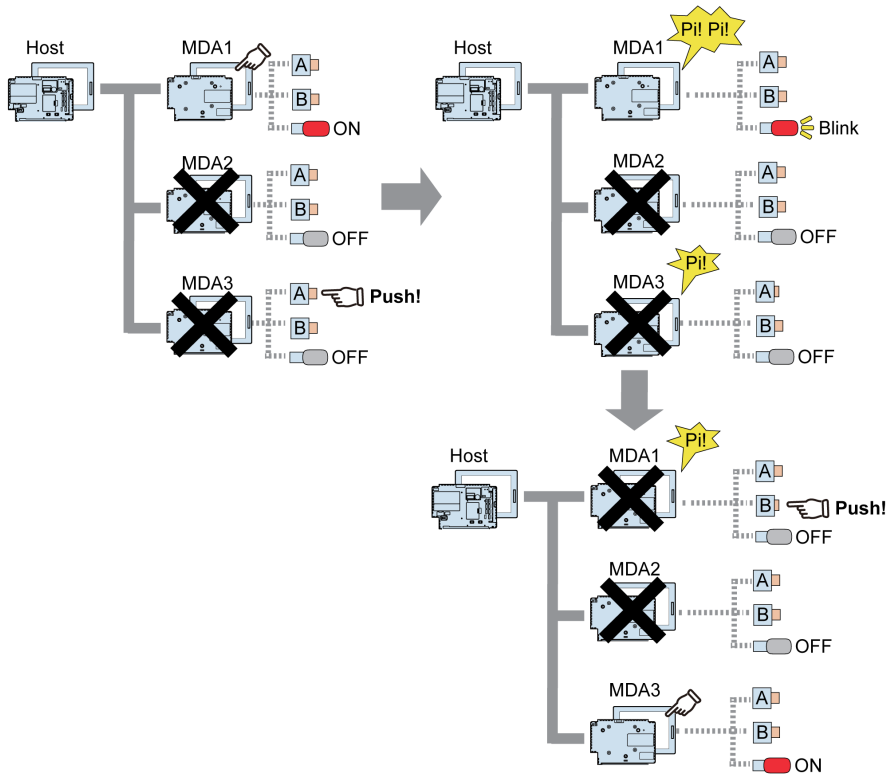

- A: Request switch
- B: Release switch

Accessories

Product Name	Product Number	Description
VESA Mount Adapter	PFXZSPADVS1	Adapter for mounting the SP5000 Series Display Module onto a VESA arm.

Maintenance Accessories

Product Name	Product Number	Description
DIO Connector	PFXZCFCNIO1	DIO connector for managing exclusive control of touch operations between multiple displays connected to this product (5 pieces/set).

Chapter 3

Parts Identification and Functions

What Is in This Chapter?

This chapter contains the following topics:

Topic	Page
Parts Identification	26
LED Indications	27

Parts Identification

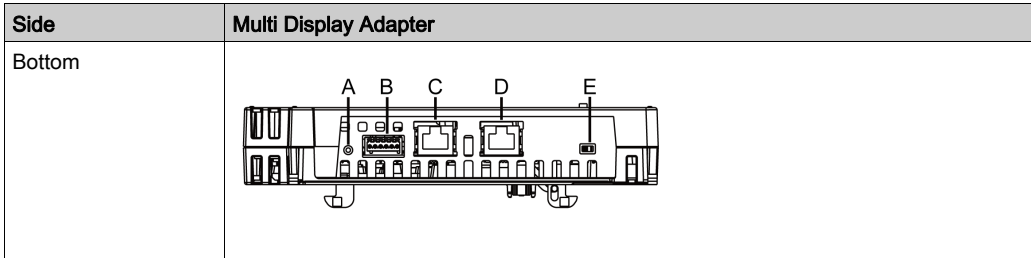

Part	Name	Description
A	Reset switch	Switch for reverting to factory default. Turn on the Display Module while pressing the reset switch, and continue pressing the switch for six seconds or more to revert the Display Module to its factory default settings. Updated standby screen and firmware are preserved.
B	DIO interface	DIO interface for exclusive control of touch operations. Input: Rated voltage 24 Vdc Output: Rated voltage 24 Vdc, rated current 50 mA
C	Ethernet interface (Ethernet1)	Ethernet transmission interface IEEE802.3i/IEEE802.3u/IEEE802.3ab 10BASE-T/100BASE-TX/1000BASE-T Connector: Modular jack (RJ-45) x 1
D	Ethernet interface (Ethernet2)	Ethernet transmission interface IEEE802.3i/IEEE802.3u/IEEE802.3ab 10BASE-T/100BASE-TX/1000BASE-T Connector: Modular jack (RJ-45) x 1
E	DHCP switch	Switch that toggles between enabling and disabling DHCP server feature. In the factory default, the switch is set to OFF.

LED Indications

Status LED

For the status of this product, check the Display Module's status LED.

Color	Indicator	Description
Green	ON	In operation
	LED fade	Backlight is OFF (Standby Mode), or no video input signal
Green/Orange	Alternating	Setting up Multi Display Adapter
Orange	Flashing	Waiting for Multi Display Adapter communication connection
Red	ON	Power is ON
Orange/Red/Green	Alternating	Display unit error ^{*1}
-	OFF	Power is OFF

*1 The product may be malfunctioning. Please contact customer support.

NOTE:

- While the green or orange light is on, if communication is not terminated using an appropriate procedure, the green or orange light will remain on until you restart the product.
- If the screen does not display and the status LED is not in the LED fade state, the backlight is burned out. When the screen does not display, always check the LED status and do not perform touch operations.

Chapter 4

Specifications

What Is in This Chapter?

This chapter contains the following topics:

Topic	Page
General Specifications	30
Interface Specifications	32

General Specifications

Electrical Specifications

Power supply	Rated input voltage	12 Vdc (Supplied by the Display Module)
	Power consumption	8 W or less

Environmental Specifications

Physical environment	Surrounding air temperature	0...60 °C (32...140 °F)
	Storage temperature	-20...60 °C (-4...140 °F)
	Surrounding air and storage humidity	10...90% RH (non-condensing, wet bulb temperature 39 °C [102.2 °F] or less)
	Dust	0.1 mg/m ³ (10 ⁻⁷ oz/ft ³) or less (non-conductive levels)
	Pollution degree	For use in Pollution Degree 2 environment
	Corrosive gases	Free of corrosive gases
Mechanical environment	Atmospheric pressure (operating altitude)	800...1,114 hPa (2,000 m [6,561 ft] or lower)
	Vibration resistance	IEC/EN 61131-2 compliant 5...9 Hz single amplitude 3.5 mm (0.14 in) 9...150 Hz fixed acceleration: 9.8 m/s ² X, Y, Z directions for 10 cycles (approximately 100 minutes)
Electrical environment	Shock resistance	IEC/EN 61131-2 compliant 147 m/s ² , X, Y, Z directions for 3 times
	Noise Immunity	Noise Voltage: 1,000 Vp-p Pulse Duration: 1 µs Rise Time: 1 ns (via noise simulator)
	Electrostatic discharge immunity	Contact Discharge Method: 6 kV Air Discharge Method: 8 kV (IEC/EN 61000-4-2 Level 3)

Air quality requirements

Do not operate or store this product where chemicals evaporate, or where chemicals are present in the air:

- Corrosive chemicals: Acids, alkalines, liquids containing salt.
- Flammable chemicals: Organic solvents.

CAUTION

INOPERATIVE EQUIPMENT

Do not allow water, liquids, metal, and wiring fragments to enter inside this product.

Failure to follow these instructions can result in injury or equipment damage.

Structural Specifications

Cooling method	Natural air circulation
External dimensions (W x H x D)	188 x 131 x 35 mm (7.4 x 5.16 x 1.38 in)
Weight	800 g (1.76 lb) or less

Interface Specifications

Cable Connections

⚠ DANGER

POTENTIAL FOR EXPLOSION

- Always confirm the ANSI/ISA 12.12.01 or CSA C22.2 N°213 hazardous location rating of your device before installing or using it in a hazardous location.
- Do not connect or disconnect equipment unless power has been switched off or the area is known to be non-hazardous. This applies to all connections including power, ground, serial, parallel, and network connections.
- Never use unshielded / ungrounded cables in hazardous locations.
- When enclosed, keep enclosure doors and openings closed at all times to avoid the accumulation of foreign matter inside the workstation.

Failure to follow these instructions will result in death or serious injury.

Division 2 hazardous location regulations require that all cable connections be provided with adequate strain relief and positive interlock. Never connect or disconnect a cable while power is applied at either end of the cable. All communication cables should include a chassis ground shield. This shield should include both copper braid and aluminum foil.

The outer diameter of the cable must be suited to the inner diameter of the cable connector strain relief so that a reliable degree of strain relief is maintained.

DIO Interface

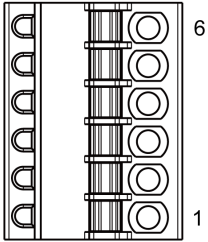
Cable connection side	Pin	Signal name	Direction	Description
	1	Request	Input	Request touch panel operation rights
	2	Request_GND	-	Ground (Request)
	3	Release	Input	Release touch panel operation rights
	4	Release_GND	-	Ground (Release)
	5	Lamp	Output	Output when touch panel operation rights acquired
	6	Lamp_GND	-	Ground (Lamp)

Request/Release

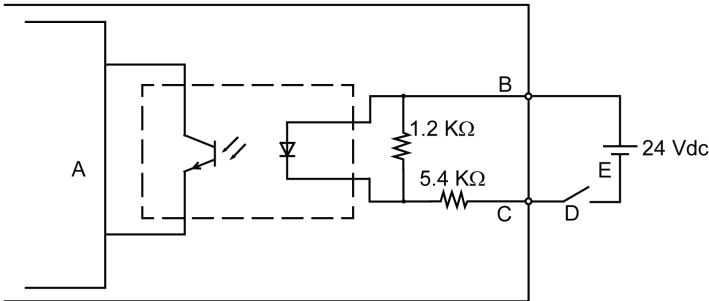

- A Internal circuit
- B Pin number 1 or 3: Request or Release
- C Pin number 2 or 4: Request_GND or Release_GND
- D Switch
- E External power

Lamp

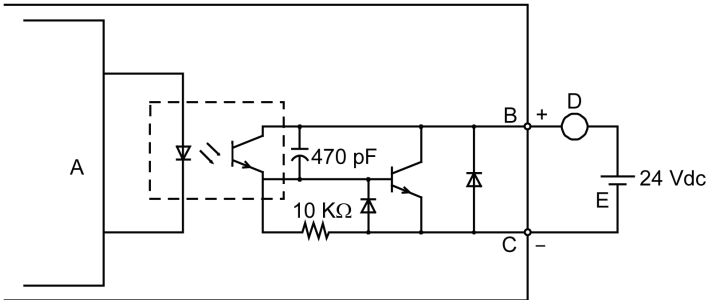

- A Internal circuit
- B Pin number 5: Lamp
- C Pin number 6: Lamp_GND
- D Load
- E External power

NOTE: Since the output terminals are not electrically protected, an output line might be short-circuited or a connection fault might damage this product. If necessary, install an applicable fuse to prevent an overload in the circuit.

Chapter 5

Dimensions

What Is in This Chapter?

This chapter contains the following topics:

Topic	Page
External Dimensions	36
Dimensions with Cables	37

External Dimensions

NOTE: External view is shown using first angle projection method.

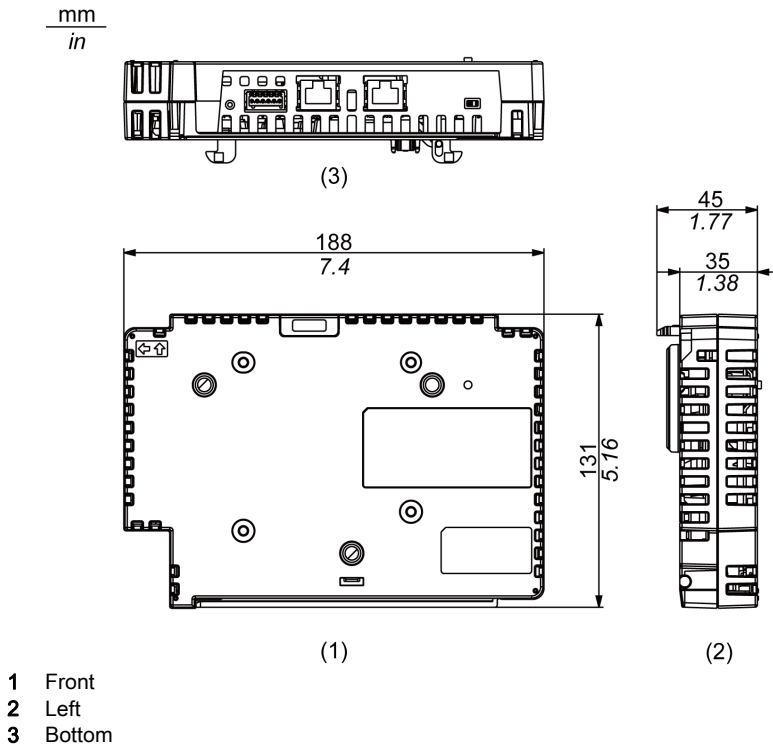

Dimensions with Cables

NOTE: The following illustration is of the SP-5600TP in an installation.

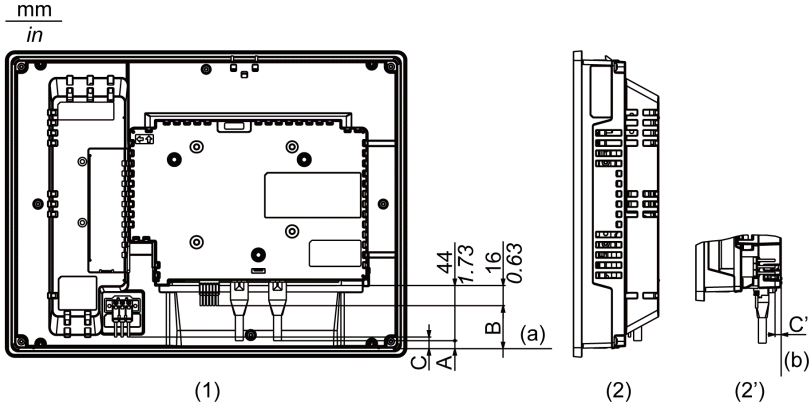

- 1 Rear
- 2 Left
- 2' Left (SP-5400WA)

Refer to the following table for the length of A, B, and C.

A, B, C: Minus when fits inside (a).

C': Minus when fits inside (b).

Series		Size	Model name	A	B	C	C'
SP5000 Series	Premium Display	10 inch	SP-5500TP	7 mm (0.28 in)	-20 mm (-0.79 in)	5 mm (0.2 in)	-
		12 inch	SP-5600TP	-6 mm (-0.24 in)	-33 mm (-1.3 in)	-9 mm (-0.35 in)	-
			SP-5660TP				
		15 inch	SP-5700TP	-33 mm (-1.3 in)	-61 mm (-2.4 in)	-36 mm (-1.42 in)	-
		15 inch wide	SP-5700WC	-18 mm (-0.71 in)	-45 mm (-1.77 in)	-20 mm (-0.79 in)	-
	19 inch wide	SP-5800WC	-52 mm (-2.05 in)	-79 mm (-3.11 in)	-54 mm (-2.13 in)	-	
	Advanced Display	7 inch wide	SP-5400WA	40 mm (1.57 in)	13 mm (0.51 in)	-	-4 mm (-0.16 in)
		10 inch wide	SP-5500WA	15 mm (0.59 in)	-12 mm (-0.47 in)	13 mm (0.51 in)	-
		12 inch wide	SP-5600WA	-1 mm (-0.04 in)	-28 mm (-1.1 in)	-4 mm (-0.16 in)	-
		12 inch	SP-5600TA	-6 mm (-0.24 in)	-33 mm (-1.3 in)	-9 mm (-0.35 in)	-

NOTE:

- All the above values are designed with cable bending in mind. The dimensions given here are representative values depending on the type of connection cable in use. Therefore, these values are intended for reference only.
- For details about the depth dimension when the Box Module and Display Module are attached to each other, refer to the SP5000 Series Hardware Manual.

Chapter 6

Installation and Wiring

What Is in This Chapter?

This chapter contains the following topics:

Topic	Page
Installation	40
DIO Connector	44
VESA Mount Adapter	45

Installation

Be aware of the following when building this product into an end-use product:

- The rear face of this product is not approved as an enclosure. When building this product into an end-use product, be sure to use an enclosure that satisfies standards as the end use product's overall enclosure.
- This product is not designed for outdoor use. UL certification obtained is for indoor use only.

Installing onto Display Module

⚡ ⚠ DANGER

HAZARD OF ELECTRIC SHOCK, EXPLOSION, OR ARC FLASH

- Remove all power from the device before removing any covers or elements of the system, and prior to installing or removing any accessories, hardware, or cables.
- Unplug the power cable from both the Display Module and the power supply.
- Always use a properly rated voltage sensing device to confirm power is off.
- Replace and secure all covers or elements of the system before applying power to the Display Module.

Failure to follow these instructions will result in death or serious injury.

NOTICE

EQUIPMENT DAMAGE

- When mounting the Display Module vertically, first install this product onto the Display Module before attaching the Display Module to the panel.
- When installing this product onto the Display Module, place the Display Module on a clean and level surface with the screen facing downward.

Failure to follow these instructions can result in equipment damage.

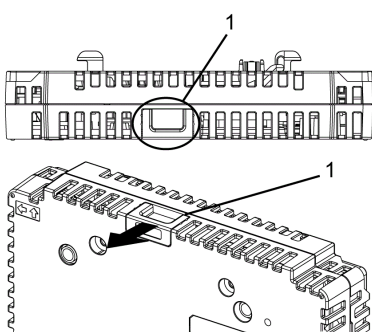
Step	Action
1	<p>Pull the LOCK forward on the top of this product to release the lock as illustrated.</p>  <p>1 LOCK</p>

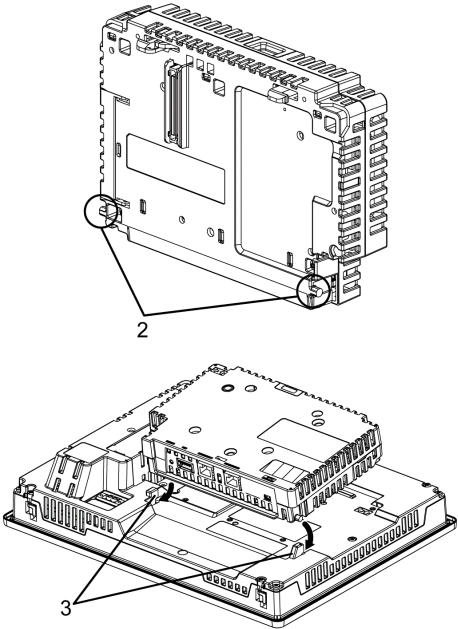
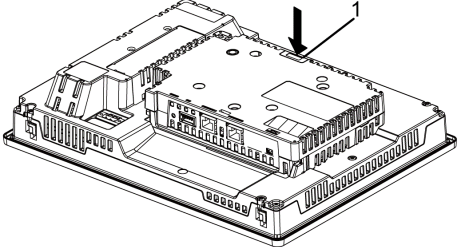
Step	Action
2	<p data-bbox="353 204 1243 253">Insert the protruding points on the bottom left and right of this product into the two holes on the back of the Display Module to attach this product and the Display Module together.</p>  <p data-bbox="353 935 566 983">2 Protruding points 3 Holes for insertion</p>
3	<p data-bbox="353 996 1243 1025">Fully push on the LOCK on the top of this product to mount this product on the Display Module.</p>  <p data-bbox="353 1340 454 1360">1 LOCK</p>

NOTE: Refer to the SP5000 Series Hardware Manual or the SP5000 Series (Display Module) Installation Guide on how to mount the Display Module to the panel.

Removing from Display Module

⚡ ⚠ DANGER

HAZARD OF ELECTRIC SHOCK, EXPLOSION, OR ARC FLASH

- Remove all power from the device before removing any covers or elements of the system, and prior to installing or removing any accessories, hardware, or cables.
- Unplug the power cable from both the Display Module and the power supply.
- Always use a properly rated voltage sensing device to confirm power is off.
- Replace and secure all covers or elements of the system before applying power to the Display Module.

Failure to follow these instructions will result in death or serious injury.

NOTICE

EQUIPMENT DAMAGE

When the Display Module is mounted vertically, first remove the Display Module from the panel, then remove this product from the Display Module.

Failure to follow these instructions can result in equipment damage.

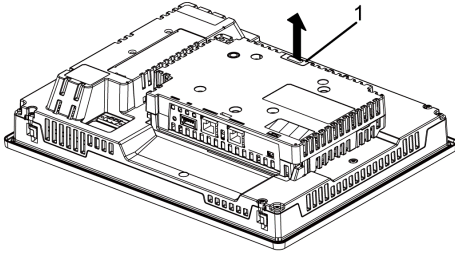
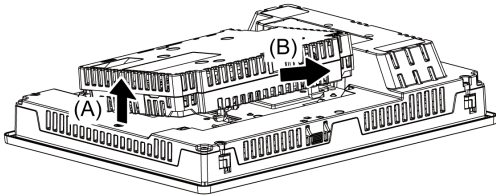
Step	Action
1	<p>If the Display Module was mounted vertically, remove the Display Module from the panel and place the Display Module on a clean and level surface with the screen facing down.</p> <p>NOTE: Refer to the SP5000 Series Hardware Manual or the SP5000 Series (Display Module) Installation Guide on how to remove the Display Module from the panel.</p>
2	<p>Release the LOCK on the top of this product as illustrated.</p>  <p>1 LOCK</p>
3	<p>Lift up this product in the direction indicated by arrow (A) in the diagram and remove it by sliding in the direction indicated by arrow (B).</p> 

 **CAUTION**

RISK OF INJURY

Do not drop this product when you remove it from the Display Module.

- Hold the unit in place after removing the fasteners.
- Use both hands.

Failure to follow these instructions can result in injury or equipment damage.

DIO Connector

Wiring Procedure

⚡ ⚠ DANGER

ELECTRIC SHOCK

- Remove the DIO connector from this product prior to wiring.
- Strip wires only to the required length.
- Do not solder the wire itself.

Failure to follow these instructions will result in death or serious injury.

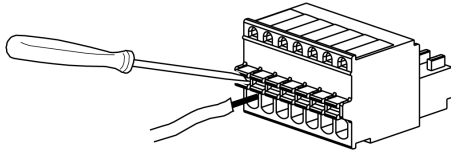
Step	Action
1	Align the flat-head screwdriver with the groove of the orange spring release button, and while depressing the button insert the electric wire into the wire insertion slot (round-shaped hole).
2	Pull out the screwdriver from the release button. The wire insertion slot is then closed, and the wire is held securely in place. To remove the wire, align the flat-head screwdriver with the groove of the release button, and while depressing the button pull the wire out. 
3	Insert the wired DIO connector to the DIO Interface of this product.

Recommendations:

- Screwdriver: SZS 0.4 x 2.0 (Product No. 1205202) manufactured by Phoenix Contact.
If you use another manufacturer, be sure the part has the following dimensions:
 - point depth: 0.4 mm (0.02 in)
 - point height: 2.0 mm (0.08 in)
 Point shape should have isolation properties meeting DIN 5264 and EN60900.

NOTE:

- Wire should be AWG 28 to AWG 20 thick and twisted.
- Applicable wire sizes are Style 1015 and Style 1007.
- Be sure to strip 8.0 mm (0.31 in) of cover from the wire.
- Use copper conductors only.

VESA Mount Adapter

Introduction

By attaching Pro-face's VESA mounting adapter (PFXZSPADVS1) to the back of this product's adapter mounting holes, you can attach commercially available VESA 75 mm arms and wall-mount adapters.

NOTE: For details on how to attach the arm or wall-mount adapter, refer to the product's associated instruction manual.

CAUTION

RISK OF INJURY

- Do not drop this product when you mount it to, or remove it from, a commercial type arm or wall-mount adapter.
- Hold the unit in place after removing the fasteners.
- Use both hands.
- Attach this product to the Display Module before attaching the VESA Mount Adapter.
- Be careful not to injure your fingers when you mount this product to a commercial-type arm or wall-mount adapter.

Failure to follow these instructions can result in injury or equipment damage.

NOTICE

BROKEN ENCLOSURE

- Do not exert more than 1.5 N•m (13.3 lb-in) of torque when tightening the fastener's screws.
- Use the screw type specified in the following instructions.

Failure to follow these instructions can result in equipment damage.

Attaching the VESA Mount Adapter

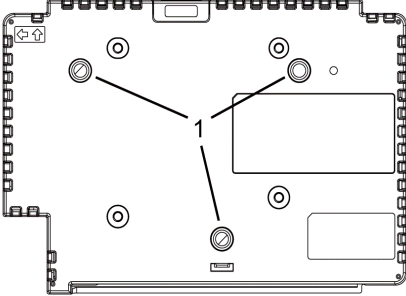
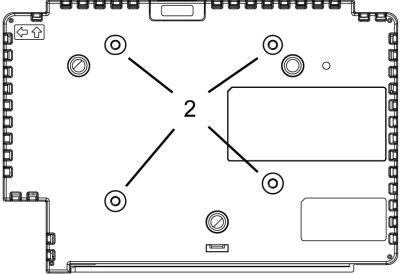
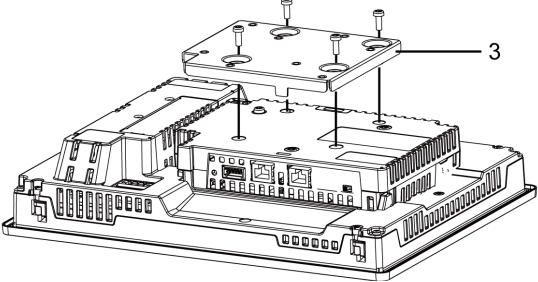
Step	Action
1	Check your VESA Mount Adapter package and make sure it includes three M4 (35 mm) and four M4 (16 mm) screws.
2	Attach this product to the Display Module before attaching the VESA Mount Adapter (<i>see page 40</i>).
3	<p>To get a firmer hold between this product and the Display Module, at the back of this product, insert the screws (M4, 35 mm) into the fixed screw holes with a Phillips screwdriver, using a torque of 1.5 N•m (13.3 lb-in).</p>  <p>1 Fixed screw holes</p>
4	<p>Attach the VESA Mount Adapter to this product with the adapter mounting screws (M4, 16 mm). Tighten the screws using a torque of 1.5 N•m (13.3 lb-in).</p>   <p>2 Adapter mounting holes 3 VESA Mount Adapter</p>

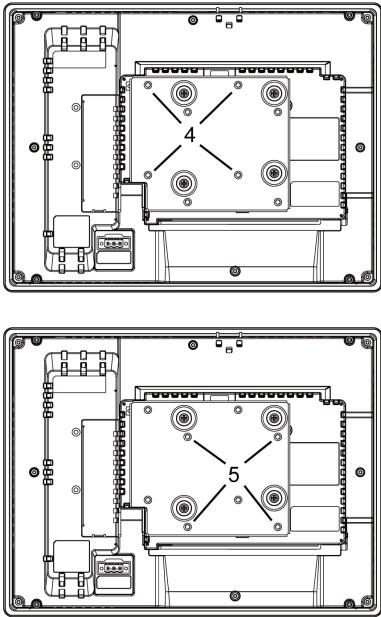
Step	Action
5	<p data-bbox="345 195 1255 305">Attach the commercial-type arm or the wall-mount adapter with M4 screws, 10 mm or shorter. Tighten the screws using a torque of 1.5 N•m (13.3 lb-in). Check for the mounting holes by referring to the following diagram, as the mounting holes differ depending on the Display Module size.</p> <div data-bbox="367 336 746 948"></div> <p data-bbox="345 981 883 1035">4 VESA arm mounting holes (other than SP-5400WA) 5 VESA arm mounting holes (SP-5400WA)</p>

Chapter 7

Multi Display Adapter Settings

What Is in This Chapter?

This chapter contains the following sections:

Section	Topic	Page
7.1	Utility Environment	50
7.2	Before Setup	51
7.3	MDA Configuration Tool	58
7.4	Network Setting Tool/MDA Finder	68

Section 7.1

Utility Environment

Operating Systems, Drivers, Utilities

Use dedicated utilities to configure or change display settings, network settings, and the communication connection between this product and the host.

The following describes the operating environment for the utilities.

Compatible Operating Systems

Refer to the Readme.txt that comes with the MDA Utilities (MDA_Utilities_[version]_EN.zip) that you can download from our support site.

MDA Utilities

MDA Utilities (drivers and utilities) are required for touch input data communication between this product and the host, and adjustment of the screen display.

You can download the MDA Utilities from our support site at <http://www.pro-face.com/trans/en/manual/1001.html>.

Name		Description
Driver	Communication driver	This driver enables communication between this product and the utilities (<i>see page 57</i>).
Utility	MDA Configuration Tool	Sets up the communication connection between this product and the host, exclusive control, and display settings (<i>see page 58</i>).
	Network Setting Tool	Runs network settings of each Multi Display Adapter from an Internet browser (<i>see page 70</i>).
MDA Finder		Detects the IP address of connected Multi Display Adapters (<i>see page 74</i>).

Section 7.2

Before Setup

What Is in This Section?

This section contains the following topics:

Topic	Page
Workflow	52
Setting Workflow	54
Installing the MDA Utilities	57

Workflow

For network configuration and screen display settings between this product and the host, use the various tools and configuration screens described in the following passages.

Callouts in the following descriptions identify which platform and which tool is used for configuration. Lightbulbs identify the equipment that is configured.

Network Settings

Use the MDA Configuration Tool or MDA Finder's **Network Setting** to open the Network Setting Tool, and set up static IP addresses for each Multi Display Adapter (*see page 70*).

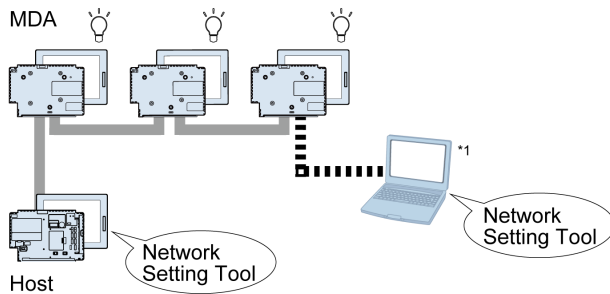

*1 You can also set up from a different computer than the host on the same network.

Connection between Multi Display Adapter and Host

Use the MDA Configuration Tool to start communication between a Multi Display Adapter and the host (*see page 59*).

For connection to the host, use the following methods to identify the Multi Display Adapters that will be connected.

- MAC address on the product label
- **Display Info on MDA** in MDA Configuration Tool

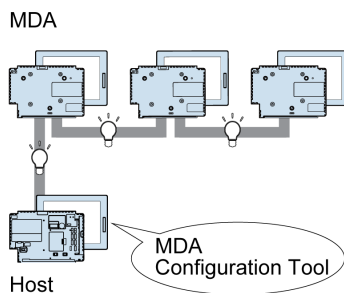

Screen Display Settings

In the host's Windows® display settings, set up the screen display (duplicate, extend) (see page 61).

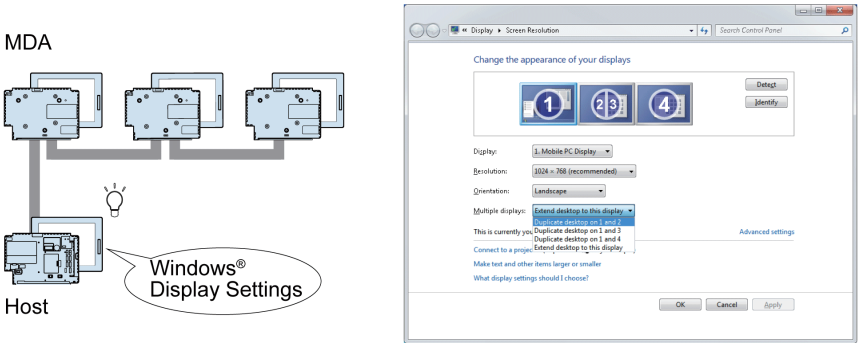

Furthermore, including the host display, to view the same screen on three or more displays, use the MDA Configuration Tool's Multi Mirror (see page 61).

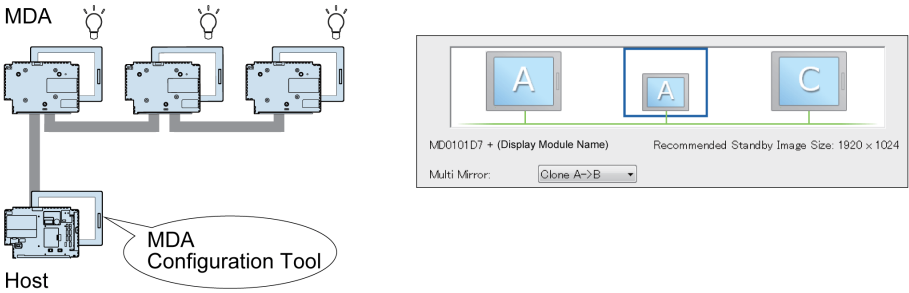

Using the Window Recorder, you can record the display position at application startup, then even after being disconnected from the network, or the power is shut down, when you connect again the application window appears in the same display and position as before being disconnected (see page 66).

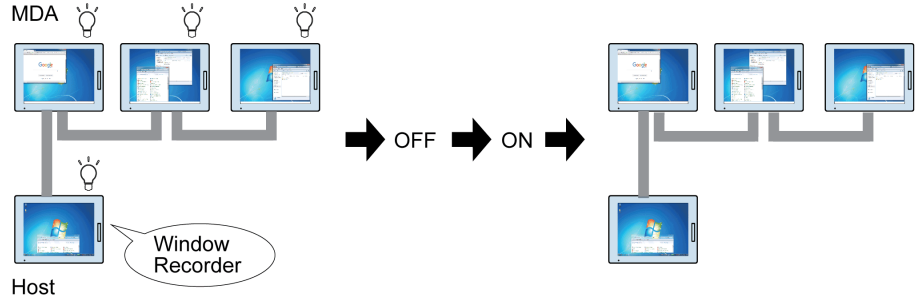

Setting Workflow

The following describes how to configure this product and the host.

Step	Action
1	Install the Multi Display Adapter onto the Display Module (<i>see page 40</i>).
2	Connect the Multi Display Adapters to the host with Ethernet cables (<i>see page 18</i>).
3	Turn on the DHCP switch located on the bottom part of one of the connected Multi Display Adapters (<i>see page 26</i>). NOTE: <ul style="list-style-type: none"> • Before turning on the Multi Display Adapter, turn on the DHCP switch. • If there are two or more DHCP servers on the same network, they will not work properly.
4	Turn on all Multi Display Adapters.
5	The following standby screen will appear on the displays of the Multi Display Adapters. 
6	Perform steps 8 to 15 below on a display connected to the host. NOTE: You cannot run these steps on a display with Multi Display Adapter attached.
7	Turn on the power of the host.
8	Install the MDA Utilities on the host (<i>see page 57</i>). NOTE: <ul style="list-style-type: none"> • In this instance, configure to obtain an IP address for the host automatically. • When installing the utilities and changing settings in MDA Configuration Tool, always ensure that the Write Filter is disabled. If the Write Filter is enabled, the setting information will be erased when the operating system is restarted. After you change the setting, we recommend that you re-enable the Write Filter.
9	In the MDA Configuration Tool, select a Multi Display Adapter that has its DHCP switch set to off, and touch Network Setting to open the Network Setting Tool. From TCP/IP set DHCP to [Disable] (<i>see page 70</i>) and set a static IP address. Perform this step for all Multi Display Adapters with their DHCP switch set to off. NOTE: <ul style="list-style-type: none"> • Set up a static IP address that does not conflict with IP addresses automatically assigned to other Multi Display Adapters or the host. Check the host IP address from the Windows® Control Panel. • After setup is complete, the Multi Display Adapter is restarted. • If you start communication without setting up static IP addresses, communication may not operate normally after powering on or reconnecting communication cables.
10	Next, on the Multi Display Adapter with the DHCP switch on, turn off the DHCP switch.
11	Same as step 9, set up static IP addresses for the Multi Display Adapter in step 10.

Step	Action
12	<p>Use the Windows[®] Local Area Connection to set up a static IP address on the host. In this case, the network addresses of all Multi Display Adapters and the host must be the same.</p> <p>Example: Emphasized numbers are the same</p> <p>Host side IP Address: 192.168.0.1 Subnet mask: 255.255.255.0</p> <p>Multi Display Adapter 1 IP Address: 192.168.0.100 Subnet mask: 255.255.255.0</p> <p>Multi Display Adapter 2 IP Address: 192.168.0.101 Subnet mask: 255.255.255.0</p> <p>Multi Display Adapter 3 IP Address: 192.168.0.102 Subnet mask: 255.255.255.0</p>
13	<p>Use the MDA Configuration Tool to set up communication between each Multi Display Adapter and the host (<i>see page 59</i>).</p> <p>NOTE: On first communication connection, it may take a few minutes before the screen becomes visible.</p>
14	<p>In the MDA Configuration Tool, define settings such as the Display Settings and Tablet PC Settings. Set them up in the following order.</p> <ol style="list-style-type: none"> 1. Multi Mirror^{*1} (<i>see page 61</i>) 2. Display Settings (<i>see page 61</i>) 3. Tablet PC Settings (<i>see page 61</i>) 4. Touch Panel Calibration^{*1} (<i>see page 61</i>) 5. Touch Operation Exclusive Control^{*1} (<i>see page 65</i>) <p>*1 Only when required.</p> <p>NOTE: If the settings are not set up in the order shown above, the settings are discarded.</p>
15	<p>When using a SP5000 Series Premium Display, you can use the MDA Configuration Tool to turn off the front USB function (<i>see page 61</i>). To use a USB storage device from the front USB port, turn on the front USB function, and from the Network Setting Tool, set the Device Filter to [Enable] (<i>see page 70</i>).</p>

NOTE: If the host has entered sleep or standby mode, it will not exit this state if you use the touch panel, mouse, or keyboard attached to the Multi Display Adapters.

For stable operation of the system when using Multi Display Adapters, we recommend the following:

 **CAUTION**

INOPERATIVE EQUIPMENT

- When turning on the power:
 - Turn on the host terminal and all Multi Display Adapters at the same time (using a common power supply).
 - Or, after turning on all Multiple Display Adapters and the standby screens are displayed, turn on the host terminal.
- While the system is in operation:
 - Turn on or off Multi Display Adapters and connect or disconnect LAN cables, only after turning off the host terminal.

Failure to follow these instructions can result in injury or equipment damage.

Installing the MDA Utilities

Follow the steps below to install the required drivers and utilities (*see page 50*) to the host.

NOTE: When installing the utilities and changing settings in MDA Configuration Tool, always ensure that the Write Filter is disabled. If the Write Filter is enabled, the setting information will be erased when the operating system is restarted. After you change the setting, we recommend that you re-enable the Write Filter.

Step	Action
1	Download the installer (MDA_Uilities_[version]_EN.zip) onto the host and unzip the file (<i>see page 50</i>).
2	Run setup.exe, and follow the on-screen instructions to install the drivers and the utilities.
3	After installation is complete, as instructed by the message, restart the computer.
4	After the computer starts up, start the utilities from the Windows® Start menu → Pro-face → Multi Display Adapter → MDA Configuration Tool .

NOTICE

EQUIPMENT DAMAGE

Do not turn off this product:

- While updating settings.
- While this product is restarting after the firmware settings have been updated.
- While resetting this product to the factory default settings.

Failure to follow these instructions can result in equipment damage.

Section 7.3

MDA Configuration Tool

What Is in This Section?

This section contains the following topics:

Topic	Page
Connection Setting	59
MDA Setting	61
Touch Operation Exclusive Control	65
Window Recorder	66

Connection Setting

When starting the MDA Configuration Tool, it detects all the Multi Display Adapters on the same network as the host.

Use this screen to set up communication between the Multi Display Adapter and host. Additionally, this screen displays the status of the Multi Display Adapter.

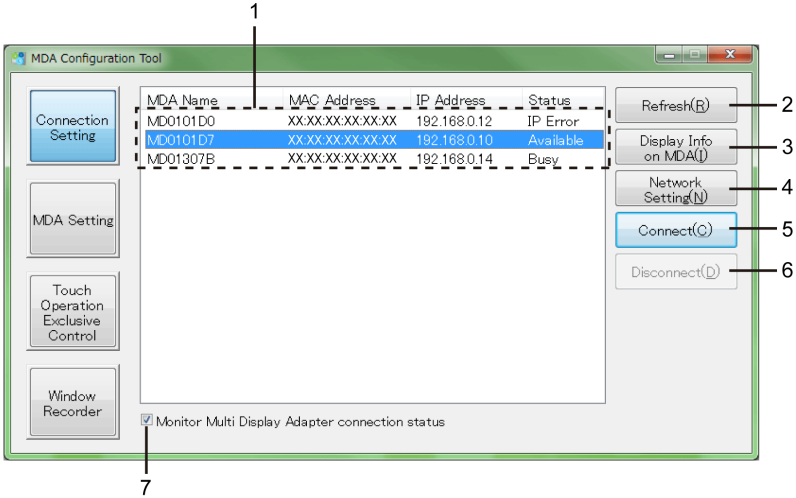

No.	Name	Description
1	MDA list	Displays the name, MAC address, IP address, and status of the connected Multi Display Adapters. If there are multiple Multi Display Adapters on the same network, displays up to a maximum 16 units. To identify the Multi Display Adapter, touch Display Info on MDA , or from the product label check the MAC address. Status details are as follows: <ul style="list-style-type: none">● Available: Available to connect with the host.● Busy: Connected to a different host.● Connecting: Connecting to the host.● Connected: Connected to the host.● IP Error: Error found in network connection.● Not found: Unable to detect the connected or defined Multi Display Adapter. NOTE: You can change the automatically assigned MDA Name with the Network Setting Tool (<i>see page 70</i>).
2	Refresh	Refreshes the MDA list.

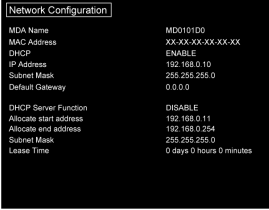
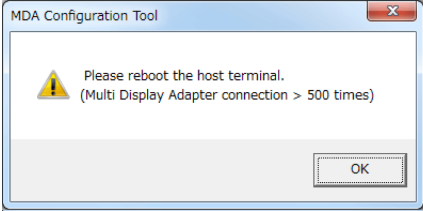
No.	Name	Description
3	Display Info on MDA	<p>Displays network information about the Multi Display Adapter selected in the MDA list. The information appears on the display that has the Multi Display Adapter attached.</p> <p>This feature is useful for identifying the selected Multi Display Adapter.</p> <p>Each time you touch this button, it shows/hides the information on the Multi Display Adapter.</p> 
4	Network Setting	<p>Opens the Network Setting Tool (<i>see page 70</i>) for the Multi Display Adapter selected in the MDA list.</p>
5	Connect	<p>Starts communication between the host and the Multi Display Adapter selected in the MDA list.</p>
6	Disconnect	<p>Stops communication between the host and the Multi Display Adapter selected in the MDA list.</p>
7	Monitor Multi Display Adapter connection status	<p>When the check box is selected, to maintain a stable connection, the following message displays when the Multi Display Adapter attempts to reconnect for the 500th time. Restart the host as instructed. If display of this message is not required, clear the check box.</p> 

MDA Setting

Use this screen to set up the display settings for each Multi Display Adapter.

You can define the settings in the MDA Setting screen only with Multi Display Adapters that have established communication with the host with the **Connect** button.

Screen settings such as duplicate, extend, resolution and main display depend on the host's Windows® display settings.

1st Page

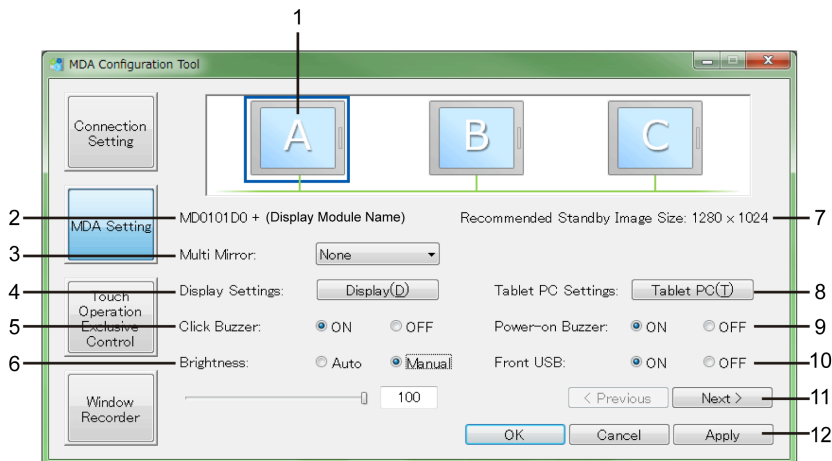

No.	Name	Description
1	Display symbol	Shows the display symbol of the connected Multi Display Adapter. Select the display symbol of the Multi Display Adapter you want to set up. LED of the selected Multi Display Adapter alternates between green and orange. NOTE: Does not show the host display.
2	Product Name	Displays the names of the selected Multi Display Adapter and attached Display Module. You can change the name with the Network Setting Tool (see page 70).
3	Multi Mirror	Sets up clone screen settings for the Multi Display Adapter. The default is [None].*1
4	Display Settings	Displays the Windows® display settings screen.
5	Click Buzzer	Sets the sound on/off when you perform touch-panel operations. The default is [ON].
6	Brightness	Manual (default): Sets the brightness to a fixed value from 0 to 100. Auto: Automatically adjusts the brightness to the selected level using a brightness sensor.
7	Recommended Standby Image Size	Displays the recommended screen resolution for the standby screen. For information on changing the standby screen, refer to "Screen Description - Menu 2" in Network Setting Tool (see page 70).

No.	Name	Description
8	Tablet PC Settings	Following the on-screen instructions, confirm that the display is recognized as touch screen. NOTE: Before using this setting, confirm the Touch Operation Exclusive Control (<i>see page 65</i>) is OFF.
9	Power-on Buzzer	Set on/off the buzzer that sounds when you turn on this product. The default is [ON]
10	Front USB	Enables/disables the front USB port on the Display Module. The default is [ON] (Enable). NOTE: <ul style="list-style-type: none"> The change is applied after the Display Module is restarted. When you want to use a storage device from the front USB port, from the Network Setting Tool, set Device Filter to [Enable] (<i>see page 70</i>). When using this product with the SP5000 Series Premium Display, you will be unable to use the Premium Display's front USB (mini-B) port.
11	Next	Displays the MDA Setting screen's second page.
12	Apply	Saves the current settings.

*1 The following options are available for Multi Mirror.

Selected MDA	Option	Description
-	None	Multi Mirror is not used (default).
A	Clone B → A	Clones screen B to A.
A	Clone C → A	Clones screen C to A.
B	Clone A → B	Clones screen A to B.
B	Clone C → B	Clones screen C to B.
C	Clone A → C	Clones screen A to C.
C	Clone B → C	Clones screen B to C.

When Multi Mirror is set up, on the MDA Configuration Tool screen the destination display symbol changes to match the display symbol of the cloned screen. Additionally, the size of the destination display image is reduced.

Example) When you select [B], and define [Clone A → B]



Example) When [B] is selected and [Clone A → B] is defined, then you select [C] and define [Clone A → C]

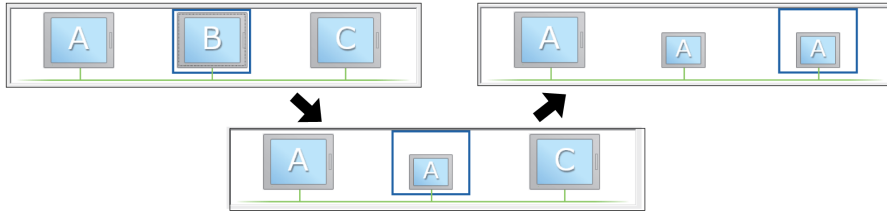

If Multi Mirror is set up, its display number for the destination screen is hidden in the host's Windows® display setting screen.

Example) Windows® display setting screen when Multi Mirror is set up with [Clone A → B]
 (As shown in the left part of the following diagram, Screen ID 1 is the host, 2 is Multi Display Adapter A, 3 is B, and 4 is C)

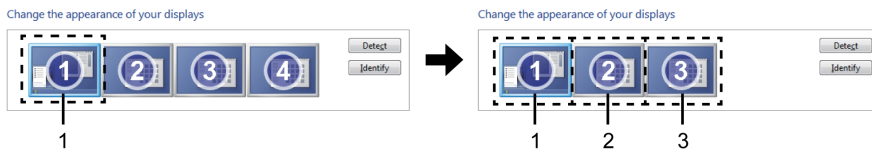

- 1 Host
- 2 Multi Display Adapter A and B have same Screen ID
- 3 Multi Display Adapter C

NOTE: After changing the Multi Mirror settings, configure the **Display Settings** and **Tablet PC Settings** again.

2nd Page

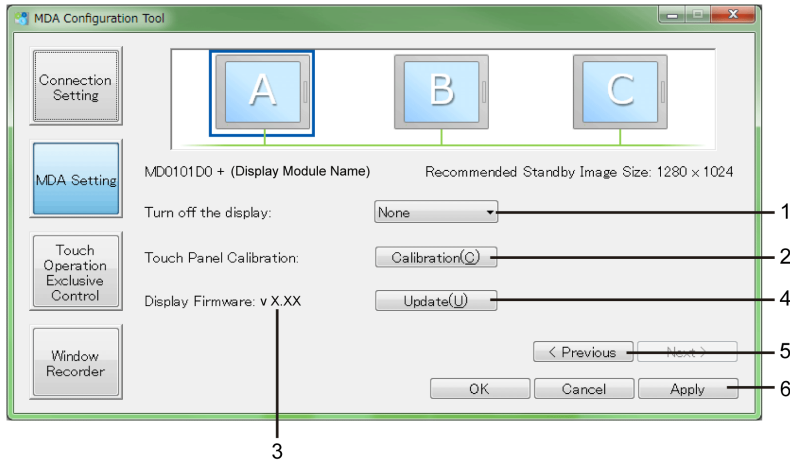

No.	Name	Description
1	Turn off the display	If touch operations do not occur for the amount of time specified here, the display of the selected Multi Display Adapter is turned off. The default is [None].
2	Touch Panel Calibration	Calibrates the touch panel via the on-screen instructions. NOTE: <ul style="list-style-type: none"> • Before using this setting, confirm the Touch Operation Exclusive Control (<i>see page 65</i>) is OFF. • When using this product with SP-5700WC or SP-5800WC, this feature is unavailable. • Do not calibrate the touch panel using Calibrate from the Windows® standard Tablet PC Settings.
3	Display Firmware version	Displays the firmware version of the Display Module connected to the selected Multi Display Adapter.
4	Update	Updates the firmware for the Display Module connected to the selected Multi Display Adapter. NOTE: You can update the Multi Display Adapter's firmware with the Network Setting Tool (<i>see page 70</i>).
5	Previous	Displays the MDA Setting screen's first page.
6	Apply	Saves the current settings.

Touch Operation Exclusive Control

Use this screen to define the Touch Operation Exclusive Control settings. For details on Touch Operation Exclusive Control, refer to About Touch Operation Exclusive Control (*see page 21*).

This screen setting is for all the Multi Display Adapters connected to the same host. The setting is common no matter which Multi Display Adapter you select with the display symbol.

NOTE: Touch operation is enabled all the time for displays connected to the host and those displays cannot be exclusively controlled in Excluded Mode.

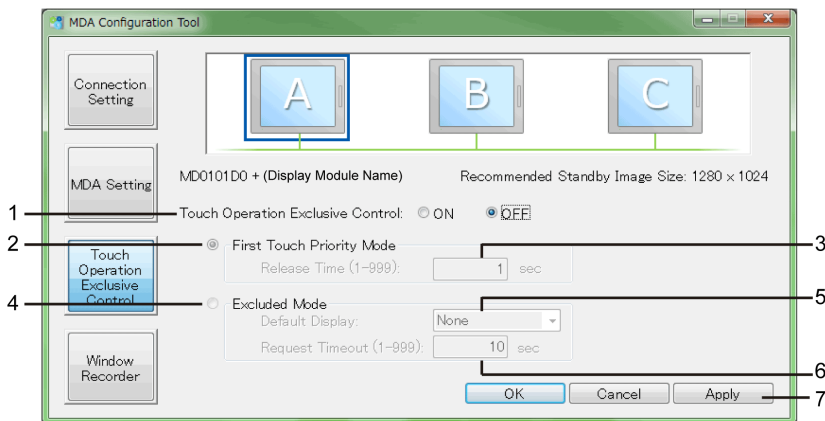

No.	Name	Description
1	Touch Operation Exclusive Control	Turns the Touch Operation Exclusive Control on or off. The default is [OFF]. When [OFF], touch operation is possible from any of the displays connected to the Multi Display Adapter.
2	First Touch Priority Mode	Select this option if you want to provide operation rights to the display with the first touch input detected (<i>see page 21</i>).
3	Release Time	When touch input is complete in First Touch Priority Mode and the time defined here elapses without any further input operations, the exclusive operation is released. The default is 1 second.
4	Excluded Mode	Select this option if you want to provide operation rights to a specific display only, or control operation rights with DIO signals (<i>see page 21</i>).
5	Default Display	With Excluded Mode , select the MDA Name for the display that will use operation rights. The default is [None]
6	Request Timeout	When a request to transfer operation rights is received via a DIO signal from other Multi Display Adapters, after the time defined here elapses with no transfer of operation rights, the request to transfer operation rights is canceled. The default is 10 seconds.
7	Apply	Saves the current settings.

Window Recorder

For some reason if the connection to the display is disconnected, the displayed application window may move to a different position or to a different display altogether. By using the Window Recorder you can fix the display position of the application at startup, so that after reconnecting you can view the application window in the same display and position as before being disconnected.

NOTE: The fixed window display position of the utilities are recorded in the users account used to log into Windows®. To display the window in the recorded position, log in using the same users account.

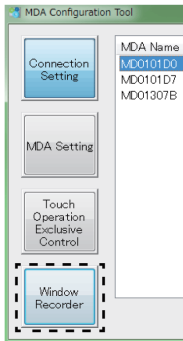

Starting the Window Recorder

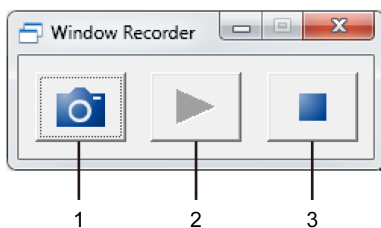

- 1 REC
- 2 PLAY
- 3 STOP

Step	Action
1	Start up all application windows to define their display positions and which display to use. NOTE: If you record the display position while the application is in full screen mode, the window may not display properly.
2	Move each window to the desired display position.
3	Touch Window Recorder on the MDA Configuration Tool screen.
4	Touch REC to save the display position, so that every time the application window is started it automatically shows in the saved position.

NOTE:

- When recording window positions, ensure that the Write Filter is disabled. If the Write Filter is enabled, the recorded information will be erased when the operating system is restarted. After you finish recording, we recommend that you re-enable the Write Filter.
- To temporarily release the fixed position, touch **STOP**. To return to the fixed position, touch **PLAY**.
- After saving the window display position, adding a Multi Display Adapter connection or disconnecting a Multi Display Adapter loses the display positions. If you add a connection or disconnect, save the display position again. However, if you return to the same configuration as before adding the Multi Display Adapter connection or disconnecting the Multi Display Adapter, the saved display position information is applied so you do not have to set the display information again.

Section 7.4

Network Setting Tool/MDA Finder

What Is in This Section?

This section contains the following topics:

Topic	Page
Introduction	69
Network Setting Tool	70
MDA Finder	74

Introduction

Using the Network Setting Tool you can do the following:

- Change the Multi Display Adapter's IP address
- Change the Multi Display Adapter name
- Set up a standby screen
- Set up permission to use the front USB storage device
- Update the Multi Display Adapter's firmware

This topic describes the above settings. For information on other set up items, in the Network Setting Tool, refer to the **HELP** in the top-right of each screen.

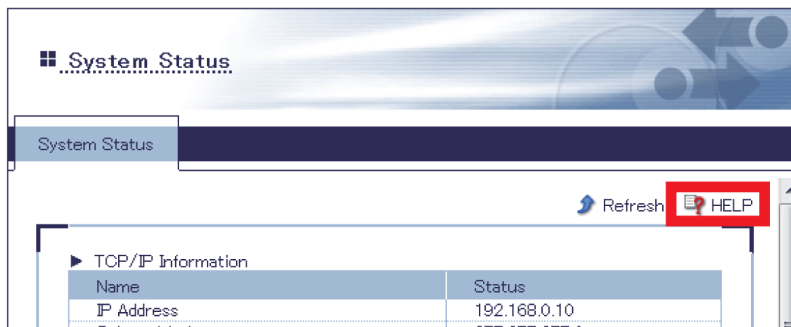

Network Setting Tool

Network Setting Tool is a utility for defining the Multi Display Adapter network settings. This topic provides an outline of each screen. For information on set up items in the Network Setting Tool, refer to the **HELP** in the top-right of each screen.

Starting the Network Setting Tool

You can start the Network Setting Tool using one of the following methods.

- MDA Configuration Tool's Network Setting (*see page 59*).
- MDA Finder (*see page 74*).

About the Menus

Network Setting Tool menus are divided into **Menu 1** and **Menu 2**. You can select the language as either English or Japanese.

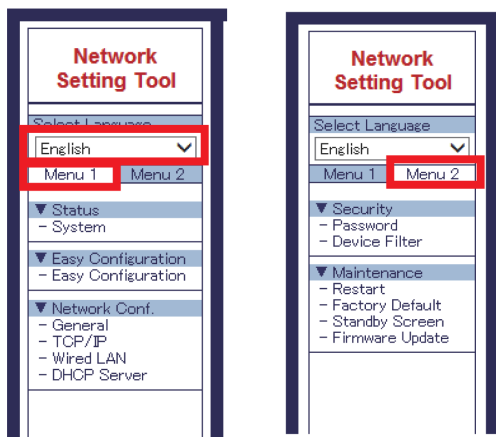

About the Login ID

Start the Network Setting Tool, and enter your login ID when you first change the screen. The user name and initial password is as follows. You cannot change the user name. You can set up the password from **Menu 2's Password** command.

User name: root (fixed)

Password: (empty)



NOTE: If you lose the password, to use the Multi Display Adapter, you need to reset the Multi Display Adapter settings to the factory default from the **Factory Default** screen or use the reset switch (*see page 26*).

About Applying Changes to Settings

After changing the settings, touch the **Submit** button and a message confirms whether to restart the Multi Display Adapter. Changes to configuration are completed after restarting.

When making multiple changes to the settings, touch the **Submit** button after each change in settings, and in the restart confirmation message box, select [No]. Once you've completed all the setting changes, from **Menu 2** select **Restart** to implement all the setting changes at one time.

NOTICE

EQUIPMENT DAMAGE

Do not turn off this product:

- While updating settings.
- While this product is restarting after the firmware settings have been updated.
- While resetting this product to the factory default settings.

Failure to follow these instructions can result in equipment damage.

Screen Description - Menu 1

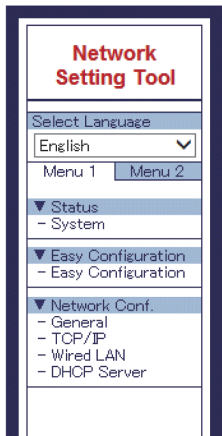

Menu	Description
System	Displays the Multi Display Adapter's current TCP/IP information.
Easy Configuration	You can set up General Configuration , TCP-IP Configuration , and DHCP Server Configuration all at one time, as follows.
General	Changes the MDA name.
TCP/IP	To set a static IP address, set DHCP to [Disable] and enter the IP address. The default is [Enable]. NOTE: If you start communication without setting up a static IP address, communication may not operate normally after powering on or reconnecting communication cables.
Wired LAN	Enables or disables the use of Jumbo Frame. The default is [OFF].
DHCP Server	Use when setting up a static IP address for the Multi Display Adapter (<i>see page 54</i>).

Screen Description - Menu 2



Menu	Description
Password	Defines the login password.
Device Filter	<p>Defines whether you can use (Enable / Disable) an USB storage device on the front USB port. Even if you set [Disable], you can still use an USB mouse or keyboard.</p> <p>NOTE:</p> <ul style="list-style-type: none"> • USB 2.0 High-Speed isochronous transfer, used by devices such as USB speakers and USB cameras, is not supported. • When using this product with the SP5000 Series Premium Display, you will be unable to use the Premium Display's front USB (mini-B) port.
Restart	Restarts the Multi Display Adapter.
Factory Default	Resets the Multi Display Adapter to factory defaults. Updated standby screen and firmware are preserved.
Standby Screen	<p>You can define a screen image you create for a standby screen that appears on the Multi Display Adapter when it is not connected to a host. When making a standby screen, note the following limitations.</p> <ul style="list-style-type: none"> • File size: Maximum 2 MB • File format: png • Image resolution: WVGA 800 x 480, SVGA 800 x 600, XGA 1024 x 768, WXGA 1280 x 800, SXGA 1280 x 1024, FWXGA 1366 x 768, Full HD 1920 x 1080 <p>For information on the recommended screen resolution for the Multi Display Adapter's standby screen, refer to MDA Setting (<i>see page 61</i>).</p>
Firmware Update	<p>Updates the Multi Display Adapter firmware.</p> <p>You can download the firmware from our website: http://www.pro-face.com/trans/en/manual/1001.html</p>

MDA Finder

This feature is useful for identifying the selected Multi Display Adapter when you do not know its IP address, which can happen when you forget the IP address after having changed it, or when a different computer than the host was used to set up the IP address. You can also use the MDA Finder to start the Network Setting Tool.

You can download MDA Finder from our support site at <http://www.pro-face.com/trans/en/manual/1001.html>.

Before Using the MDA Finder

Before using the MDA Finder, change Windows® Firewall settings according to the following setup. Otherwise, you may not be able to detect this product.

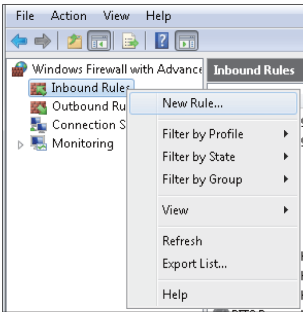
Step	Action
1	From the Windows® Start menu, open Control Panel → System and Security → Windows Firewall → Advanced settings .
2	Click Inbound Rules . Then, right-click it and select New Rule . 
3	Select Custom and then click Next .
4	Select All Programs and then click Next .

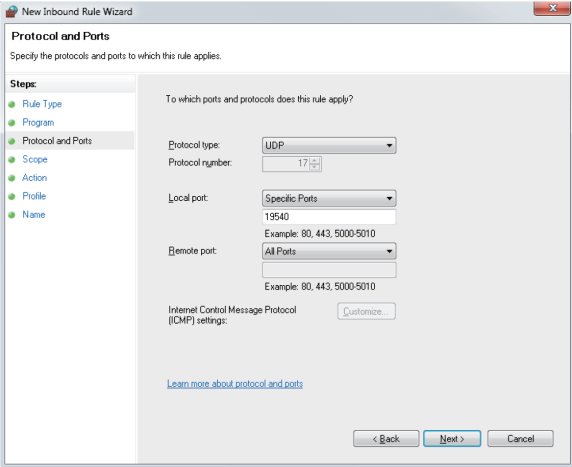
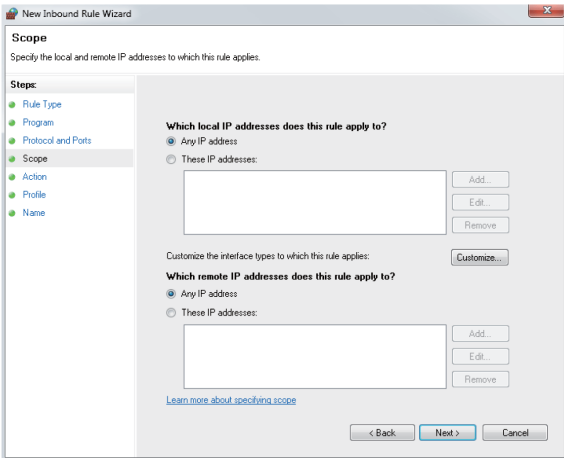
Step	Action
5	<p>Set Protocol type to UDP, Local port to Specific Ports, and enter 19540. Select All Ports for Remote port and then click Next.</p>  <p>The screenshot shows the 'New Inbound Rule Wizard' dialog box at the 'Protocol and Ports' step. The 'Steps' list on the left includes Rule Type, Program, Protocol and Ports, Scope, Action, Profile, and Name. The main area asks 'To which ports and protocols does this rule apply?'. The 'Protocol type' is set to 'UDP' and the 'Protocol number' is '17'. The 'Local port' is set to 'Specific Ports' with '19540' entered. The 'Remote port' is set to 'All Ports'. There are 'Back', 'Next', and 'Cancel' buttons at the bottom.</p>
6	<p>Select Any IP address and then click Next.</p>  <p>The screenshot shows the 'New Inbound Rule Wizard' dialog box at the 'Scope' step. The 'Steps' list on the left includes Rule Type, Program, Protocol and Ports, Scope, Action, Profile, and Name. The main area asks 'Specify the local and remote IP addresses to which this rule applies.'. Under 'Which local IP addresses does this rule apply to?', the 'Any IP address' radio button is selected. Under 'Which remote IP addresses does this rule apply to?', the 'Any IP address' radio button is also selected. There are 'Back', 'Next', and 'Cancel' buttons at the bottom.</p>
7	<p>Select Allow the connection and then click Next.</p>

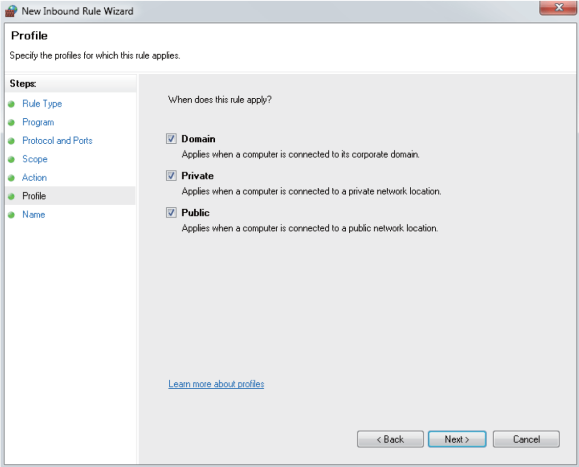
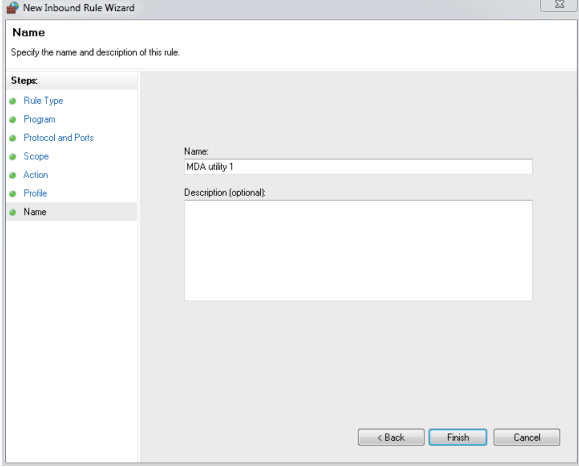
Step	Action
8	<p>From the Profile, select the check boxes of items that match your environment and then click Next.</p>  <p>The screenshot shows the 'New Inbound Rule Wizard' window at the 'Profile' step. The 'Steps' list on the left includes Rule Type, Program, Protocol and Ports, Scope, Action, Profile, and Name. The 'When does this rule apply?' section has three checked options: 'Domain' (Applies when a computer is connected to its corporate domain), 'Private' (Applies when a computer is connected to a private network location), and 'Public' (Applies when a computer is connected to a public network location). There are '< Back', 'Next >', and 'Cancel' buttons at the bottom.</p>
9	<p>In the Name field, enter a name (for example MDA utility 1) and click Finish.</p>  <p>The screenshot shows the 'New Inbound Rule Wizard' window at the 'Name' step. The 'Steps' list on the left includes Rule Type, Program, Protocol and Ports, Scope, Action, Profile, and Name. The 'Name' field contains the text 'MDA utility 1'. There is a 'Description (optional)' text area below it. There are '< Back', 'Finish', and 'Cancel' buttons at the bottom.</p>
10	Click Inbound Rules . Then, right-click it and select New Rule .
11	Select Program and then click Next .
12	Select This program path and then click Browse .
13	In the folder where you downloaded MDA Finder, select MdaFinder.exe .

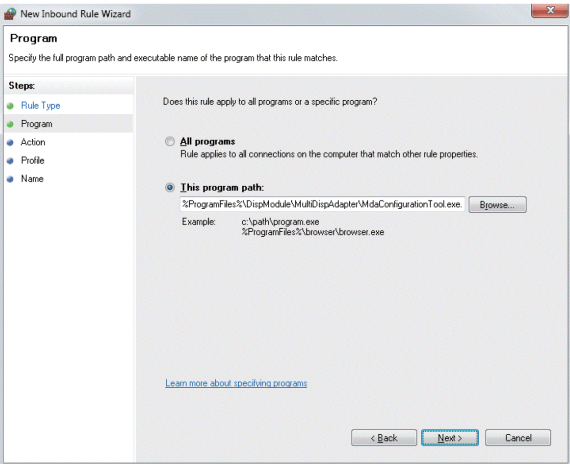
Step	Action
14	<p>After returning to the screen shown below, click Next.</p> 
15	Select Allow the connection and then click Next .
16	From the Profile, select the check boxes of items that match your environment, and then click Next .
17	In the Name field, enter a name (for example MDA Finder) and click Finish .

Operation Method

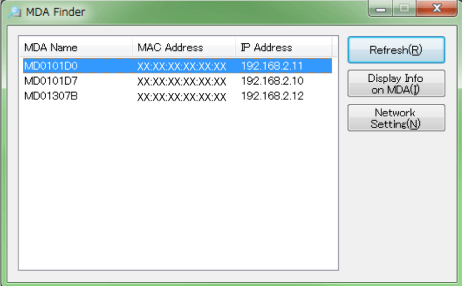
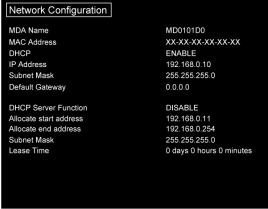
Step	Action
1	Download MDA Finder to the host, or to a different computer on the network.
2	Start MdaFinder.exe , which was downloaded.
3	<p>From the list of Multi display Adapters on the same network, select the Multi Display Adapter you want to set up.</p>  <p>NOTE: When the Multi Display Adapter does not display properly, touch the Refresh button.</p>
4	Touch the Network Setting button to display the Network Setting Tool in an Internet browser.
5	<p>Touch Display Info on MDA to display network information about the Multi Display Adapter selected in the list. This information appears on the display that has the Multi Display Adapter attached. Touch this button to show or hide the information on the Multi Display Adapter.</p> 

Chapter 8

After-sales Service

After-sales Service

Information

For details on after-sales service, refer to our website at
<http://www.pro-face.com/trans/en/manual/1001.html>

