

1 Download the manuals

You must have detailed information to be able to carry out the installation and commissioning.

This information can be found in the following manuals that can be downloaded on www.schneider-electric.com.

- The ATV320 [Installation manual \(NVE41289\)](#)
- The ATV320 [Programming manual \(NVE41295\)](#)

⚠ ⚠ DANGER

HAZARD OF ELECTRIC SHOCK, EXPLOSION, OR ARC FLASH

- Only appropriately trained persons who are familiar with and understand the contents of this manual and all other pertinent product documentation and who have received safety training to recognize and avoid hazards involved are authorized to work on and with this drive system. Installation, adjustment, repair and maintenance must be performed by qualified personnel.
- The system integrator is responsible for compliance with all local and national electrical code requirements as well as all other applicable regulations with respect to grounding of all equipment.
- Many components of the product, including the printed circuit boards, operate with mains voltage. Do not touch. Use only electrically insulated tools.
- Do not touch unshielded components or terminals with voltage present.
- Motors can generate voltage when the shaft is rotated. Prior to performing any type of work on the drive system, block the motor shaft to prevent rotation.
- AC voltage can couple voltage to unused conductors in the motor cable. Insulate both ends of unused conductors of the motor cable.
- Do not short across the DC bus terminals or the DC bus capacitors or the braking resistor terminals.
- Before performing work on the drive system:
 - Disconnect all power, including external control power that may be present.
 - Place a "Do Not Turn On" label on all power switches.
 - Lock all power switches in the open position.
 - Wait 15 minutes to allow the DC bus capacitors to discharge. The DC bus LED is not an indicator of the absence of DC bus voltage that can exceed 800 Vdc.
 - Measure the voltage on the DC bus between the DC bus terminals (PA/+, PC/-) using a properly rated voltmeter to verify that the voltage is < 42 Vdc.
 - If the DC bus capacitors do not discharge properly, contact your local Schneider Electric representative.
- Install and close all covers before applying voltage.

Failure to follow these instructions will result in death or serious injury.

Electrical equipment should be installed, operated, serviced, and maintained only by qualified personnel. No responsibility is assumed by Schneider Electric for any consequences arising out of the use of this material.

Information below is designed to use **single drive** connected to **single asynchronous motor with a motor cable length less than 50 m (164 ft)**. Verify your cables before connecting the drive with motor (length, power, shielded or unshielded).

2 Verify the delivery of the drive

- Unpack the drive and verify that it has not been damaged.

Damaged products or accessories may cause electric shock or unanticipated equipment operation.

⚠ ⚠ DANGER

ELECTRIC SHOCK OR UNANTICIPATED EQUIPMENT OPERATION

Do not use damaged products or accessories.

Failure to follow these instructions will result in death or serious injury.

Contact your local Schneider Electric sales office if you detect any damage whatsoever.

- Verify that the drive catalog number printed on the label is the same as that on the delivery note corresponding to the purchase order.
- Write the drive Model Reference: _____ and Serial Number: _____
- For ATV320U●●M2B, U0●N4B, U1●N4B, U22N4B...U30N4B, remove the output connector from the packaging and verify that it has not been damaged.



3 Verify The Supply Mains Compatibility

- Verify that the **supply mains** is compatible with the supply range of the drive.
Line voltage _____ Volts Drive voltage range _____ Volts
Drive range: ATV320●●●M2● = 200 V single phase, ATV320●●●M3C = 200 V three-phase, ATV320●●●N4● = 400 V three-phase, ATV320●●●S6C = 600 V three-phase

4 Mount The Drive Vertically

For a surrounding air temperature up to 50 °C (122°F). See the [Installation manual \(NVE41289\)](#) for other mounting and thermal conditions.

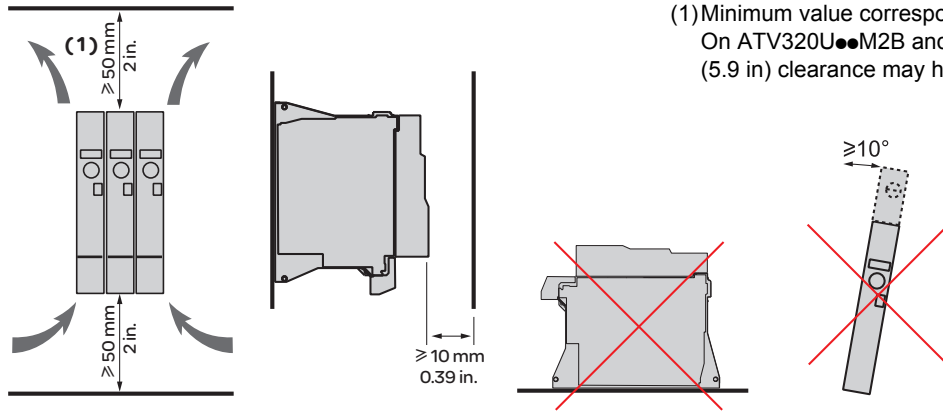

5 Connect The Drive: Power

- Connect the drive to the ground.
- Verify circuit breaker rating or fuse rating. (See [SCCR annex NVE21777](#))
- Verify that the nominal motor voltage is compatible with the drive voltage. Nominal motor voltage _____ volts.
- Connect the drive to the motor.
- Connect the drive to the supply mains.

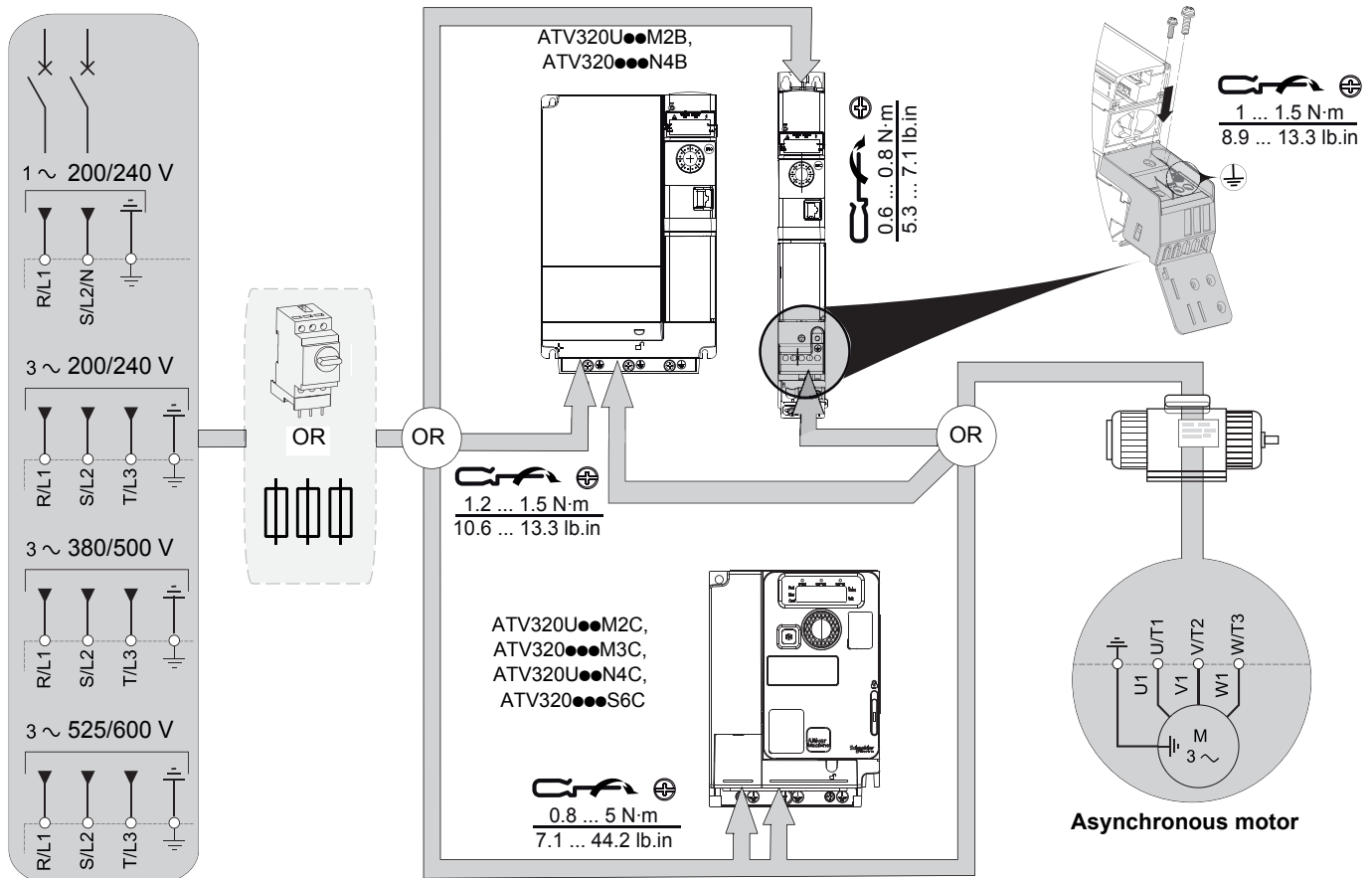

⚠ ⚠ DANGER

HAZARD OF FIRE OR ELECTRIC SHOCK

Wire cross sections and tightening torques must comply with the specifications provided in the installation manual.

Failure to follow these instructions will result in death or serious injury.

6 Connect The Drive: Control by External Reference (FrI = ALI)

- Connect the speed reference:

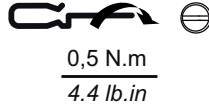
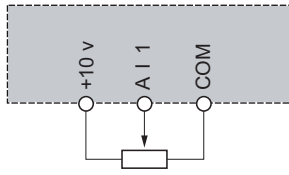

- Connect the command:

Control command 2-wire: Parameter $CC = 2C$

D11: forward
D12: reverse

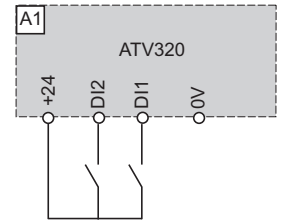
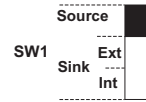

7 Apply power to the drive

- Ensure that used digital Inputs are not active (D11, D12 see step 6 diagram above).
- Apply power to the drive.
- At first power up, the drive displays bFr , in the menu SiP - [SIMPLY START]

8 Set motor parameters for asynchronous motor (2).

- Refer to the motor Nameplate for the following parameters settings .

Menu	Code	Description	Factory setting	Customer setting
$CONF > FULL > SiP$ - [SIMPLY START]	bFr	[Standard mot. freq]: Standard motor frequency (Hz)	50.0	
	nPr	[Rated motor power]: Nominal motor power on motor nameplate (KW)	drive rating	
	unS	[Rated motor volt.]: Nominal motor voltage on motor nameplate (V)	drive rating	
	nCr	[Rated motor current]: Nominal motor current on motor nameplate (A)	drive rating	
	FrS	[Rated motor freq.]: Nominal motor frequency on motor nameplate (Hz)	50.0	
	nSP	[Rated motor speed]: Nominal motor speed on motor nameplate (rpm)	drive rating	
	iLH	[Mot. therm. current]: Nominal motor current on motor nameplate (A)	drive rating	

(2)for synchronous motor, consult the [Programming manual \(NVE41295\)](#) on [www.schneider-electric.com](#).

9 Set basic parameters

Menu	Code	Description	Factory setting	Customer setting
$CONF > FULL > SiP$ - [SIMPLY START]	ACC	[Acceleration]: Acceleration time (s)	3.0	
	DEC	[Deceleration]: Deceleration time (s)	3.0	
	LSP	[Low speed]: Motor frequency at minimum reference (Hz)	0.0	
	HSP	[High speed]: Motor frequency at maximum reference (Hz)	50.0	

10 Start the motor

- Switch on D11

Menus structure

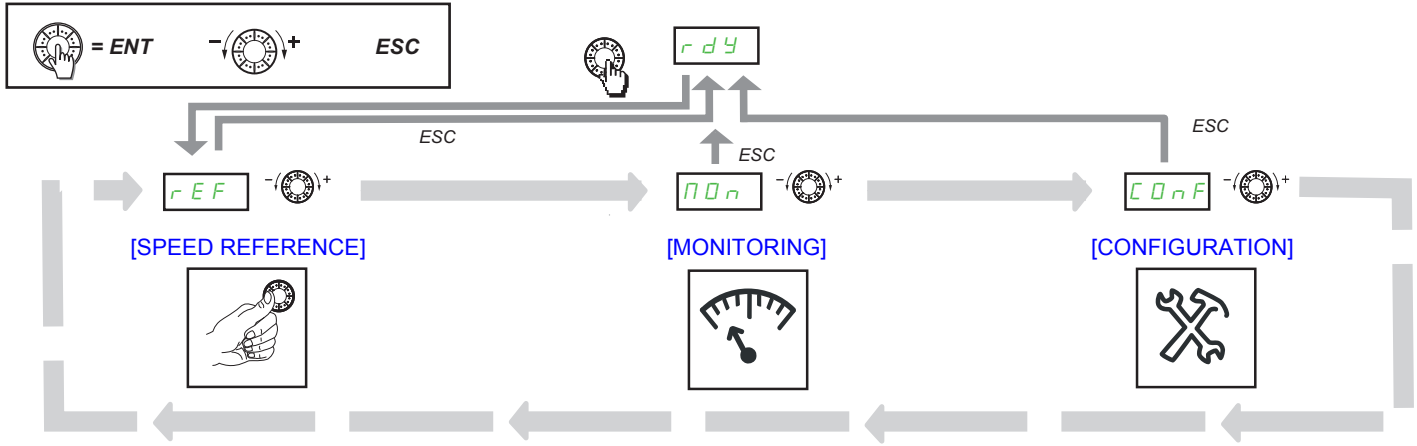

A dash appears after menu codes to differentiate them from parameter codes. Example: **[SIMPLY START]5 IN-**, **EEC** parameter.

Refer to the [Programming manual \(NVE41295\)](#) for comprehensive menu descriptions.

