



DANGERS

When Designing your GLC System:

- **Be sure to design your GLC control system so that in the event of a main power supply failure or a GLC accident, the user system's overall safety integrity will be maintained. If this is not done, incorrect output signals or a GLC malfunction may cause an accident.**
 - (1) **Interlock circuits, etc. designed to interrupt or oppose normal machine movement (i.e. Emergency Stop, General Protection, forward and reverse rotation, etc.), as well as those designed to prevent machine damage (i.e. for upper, lower and traverse movement limit positioning, etc.) should all be designed to be located outside of the GLC.**
 - (2) **Whenever the GLC generates a "Watchdog Timer Error", GLC operation will halt. Also, when errors occur in Input/Output control areas that the GLC cannot detect, it is possible for unexpected movement to occur in those areas. As a result, for the purpose of preventing unsafe machine movement, a "Failsafe Circuit" should be created which is completely external to the GLC.**
 - (3) **If a problem arises with an external unit's relay or transistor, causing an output (coil) to remain either ON or OFF, a major accident can occur. To prevent this, be sure to set up external watchdog circuits that will monitor vital output signals.**
- **Be sure to design a circuit that will supply power to the GLC's I/O unit before starting up the GLC. If the GLC's internal program enters RUN mode prior to the I/O unit's load control power turning ON, an incorrect output (signal) or malfunction could cause an accident to occur.**
- **Be sure to design a program that will ensure the safety of the user's system, in the event of a GLC display or control error, or in the event of either a data transmission error or power failure between the GLC and a connected unit. These types of problems can lead to an incorrect output (signal) or malfunction, which could thereby cause an accident to occur.**
- **Do not create GLC touch panel switches that could possibly endanger the safety of equipment and personnel. Damage to the GLC, its I/O unit(s), cable(s), and other related equipment can cause an output signal to remain continuously ON or OFF and possibly cause a major accident. Therefore, design all monitoring circuits using limit switches, etc. to detect incorrect device movement. To prevent accidents related to incorrect signal output or operation, design all switches used to control vital machine operations so they are operated via a separate control system.**



DANGERS

- Do not use the GLC unit as a warning device for critical alarms that can cause serious operator injury, machine damage or production stoppage. Critical alarm indicators and their control/activator units must be designed using stand-alone hardware and/or mechanical interlocks.
- Do not use GLC touch panel switches to perform operator safety-related or important accident prevention operations. These operations should be performed by separate hardware switches to prevent operator injury and machine damage.
- Be sure to design your system so that equipment will not malfunction due to a communication fault between the GLC and its host controller. This is to prevent any possibility of bodily injury or material damage.
- The GLC is not appropriate for use with aircraft control devices or medical life support equipment, central trunk data transmission (communication) devices, nuclear power control devices, or medical life support equipment, due to these devices inherent requirements of extremely high levels of safety and reliability.
- When using the GLC with transportation vehicles (trains, cars and ships), disaster and crime prevention devices, various types of safety equipment, non-life support related medical devices, etc. redundant and/or failsafe system designs should be used to ensure the proper degree of reliability and safety.



WARNINGS

Touch Panel Warnings:

After the GLC's backlight burns out, unlike the GLC's "Standby Mode", the touch panel is still active. If the operator fails to notice that the backlight is burned out and touches the panel, a potentially dangerous machine operation error can occur.

- 1) If your GLC is not set to " Standby Mode" and the screen has gone blank, your backlight is burned out.
- 2) Or, if your GLC is set to Standby Mode, but touching the screen does not cause the display to reappear, your backlight is burned out.

Also, to prevent an accidental machine operation error, Pro-face suggests you use the GLC's built-in "USE TOUCH PANEL AFTER BACKLIGHT BURNOUT" feature, that will automatically detect a burnout and disable the touch screen.

Installation Warnings:

- High voltage current runs through the GLC. Except for replacing the backlight, never disassemble the GLC, otherwise an electric shock can occur.

- Do not modify the GLC unit. Doing so may cause a fire or an electric shock.
- Do not use the GLC in an environment where flammable gasses are present, since operating the GLC may cause an explosion.

Wiring Warnings:

- To prevent electric shock or equipment damage, prior to installing or wiring the GLC, confirm that the GLC's power cord is unplugged from the power supply.
- After completing any GLC wiring work, be sure the terminal block's protective plastic cover is reattached. If this cover is not reattached, an electric shock could easily occur.
- Do not use power levels with the GLC that are outside of the GLC's specified power range. Doing so may cause a fire, electric shock or damage the GLC.
- Do not operate or store the GLC in areas where flammable gasses are present, since operating the GLC may cause an explosion.

Operation and Maintenance Warnings:

- Do not touch a live power terminal. This could cause a shock or machine malfunction.
- Due to the danger of an electric shock, confirm that the GLC's power cord is unplugged before either cleaning the GLC or attaching/detaching the power terminal block screws.
- When replacing the GLC's backlight, be sure to unplug the unit's power cord to prevent a shock, and wear gloves to prevent being burned.
- The GLC uses a lithium battery for backing up its internal clock and control memory data. If the battery is incorrectly replaced (i.e. the + and - sides are reversed), the battery may explode. Therefore, before changing the battery, Pro-face recommends that you contact your local GLC distributor for battery replacement instructions.
- Do not attempt to modify the GLC's internal parts or wiring in any way, since this may lead to either a shock or fire.



CAUTIONS

Wiring Layout Cautions:

- Be sure that all GLC input/output signal lines are isolated from all power wiring or power cables, via a separate wiring duct. This is to prevent excessive noise, which can cause a unit malfunction.

Installation Cautions:

- Be sure any data cable attached to a GLC connector is securely attached. If the cable and connector pins do not all make complete contact, incorrect input or output signals can result. e noise, which can cause a unit malfunction.

- The GLC must be used as a built-in component of an end-use product.
- The GLC should be installed in the front face of a metal panel.
- If the GLC is installed so as to cool itself naturally, be sure to install it in a vertical panel.

General Wiring Cautions:

- To prevent shocks or malfunctions, the GLC's FG (earth) wire should be grounded according to the following:
 - 1) A maximum grounding resistance of 100Ω or less.
 - 2) A grounding wire of 2mm² or larger should be used.
- The GLC's wiring should be checked to confirm both that the operating voltage and wiring terminal locations are correct. If either the voltage or the wiring terminal locations are incorrect, it can cause a fire or accident.
- Be sure to secure all wiring terminal screws in place with the designated torque. Screws and terminals that become loose can cause a short circuit, fire or accident.
- Be sure that metal filings or wiring remnants do not fall inside the GLC, since they can cause a fire, accident, or malfunction.

GLC Operation and Maintenance Cautions:

- Be sure to read the GLC's manual and on-line help information carefully before performing program changes, forced output, or utilizing the RUN, STOP, PAUSE, Enable I/O and other commands while the GLC is in operation. Mistakes concerning the use of these items can cause a machine accident or damage.
- The liquid crystal panel contains a powerful irritant and if for any reason the panel is damaged and this liquid enters your eye, flush your eye for 15 minutes with running water and contact a physician.
- Prior to inserting or removing a CF Card, be sure to turn the GLC's CF Card ACCESS switch OFF and to confirm that the ACCESS lamp is not lit. If you do not, CF Card internal data may be damaged or lost.
- Do not turn OFF or reset the GLC while a CF Card is being accessed or insert or remove the CF Card. Prior to performing these operations, create and use a special GLC application screen that will prevent access to the CF Card.

GLC Unit Disposal Cautions:

- Be sure to dispose of the GLC unit in a manner appropriate to your country's industrial machinery disposal standards.

UL/c-UL Approval

The GLC2500-TC41-200V, GLC2600-TC41-200V are UL/c-UL recognized components. (UL file No. E231702)

GLC2500-TC41-200V (UL Registration Model : 3280036-02)

GLC2600-TC41-200V (UL Registration Model : 3280036-01)

These products conform to the following standards:

■ **UL1604**

Electrical Equipment for Use in Class I and II Division 2 and Class III Hazardous(Classified) locations

■ **UL60950**

Safety Standard for Information Technology Equipment (3rd Edition, issued December 1, 2001)

■ **CAN/CSA-C22.2, No.213-M1987 (c-UL Approval)**

Safety Standard for Information Technology and Electrical Business Equipment

■ **CAN/CSA-C22.2, No.60950-00 (c-UL Approval)**

Safety Standard for Information Technology Equipment (3rd Edition, issued December 1, 2001)

<**Cautions**>

Be aware of the following items when building the GLC into an end-use product:

- The GLC unit's rear face is not approved as an enclosure. When building the GLC unit into an end-use product, be sure to use an enclosure that satisfies standards as the end-use product's overall enclosure.
- The GLC unit must be used indoors only.
- Install and operate the GLC with its front panel facing outwards.
- If the GLC is mounted so as to cool itself naturally, be sure to install it in a vertical panel. Also, insure that the GLC is mounted at least 100 mm away from any other adjacent structures or machine parts. If these conditions are not met, the heat generated by the GLC unit's internal components may cause it to fail to meet UL standards.
- When building the GLC into an end-use product, UL evaluation and approval must be obtained for the combination of the GLC and the end-use product.

UL1604 Conditions of Acceptability and Handling Cautions:

1. Power, input and output (I/O) wiring must all be in accordance with Class I, Division 2 wiring methods, Article 501-4 (b) of the National Electrical Code, NFPA 70, or as specified in Section 18-152 of the Canadian Electrical Code for units installed within Canada, and in accordance with that location's authority.
2. Suitable for use in Class I, Division 2, Groups A, B, C and D hazardous location.
3. **WARNING:** Explosion hazard - substitution of components may impair suitability for Class I, Division 2.
4. **WARNING:** Explosion hazard - when in hazardous locations, turn the power off before replacing or wiring modules.
5. **WARNING:** Explosion hazard - do not disconnect equipment unless power has been switched off or the area is known to be nonhazardous.
6. **WARNING:** Explosion hazard - do not connect/ disconnect equipment unless area is known to be nonhazardous. Port is for system set up and diagnostics.

CE Marking

The GLC2500-TC41-200V and GLC2600-TC41-200V are CE marked products that conform to EMC directives and the Low-voltage directive EN55011 Class A, EN61000-3-2, EN61000-3-3, EN61000-6-2 and EN60950.

For detailed CE marking information, please contact your local GLC distributor.

<Cautions>

- The GLC unit's rear face is not approved as an enclosure. When building the GLC unit into an end-use product, be sure to use an enclosure that satisfies standards as the end-use product's overall enclosure.
- The GLC unit must be used indoors only.
- Install and operate the GLC with its front panel facing outwards.
- If the GLC is mounted so as to cool itself naturally, be sure to install it in a vertical panel. Also, insure that the GLC is mounted at least 100 mm away from any other adjacent structures or machine parts. If these conditions are not met, the heat generated by the GLC unit's internal components may cause it to fail to meet the standard requirements.

Package Contents

The following items are included in the GLC's package. Before using the GLC, please confirm that all items shown here are present.

- **GLC Unit (1)**
(GLC2500-TC41-200V/
GLC2600-TC41-200V)

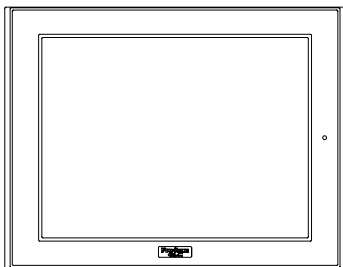

- **Installation Guide (1)**
<This Guide>



- **Installation Fasteners (4)**

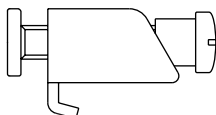

This unit has been carefully packed, with special attention to quality. However, should you find anything damaged or missing, please contact your local GLC distributor immediately.

1 Part Names

A : Display

B : Touch Panel

C : Status LED

Color	Indicator	Operation Mode ^{*1}	Controller Operation Mode ^{*2}
Green	ON	OFFLINE	--- ^{*3}
	ON	In operation	RUN
	Flashing	In operation	STOP
Red	ON	In operation	Major Error

Color	Indicator	Meaning
Orange	ON	Backlight burnout has occurred.

**1 Operation mode includes Display, SIO Communication and touch key features.*

**2 Includes the performance of ladder circuit program features.*

**3 Changing to OFFLINE will release and stop ladder circuit program features.*

D : Power Input Terminal Block

E : Expansion Unit Interface 1

F : Expansion Unit Interface 2

G : CF Card Expansion Interface

H : CF Card Cover

I : CF Card Access LED

J : CF Card Slot (inside cover)

K : Serial Interface (Dsub 25-pin)

L : Expansion Serial Interface (Dsub 9-pin)

M : Printer Interface (Half Pitch 20-pin)

N : Ethernet Interface

O : Flex Network LED

P : Screw Lock Terminal Block

Q : Tool Connector

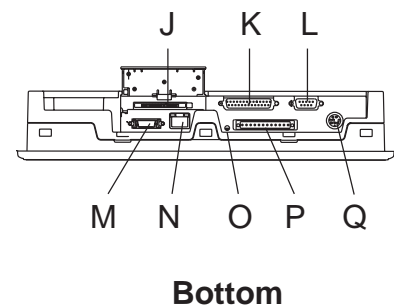
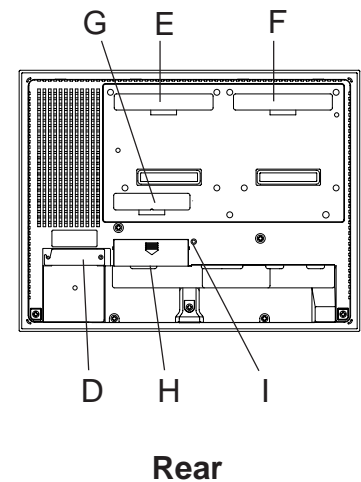
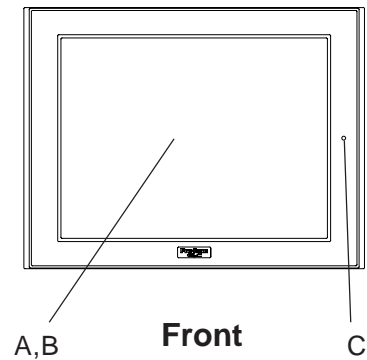

2 Dimensions

Unit:mm [in.]

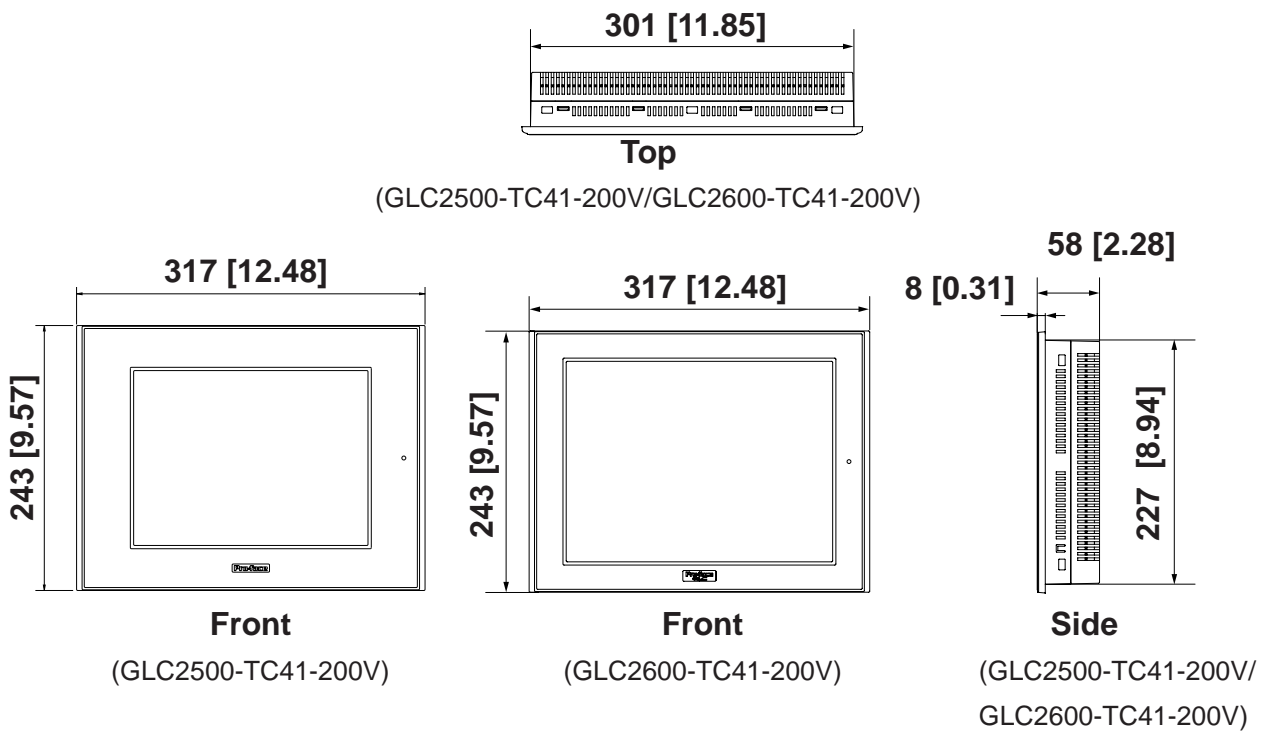

3 CF Card Dip Switches

These switches are located inside the CF Card's cover.

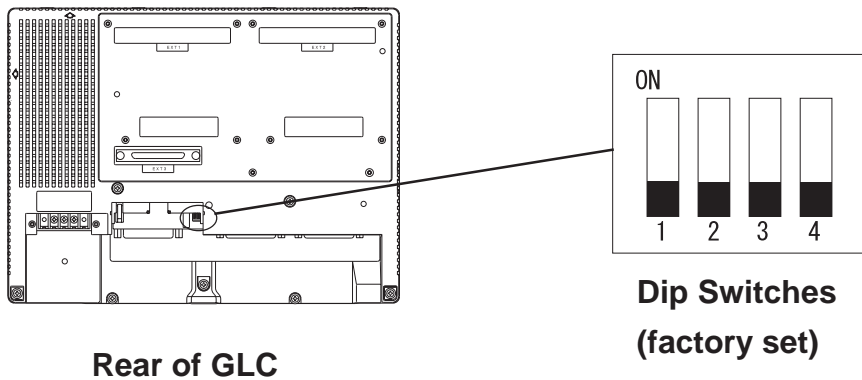

Dip Switch	Function	ON	OFF	Note
1	This Dip switch setting controls the startup from a CF Card.	Startup from CF Card is enabled.	Startup from CF Card is disabled.	CF Card with startup data required.
2	Reserved	—	—	Always OFF
3	Reserved	—	—	Always OFF
4	This setting controls the forced closing of the CF Card cover.	Forced close enabled.	Forced close disabled.	Used when CF Card cover is damaged.

4 Interfaces

Serial Interface

This interface is used to connect the GLC to the host (PLC), via an RS-232C or RS-422 cable. The connector used is a socket-type connector.

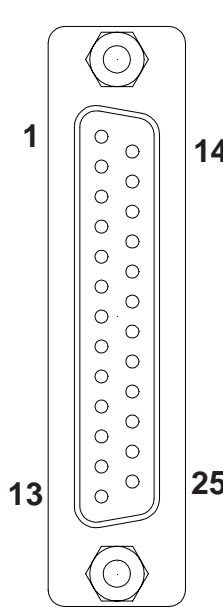
Pin Arrangement	Pin #	Signal Name	Condition
	1	FG	Frame Ground
	2	SD	Send Data (RS-232C)
	3	RD	Receive Data (RS-232C)
	4	RS	Request to Send (RS-232C)
	5	CS	Clear to Send (RS-232C)
	6	DR	Data Set Ready (RS-232C)
	7	SG	Signal Ground
	8	CD	Carrier Detect (RS-232C)
	9	TRMX	Termination (RS-422)
	10	RDA	Receive Data A (RS-422)
	11	SDA	Send Data A (RS-422)
	12	NC	Not Connected (Reserved)
	13	NC	Not Connected (Reserved)
	14	VCC	5V±5% Output 0.25A
	15	SDB	Send Data B (RS-422)
	16	RDB	Receive Data B (RS-422)
	17	RI	Ring Indicate (RS-232C)
	18	CSB	Clear to Send B (RS-422)
	19	ERB	Enable Receive B (RS-422)
	20	ER	Enable Receive (RS-232C)
	21	CSA	Clear to Send A (RS-422)
	22	ERA	Enable Receive A (RS-422)
	23	NC	Not Connected (Reserved)
	24	NC	Not Connected (Reserved)
	25	NC	Not Connected (Reserved)

Recommended Connector : Dsub 25-pin plug XM2A-2501 <made by OMRON Corp.>

Recommended Cover : Dsub 25-pin Cover XM2S-2511 <made by OMRON Corp.>

Recommended Screw : Jack Screw XM2Z-0071 <made by OMRON Corp.>

Recommended Cable : CO-MA-VV-SB5P x 28AWG <made by HITACHI Cable Ltd.>



- ***This GLC unit's serial port is not isolated. When the host (PLC) unit is also not isolated, and to reduce the risk of damaging the RS-422 circuit, be sure to connect the #7 SG (Signal Ground) terminal.***
- ***Pin #14 (VCC) DC 5V Output is not protected. To prevent damage or unit malfunction, use only the designated level of current.***
- ***Inside the GLC unit, the SG (Signal Ground) and FG (Frame Ground) terminals are connected to each other.***
- ***When connecting an external device to the GLC with the SG terminal, ensure that no short-circuit loop is created when you setup the system.***



- Use rough metric type M2.6 x 0.45p threads to hold the cable's set (fastening) screws in place
- For RS-422 Connectors
 - The following pairs of pin numbers must be connected (shorted).
 - ...#18 (CSB) <-> #19 (ERB)
 - ...#21 (CSA) <-> #22 (ERA)
 - Connecting the #9 (TRMX) and #10 (RDA) wires, adds a termination resistance of 100Ω between RDA and RDB.
 - Use a 4-wire cable when the PLC type is Memory Link and the cable is RS-422.
- For RS-232C Connectors
 - Do not connect #9 (TRMX), #10 (RDA), #11 (SDA), #15 (SDB), #16 (RDB), #18 (CSB), #19 (ERB), #21 (CSA), and #22 (ERA).
 - The #1 (FG) terminal should only be connected if it is required by the device being connected to.

■ Expansion Serial Interface

The connector used is a plug-type connector.

Pin Arrangement	Pin #	Signal Name	Meaning
	1	CD	Carrier Detect(RS-232C)
	2	RD	Receive Data(RS-232C)
	3	SD	Send Data(RS-232C)
	4	ER	Enable Receive(RS-232C)
	5	SG	Signal Ground
	6	DR	Data Set Ready(RS-232C)
	7	RS	Request to Send(RS-232C)
	8	CS	Clear to Send(RS-232C)
	9	RI/VCC	Ring Indicate(RS-232C) 5V±5% 0.25A

Recommended Connector :Dsub 9-pin socket XM2D-0901 <made by OMRON Corp.>

Recommended Cover :Dsub 9-pin cover XM2S-0913 <made by OMRON Corp.>

Recommended Screw :Jack Screw XM2Z-0073 <made by OMRON Corp.>

Use inch type screws (#4-40UNC) as set screws.



Since Pin#9(RI/VCC) is unprotected, be sure to keep the output current within the rated range.

■ Printer Interface

When connecting a printer, use Digital's printer cable (PSM-PRCB00).

Pin Arrangement	Pin #	Signal Name	Meaning
	1	GND	Ground
	2	RESERVE	Reserved
	3	PDB5	Data Signal
	4	PDB4	Data Signal
	5	PDB3	Data Signal
	6	GND	Ground
	7	SLCT	Select Condition(Input)
	8	PDB0	Data Signal
	9	PSTB	Strobe Signal(Output)
	10	BUSY	Busy Signal(Input)
	11	PDB7	Data Signal
	12	PDB6	Data Signal
	13	GND	Ground
	14	ERROR	Printer Error(Input)
	15	GND	Ground
	16	PDB2	Data Signal
	17	PDB1	Data Signal
	18	PE	Paper End
	19	INIT	Initialize Signal(Output)
	20	GND	Ground

■ Screw Lock Terminal Block

This interface is used for external reset, Flex Network connections, or sound output.

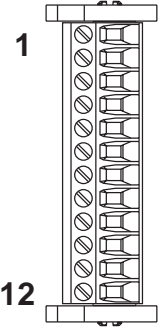
Pin Arrangement	I/F	Pin No.	Signal Name	Meaning
	External Reset	1	AUXCOM	External Reset Common
		2	AUXRESET	External Reset Input
	Flex Network I/F	3	TR+	CH1 Communication Data
		4	TR-	CH1 Communication Data
		5	SLD	CH1 Cable, Shield
		6	TR+	CH2 Communication Data
		7	TR-	CH2 Communication Data
		8	SLD	CH2 Cable, Shield
	—	9	Reserved	Reserved
	Sound I/F	10	SP OUT	Speaker Output Terminal
		11	GND	Ground
		12	LINE OUT	Line Out Output Terminal

■ Ethernet Interface

This interface complies with the IEEE802.3 standard for Ethernet (10BASE-T) connections. This interface uses an RJ-45 type modular jack (8 points).

■ CF Card Interface

This slot accepts a CF Card.

■ Expansion CF Card Interface

This interface is for connecting the Front Maintenance CF Card Unit.

■ Expansion Unit Interface 1

This interface is used to connect an expansion unit that can transmit data over

■ Expansion Unit Interface 2

Provides expanded features.

■ Tool Connector

Connects a Data Transfer Cable or bar code reader.

5 Installation

■ Confirm the Installation Gasket's Positioning

It is strongly recommended that you use the gasket. It absorbs vibration in addition to repelling moisture.

Place the GLC on a level surface with the display panel facing downward. Check that the GLC's installation gasket is seated securely into the gasket's groove, which runs around the perimeter of the panel's frame.



- **Before installing the GLC into a cabinet or panel, check that the installation gasket is securely attached to the unit.**
- **A gasket which has been used for a long period of time may have scratches or dirt on it, and could have lost much of its dust and drip resistance. Be sure to change the gasket periodically (or when scratches or dirt become visible).**

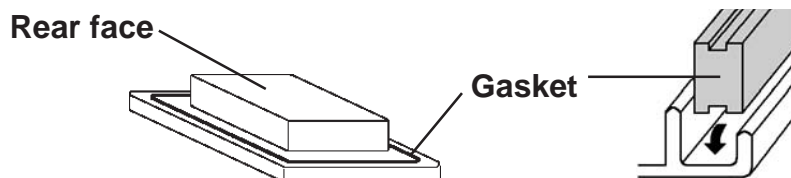

■ **Create a Panel Cut and insert the GLC into the panel from the front**

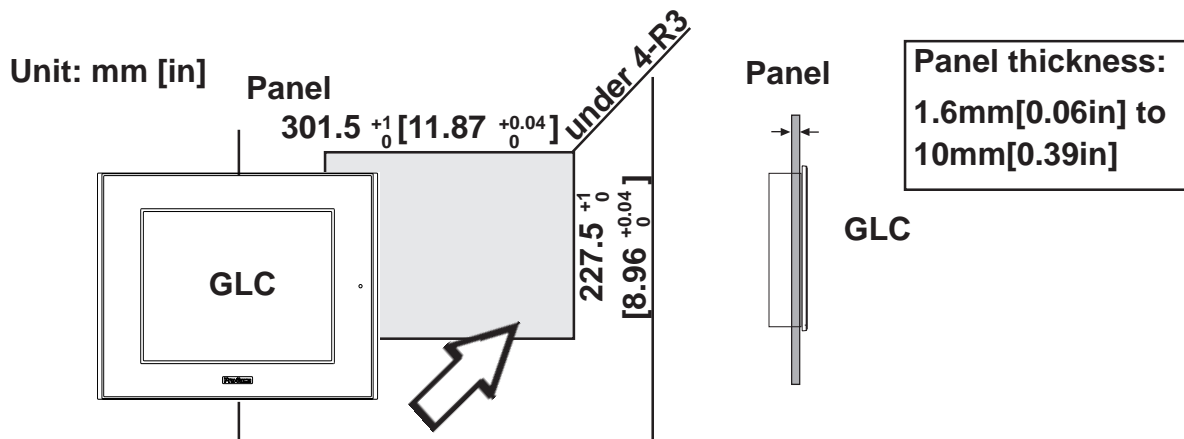

■ **Attach the Installation Fasteners from Inside the Panel**

The following figures show the four (4) fastener insertion slot locations. Insert each fastener's hook into the slot and tighten it with a screwdriver.

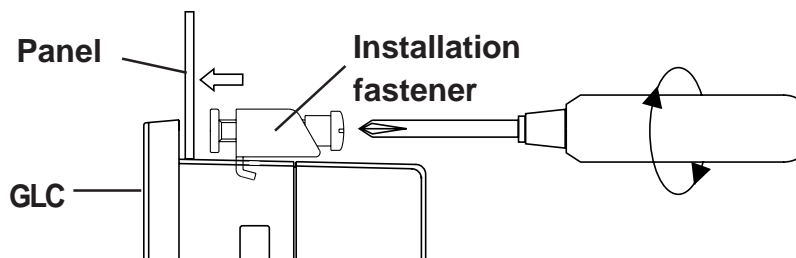
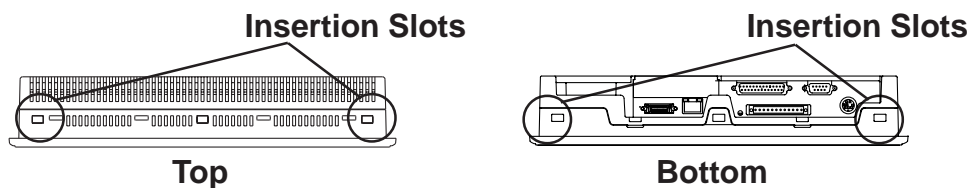

- ***Tightening the screws with too much force can damage the GLC's plastic case.***



- ***The necessary torque is 0.5 N•m.***
- ***Depending on the installation panel's thickness, etc., the number of installation fasteners used may need to be increased to provide the desired level of moisture resistance.***

6 Wiring



WARNINGS

- **To avoid an electric shock, when connecting the GLC's power cord terminals to the power terminal block, confirm that the GLC's power supply is completely turned OFF, via a breaker, or similar unit.**
- **The GLC2500-TC41-200V and GLC2600-TC41-200V units are designed to use only with 100 V to 240V AC input. Any other power level can damage both the GLC and the power supply.**
- **Since there is no power switch on the GLC unit, be sure to attach a breaker-type switch to its power cord.**
- **When the FG terminal is connected, be sure the wire is grounded.**



- To avoid a short caused by loose ring terminals, be sure to use ring terminals with an insulating sleeve. *1



- When the FG terminal is connected, be sure the wire is grounded. Not grounding the GLC unit will result in excess noise and vibration.
- Wherever possible, use thick wires (max. 2 mm²) for power terminals, and twist the wire ends before attaching the ring terminals.
- Be sure to use the following size ring terminals.

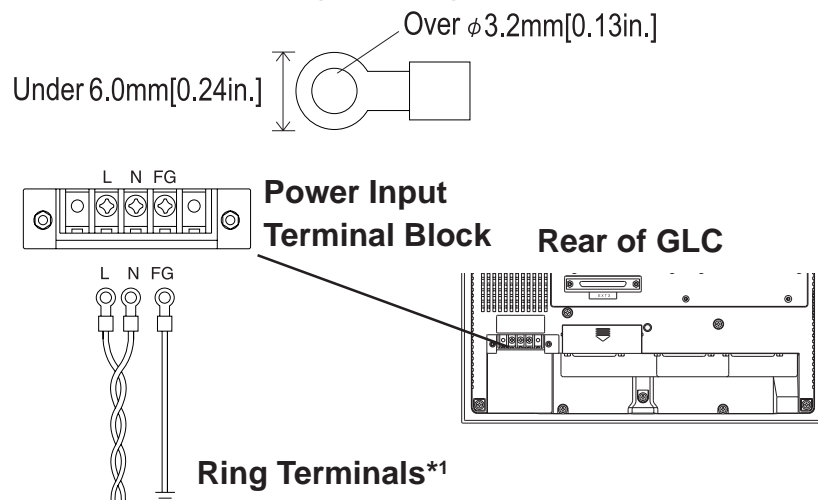

Connecting the GLC Power Cord

When connecting the power cord, be sure to follow the procedures given below.

1. Confirm that the GLC's Power Cord is unplugged from the power supply.
2. Use a screwdriver to remove the Power Input Terminal Block's clear plastic cover.
3. Unscrew the screws from the middle three (3) terminals, align the Ring Terminals and re-attach the screws.
4. Replace the Power Input Terminal Block's clear plastic cover.



- Confirm that the ring wires are connected correctly.
- The torque required to tighten these screws is 0.5 to 0.6 N•m.

*1 L=AC Input Live Line
N=AC Input Neutral Line
FG=Grounding Terminal connected to the GLC chassis.
Suggested Ring Terminal : equivalent to V2-MS3 (made by JST)

7 Power Supply Cautions

Please pay special attention to the following instructions when connecting the power cord terminals to the GLC unit.

- If the power supply voltage exceeds the GLC's specified range, connect a voltage transformer.
- Between the line and the ground, be sure to use a low noise power supply. If there is still an excessive amount of noise, connect a noise reducing transformer.
- Input and Output signal lines must be separated from the power control cables for operational circuits.
- To increase the noise resistance, be sure to twist the ends of the power cord wires before connecting it to the GLC unit.
- The GLC's power supply cord should not be bundled with or kept close to main circuit lines (high voltage, high current), or input/output signal lines.
- Connect a surge absorber to handle power surges.
- To reduce noise, make the power cord as short as possible.

8 Grounding Cautions

- When attaching a wire to the GLC's rear face FG terminal, (on the Power Input Terminal Block), be sure to create an exclusive ground.
- Inside the GLC2500-TC41-200V/GLC2600-TC41-200V units, the SG (Signal Ground) and FG(Frame Ground) terminals are connected to each other.
- When connecting an external device to the GLC with the SG terminal, ensure that no short-circuit loop is created when you setup the system.
- When attaching an expansion unit to the GLC, be sure to read the expansion unit's Installation Guide.

9 Input/Output Signal Line Cautions

- All GLC Input and Output signal lines must be separated from all operating circuit (power) cables.
- If this is not possible, use a shielded cable and ground the shield.

10 Replacing the Backlight

The GLC unit's backlight is user replaceable.



Do not use of a different model backlight, since it may cause a GLC malfunction or breakdown.

For an explanation of how to replace the GLC's backlight, please refer to the User Manual or the Installation Guide which comes with the replacement backlights (sold separately).

GLC Unit	Rev.	Required Backlight Model
GLC2500-TC41-200V	-	GP577RT-BL00-MS
GLC2600-TC41-200V*1	Rev.4 is marked	CA3-BLU12-01
	The others	PS600-BU00

*1 For GLC2600 Series, the backlight differs depending on a Rev. For the correct backlight and how to distinguish Rev., refer to the User Manual carried in the Pro-face Web Site (<http://www.pro-face.com/>).