

Preface

Thank you for purchasing the Pro-face GP-37WL, one of the Digital Electronics Corporation's series of Graphic Control Panels (hereafter referred to as the GP-37WL unit).

Please read this manual carefully as it explains, step by step, how to use the GP's functions and features correctly.

For example purposes this manual uses the Mitsubishi MELSEC-AnA Series PLC wherever possible, connected in a one-to-one (direct) relationship with the GP-37WL.

This GP-37WL series unit is a CE marked product, that conforms to EMC Directives EN55022 Class A and EN50082-2.



1. It is forbidden to copy the contents of this manual, either in whole or in part, except for the purpose of the user's personal use, without the express written permission of the Digital Electronics Corporation of Japan.
2. The information provided in this manual is subject to change without notice.
3. This manual has been written with care and attention to detail; however, should the user discover any errors or omissions, please contact the Digital Electronics Corporation and inform them of your findings.
4. Please be aware that the Digital Electronics Corporation is not responsible for any damages resulting from the use of its products, regardless of article 3 above.

All company or manufacturer names used in this manual are the registered trademarks of their respective companies.

© Copyright 1997, Digital Electronics Corporation

MS-DOS and Windows®95 are registered trademarks of the Microsoft Corporation.

Safe Product Usage

This manual contains a variety of safety markings to help you safely and correctly operate Digital's GP-37WL Graphic Control Panel.

Be sure to keep this manual handy for future reference.

■ Safety Icons

This manual uses the two icons below to call attention to information important for the safe and correct use of the GP. Please pay attention to these icons and follow all instructions given by them.

The safety icons and their meanings are:



Indicates a potentially hazardous situation which could result in serious injury or even death, if the instructions are not followed.



Indicates a potentially hazardous situation which could result in minor injury or equipment damage if the instructions are not followed.



Essential Safety Precautions

For the safe and correct use of this unit, be sure to follow the guidelines stated below:

- Due to the possibility of an electrical shock, be sure the Power Cord is not plugged in to a power supply when first connecting the Power Cord's power terminals to the GP-37WL.
- Because the GP-37WL contains high voltage parts, an electrical shock can occur if the user tries to disassemble the unit. The GP-37WL should be disassembled only by an authorized serviceman.
- Do not use power which is outside of the specified voltage range. Doing so may cause a fire or an electric shock.
- Do not attempt to modify or alter the GP-37WL unit. Doing so may cause a fire or an electric shock.
- Do not use the GP-37WL in an environment that contains flammable gases, since it may cause explosion.
- The GP-37WL uses a lithium battery to back up its internal clock data. If this battery is incorrectly replaced, however, it may explode. To prevent this, be sure to consult with your local GP-37WL distributor before changing this battery.
- Do not use this unit's touch panel keys to perform any life-threatening or accident-prevention operations (i.e. as an Emergency Stop switch, etc.) Be sure to use separate hardware switches for such operations.
- Please design your machine's control system so that it will not malfunction due to a communication fault between the GP-37WL and the host controller (PLC).

If this is not done, there could be a danger of either personal injury or machinery/material damage.



General Safety Precautions

To Avoid Damaging the GP-37WL:

- Do not strike or hit the touch panel with either hard or heavy objects, or push the touch panel's face too strongly.
- Storing or operating the GP-37WL in environments with temperatures outside the specified allowable ranges may cause the unit to break down.
- Do not allow water, liquids, or metal particles to enter into the GP-37WL's case, since it can cause a malfunction or electrical shock.
- Avoid operating the GP-37WL in locations where sudden temperature changes can cause condensation to form inside the unit, since this can cause the unit to malfunction.
- Avoid restricting the GP-37WL's naturally occurring ventilation, or storing or operating the GP-37WL in an environment that will cause it to become either too hot or too cold.
- Avoid storing or operating the GP-37WL in either direct sunlight or in excessively dusty or dirty environments.
- Because the GP-37WL is a precision instrument, do not store or use it in locations where excessive jolting or vibration can occur.
- Do not store or operate the GP-37WL where chemicals and acids are either stored or where high concentrations of fumes are present. The GP-37WL may either malfunction or be damaged as a result.
- Do not use paint thinner or organic solvents to clean the GP-37WL's case or display.
- Due to the danger of unforeseen accidents, be sure to back up all screen data regularly.

Notes on the GP-37WL Display

- The type of display data shown on the GP-37WL's screen and the unit's current contrast level may affect the intensity of Contouring. (i.e. when certain parts of the screen are brighter than others, creating a wave-like pattern)
- The small grid-points on the Display Panel surface are the panel's normal design and are not a defect.
- Shadows may appear at the top of the LCD's border.
- A color will look different when viewed from an angle outside the screen's specified view angle. This is also normal.
- Displaying a single image for long periods can cause an afterimage to remain after changing to another screen.
- To prevent these afterimages, follow the instructions below:



- When the same screen will be displayed for a long period of time, use the display OFF function (for further information about this function, refer to *Chapter 5, "INITIALIZE"*).
- Do not display any single screen for a long period of time. Change the screen display periodically.

UL/c-UL (CSA) Application Notes

GP-37WL panels are UL 1950 recognized products (UL file No. E177793). Please pay special attention to the following instructions when applying for UL approval for machinery which includes the GP-37WL. For any machine that incorporates the GP-37WL, the compatibility of the combination of the machine and the GP-37WL must be UL approved.

■ **The GP-37WL conforms as a component to the following standards:**

UL 1950, Third Edition, dated July 26, 1995

(Standard for Safety of Information Technology Equipment, including Electrical Business Equipment)

CSA-C22.2 No. 950-M93

(Standard for Safety of Information Technology Equipment, including Electrical Business Equipment)

GP37W-LG11-24V (UL Registration Model: 0880042-01)

- If the GP-37WL is mounted so as to cool itself naturally, please install it in a vertical panel. Also, be sure that the GP-37WL is mounted at least 100mm away from any adjacent structures or equipment. If these conditions are not met, the heat generated by the GP-37WL's internal components may cause it to fail to meet UL standard requirements.

Table of Contents

Preface

Preface	1
Safe Product Usage	2
Essential Safety Precautions	3
General Safety Precautions	4
UL/c-UL (CSA) Application Notes	6
Table of Contents	7
Package Contents	10
Symbols	11

Chapter 1 Introduction

1-1 Prior to Operating the GP-37WL	1-1
1-2 System Design	1-2
1-3 Optional Equipment	1-4

Chapter 2 Specifications

2-1 General Specifications	2-1
2-1-1 Electrical Specifications	2-1
2-1-2 Environmental Specifications	2-1
2-1-3 Dimensions	2-2
2-2 Functional Specifications	2-3
2-2-1 Display Features	2-3
2-2-2 Screen Memory	2-3
2-2-3 Touch Panel	2-3
2-2-4 External Interface	2-4
2-3 Interface Specifications	2-5
2-3-1 Serial Interface	2-5
2-4 Names and Functions of GP Parts	2-7
2-5 GP Dimensions	2-8
2-5-1 GP-37WL External Dimensions	2-8
2-5-2 GP-37WL Installation Fasteners	2-9
2-5-3 GP-37WL Installation Dimensions	2-10

Chapter 3 Installation and Wiring

3-1	GP Installation	3-1
3-1-1	Installation	3-1
3-2	Wiring	3-5
3-2-1	Connecting the GP-37WL's Power Cable	3-5
3-2-2	Precautions: Grounding	3-6
3-2-3	Precautions: Input/Output Signal Lines	3-7
3-3	Tool Connector	3-7

Chapter 4 OFFLINE Mode

4-1	Using OFFLINE Mode	4-1
4-1-1	Entering OFFLINE Mode - After Start-Up	4-1
4-1-2	Entering OFFLINE Mode - From Forced Reset Screen	4-2
4-2	Main Menu Screen	4-3
4-3	INITIALIZE Functions	4-4
4-4	SLEF-DIAGNOSIS Functions	4-6
4-5	Transferring Screen Data	4-8

Chapter 5 INITIALIZE

5-1	INITIALIZE Screen	5-1
5-2	INITIALIZE Menu Items	5-2
5-3	SYSTEM ENVIRONMENT	5-3
5-3-1	SYSTEM SET UP	5-3
5-3-2	SYSTEM AREA SET UP	5-4
5-3-2	GLOBAL WINDOW SETUP	5-6
5-3-3	CHARACTER STRING DATA SETUP	5-7
5-4	SET UP I/O	5-10
5-4-1	SET UP SIO	5-10
5-4-2	SET UP I/O	5-11
5-4-3	COMMUNICATION SETUP	5-13
5-5	PLC SETUP	5-15
5-5-1	SET UP OPERATION SURROUNDINGS (1:1)	5-15
5-5-2	SET UP OPERATION SURROUNDINGS (n:1)	5-16
5-5-3	STATION SETUP (n:1)	5-17
5-5-4	CUSTOMIZE SETUP	5-20
5-6	INITIALIZE MEMORY	5-22
5-7	SET UP TIME	5-23
5-8	SET UP SCREEN	5-24
5-9	FONT SETTING	5-25

Chapter 6 RUN and Errors

6-1	GP RUN Mode	6-1
6-1-1	After Powering Up	6-1
6-1-2	OFFLINE Mode	6-2
6-2	Troubleshooting	6-3
6-2-1	GP Problems	6-3
6-2-2	No Display	6-4
6-2-3	Can Not Communicate With Host (PLC)	6-7
6-2-4	Touch Panel Does Not Work	6-9
6-3	SELF-DIAGNOSIS	6-10
6-3-1	SELF-DIAGNOSIS Features	6-10
6-3-2	SELF-DIAGNOSIS - Detailed Explanation	6-11
6-4	Error Messages	6-13
6-4-1	Error Message List	6-13
6-4-2	Error Message - Details	6-14

Chapter 7 Maintenance

7-1	Regular Cleaning	7-1
7-2	Periodic Check-Up	7-2
7-3	Maintenance	7-2

Index

Package Contents

The GP-37WL's packing box contains the items listed below. Please confirm that everything illustrated here has been included.

■ **GP-37WL Unit**
GP37W-LG11-24V

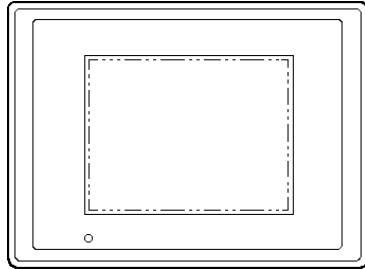

■ **GP-37WL**

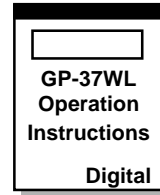

■ **Mounting Fasteners (4/set)**

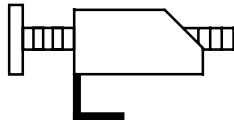

This unit has been carefully packed, however, should you find anything damaged or missing, please contact your local GP-37WL distributor immediately for service.

* This unit's User's Manual is sold separately (GP-37WL User's Manual).

Symbols

The list below describes the symbols and abbreviations used in this manual.



Indicates a potentially hazardous situation which could result in serious injury or even death, if the instructions are not followed.



Indicates a potentially hazardous situation which could result in minor injury or equipment damage if the instructions are not followed.



Explains a situation that requires a moderate amount of user caution.

GP-37WL
Screen Editor

Refers to the “GP-PRO/PBIII for Windows95” software.

PLC

Programmable Logic Controller

*1

Indicates supplemental explanatory information is located nearby, usually at the bottom of the page.



Indicates additional, relevant information.



Reference pages of related sections and topics.

n:1

n:1 (multi-link) connection setup.

The Tag Reference, PLC Connection Manuals referred to here are those included in the GP-PRO/PBIII for Windows95 software package.

MEMO

This page intentionally left blank.

Chapter 1

Introduction

1-1 Prior to Operating the GP-37WL

1-2 System Design

1-3 Optional Equipment

1-1 Prior to Operating the GP-37WL

Prior to operating the GP, be sure to perform the following steps.

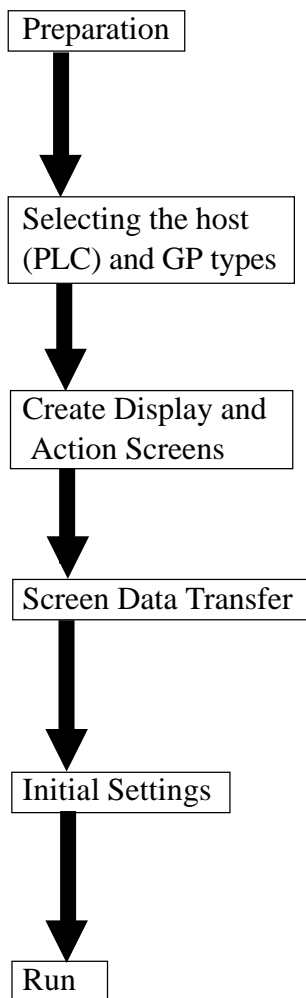

Prepare the hardware and check the specifications, wirings, and installation method to operate the GP unit.

 Refer to *Chapter 2, “Specifications”*, and *Chapter 3, “Installation and Wiring”*

When first creating your project with the GP-PRO/PB III for Windows 95 software, select the Host (PLC) and GP type that you will be using.

 Refer to *Operation Manual*

Start up the GP-PRO/PBIII software and lay out objects on the screens as you intend to use them.

 Refer to *Operation Manual* and *Tag Reference Manual*

Use the GP-PRO/PB III for Windows 95 software to transfer screen data from your PC to the GP unit using the Data Transfer cable.

 Refer to *Operation Manual*

Set up the GP’s initial settings so that they agree with the Host (PLC)’s data transfer specifications.

 Refer to *Chapter 5, “INITIALIZE”*, and *PLC Connection Manual*

Link your GP with the Host (PLC) using the designated Connection cable (different cables may be necessary for different host devices), and then run the GP.

1-2 System Design

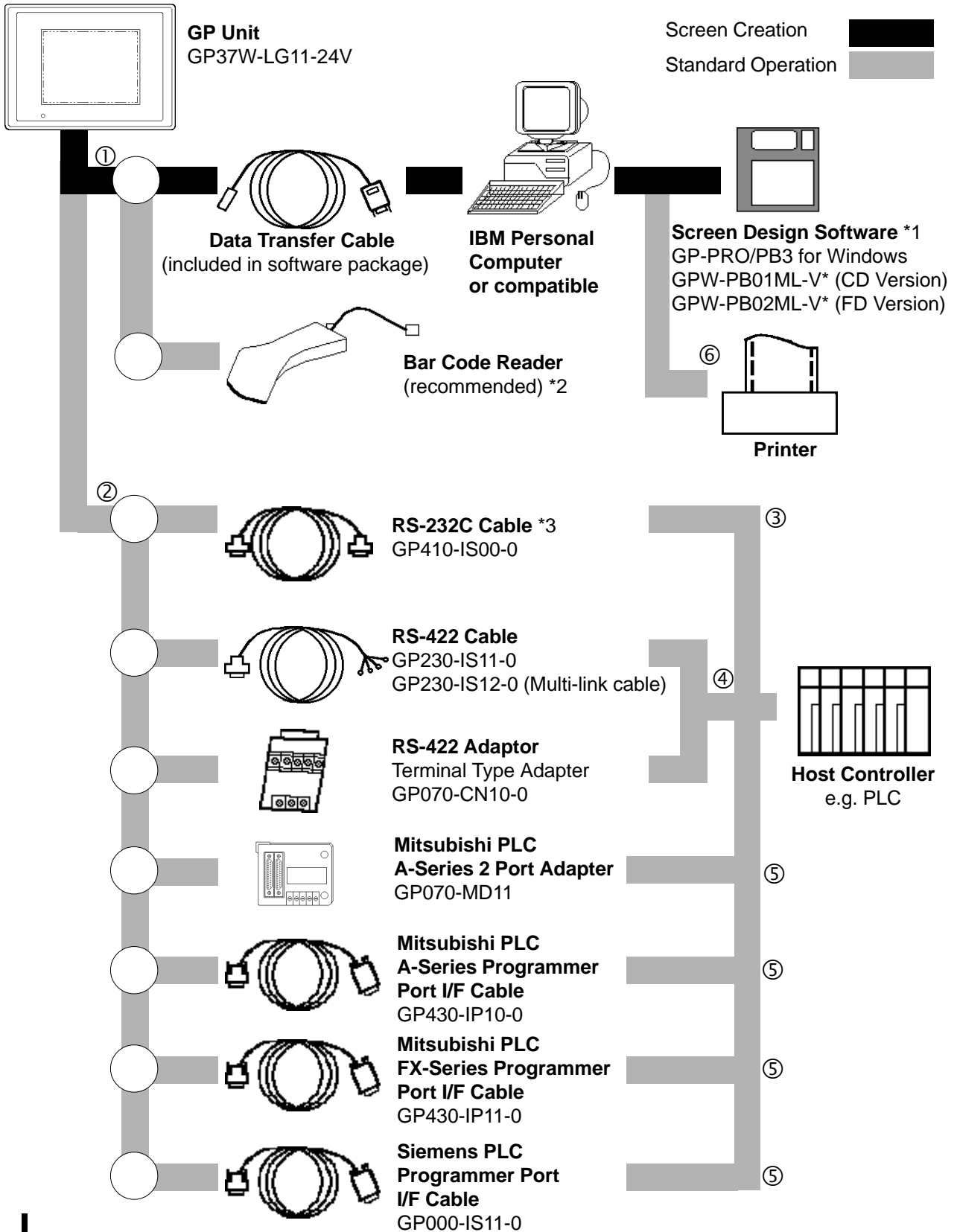

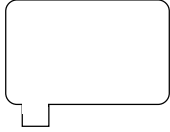

Introduction

Optional Items

	<p>Screen Protection Cover Sheet GP37W-COVER-20P</p>
---	--

All optional items are sold separately.

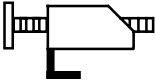
Maintenance Parts (Optional)

	<p>GP-37WL Installation Fasteners GP070-AT00-MS</p>
	<p>Moisture Resistant Gasket GP37W-WP00-MS</p>

These items are part of the GP unit's original equipment. They can also be purchased separately, if needed.

GP Interface

- ① Tool Connector
- ② Serial Interface

PLC Interface

- ③ RS-232C Port
- ④ RS-422 Port
- ⑤ Programmer Port

PC Interface

- ⑥ Printer Interface

*1 For more information about the contents of this system data disk, please feel free to contact your local GP distributor.

*2 Recommended Units:

Aimex Corporation	OPT Electronics		
BR-331 PC2 (Pen type)	Reading Width	Touch Scanner Type	Keyboard Connection Type
	60mm	OPT-1125-WL 98	OPT-1125-WD 98
	80mm	OPT-5125-WL 98	OPT-5125-WD 98
	100mm	LT-2125-WL 98	LT-2125-WD 98

*3 Depending on the PLC model used, some types of connections are not possible.



Refer to **PLC Connection Manual**

1-3 Optional Equipment

All optional items listed below are Digital Electronics Corporation products.

	ITEM	DESCRIPTION
Screen Creation/Editing Software	GP-PRO/PB III for Windows95 (GPW-PB01ML-V*<CD-ROM>) (GPW-PB02ML-V*<Floppy disk>)	GP-PRO/PB III PC based screen design software for GP display screens. GP-37WL system disk is required. Use the included FAX form to ask for the system disk.
	Data Transfer Cable Set (GPW-CB-SET)	Data Transfer Cable Connects your PC to the GP, allowing screen data to be transferred between the two.
Serial Interface	RS-232C Cable (GP410-IS00-O)*1	I/F cable to connect GP to the Host (PLC).
	RS-422 Cable (GP230-IS11-O)	
	Multi-link Cable (GP230-IS12-O)	Allows multi-link (n:1) SIO between the Host (PLC) and GP. RS-422 interface cable.
	RS-422 Terminal Type Adapter (GP070-CN10-O)	Adapter for converting output from a serial interface to RS-422.
	Siemens Simatic Series Programming Port I/F Connection Cable (GP000-IS11-O)	TTY converter cable for Siemens Simatic S5 Series PLCs. Simultaneous use of program console is not possible.
	Mitsubishi A Series Programming Port I/F cable (GP430-IP10-O)	Connects directly to Mitsubishi's FX Series I/F Programming Console. Conversion link unit not necessary. Simultaneous use of program console, however, is not possible.
	Mitsubishi PLC FX Series Programming Port I/F Cable (GP430-IP11-O)	
Mitsubishi PLC A Series 2 Port Adapter (GP070-MD11)	Interface unit that allows use of both GP and Mitsubishi A series equipment in the same location.	
Optional Part	Cover Sheet GP-37WL (GP37W-COVER-20P)	Disposable sheets provide protection from a variety of elements. The GP's touch panel can be used with this cover sheet attached. (20 sheets/set)
Maintenance Parts	Installation Fasteners (GP070-AT00-MS)	Metal installation fasteners for GP-37WL.
	Moisture Resistant Gasket GP-37WL (GP37W-WP00-MS)	Used when installing the GP to provide a moisture resistant seal. Same as in the GP's original equipment package.

*1 Depending on PLC model used, some types of connections are not possible.



Refer to **PLC Connection Manual**

2

2-1 General Specifications

2-2 Functional Specifications

2-3 Interface Specifications

2-4 Names and Functions of
GP Parts

2-5 GP Dimensions

Specifications

This chapter provides the specifications for the GP37WL's general features, performance, and interface equipment. It also describes the names and dimensions of this unit's parts.

2-1 General Specifications

1 Electrical Specifications

Operating Voltage	24VDC±15%
Power Consumption	Under 20W (TYP 10W)
Allowable Pause Duration	2ms or less
Voltage Endurance	1000VAC 10 mA 1 minute (between the live wire and grounding terminals)
Isolation Resistance	Above 20M Ohm at 500VDC (between the live wire and grounding terminals)

2 Environmental Specifications

Operating Temperature	0 to 50 degrees Celsius
Storage Temperature	-20 to 60 degrees Celsius
Ambient Humidity	20 to 85%RH (no condensation)
Vibration Endurance	10 to 25 Hz (X,Y,Z directions 30 minutes 2G)
Noise Endurance	Noise Voltage: 1000 Vp-p
	Pulse length: 1 microsecond
	Arise time (rise/fall): 1 nanosecond
Atmosphere	Free of corrosive gas
Grounding	Class 3
Protective Structure*1	Equivalent to IP64

*1 See the following page.

*1 The front face of the GP unit, installed in a solid panel, has been tested using conditions equivalent to the standard shown in the specification. Even though the GP unit's level of resistance is equivalent to the standard, oils that should have no effect on the GP can possibly harm the unit. This can occur in areas where either vaporized oils are present, or where low viscosity cutting oils are allowed to adhere to the unit for long periods of time. If the GP's front face protection sheet becomes peeled off, these conditions can lead to the ingress of oil into the GP and separate protection measures are suggested. Also, if non-approved oils are present, it may cause deformation or corrosion of the front panel's plastic cover. Therefore, prior to installing the GP be sure to confirm the type of conditions that will be present in the GP's operating environment. If the installation gasket is used for a long period of time, or if the unit and its gasket are removed from the panel, the original level of the protection cannot be guaranteed. To maintain the original protection level, you need to replace the installation gasket regularly.

3 Dimensions

External Dimensions	210W x 160H x 63D (mm) (GP unit only)
Weight	Under 1100g (GP unit only)
Cooling Method	Natural air circulation

2-2 Functional Specifications

1 Display Features

Display Type	Monochrome LCD
Display Colors	White, Black
Backlight	CFL (at normal temperatures and humidity, lifespan of 25,000 hours)
Resolution	320 x 240 pixels
Display Area	115.2W x 86.4H (mm)
Attributes	Blink/Reverse Video
Contrast Adjustment	8 levels available
Characters	Korean: (KSC5601-1992 codes) Hangeul fonts (including Kanji) Chinese: (GB2321-80 codes) simplified Chinese fonts Taiwanese (Big 5 codes) traditional Chinese fonts ASCII: (Code Page850) Alphanumeric (including European fonts) Japanese: ANK 158 type, Kanji:6349 (includes non-kanji:453, and Standard JIS Type 1 and 2)
Char. Disp. #	8 x 8 dot font: 40 Char. per row, 30 rows 8 x 16 dot font: 40 Char. per row, 15 rows 16 x 16 dot font: 20 Char. per row, 15 rows 32 x 32 dot or larger font: class 1 level
Character Size	1, 2, 4, or 8-times size (both height and width) (Double size and larger characters can be displayed in high-quality fonts)

2 Screen Memory

Internal Memory	FLASH EPROM 256 Kbytes (holds up to 80 screens, assuming a standard screen size of 3.2 Kbytes)
------------------------	---

3 Touch Panel

Touch Panel	16 x 12 "squares" per screen; either single or double-touch activation can be selected.
--------------------	---

4 External Interface

Serial Interface	Asynchronous Transmission Method: RS-232C/RS-422 Data Length: 7 or 8 bits Stop Bit: 1 or 2 bits Parity: None, Odd or Even Data Transmission Rate: 2400 to 38400 bps
Tool Connector	Asynchronous Transmission TTL level non-procedural command interface (During Development) use this I/F to download screen data files (During RUN mode) use this I/F for the BarCode Reader

2-3 Interface Specifications

1 Serial Interface

The RS-232C or RS-422 (serial) ports are used for connecting to the Host (PLC).



When connecting this unit to a PLC, refer to *PLC Connection Manual* for specification data.

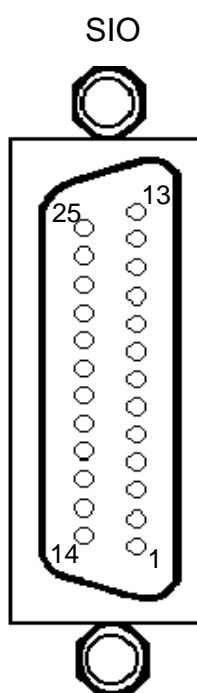

Pin #	Signal Name	Condition	Pin #	Signal Name	Condition
1	FG	Frame Ground	14	VCC	5V Output 0.25A
2	SD	Send Data (RS-232C)	15	SDB	Send Data B (RS-422)
3	RD	Receive Data (RS-232C)	16	RDB	Receive Data B (RS-422)
4	RS	Request to Send (RS-232C)	17	NC	No Connection
5	CS	Clear to Send (RS-232C)	18	CSB	Clear to Send B (RS-422)
6	NC	No Connection	19	ERB	Enable Receive B (RS-422)
7	SG	Signal Ground	20	ER	Enable Receive (RS-232C)
8	CD	Carrier Detect (RS-232C)	21	CSA	Clear to Send A (RS-422)
9	TRMX	Termination (RS-422)	22	ERA	Enable Receive A (RS-422)
10	RDA	Receive Data A (RS-422)	23	BUZZ GND	External Buzzer Ground
11	SDA	Send Data A (RS-422)	24	NC	No Connection
12	NC	No Connection	25	BUZZ OUT	External Buzzer Output
13	NC	No Connection			

Recommended Connector: Dsub25pin plug XM2A-2501
<made by OMRON Corp.>

Recommended Cover : Dsub25pin Cover XM2S-2511
<made by OMRON Corp.>
Jack screw XM2Z-0071
<made by OMRON Corp.>

Recommended Cable : CO-MA-VV-SB5P X 28AWG
<made by HITACHI Cable Ltd.>

Refer to *PLC Connection Manual* to determine your PLC's connector pins.



Use regular M2.6 x 0.45p screws to fix the jack screws in place.

When creating your own cable, follow the instructions listed below concerning each connection type.

When using an RS-422 Cable

- The following pairs of pin #'s must be connected (shorted) to each other.
 - #18 (CSB) <---> #19 (ERB)
 - #21 (CSA) <---> #22 (ERA)
- When connecting an RS-422 cable and using the #9 (TRMX) and #10 (RDA) pins, a termination resistance of 100 ohms is created between the RDA and RDB pins.
- When making a cable for the Memory Link format, be sure to select a 4-line type.

When using an RS-232C Cable

Do not use the following pins:

9 (TRMX), 10 (RDA), 11 (SDA), 15 (SDB), 16 (RDB), 18 (CSB), 19 (ERB), 21 (CSA), 22 (ERA).

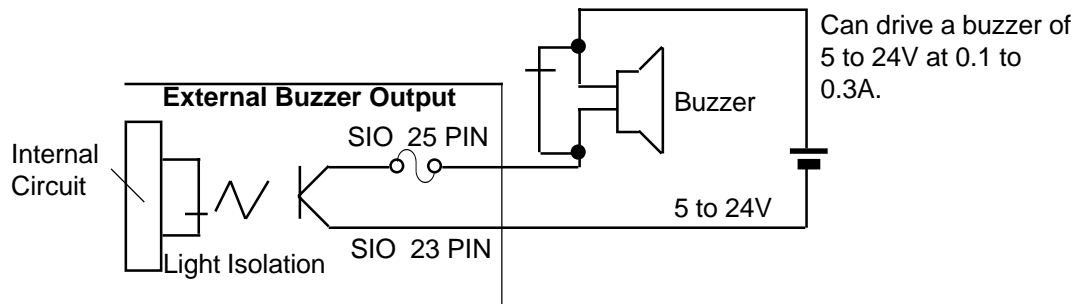

2-4 Names and Functions of GP Parts

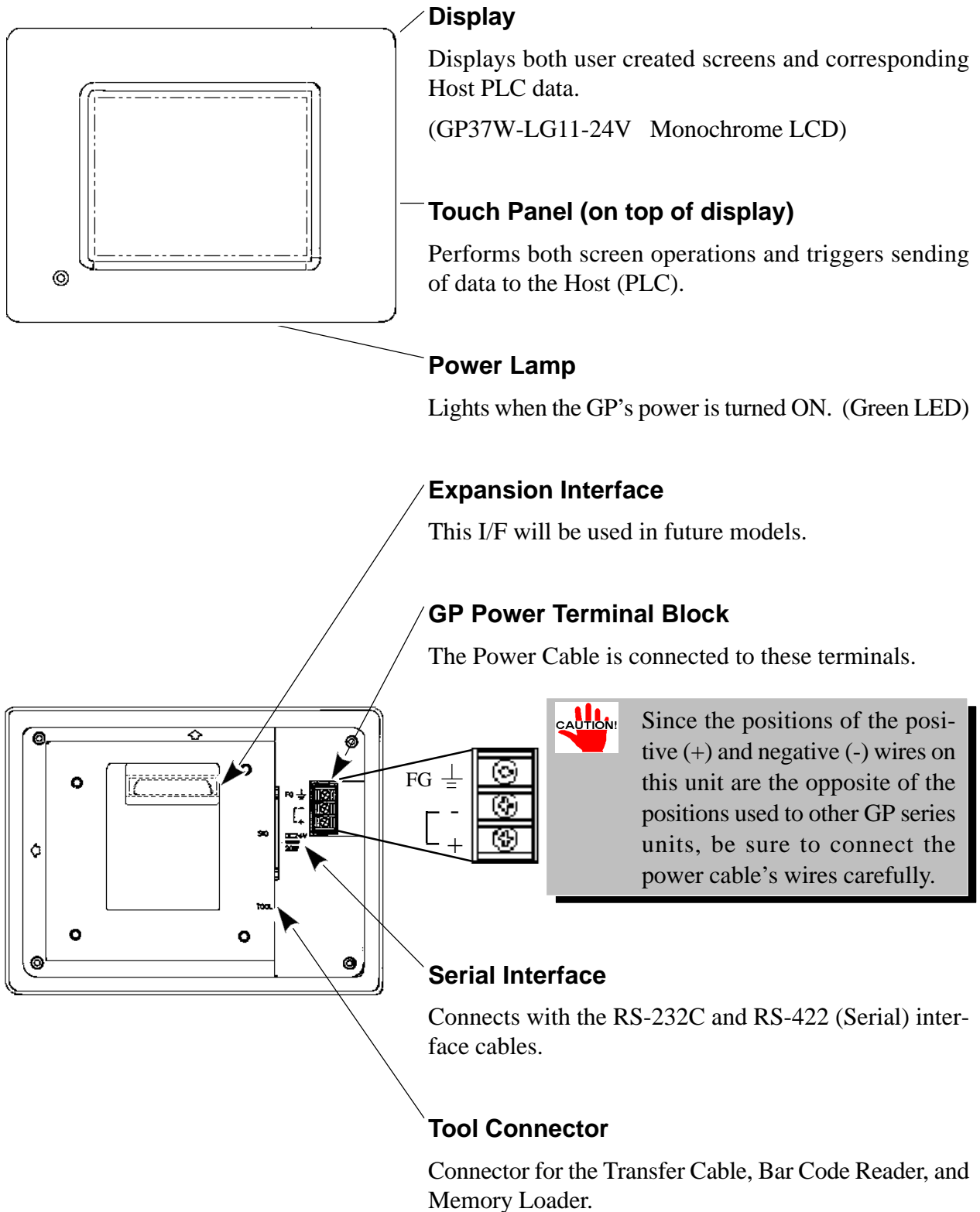

2-5 GP Dimensions

1 GP-37WL External Dimensions

Unit: mm

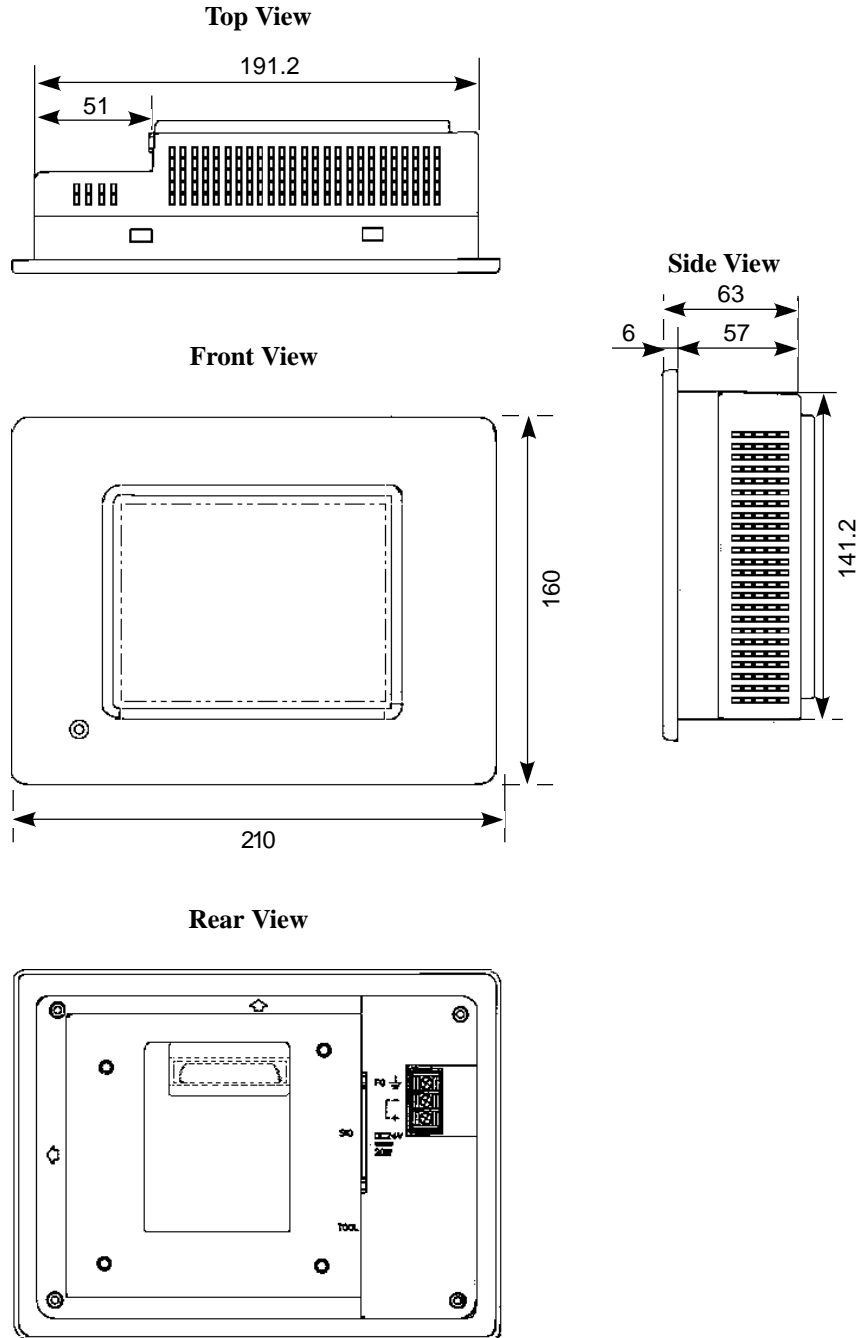

2 GP-37WL Installation Fasteners

Unit: mm

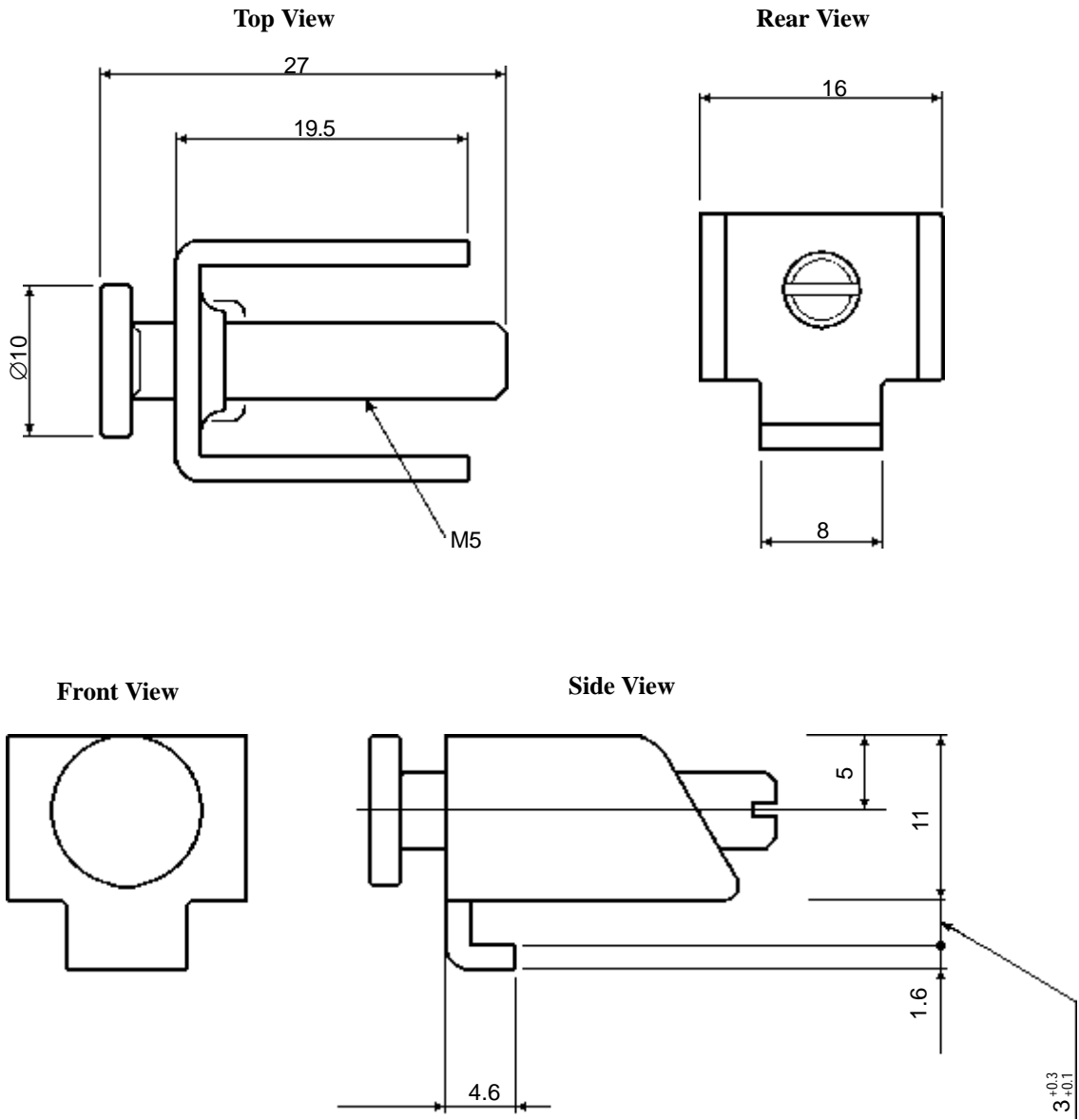

3 GP-37WL Installation Dimensions

Unit: mm

These are the mounting hole dimensions used when installing the GP into a panel or cabinet.

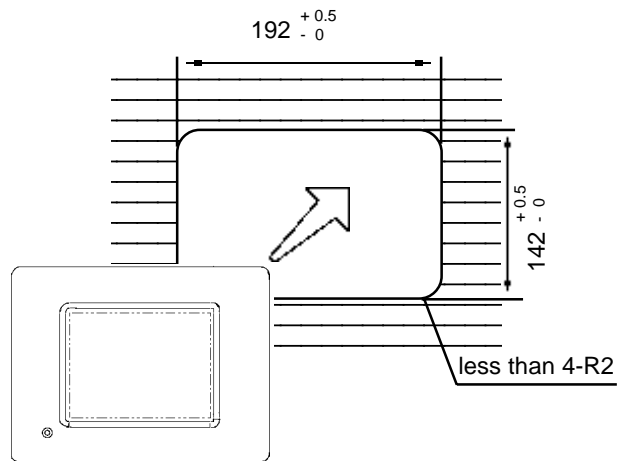

Installation and Wiring

3-1 GP Installation

This section describes both the procedures and precautions used with the GP-37WL's installation.

1 Installation

When installing the GP unit, follow the steps given below



Prior to installing the GP-37WL into a panel or enclosure, be sure the moisture resistant gasket (seal) is firmly in place.

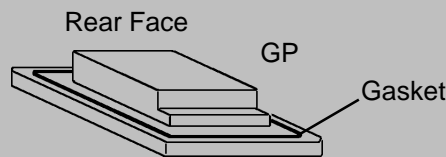

■ Create an Opening

Create the opening required for installing the GP, using the dimensions given here as your guide. Also, since the GP's moisture resistant packing, installation brackets, and attachment screws will all be required for installation, please confirm that each is available.



Refer to 2-5, “GP Dimensions”



- It is important that the surface of the panel/cabinet used is flat, clean and that all edges contacting the GP are smooth.
- The panel/cabinet surface thickness should be from 1.6 to 5.0 mm.

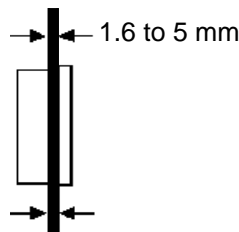



- For easier maintenance and operation, as well as improved natural ventilation, be sure the GP is mounted at least 100mm away from any adjacent structures or devices.

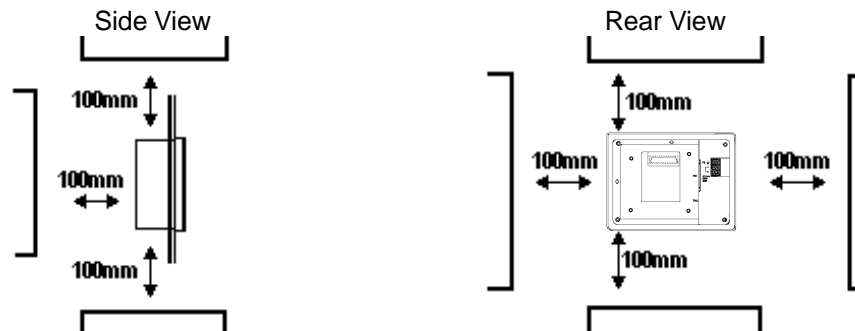

- The GP is cooled by naturally occurring ventilation through its outer shell. When installing the unit either horizontally or sideways, use either a forced air cooling system (i.e. a fan) or lower the surrounding temperature to avoid overheating.

Vertical Installation

Side View

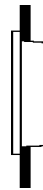

Screen Face

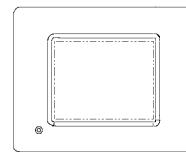

Horizontal Installation

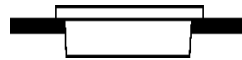

Sideways Installation

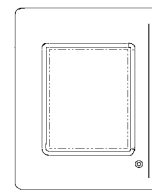
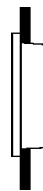

- When installing the GP sideways, be sure that the unit's Power Terminal Block points downwards.
- Be sure that heat from other, surrounding equipment does not cause the GP to overheat.
- Do not use GP-37WL in an environment that exceeds 50°C.
- Do not install this unit near any electromagnetic circuits, non-fuse type breakers, or equipment that can cause arcing.

Installation and Wiring

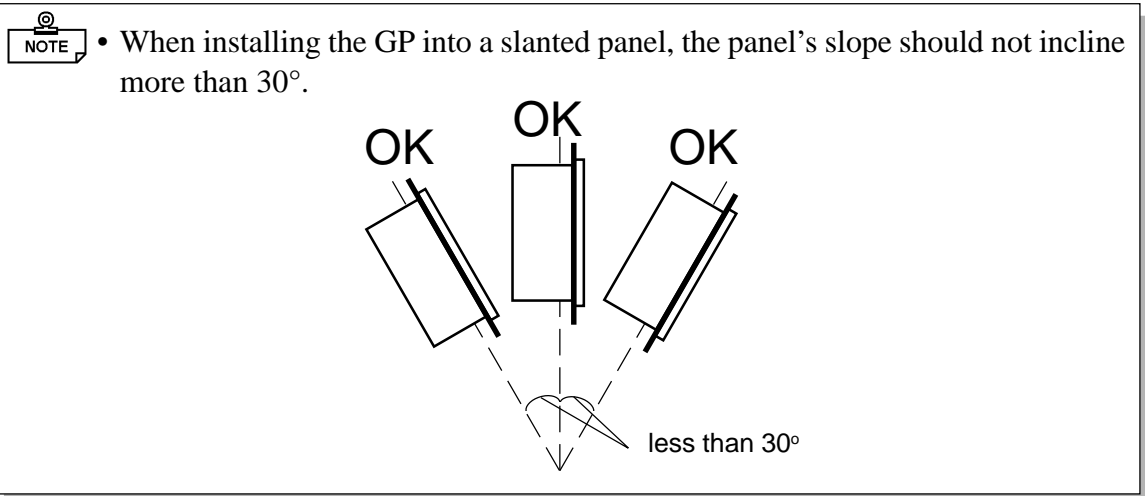

■ **Install the GP into the front face of the panel/cabinet, not from behind.**

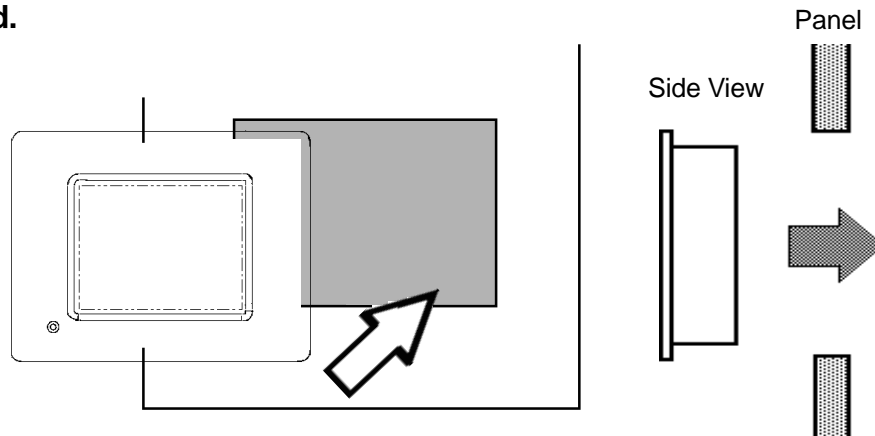

■ **Attach the Installation Fasteners from inside the panel/cabinet.**

- (1) Find the four (4) fasteners insertion slots, located on the top and bottom of the GP, where the metal installation brackets are inserted.

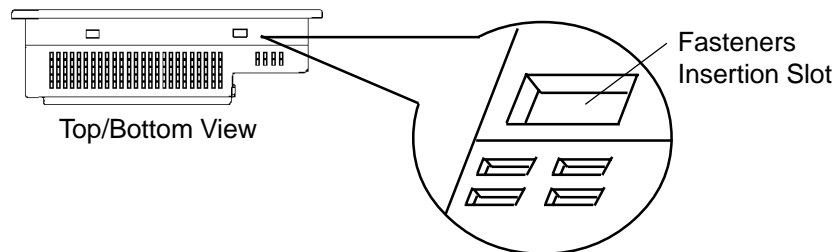

(2) Insert each fasteners into its insertion slot.

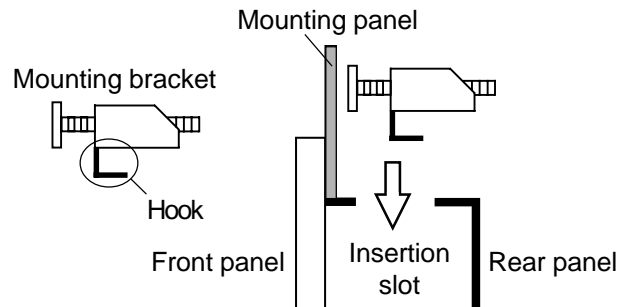

(3) After placing the fasteners into their insertion slots, pull them towards the rear of the GP.

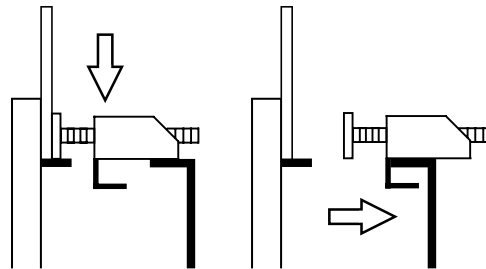

(4) Tighten the attachment screw(s) until each front plunger is pushed flush against the panel's face. Do not use a torque of more than 0.5 to 0.6N·m.

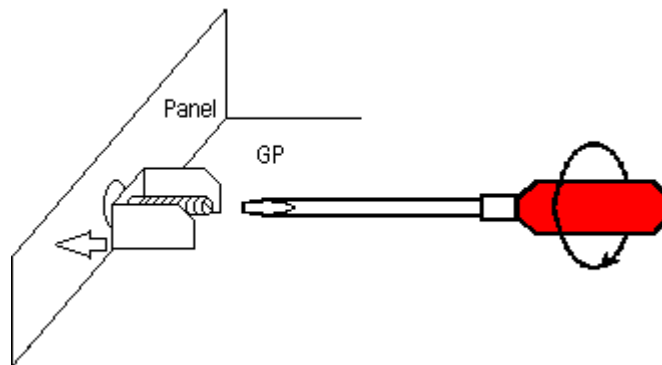

Using too much force may crack the case and damage the GP unit.

3-2 Wiring

1 Connecting the GP-37WL's Power Cable



WARNING

- **To avoid an electric shock, be sure the GP's power cable is unplugged from the power outlet before connecting the power cable's terminals to the GP.**
- The GP37W-LG11-24V can only use 24V DC power. If you use other than 24V DC power, you will damage the GP's power supply and the GP unit.
- There is no ON/OFF power switch on the GP unit, so please be sure to connect a breaker type switch.



When the FG terminal is connected, be sure the power cable is grounded. Not grounding the GP unit's power cable will result in excess noise.



- Wherever possible, use thick wires (max 2 mm) for power lines, and twist the wire by hand before connecting the ring terminal clips.
- Please use ring terminals the size shown here.

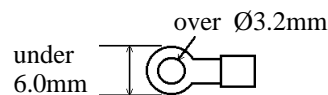

- To avoid the possibility of a short if one of the ring terminal screws become loose, please use ring terminals with a sleeve.

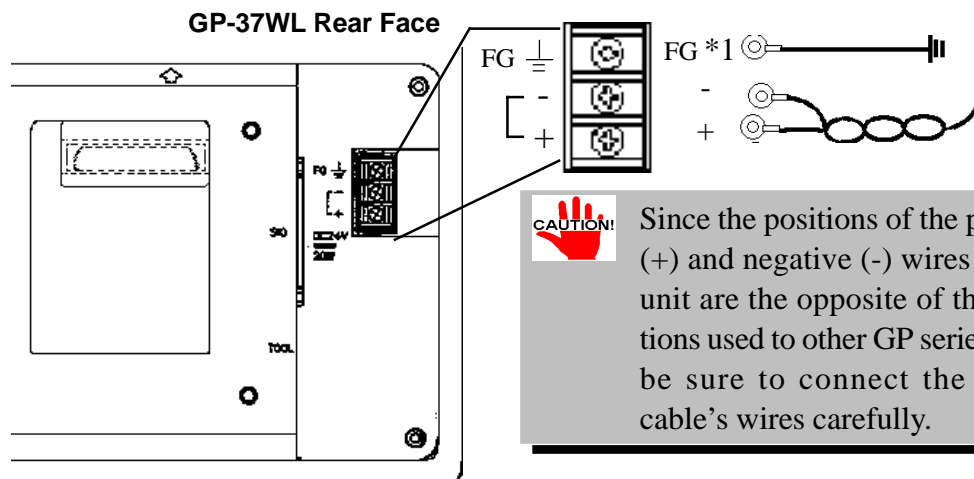

Since the positions of the positive (+) and negative (-) wires on this unit are the opposite of the positions used to other GP series units, be sure to connect the power cable's wires carefully.

*1 Ring Terminals: V2-S3 type (made by JST)

To connect the GP's power cable terminals:

- 1) First, confirm that the power cord is unplugged from the power supply.
- 2) Next, remove the Terminal Block's plastic cover.
- 3) Last, remove each terminal's attachment screw, attach the power wires in the correct order (refer to the previous diagram) and re-insert the screws to secure the ring terminals in place.

2 Precautions: Grounding

(a) Exclusive Grounding (BEST)^{*1}

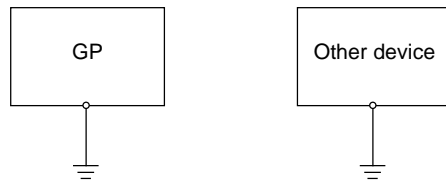

- Connect the unit's FG terminal to an exclusive ground.

(b) Common Grounding (OK)^{*1}

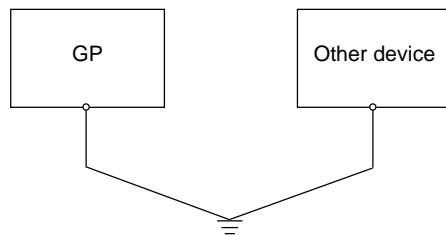

- If exclusive grounding is not possible, use a common connection point. [Diagram (b)]
- The grounding wire should be thicker than 2 mm. Locate the connection point as close to the GP unit, and make the wire as short, as possible. When using a long grounding wire, use a thicker wire and place it in a duct.
- If the GP does not function properly when grounded, disconnect the ground wire from the FG terminal.

(c) Common Grounding (BAD)

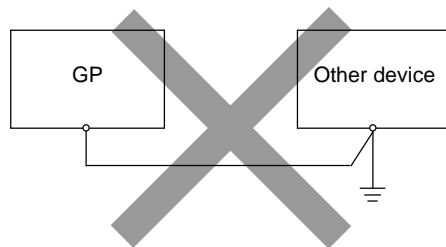

^{*1} Use a grounding resistance of less than 100Ω and 2 mm² or larger wire, or your country's applicable standard.

3 Precautions: Input/Output Signal Lines

- The GP's input and output signal lines must be wired separately from the power control lines used for machine operation circuits.
- If this is not possible, use a shielded cable and ground the shield terminal.

3-3 Tool Connector

The GP's Data Transfer Cable, Bar Code Reader, and Memory Loader unit connectors (plugs) are each connected to the Tool Connector's socket.

Side View

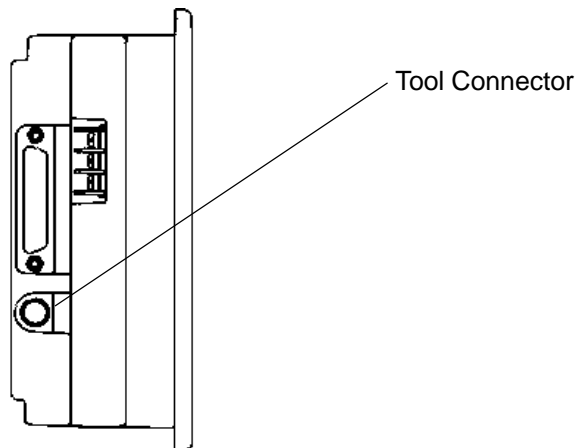

- When inserting or removing a connector from the Tool Connector socket, be sure the GP unit has been turned OFF (i.e. the power cord has been unplugged).
- When the Bar Code Reader will use a different power supply:
 - Turn the Bar Code Reader ON before turning the GP unit ON. (i.e. connecting the power cord)
 - Turn the GP unit OFF (disconnect the power cord) before turning the Bar Code Reader OFF.

MEMO

This page intentionally left blank.

4

4-1 Using OFFLINE Mode

4-2 Main Menu Screen

4-4 SELF-DIAGNOSIS Functions

4-3 INITIALIZE Functions

4-5 Transferring Screen Data

OFFLINE Mode

4-1 Using OFFLINE Mode

OFFLINE mode refers to the Initialize, Self-Diagnosis, and other setup information contained in the GP. You will need place the GP unit in OFFLINE mode before changing any settings or using any features.



OFFLINE mode is unavailable when using a completely new GP. The necessary screen and system data must first be transferred from the user's screen creation program.



Refer to 4-5, "Transferring Screen Data"

To INITIALIZE the GP's setup data or to run any of the SELF-DIAGNOSIS programs, the user must first enter OFFLINE mode. There are two ways to enter OFFLINE mode: first, after plugging the GP in, and second, from the Forced Reset screen.

1 Entering OFFLINE Mode - After Start-Up

Press the top left corner of the GP screen with your fingertip within 10 seconds of plugging in the power cord.

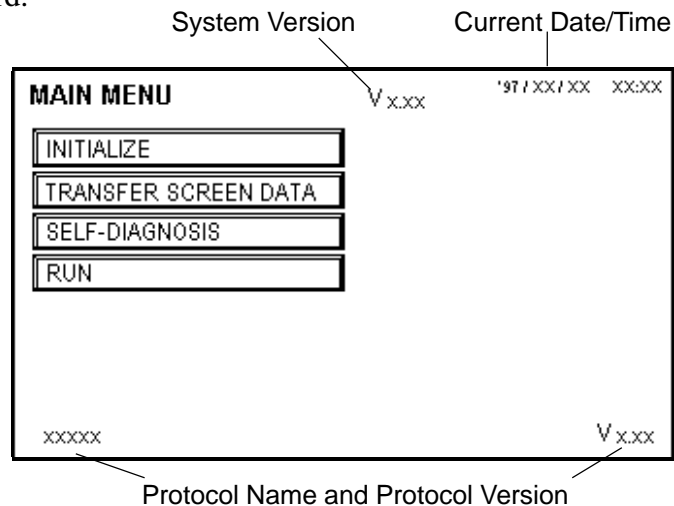
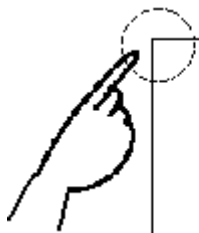

2 Entering OFFLINE Mode - From Forced Reset Screen

After calling up the Forced Reset screen, press the OFFLINE button.



For more information about the Forced Reset Screen, refer to 5-4, “*SET UP I/O*”.

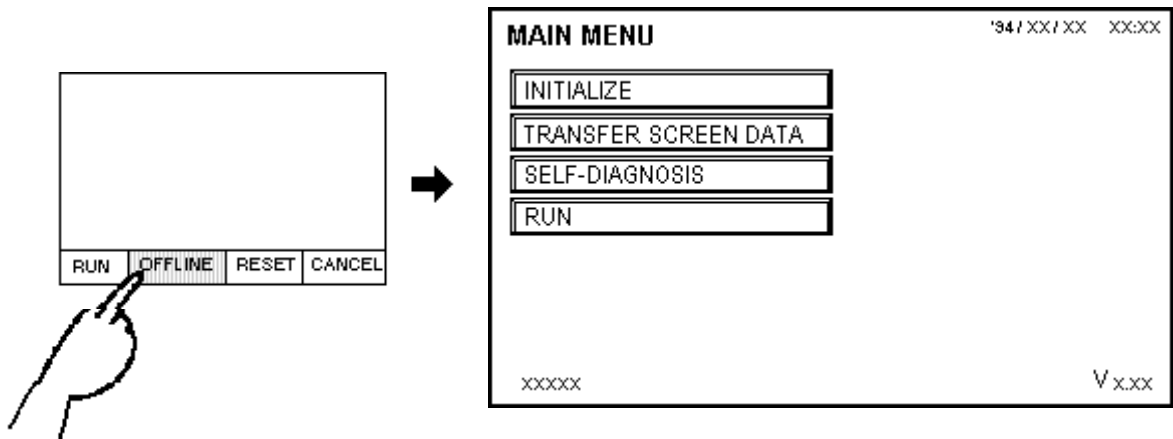

If a Password has been designated in the Initialize/Set Up System screen, the following password input screen will appear prior to entering OFFLINE mode.

Enter the password, and then press Set to enter OFFLINE mode.

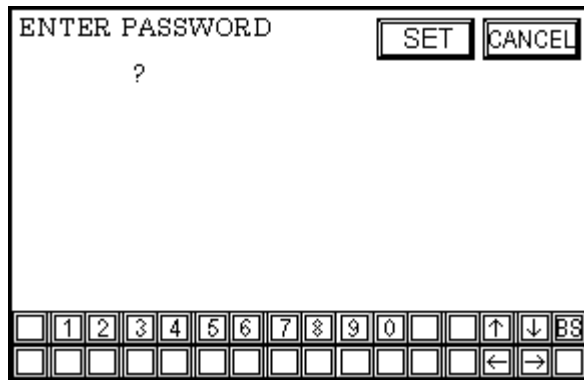

For more about entering the Password, refer to 5-3-1, “*SYSTEM SETUP*”.



For more information on password input, refer to 4-3, “*INITIALIZE Functions/ Inputting Numbers*”.

4-2 Main Menu Screen

Each menu item in this screen has its own unique setup data that must be set so as to agree with the designated PLC in order for the GP to communicate properly.

- In OFFLINE mode, the following four areas are displayed.
Select the desired menu item by pressing that item's selection box.

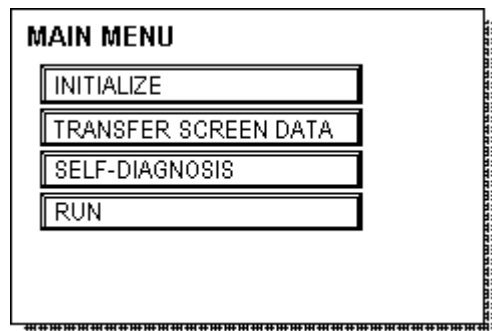

INITIALIZE

This area's data is used for the operation of the GP unit.

TRANSFER SCREEN DATA

This area's functions are used to either transfer screen data to, or receive data from the screen editing software in the user's PC.

SELF-DIAGNOSIS

These functions are used to diagnose GP System and Interface (I/F) problems.

RUN

Starts the GP unit's loaded program.



For more information about:

- INITIALIZE area, refer to *Chapter 5, "INITIALIZE"*.
- TRANSFERRING SCREEN DATA area, refer to *Operation Manual*.
- SELF-DIAGNOSIS and RUN areas, refer to *Chapter 6, "RUN and Errors"*.

4-3 INITIALIZE Functions

■ Menu Selection

Press INITIALIZE to call up the initialize area's sub-menu.

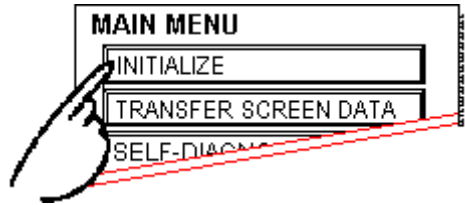

Press the desired sub-menu item.

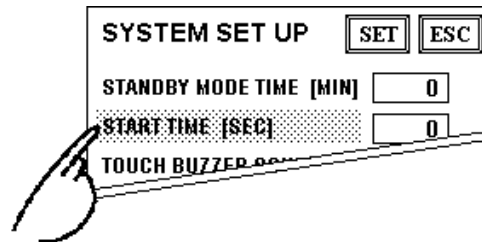

■ Inputting Numbers

After touching the desired sub-menu item, use the numeric keypad to enter the desired numeric values. Press the touch keys to enter a value, and then press the [SET] key to register it.

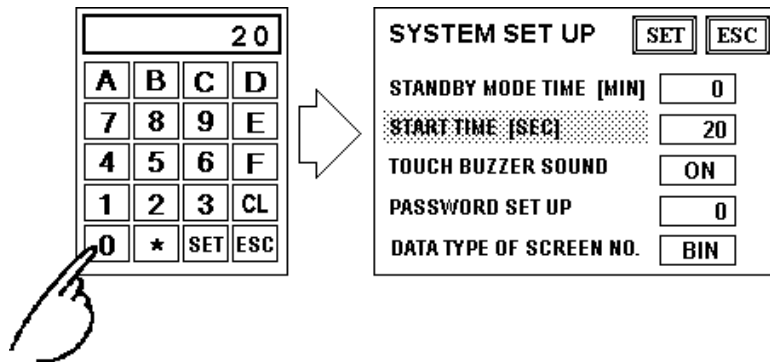

■ Selecting Setup Conditions

After selecting a menu item, touch the entry field that you would like to change. Touching the entry field will toggle between the available options.

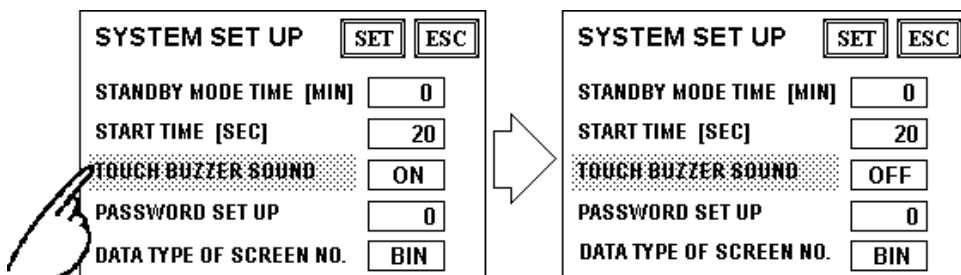

OFFLINE Mode

■ Ending Setup (Data Entry)

To end setup normally, press the top-left “SET” button.

If, however, you wish to exit the screen without registering any changes, press the ESC button.

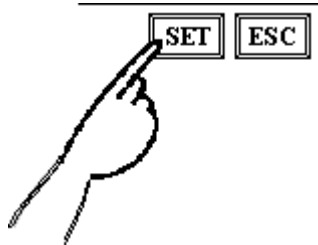

- Pressing the SET key writes the new Setup conditions into the GP’s internal FEPR0M. This operation may take some time to perform. Please do not touch the screen until the previous menu display reappears.
- Pressing the ESC key stops the writing of the SETUP conditions and returns to the previous menu.

■ Moving (Returning) to Other Screens

Press the tab (title bar) of the screen you would like to move to.

E.g. To return to the MAIN MENU from the SYSTEM ENVIRONMENT SETUP screen, simply press the MAIN MENU tab (title bar).

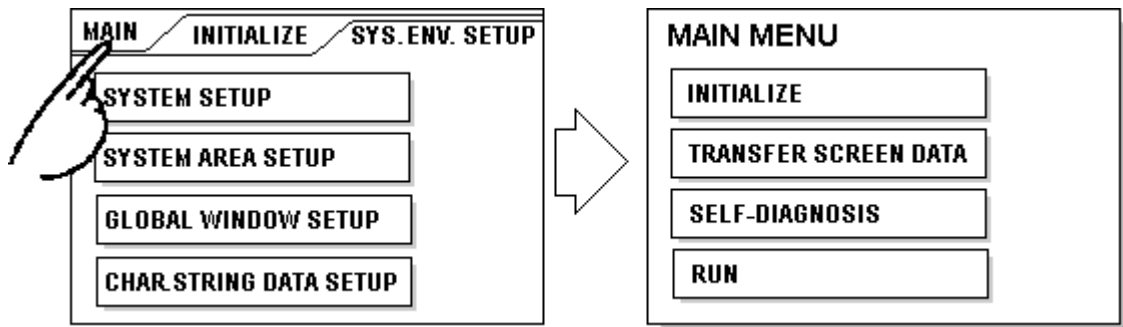

4-4 SELF-DIAGNOSIS Functions

This section describes the basic operations required to perform the GP's self-diagnosis function.

■ Selecting A Menu Item

Press the desired menu item.

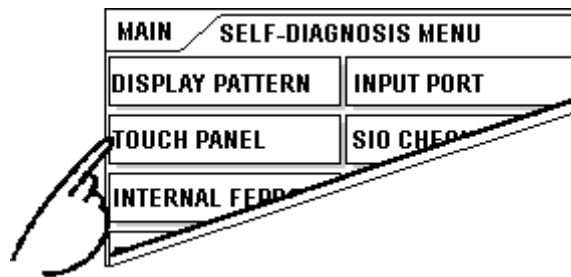

■ SET, ESC Keys

After selecting a SELF-DIAGNOSIS menu item, the SET and ESC keys will appear at different times at the top of the screen.

E.g.

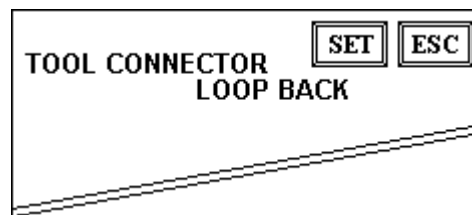

SET Key

Press this key to inform the GP-37WL that all of the steps required before starting the self-diagnosis function have been completed (as prompted by the messages displayed on the screen). Please be sure that all of these steps are completed before touching this key.

ESC Key

Pressing this key cancels the Self-Diagnosis program and returns the user to the Self-Diagnosis menu.

OFFLINE Mode

■ Diagnosis Completed - Check OK

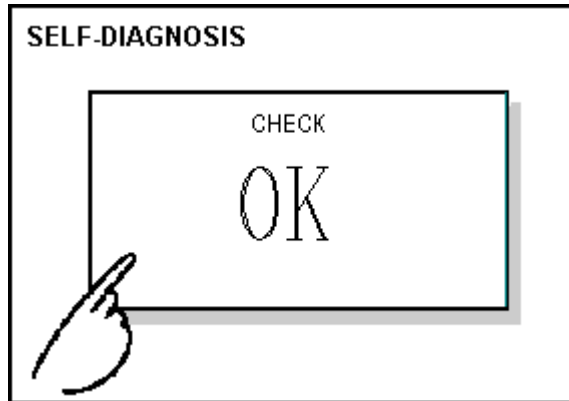

When the words “OK” appear, pressing once anywhere on the screen returns you to the previous Self-Diagnosis area menu.

■ Diagnosis Completed - Error

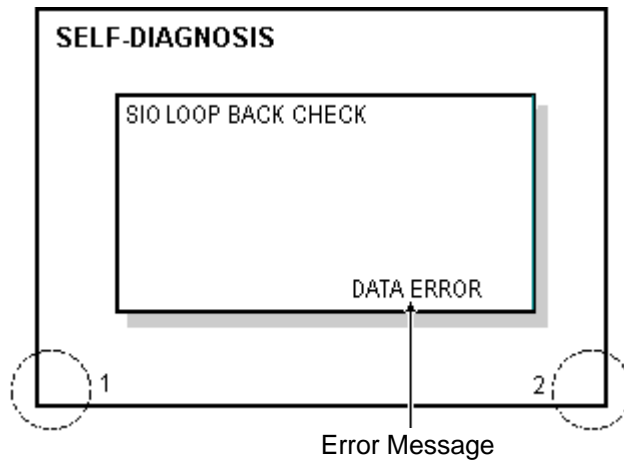

When an error message appears, press the bottom two corners of the panel (points 1 and 2) to return to the previous Self-Diagnosis menu.

■ Returning To The Main Menu

Press the MAIN tab in the SELF-DIAGNOSIS menu to return to the MAIN MENU screen.

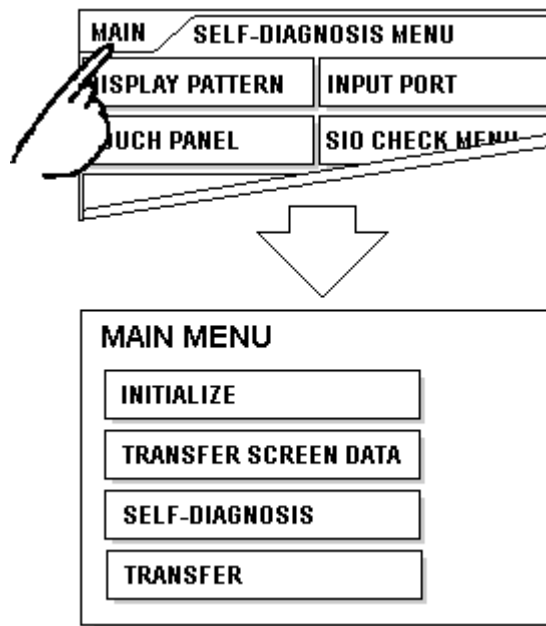

4-5 Transferring Screen Data

This section describes how to transfer screen data to the GP, or to receive data from the GP.

First, connect the GP's rear face tool connector to the data transfer cable's round connector. Then, connect the other end of the data transfer cable to your PC's RS-232C connector.

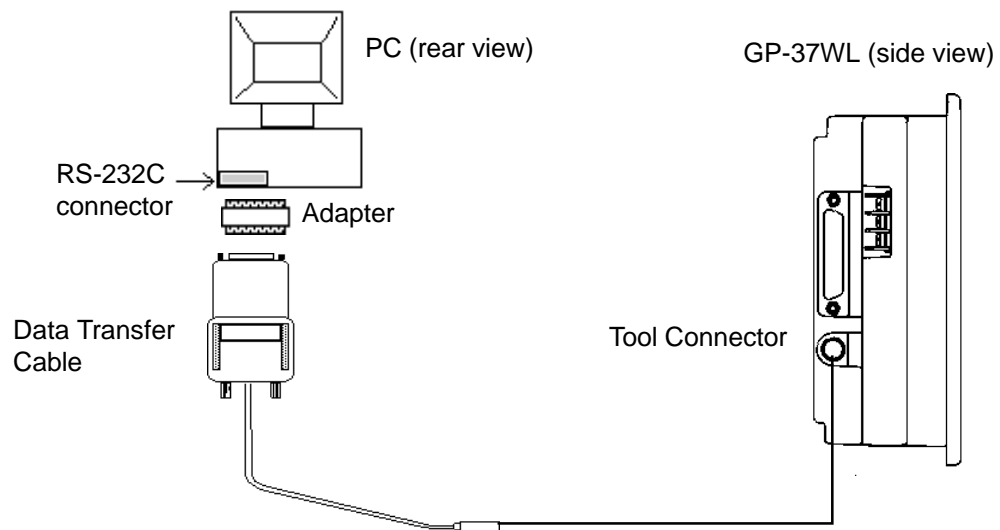

- Use an adapter to match the data transfer cable's connector with your PC's Serial Port connector.
- When using a serial mouse with your PC, be sure to use a different serial port for data transfer.

First, connect the GP's power cord and then select either the TRANSFER SCREEN DATA or RUN mode. If you are using your GP for the first time, you must first transfer system program data from the GP screen editing software to the GP in order for it to operate. After this data is transferred, the OFFLINE mode screen (INITIALIZE) will appear.



Refer to *Software Operation Manual 4.2 "Transmitting and Receiving Data"*

OFFLINE Mode

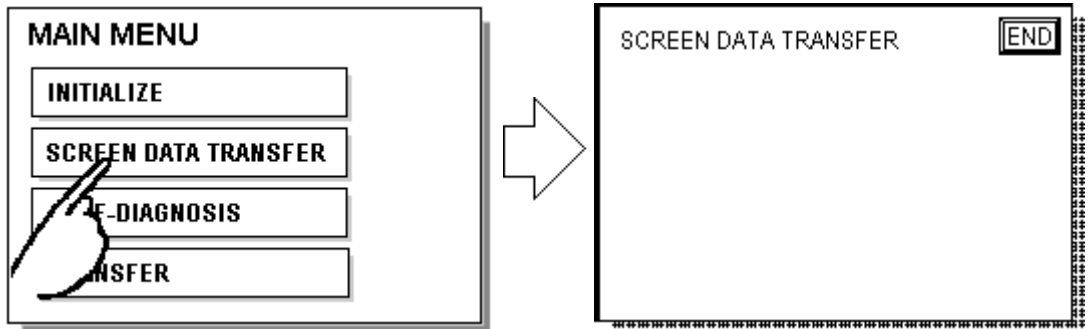

While data is being transferred, the messages “SETUP TRANSFER” and “Transferring Data, Please Wait” will appear. Once data transfer is completed, the GP main menu’s OFFLINE mode screen appears, if the GP has been previously set up (*1). If the GP has not yet been set up, the screen designated in the Initial Setup/Initial Screen File Number area will appear and the GP will enter RUN mode.

*1 “Setting Up” the GP means transferring system data to the GP so that it can be used in a specific environment, i.e. with a specific PLC. This is performed automatically during data downloading, when the required GP system program data and PLC protocol driver are sent from the GP screen editing software to the GP unit.

MEMO

This page intentionally left blank.

5-1 INITIALIZE Screen

For the GP to run correctly, various GP Setup data (items) must be verified. These items are listed on the MAIN MENU's INITIALIZE screen.

This chapter explains each of the OFFLINE mode's INITIALIZE menu items. However, there are two types of INITIALIZE data used, one for the **1:1** (direct) connection and the other for the **n:1** (multi-link) connection *1.

- 1:1** A single (1) GP is connected to a single (1) PLC. (direct connection)
- n:1** Multiple GP's are connected to a single (1) PLC. The GP's successively pass a token (exclusive PLC interaction key) among themselves to designate which can communicate with the PLC.

The "**n:1**" mark appears on menu items concerned only with the **n:1** multi-link connection. If no mark is used, the menu item is common to both **1:1** and **n:1** connections.



If a Project's System File (S0) is transferred to a GP, the GP will operate according to that data's specifications. Thus, if the necessary system file data has been correctly designated and transferred to the GP, INITIALIZE data entry becomes unnecessary.



For information concerning the data contained in the System File (S0), refer to *Operation Manual 1.1.3, "Screen Types"*

*1 PLC's that support the **n:1** (multi-link) connection are limited.



Refer to *PLC Connection Manual*

5-2 INITIALIZE Menu Items

Here, the screens displayed in each of the Initialize Menu items is shown.



For further information concerning OFFLINE mode screen operation and numeric input, refer to *Chapter 4, "OFFLINE Mode"*.

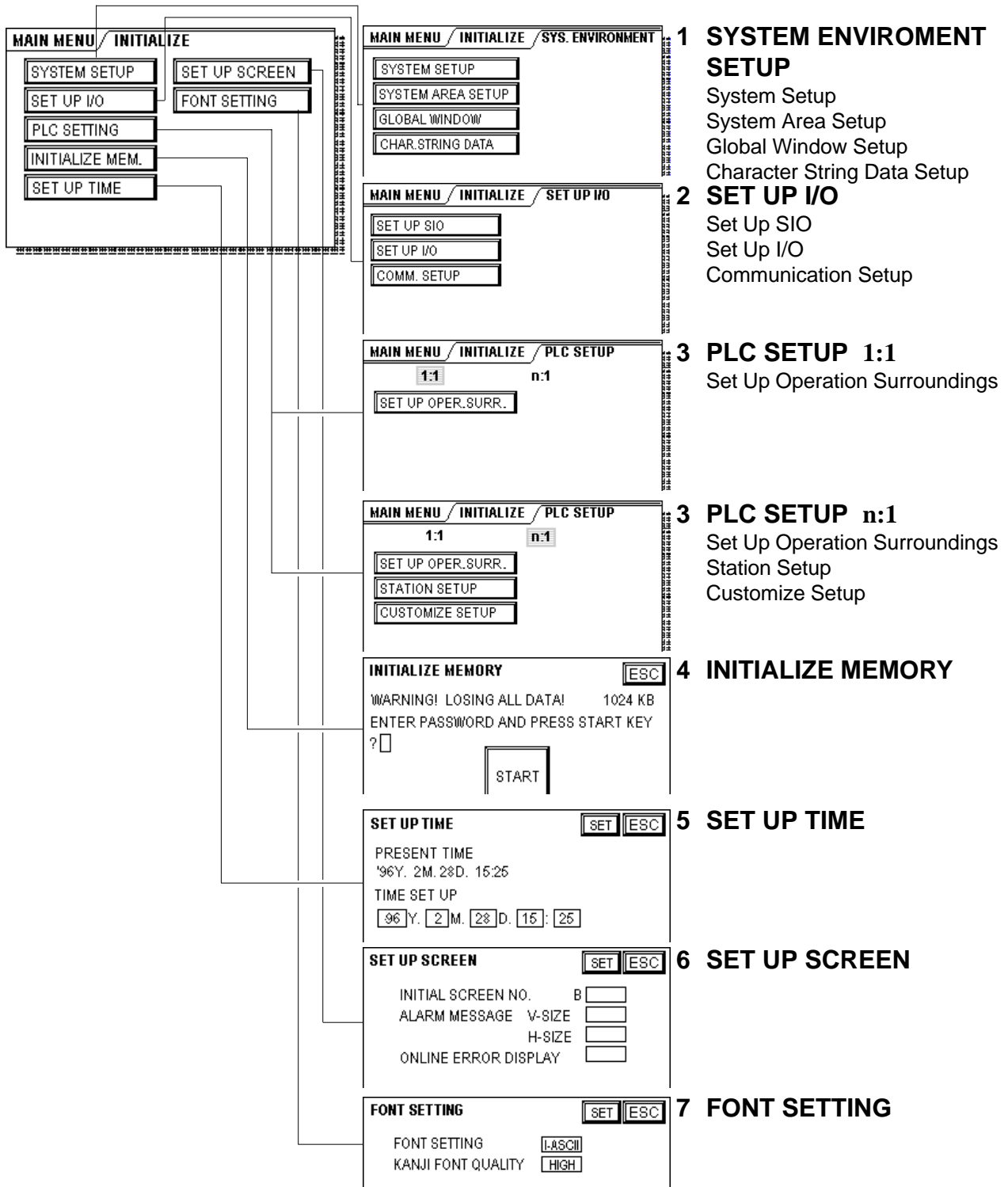

5-3 SYSTEM ENVIRONMENT SETUP

Here, the GP system settings can be changed. The SYSTEM ENVIRONMENT SETUP area includes the SYSTEM SET UP, SYSTEM AREA SET UP, GLOBAL WINDOW SETUP, and CHARACTER STRING DATA SETUP areas.

1 SYSTEM SET UP

SYSTEM SET UP		SET	ESC
STANDBY MODE TIME [MIN]		0	
START TIME [SEC]		20	
TOUCH BUZZER SOUND		ON	
PASSWORD SET UP		0	
DATA TYPE OF SCREEN NO.		BIN	

■ STANDBY MODE TIME (0-255)

To protect the GP's display, the GP has a screen saver function that automatically erases the screen when no GP operations have occurred for a certain period of time. A 0 entered in this field causes the current display to remain as it is indefinitely.

When the SYSTEM DATA AREA's  *PLC Connection Manual*) SCREEN DISPLAY ON/OFF *1 data is 0000h, and the following operations are not performed for the number of minutes designated by this setting, the GP will erase the display.

- Change Screen
- Touch Screen
- Alarm Display

■ START TIME (0-255)

This data determines the start-up time delay used by the GP. After the power cord is connected and the time value entered for this parameter elapses, the GP starts communicating with the Host (PLC). This parameter is usually used to control the power-up sequence, e.g., so that the GP starts up only after its power cable is connected and the host computer has started.

*1 When using either the Direct Access or the Memory Link formats, the object address becomes +9 or +12, respectively.

■ TOUCH BUZZER SOUND

Designates whether or not the GP beeps when the screen is pressed.

■ PASSWORD SET UP

The password entered here will be required when entering the INITIALIZE, and OFFLINE modes. This password (number) protects the GP’s current settings, since OFFLINE mode cannot be inadvertently entered. Use any number desired. If you do not wish to use this feature, enter the default value “0”.

■ DATA TYPE OF SCREEN NO.

This area controls whether BIN or BCD format numbers are used when making screen changes.

2 SYSTEM AREA SET UP

SYSTEM AREA SET UP data is necessary for the PLC to control the GP, and to prepare the PLC’s internal Data Memory (DM) and Data Registers (D). Use this area to prepare the desired SYSTEM DATA AREA items. If the memory link setting is used, this setting is not necessary.



Refer to *PLC Connection Manual*

SYSTEM AREA (WRITE)		NEXT	SET	ESC
CURRENT SCREEN NO. (1 WORD)	RESERVED (1 WORD)			
ERROR STATUS (1 WORD)				
CLOCK DATA CURRENT (4 WORDS)				
STATUS (1 WORD)				
AREA SIZE: WORD				
(Reverse mode items are selected.)				

Pressing



SYSTEM AREA (READ)		PREV	SET	ESC
CHANGE SCREEN NO. (1 WORD)	RESERVED (1 WORD)			
DISPLAY ON/OFF (1 WORD)	WINDOW CONTROL (1 WORD)			
CLOCK DATA SET (4 WORDS)	WINDOW REG. NO. (1 WORD)			
CONTROL (1 WORD)	WINDOW LOCATION (1 WORD)			
AREA SIZE: WORD				
(Reverse mode items are selected.)				

Press the NEXT and PREV buttons to toggle between the SYSTEM AREA (WRITE) and SYSTEM AREA (READ) screens.

When an item is highlighted, it is selected. Press it once to change to the other state or deselect it.

INITIALIZE

■ AREA SIZE display

This field displays the size, in “word” units, of the items selected in the SYSTEM AREA (all WRITE and READ items).

When you press the SET key, the System Area Contents screen appears so you can verify the selected items.



- The settings shown are enabled only when using the Direct Access format.
- All selected System Area items displayed on the screen become the System Data Area items.

When these five items, “Current Screen Number”, “Error Status”, “Clock Data (Current)”, “Change Screen Number”, and “Display ON/OFF”, have been selected, word addresses are assigned to each item, in order, as shown below.

SYSTEM AREA CONTENTS		SET	ESC
WORD		WORD	
+0	CURRENT SCR.NO.	+10	
+1	ERROR STATUS	+11	
+2	CLOCK (CURRENT)	+12	
+3	CLOCK (CURRENT)	+13	
+4	CLOCK (CURRENT)	+14	
+5	CLOCK (CURRENT)	+15	
+6	CHANGE SCR.NO.	+16	
+7	DISPLAY ON/OFF	+17	
+8		+18	
+9		+19	

The System Data Area allocation follows this formula [System Data Start Address + n]. For example, (referring to the System Area Contents screen displayed above) if the System Area Start Address was D00200, and the Change Screen Number option was selected, since the Change Screen Number’s address has been set to +6, its word address would be $D00200+6=D00206$.



For more information on the System Data Area, refer to *PLC Connection Manual 1.1.4, “System Area Content and Ranges”*.

3 GLOBAL WINDOW SETUP

The GP-37WL can display one Global Window and up to two Local Windows at any one time. A Global Window will be common to all the display screens. The Local Window(s) will display only on the current base screen. Here, the setting up of the GLOBAL WINDOW is described.

GLOBAL WINDOW SETUP		PREV	SET	ESC
GLOBAL WINDOW ACCESS			DIRECT	
DATA FORMAT			BIN	
REGISTRATION NO. (1-256)			1	
LOCATION	X (0-319)		160	
	Y (0-239)		120	

GLOBAL WINDOW

When the first Global Window Setup screen appears, select whether to Use, or Not Use a Global Window. (If you select Do Not Use, please ignore the items described below) After selecting Use, the following options will appear after you press the NEXT button.

■ GLOBAL WINDOW ACCESS

This setting designates whether the Global REGISTRATION NO. and the Window LOCATION are Direct or Indirect values. When designated as Direct, the REGISTRATION NO. and Window LOCATION values used are fixed to the values entered here. When Indirect is designated, the WINDOW REG. NO. word address prepared in the System Area becomes variable - which means it can have a new REGISTRATION NO. written to it, and as a result, multiple WINDOW REG. NO.s can be used as the Global window. You can also change the Global window data's display position via this method, i.e. by writing new X,Y coordinates to the SYSTEM AREA's WINDOW LOCATION word addresses.

■ DATA FORMAT

Designates whether the REGISTRATION NO. and the Window LOCATION values are input as BIN or BCD numbers. Only Indirect values can be used in these fields.

■ REGISTRATION NO. (1-256)

Designates the Window Screen Number used by the Global Window. This field is applicable only when the GLOBAL WINDOW ACCESS is set to Direct.

■ LOCATION

Designates the Global Window LOCATION. This field is applicable only when the GLOBAL WINDOW ACCESS is set to Direct.

4 CHARACTER STRING DATA SETUP

Character String Data order will vary from manufacturer to manufacturer. Designate the Character String Data order here that matches your PLC's data order.



Be sure to designate the Character String Data order that matches your PLC type. Device type and Tag settings cannot be entered.

Locate the data storage order for your PLC in the table on the next page, and designate the CHARACTER STRING DATA MODE, based on the data in the following categories.

- I) Data's Device Storage Order
- II) Word's Internal Byte LH/HL Storage Order
- III) Double-word's Internal LH/HL Storage Order

<CHARACTER STRING DATA MODE List>

I) Data's Device Storage Order	II) Word's Internal Byte LH/HL Storage Order	III) Double-word's Internal LH/HL Storage Order	Character String Data Mode
Store from Start Data	LH order	LH order	4
		HL order	2
	HL order	LH order	5
		HL order	1
Store from End Data	LH order	LH order	6
		HL order	7
	HL order	LH order	8
		HL order	3

I) Data Device Storage Order

E.g. Characters A B C D E F G H
 └─┘ └─┘ └─┘ └─┘
 ① ② ③ ④

• Store from Start Data

①	D0100
②	D0101
③	D0102
④	D0103

• Store from End Data

④	D0100
③	D0101
②	D0102
①	D0103

II) Word's Byte LH/HL Storage Order

E.g. Characters A B C D
 ① ② ③ ④

• 16-bit Device LH Order

②	①	D0100
④	③	D0101

• 16-bit Device HL Order

①	②	D0100
③	④	D0101

• 32-bit Device LH Order

②	①	④	③	D0100
---	---	---	---	-------

• 32-bit Device HL Order

①	②	③	④	D0100
---	---	---	---	-------

III) Double-word's Internal LH/HL Storage Order

E.g. Characters "A B C D E F G H I J"
 └─┘ └─┘ └─┘ └─┘ └─┘
 ① ② ③ ④ ⑤

• 16-bit Device LH Order

②	D0100
①	D0101
④	D0102
③	D0103
⑤	D0104

• 16-bit Device HL Order

①	D0100
②	D0101
③	D0102
④	D0103
⑤	D0104

INITIALIZE

E.g. Characters A B C D E F G H I J K L M N O P Q R S T
 ① ② ③ ④ ⑤ ⑥ ⑦ ⑧ ⑨ ⑩

• 32-bit Device LH Order

②	①	D0100
④	③	D0101
⑥	⑤	D0102
⑧	⑦	D0103
⑩	⑨	D0104

• 32-bit Device HL Order

①	②	D0100
③	④	D0101
⑤	⑥	D0102
⑦	⑧	D0103
⑨	⑩	D0104

■ Relationship between K-tag Write Character Values and PLC Device(s)

• With a 16-bit Device

The GP stores the character string from the start, in groups of 2, in a single PLC.

When there are nine characters, they are arranged as follows.

1 2 3 4 5 6 7 8 9 NULL
 └─┘ └─┘ └─┘ └─┘ └─┘



When the characters do not divide into 2 evenly, a NULL value is added.

• With a 32-bit Device

GP stores the character string from the start, in groups of 4, into a single PLC.

When there are nine characters, they are arranged as follows.

1 2 3 4 5 6 7 8 9 NULL
 └─┘ └─┘ └─┘



When the characters do not divide into 4 evenly, NULL value(s) is/are added.

5-4 SET UP I/O

This section describes the communication settings used with both the host PLC and for any peripheral equipment. The SET UP I/O menu includes the SET UP SIO, SET UP I/O, and COMMUNICATION SETUP menus.

1 SET UP SIO

This menu controls the PLC communication settings. Be sure to match the settings listed below with the SIO settings on the PLC host side.



Refer to *PLC Connection Manual*

SET UP SIO	SET	ESC
COMMUNICATION RATE	9600	
DATA LENGTH	8 / 1	
PARITY	OFF	
CONTROL	ER-CNTRL	
COMMUNICATION INTERFACE	4 LINE	

■ COMMUNICATION RATE

The COMMUNICATION RATE (baud rate) is the data communication speed, measured in bits per second (bps), used between the GP and PLC.

■ DATA LENGTH

For data communication, the DATA LENGTH (the first numeral) must be set to either 7-bit or 8-bit. The second value is the DESIGNATED BIT, which must be set to either 1-bit or 2-bit, depending on the DATA LENGTH setting.

■ PARITY

Is used to set whether there is no parity check, or whether an odd or even number parity check is used during data communication.

■ CONTROL

The CONTROL setting prevents the overflow of data. Select either X-CNTRL or ER-CNTRL.

INITIALIZE

■ COMMUNICATION FORMAT

Select one of the following options for the communication format: RS-232C, RS-422 (4 lines), or RS-422 (2 lines)



When using Memory Link format and an RS-422 cable, be sure to select the 4-line option.

2 SET UP I/O

Touch operation, system resetting, and GP display adjustments are made here.

SET UP I/O	SET	ESC
TOUCH OPERATION MODE	2 Points	
SYSTEM RESET MODE	ON	
CONTRAST SETTING	ON	
LCD SETTING	NORMAL	

■ TOUCH OPERATION MODE

Designate either One Point or Two Point (i.e. two points must be touched simultaneously) touch input. Touching the right side's data field will toggle this setting.

■ SYSTEM RESET MODE

Designate whether or not a FORCED RESET can be performed.

To perform a FORCED RESET: While pressing the bottom right corner (1) of the screen, also press the upper right (2) and the bottom left screen corners (3) to call up the SYSTEM RESET screen. Next, press the RESET button.

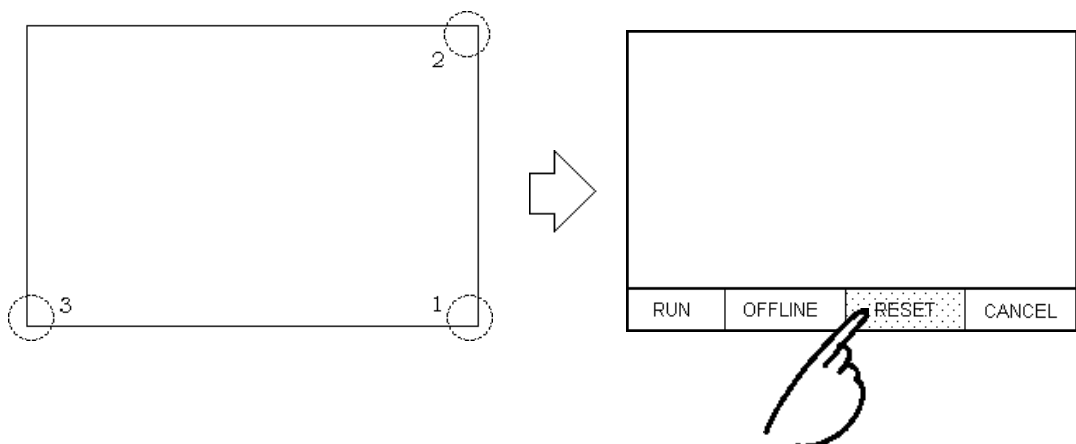



A forced reset can be performed in both RUN and OFFLINE modes.



- The SYSTEM RESET mode cannot be used while the GP is starting up.
- SYSTEM RESET mode can be entered even when normal GP RUN operations (PLC <--->GP communication) are not occurring.

■ CONTRAST SETTING

When this mode has been set to ON, contrast adjustments can be made by simply touching the screen selections.

To call up this mode, simultaneously press the upper right hand and upper left corners of the screen, shown by (1) and (2). Then, as soon as the desired setting is pressed, the screen's contrast will change.

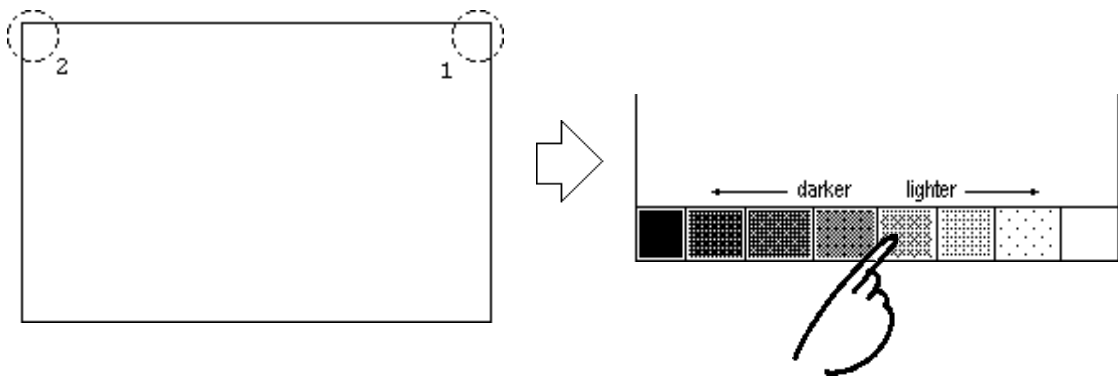

- To exit the CONTRAST ADJUSTMENT mode, touch anywhere outside the contrast option bar.
- CONTRAST ADJUSTMENT mode cannot be entered while the GP is starting up.
- Contrast adjustments can be made even during RUN mode (PLC<--->GP communication).

INITIALIZE

■ LCD SETTING

Touching this item's right side data field will toggle between two options: REVERSE display and NORMAL display. When REVERSE is selected, the screen's colors are inverted (right side screen).

Press the LCD SETTING's right-hand square to change the GP's display from NORMAL to REVERSE, then press the SET button. The display colors will reverse and you will be returned to the previous screen.

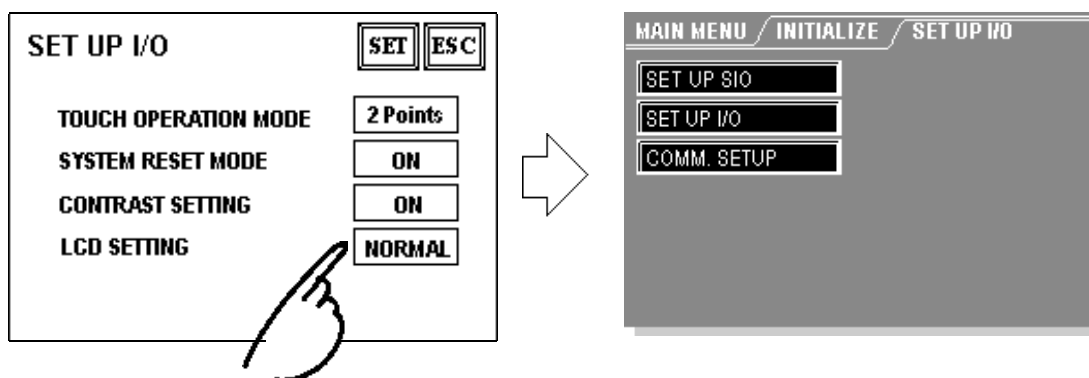

3 COMMUNICATION SETUP

The settings entered into these fields will be used after a GP<--->PLC communication error occurs and an error message is output. Using this feature ensures that an actual error has taken place, rather than a slight communications break or a slowdown in data processing by either the GP or the host (PLC).

COMMUNICATION SETUP		SET	ESC
RECEIVE TIMEOUT (1~127)	10	sec	
RETRY COUNT (0~255)	2		

■ RECEIVE TIMEOUT

Designates how long the GP unit will wait after not receiving any data. (This is referred to as the "Timeout Time") However, if no data communication cable is connected, regardless of this setting, the Timeout value is automatically set to 1 second. The default value (used when a cable is connected) is 10 seconds.



- When a value of over 30 seconds is set here, and screen data is transferred from the user's PC to the GP while a PLC Communication error has occurred, a communication error may also occur with the user's PC.

■ RETRY COUNT

When a PLC communication error occurs, this setting designates the number of times the GP will resend a command before generating an error message. If normal communication is not reestablished after the specified number of retries, an error message will appear on the GP screen. After the message is displayed, the GP will continue trying to send. The default value is 2.

5-5 PLC SETTING SETUP

This screen is used to designate the System Area and the Unit Number. Since **1:1** and **n:1** GP connections will use different settings, be sure to check that the current setting data matches the current connection type.



With the GP-PRO/PBIII for Windows95 “Simulation” feature, the GP’s “Setup Operation Surroundings” area cannot be used.

1 SET UP OPERATION SURROUNDINGS (1:1)

Enter the PLC System Data Area and Unit Number settings here.



These settings are necessary only when using the GP/PLC Direct Access format.

SET UP OPERATION SURROUNDINGS		SET	ESC
SYSTEM AREA START DEV	D		
START ADR	0		
UNIT NO.	0		
SYSTEM AREA READ SIZE	0		

■ SYSTEM AREA START ADDRESS

Designates the SYSTEM DATA AREA’s START ADDRESS. This area contains the PLC’s Data Register (D), Data Memory (DM), and other settings. (The START DEV data used will vary, depending on the PLC type used.)



If your PLC allows multiple devices to be allocated, touch the START DEV entry field and a data entry keypad will appear.

■ UNIT NO.

Enter the PLC Unit number here. Be sure it matches the number used in the PLC.

■ SYSTEM AREA READ SIZE

When using a Block Display Trend Graph, designate a Read Area Size (in word units) that matches the Trend Graph’s data size. The read area will then be allocated according to the system data area setting(s). Use this setting when you wish to designate the PLC Data Register (D), or Data Memory (DM) read areas.



- If you do not plan to use the Read Area, please do not change the default “0” values. This will allow high speed data communication to be performed.
- When using Hitachi’s HIDIC-S10 a Series, an extra item, titled the “Extended Memory Address (HIDIC) [000000]” will be added to the above screen display. Values accepted by the extended memory start address are 0 (memory not extended), and 100000 to 1FF000.



When using Matsushita Electric Company’s NEWNET-FP, an extra item, titled the “Monitor Register”, is added to this screen. When using two (2) or more CCU’s (communication units), as shown in the following diagram, with a GP connected to each CCU, select the 1:1 connection type and designate the Monitor Register as “None”.

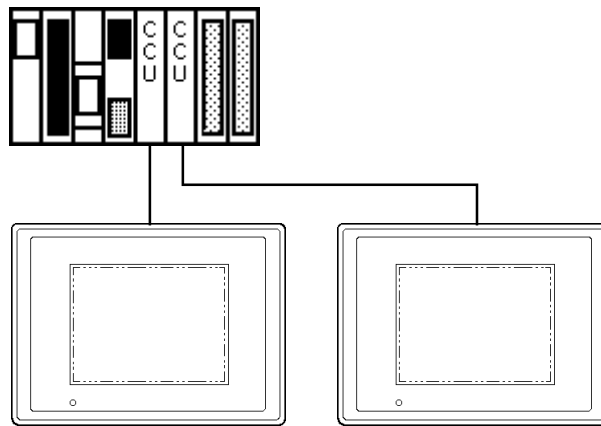

2 SET UP OPERATION SURROUNDINGS (n:1)

This screen designates the settings used for the SYSTEM DATA AREA and UNIT NO. with an n:1 (multi-link) PLC connection.



For more information about the n:1 (multi-link) connection’s SYSTEM DATA AREA, refer to *PLC Connection Manual*.



These settings are only necessary when using the Direct Access format.

SET UP OPERATION SURROUNDINGS		SET	ESC
SYSTEM AREA START DEV	D		
START ADR	0		
UNIT NO.	0		
SYSTEM AREA READ SIZE	0		

INITIALIZE

■ SYSTEM AREA START ADDRESS

Designates the SYSTEM DATA AREA's START ADDRESS. This area contains the PLC's Data Register (D), Data Memory (DM), and other settings.



If your PLC allows multiple devices to be allocated, touch the START DEV. entry field and a data entry keypad will appear.

■ UNIT NO.

Enter the PLC Unit number here. Be sure it matches the number used in the PLC.

■ SYSTEM AREA READ SIZE

When using a Block Display Trend Graph, be sure to designate a Read Area Size (in word units) that matches the Trend Graph's data size. The read area is allocated immediately following the system data area. Set this up when you wish to designate the PLC Data Register (D), or Data Memory (DM) read areas.



- If you do not plan to use the Read Area, please do not change the default "0" values. This will allow high speed data communication to be performed.

3 STATION SETUP (n:1)

STATION SETUP data, which is required for **n:1** (multi-link) systems, checks whether data communication is being performed correctly within the network configuration.

STATION SETUP	SET	ESC
NETWORK INFORMATION DEV	<input type="text"/>	
INFORMATION ADR	<input type="text"/>	
STATION No. (0-15)	<input type="text"/>	

■ **NETWORK INFORMATION ADDRESS**

With a **n:1** (multi-link) connection, network information is transmitted in two (2) word units. These units consist of a Connection List and a Validation List (shown below). This data is used to allocate transmission data into the PLC's Data Register (D) and Data Memory (DM), respectively.

Be sure to specify only addresses which do not overlap the system data area addresses.

PLC Data Register Design

+0	CONNECTION LIST	PLC-->GP
+1	VERIFICATION LIST	GP-->PLC



In the NETWORK INFORMATION ADDRESS area, use the same address to designate all the GP's connected to the same link unit (PLC). Also, when the connected link unit (PLC) has two (2) ports, be sure the PLC addresses used are different.

► **Connection List**

The Connection List's word address designates the number of GP's connected to the PLC, which must be registered beforehand in the PLC. When these GP's are then physically connected to the PLC, the corresponding PLC bit numbers for the particular GP Stations (see below) turn ON.



When the GP is connected to the PLC and the GP ONLY transmission option finishes and OFFLINE mode is reentered, the GP Station Number turns the corresponding PLC bit OFF.

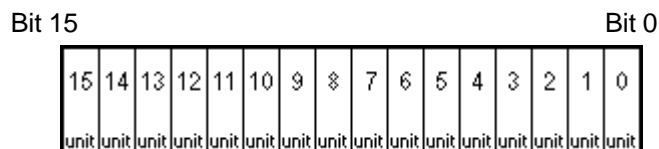

For example, when these four (4) GP units - bit 0, bit 2, bit 3, and bit 5 - are connected, the value 002D (h) is written to the Connection List.

Connection List

0	0	0	0	0	0	0	0	0	0	0	1	0	1	1	0	1
---	---	---	---	---	---	---	---	---	---	---	---	---	---	---	---	---

 002D (h)



- Be sure to designate these settings before running the GP.
- Turn all bits not connected to the GP OFF.

INITIALIZE

► Verification List

This area responds to data transmission from each connected GP. When the bit numbers corresponding to those used the Connection List turn ON, the data transmission is accepted by the Verification List. In turn, the PLC bit numbers corresponding to the Station Numbers of the communicating GPs turn ON.

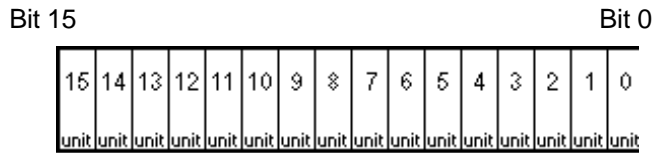

If data transmission between the GP(s) and PLC is being performed correctly, the same value in the Connection List will write to the Verification List.

For example, the value 002D (h) in the Connection List, designated as 0 bit, 2 bit, 3 bit, and 5 bit, will be written to the Verification List, as shown below.

Connection List

0	0	0	0	0	0	0	0	0	0	0	0	1	0	1	1	0	1
---	---	---	---	---	---	---	---	---	---	---	---	---	---	---	---	---	---

 002D (h)

Verification List

0	0	0	0	0	0	0	0	0	0	0	0	1	0	1	1	0	1
---	---	---	---	---	---	---	---	---	---	---	---	---	---	---	---	---	---

 002D (h)



- When the Connection List and Verification List data values do not match, a **COMMUNICATION ERROR** occurs. Recheck all related settings.
- When changing the current connection, first turn all the data bits OFF.

■ STATION NO.

This designates the number of GP Stations in use. The designated range is from 0 to 15, with the only restriction being that each GP STATION NO. used must be unique within the system. If STATION NO.'s are repeated, a **COMMUNICATION ERROR** will occur.



A STATION NO. is the number allocated to a particular GP unit. This number is not related to the Link Unit's (PLC's) machine number.

4 CUSTOMIZE SETUP

The Customize function adjusts the **n:1** (multi-link) connection's communication method to make it more effective. To communicate more efficiently, decide whether to use the Operation or Display priority feature on your GP. As a result, the communication response speed can be improved, although the amount of improvement will depend on the type of information being displayed.

CUSTOMIZE SETUP		SET	ESC
PLC PRIORITY		OPE.	
GP TOUCH MONOPOLIZE		OFF	
MONOPOLIZE TIME		0	*10 sec

■ PLC PRIORITY

Depending on how the GP is used, select either the Operation priority (OPE.) or Display priority setting.

▶ Display (DISP.)

Designate this option when using the GP primarily as a monitor. The GP will operate at a higher display speed as a result; however, the response time for the touch panel's operations will slow.

▶ Operation (OPE.)

Designate this option when using the GP primarily as an operation panel. As a result, the touch panel's numeric input and switch response times will improve.

Leaving the GP in this mode does not significantly influence the touch panel response time of the rest of the GP's, however, their screen display refresh cycles will slow.



- In a standard configuration of GPs, use the same settings for all connected GP's.
- To increase a GP's display speed, be sure to use consecutive addresses wherever possible. With bit addresses, use consecutive word units.

INITIALIZE

► Display Priority and Operation Priority Speed Differences

When using the Mitsubishi Electric Corporation's A3A PLC, with a scan time of 20ms and consecutive addresses (80 words, not including the System Area), the difference in reading speed is as shown in the following graphs.

Display Priority and Operation Priority Speed Differences

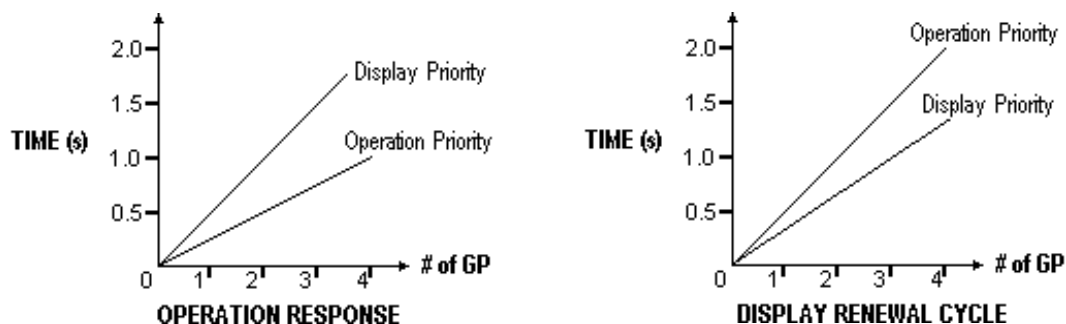

■ GP TOUCH PANEL MONOPOLIZE

The touch panel monopolization feature can be set to either ON or OFF. When the Touch Panel has been set to momentary operation and you want to use the PLC exclusively, turn the GP TOUCH MONOPOLIZE feature ON.



Refer to *PLC Connection Manual 4.5, "About PLC Monopolize"*

When this feature is ON, the touch panel uses the PLC exclusively whenever the Touch Panel's momentary operation feature is pressed. In this way, you can use a momentary switch to perform inching operations. Then, when you press the momentary feature again, exclusive use ends.

■ MONOPOLIZE TIME (0~2550 sec.)

This setting controls the length of time the monopolize feature is in effect when no other touch panel operations are performed. The Monopolize operation begins when the GP System Data Area's word address LS14's 7th bit turns on, and ends either when either the bit turns OFF, or when the set time value elapses. Once the MONOPOLIZE function is released, the previous **n:1** (multi-link) communication method will resume.



- Pressing the touch panel in the middle of the monopolize process interrupts the MONOPOLIZE TIME function, and ends exclusive use.
- When MONOPOLIZE TIME is set to **0**, the monopolize function does not automatically finish.



For further information about the contents of System Data Area's LS6 (status) and LS14 (control) bits, refer to *PLC Connection Manual 1.1.4, "Contents and Range of System Area"*.

5-6 INITIALIZE MEMORY

This command erases all the GP screen data in memory.



- You cannot cancel the Initialization procedure once the Start key is pressed.
- Initialization does not erase the SYSTEM SET UP, SIO protocol, or internal clock data.

INITIALIZE INTERNAL MEMORY 

WARNING: PREVIOUS DATA WILL BE
OVERWRITTEN!

ENTER PASSWORD AND PRESS
START KEY ?



To initialize the GP's internal memory, enter the common password **1101**, or the password entered in the SYSTEM SET UP screen.



For information about entering a password, refer to 4-3, “*INITIALIZE Functions/Inputting Numbers*”.



Initialization takes 10 to 20 seconds.

5-7 SET UP TIME

Enters the time value used for the GP's internal clock. Enter the current date and time (year should be last 2 digits only).

SET UP TIME	SET	ESC
PRESENT TIME		
'95 Y 1 M 15 D 22:16		
TIME SET UP		
' 95 Y 1 M 15 D 22 : 16		



- Overtime, the GP's internal clock will develop an error. At normal room temperature, with the unit unused, this error is within ± 65 seconds/month. The surrounding temperature and age of the unit can further increase the error to +90 to -380 seconds/month. If you use the GP in an environment where a this error can cause problems, be sure to periodically reset the time.
- The year, month, day, hour, and minute data can be written to the System Data Area's clock data in the same way as in OFFLINE mode.

5-8 SET UP SCREEN

Here, the initial screen display shown on powering up, the character size used for alarm messages, and other related items are designated.

SET UP SCREEN		SET	ESC
INITIAL SCREEN NO.	B	1	
ALARM MESSAGE V SIZE		1	
	H SIZE	1	
ONLINE ERROR DISPLAY		ON	

■ INITIAL SCREEN NO.

Here, you can enter the number of the screen file that will first display when the unit is powered up. If the SYSTEM SET UP area's DATA TYPE OF SCREEN NO. field's BIN option has been selected, you can enter a number from B1 to B8999. If BCD has been selected, input a number from B1 to B1999.

■ ALARM MESSAGE

Designates the size of the letters displayed in the ALARM MESSAGE.

1

2

4

Height=1; Width=1
16 x 8 pixels

Height=2; Width=2
32 x 16 pixels

Height=4; Width=4
64 x 32 pixels

■ ONLINE ERROR DISPLAY

Designates whether or not error messages will display during RUN mode.

5-9 FONT SETTING

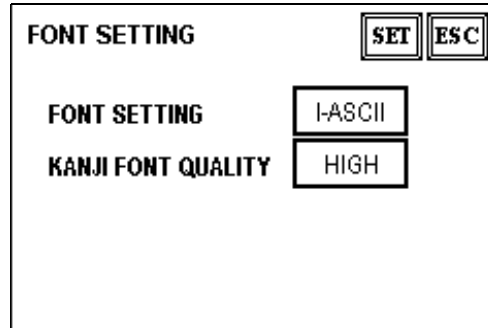

■ FONT SETTING

Select the type of font used by the GP during RUN mode. The options available include ASCII, Korean, Taiwanese, Chinese, and Japanese.

■ KANJI FONT QUALITY

When “FONT SETTING” is set to “JAPAN” :

When the kanji (Chinese) character quality is set to HIGH, Larger than double sized (32X32) characters display as 32 dot characters. When STANDARD is selected, the display becomes a 16 dot font multiple.

When “FONT SETTING” is set to any other setting :

Selecting the HIGH setting will cause single-byte characters (with some exceptions) to display as high quality characters. Selecting STANDARD will cause standard single-byte characters to be displayed.



- When set to the HIGH quality setting, the Level 1 JIS Kanji Code standard is the object. Level 2 standard characters, no matter what the setting, display as 16 dots.

MEMO

This page intentionally left blank.

6

RUN and Errors

6-1 GP RUN Mode

6-2 Troubleshooting

6-3 SELF-DIAGNOSIS

6-4 Error Messages

This chapter describes GP RUN mode, and a variety of troubleshooting processes.

6-1 GP RUN Mode

There are two ways of entering RUN mode, one being after the unit (GP) powers up, and the other being from OFFLINE mode.

1 After Powering Up

Connect the GP unit's power cord terminals. After the unit has powered up, the START TIME value designated in the INITIALIZE/SYSTEM SET UP area determines how long the display, shown below, appears before it is replaced by the next screen, whose number was setup in the INITIALIZE/SET UP SCREEN menu. If, however, a screen has not been previously designated, or, if the designated screen does not exist, this initial screen will remain displayed.

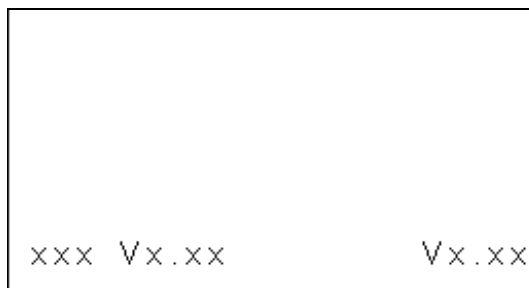

2 OFFLINE Mode

Here, simply press MAIN MENU item number 4, RUN to begin GP operation. The INITIALIZE/SET UP SCREEN option determines the first screen that appears in RUN mode, when communication with the PLC begins. However, if a screen has not been designated, or if the designated screen does not exist, the initial screen will remain displayed.

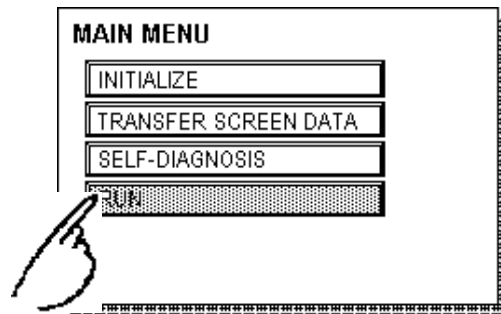

Press the top left corner within 10 seconds of starting RUN to enter OFFLINE Mode.

E.g.) After the GP powers up, the initial screen displayed has a screen-change switch in the top left corner. If this switch is pressed within 10 seconds of the screen being displayed, the GP changes from RUN mode to OFFLINE mode.

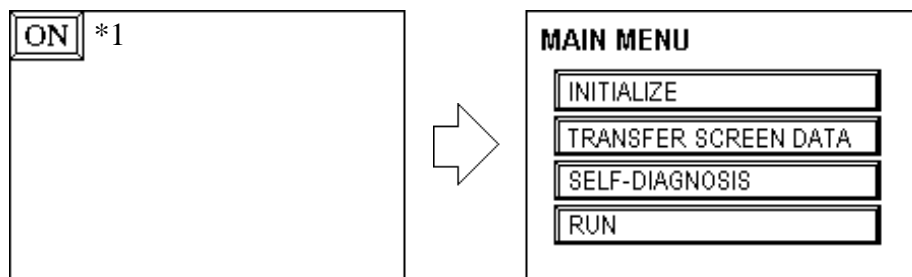

*1 Here, "ON" is shown only to represent the area where you should press. Actually, the word

6-2 Troubleshooting

This section describes how to identify and resolve problems that may occur with the GP. If there is a problem with the PLC, please refer to that PLC maker's manual.

1 GP Problems

The following are possible problems that may occur while using the GP.

(1) No Display

No display appears when the GP's power cable is connected. Also, during RUN mode, the screen disappears.

(2) No Communication

The GP unit cannot receive data from the Host (PLC). An error message may appear on the screen as a result.



For further information about error messages, refer to **6-4, "Error Messages"**.

(3) Touch Panel Does Not Respond

The touch panel does not respond when pressed, or the response time is very slow.

(4) OFFLINE message displays during RUN Mode

For problems (1) to (3), refer to the flowcharts on the following pages.

For problem (4), a **SYSTEM ERROR** may have developed that caused the OFFLINE mode screen to appear.



Refer to **6-4-2, "Error Messages - Details"**

However, if this screen appears after entering OFFLINE mode (by pressing the top left corner within ten seconds of powering up), the unit is operating normally.



WARNING

Prior to performing any adjustments to the GP's wiring:

Because of the possibility of an electric shock, be sure the GP's power cable is not plugged into the main power supply.



This section assumes that the GP is the cause of the problem, not the Host (PLC). When, however, the Host (PLC) is the problem, please refer to the PLC maker's manual.

2 No Display

Use the flowchart below to diagnose why no display appears after the GP's power cable is connected, or, when the screen turns OFF by itself during RUN mode.

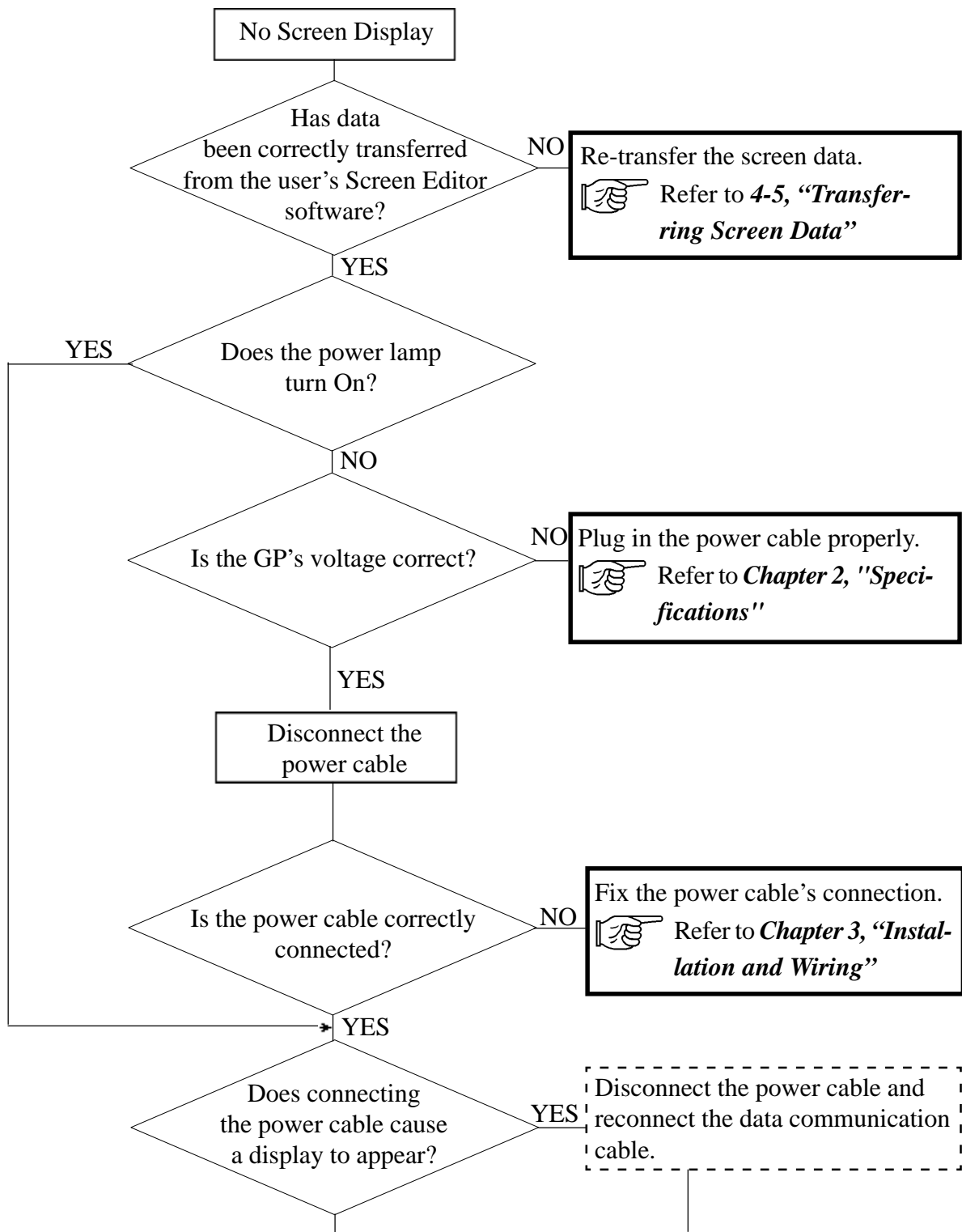

RUN and Errors

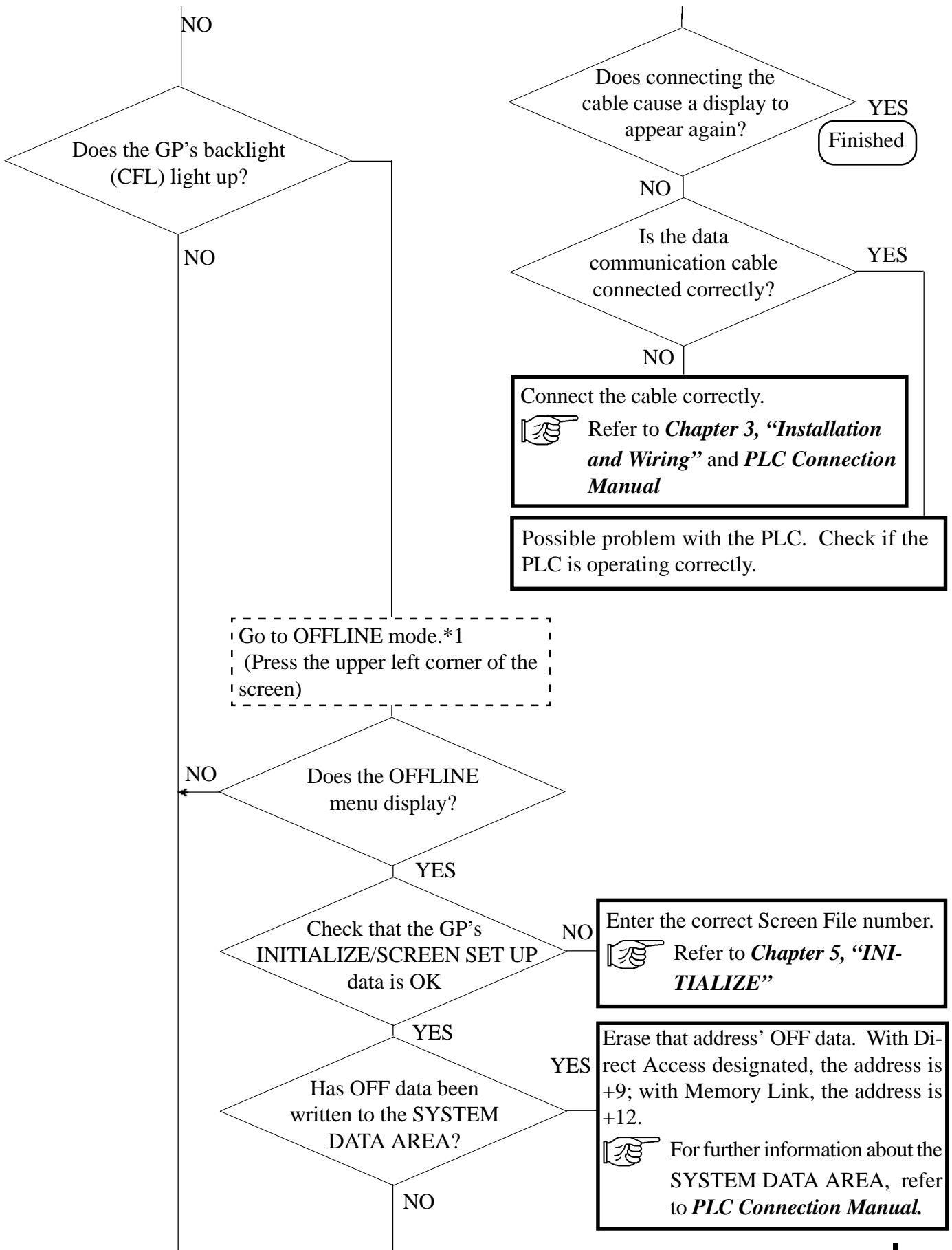

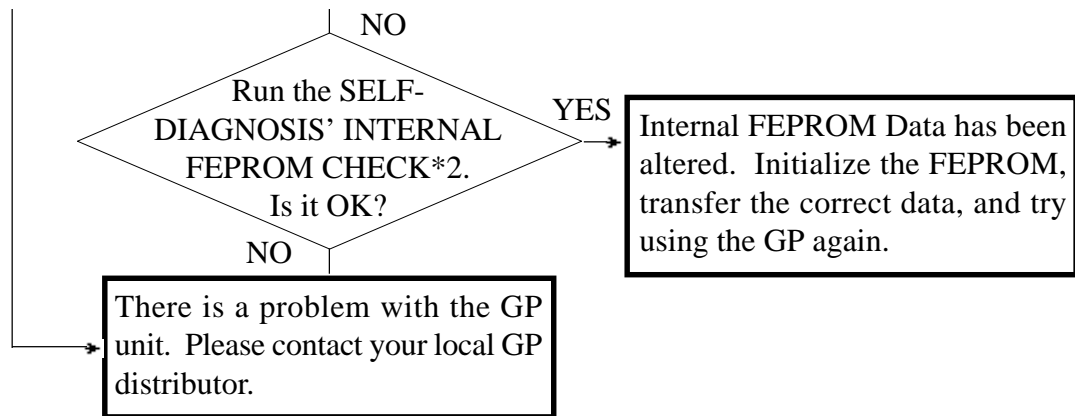

*1 To make the GP's OFFLINE screen appear, disconnect the power cable, reconnect it, then press the upper left corner of the screen within 10 seconds of reconnecting the power cable.

*2 Running the FEPROM check will erase all the current screen data. Be sure to make a backup of all screen data prior to running this check.

3 Can Not Communicate With Host (PLC)

When the GP can not communicate with the Host (PLC), use the flowchart below to diagnose the problem.

Also, if an error message appears on the screen, refer to the error code list.



Refer to 6-4, "Error Messages"

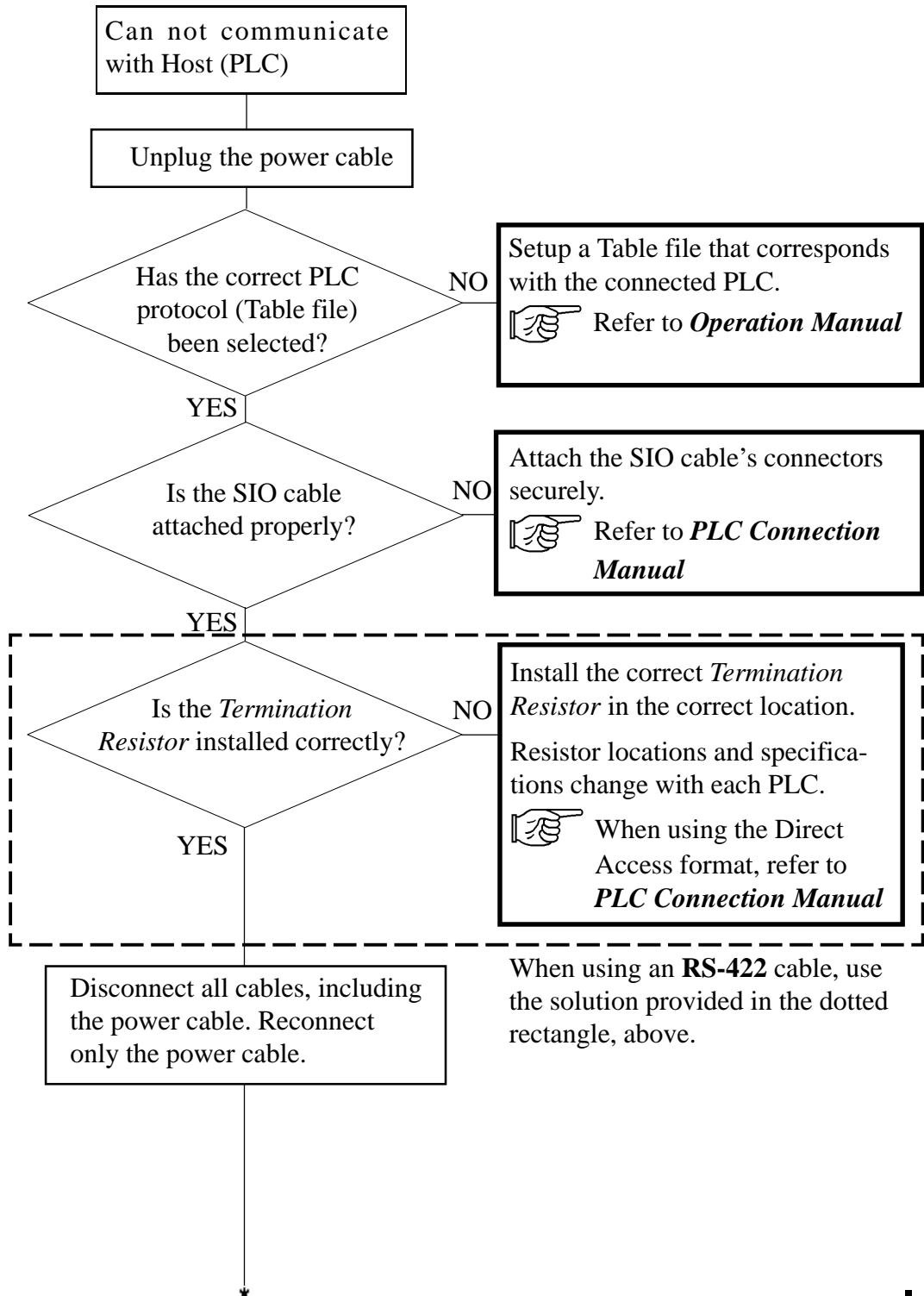

When using an **RS-422** cable, use the solution provided in the dotted rectangle, above.

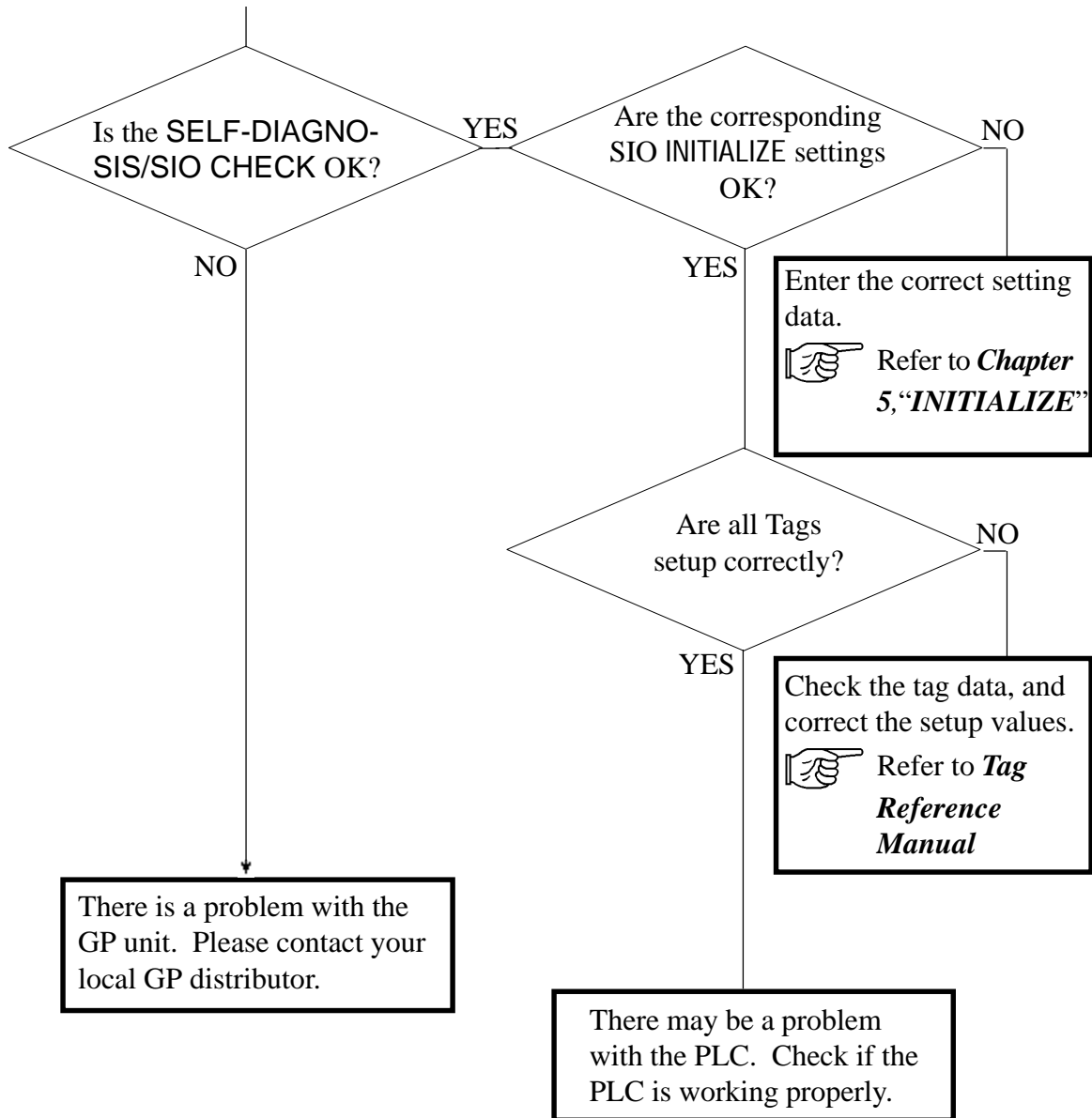

NOTE To run the SELF-DIAGNOSIS SIO CHECK options, special equipment is required.

For details about performing the SELF-DIAGNOSIS, refer to this chapter’s **SELF-DIAGNOSIS** section.

4 Touch Panel Does Not Work

When the touch panel does not respond, or its response time is very slow, please use the flowchart below to diagnose the problem.

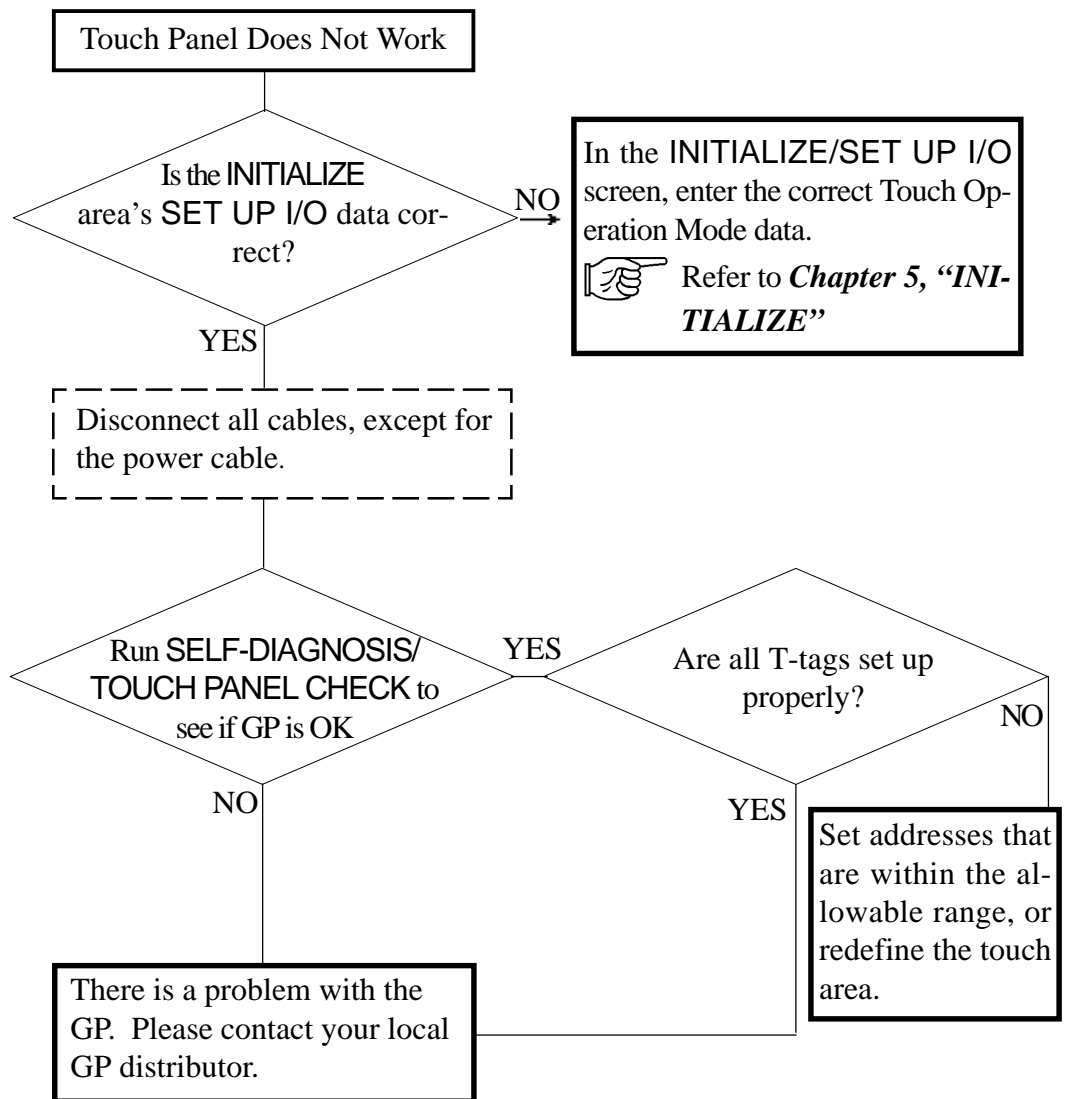

6-3 SELF-DIAGNOSIS

The GP is equipped with System and Interface diagnostic programs. Use this area as a first step in solving most GP problems.

1 SELF-DIAGNOSIS Features

MAIN SELF-DIAGNOSIS MENU	
DISPLAY PATTERN	INPUT PORT
TOUCH PANEL	SIO CHECK
FEPROM CHECKSUM	
FRAME BUFFER	
TOOL CONNECTOR	

DISPLAY PATTERN

Displays all the screen's shapes and tiling patterns to check if they are correct.

TOUCH PANEL

Checks the touch panel squares.

FEPROM CHECKSUM

Runs the GP internal memory's (FEPROM) system and protocol checksum.

FRAME BUFFER

Checks the GP internal display memory (FRAME BUFFER).

***TOOL CONNECTOR**

Checks the tool connector's control lines and input/output lines.

INPUT PORT (for Digital's maintenance use only)

Checks the status of the Input Port.

***SIO CHECK**

Checks the input/output lines for the RS-232C and RS-422 terminals.

 All SELF-DIAGNOSIS items marked with an asterisk (*) require special, user-supplied equipment.

2 SELF-DIAGNOSIS - Detailed Explanation

This section explains the details of the GP's SELF-DIAGNOSIS feature.



For information about how to operate this screen, refer to *Chapter 4, "OFFLINE Mode"*.



For information about how to set up any special equipment required, refer to *Chapter 3, "Installation and Wiring"*.

DISPLAY PATTERN

Checks the drawing function and Kanji ROM. Used when a device's contents are not displayed correctly. Runs checks on the various screen pattern displays. If all displays are normal, "OK" appears; if there is a problem, an "NG" displays.

TOUCH PANEL

Checks if each touch cell highlights when pressed.

INTERNAL FEPROM CHECKSUM (System & Protocol)

The Internal FEPROM System and Protocol check searches for any problems that may have arisen during GP operation. If the FEPROM is normal, OK displays; if there is a problem, an error message appears. Performing this check does not erase any System or Protocol data.

FRAME BUFFER

Looks for any display (memory) problems that may have developed. If everything is normal, OK will appear; if there is a problem, an error message will appear.

TOOL CONNECTOR LOOP BACK

The Tool Connector Control line and Send/Receive line check is used when the GP cannot send or receive data normally from the PC. To perform this check, a Tool Connector Check Loop Back Cable (Dsub25 pin female connection) must be connected to the Data Communication Cable. Refer to the diagram on the next page.

If everything is normal, OK will appear; if there is a problem, an error message will appear.

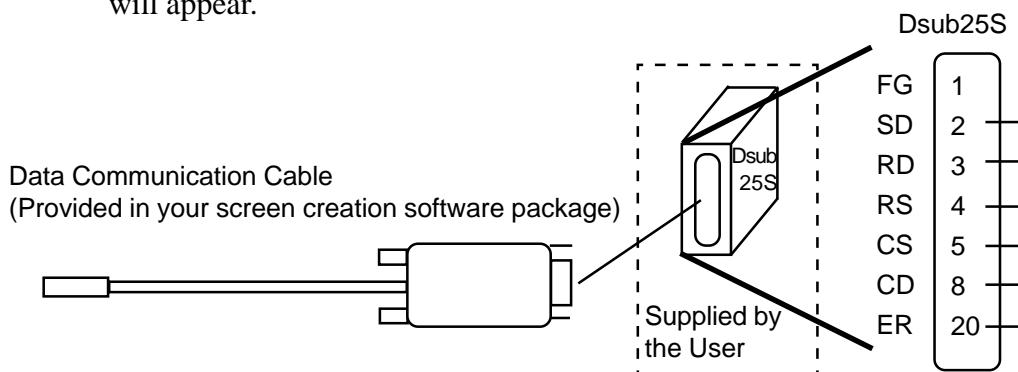

INPUT PORT

Used by Digital for maintenance purposes.

SIO CHECK

Checks the RS-232C and RS-422 I/O cables to identify areas where data transfer problems may have developed. Select which type of check to run from the menu. In order to run this check, a serial interface cable connection is required. If the cable is normal, **OK** displays; if there is a problem, an error message appears.

The serial interface (S10) cable's wiring for each type of check is as shown below.

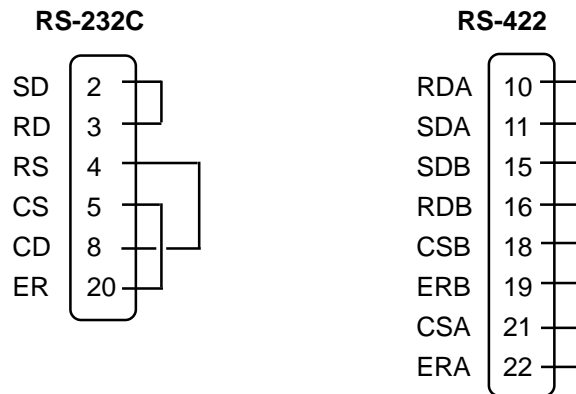

6-4 Error Messages

This section describes each error message that can appear during the operation of the GP-37WL. The origin of each error message's problem is explained, along with appropriate ways of correcting the error.

After a GP problem has been diagnosed, unplug the GP's power cable, then reconnect it to restart the unit.

1 Error Message List

The following list shows the different error messages that can appear on the GP unit. Instructions on how to find and solve the problems indicated by these error messages are explained on the pages that follow.

- SYSTEM ERROR
- ILLEGAL ADDRESS IN SCREEN DATA
- UNSUPPORTED TAG IN SCREEN DATA
- PLC NOT CONNECTED (02:FF) and (02:F7)
- PLC NOT RESPONDING (02:FE)
- RECEIVE DATA ERROR (02:FD)
- PLC COM. ERROR
- SCREEN MEMORY DATA IS CORRUPT
- CLOCK SETUP ERROR
- SCREEN TRANSFER ERROR
- OBJ. PLC HAS NOT BEEN SETUP

For **n:1** connections:

- GP STATION NO. DUPLICATION ERROR (02:F9)
- NETWORK ADDRESS ERROR (02:F8)



If more than one error occurs, the GP displays the error message for the last error detected.

2 Error Messages - Details

■ SYSTEM ERROR

Indicates a basic GP operation error has occurred.

Just after the error message, an error code, as shown below, will appear. Please report the error number, together with any details on how the error might have developed to your local GP distributor.

▶ SYSTEM ERROR (03 : x x)

This message is displayed if a unrecoverable error occurs when data is transferred from the personal computer.

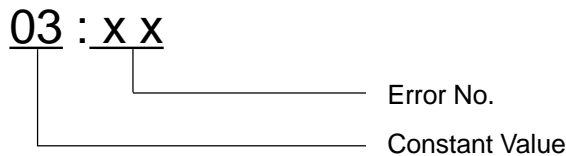

▶ SYSTEM ERROR (x x x : x x x : x x x)

Displays in RUN mode when an unrecoverable error occurs.

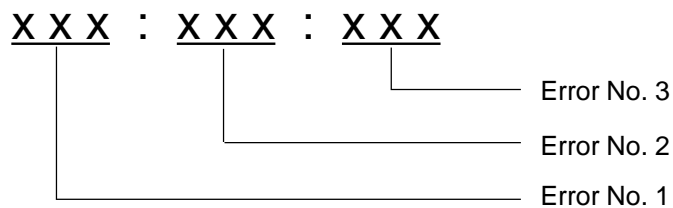

▶ OFFLINE mode displays during RUN mode

When the GP suddenly changes to OFFLINE mode without the user having touched the screen, it is possible that the GP's screen data settings have become corrupted. When this happens, after a **SYSTEM ERROR** is displayed, the screen automatically reverts to OFFLINE mode after approximately 10 seconds. In this case, run the GP's **INITIALIZE MEMORY** command and then retransfer the screen data from your PC to the GP.

RUN and Errors

■ ILLEGAL ADDRESS IN SCREEN DATA

This error message is caused when address values overlap.

Just after this error message, error codes, as shown below, will appear. If the error cannot be fixed, please report this error code and any information as to how the error developed to your local GP distributor.

► ILLEGAL ADDRESS IN SCREEN DATA (0 0 B : x x x : x x x)

0 0 B : x x x : x x x

Error No. 2 (See table below)

Error No. 1

<Overlapping Addresses>

Error No. 1	Error No. 2	Meaning
0C1	191	All or part of the T-File*1 or S-tag address ranges are overlapping System Data Area addresses.
	192	
	193	
0C2	194	All or part of the System Data Area, A-File, or, S-tag address ranges are overlapping a T-file's addresses.
	195	
	196	
0C3	197	All or part of the T-File*1, S-tag or K-tag address ranges are overlapping the address ranges set in an A-file.
	198	
	199	
0C9	19B	All or part of the T-File*1, S-tag or K-tag address ranges are overlapping the address ranges set in a Log Alarm.



Overlapping addresses, other than the ones mentioned above, can also cause the Illegal Address message to appear.

E.g. When the starting address of the System Data Area is set to 100, and a tag is designated as follows:

Tag Name/ Part ID No.	Word Address	Tag Format
N1	99	BCD32

Here, the N-tag's format has been set to 32 bits, meaning it uses two consecutive word addresses. Therefore, since the first address is 99, the second address must be 100. Address 100, however, cannot be used since it has already been reserved for the System Data Area.



*1 For details about setting up T-files (trend graph) and A-files (alarm message), refer to **Tag Reference Manual**.

■ UNSUPPORTED TAG IN SCREEN DATA

This error message shows a list of the tag(s) being used that are not supported by the current GP version. The user must re-do their display screens so that they correspond with those supported by this GP.



For details about tags, refer to *Tag Reference Manual*.

■ PLC NOT CONNECTED (02:FF) (02:F7)

Appears when either communication with the PLC has stopped for more than 60 seconds, when there is a data transmission timeout error, or when there is excessive noise.

Check the data communication cable's wiring and confirm that all connections are correct.

■ PLC NOT RESPONDING (02:FE)

Displays when there is a Reply Timeout Error, or when there is excessive noise.

A list of possible causes and solutions are shown below.

CAUSES	SOLUTION
The Host (PLC) is not turned ON.	Turn the Host (PLC)'s power switch ON.
The GP INITIALIZE area's settings (Setup I/O, PLC Settings, etc.) are not correct.	Correct the GP's INITIALIZE settings so that they agree with the current Host (PLC) and data communication cable settings/specifications.
The Host (PLC) and/or GP's start-up process was incorrect.	After unplugging both the Host (PLC) and the GP, turn the Host (PLC)'s power ON first, wait 2 to 3 seconds, then connect the GP's power cable.
The data communication cable was not connected properly.	Confirm that the data communication Cable's wiring and connections are all correct.

■ RECEIVE DATA ERROR (02:FD)

This error occurs due to one of the following three reasons:

- There is a data reception problem
- The designated and actual PLC types are different
- Noise

The first two errors will appear if the data communication cable is disconnected while the GP is operating, or, when normal data communication is taking place, and the GP's power cable is disconnected, then reconnected. In either of these cases, simply retransmit the previous data.

When the error is a result of noise, correct any improper connections or install a noise filter.

RUN and Errors

■ GP STATION NO. DUPLICATION ERROR (02:F9) n:1

This error will appear for one of two reasons:

- The current GP's station number is the same as another GP's station number. Check that all the GP station numbers are unique.
- During normal data communication, the PLC's power was turned OFF and then ON. Restart both the PLC and the GP.

■ NETWORK ADDRESS ERROR (02:F8) n:1

The SIO address used for the current GP is different from that used for other GPs. Check that all the addresses used for the GPs are unique.

■ PLC COM. ERROR

Appears when the address used for a tag(s) exceeds the address range(s) used on the Host (PLC) side. Check the Error Number that follows this message and use the following table to find a solution.

► PLC COM. ERROR (02 : x x)

02 : xx

Error Code (See table below)

Constant Value

Error #	Cause	Solution
FC	(M to M type) There is a data format problem with the message received.	Check the data being transferred from the Host (PLC).
FB	A tag address, a trend graph data storage address, or an alarm message address is outside of (greater or less than) the allowable range. (address range error)	* When using a Memory to Memory (M to M) connection, enter an address that is within the System Area (0 to 2047)'s designated range, then resend the data. * When using a Siemens series PLC, set up the PLC's data block in the System Data area.
FA	Address range error	Set the addresses so they are within the allowable device address range.
53	With a Matsushita Electronics PLC, when too many tags are used on the screen the PLC cannot receive screen data.	Reduce the number of screen tags.
51	Tag addresses, Trend graph data storage addresses, Alarm message registration addresses, etc. do not exist in the PLC's internal memory. (With a Fuji Electric Co. PLC)	Be sure all addresses have been created within the Fuji PLC's device ranges.
Others	The Error Number displayed will vary depending on the type of PLC used. Look up the error number's meaning in the PLC maker's manual or, contact the PLC maker for information and support.	



- Disregard the above table's data if Error Number **51** appears and you are using a PLC other than that made by the Fuji Electric Co. Look up the error's explanation in your PLC manual and follow the instructions given there.
- Disregard the above table if Error Number **53** appears and you are using a PLC other than that made by Matsushita Electronics. Look up the error's explanation in your PLC manual and follow the instructions given there.
- In Hitachi's HIDIC H (HIZAC H) Series, the error code is divided into 2 bytes, whereas the GP's Error Number is composed of 1 byte codes.

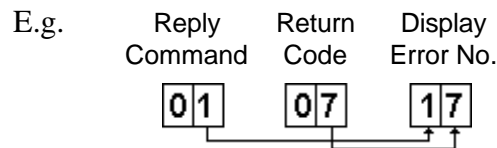

When the displayed error number is 8*, or 5*, use only the left column number as the error number.

- In Toshiba's PROSEC T Series, the Error Code is 4 digits long; on the GP, Error Numbers are converted to and displayed as Hexadecimal.

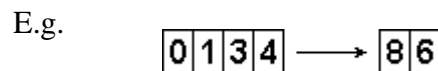

- With the Allen-Bradley PLC-5 and SLC-500 Series PLCs, the EXT/STS error codes have been re-mapped to start at D0 HEX, so that they will not conflict with other error codes. When looking up the error number in the PLC manual, subtract D0 h from the GP error code to get the manual's error code/value.

E.g.

<u>GP Error Code</u>	→	<u>PLC Error Code</u>
D1	→	01
EA	→	1A

■ SCREEN MEMORY DATA IS CORRUPT

Displays when corrupted screen files cause the screen memory data checksum to not match.

Error codes, as shown below, appear just after the error message. Use these codes and their accompanying information to diagnose the screens that have errors. When a screen file has become corrupted, delete that file and make a new one (or use a backup copy, if available).

► SCREEN MEMORY DATA IS CORRUPT (x x x x : x x x x)

X X X X : X X X X

The Screen Number that has an error.
(Displays only one error per Screen Number.)

The number of screens
that have errors (Decimal)

■ CLOCK SET UP ERROR

This message displays when the backup battery for the GP's internal clock is dead. If the battery is incorrectly replaced, however, the battery may explode. To avoid this danger, please consult with your local GP distributor when the battery needs replacement.

After changing the backup battery, be sure to reset the internal clock.



Refer to *Chapter 5, "INITIALIZE"*



The life span of the backup battery depends on the battery's ambient temperature and the amount of current being charged and used. The table below gives a general indication of how long this battery will last.

Battery 's Ambient Temperature	40°C or less	50°C or less	60°C or less
Expected Life Span	more than 10 yrs.	more than 4.1 yrs.	more than 1.5 yrs.

■ SCREEN TRANSFER ERROR

Displays when an error occurs during data transmission from the screen editor (User's PC) to the GP panel. Try re-transmitting the screen data.

■ THE MAXIMUM NUMBER OF TAGS (128) HAS BEEN EXCEEDED.

When a tag is added to a screen and it exceeds the maximum number of tags allowed for that screen, it becomes invalid. In other words, the last tag (i.e. the last tag added) in the list of tags displayed on the screen becomes invalid. However, if "Registered screens" and "Called screens" are included on a single base screen, the last tag called that is over this limit then becomes invalid. If multiple tags are displayed on a single screen, the last tag to become invalid will be as follows:

1. The last screen in the list of registered screens called that exceeds the tag limit becomes invalid.
2. The last screen in the list of called screens that exceeds the tag limit becomes invalid.

Check which tag has become invalid and reduce the number used.

■ OBJ. PLC HAS NOT BEEN SETUP (02:F9)

The host PLC setup in GP's INITIALIZE Screen does not match the PLC in use. Use the Error Code that follows the error message to select the proper PLC type in the GP and correct the INITIALIZE area's setup data.

▶ OBJ. PLC HAS NOT BEEN SETUP (x x)

X X

The PLC number (Hexadecimal) currently written to the System File
(See table below)

<List of PLCs corresponding to error codes>

PLC #	PLC TYPE	PLC #	PLC TYPE
0	SYSMAC - C	20	SIEMENS S5 135-115
1	MELSEC - AnN (Link)	21	SIEMENS S5 3964(R) protocol
2	NEW SATELLITE JW	22	Allen Bradley PLC-5
3	FA500	28	Allen Bradley SLC500
4	MICREX-F	63	FA500M n:1 SIO
6	TOYOPUC-PC2	66	GP FANUC 90SNP
7	MEWNET-FP	67	HIZAC EC
8	HIDIC-S10	68	IDIC 1
9	Memocon-SC	69	IDIC 2
B	MELSEC-AnA (Link)	6A	IDIC 3
D	SYSMAC-CV	6B	FANUC Power Mate
E	PROSEC EX2000	6C	MICRO3
10	HIZAC H	81	MELSEC-AnN (CPU)
11	MELSEC-FX	8B	MELSEC-AnA (CPU)
12	MELSEC-F2	0C	KOSTAC SR21/22
14	KOSTAC SG8	6D	KEYENCE
15	PROSEC T	1C	MELSEC-QnA (LINK)
16	MEMORY LINK (SIO Type)	6F	FLEX-PC (CPU)
18	FLEX-PC		
1B	TC200		
1F	SIEMENS S5 90-115		

7-1 Regular Cleaning

■ Cleaning the Display

When the screen's surface or border becomes dirty, soak a soft cloth in water with a neutral detergent, wring the cloth tightly and wipe off the display.

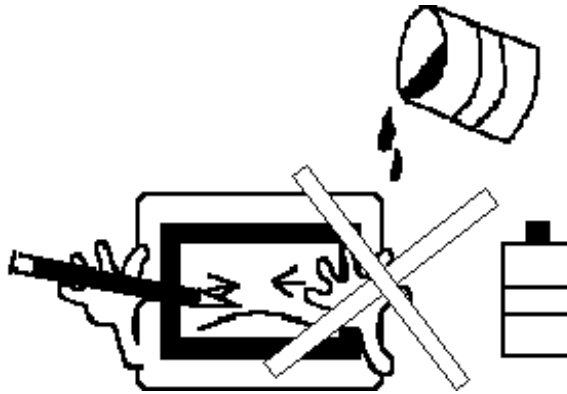

- Do not use paint thinner, organic solvents, or strong acid compounds to clean the GP.
- Do not press the touch-screen panel with hard or pointed objects, such as a mechanical pencil, since it may damage or scratch the surface.

■ Replacing the Moisture Resistant Gasket

This gasket protects the GP and prevents water from entering the case.



For instructions on installing the gasket, refer to **3-1, “GP Installation”**.



When this gasket has been used for a long period of time, it may have scratches or dirt on it and may have lost much of its water resistance. As a result, be sure to change this seal periodically (or when scratches or dirt become visible).

7-2 Periodic Check-Up

To maintain your GP in its best condition, please check the following points periodically.

■ Inspection Items:

Surrounding Environment

Is the temperature within the allowable range? (0 to 50 ° Celsius)

Is the humidity within the specified range? (20 to 85%RH)

Is the atmosphere free of corrosive gas?

- When the GP unit is mounted into a panel, the surrounding temperature refers to the temperature inside the cabinet.

Electrical Specifications

Is the input voltage appropriate? (20.4 to 27.6VDC)

Attachments

Are all cables connected securely?

Are the mounting brackets holding the unit securely?

Are there many scratches or traces of dirt on the moisture resistant gasket?

7-3 Maintenance

For the maintenance of the GP's backlight, contact your local GP distributor. In principle, this service is performed on a send-back basis.

Index

Index

Symbols

1:1 5-1, 5-13

A

Alarm Display 5-3

B

Backlight 7-3

Backlight Bulb 1-4

Bar Code Reader 1-3

C

Cable

Connection 1-2

Downloading Cable 1-3, 4-7

Mitsubishi PLC Procon I/F 1-3

Mitsubishi Programming Port I/F 1-5

Multi-link 1-5

RS-232C 1-3, 1-5

RS-422 1-3, 1-5

Siemen's Programming Port I/F Connection Cable
1-5

CCU 5-14

Change Screen 5-3

COMMUNICATION SETUP

RECEIVE TIMEOUT 5-12

RETRY COUNT 5-12

Connection Part 5-15

Cover Sheet 1-4

CUSTOMIZE SETUP

GP TOUCH MONOPOLIZE 5-18

MONOPOLIZE TIME 5-18

PLC PRIORITY 5-17

D

Data Device Storage Order 5-7

DISPLAY PATTERN 6-10

Downloading Cable 4-7

E

Environmental Shield 7-1

Equipment. *See* Optional Equipment; System Structure

Error Messages

CLOCK SET UP ERROR 6-19

GP STATION NO. REPEATED 6-17

ILLEGAL ADDRESS IN SCREEN DATA 6-15

INCORRECT STORAGE INFORMATION AD-
DRESS 6-17

OBJ. PLC HAS NOT BEEN SETUP 6-20

PLC COM. ERROR 6-18

PLC NOT CONNECTED 6-16

PLC NOT RESPONDING 6-17

RECEIVE DATA ERROR 6-17

SCREEN MEMORY DATA IS CORRUPT ... 6-19

SCREEN TRANSFER ERROR 6-20

SYSTEM ERROR 6-15

UNSUPPORTED TAG IN SCREEN DATA .. 6-16

ESC Key 4-6

F

FORCE RESET 5-10-5-11

Force Reset 4-2

FRAME BUFFER 6-10

G

Global Window 5-5

GLOBAL WINDOW SETUP

DATA FORMAT 5-6

GLOBAL WINDOW 5-5

GLOBAL WINDOW ACCESS 5-5

REGISTRATION NO. (1-256) 5-6

Graphic Panel

Auxiliary Input/Output 2-5

Cleaning 7-1-7-2

Clock 2-3

Display 2-5

Display Functions 2-2

Electrical Specifications 7-2

Environment 7-2

GP-470 External Dimensions 2-6

Installation Brackets 2-7

Installation Dimensions 2-8

Interface 2-3

Maintenance 7-1

Names and Functions of parts 2-5

Periodic Check-Up 7-2

Power Input Terminal Block 2-5

Screen Memory 2-3

Serial Interface	2-5
Temperature	7-2
Tool Connector	2-5
Touch Panel	2-5
Ventilation	3-2

H

Hitachi	
HIDIC-S10 alpha Series	5-13

I

INITIALIZE	4-3, 5-1
Standard Operations	4-4-4-5
INITIALIZE MEMORY	5-19
INPUT PORT	6-10
Installation	3-1
Installation Brackets	1-4

K

K-tag	5-8
-------------	-----

L

Local Window	5-5
--------------------	-----

M

Main Menu	4-3
Matsushita Electric	
NEUNET-FP	5-14
Memory Loader	1-3
Mitsubishi PLC A-Series	
2 Port Adapter	1-3
Procon I/F Cable	1-3
Mitsubishi PLC FX-Series	
Procon I/F Cable	1-3

N

n:1	5-1, 5-14, 5-15-5-16
NETWORK INFORMATION ADDRESS	5-15

O

Off-line Mode	4-1, 6-1
Optional Equipment	1-5

P

Package Contents	10
PLC PRIORITY	
Display Priority and Operation Priority Speed Diff	
5-17	
PLC SETUP	5-13
CUSTOMIZE SETUP	5-17
SET UP OPERATION SURROUNDINGS (n:1) ..	
5-14	
SET UP OPERATION SURROUNDINGS (1:1) ...	
5-13	
STATION SETUP	5-15
Power Terminal Block	3-5
Power-up Sequence	5-3
Printer	1-3
Program Port	1-2

R

RS-232C	2-4, 4-7
RS-232C Port	1-2
RS-422	2-4
RS-422 Connector	1-3
RS-422 Port	1-2
Rubber Gasket	1-4, 7-1
RUN	4-3

S

SCREEN DATA TRANSFER	4-3
Screen Saver Function	5-3
SELF-DIAGNOSIS	4-3, 6-10
DISPLAY PATTERN	6-11
FRAME BUFFER	6-11
INPUT PORT	6-12
INTERNAL FEPROM CHECKSUM	6-11
KEYBOARD LOOP BACK	6-11
SIO CHECK	6-12
DTR CHECK	6-12
RS-422 CHECK	6-13
RTS CHECK	6-12
Standard Operations	4-5-4-7
TOUCH PANEL	6-11
Serial Interface	1-2, 1-5, 2-4
SET Key	4-6
SET UP I/O	5-9
COMMUNICATION SETUP	5-12
SET UP SIO	5-9

Index

SET UP TOUCH PANEL	5-10
SET UP OPERATION SURROUNDINGS	
STARTING ADDRESS OF SYSTEM DATA AREA	
5-13, 5-14	
SYSTEM AREA--READING AREA SIZE	
5-13, 5-15	
UNIT NO.	5-13, 5-14
SET UP SCREEN	5-20
ALARM MESSAGE	5-20
FONT SETTING	5-21
INITIAL SCREEN NO.	5-20
KANJI FONT QUALITY	5-21
ON-LINE ERROR DISPLAY	5-20
SET UP SIO	5-9
COMMUNICATION FORMAT	5-9
CONTROL	5-9
DATA LENGTH	5-9
PARITY	5-9
SET UP TIME	5-19
SET UP TOUCH PANEL	
BRIGHTNESS ADJUSTMENT	5-11
CONTRAST ADJUSTMENT	5-11
FORCE RESET	5-10
TOUCH OPERATION MODE	5-10
SIO CHECK MENU	6-10
Specifications	
Electrical	2-1
Environmental	2-1
Interface	2-4
Structural	2-2
STATION SETUP	
NETWORK INFORMATION ADDRESS	5-15
STATION NO.	5-16
Storage Order. <i>See</i> Data Device Storage Order	
Symbols	11
SYSTEM AREA SETUP	
System Area Size	5-4
SYSTEM ENVIRONMENT SETUP	5-3
CHARACTER STRING DATA SETUP	5-6
GLOBAL WINDOW SETUP	5-5
SYSTEM AREA SETUP	5-4
SYSTEM SETUP	5-3
SYSTEM SETUP	
BUZZER TERMINAL OUTPUT	5-3
DATA TYPE OF SCREEN NO.	5-4
PASSWORD (0-9999)	5-3
STAND-BY MODE TIME (0-255)	5-3
START TIME (0-255)	5-3
TOUCH BUZZER SOUND	5-3
System Structure	1-2

T

Termination Resistor	6-7
TOOL CONNECTOR	6-10
Tool Connector	1-2, 3-7
TOUCH PANEL	6-10
Touch Screen	5-3
Touch Screen Cover	7-1
Transfer Screen Data	4-7-4-8
Troubleshooting	6-2-6-3.
<i>See also</i> Error Messages	
No Display	6-4
The Touch Panel Does Not Work	6-9
Would Not Communicate	6-7

V

Verification Part	5-16
-------------------------	------

W

Wiring	3-5
Grounding	3-6
Input/Output Signal Lines	3-6
Power Cable	3-5
Word Byte LH/HL Order	5-7

