

WARNINGS

- **When connecting the GP power cord terminals to the power terminal block, check first that the GP power supply is completely turned OFF, via a breaker, or similar unit.**
- **With the exception of changing the GP's backlight, do NOT open the GP's case, since high voltage runs through the GP and touching an internal part can lead to an electric shock.**
- **Do not use power beyond the GP's specified voltage range. Doing so may cause a fire or an electric shock.**
- **Do not modify the GP's design, since it may lead to a fire or an electric shock.**
- **Do not use the GP in an environment where flammable gases are present, since operating the GP may cause an explosion.**
- **The GP uses a lithium battery for backing up its internal clock data. If the battery is incorrectly replaced (i.e. its + and — sides are reversed), the battery may explode. When changing the battery, please contact your local GP distributor.**
- **Do not use GP touch panel switches in life-threatening or important disaster prevention situations. For safety related switches, such as an emergency stop switch, be sure to use a separate mechanical switch.**
- **To prevent operator injury or machine damage, be sure to design your machine operation system so that the machine will not malfunction due to a communication fault between the GP and its host controller.**
- **The GP is not appropriate for use with aircraft control devices, aerospace equipment, central trunk data transmission (communication) devices, nuclear power control devices, or medical life support equipment, due to these devices inherent requirements of extremely high levels of safety and reliability.**
- **When using the GP with transportation vehicles (trains, cars and ships), disaster and crime prevention devices, various types of safety equipment, non-life support related medical devices, etc. redundant and/or failsafe system designs should be used to ensure the proper degree of reliability and safety.**

Please be aware that Digital Electronics Corporation shall not be held liable by the user for any damages, losses, or third party claims arising from the uses of this product.

CAUTIONS

- *Do not strike the GP's touch panel with a hard or heavy object, or press on the touch panel too strongly since it may damage the display.*
- *Do not install the GP where the temperature will exceed its specified range.*
- *Be sure that water, liquids or metal particles do not enter the GP, since it may cause a malfunction or a short circuit.*
- *Avoid installing the GP where sudden, large changes in temperature may occur. These changes may cause condensation to form inside the unit, possibly causing a malfunction.*
- *To prevent excessive heat from building up inside the GP, do not install it where its ventilation holes may be blocked.*
- *Do not install or store the GP :*
 - *Where direct sunlight or high levels of dust exist.*
 - *Where either strong shocks or excessive vibration may occur.*
 - *In an area containing chemicals or chemical fumes.*
 - *Near high temperature equipment.*
- *Do not use paint thinner or organic solvents to clean the GP's case or screen.*
- *Due to the danger of unforeseeable accidents, be sure to back up all data regularly.*
- *After turning the GP OFF, be sure to wait a few seconds before turning it ON again. If the GP is re-started too quickly, it may not start up correctly.*

UL/c-UL (CSA) Application Notes

The GP377-SC41-24V and the GP377-LG41-24V are UL/c-UL listed products. (UL file No.E182139)

These units conform as products to the following standards:

■ **UL508**

Industrial Control Equipment

■ **UL1604**

Electrical Equipment for use in Class I and II Division 2, and Class III Hazardous (Classified) Locations, industrial control applications.

■ **CAN/CSA-C22.2, Nos.142 and 213-M1987**

Standard for Safety of Information Technology Equipment, including Electrical Business Equipment

GP377-SC41-24V (UL Registration Model: 2880011-01)

GP377-LG41-24V (UL Registration Model: 2880011-02)

<**Cautions**>

- The GP must be used as a built-in component of an end-use product.
- This unit should be installed in the front face of a solid panel.
- If this unit is installed so as to cool itself naturally, be sure to install it in a vertical panel. Also, be sure that the GP is mounted at least 100mm (3.94 in.) away from any adjacent structures or equipment. If these requirements are not met, the heat generated by the GP's internal components may cause the unit to fail to meet UL/c-UL standard requirements.

UL1604 Conditions of Acceptability and Handling Cautions:

1. Power, input and output (I/O) wiring must be in accordance with Class I, Division 2 wiring methods - Article 501- 4(b) of the National Electrical Code, NFPA 70 within the United States, and in accordance with Section 18-152 of the Canadian Electrical Code for units installed within Canada.
2. Suitable for use in Class I, Division 2, Groups A, B, C and D, Hazardous Locations.
3. **WARNING:** Explosion hazard - substitution of components may impair suitability for Class I, Division 2.
4. **WARNING:** Explosion hazard - when in hazardous locations, turn power OFF before replacing or wiring modules.
5. **WARNING:** Explosion hazard - do not disconnect equipment unless power has been switched OFF, or the area is known to be non-hazardous.

CE Marking

The GP377-SC41-24V and the GP377-LG41-24V are CE marked products that conform to EMC directives EN55011 class A and EN50082-2.

For detailed CE marking information, please contact your local distributor.

Package Contents

The following items are included in the GP's package. Before using the GP, please confirm that all items shown here are present.

■ GP Unit (1) ■ Installation guide(1) ■ Installation fasteners (4/set)

(GP377-SC41-24V,
GP377-LG41-24V)

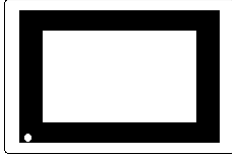

<This Guide>

(GP377-SC41-24V,
GP377-LG41-24V)

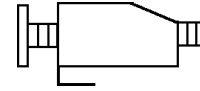

This unit has been carefully packed, with special attention to quality. However, should you find anything damaged or missing, please contact your local GP distributor immediately.

GP Options (Made by Digital)

■ GP-377 Series Users Manual *1 (Sold Separately)

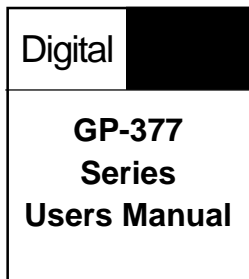

GP377-MM11-ENG/
GP377-MM11
(English/Japanese)

■ Cables ■ Adapters ■ Screen editor software, etc.

For more information on these items, please refer to Digital's latest GP catalogues.

*1 Please refer to this manual for detailed GP information.

1 GP-377 Parts Names and Functions

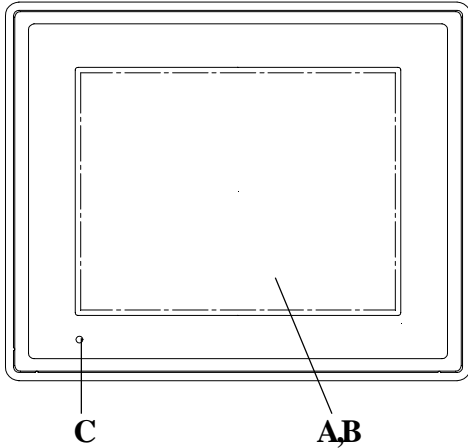

A: Display

Displays User-created screens and host (PLC) data.

GP377-SC41-24V : STN type Color LCD

GP377-LG41-24V : Monochrome LCD

B: Touch Panel

Performs screen change operations and sends data to the host (PLC).

C: Status LED

LED	GP Status
Not Lit	Power cord is not connected.
Green	Normal operation
Orange	Backlight is not functioning (Refer to Section 9. Changing the Backlight)

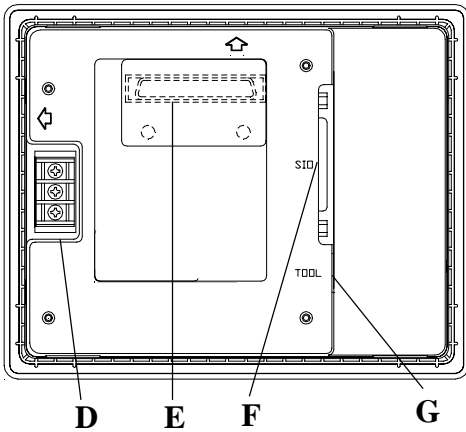

D: Power Input Terminal Block

Connects the GP power cable's input and ground wires to the GP.

E: Expansion Unit Interface

Connects an optional GP Expansion Unit to the GP.
(Inside cover)

F: Serial Interface

Connects an RS-232C or RS-422 (Serial) cable
(from the host/PLC) to the GP.

G: Tool Connector

Connects the Data Transfer Cable, Bar Code Reader,
Memory Loader or other equipment to the GP.

2 GP-377 External Dimensions

Unit:mm(in.)

Top View

155.5 (6.12)

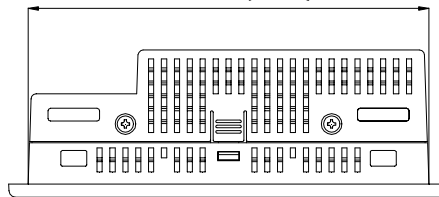

Rear View

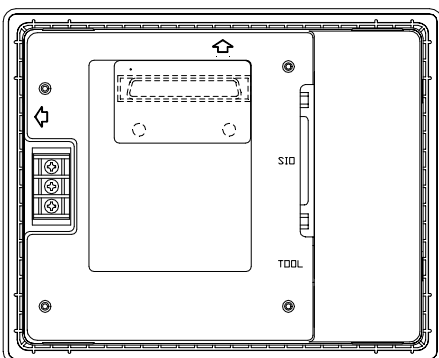

138 (5.43)

Front View

171 (6.73)

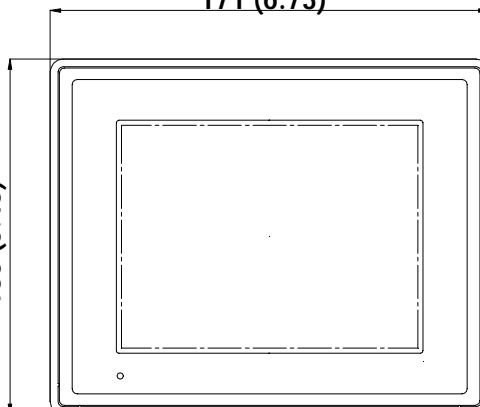

Side View

57 (2.24)

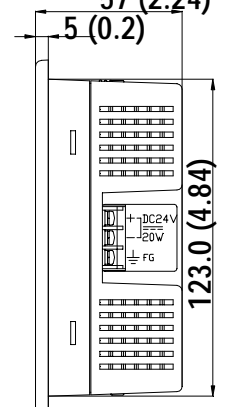

123.0 (4.84)

3 Serial Interface

This interface is for connecting the GP to the host (PLC), via either an RS-232C or RS-422 cable.

	Pin #	Signal Name	Meaning
	1	FG	Frame Ground
	2	SD	Send Data (RS-232C)
	3	RD	Receive Data (RS-232C)
	4	RS	Request to Send (RS-232C)
	5	CS	Clear to Send (RS-232C)
	6	NC	No Connection
	7	SG	Signal Ground
	8	CD	Carrier Detect (RS-232C)
	9	TRMX	Termination (RS-422)
	10	RDA	Receive Data A (RS-422)
	11	SDA	Send Data A (RS-422)
	12 ^{*1}	RESERVED	RESERVED
	13 ^{*1}	RESERVED	RESERVED
	14	VCC	5V Output 0.25A
	15	SDB	Send Data B (RS-422)
	16	RDB	Receive Data B (RS-422)
	17	NC	No Connection
	18	CSB	Clear to Send B (RS-422)
	19	ERB	Enable Receive B (RS-422)
	20	ER	Enable Receive (RS-232C)
	21	CSA	Clear to Send A (RS-422)
	22	ERA	Enable Receive A (RS-422)
	23	BUZZ GND	External Buzzer Ground
	24	NC	No Connection
	25	BUZZ OUT	External Buzzer Output

*1 Pins Number 12 and 13 are reserved and should not be connected to anything.

Recommended Connector: Dsub 25 pin (male) XM2A-2501 <made by OMRON Corp.>

Recommended Cover: Dsub 25 pin XM2S-2511 <made by OMRON Corp.>

Jack Screws XM2Z-0071 <made by OMRON Corp.>



Use rough metric type M2.6 x 0.45p threads to hold the cable's set (fastening) screws in place.

Recommended Cable: CO-MA-VV-SB5P x 28AWG <made by HITACHI Cable>



- **The GP's RS-485(RS-422) Port is not isolated, therefore, be sure to connect pin #7 (SG terminal) to the other unit's signal ground terminal. If this is not done, the RS-485(RS-422) circuit may be damaged.**
- **Since pin #14 (VCC) is not protected, be sure to use it only within its rated range.**



Note: When making a cable, please be aware of the following:

<For RS-232C Connectors>

- **Do not connect #9 (TRMX), #10 (RDA), #11 (SDA), #15 (SDB), #16 (RDB), #18(CSB), #19 (ERB), #21 (CSA), and #22 (ERA).**

<For RS-422 Connectors>

- **The following pairs of pin numbers' must be connected (shorted):**
 - #18 (CSB) <-> #19 (ERB)**
 - #21 (CSA) <-> #22 (ERA)**
- **Connecting the #9 (TRMX) and #10 (RDA) wires adds a termination resistance of 100W between RDA and RDB.**
- **Use a 4-wire cable when the PLC type is Memory Link and the cable is RS-422.**

<External Buzzer Output>

Use pins 23(BUZZ GND) and 25(BUZZ OUT) when producing external output for an alarm.

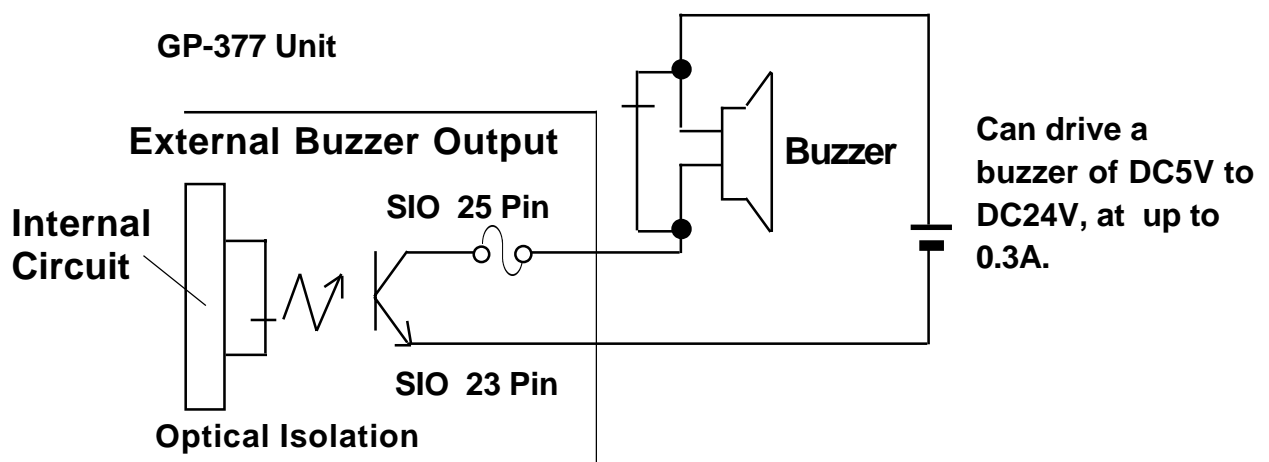

4 Installation Procedures

Follow the steps given below when installing the GP unit.

■ Confirm the Installation Gasket's Seating

It is strongly recommended that you use the gasket.

Place the GP on a level surface with the display panel facing downward. Check that the GP's installation gasket is seated securely into the gasket's groove, which runs around the perimeter of the panel's frame.



Before installing the PL into a cabinet or panel, check that the Installation gasket is securely attached to the unit.

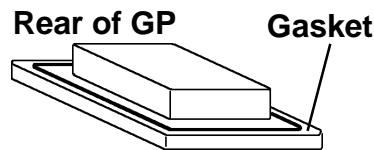

■ Cut a hole in the metal panel according to the dimensions given below.

Insert the GP into the panel from the front of the panel.

Unit: mm (in.)

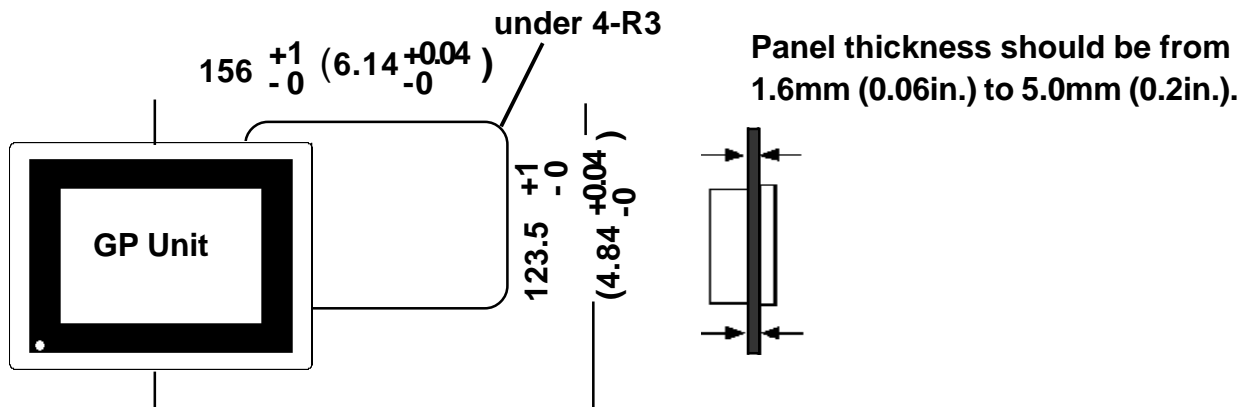

■ Attach the GP's Installation Fasteners from inside the panel.

Tighten the installation fasteners with a standard screwdriver.

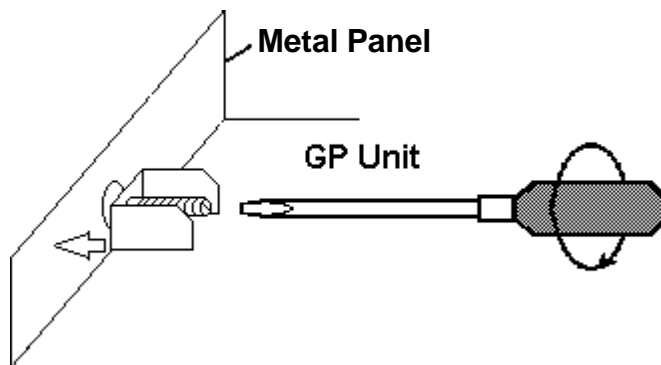

Tightening the fastener screws with too much force can damage the GP's case. The torque necessary to ensure a sufficient seal is 0.5 to 0.6N•m.

5 Wiring

WARNING

- To avoid an electric shock, check first that the GP's power supply is completely turned OFF, via a breaker, or similar unit when connecting the GP power cord terminals to the power terminal block.
- GP-377 Series units are designed to use only DC24V input. Any other power level can damage both the GP and the power supply.
- Be sure to reattach the GP Power Terminal's clear plastic cover after connecting the Power Cord's power terminals to the Terminal Block.



- When connecting a wire to the GP's FG terminal, be sure the wire is grounded. Not grounding the wire will result in excessive noise.
- To avoid a short caused by loose ring terminals, be sure to use ring terminals with an insulating sleeve.



- Wherever possible, use thick wires (max. 2 mm²) for power terminals, and twist the wire ends before attaching the ring terminals.
- Be sure to use the following size ring terminals.*¹

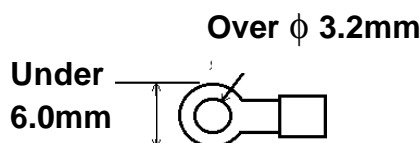

- Since the GP has no power switch, install a breaker-type switch.

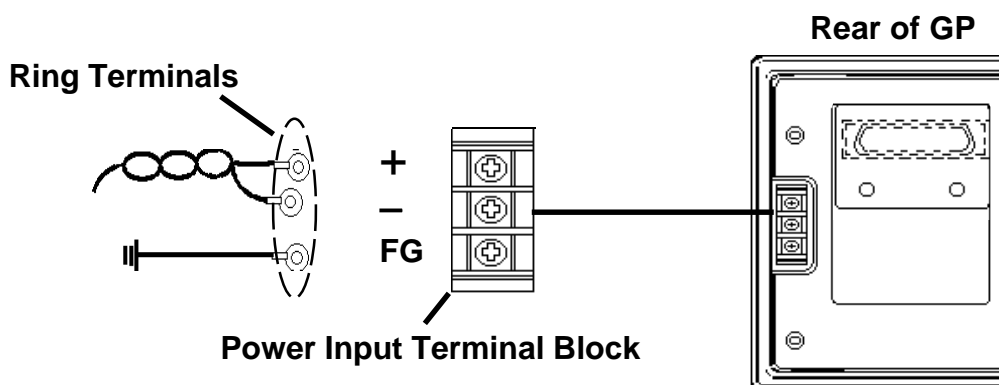

■ Connecting the GP's Power Cord

When connecting the power cord, be sure to follow the procedures given below.

1. Confirm that the GP's Power Cord is unplugged from the power supply.
2. Use a screwdriver to remove the Power Input Terminal Block's clear plastic cover.
3. Connect the power terminals and check that the wires are connected correctly.
4. Replace the Power Input Terminal Block's clear plastic cover.



The torque required for fastening the screws is 0.5 to 0.6N•m.

*¹ Suggested Ring Terminal: V2-MS3 (made by JST Co.)

6 Power Supply Precautions

Be aware of the following items when attaching the power cord terminals to the GP's power terminal block.

- When operating the GP where large power fluctuations will occur, install a constant voltage transformer.
- To reduce wire-to-wire or wire-to-earth noise as much possible, use a low-noise power supply. If noise is excessive, use a Noise Reducing Transformer.
- Be sure to separate all GP power, I/O unit and Operation unit lines.
- To increase the noise resistance of the power cord's wires, twist each end before attaching the Ring Terminal.
- Do not bundle or position the GP's power cord near main circuit lines (high voltage, strong current), or I/O signal lines.
- To prevent damage from lightning, be sure to install a lightning surge absorber.
- To minimize line noise, make the GP's power cord as short as possible.

7 Grounding Precautions

- When attaching a wire to the GP's rear face FG terminal, (on the Power Input Terminal Block), be sure to create an exclusive ground.*¹

8 I/O (Input/Output) Signal Line Precautions

- All GP Input and Output signal lines must be separated from all operating circuit (power) cables.
- If this is not possible, use a shielded cable and ground the shield.

9 Changing the Backlight



WARNING

- Be sure the GP's power supply is completely turned OFF, via a breaker, or similar unit prior to changing the Backlight.
- Do not touch any of the GP's internal parts while the unit is still ON, since high voltage runs through the Backlight area.
- When the power has just been turned OFF, the unit and Backlight are still very hot. Be sure to use gloves to prevent burns.

When the unit's backlight burns out, the unit's status LED will turn orange. If the "USE TOUCHPANEL AFTER BACKLIGHT BURNSOUT" feature is set to "NO", the GP's touch panel will be disabled. *1



Note: Check you have the proper backlight for the GP-377 Series.

GP	Backlight Model
GP377-SC41-24V	GP377L/S - BL00 - MS
GP377-LG41-24V	

Change the Backlight following the steps below. Be sure to use gloves.

(Fig.A)

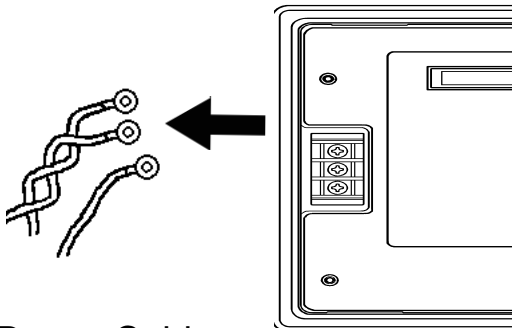

Power Cable

- 1) Disconnect the GP's Power Cord from the power supply.
- 2) Remove the power cord terminals from the GP. (See figure A)

(Fig.B)

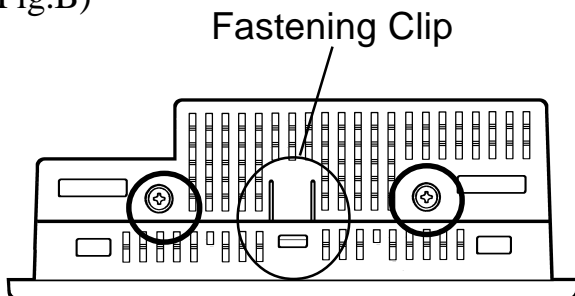

- 3) Use a screwdriver to unscrew the two screws attached on the unit's top face. Keep pushing the Fastening Clip and open the top face. Be sure the clip-tab does not get caught. (See figure B)

*1 If "NO" has been selected for the OFFLINE menu's "FORCE RESET" feature, Touch-Panel operation is disabled.

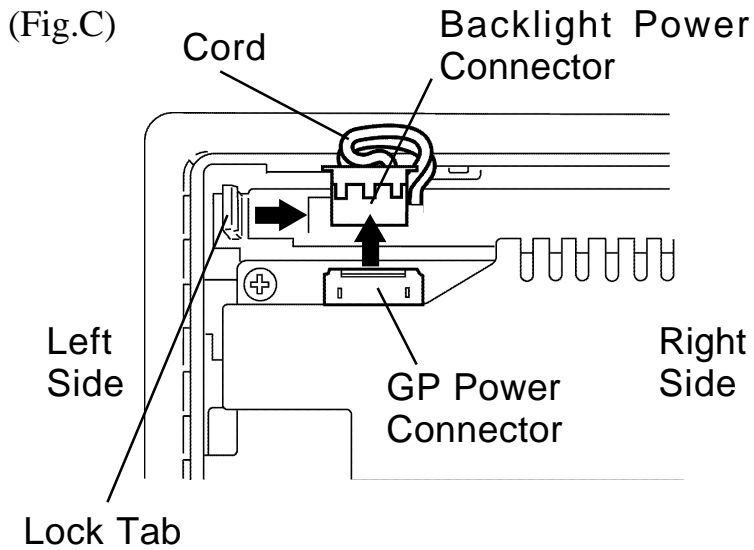

- 4) Disconnect the backlight's Power Connector as shown in Fig. C. Do not pull the cord itself.
- 5) Push the Lock Tab to the right, pull the tab upward, and remove the backlight unit. (Fig. C)
- 6) Insert the new Backlight unit into the slot. (Right side first, then left side.)
- 7) Reattach the Backlight Power Connector to the GP Power Connector.

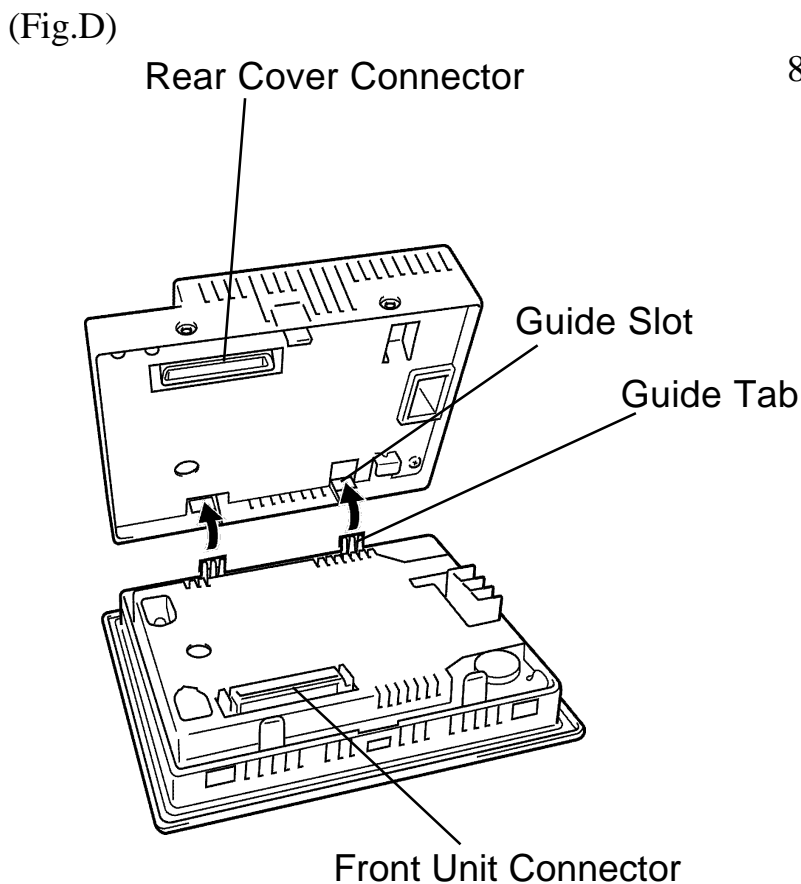

- 8) To replace the GP's rear cover, insert the Front Unit's guide tabs into the case's guide slots and close the cover. Be sure that the Rear Cover Connector and the Front Unit Connector are correctly aligned. (Fig. D)