

PL3000 Series Installation Guide

(Built-in Battery Unit Version)

Caution

Be sure to read the “Warning/Caution Information” on the attached sheet before using the product.

Package Contents

- (1) PL Unit (1)
- (2) English and Japanese Installation Guides (one of each) <This Guide>
- (3) Warning/Caution Information (1)
- (4) USB Cable Clamp (2 ports) (2)

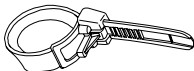

- (5) USB holder (Fasteners: 1, screws: 2) (1set)



- (6) Power Connector (For AC type) (1)



AC type
(5.08 mm [0.2 in.] pitch)

■PL-3000B Series

- (7) Installation Fasteners (Fasteners: 2, screws: 4)

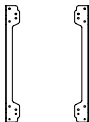

■PL-3600*/3700*/3900T Series

- (7) Installation Gasket (Attached to the front module) (1)
- (8) Installation Fasteners (4 fasteners per set)
PL-3600T Series : 1 set
PL-3600K/3700T Series : 2 sets
PL-3700K/3900T Series : 3 sets



IMPORTANT

- Be careful when installing the PL not to damage the built-in HDD.

This unit has been carefully packed, with special attention to quality. However, should you find anything damaged or missing, please contact your local PL distributor immediately.

When you order a PL unit built to your specifications, that PL package should include each optional item's Installation Guide. Please use that guide to check the contents of each optional item's package.

About the Manuals

For the detailed information on PL series, refer to the following manuals.

- PL3000 Series Hardware Manual
 - PL3000 Series Reference Manual
 - PL3000 Series API Reference Manual
- The manual can be downloaded from Pro-face Home Page.

URL

<http://www.pro-face.com/otasuke/>

NOTE

- The drivers and utilities for PL can be downloaded from Pro-face Home Page.

Part Names and Functions

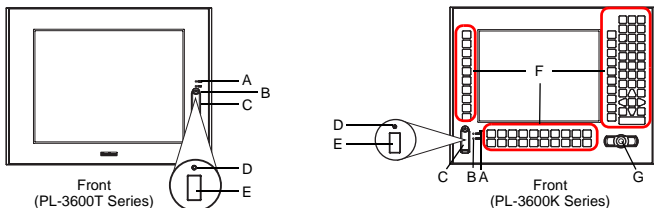

Name	Description												
A Power LED / RAS status lamp (POWER)	<table border="1"> <thead> <tr> <th>LED</th> <th>Indicates</th> </tr> </thead> <tbody> <tr> <td>Green (lit)</td> <td>Normal operation (power is on)</td> </tr> <tr> <td>Green (blinking)</td> <td>Soft OFF state</td> </tr> <tr> <td>Orange (lit)</td> <td>System monitor error (RAS error)</td> </tr> <tr> <td>Orange/Red (blinking)</td> <td>Backlight burnout is detected.</td> </tr> <tr> <td>Not lit</td> <td>Power is OFF</td> </tr> </tbody> </table>	LED	Indicates	Green (lit)	Normal operation (power is on)	Green (blinking)	Soft OFF state	Orange (lit)	System monitor error (RAS error)	Orange/Red (blinking)	Backlight burnout is detected.	Not lit	Power is OFF
LED	Indicates												
Green (lit)	Normal operation (power is on)												
Green (blinking)	Soft OFF state												
Orange (lit)	System monitor error (RAS error)												
Orange/Red (blinking)	Backlight burnout is detected.												
Not lit	Power is OFF												
B Disk access lamp (DISK)	<table border="1"> <thead> <tr> <th>LED</th> <th>Indicates</th> </tr> </thead> <tbody> <tr> <td>Green (lit)</td> <td>When HDD/SSD or IDE is accessed</td> </tr> <tr> <td>Not lit</td> <td>When neither HDD/SSD nor IDE is accessed</td> </tr> <tr> <td>Orange (lit)</td> <td>Battery working</td> </tr> </tbody> </table>	LED	Indicates	Green (lit)	When HDD/SSD or IDE is accessed	Not lit	When neither HDD/SSD nor IDE is accessed	Orange (lit)	Battery working				
LED	Indicates												
Green (lit)	When HDD/SSD or IDE is accessed												
Not lit	When neither HDD/SSD nor IDE is accessed												
Orange (lit)	Battery working												
C Front cover	—												
D Hardware reset switch (RESET)	Resets the PL unit and returns the system from Soft OFF.* ¹												
E USB interface	1 port. USB2.0 compatible. Type-A connector is used. <table border="1"> <tbody> <tr> <td>Power supply voltage</td> <td>DC5V±5%</td> </tr> <tr> <td>Output current</td> <td>500mA (Max.)</td> </tr> <tr> <td>Maximum communication distance</td> <td>5m</td> </tr> </tbody> </table>	Power supply voltage	DC5V±5%	Output current	500mA (Max.)	Maximum communication distance	5m						
Power supply voltage	DC5V±5%												
Output current	500mA (Max.)												
Maximum communication distance	5m												
F Keypad	F/A key allows switching between function input and character input. An illuminated F/A key LED indicates character input. For detailed instructions on how to use the keypad, refer to "PL3000 Series Reference Manual".												
G Mouse pointer	2-button mouse												

*¹ The Soft OFF refers to the state when Windows[®] has been shut down and the power is provided only for the electric circuit to boot system. This Soft OFF State is different from Windows[®] System Standby.

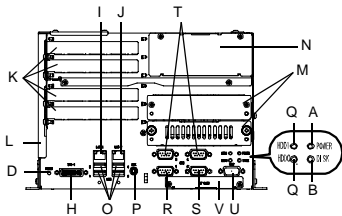

Front (PL-3000B Series)

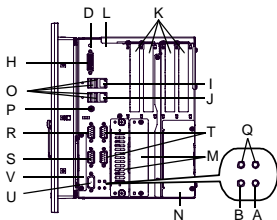

Right side (PL-3600T Series)

Name	Description						
H DVI-I interface (DVI-I)	Interface with DVI monitor or analog RGB monitor. DVI monitor can be connected to PL-3000B series only.						
I Ethernet interface (LAN1)	10BASE-T/100BASE-TX/1000BASE-T Auto Changeover. This interface uses an RJ-45 type modular jack connector (8 pins).						
J Ethernet interface (LAN2)	10BASE-T/100BASE-TX Auto Changeover. This interface uses an RJ-45 type modular jack connector (8 pins).						
K Expansion slot	For expansion board (PCI). 4 slots.						
L Expansion slot cover	Expansion slot cover is removed when mounting expansion board and DIM module.						
M HDD slot	For serial ATA HDD/SSD unit. HDD slot 0 and HDD slot 1.						
N Battery unit cover	Battery unit inside.						
O USB interface (USB1/2/3/4)	4 ports. USB2.0 compatible. Type-A connector is used. <table border="1" style="width: 100%; border-collapse: collapse;"> <tr> <td>Power supply voltage</td> <td>DC5V±5%</td> </tr> <tr> <td>Output current</td> <td>500mA (Max.)</td> </tr> <tr> <td>Maximum communication distance</td> <td>5m</td> </tr> </table>	Power supply voltage	DC5V±5%	Output current	500mA (Max.)	Maximum communication distance	5m
Power supply voltage	DC5V±5%						
Output current	500mA (Max.)						
Maximum communication distance	5m						
P Speaker output interface (SPK)	Mini pin jack connector						
Q HDD status lamp	For HDD slot 0 and for HDD slot 1. <table border="1" style="width: 100%; border-collapse: collapse;"> <thead> <tr> <th>LED</th> <th>Indicates</th> </tr> </thead> <tbody> <tr> <td>Green (lit)</td> <td>HDD/SSD mounted (Normal operation)</td> </tr> <tr> <td>Not lit</td> <td>No HDD/SSD mounted</td> </tr> </tbody> </table>	LED	Indicates	Green (lit)	HDD/SSD mounted (Normal operation)	Not lit	No HDD/SSD mounted
LED	Indicates						
Green (lit)	HDD/SSD mounted (Normal operation)						
Not lit	No HDD/SSD mounted						
R Serial interface (COM1)	D-Sub 9-pin plug type. RS-232C, RS-422, RS-485 Changeover. CI (RI)/+5V Changeover.						
S Serial interface (COM2)	Not available on the built-in battery unit version.						
T Serial interface (COM3/COM4)	D-Sub 9-pin plug type. RS-232C.						
U RAS interface (RAS)	D-Sub 9 pin socket type.						
V CF card interface (CF CARD)	IDE-type connection *1. CF card (Type I/II) is available.						

*1 Since an IDE-type connection is used, the unit is not hot-swappable. When inserting/removing the CF card, be sure that power is turned OFF.

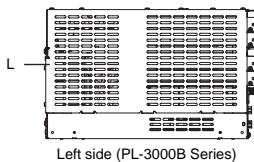
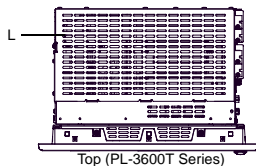
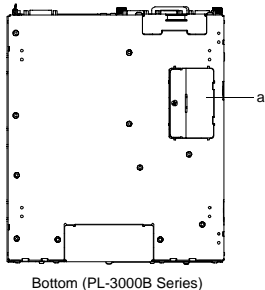
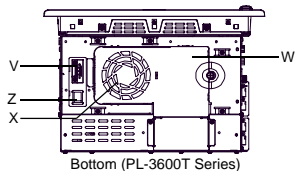
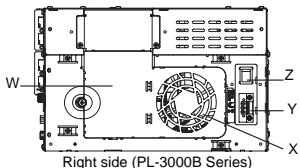

W	Fan cover	System fan inside
X	System fan	A fan for cooling the PL unit.
Y	Power connector	—
Z	Power switch	—
a	Switch cover	Remove switch cover when setting the DIP switch, slide switch, and replacing batteries for clock data backup.

General Specifications

■ Electrical Specifications

Power Supply		AC type
	Input Voltage	AC100 to 240V
	Rated Voltage	AC85 to 264V
	Rated Frequency	50/60Hz
	Allowable Frequency Range	47 to 63Hz
	Allowable Voltage Drop	1 cycle or less (Voltage drop interval must be 1s or more.)*1
	Power Consumption	145VA or less
	In-Rush Current	40A or less
Voltage Endurance	AC1500V 20mA for 1 minute (between charging and FG terminals)	
Insulation Resistance	DC500V 10M Ω (min.) (between charging and FG terminals)	

*1 When the battery is not charged, depending on the total of the expansion slot power and the external load power, the length of the allowable voltage drop will be 20 ms or less (excluding PL3000B series). For details, refer to the graphs below.

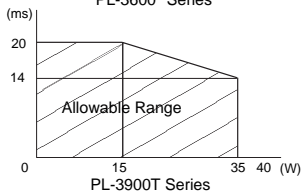
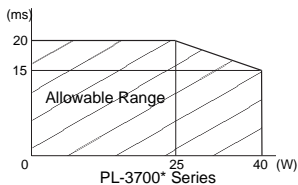
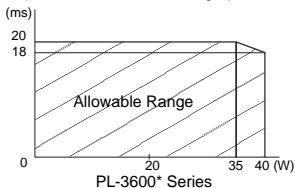

■ Environmental Specifications

Physical	Surrounding Air Temperature	5 to 45°C
	Storage Temperature	-20 to +60°C (when packed)
	Ambient Humidity	10 to 90% RH (Not condensing, wet bulb temperature: 39°C or less. Wet bulb temperature with HDD: 29°C or less.)
	Storage Humidity	10 to 90% RH (Not condensing, wet bulb temperature: 39°C or less.)
	Dust	Free of dust
	Pollution Degree	For use in Pollution Degree 2 environment

IMPORTANT

- When using any of the PL's optional devices, be sure to check that device's specifications for any special conditions or cautions that may apply to its use.
- Be aware that not only does the HDD/SSD have a fixed lifetime, but that accidents can always occur. Therefore, be sure to back up your HDD/SSD's data regularly, or prepare another HDD/SSD unit that can be used for backup.
- The Hard Disk lifetime given here may be reduced due to unforeseen environmental factors, however, generally speaking, the disk should last for 20,000 hours (of operation) or approximately 5 years, whichever comes first at an operating temperature of 20°C and 333 hours of operation per month. (HDD access frequency of 20% or less)
- Using the Hard Disk in an environment that is excessively hot and/or humid will shorten the disk's usage lifetime. A wet bulb temperature of 29°C or less is recommended. This is equivalent to the following data.

Temperature	at 35°C	at 40°C
Humidity	no higher than 64% RH	no higher than 44% RH

- In order to extend the lifetime of the hard disk, Pro-face recommends you set the Windows® 2000's [Control panel]-[Power Management option]-[Turn off hard disks] selection or the Windows® XP's [Control panel]-[Performance and Maintenance]-[Power Management option]-[Turn off hard disks] selection to turn the hard disk off when the unit is not being operated. A setting of 5 minutes is recommended.
- Do not vibrate the hard disk continuously at the same frequency. Doing so may cause the hard disk to reduce transfer speeds or stop temporarily.

NOTE

- Weight increases by about 1.4kg with a battery unit. Please refer to PL3000 Series Hardware Manual for other specifications.

Internal Switches

To operate the internal switches, uninstall the control box and the front module.

With the PL-3000B series unit, remove the switch cover from the control box.



Installation/uninstallation of the front module and the control box (18 page)

IMPORTANT

- Make sure to turn off the power supply before using the switches. Adjusting the switches while power is supplied may cause errors.

1. Internal switches of the control box

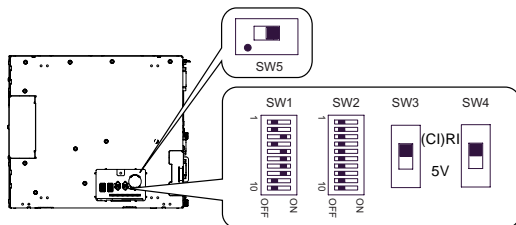

Bottom face of the control box

Switch Location	Switch Name	Compatible I/F	Factory Settings	Description
SW1	System Set Switch	—	See ■ System Set Switch	10-point DIP switch. For System Set Switch and the factory settings details, see ■ System Set Switch.
SW2	Serial Mode Select Switch	COM1	All OFF (RS-232C)	10-point DIP switch. Designates COM1 communication settings. For Serial Mode Select Switch details, see ■ Serial Mode Select Switch.
SW3	CI(RI)/+5V Changeover Switch	COM2	CI(RI)	Not available on the built-in battery unit version.
SW4	CI(RI)/+5V Changeover Switch	COM1	CI(RI)	Changes # 9 pin (CI(RI) / +5V).
SW5 ^{*1}	DVI Cable Selection Switch	—	 Side without the symbol ● (FP-DV01-100 is not supported)	Toggles between supporting and not supporting the FP-DV01-100 [DVI-D cable (10m)], a Pro-face FP3000 Series option. For details, see ■ DVI Cable Selection Switch.

*1 .PL-3000B series only.

■ System Set Switch

Switch No.	Description	ON	OFF	Factory Settings	Notes
1	Internal setting	Reserved	Reserved	OFF	Do not change. (Factory setting)
2	Implements the logical inversion operation for RAS output	Normal Close	Normal Open	OFF	RAS output is a CLOSE state when the switch and the system is ON. When the Switch is OFF, it is the opposite. The RAS Output keeps Normal OPEN when the Soft OFF state occurs or the power turns OFF.
3	Sets up an enabled/disabled state for the front USB port execution control function ^{*1*2}	Enabled	Disabled	ON	The front USB port is available when the switch is ON. It is unavailable when the switch is OFF.
4	Internal setting	Reserved	Reserved	OFF	Do not change. (Factory setting)
5 to 8				ON	
9 to 10				OFF	

*1 Panel computer only.

*2 The Setting up an enabled/Disabled state for USB port execution control function is available for only Windows[®] 2000 and Windows[®] XP. Make sure to disable the function of the setting when other OS is used.

■ Serial Mode Select Switch

Switch No.	Description	ON	OFF	RS-232C	RS-422	RS-485
1	Internal setting	Reserved	Reserved	OFF ^{*1}	OFF ^{*1}	OFF ^{*1}
2	Changes COM1's communication method	RS-422/RS-485	RS-232C	OFF	ON	ON
3	Changes COM1's communication method	RS-422/RS-485	RS-232C	OFF	ON	ON
4	Changes SD (TXD) data's output mode	SD (TXD) data output is controlled via the RS (RTS) signal.	SD (TXD) data output is NOT controlled via the RS (RTS) signal. (normally output)	OFF	ON/ OFF	ON/ OFF ^{*2}
5	Switches the SD (TXD) termination resistance ON/OFF	Inserts termination resistance of 220Ω between SDA and SDB.	No termination	OFF	ON	ON/ OFF ^{*3}
6	Switches the RD (RXD) termination resistance ON/OFF	Inserts termination resistance of 220Ω between RDA and RDB.	No termination	OFF	ON	ON/ OFF ^{*3}

Switch No.	Description	ON	OFF	RS-232C	RS-422	RS-485
7	Switches the shorting of SDA and RDA ON or OFF	Shorts SDA and RDA (RS-485 mode)	No shorting (RS-422 mode)	OFF	OFF	ON
8	Switches the shorting of SDB and RDB ON or OFF	Shorts SDB and RDB (RS-485 mode)	No shorting (RS-422 mode)	OFF	OFF	ON
9	RS (RTS) Automatic control mode (enabled only when RS-485 mode)	The data is automatically controlled via the RS (RTS) signal.	The data is not automatically controlled via the RS (RTS) signal.	OFF	OFF	ON/ OFF*2
10				OFF	OFF	ON/ OFF*2

Serial Mode Select Switches (SW4 to SW10) operate as shown in the circuit diagram below.

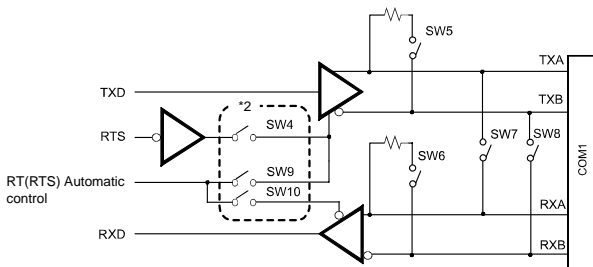

*1 Be sure to leave these settings OFF.

*2 Set switches number 9 and 10 to ON when the SD (TXD) output driver is automatically controlled with RS (RTS). Set switch number 4 to OFF.
Set switches number 9 and 10 to OFF when the SD (TXD) output driver is controlled with the RS (RTS) signal. Set switch number 4 to ON.

*3 If you use the termination resistance, base your settings on the connection specifications.

■ DVI Cable Selection Switch

When connecting Pro-face FP3000 Series to PL-3000B series unit, use the Pro-face DVI-D cable (10m) FP-DV01-100. (Other 10m DVI cables are not supported)

When using FP-DV01-100, change DVI Cable Selection Switch (SW5) settings.

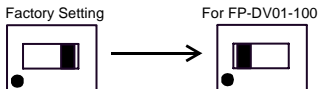

IMPORTANT

- When using the display unit with a cable other than FP-DV01-100 (such as FP-DVD01-50), use the Factory Setting.

NOTE

- The default Resolution and Screen Refresh Rates are as follows.
Resolution : SVGA (800x600)Screen
Refresh Rate: 60Hz
Maximum resolution varies depending on the FP3000 Series models. Please customize it for your FP model.

2. Internal switches of the front module

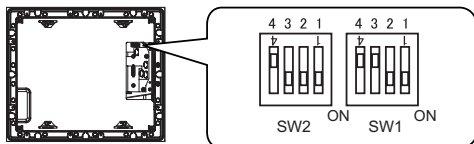

Rear face of the front module

Switch Location	Switch Name	Factory Settings	Description
SW1	Touch Panel Set Switch	1:ON, 2:ON, 3:OFF, 4:OFF	4-point DIP switch. For Touch Panel Set Switch details, see "■ Touch Panel Set Switch".
SW2	—	Version Dependant	Internal setting. Do not change. (Factory setting) PL-3600* Series : 1, 2, 3: ON, 4: OFF PL-3700* Series : 1, 3: ON, 2, 4:OFF PL-3900T Series : 1, 2, 4: OFF, 3:ON

■ Touch Panel Set Switch

Switch No.	Description	ON	OFF	Factory Settings	Notes
1 to 2	Internal setting	Reserved	Reserved	ON	Do not change. (Factory setting)
3				OFF	
4	Cancellation function of two point touch on the touch panel*1	Enabled	Disabled	OFF	The middle point is not considered to be touched when the switch is ON. It is considered to be touched when the switch is OFF.

*1 When two points are pushed, it is considered that middle point between the two points is touched according to the nature of the analog resistive touch panel. When the switch, etc. is set on the middle point, it will be enabled and may operate. To prevent such a switch from malfunction in case of pushing two points, turn ON Switch No.4 in advance, then the middle point will be disabled for two point touch.

Backup Battery

1. About the Battery

The battery unit is equipped with a Ni-H battery for backup.

■ Charging time

It takes 15 hours for the battery to become fully charged from empty with the power on.

IMPORTANT

- If the PL unit is not used for an extensive period of time, or during initial stage of new installation of the PL unit, the backup battery may be insufficiently charged. The battery must be fully charged with the unit powered on AC for 15 hours or more. If the battery is insufficiently charged, the backup battery function may not work properly.

■ Service life

Conditions for the battery	Service life (years)
Hours of use per a day: 24 hours (continuous use) Discharge: 50W 3 minutes discharge, 5 times per year Surrounding air temperature: 30°C	about 3

IMPORTANT

- The service life of the battery varies depending on its usage condition. The values shown above do not guarantee your battery's service life. It is strongly recommended that the battery be replaced with a new one as early as possible.

2. Battery Cautions

DANGER

- To prevent the battery from leakage, heat generation or explosion, be sure and:
 - Do not heat or throw the battery into a fire.
 - Do not disassemble or modify the battery.
- If the battery liquid, strong alkaline, gets in your eyes, immediately rinse your eyes with clean water and consult a doctor, since it may cause you to lose your eyesight.

WARNING

- Do not get the battery wet in fresh or salt water. Doing so may cause battery heat generation and rust. If rust in the battery is found, the function of the gas blowdown valve may not work properly. Moreover, continued use of the battery in this situation may cause an explosion.
- Do not scratch or remove the outer covering tube. Doing so may cause battery leakage, heat generation, and an explosion.
- If the battery liquid, strong alkaline, contacts your skin and clothes, be sure to wash it with clean water. Otherwise, it may cause skin lesions.

CAUTION

- Do not strike or throw the battery. Doing so may cause battery leakage, heat generation, and an explosion.
- Do not carry the battery while holding the connector and the lead wire. Doing so may cause battery damage.

- Avoid leaving the battery in high temperature places such as direct sunlight, inside a sun-heated car, near water, or near a heater. Doing so may cause battery leakage, or reduce the battery functions and lifetime.
- The battery can be recycled. To recycle your used battery, follow the regulations and instructions in your area.

External Interfaces

IMPORTANT

- This PL unit's serial port is not isolated. When the host (PLC) unit is also not isolated, and to reduce the risk of damaging the RS-232C/RS-422/RS-485 circuit, be sure to connect pin #5 SG (Signal Ground) terminal.
- Never connect NC to COM1.
- Connect FG to housing.
- COM2 is not available on the built-in battery unit version because that version uses COM2 exclusively as an interface for battery output.

■ Serial Interface (COM1, COM3, COM4)

Interfit Bracket	#4-40 (UNC)
------------------	-------------

◆ COM1, COM3, COM4

Pin #	RS-232C	
	Signal Name	Description
1	CD	Carrier Detect
2	RD(RXD)	Receive Data
3	SD(TXD)	Send Data
4	ER(DTR)	Data Terminal Ready
5	SG	Signal Ground
6	DR(DSR)	Data Set Ready
7	RS(RTS)	Request to Send
8	CS(CTS)	Clear to Send
9	CI(RI)/+5V	Called status display/ +5V Output 0.5A*1 *2
Shell	FG	Frame Ground (Common with SG)

*1 Only COM1 is available for switching to +5 V. COM3 and COM4 are used exclusively for CI (RI).

*2 Slide switch on the circuit board in the PL unit switches between CI (RI) and +5 V. For details, see [Internal Switches].

◆COM1

Pin #	RS-422 *3	
	Signal Name	Description
1	RDA	Receive Data A(+)
2	RDB	Receive Data B(-)
3	SDA	Send Data A(+)
4	ERA	Data Terminal Ready A(+)
5	SG	Signal Ground
6	CSB	Clear to Send B(-)
7	SDB	Send Data B(-)
8	CSA	Clear to Send A(+)
9	ERB	Data Terminal Ready B(-)
Shell	FG	Frame Ground (Common with SG)

Pin #	RS-485*3	
	Signal Name	Description
1	DATA +	Send/Receive Data (+)
2	DATA -	Send/Receive Data (-)
3	NC	No Connection
4	NC	No Connection
5	SG	Signal Ground
6	NC	No Connection
7	NC	No Connection
8	NC	No Connection
9	NC	No Connection
Shell	FG	Frame Ground (Common with SG)

*3 To change the communication method, set the DIP switch located on the circuit board in the PL unit to the desired position. For details, see [Internal Switches].

■ RAS Interface

IMPORTANT

- Be sure to use only the rated voltage level when using pin #1 (+12V) for external power output. Failure to do so can lead to a unit malfunction or accident.

Interfit Bracket	#4-40 (UNC)
------------------	-------------

Pin #	Signal Name	Description
1	+12V	Output Current: 100mA or less Output Voltage: 12V±5%
2	DOUT0(+)	Data out 0(+)
3	DOUT1(+)	Data out 1(+)
4	DIN0(+)	Data in 0(+)
5	DIN1(+)	Data in 1(+)**1
6	GND	Ground
7	DOUT0(-)	Data out 0(-)
8	DOUT1(-)	Data out 1(-)
9	DINCOM	Data in ground common

*1 Can be used as reset input.

NOTE

- For the circuit diagram, refer to “PL3000 Series Reference Manual”.

Installations

1. PL-3000B Series Installation

■ Installation Requirements

- For easier maintenance, operation, and improved ventilation, be sure to install the PL at least 50mm [1.97 in.] away from adjacent structures and other equipment. 120 mm [4.72 in.] space (minimum) is necessary at the front for cable curve.

Unit:mm[in.]

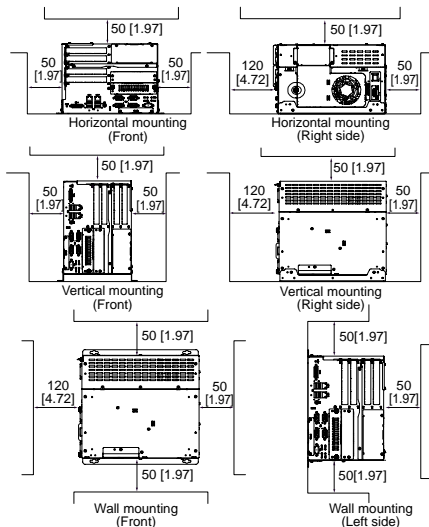

- Be sure that the surrounding air temperature and the ambient humidity are within their specified ranges.

Check the surrounding air temperature 30 mm [1.18 in.] away from the main unit.

Ex.: Horizontal mounting

Unit:mm[in.]

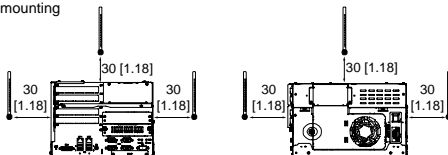

- Be sure that heat from surrounding equipment does not cause the PL to exceed its standard operating temperature.

■ Installation

IMPORTANT

- Determine the thickness of the board in consideration of its strength. The minimum thickness of a board is 1.6 mm [0.06 in.] for M4 screws.
 - M4 screws are not included with the PL unit. Please prepare them by yourself.
- (1) Create holes and perform the necessary processing on the board according to the drawing of mounting holes.

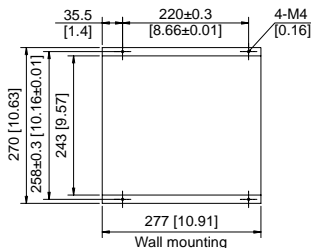
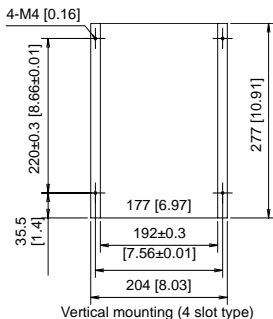
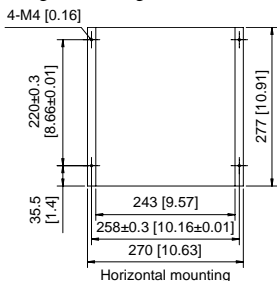

- (2) Attach installation fasteners with the accompanying four screws (M3) to the PL unit. Pay close attention to the direction of the fasteners. The torque required to tighten these screws is 0.5 to 0.6N•m.

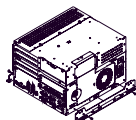

Horizontal mounting
or wall mounting

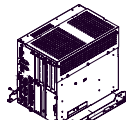

Vertical mounting

- (3) Attach the PL unit to the board with the screws (M4): First, tighten the screws temporarily on the board; mount installation fasteners temporarily onto the screws; and then tighten the screws until the PL unit is securely fixed. The torque should be 1.0 to 1.2N•m.

Ex.: Horizontal mounting

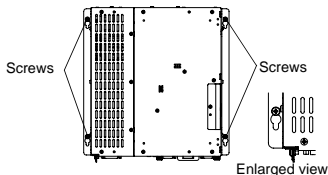

IMPORTANT

- Tightening the screws with too much force can damage the PL unit.
- Be sure to insert installation fasteners in the recessed portion of an installation fasteners hole. If the fasteners are not correctly attached, the PL unit may shift or fall out of the panel.

2. PL-3600*/3700*/3900T Series Installation

IMPORTANT

- Before installing the PL unit on the panel, detach the control box from the front module to configure the settings of the internal switches.

SEE→ Installation/uninstallation of the front module and the control box, Internal Switches

Installation Requirements

- For easier maintenance, operation, and improved ventilation, be sure to install the PL at least 50mm [1.97 in.] away from adjacent structures and other equipment. For the face to which the cable is connected, however, a space of 120 mm [4.72 in.] or more is necessary for cable curve.

Unit:mm[in.]

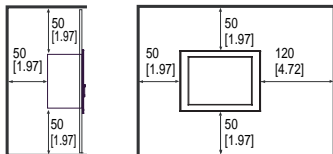

- Be sure that the surrounding air temperature and the ambient humidity are within their specified ranges.

When installing the PL on the panel of a cabinet or enclosure, “Surrounding air temperature” indicates both the panel face

and cabinet or enclosure’s internal temperature.

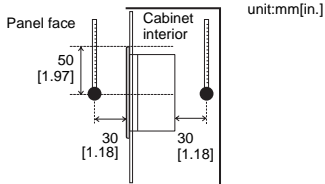

- Be sure that heat from surrounding equipment does not cause the PL to exceed its standard operating temperature.

Installation

- (1) Create a Panel Cut using the dimensions in the following table. Also, determine the panel thickness according to the panel thickness range with due consideration of panel strength.

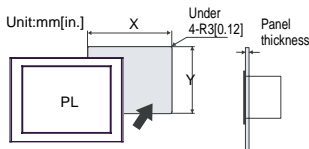

PL	X	Y	Panel thickness
PL-3600T Series	295.5 ⁺¹ ₋₀ [11.61 ^{+0.04} ₋₀]	243.5 ⁺¹ ₋₀ [9.59 ^{+0.04} ₋₀]	1.6[0.06] to 10.0[0.39]
PL-3600K/3700T Series	383.5 ⁺¹ ₋₀ [15.1 ^{+0.04} ₋₀]	282.5 ⁺¹ ₋₀ [11.12 ^{+0.04} ₋₀]	1.6[0.06] to 10.0[0.39]
PL-3700K Series	441.5 ⁺¹ ₋₀ [17.38 ^{+0.04} ₋₀]	313.5 ⁺¹ ₋₀ [12.34 ^{+0.04} ₋₀]	1.6[0.06] to 10.0[0.39]
PL-3900T Series	419.5 ⁺¹ ₋₀ [16.52 ^{+0.04} ₋₀]	352.5 ⁺¹ ₋₀ [13.88 ^{+0.04} ₋₀]	1.6[0.06] to 10.0[0.39]

NOTE

- When using the PL-3600K series to replace the 3612KPM/4612KPM from Xycom Automation, you can install the

unit without adjusting the Panel Cut size. As shown in the following diagram, simply remove 7 screws from the upper and lower positions to remove attachments from the PL-3600K series unit.

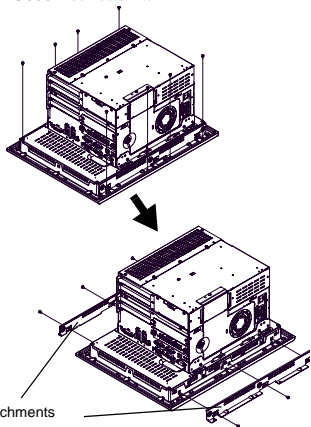

Panel Cut size without attachment

PL	X	Y	Panel thickness
PL-3600K Series (3612KPM/ 4612KPM compatible)	383.54 [15.10]	275.59 [10.85]	1.6[0.06] to 10.0[0.39]

- (2) Confirm that the installation gasket is attached to the PL unit and then place the PL unit into the panel from the front.

IMPORTANT

- It is strongly recommended that you use the installation gasket, since it absorbs vibration in addition to repelling water.

For the procedure for attaching the installation gasket, refer to "PL3000 Series Hardware Manual".

- (3) Insert each fastener's hook into the slot and tighten it with a screwdriver. Tighten the screws gradually in an even, criss-cross pattern.

The number of the slots varies depending on the model.

PL-3600T Series : 4 slots

PL-3600K/3700T Series: 8 slots

PL-3700K/3900T Series: 12 slots

Locations of the 4 slots

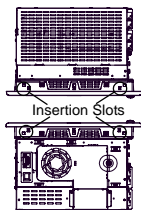

Locations of the 8 slots

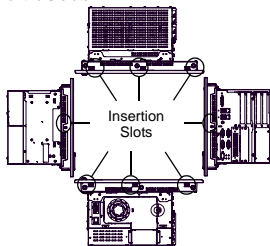

Locations of the 12 slots

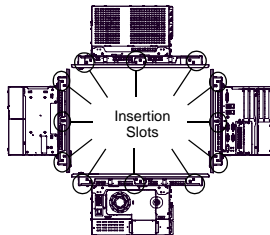

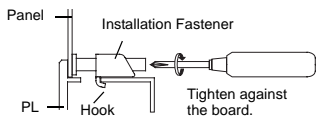

IMPORTANT

- Tightening the screws with too much force can damage the PL unit.
- The torque required to tighten these screws is $0.8 \text{ N}\cdot\text{m}$.

Installation/uninstallation of the front module and the control box

⚠ WARNING

- To avoid an electric shock, prior to installation/uninstallation of the front module and the control box, confirm that the PL unit's power supply is completely turned OFF, via a breaker, or similar unit.

1. Installation/uninstallation of the front module and the control box (PL-3600T Series)

■ Uninstalling

- (1) Unscrew the one attachment screw to detach the cover for the flexible cable.

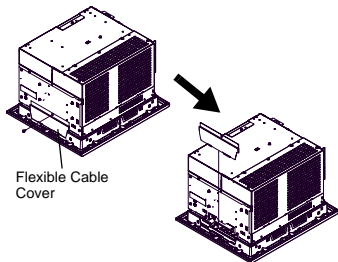

- (2) Disconnect the flexible cable.

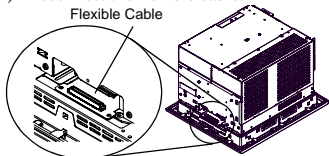

- (3) Unscrew the four attachment screws located at the top and bottom of the front module.

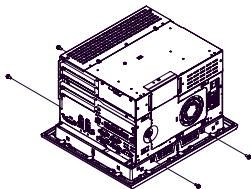

- (4) Detach the control box from the front module.

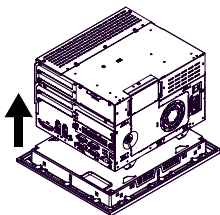

■ Installing

Install the control box to the front module in the reverse order of the uninstallation steps. The necessary torque is $0.5 \text{ N}\cdot\text{m}$ to $0.6 \text{ N}\cdot\text{m}$ in every step.

2. Installation/uninstallation of the front module and the control box (PL-3600K/3700*/3900T Series)

■ Uninstalling

- (1) Unscrew the two attachment screws to detach the cover for the flexible cable.

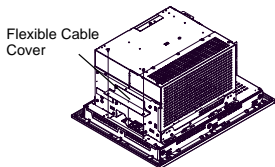

- (2) Disconnect the flexible cable.

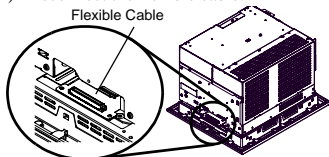

- (3) Remove four screws on the installation fasteners for the control box.

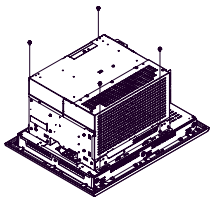

- (4) Slide the control box in direction shown by the arrow.

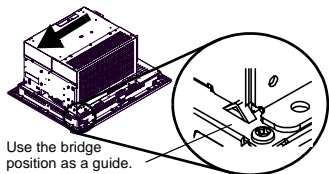

- (5) Lift the control box and remove the front module tabs from the slot on the installation fasteners for the control box. Then remove the control box.

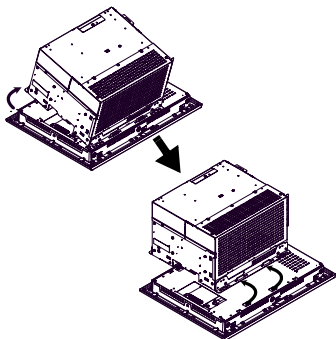

■ Installing

Install the control box to the front module in the reverse order of the uninstallation steps. The necessary torque is $0.5\text{N}\cdot\text{m}$ to $0.6\text{N}\cdot\text{m}$ in every step.

Wiring

⚠ WARNING

- To avoid an electric shock, prior to connecting the PL unit's power cord terminals to the power terminal block, confirm that the PL unit's power supply is completely turned OFF, via a breaker, or similar unit.
- Any other power level can damage both the PL and the power supply.
- Since DC type has no power ON/OFF switch, be sure to attach a breaker-type switch to its power cord.
- When the FG terminal is connected, be sure the wire is grounded.

■ Power Connector

The following parts are used in the power connector (plug).

	Accompanying Power Connector	Shape
AC type	CA7-ACCNL-01 of Pro-face	Straight Spring
	FKC 2,5/3-STF-5,08 of Phoenix Contact	

When PL is mounted vertically, a right-angle power connector is recommended. Use the following right-angle power connectors.

	Optional Power Connector	Shape
AC type	CA7-ACCNL-01 of Pro-face	Right-angle Spring
	FKCVR 2,5/3-STF-5,08 of Phoenix Contact	

1. Wiring power cords with a spring-type power connector

IMPORTANT

- When the FG terminal is connected, be sure the wire is grounded. Not grounding the PL unit will result in excessive noise. Use your country's applicable standard for grounding.

■ Power Cord Specifications

Use copper conductors only.

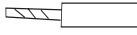
Power Cord Diameter	0.75 to 2.5mm ² (18 - 12 AWG)
Conductor Type	Simple or Stranded Wire*1
Conductor Length	10mm [0.39in] 

*1 If the Conductor's end (individual) wires are not twisted correctly, the end wires may either short against each other, or against an electrode.

■ Wiring

When connecting the power code, use the following items when performing wiring. (Items are made by Phoenix Contact.)

Recommended Driver	SZS 0.6x3.5 (1205053)
Recommended Pin Terminals	AI 0.75-10GY (3201288) AI 1-10RD (3200182) AI 1.5-10BK (3200195) AI 2.5-12BU (3200962)
Recommended Pin Terminal Crimp Tool	CRIMPFOX ZA3 (1201882)

■ Connecting the Power Cord

- (1) Confirm that the power is not supplied to the PL unit.
- (2) Push the Opening button with a small slot screw driver to open the desired pin hole.
- (3) Insert each pin terminal into its each hole. Release the Opening button to clamp the pin place.

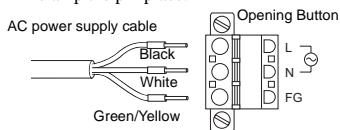

- (4) After inserting all three pins, insert the Power Plug into the Power Connector at PL. Fix the plug with two minus screws.

IMPORTANT

- Confirm that all wires are connected correctly.
- The torque required to tighten these screws is 0.5 to 0.6 N•m.
- To prevent the possibility of a terminal short, use a pin terminal that has an insulating sleeve.

2. Power Supply Cautions

- Input and Output signal lines must be separated from the power control cables for operational circuits.

- To improve the noise resistance, be sure to twist the ends of the power cord wires before connecting them to the Power connector (Plug).
- The PL unit's power supply cord should not be bundled with or kept close to main circuit lines (high voltage, high current), or input/output signal lines.
- To reduce noise, make the power cord as short as possible.
- If the supplied voltage exceeds the PL unit's range, connect a voltage transformer.
- Between the line and ground, select a power supply that is low in noise. If there is an excess amount of noise, connect an insulating transformer.
- The temperature rating of field installed conductors: 75°C only.
- The SG (signal ground) and FG (frame ground) terminals are connected internally in the PL unit. When connecting the SG line to another device, be sure that the design of the system/connection does not produce a shorting loop.
- The grounding wire should have a cross sectional area greater than 2mm². Create the connection point as close to the PL unit as possible, and make the wire as short as possible. When using a long grounding wire, replace the thin wire with a thicker wire, and place it in a duct.

IMPORTANT

- Use constant voltage and insulating transformers with capacities exceeding Power Consumption value.
- Connect a surge absorber to handle power surges.

IMPORTANT

- Be sure to ground the surge absorber (E1) separately from the PL unit (E2). Select a surge absorber that has a maximum circuit voltage greater than that of the peak voltage of the power supply.

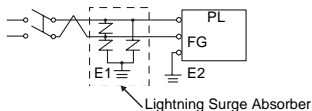

3. Grounding Cautions

- Be sure to create an exclusive ground for the Power Cord's FG terminal. Use a grounding resistance of 100Ω, a wire of 2mm² or thicker, or your country's applicable standard.

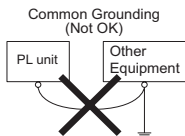
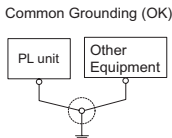
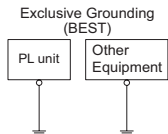

4. Input/Output Signal Line Cautions

- All PL Input and Output signal lines must be separated from all operating circuit (power) cables.
- If this is not possible, use a shielded cable and ground the shield.
- To improve noise immunity, it is recommended to attach a ferrite core to the power cord.

Connecting USB Cable Clamp

■ Attaching the USB Cable Clamp

- (1) Place the PL unit face-down on a flat surface as shown below. Your PL unit has four USB connectors.

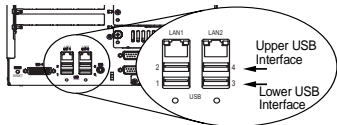

to keep the clamp from interfering with nearby connectors and their cables.

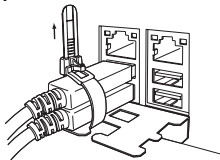

■ Removing the USB Cable Clamp

- (1) To remove the clamp from the USB cables, push down on the clamp strap's clip to release it while pulling up on the clamp.

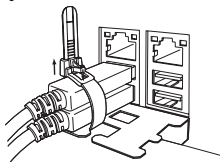

NOTE

- When using two or more USB ports, be sure to first connect one USB cable to the lower USB connector, and then connect the second USB cable to the upper USB connector.
 - When using only one of the USB ports, be sure to use the lower USB connector. This allows you to securely clamp the USB cable in the cable clamp.
- (2) Fix the USB holder with two screws. The torque required to tighten these screws is 0.5 to 0.6 N•m.

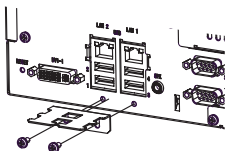

- (3) As the figure shows, pass the USB Cable Clamp's band around the depressed surface of the holder, twist the USB Cable Clamp's band around the USB cable, pull the band in the direction of the arrow, and then fasten the band using the clamp.

NOTE

- Be sure the clamp is securely holding the USB cable's plug and collar.
- Be sure the clamp is positioned as shown in the following image, with the clamp pointing upwards - not to the side. This is

Installation prerequisites for standards

The following units are UL/c-UL recognized products:

(UL File No.E171486)

■ Built-in battery unit version

Product Model No.	UL/c-UL Registration Model No.
APL3000-BA	3582302-02
APL3600-TA	3582302-02 Front Module: 3620003-01
APL3700-TA	3582302-02 Front Module: 3620003-02
APL3900-TA	3582302-02 Front Module: 3620003-03
APL3600-KA	3582302-02 Front Module: 3620003-04
APL3700-KA	3582302-02 Front Module: 3620003-05

- Built-in battery unit and DVD unit version

Product Model No.	UL/c-UL Registration Model No.
APL3000-BA	3582302-03
APL3600-TA	3582302-03 Front Module: 3620003-01
APL3700-TA	3582302-03 Front Module: 3620003-02
APL3900-TA	3582302-03 Front Module: 3620003-03
APL3600-KA	3582302-03 Front Module: 3620003-04
APL3700-KA	3582302-03 Front Module: 3620003-05

For the detailed certification's information, refer to the Pro-face Home page.

<Cautions>

Be aware of the following items when building the PL into an end-use product:

PL-3000B Series

- The PL unit is approved as an open-type unit.
- Install the PL unit on a flat surface. Create space between the PL unit, the structure that the PL unit is attached to and immediate parts according to the mounting conditions. The temperature must be checked on the final product in which the PL is installed.

PL-3600*/3700*/3900T Series

- The PL unit's rear face is not approved as an enclosure. When building the PL unit into an end-use product, be sure to use an enclosure that satisfies standards as the end-use product's overall enclosure.
- The PL unit must be used indoors only.
- Install and operate the PL with its front panel facing outwards.
- If the PL is mounted so as to cool itself naturally, be sure to install it in a vertical panel. Also, according to the installation requirements, create space around the rear face of the PL unit. The temperature must be checked on the final product in which the PL unit is installed.

- For use on a flat surface of a Type 1 Enclosure.

CE Marking

- The following units are CE marked, EMC directives and Low Voltage Directive compliant products.
APL3000-BA, APL3600-TA,
APL3700-TA, APL3900-TA,
APL3600-KA, APL3700-KA

For the detailed information, be downloaded and refer the Declaration of Conformity from Pro-face Home Page.

Inquiry

Do you have any questions or comments about this product?
Please access our site anytime you need help with a solution.

<http://www.pro-face.com/otasuke/>

Note

Please be aware that Digital Electronics Corporation shall not be held liable by the user for any damages, losses, or third party claims arising from the uses of this product.

