

Essential Safety Precautions



■ System Design

- Do not create PS-3650A/PS-3651A (hereafter referred to as the “PS-A”) touch panel switches that could possibly endanger the safety of personnel or equipment. A malfunction of the PS-A unit, its I/O unit(s), cable(s), or other related equipment can cause unexpected output signals, leading to a serious accident. Be sure to design all important machine operation switches so they are operated via a separate control system, and not via the PS-A.
- Do not create PS-A touch panel switches to control machine safety operations, such as an emergency stop switch. Install these switches as separate hardware switches, otherwise severe bodily injury or equipment damage can occur.
- Be sure to design your system so that a communication fault between the PS-A and its host controller will not cause equipment to malfunction. This is to prevent any possibility of bodily injury or equipment damage.
- Do not use the PS-A as a warning device for critical alarms that can cause serious operator injury, machine damage or can halt system operation. Critical alarm indicators and their control/activator units must be designed using stand-alone hardware and/or mechanical interlocks.
- Do not use the PS-A with aircraft control devices, aerospace equipment, central trunk data transmission (communication) devices, nuclear power control devices, or medical life support equipment, due to these devices’ inherent requirements of extremely high levels of safety and reliability.
- Be sure to use redundant and/or failsafe system designs to ensure adequate levels of system reliability and safety when using the PS-A with transportation vehicles (trains, cars and ships), disaster and crime prevention devices, various types of safety equipment, non-life support related medical devices, and other similar equipment.
- After the PS-A unit’s backlight burns out the touch panel is still active, unlike the PS-A unit’s “Standby Mode”. If the operator fails to notice that the backlight is burned out and touches the panel, a potentially dangerous machine operation error can occur. Therefore, do not create PS-A unit touch panel switches that may cause injury and/or equipment damage. If your PS-A unit’s backlight suddenly turns OFF, use the following steps to determine if the backlight is actually burned out.
 - 1) If the PS-A unit’s “Backlight Control” is not set and the screen has gone blank, your backlight is burned out.
 - 2) If the PS-A unit’s “Backlight Control” is set to Standby Mode and the screen has gone blank, and touching the screen or performing another input operation does not cause the display to reappear, your backlight is burned out.

■ Handling

- Do not modify the PS-A unit. Doing so may cause a fire or an electric shock.
- Do not operate the PS-A in an environment where flammable gases are present, since it may cause an explosion.

■ Wiring

- To prevent an electric shock be sure to disconnect your PS-A unit’s power cord from the power supply before wiring the PS-A.
- Do not use voltage beyond the PS-A unit’s specified range. Doing so may cause a fire or an electric shock.

■ Maintenance

- Do not connect or disconnect Host and PS-A unit communication cables while the PS-A is turned ON.
- The PS-A uses a lithium battery for backing up its internal clock data and the battery may explode if it is replaced incorrectly. When replacement is required, use a Pro-face designated product.

⚠ CAUTION

■ Installation

- Be sure all cable connectors are securely attached to the PS-A unit. A loose connection may cause incorrect input or output signals.

■ Wiring

- Be sure to ground the PS-A unit's FG wire separately from other equipment FG lines. Also, be sure to use a grounding resistance of 100Ω or less and a 2mm^2 or thicker wire, or your country's applicable standard. Otherwise, electric shock or malfunctions may result.
- Be sure to use only the designated torque to tighten the PS-A unit's terminal block screws. If these screws are not tightened firmly, it may cause a short-circuit, fire or incorrect unit operation.
- Be sure that metal particles and wiring debris do not fall inside the PS-A unit. They can cause a fire, malfunction or incorrect unit operation.

■ Maintenance

- Do not reset or turn the PS-A OFF, or insert or remove the CF Card while the PS-A unit's CF Card or hard disk is being accessed. Otherwise, CF Card and the hard disk internal data may be damaged or lost.

■ Unit Disposal

- When the product is disposed of, it should be done so according to your country's regulations for similar types of industrial waste.

■ General Safety Precautions

- Do not press on the PS-A unit's display with excessive force or with a hard object, since it can damage the display. Also, do not press on the touch panel with a pointed object, such as the tip of a mechanical pencil or a screwdriver, since doing so can damage the touch panel.
- Do not install the PS-A where the ambient temperature exceeds the specified range. Doing so may cause a unit malfunction.
- To prevent abnormally high temperatures from occurring inside the PS-A, do not restrict or block the PS-A unit's rear-face ventilation slots.
- Do not allow water, liquids or metal fragments to enter inside the PS-A unit's case, since they can cause either a malfunction or an electric shock. For use in pollution degree 2 environment.
- Do not operate or store the PS-A in locations where it can be exposed to direct sunlight, high temperatures, excessive dust, moisture or vibration.
- Do not operate the PS-A in areas where large, sudden temperature changes can occur. These changes can cause condensation to form inside the PS-A, possibly causing it to malfunction.
- Do not operate or store the PS-A where chemicals evaporate, or where chemicals are present in the air.

Corrosive chemicals	: Acids, alkalines, liquids containing salt
Flammable chemicals	: Organic Solvents
- Do not use paint thinner or organic solvents to remove dirt or oil from the PS-A unit's surface. Instead, use a soft cloth moistened with a diluted neutral detergent.
- Do not use or store the PS-A in areas with direct sunlight, since the sun's ultraviolet rays may cause the LCD's quality to deteriorate.

- Do not store the PS-A in an area where the temperature is lower than that recommended in the PS-A unit's specifications. Doing so may cause the LCD display's liquid to congeal, which can damage the LCD. Also, if the storage area's temperature becomes higher than the specified level, the LCD's liquid may become isotropic, causing irreversible damage to the LCD. Therefore, only store the PS-A in areas where temperatures are within the PS-A unit's specifications.
- After turning OFF the PS-A, be sure to wait a few seconds before turning it ON again. The PS-A may not operate correctly if it is restarted too quickly.
- Due to the possibility of unexpected accidents, be sure to back up the PS-A unit's data regularly.

■ LCD Panel Usage Precautions

- The LCD panel's liquid contains an irritant. If the panel is damaged and any of this liquid contacts your skin, immediately rinse the area with running water for at least 15 minutes. If the liquid gets in your eyes, immediately rinse your eyes with running water for at least 15 minutes and consult a doctor.
- The PS-A unit's LCD screen may flicker or show unevenness in the brightness of certain images or at some contrast settings. This is an LCD characteristic and not a product defect.
- There is an individual difference in brightness and tone of LCD screen. Please be aware of this difference before using the lined-up plural units.
- Depending on the ambient temperature, LCD screens may sometimes look whitish (at high temperatures) or blackish (at low temperatures). This is an LCD characteristic and not a product defect.
- Some of PS-A unit's LCD screens may contain black and white colored pixels. This is an LCD characteristic and not a product defect.
- Extended shadows, or "Crosstalk" may appear on the sides of screen images. This is an LCD characteristic and not a product defect.
- The color displayed on the PS-A unit's LCD screen may appear different when seen from outside the specified viewing angle. This is an LCD characteristic and not a product defect.
- When the same image is displayed on the PS-A unit's screen for a long period, an afterimage may appear when the image is changed. If this happens, turn off the PS-A, wait 10 seconds and then restart the unit. This is an LCD characteristic and not a product defect.
- To prevent an afterimage:
 - * Set the PS-A unit's display OFF feature when you plan to display the same screen image for a long period of time.
 - * Change the screen image periodically and try to not display the same image for a long period of time.

UL/CSA Approval

The following units are UL/CSA listed products (UL File No. E220851/CSA File No. 219866).

Product Model No.	UL/CSA Registration Model No.
PS3650A-T41	3480801-02
PS3651A-T41	3480801-01
PS3650A-T41-24V	3480801-12
PS3651A-T41-24V	3480801-11

This product conforms to the following standards:

UL508

Industrial Control Equipment

CSA-C22.2 No.142-M1987

Process Control Equipment

<Cautions>

Be aware of the following items when building the PS-A into an end-use product:

- The PS-A unit's rear face is not approved as an enclosure. When building the PS-A unit into an end-use product, be sure to use an enclosure that satisfies standards as the end-use product's overall enclosure.
- For use on a flat surface of a Type 4X (Indoor Use Only) and/or Type 12 Enclosure.
- The PS-A unit must be used indoors only.
- Install and operate the PS-A with its front panel facing outwards.
- If the PS-A is mounted so as to cool itself naturally, be sure to install it in a vertical panel. Also, it is recommended that the PS-A should be mounted at least 50mm away from any other adjacent structures or machine parts. The temperature must be checked on the final product in which the PS-A is installed.

CE Marking

PS3650A-T41/PS3651A-T41 are CE marked product that conforms to EMC directives and Low-voltage directive EN55011 Class A, EN61000-6-2 and EN60950.

PS3650A-T41-24V/PS3651A-T41-24V are CE marked product that conforms to EMC directives EN55011 Class A, and EN61000-6-2.

Package Contents

The following items are included in the PS-A unit's package. Before using the PS-A, please check that all items listed here are present.

PS-A Unit (1)

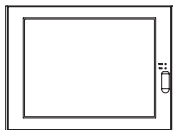

Installation Fasteners (4/set)

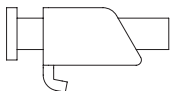

Power Plug (1) (Attached to the PS-A unit)

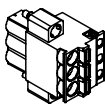

AC type
(5.08mm [0.2in.] pitch)

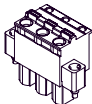

DC type
(7.62mm [0.3in.] pitch)

Installation Guide <This Guide> (1)

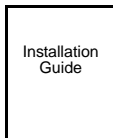

Installation Gasket (1) (Attached to the PS-A unit)



USB Holder (2 set) (USB holder (1), USB cover (2)) 2

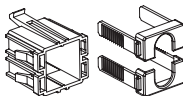

NOTE

- When you order a PS-A unit built to your specifications, that PS-A package should include each optional item's Installation Guide. Please use that guide to check the contents of each optional item's package.

IMPORTANT

- Be careful when installing the PS-A not to damage the built-in HDD.

This unit has been carefully packed, with special attention to quality. However, should you find anything damaged or missing, please contact your local PS-A distributor immediately.

About the Manual

For the detailed information on PS-A, refer to the following manuals.

- PS-3650A/PS-3651A User Manual
- API Reference Manual

Manual can be downloaded from Pro-face Home Page.

URL

<http://www.pro-face.com/otasuke/>

NOTE

- The drivers and utilities for PS-A can be downloaded from Pro-face Home Page.

Part Names

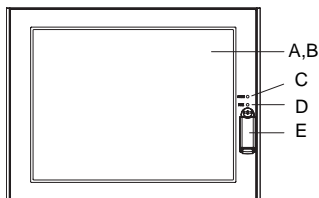

Front
(Common to PS-3650A and PS-3651A)

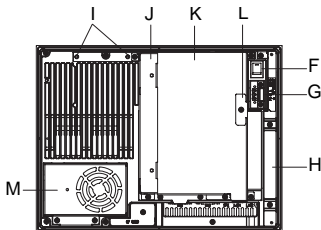

Back
(PS3650A-T41)

A: Display

B: Touch Panel

C: Power LED/RAS Status Lamp (POWER)

LED	PS-A Status
Green (lit)	Normal operation (power is ON).
Green (blinking)	Soft OFF state.
Orange (lit)	System monitor error / Touch panel SELF TEST error.
Orange/Red (blinking)	Backlight burnout is detected.
Off	Power is OFF.

D: HDD/IDE Access Lamp (DISK)

LED	PS-A Status
Green (lit)	When accessing HDD or IDE
Off	Non accessing

E: Front Cover

When you opened it, there are a hard ware reset switch (RESET) and a USB interface (corresponding to USB Ver.1.1) inside.

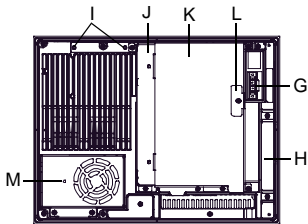

Back
(PS3650A-T41-24V)

F: Power Switch

Supported by AC type (PS3650A-T41/
PS3651A-T41) only.

G: Power Supply Connector

H: Mask Cover

I: RS-232C/485 converting unit hook holes

J: Expansion Board Base

K: Expansion Board Cover

L: Expansion Board Supporter

M: Fan Cover

N: Memory Slot Cover

O: IDE Cover

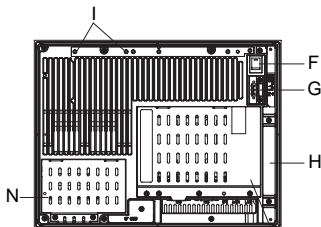

Back
(PS3651A-T41)

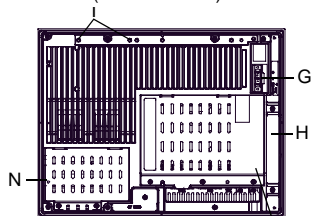

Back
(PS3651A-T41-24V)

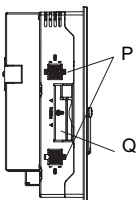

Left Side
(PS-3650A)

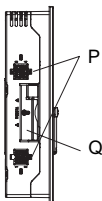

Left Side
(PS-3651A)

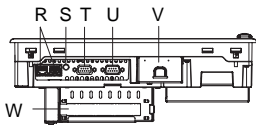

Bottom
(PS-3650A)

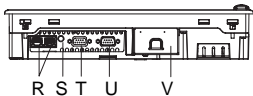

Bottom
(PS-3651A)

P: USB Interface (USB)

4 ports. Complies with USB 2.0 .

Uses a "TYPE-A" connector.

Power supply voltage	5V DC $\pm 5\%$
Output current	Each port: 500mA(max.), Total 5 ports (Front and Left): 500mA(max.)
The maximum communication distance	5m

Q: PCMCIA Slot Cover

R: Ethernet Interface (LAN)

S: Speaker output interface

T: RAS Interface (RAS)

U: Serial Interface (COM1)

(RI/+5V Switching available)

V: CF Card Cover

W: Expansion Slot

Specifications

■ Electrical

		PS3650A-T41 PS3651A-T41	PS3650A-T41-24V PS3651A-T41-24V
Power Supply	Input Voltage	AC100/240V	DC24V
	Rated Voltage	AC85V to 265V	DC19.2 to 28.8V
	Rated Frequency	50/60Hz	-
	Allowable Voltage Drop	1 cycle or less (Voltage drop interval must be 1s or more.)	5ms (max.)
	Power Consumption	PS-3650A:110VA (100W) (max.) PS-3651A:95VA (50W) (max.)	PS-3650A:80W or less PS-3651A:40W or less
	In-Rush Current	For AC100V (Ambient Temperature) :30A (max.) For AC240V (Ambient Temperature) :50A (max.)	30A (max.) (Ambient Temperature)
Voltage Endurance		AC1500V 20mA for 1 minute (between charging and FG terminals)	AC1000V 20mA for 1 minute (between charging and FG terminals)
Insulation Resistance		DC500V 10MΩ (min.) (between charging and FG terminals)	

■ Environmental

		PS-3650A	PS-3651A
Physical	Surrounding Air Temperature	0°C to 50°C (When using HDD: 5°C to 50°C)	0°C to 50°C (When using HDD: 5°C to 45°C)
	Storage Temperature	-20°C to +60°C	
	Ambient Humidity	10 to 90% RH (Not condensing, Wet bulb temperature: 39°C or less. Wet bulb temperature with HDD: 29°C or less.)	
	Storage Humidity	10 to 90% RH (Not condensing, Wet bulb temperature: 39°C or less.)	
	Dust	Free of dust	
	Pollution Degree	For use in Pollution Degree 2 environment	
	Atmosphere	Free of corrosive gases	
Mechanical	Vibration Resistance	<When vibration is NOT continuous> IEC61131-2 compliant 5 to 9Hz single-amplitude 3.5mm 9 to 150Hz constant-accelerated velocity 9.8m/s ² X, Y, Z directions for 10 cycles (100 minutes) <When vibration is continuous> 4.9m/s ² 10Hz to 25Hz X, Y, Z directions for 30 minutes	

Electrical	Noise Immunity (via noise simulator)	AC type	Noise Voltage: 1,500Vp-p (via noise simulator) Pulse Duration: 50ns, 500ns, 1µs Rise Time: 1ns
		DC type	Noise Voltage: 1,000Vp-p (via noise simulator) Pulse Duration: 50ns, 500ns, 1µs Rise Time: 1ns
	Electrostatic Discharge Immunity		6kV (complies with IEC61000-4-2 Level 3)
Noise Immunity (First transient burst noise)			Power Line:2kV IEC61000-4-4 COM Port:1kV IEC61000-4-4

IMPORTANT

- When using any of the PS-A is optional devices, be sure to check that device's specifications for any special conditions or cautions that may apply to its use.
- Be aware that not only does the Hard Disk have a fixed lifetime, but that accidents can always occur. Therefore, be sure to back up your Hard Disk's data regularly, or prepare another Hard Disk unit that can be used for backup.
- The Hard Disk lifetime given here may be reduced due to unforeseen environmental factors, however, generally speaking, the disk should last for 20,000 hours (of operation) or approximately 5 years, whichever comes first at an operating temperature of 20oC and 333 hours of operation per month. (HDD access frequency of 20% or less)
- Using the Hard Disk in an environment that is excessively hot and/or humid will shorten the disk's usage lifetime. A wet bulb temperature of 29°C or less is recommended. This is equivalent to the following data.

Temperature	Humidity
35°C	no higher than 64%RH
40°C	no higher than 44%RH

- In order to extend the lifetime of the hard disk, Pro-face recommends you set the Windows® [Control panel]-[Power Management option]-[Turn off hard disks] selection to turn the hard disk off when the unit is not being operated. A setting of 5 minutes is recommended.

■ Structural

		PS-3650A	PS-3651A
Installation	Grounding	Grounding resistance of 100 Ω , 2mm ² or thicker wire, or your country's applicable standard. (Same for FG and SG terminals)	
	Structure	Rating* ¹ : Equivalent to IP65f Installation method: Panel	
	Cooling Method	Forced cooling by fan	Natural air circulation
	Weight	Approx. 4.5kg [9.9lb.] (unit only)	Approx. 3.8kg [8.4lb.] (unit only)
	External Dimensions	W313mm [12.32in.] x H239mm [9.41in.] x D103mm [4.06in.]	W313mm [12.32in.] x H239mm [9.41in.] x D60mm [2.36in.]

- *1. The front face of the PS-A unit, installed in a solid panel, has been tested using conditions equivalent to the standards shown in the specification. Even though the PS-A unit's level of resistance is equivalent to these standards, oils that should have no effect on the PS-A can possibly harm the unit. This can occur in areas where either vaporized oils are present, or where low viscosity cutting oils are allowed to adhere to the unit for long periods of time. If the PS-A's front face protection sheet becomes peeled off, these conditions can lead to the ingress of oil into the PS-A and separate protection measures are suggested. Also, if non-approved oils are present, it may cause deformation or corrosion of the front panel's plastic cover. Therefore, prior to installing the PS-A be sure to confirm the type of conditions that will be present in the PS-A's operating environment.
- If the installation gasket is used for a long period of time, or if the unit and its gasket are removed from the panel, the original level of the protection cannot be guaranteed. To maintain the original protection level, be sure to replace the installation gasket regularly.

Interfaces

Serial Interfaces (COM1)

This interface is used to connect an RS-232C cable. A D-sub 9-pin plug connector is used.

IMPORTANT

- The PS-A unit's serial port is not isolated. When the host (PLC) unit is also not isolated, be sure to connect the #5 SG (Signal Ground) terminal to reduce the risk of damaging the RS-232C circuit.
- Inside the PS-A unit, the SG (Signal Ground) and FG (Frame Ground) terminals are connected.
- When connecting an external device to the PS-A using the SG terminal, be sure to check that no short-circuit loop is created when you setup the system.

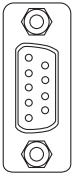
Stacking Metal Fittings		#4-40 UNC screws		
Pin Arrangement	Pin No.	Signal Name	Direction	Meaning
	1	CD	Input	Carrier Detect
	2	RD(RXD)	Input	Receive Data
	3	SD(TXD)	Output	Send Data
	4	ER(DTR)	Output	Data Terminal Ready
	5	SG	-	Signal Ground
	6	DR(DSR)	Input	Data Set Ready
	7	RS(RTS)	Output	Request to Send
	8	CS(CTS)	Input	Send Possible
	9	CI(RI)/ 5V*1	Input / -	Called status display / +5V±5% Output
	Shell	FG	-	Frame Ground (Common with SG)

*1. The RI/5V changeover of the #9 pin is possible via the switch on the board.

IMPORTANT

- Whenever changing RI/5V setting switch, be sure to first turn the PS-A's power supply OFF.

◆ Switch

The RI/5V changeover switch corresponding to the serial interface is found on the board after removing the Fan Cover or the Memory Slot Cover.

SEE → For how to remove the Fan Cover and the Memory Slot Cover, refer to “3.3.1 Installation of Memory Module” of the “PS-3650A/PS-3651A User Manual”.

Internal enlarged illustration

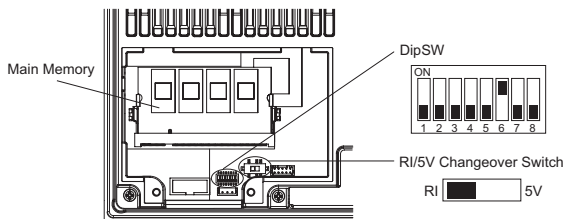

<RI/5V Changeover Switch>

This can change RI/5V setting switch of the #9 pin of RS-232C. The factory setting is [RI].

<Dip SW>

SW No.	Description	ON	OFF	Note
1	Used by the system.	Reserved	Reserved	The factory setting is OFF.
2				
3				
4	Able to set up an enabled/disabled state for the hardware reset switch ^{*1} .	Disabled	Enabled	The factory setting is OFF.
5	Used by the system.	Reserved	Reserved	The factory setting is OFF.
6	Able to set up an enabled/disabled state for the front USB. ^{*2 *3}	Enabled	Disabled	The factory setting is ON.
7	Able to change a Master/Slave setting for CF card slot.	Master	Slave	The factory setting is OFF. ^{*4}
8	Used by the system.	Reserved	Reserved	The factory setting is OFF.

*1. When the SW is ON, the hardware reset switch is unavailable. But it is available to reset from the Soft OFF state.

*2. The mask function to USB port is available for only Windows[®]2000 and Windows[®]XP. Make sure to disable the function of the setting when other OS used.

*3. When the SW is OFF, the front USB port is not available.

*4. When built in Pro-face's Windows[®]XP Embedded, the factory setting is ON.

■ RAS Interface

RAS Interface. A D-sub 9-pin socket connector is used.

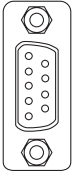
Stacking Metal Fittings		#4-40 UNC screws	
Pin Arrangement	Pin No.	Signal Name	Meaning
	1	+12V	100mA
	2	DOU0 (+)	Data Output 0 (+)
	3	DOU1 (+)	Data Output 1 (+)
	4	DIN0 (+)	Data Input 0(+)
	5	DIN1 (+)	Data Input 1 (+) or Remote Reset Input
	6	GND	SG (same as FG)
	7	DOU0 (-)	Data Output 0 (-)
	8	DOU1 (-)	Data Output 1 (-)
	9	DINCOM	DIN GND Common



For the circuit diagram, refer to “6.1.2 RAS Function - Details“ of the “PS-3650A/PS-3651A User Manual“.

■ Ethernet Interface

The Ethernet transmission interface conforms to IEEE802.3u (10BASE-T/100BASE-TX). An RJ-45 type modular jack connector (8-pole) is used.

■ CF Card Interface

1 port. CF card slot (Type II). For inserting a CF Card (supporting Type I).

■ USB Interface

Connect a USB connectable device here. (TYPE-A conn.)

USB port (4) on PS-A Left Side conforms to USB2.0.

USB port (1) on PS-A Front conforms to USB1.1.

■ Expansion Board Interface (PS-3650A only)

Used to connect a PCI board.

■ PCMCIA / Card Bus Interface

For inserting a PC Card.

■ Speaker Output Interface

Used to connect a speaker. This interface uses a mini-pin jack-type connector.

Dimensions

■ PS-3650A Dimensions (With Installation Fastener)

The following dimensions apply to all PS-3650A units.

The following drawings show the PS3650A-T41 (AC type).

Unit: mm [in.]

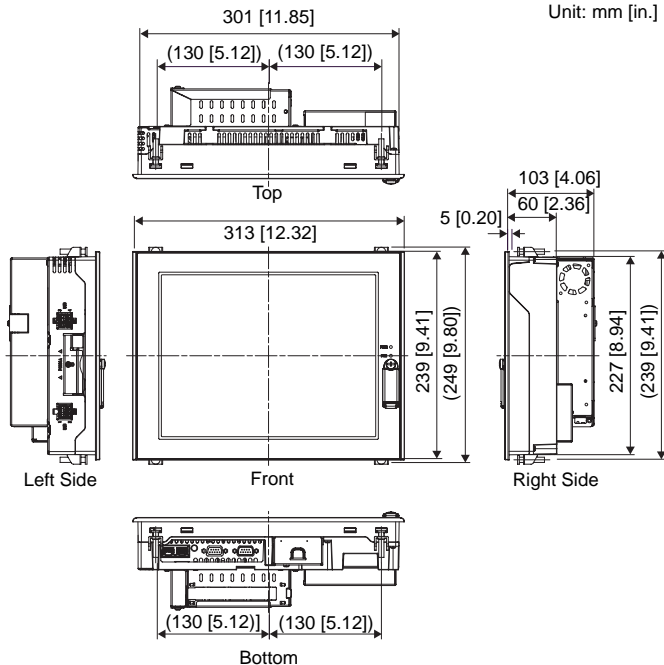

■ PS-3651A Dimensions (With Installation Fastener)

The following dimensions apply to all PS-3651A Series units.

The following drawings show the PS3651A-T41 (AC type).

Unit: mm [in.]

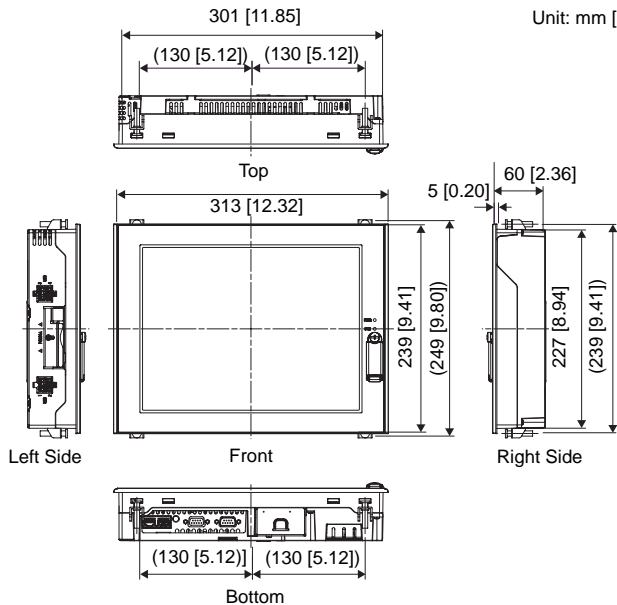

Installing

1 Installation Requirements

- For easier maintenance, operation, and improved ventilation, be sure to install the PS-A at least 50 mm [1.97 in.] away from adjacent structures and other equipment.

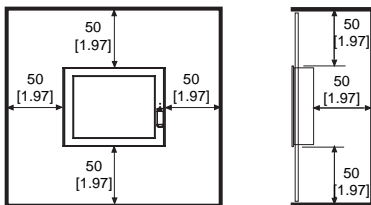

Unit: mm [in.]

- Be sure that the ambient operation temperature and the ambient humidity are within their designated ranges. (Ambient operation temperature: 0 to 50°C, Ambient humidity: 10 to 85% RH, Wet bulb temperature: 29°C max.) When installing the PS-A on the panel of a cabinet or enclosure, “Ambient operation temperature” indicates both the panel face and cabinet or enclosure’s internal temperature.

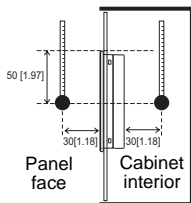

Unit: mm [in.]

- Be sure that heat from surrounding equipment does not cause the PS-A to exceed its standard operating temperature.
- When installing the PS-A in a slanted panel, the panel face should not incline more than 30°.

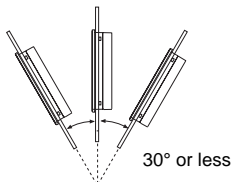

- When installing the PS-A in a slanted panel, and the panel face inclines more than 30°, the ambient temperature must not exceed 40°C. You may need to use forced air cooling (fan, A/C) to ensure the ambient operating temperature is 40°C or below.

- The PS-A Series unit does not support longitudinal mounting.

2 Installing the PS-A unit in a Panel

The PS-A unit is designed to be installed in a Panel. Refer to the following procedure to mount the PS-A unit.

- (1) Create a Panel Cut on the Panel surface as shown in the panel cut dimensions illustration. Also, determine the panel thickness according to the panel thickness range with due consideration of panel strength.

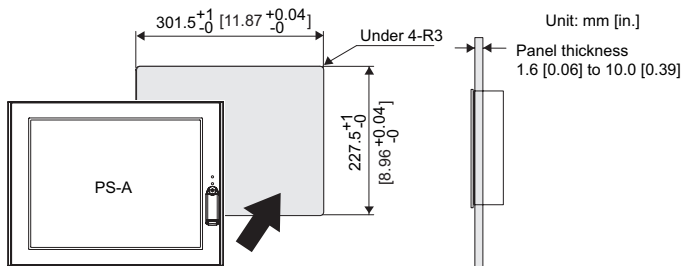

- (2) Confirm that the installation gasket is attached to the PS-A unit and then place the PS-A unit into the Panel from the front.

IMPORTANT

- It is strongly recommended that you use the installation gasket, since it absorbs vibration in addition to repelling water.

SEE →

For the procedure for replacing the installation gasket, refer to “PS-3650A / PS-3651A User Manual”.

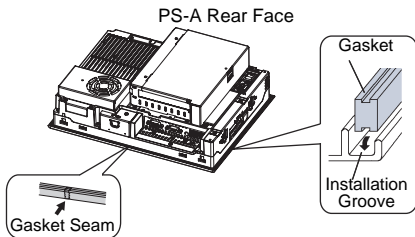

- (3) Insert the hook of the installation fastener into the insertion slot of the PS-A unit and tighten the back of the installation fastener using a screwdriver. For the position of the insertion slot, refer to the dimension illustration.

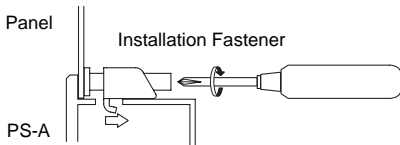

IMPORTANT

- Be sure to insert installation fasteners in the recessed portion of a installation fasteners hole. (Refer to the following figure.) If the fasteners are not correctly attached, the PS-A unit may shift or fall out of the panel.



- Tightening the screws with too much force can damage the PS-A unit's plastic case.
- The torque required to tighten these screws is 0.5 N•m.

NOTE

- The installation fastener's model number is CA3-ATFALL-01.

Wiring

⚠ WARNING

■ Wiring

- To avoid an electric shock, prior to connecting the PS-A unit's power cord terminals to the power terminal block, confirm that the PS-A unit's power supply is completely turned OFF, via a breaker, or similar unit.
- Supplying a power voltage other than that specified will damage the power source and the PS-A unit.
- Since PS3650A-T41-24V/PS3651A-T41-24V have no power ON/OFF switch, be sure to attach a breaker-type switch to its power cord.
- When the FG terminal is connected, be sure the wire is grounded.

1 Wiring for the PS-A unit

IMPORTANT

- When the FG terminal is connected, be sure the wire is grounded. Not grounding the PS-A unit will result in excessive noise. Use your country's applicable standard for grounding.

■ Power Cord Specifications

Use copper conductors only.

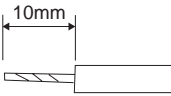
Power Cord Diameter	0.75 to 2.5mm ² (18 to 12 AWG)
Conductor Type	Simple or Twisted Wire [†]
Conductor Length	

*1 If the Conductor's end (individual) wires are not twisted correctly, the end wires may either short against each other, or against an electrode.

■ Wiring

When connecting the power cord, use the following items when performing wiring. (Items are made by Phoenix Contact.)

Recommended Driver	SZS 0.6X3.5 (1205053)
Recommended Pin Terminals	AI 0.75-10GY (3201288) AI 1-10RD (3200182) AI 1.5-10BK (3200195) AI 2.5-12BU (3200962)
Recommended Pin Terminal Crimp Tool	CRIMPFOX ZA3 (1201882)

NOTE

- Accompanying AC type power supply connector (straight) is CA7-ACCNL-01 of Pro-face or FKFC2.5/3-STF-5.08 is manufactured by Phoenix Contact.
- Accompanying DC type power supply connector (straight) is CA7-DCCNL-01 of Pro-face or GFKC2.5/3-STF-7.62 is manufactured by Phoenix Contact.

■ Connecting the Power Cord

- (1) Confirm that the power cord is unplugged from the power supply.
- (2) Unplug the power connector from the rear of the PS-A unit.
- (3) Push the Opening button by a small and flat screw driver to open the desired pin hole.
- (4) Insert each pin terminal into its each hole. Release the Opening button to clamp the pin place.

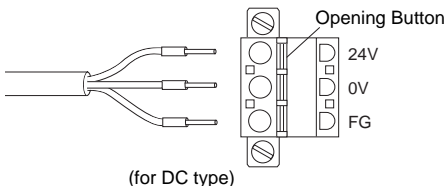
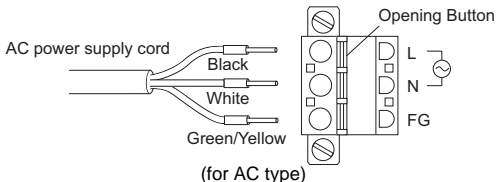

- (5) After inserting all three pins, insert the Power Plug into the Power Connector at PS-A. Fix the plug with two(2) minus screws.

IMPORTANT

- Confirm that all wires are connected to AC type power supply connector correctly.
- The torque required to tighten these screws is 0.5 to 0.6N•m.
- To prevent the possibility of a terminal short, use a pin terminal that has an insulating sleeve.

2 Power Supply Cautions

- When supplying power to the PS-A unit, please separate the input/output and operation unit lines.
- To increase the noise resistance quality of the power cord, simply twist each power wire before attaching the Ring Terminal.
- The power cord must not be bundled or positioned close to main circuit lines (high voltage, high current), or input/output signal lines.
- To avoid excess noise, make the power cord as short as possible.
- If the supplied voltage exceeds the PS-A unit's range, connect a constant voltage transformer.
- For between the line and ground, select a power supply that is low in noise. If there is an excess amount of noise, connect a noise reducing transformer.

- The temperature rating of field installed conductors : 75°C only.

IMPORTANT

- Use Voltage and noise reducing transformers with capacities exceeding Power Consumption value.
- Connect a surge absorber to handle power surges.

- Connect a lightning surge absorber, as shown in the diagram, to deal with power surges.

IMPORTANT

- Be sure to ground the surge absorber (E1) separately from the PS-A unit (E2).
- Select a surge absorber that has a maximum circuit voltage greater than that of the peak voltage of the power supply.

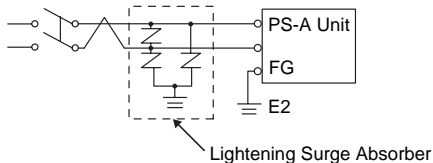

3 Grounding Cautions

- Be sure to create an exclusive ground for the power cord's FG terminal. Check that the grounding resistance is less than 100 Ω
- Inside the PS-A unit, the SG (Signal Ground) and FG (Frame Ground) terminals are connected. When connecting an external device to the PS-A using the SG terminal, be sure to check that no short-circuit loop is created when you setup the system.
- The grounding wire should have a cross sectional area greater than 2mm². Create the connection point as close to the PS-A unit as possible, and make the wire as short, as possible. When using a long grounding wire, replace the thin wire with a thicker wire, and place it in a duct.

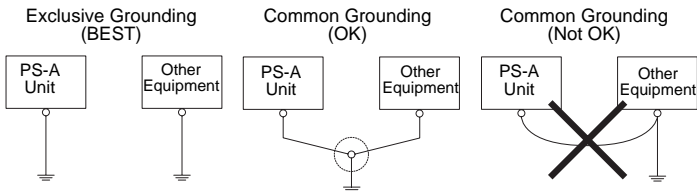

4 Input/Output Signal Line Cautions

- Input and output signal lines must be separated from the power control cables for operating circuits.
- If this is not possible, use a shielded cable and connect the shield to the PS-A unit's frame.
- To improve noise immunity, it is recommended to attach a ferrite core to the power cord.

Peripheral Devices Installation

1 USB holder Attachment/Removal

When using the USB device, attaching the USB holder prevents the USB cable from becoming disconnected.

■ Attachment

- (1) Attach the USB holder to the USB Host Interface part of the main unit.
Hook the upper pick of the USB holder to the attachment hole of the main unit and then insert the lower pick as shown below to fix the USB holder.

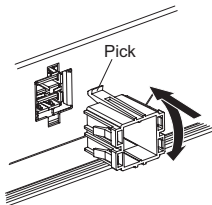

- (2) Insert the USB cable into the USB Host Interface.

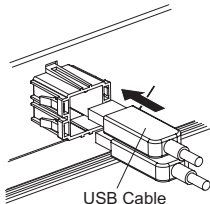

- (3) Attach the USB cover to fix the USB cable. Insert the USB cover into the tab of the USB holder.

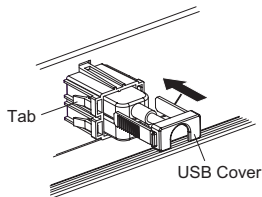

In case of installing the second USB cable, repeat the step2, 3.

■ Removal

(1) Lift up the tab of the USB holder and then remove the USB cover as shown below.

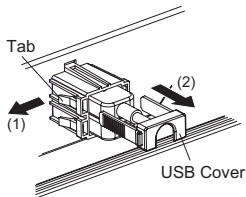

(2) After removing the USB cable, remove the picks pushing the USB holder from both top and bottom.

Replacing the Backlight

The PS-A's backlight can be replaced after it wears out. For the procedure for replacing the backlight, refer to "PS-3650A/PS-3651A User Manual". The backlight's model number is CA5-BLU12XGA-01.

Note

Please be aware that Digital Electronics Corporation shall not be held liable by the user for any damages, losses, or third party claims arising from the uses of this product.

© Copyright 2007 Digital Electronics Corporation. All rights reserved.