

Pro-face®

PS-3650A / PS-3651A Series

Reference Manual

NOTES

- (1) The copyrights to all programs and manuals included in the “PS-3650A/PS-3651A” (hereinafter referred to as “PS-A”) are reserved by the Digital Electronics Corporation. Digital grants the use of PS-A to its users as described in the “Software Operating License Conditions” documentation. Any actions violating the above-mentioned conditions are prohibited by both Japanese and foreign regulations.
- (2) The contents of this manual have been thoroughly inspected. However, if you should find any errors or omissions in this manual, please inform your local PS-A representative of your findings.
- (3) Regardless of article (2), the Digital Electronics Corporation shall not be held responsible for any damages or third party claims resulting from the use of PS-A.
- (4) Differences may occur between the descriptions found in this manual and the actual functioning of PS-A. Therefore, the latest information on PS-A is provided in data files (i.e. Readme.txt files, etc.) and in separate documents. Please consult these sources as well as this manual prior to using the product.
- (5) Even though the information contained in and displayed by PS-A may be related to intangible or intellectual properties of the Digital Electronics Corporation or third parties, the Digital Electronics Corporation shall not warrant or grant the use of said properties to any users and/or other third parties. Digital Electronics Corporation accepts no liability for issues related to the intellectual property rights of third parties or any issues related to the use of the information contained in or displayed by PS-A.

Information Symbols

This manual uses the following icons:

IMPORTANT	Indicates a warning or a product limitation. Be sure to follow the instructions given with this icon to ensure the safe operation of the PS-A.
NOTE	Contains additional or useful information.
(1) (2)	Indicates steps used to accomplish a given task. Be sure to follow these steps in the order they are written.
*	Indicates useful or important supplemental information.
SEE → 	Indicates pages containing related information.

PS-3650A/PS-3651A Series Model Names

The following models will be referred to as the PS-3650A/PS-3651A Series in this manual.

Series	Models
PS-3650A Series	PS3650A-T42
	PS3650A-T42S
	PS3650A-T42-24V
	PS3650A-T42S-24V
PS-3651A Series	PS3651A-T42
	PS3651A-T42S
	PS3651A-T42-24V
	PS3651A-T42S24V

NOTE

- For other PS-3650A/PS-3651A Series models not listed above, refer to the pdf version of the manual below.
 - PS-3650A/PS-3651A Users Manual

Download the manual from the Pro-face support site "Otasuke Pro!".

URL <http://www.pro-face.com/otasuke/>

About Pre-installed OS

The following Operating Systems are provided as the Pre-installed OS for PS-3650A/PS-3651A Series.

OS		Language			
Windows® XP	Japanese	Japanese			
	ML	Chinese (Simplified)	French	Portuguese (Brazil)	Estonian
		Chinese (Traditional)	German	Russian	Latvian
		Czech	Greek	Spanish	Lithuanian
		Danish	Hungarian	Swedish	Romanian
		Dutch	Italian	Turkish	Slovak
		English	Polish	Bulgarian	Slovenian
		Finnish	Portuguese	Croatian	Thai
Windows® XP Embedded	ML	SEE →	"Windows® XP Embedded Reference Manual"		

Contents

NOTES	1
Information Symbols	2
PS-3650A/PS-3651A Series Model Names	2
About Pre-installed OS	2
Contents	3
Setup operation flow.....	5
Chapter 1 Setting Up Software	
1.1 Software Configuration	1-2
1.2 Setting Up an HDD with no Pre-installed OS.....	1-2
1.2.1 Setting Up the OS.....	1-2
1.2.2 Setting Up the PS-A Dedicated Software	1-2
1.3 Setting Up an HDD with Pre-installed OS.....	1-4
1.3.1 Setting Up OS.....	1-6
1.4 PS-A Dedicated Software	1-9
1.4.1 Driver	1-9
1.4.2 Special Application Program Features.....	1-11
Chapter 2 System Setup	
2.1 System Setup Screen Operation	2-2
2.2 System Parameters Setting	2-4
2.2.1 Main	2-4
2.2.2 Advanced.....	2-6
2.2.3 Intel	2-17
2.2.4 Security.....	2-27
2.2.5 Boot	2-28
2.2.6 Exit.....	2-29
Chapter 3 PS-A Monitoring Features	
3.1 RAS Features	3-2
3.1.1 RAS Features	3-2
3.2 Setting Menus.....	3-9
3.3 Monitoring the PS-A Status.....	3-11
3.3.1 Description.....	3-11
3.3.2 Setup Procedure.....	3-11
3.3.3 When an Error Occurs	3-14
3.3.4 When an Alert Occurs.....	3-15

3.4	Checking the Status of the PS-A Being Monitored	3-16
3.4.1	Description	3-16
3.4.2	Setup Procedure	3-16
3.5	Checking the Error Log List	3-17
3.5.1	Description	3-17
3.5.2	Setup Procedure	3-18
3.6	Monitoring Errors/Alerts from a Remote Server.....	3-20
3.6.1	Description	3-20
3.6.2	System Configuration.....	3-21
3.6.3	Monitoring using Pro-Server with Pro-Studio or Pro-Server EX.....	3-24
3.7	Restarting/Shutting Down the PS-A from a Remote Server	3-26
3.7.1	Description	3-26
3.7.2	Setup Procedure	3-27
3.8	Setup Guide for the System Monitor Property	3-28
3.8.1	Voltage / Fan / Temperature / Backlight / DIN0 / DIN1.....	3-29
3.8.2	SMART	3-30
3.8.3	Remote RAS	3-31
3.8.4	Watchdog Timer.....	3-32
3.8.5	Remote reset	3-33
3.9	Setup Guide for the System Monitor Screen	3-34
3.9.1	Voltage / Fan / Temperature / Backlight / Watchdog Timer.....	3-34
3.9.2	SMART	3-35
3.10	Displayed Messages.....	3-36
3.11	Restrictions	3-40

Chapter 4 Troubleshooting

4.1	Problems and Countermeasures	4-2
4.2	Recovery Procedure	4-5
4.2.1	PS-A with no Pre-installed OS	4-5
4.2.2	PS-A with Pre-installed OS (Windows® XP).....	4-5

Appendices

1	I/O Map	A-2
2	Memory Map.....	A-3
3	Interrupt Map	A-4
4	License Agreement.....	A-6

Setup operation flow

The following shows the flow of the setup operation from the purchase of the PS-A to the completion of the required setup before use.

■ PS-A with no pre-installed OS

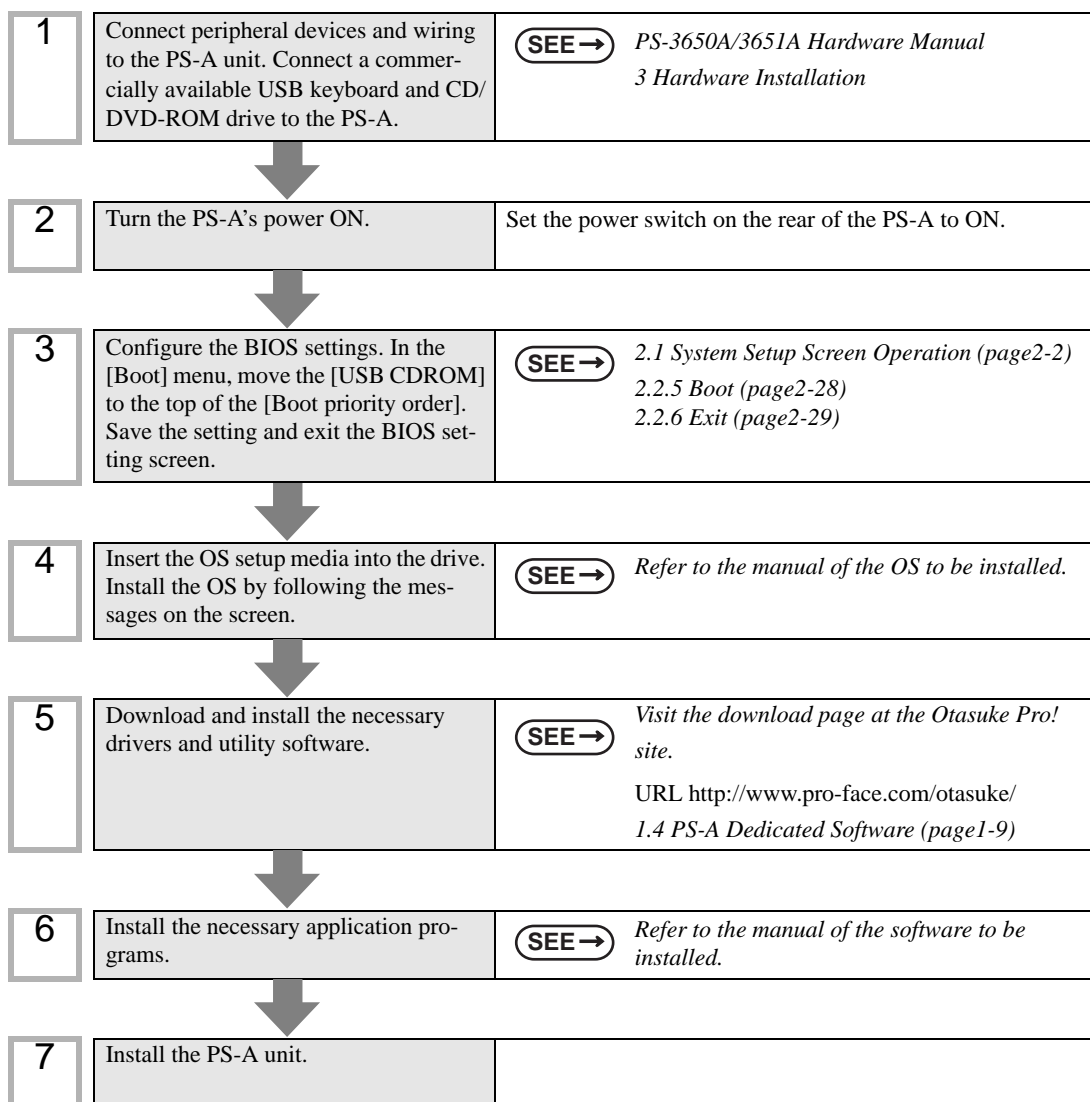

■ PS-A with pre-installed OS

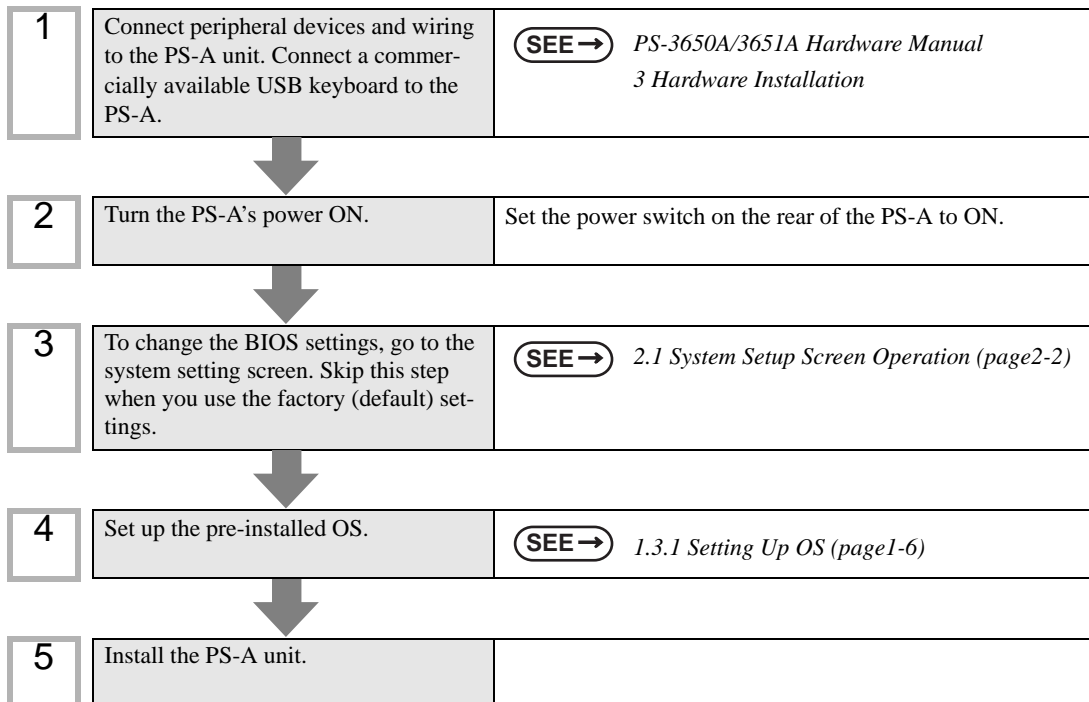

IMPORTANT

- After hardware setup is completed, the OS (Windows® XP) must be used to create partitions and format (initialize) the HDD before any data or applications can be saved to the PS-A drive. For details concerning these procedures, refer to the OS manufacturer's instruction manual.
- Whenever you turn the PS-A unit's power OFF, wait until the internal HDD stops spinning (approximately 5 seconds) before turning the power ON again.
- The PS-A's hard disk is designed for use with the Windows® XP. Other operating systems do not support this driver software, etc.

NOTE

- Use of an uninterrupted power supply is recommended to protect your data from accidental power failures. An uninterrupted power supply that supports Windows® will give you sufficient time to shut down your system safely by changing into the power supply for the backup in case of a power failure, and can even be set up to automatically shut down your Windows® OS. The PS-A unit, however, cannot be used with a 2-Step Inverter Output type uninterrupted power supply. Be sure the unit is a sine-output type power supply. For details, consult your local UPS system dealer.

1 | Setting Up Software

1. Software Configuration
2. Setting Up an HDD with no Pre-installed OS
3. Setting Up an HDD with Pre-installed OS
4. PS-A Dedicated Software

This chapter describes the setting procedures for the PS-A dedicated programs and the setting parameters.

1.1 Software Configuration

If you purchased a PS-A unit with the OS pre-installed, the software has been pre-installed.

If you purchased a PS-A unit without the OS pre-installed, you can download each software program from the Pro-face support site "Otasuke Pro!".

SEE → 1.2.2 Setting Up the PS-A Dedicated Software (page1-2)

1.2 Setting Up an HDD with no Pre-installed OS

First, when you use a PS-A with no pre-installed OS, you will need to install Windows® XP. You also need to install any required utility software.

1.2.1 Setting Up the OS

Install your operating system. For the setup procedures about the OS, refer to that product's installation manual.

IMPORTANT

- You will need the Serial ATA controller driver to install the OS. Download the Serial ATA controller driver from the Pro-face support site "Otasuke Pro!".
- The PS-A unit supports Windows® XP Service Pack 2. The PS-A unit performance cannot be guaranteed when any other operating system is used.

1.2.2 Setting Up the PS-A Dedicated Software

Download the necessary drivers and utility software from the Pro-face support site "Otasuke Pro!".

URL <http://www.pro-face.com/otasuke/>

Click here!

NOTE

- The setup requires a USB keyboard.
- For details about the drivers and utility software, refer to the following section.

SEE → 1.4 PS-A Dedicated Software (page1-9)

■ [Proface] Folder Configuration

The following diagram describes the configuration of this folder. (For all Windows® versions)

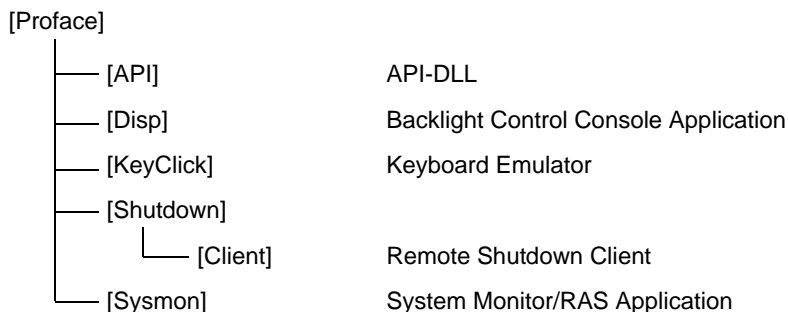

NOTE

- When a LAN or a printer is added, you need to change the Windows® system configuration using the following procedure.

- (1) When the Windows® system configuration settings are changed, the following message appears. When your media is DVD-ROM, replace “CD-ROM” with “DVD-ROM”.

Insert the CD labeled “Windows® xx*1 Professional CD-ROM” in the CD-ROM drive (D:), and click [OK].

When copying the file from other locations such as a floppy disk or network server, also click the [OK] button.

*1 “xx” is your OS.

Example) When using Windows® XP: “Windows® XP Professional CD-ROM”

- (2) Select the folder where you will change the system configuration and click [OK].

Double-click the [I386] folder in the Windows® installation media.

D:\I386 (When the drive is “D”)

1.3 Setting Up an HDD with Pre-installed OS

In the PS-A with pre-installed OS, the following software has been installed in advance.

■ PS-A with Windows® XP Pre-installed

- Windows® XP Professional operating system manufactured by Microsoft Corporation
- Mouse Emulation Software manufactured by DMC Co., Ltd. (TSC-1310D/DD)
- Keyclick32 keyboard emulator manufactured by IN-fINITY soft
- PS-A dedicated utility software and drivers manufactured by Pro-face

NOTE

- Each pre-installed operating system on the hard disk in the PS-A unit is designed specially for PS-3650A/PS-3651A.
- For details about the drivers and utility software, refer to the following section.



1.4 PS-A Dedicated Software (page1-9)

■ [Proface] Folder Configuration

A [Proface] folder is prepared on the C drive. The following diagram describes the configuration of this folder.

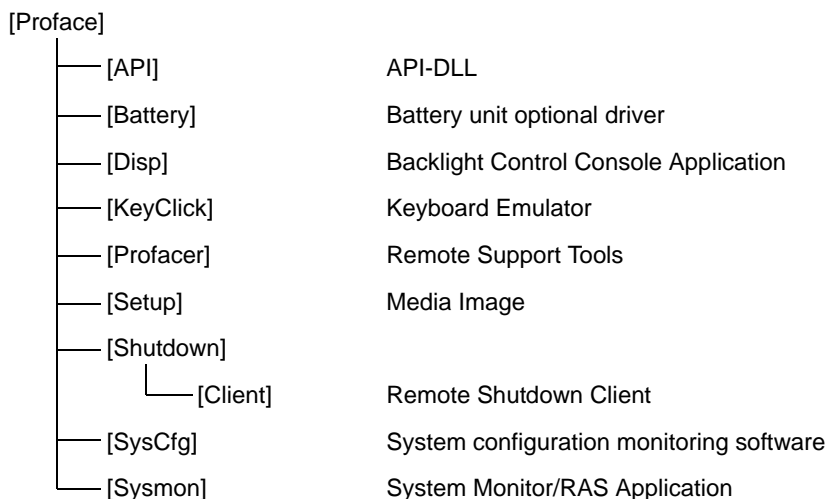

NOTE

- When a LAN or a printer is added, you need to change the Windows® system configuration using the following procedure.

(1) When the Windows® system configuration settings are changed, the following message appears. When your media is DVD-ROM, replace “CD-ROM” with “DVD-ROM”.

Insert the CD labeled “Windows® xx*1 Professional CD-ROM” in the CD-ROM drive (D:), and click [OK].

When copying the file from other locations such as a floppy disk or network server, also click the [OK] button.

*1 “xx” is your OS.

Example) When using Windows® XP: “Windows® XP Professional CD-ROM”

(2) Select the folder where you will change the system configuration and click [OK].

C:\Proface\Setup\I386

1.3.1 Setting Up OS

Set up the Pre-installed OS in the PS-A unit.

■ Windows® XP Setup Procedure

This section describes the setup procedure for Windows® XP. The setting parameters vary depending on your environment. Ask your network administrator for the appropriate parameters.

NOTE

- When setup is completed, a README file is created on the desktop. The README file contains details regarding software and information released since the creation of this manual. Read the README file first after setup is completed.
- The OS setup operation requires a keyboard.

- (1) Once the power of the PS-A unit with Windows® XP pre-installed is turned ON, the [Welcome to Microsoft Windows] screen will appear. Click [Next].



- (2) The [The End User License Agreement] screen will appear.
After reading the contents, press [Yes, I accept] if you agree, and click [Next] to continue.

- (3) The [Help protect your PC] screen will appear.

Choose whether to update Windows[®] automatically. To enable the Automatic Updates, check on [Help protect my PC by turning on Automatic Updates now (recommended)]. To disable it, check [Not right now]. Click [Next] to continue.

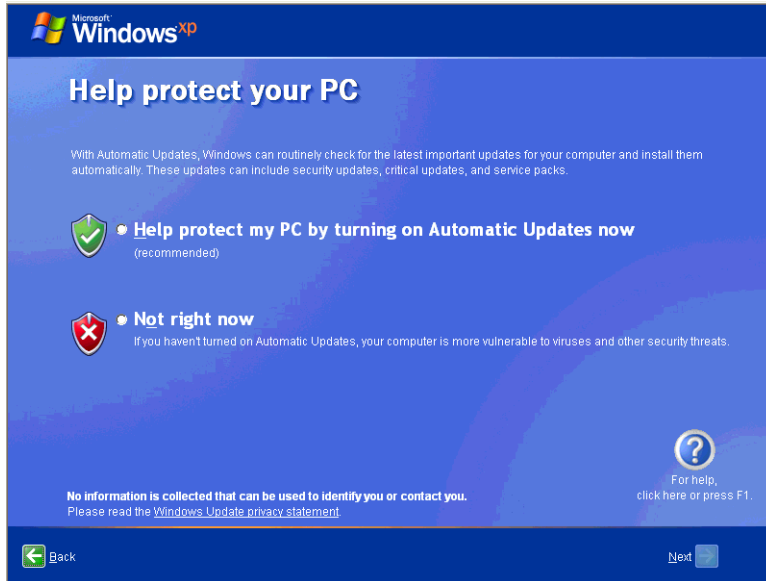

- (4) The [What's your computer's name?] screen will appear.

After entering the computer's name, click [Next] to continue. At default, the computer's name has been entered. If it's not necessary to change it, click [Skip].

- (5) The [What's your Administrator password?] screen will appear.

If the password is set, enter the password in [Administrator password:] and [Confirm password:] and click [Next]. If the password is not set, click [Skip].

- (6) The [Is this computer in a domain?] screen will appear.

To join the domain, select [Yes, make this computer a member of the following domain:] and enter the domain's name. Not to join the domain, click [Next] to continue.

- (7) The [Checking your internet connectivity] screen will appear and your internet connectivity will be automatically checked.



- (8) The [Ready to register with Microsoft?] screen will appear. If you register, check [Yes, I'd like to register with Microsoft now]. If not, check [No, not at this time]. Press [Next].

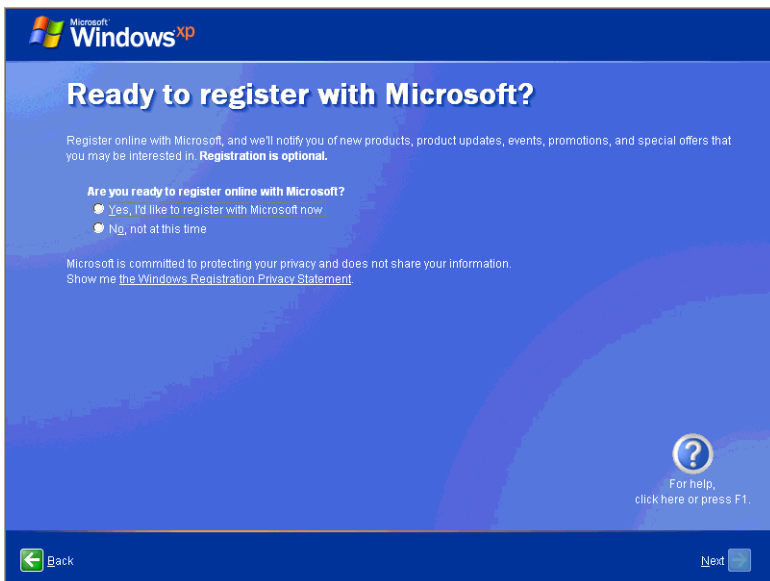

- (9) The [Who will use this computer?] will appear. Up to 5 names can be entered for a user's name. After entering the user's name, click [Next] to continue.
- (10) The [Thank you!] screen will appear. Click [Finish] to complete the setting.

1.4 PS-A Dedicated Software

1.4.1 Driver

Five types of dedicated PS-A drivers (Serial ATA Controller, Chipset, Audio, Graphic Accelerator, LAN and Touch Panel Driver (Mouse Emulator)) are available.

If you purchased the PS-A with no pre-installed OS, download the drivers from the Pro-face support site “Otasuke Pro!”. (A PS-A unit that has been recovered using the Recovery Media will have all the required drivers installed.)

The explanation given in this section assumes that the [Proface] folder has been created on drive C.

IMPORTANT

- Do not uninstall the drivers which have been installed in the PS-A unit.

NOTE

- For the procedure and precautions regarding the installation, visit the download page at the “Otasuke Pro!” site.

<http://www.pro-face.com/otasuke/>

■ Serial ATA Controller Driver

Serial ATA Controller driver made by SiliconImage.

Installing the driver enables PS-A with no pre-installed OS to install OS.

■ Chipset Driver

Chipset driver made by Intel®.

Installing the driver enables OS to recognize USB or Core PCI and use them properly.

■ Audio Driver

AC97 Audio Codec driver made by Realtek.

Installing the driver enables the sound functions to be available.

■ Graphic Accelerator Driver

Display driver made by Intel®.

Installing the driver enables to display the screens properly.

■ LAN Driver

Gigabit Ethernet Controller driver made by Realtek.

Installing the driver enables LAN2.

NOTE

- LAN1 is the standard driver. You are not required to install a LAN driver.
- The LAN2 port can be used for starting the PS-A via LAN.

SEE →

3.7 Restarting/Shutting Down the PS-A from a Remote Server (page3-26)

■ Touch Panel Driver (Mouse Emulator)

Mouse emulation software.

Installing the driver enables to use touch panel operation.

NOTE

- You can open “Touch Panel Property” by selecting the [Start] -> [Programs] -> [UPDD] -> [Settings]. In this dialog box, you can specify the details of the touch panel operation.
- If the touch position recognized in the panel deviates from the actual touch, you need to calibrate the touch panel. Select the [Start] -> [Programs] -> [UPDD] -> [Calibration]. When a cross appears on the screen, press it. Then click [OK] in the [Confirmation after calibration] dialog box to finish the calibration.

1.4.2 Special Application Program Features

The special programs designed for the PS-A unit are located in the following folders. The file storage locations given in the table below assume that the [Proface] folder already exists on drive C.

File Name	Windows® XP
Disp.exe	C:\Proface\Disp
Backlight Control.scr	C:\Windows\System32
BIBright.cpl	
Keyclick.exe	C:\Proface\Keyclick
Blioctl.dll	C:\Windows\System32
loctl.dll	
Smonras.dll	
SmSRvCPL.cpl	
Sysmon.sys	C:\Windows\System32\Drivers
SystemMonitor.exe	C:\Proface\Sysmon\GUI

■ Backlight Control Console Application: Disp.exe

This command line utility is used to turn On and Off the backlight display. This program runs on the command prompt.

Settings Used	Disp.exe ON/OFF
Option Switch	ON: Displayed / OFF: Not Displayed
Return Value	0: Completed Normally / -1: Option Switch Error

IMPORTANT

- If your application requires that the OS continuously turn the backlight display ON and OFF, be sure to use the Blioctl.dll.

■ Backlight OFF Screen Saver: Backlight Control.scr

This software is used to turn OFF the PS-A backlight after a specified period of inactivity. The use of this feature will help to extend the life of the PS-A backlight. This program runs on Windows®.

NOTE

- Certain application programs may not allow the PS-A backlight to turn OFF. Test each program individually to check if the screen saver will operate correctly before use.

■ Backlight Brightness Adjustment: BIBright.cpl

Backlight brightness can be set to one of four levels: Level 0, Level 1, Level 2 or Level 3.

- Brightness level 0: Very dark
- Brightness level 1: Somewhat dark
- Brightness level 2: Somewhat bright
- Brightness level 3: Very bright

To use this program when you use Windows® XP, click the [Backlight Brightness] icon of the [Control Panel]'s [Appearance and Themes]. The default setting is Brightness level 3.

■ Keyboard Emulator: Keyclick.exe

This program allows the User's mouse operation to perform keyboard-like data input. When this program is executed on Windows®, a keyboard is displayed on the screen of the PS-A unit.

This is a software keyboard provided by IN-fINITY soft (KeyClick32). Be sure to read the license agreement in the Appendix before use.

SEE → *Appendices 4 License Agreement (pageA-6)*

NOTE

- Certain application programs may not support this keyboard emulator. Test each application individually to check if the keyboard emulator will operate correctly.
- This program cannot be used to enter Windows® startup screen User Name and Password information.
- To change the Keyclick program's font size a keyboard is required.
- For details concerning the Keyclick program's operation, simply click on the [HELP] button on the screen keyboard to call up the program's online help data.

■ API-DLL

These dynamic link libraries allow users to access RAS features that operates on the PS-A via custom-made applications. The following three types are available.

For details, refer to the API Reference Manual which can be downloaded from the Pro-face support site "Otasuke Pro!" (URL <http://www.pro-face.com/otasuke/>).

◆ Backlight Control: Bliocctl.sil

This dynamic library allows User-created applications to utilize the PS-A backlight control feature that operates on the PS-A.

◆ RAS Features: loctl.dll

This dynamic link library allows users to access RAS features that operates on the PS-A via custom-made PS-A applications.

◆ Shared Memory Access: Smonras.dll

This dynamic link library allows users to access shared memory via remote RAS features.

■ System Monitor Property: SmSRvCPL.cpl

This program allows the user to set the notification method used in event of an error/alert while the RAS feature monitors the system. Execute the program from the [System Monitor Property] icon.

■ System File: Sysmon.sys

This system file allows use of the RAS and System Monitoring features. This file should not be modified. If it is modified, the RAS and System Monitoring features may not operate correctly.

■ System Monitoring/RAS Application: SystemMonitor.exe

The RAS and System Monitoring features allow users to monitor temperature, voltage, and fan operation errors/alerts. This program is started automatically at the same time as the OS.

◆ System Monitoring Program: SystemMonitor.exe

- SEE → [3.3.3 When an Error Occurs \(page3-14\)](#)
- [3.3.4 When an Alert Occurs \(page3-15\)](#)

◆ Watchdog Parameter Setup Program: System Monitor Property

- SEE → [3.3.1 Description \(page3-11\)](#)

2



System Setup

1. System Setup Screen Operation
2. System Parameters Setting

This chapter describes how to operate the system setup screen and how to set system parameters.

2.1 System Setup Screen Operation

This section describes the operation of the BIOS setup screen.

IMPORTANT

- Normally, use only the factory (default) settings.

- (1) Connect a USB keyboard to the PS-A.
- (2) Turn the PS-A's power ON.
- (3) After the boot-up screen comes up, press the [F2] key. The setup utility starts and the following screen appears.

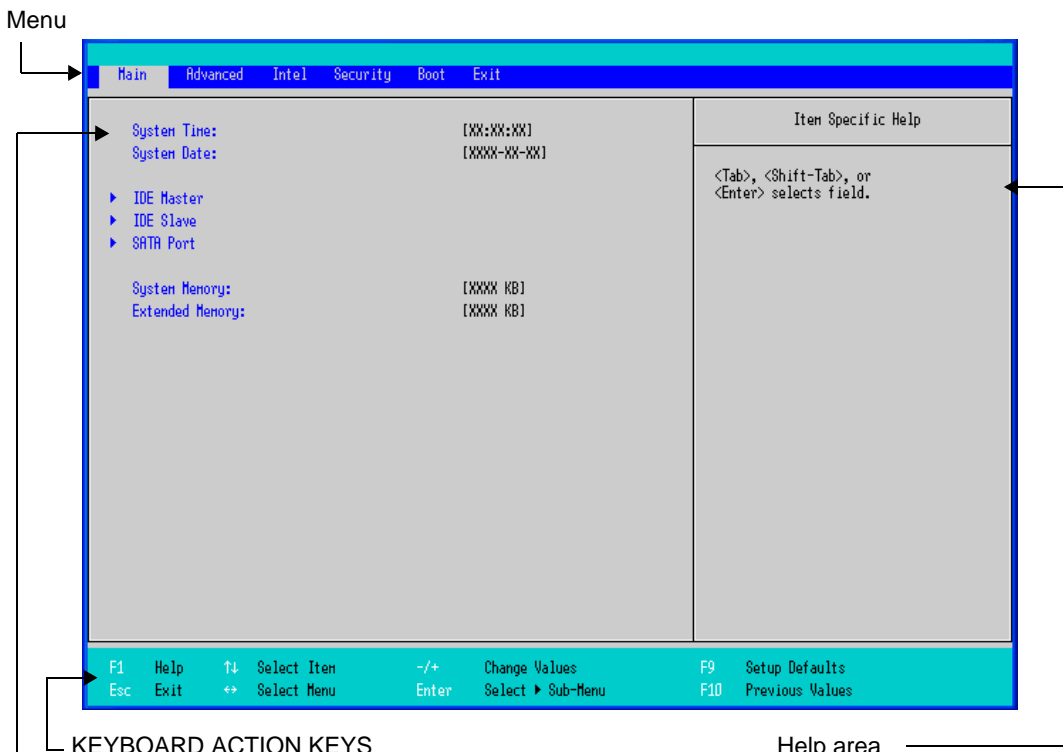

KEYBOARD ACTION KEYS

Provides a summary of the keyboard keys used to carry out the set-up. Press the [F1] key to display the help for the system setup. Press the [F9] key to reset all settings to the default settings. Press the [F10] key to save the settings and exit the system setup menu.

Help area

Shows the information of the items you selected.

SYSTEM SETTING SELECTION AREA

Each of the titles (areas) listed here contains system setting items.

- (4) To use the [←] [→] arrow keys, change the menu contents. A setting screen of each system will be displayed.
- (5) To use the [↑] [↓] arrow keys, move up and down the cursor to select an item of the system, then confirm it by the [Enter] key.
- (6) Change the value of the confirmed item with the [-] and [+] keys.
- (7) To return from the sub layer to the main layer, press the [Esc] key.

■ BIOS Setup Screen Configuration

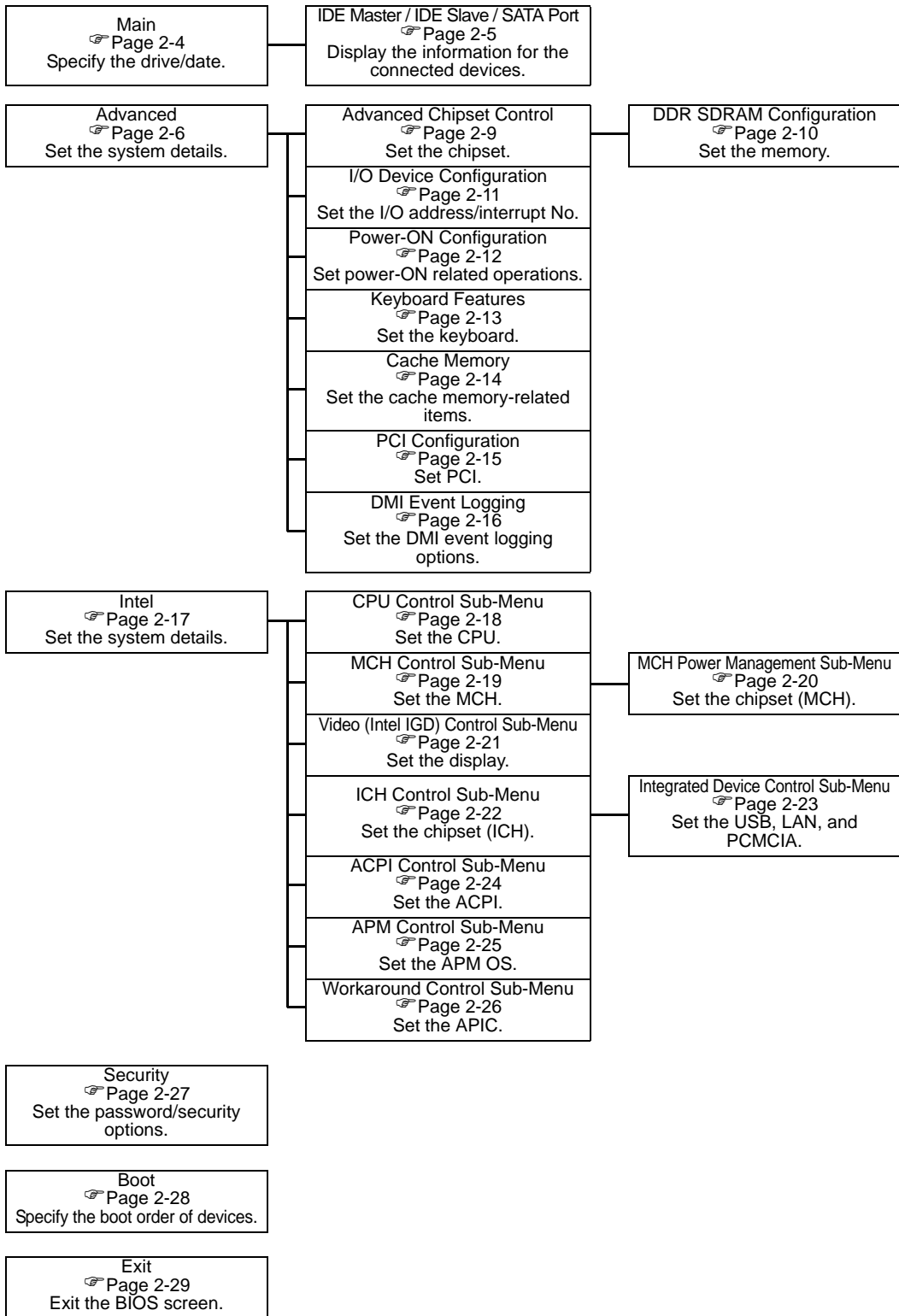

2.2 System Parameters Setting

Select the items to set up the system information. Here, we introduce the system parameters of each item.

IMPORTANT

- Normally, use only the factory (default) settings.

2.2.1 Main

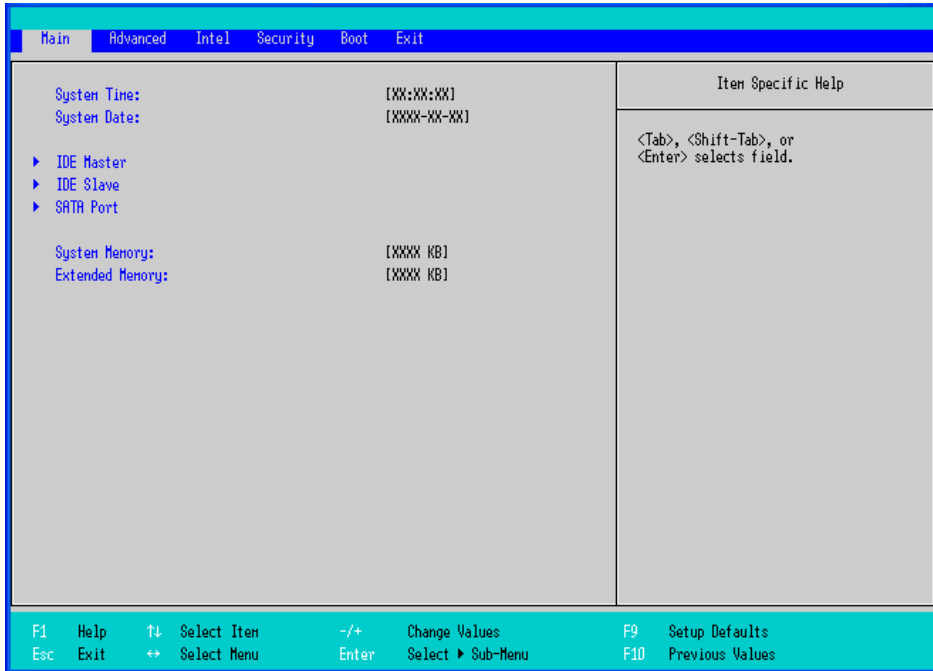

System Time

Shows the time which the PS-A currently recognizes. Move the cursor by the [Tab] key and set a proper time for the PS-A by the [Tab], [+] and [-] keys because the factory default setting is the Japan’s Standard Time (GMT+09:00).

System Date

Shows the date which the PS-A currently recognizes. Set a proper date for the PS-A by the [+] and [-] keys.

IDE Master / IDE Slave / SATA Port

Displays the name of devices connected to the PS-A. Pressing the [Enter] key will call up the Parameter settings menu.

SEE → ■ IDE Master / IDE Slave / SATA Port (page2-5)

System Memory

Shows the capacity of the “System Memory”.

Extended Memory

Shows the capacity of the “Extended Memory”. It is the loaded memory - the size of the Video Memory - 2048K byte.

■ IDE Master / IDE Slave / SATA Port

Point out the cursor at the [Primary Master], [Primary Slave], [Secondary Master], or [Secondary Slave] on the “Main screen”, and then press the [Enter] key, so that the following screen is shown.

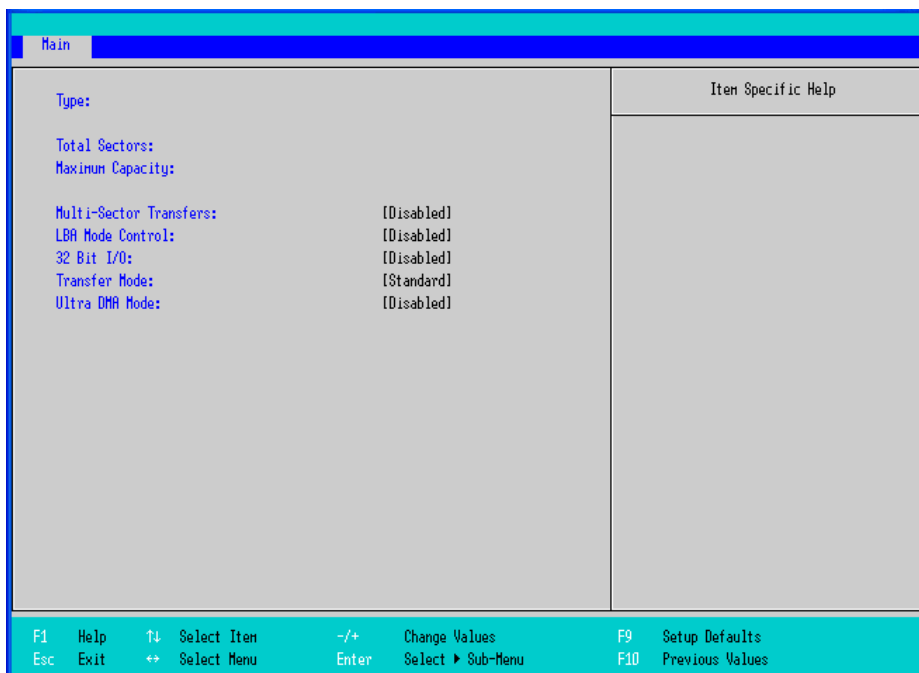

Type

Specifies a type of drive which you use. Select from [Auto], [None], [ATAPI Removable], [CD-ROM], [IDE-Removable], [Other ATAPI], or [User]. The factory default type is [Auto].

IMPORTANT

- Select [Auto] to have the PS-A recognize the hardware properly.

Total Sectors

Shows the number of disk sectors connected to the unit.

Maximum Capacity

Shows the maximum capacity of the disk connected to the unit.

Multi Sector Transfers

Specifies the number of sectors per block, which are transferred to the memory. When the [Type] is [None], nothing is displayed. When [Type] is [Auto], the selection is disabled. In other cases, select from [Disabled], [2 Sectors], [4 Sectors], [8 Sectors], or [16 Sectors].

LBA Mode Control

Enables or disables the Logical Block Address (LBA) instead of the Cylinders, Headers, and Sectors. When the [Type] is [None], nothing is displayed. When [Type] is [Auto], the selection is disabled. In other cases, select from [Disabled] or [Enabled].

32 Bit I/O

Specifies an enabled/disabled state for the 32 bit transferring between CPU and IDE controller. Select from [Enabled] or [Disabled]. When the [Type] is [None], nothing is displayed.

Transfer Mode

Specifies a method of transferring data. When the [Type] is [None], nothing is displayed. When [Type] is [Auto], the selection is disabled. In other cases, select from [Standard], [Fast PIO 1], [Fast PIO 2], [Fast PIO 3], [Fast PIO 4], [FPIO 3/DMA 1], or [FPIO 4/DMA 2].

Ultra DMA Mode

Specifies a Ultra DMA mode for the Hard drive. When the [Type] is [None], nothing is displayed. When [Type] is [Auto], the selection is disabled. In other cases, select from [Disabled], [Mode 0], [Mode 1], [Mode 2], [Mode 3], [Mode 4], or [Mode 5].

2.2.2 Advanced

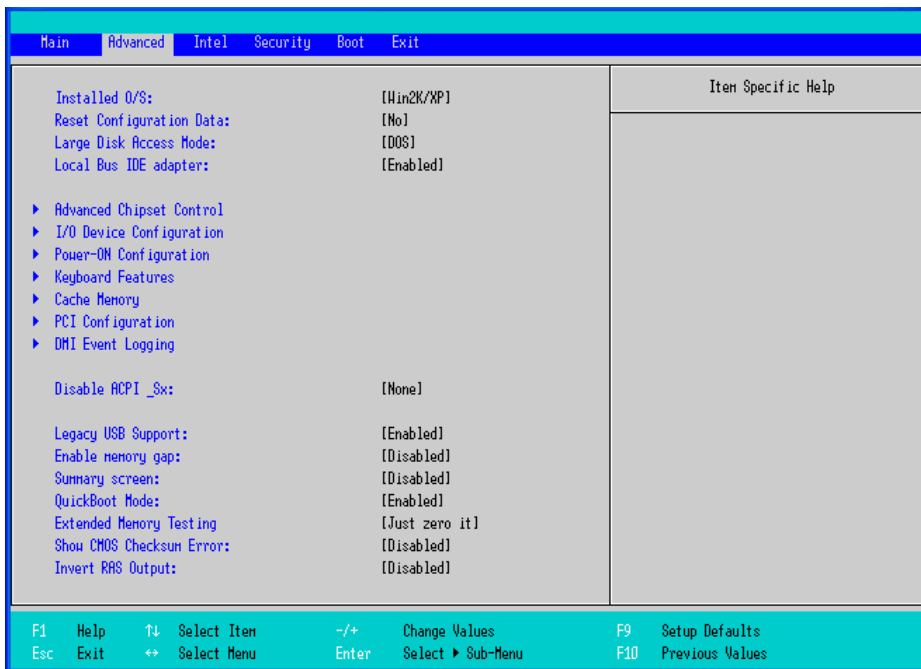

Installed O/S

Specifies a type of OS of the unit. Select from [Other] or [Win2K/XP]. The factory default setting is [Win2K/XP].

Reset Configuration Data

Specifies whether you want to reset the Plug & Play information which is recorded in the Extended System Configuration Data (ESCD) Block of the CMOS RAM, when the system boots up next time. Select from [Yes] or [No]. The factory default setting is [No].

Large Disk Access Mode

Specifies the access mode. When you use UNIX or NetWare for OS, the setting should be [Other]. Select from [Dos] or [Other]. The factory default setting is [Dos].

Local Bus IDE adapter

Specifies an enabled/disabled state for the IDE controller. Select from [Enable] or [Disabled]. The factory default setting is [Enable].

Advanced Chipset Control

Point the cursor to the [Advanced Chipset Control] and press the [Enter] Key, so that you can set up details.

SEE → ■ *Advanced Chipset Control (page2-9)*

I/O Device Configuration

Point the cursor to the [I/O Device Configuration] and press the [Enter] Key, so that you can go to the Serial Port Setting screen.

SEE → ■ *I/O Device Configuration (page2-11)*

Power-ON Configuration

Point the cursor to the [Power-ON Configuration] and press the [Enter] key, so that you can go to the set-up screen for power-ON related operations.

SEE → ■ *Power-ON Configuration (page2-12)*

Keyboard Features

Point the cursor to the [Keyboard Features] and press the [Enter] Key, so that you can go to the keyboard set-up screen.

SEE → ■ *Keyboard Features (page2-13)*

Cache Memory

Point the cursor to the [Cache Memory] and press the [Enter] Key, so that you can go to the set-up screen for Cache Memory.

SEE → ■ *Cache Memory (page2-14)*

PCI Configuration

Point the cursor to the [PCI Configuration] and press the [Enter] Key, so that you can go to the set-up screen for PCI IRQ.

SEE → ■ *PCI Configuration (page2-15)*

DMI Event Logging

Point the cursor to [DMI Event Logging] and press the [Enter] Key to go to the set-up screen for DMI event logging.

SEE → ■ *DMI Event Logging (page2-16)*

Disable ACPI_Sx

Specifies the API's state. Select from [None] or [S1]. With this action, the selecting state will be enabled. The factory default setting is [None].

Legacy USB Support

When the USB keyboard is used under DOS, specifies an enabled/disabled state for the USB. The choice is [Enabled] or [Disabled]. The factory default setting is [Enabled].

Enable Memory gap

Specifies an enabled/disabled state for the Memory gap. Select from [Enabled] or [Disabled]. The factory default setting is [Disabled].

Summary screen

Specifies whether the configuration information of the running system is displayed. Select from [Enabled] or [Disabled]. The factory default setting is [Disabled].

QuickBoot Mode

Specifies whether the system boot-up should be “QuickBoot mode”. When the choice is [Disabled], it will execute a system test at the system starting-up. The factory default setting is [Enabled].

Extended Memory Testing

Specifies whether a test for the Extended Memory needs to be executed at the system starting-up. The test types are listed below. The factory default setting is [Just Zero it].

[Normal] Normal test

[Just Zero it] Simple test

[None] No test

Show CMOS Checksum Error

Specifies whether an error message should be displayed when a CMOS checksum error occurs. Select from [Enabled] or [Disabled]. The factory default setting is [Disabled].

Invert RAS Output

Specify whether to invert the RAS output. Select [Enabled] or [Disabled]. The factory default setting is [Disabled].

■ Advanced Chipset Control

Specifies parameters for the chipset. Point the cursor to the [Advanced Chipset Control] on the [Advanced] screen and press the [Enter] Key, so that the following screen will be displayed.

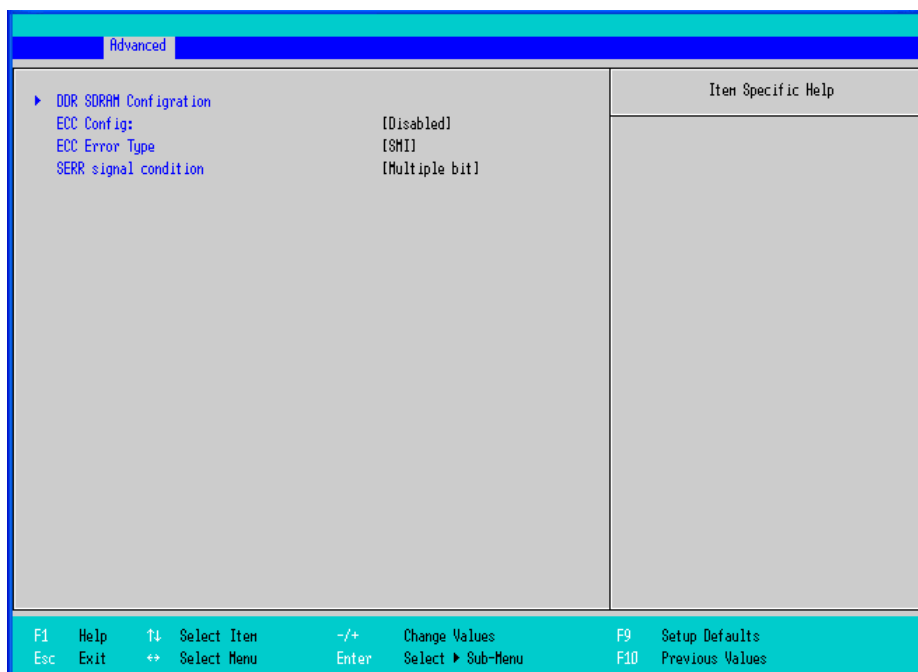

DDR SDRAM Configuration

Point the cursor to the [DDR SDRAM Configuration] and press the [Enter] Key, so that you can go to the Memory Setting screen.

SEE → ◆ *DDR SDRAM Configuration (page 2-10)*

ECC Config

Specifies whether the ECC function for memory, which is a function of recovering errors, needs to be used.

This parameter is displayed only when memory with the ECC function is used. Select from [ECC] or [Disabled]. The factory default setting is [Enabled].

ECC Error Type

Specifies the interruption setting when an ECC error occurs. This parameter is displayed only when memory with the ECC function is used. Select from [None], [NMI], [SMI], or [SCI]. The factory default setting is [SMI].

SERR signal condition

Specifies error bit(s) for ECC. This parameter is displayed only when memory with the ECC function is used.

Select from [None], [Single bit], [Multiple bit], or [Both]. The factory default setting is [Multiple bit].

◆DDR SDRAM Configuration

The memory setting parameters are displayed. Point the cursor to the [DDR SDRAM Configuration] on the [Advanced Chipset Control] and press the [Enter] Key, so that the following screen will be displayed.

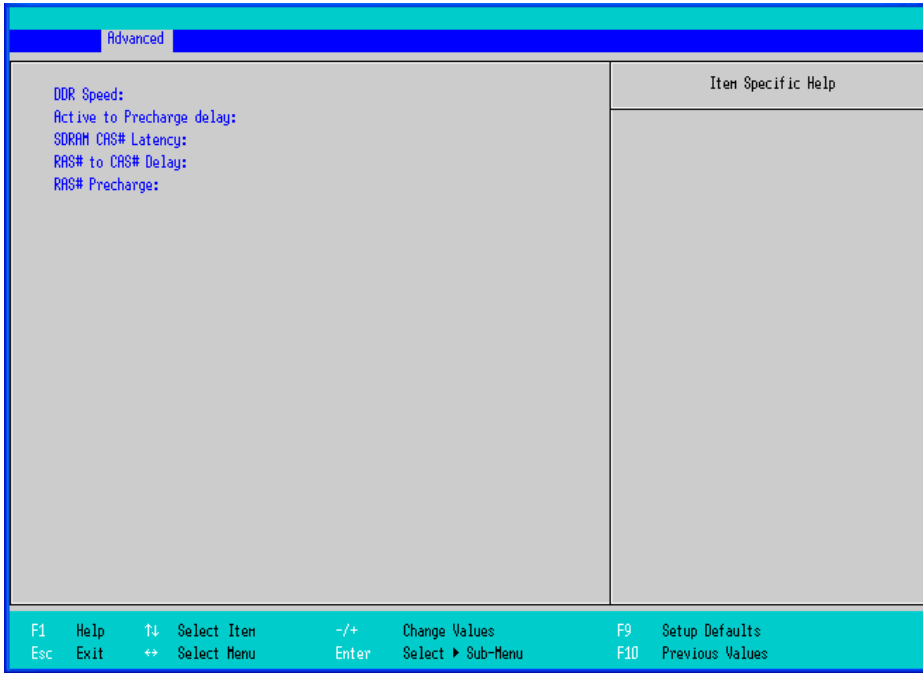

DDR Speed

Shows the clock frequency for the memory.

Active to Precharge delay

Shows the control status of the timing of DRAM Precharge processing.

SDRAM CAS# Latency

Shows the latency time for CAS.

RAS# to CAS# Delay

Shows a transfer timing from RAS to CAS.

RAS# Precharge

Shows the number of cycles of RAS precharge.

■ I/O Device Configuration

Specifies the address and interrupt level of the I/O ports. Point the cursor to the [I/O Device Configuration] on the [Advanced] screen and press the [Enter] Key, so that the following screen will be displayed.

Advanced		Item Specific Help
Onboard Serial Port 1:	[Enabled]	
Base I/O address:	[3F8]	
Interrupt:	[IRQ 4]	
Onboard Serial Port 2:	[Enabled]	
Base I/O address:	[2F8]	
Interrupt:	[IRQ 3]	
Onboard Serial Port 3:	[Enabled]	
Base I/O address:	[3E8]	
Interrupt:	[IRQ 11]	

F1	Help	↑↓	Select Item	-/+	Change Values	F9	Setup Defaults
Esc	Exit	↔	Select Menu	Enter	Select ▶ Sub-Menu	F10	Previous Values

Onboard Serial Port 1

Specifies an enabled/disabled state for the COM1. Select from [Disabled] or [Enabled]. The factory default setting is [Enabled]. In addition, the factory default setting for Base I/O Address is [3F8], and for Interrupt is [IRQ 4].

Onboard Serial Port 2

Specifies an enabled/disabled state for the COM2. Select from [Disabled] or [Enabled]. The factory default setting is [Enabled]. In addition, the factory default setting for Base I/O Address is [2F8], and for Interrupt is [IRQ 3].

Onboard Serial Port 3

Specifies an enabled/disabled state for the COM3. Select from [Disabled] or [Enabled]. The factory default setting is [Enabled]. In addition, the factory default setting for Base I/O Address is [3E8], and for Interrupt is [IRQ 11].

NOTE

- The Battery unit and driver communicate through COM3, as the battery output interface. When using a battery unit, set Onboard Serial Port 3 to [Enabled].

■ Power-ON Configuration

Specify the setting of power-on operation. Point the cursor to the [Power-ON Configuration] on the [Advanced] screen and press the [Enter] Key, so that the following screen will be displayed.

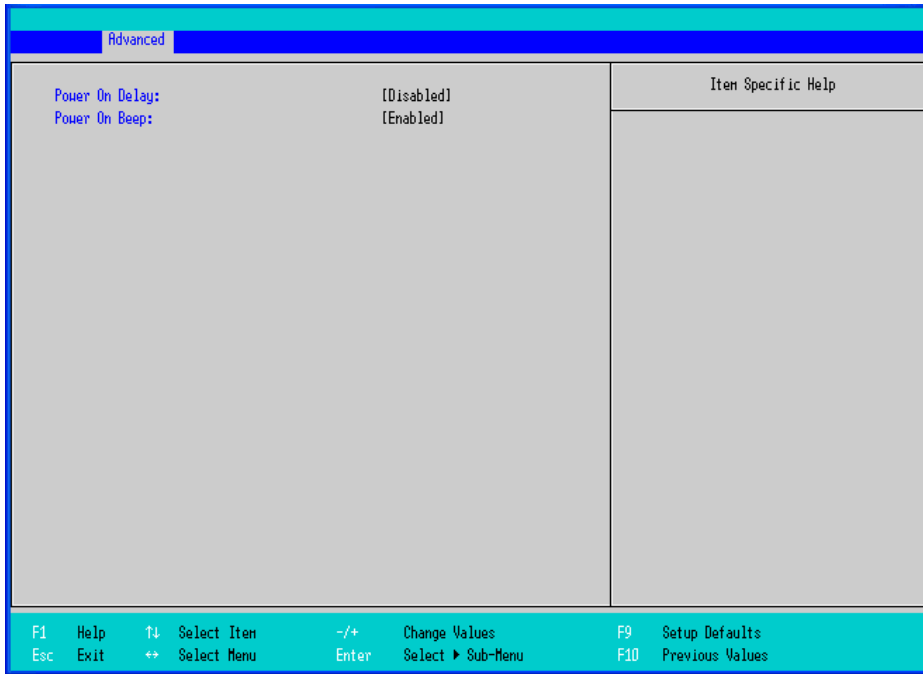

Power On Delay

Specify whether to set standby time before the system starts up. Select [Enabled] or [Disabled]. When [Enabled] is selected, the system waits for 4 seconds before start-up. The factory default setting is [Disabled].

- NOTE**
- If a USB device such as USB memory is connected to the PS-A when the PS-A is started, the following phenomenon may occur, depending on the device:
 - It takes about 1 minute before the OS starts up.
 - The PS-A does not recognize the USB device.
- These problems may be solved by setting [Power On Delay] to [Enable].

Power On Beep

Specify whether to sound a “beep” upon system boot-up. Select [Enabled] or [Disabled]. The factory default setting is [Enabled].

■ Keyboard Features

Specifies the keyboard-related parameters. Point the cursor to the [Keyboard Features] on the [Advanced Chipset Control] and press the [Enter] Key, so that the following screen will be displayed.

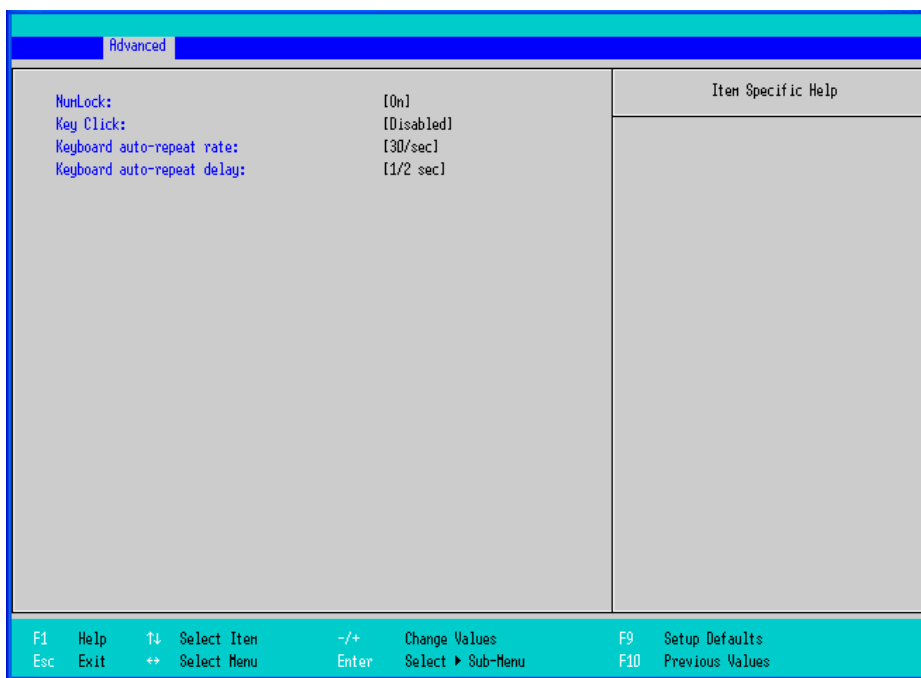

NumLock

Specifies the NumLock status. Select from [Auto], [On], or [Off]. The factory default setting is [On].

KeyClick

Specifies an enabled/disabled state for the keyboard's click sound. Select from [Enabled] or [Disabled]. The factory default setting is [Disabled].

Keyboard auto-repeat rate

Specifies the figures of how many times a key can input letters while being pressed for a second. Select from [30/sec.], [26.7/sec.], [21.8/sec.], [18.5/sec.], [13.3/sec.], [10/sec.], [6/sec.], or [2/sec.]. The factory default setting is [30/sec.].

Keyboard auto-repeat delay

Specifies a time duration until the auto-repeat function becomes enabled from a key is pressed. Select from [1/4 sec.], [1/2 sec.], [3/4 sec.], or [1 sec.]. The factory default setting is [1/2 sec.].

■ Cache Memory

Specifies the parameters for the cache memory. Point the cursor to the [Cache Memory] on the [Advanced] screen and press the [Enter] Key, so that the following screen will be displayed.

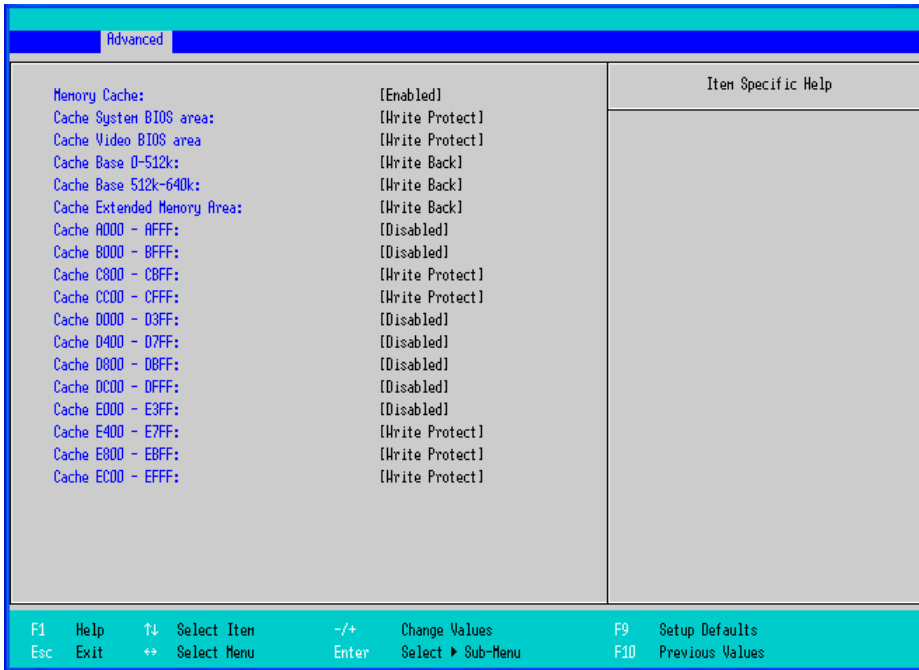

Memory Cache

Specifies an enabled/disabled state for the Memory Cache. Select from [Enabled] or [Disabled]. The factory default setting is [Enabled].

Cache System BIOS area

Specifies the cache set-up for the System BIOS area. Select from [uncached] or [Write Protect]. The factory default setting is [Write Protect].

Cache Video BIOS area

Specifies the cache set-up for the VIDEO BIOS area. Select from [uncached] or [Write Protect]. The factory default setting is [Write Protect].

Cache Base 0-512k

Specifies the cache set-up for the Base Memory, 0 to 512k. Select from [uncached], [Write Through], [Write Protect], or [Write Back]. The factory default setting is [Write Back].

Cache Base 512-640k

Specifies the cache set-up for the Base Memory, 512 to 640k. Select from [uncached], [Write Through], [Write Protect], or [Write Back]. The factory default setting is [Write Back].

Cache Extended Memory Area

Specifies the cache set-up for the Extended Memory area. Select from [uncached], [Write Through], [Write Protect], or [Write Back]. The factory default setting is [Write Back].

Cache xxxx-xxxx

Specifies the cache setting for each address. Select from [Disabled], [USWC Caching] (The address A000 - AFFF and B000 - BFFF are only available.), [Write Through], [Write Protect], or [Write Back]. The factory default setting is as follows.

A000 - AFFF	Disabled
B000 - BFFF	Disabled
C800 - CBFF	Write Protect (VIDEO Memory)
CC00 - CFFF	Write Protect
D000 - D3FF	Disabled
D400 - D7FF	Disabled
D800 - DBFF	Disabled
DC00 - DFFF	Disabled
E000 - E3FF	Disabled
E400 - E7FF	Write Protect (PXE)
E800 - EBFF	Write Protect
EC00 - EFFF	Write Protect

■ PCI Configuration

Specifies the PCI IRQ parameters. Point the cursor to the [PCI Configuration] on the [Advanced] screen and press the [Enter] Key, so that the following screen will be displayed.

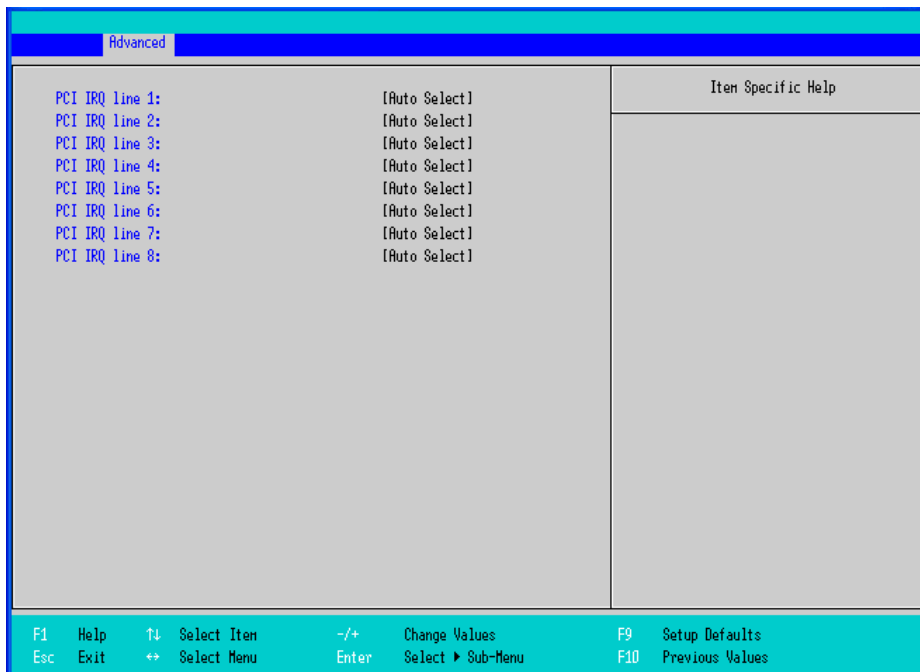

PCI IRQ line 1 to 8

Specifies the Interrupt Request Lines (IRQ) for PCI. Select from [Disabled], [Auto Select], [3], [4], [5], [7], [10], [11], [12], [14], or [15]. The factory default setting is [Auto Select].

■ DMI Event Logging

Specifies the parameters related to DMI event logging. Point the cursor to the [DMI Event Logging] on the [Advanced] screen and press the [Enter] Key, so that the following screen will be displayed.

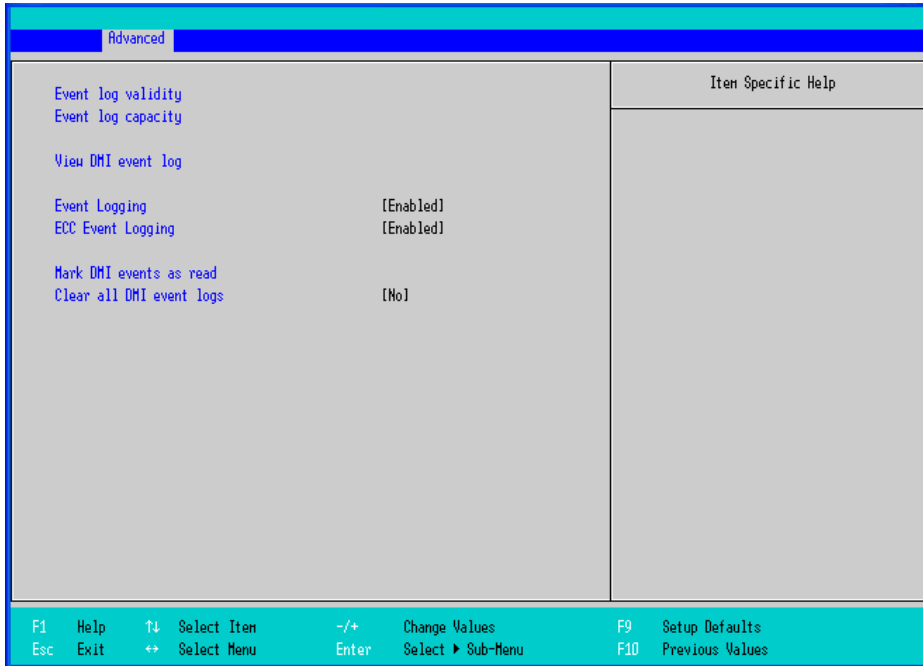

Event log validity

Shows the status of the event log storage area. [Valid] is shown when the status is normal, and [Not valid] is shown when the status is abnormal.

Event log capacity

Shows the status of the area to which event logs are written. [Full] is shown when the area is full, and [Space Available] is shown when the area is not full.

View DMI event log

Point the cursor to [View DMI event log] and press the [Enter] Key to view the DMI event logs.

Event Logging

Specifies whether event logs need to be recorded. Select from [Enabled] or [Disabled]. The factory default setting is [Enabled].

ECC Event Logging

Specifies whether the event logs related to memory ECC need to be recorded. Select from [Enabled] or [Disabled]. The factory default setting is [Enabled].

Mark DMI events as read

Point the cursor to [Mark DMI events as read] and press the [Enter] Key to mark unread event logs as read.

Clear all DMI event logs

Specifies whether all the recorded DMI event logs need to be deleted. Select from [Yes] or [No]. The factory default setting is [No].

2.2.3 Intel

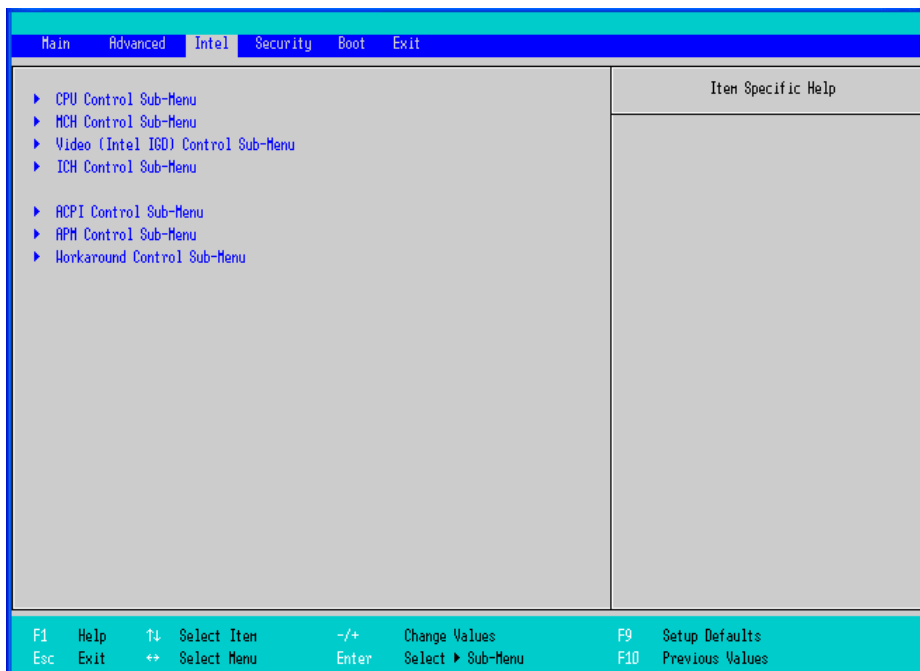

CPU Control Sub-Menu

Point the cursor to the [CPU Control Sub-Menu] on the [Intel] menu and press the [Enter] Key, so that you can go to the CPU set-up screen.

SEE → ■ *CPU Control Sub-Menu (page2-18)*

MCH Control Sub-Menu

Point the cursor to the [MCH Control Sub-Menu] on the [Intel] menu and press the [Enter] Key, so that you can go to the MCH set-up screen.

SEE → ■ *MCH Control Sub-Menu (page2-19)*

Video (Intel IGD) Control Sub-Menu

Point the cursor to the [Video (Intel IGD) Control Sub-Menu] on the [Intel] menu and press the [Enter] Key, so that you can go to the set-up screen for display.

SEE → ■ *Video (Intel IGD) Control Sub-Menu (page2-21)*

ICH Control Sub-Menu

Point the cursor to the [ICH Control Sub-Menu] on the [Intel] menu and press the [Enter] Key, so that you can go to the ICH set-up screen.

SEE → ■ *ICH Control Sub-Menu (page2-22)*

ACPI Control Sub-Menu

Point the cursor to the [ACPI Control Sub-Menu] on the [Intel] menu and press the [Enter] Key, so that you can go to the ACPI set-up screen.

SEE → ■ *ACPI Control Sub-Menu (page2-24)*

APM Control Sub-Menu

Point the cursor to the [APM Control Sub-Menu] on the [Intel] menu and press the [Enter] Key, so that you can go to the APM set-up screen. If you use APM OS, you are requested to set up this configuration.

SEE → ■ *APM Control Sub-Menu (page2-25)*

Workaround Control Sub-Menu

Point the cursor to the [Workaround Control Sub-Menu] on the [Intel] menu and press the [Enter] Key, so that you can go to the set-up screen of the whole platform.

SEE → ■ *Workaround Control Sub-Menu (page2-26)*

■ CPU Control Sub-Menu

Specifies the CPU parameters. Point the cursor to the [CPU Control Sub-Menu] on the [Intel] menu and press the [Enter] Key, so that the following screen will be displayed.

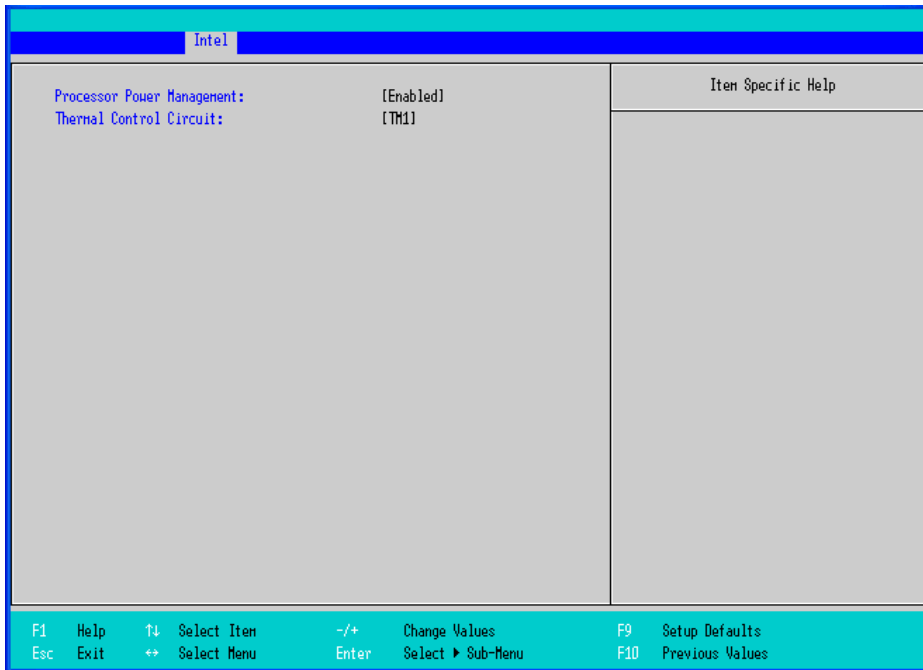

Processor Power Management

This is a function that controls the processor’s power state. Select from [Disabled] or [C States Only]. The factory default setting is [Enabled] and the default should be applied.

Thermal Control Circuit

This is a function that protects the CPU's temperature, and its setting is a situation that if it exceeds the limit that CPU is able to work properly. Select from [Disabled], [TM1], or [TM2]. The factory default setting is [TM1].

■ MCH Control Sub-Menu

Specifies the MCH control parameters. Point the cursor to the [MCH Control Sub-Menu] on the [Intel] menu and press the [Enter] Key, so that the following screen will be displayed.

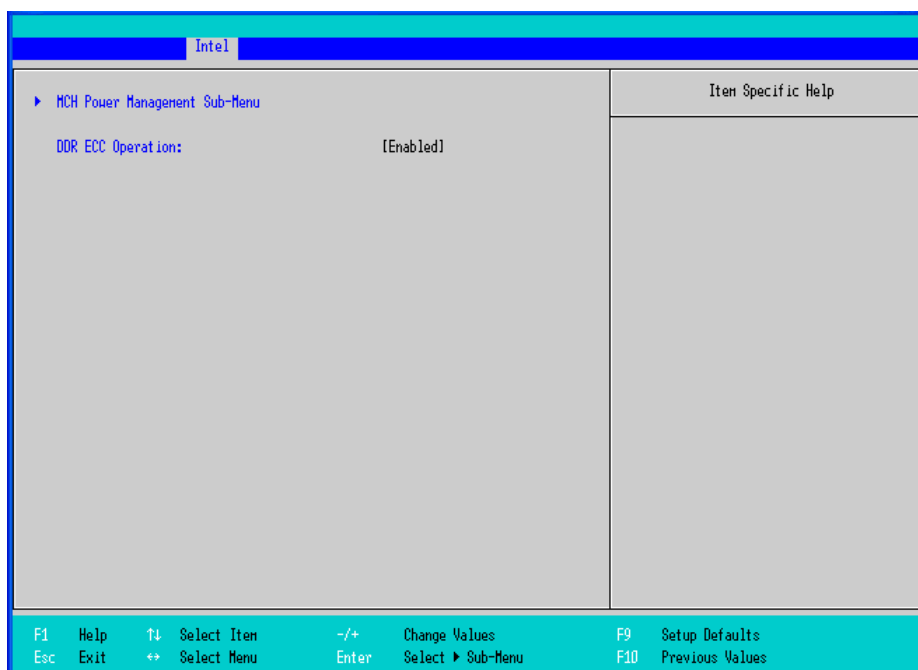

MCH Power Management Sub-Menu

Point the cursor to the [MCH Power Management Sub-Menu] on the [Intel] menu and press the [Enter] Key, so that you can go to the Chipset set-up screen.

SEE → ◆ *MCH Power Management Sub-Menu (page2-20)*

DDR ECC Operation

Specifies whether you use ECC memory or not. Select from [Enabled] or [Disabled]. The factory default setting is [Enabled].

◆ MCH Power Management Sub-Menu

Specifies the chipset (MCH) parameters. Point the cursor to the [MCH Power Management Sub-Menu] on the [Intel] menu and press the [Enter] Key, so that the following screen will be displayed.

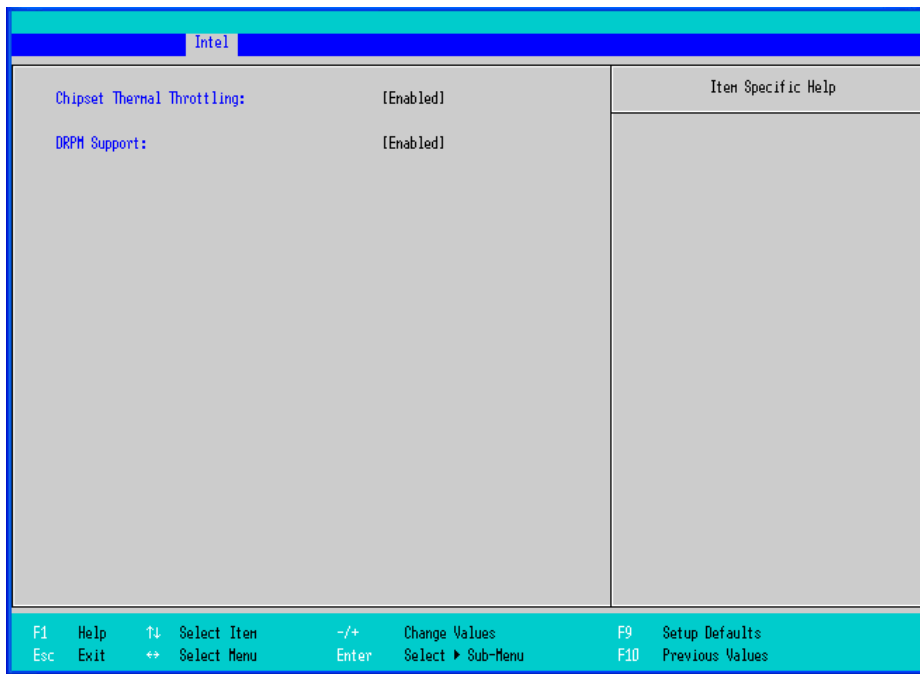

Chipset Thermal Throttling

Specifies a thermal throttle, a system to prevent a themorunway, for chipset. Select from [Enabled] or [Disabled]. The factory default setting is [Enabled].

DRPM Support

Specifies an enabled/disabled state for the setting of Dynamic Row Power Management. Select from [Enabled] or [Disabled]. The factory default setting is [Enabled].

■ Video (Intel IGD) Control Sub-Menu

Specifies the display-related parameters. Point the cursor to the [Video (Intel IGD) Control Sub-Menu] on the [Intel] menu and press the [Enter] Key, so that the following screen will be displayed.

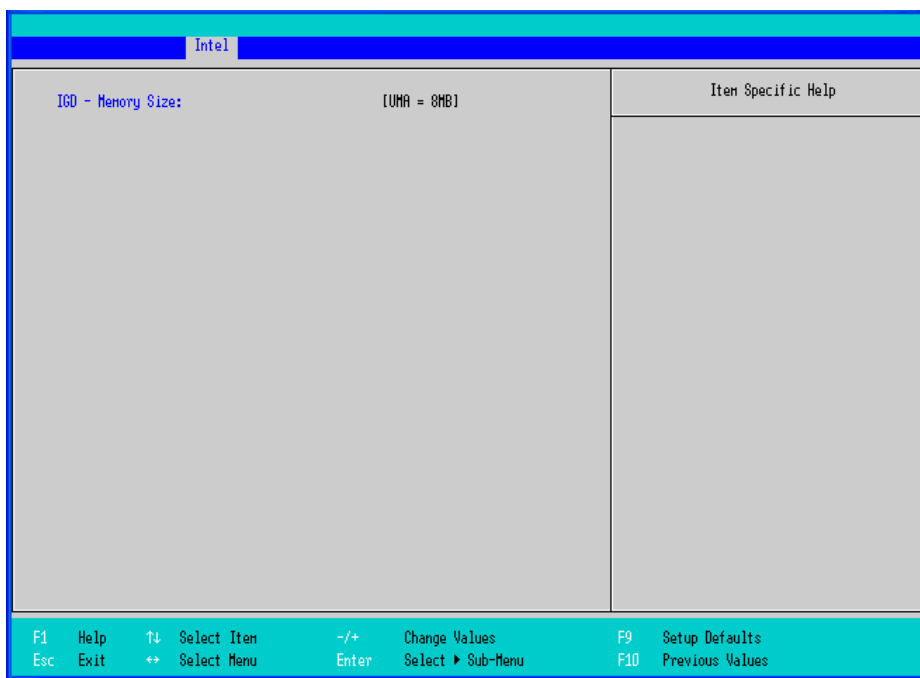

IGD-Memory Size

Specifies an allocation capacity for the Video Memory. Select from [UMA=1MB], [UMA=8MB], [UMA=16MB], or [UMA=32MB], the factory default setting is [UMA=8MB].

■ ICH Control Sub-Menu

Specifies the chipset (ICH) parameters. Point the cursor to the [ICH Control Sub-Menu] on the [Intel] menu and press the [Enter] Key, so that the following screen will be displayed.

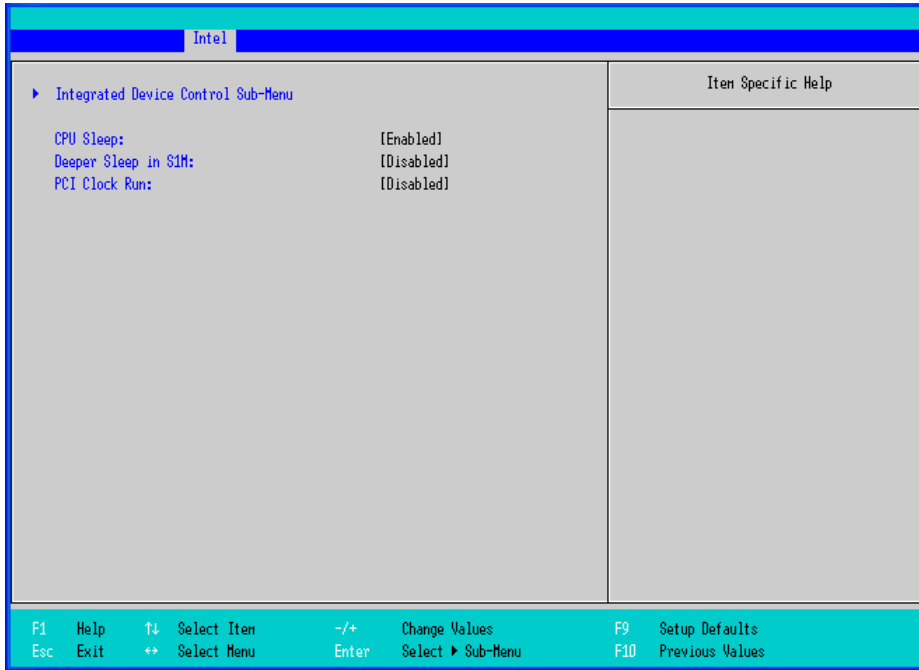

Integrated Device Control Sub-Menu

Point the cursor to the [Integrated Device Control Sub-Menu] on the [Intel] menu and press the [Enter] Key, so that you can go to the setting screen where an enabled/disabled state for the USB, LAN and PCMCIA is specified.

SEE → ◆ *Integrated Device Control Sub-Menu (page2-23)*

CPU Sleep

Specifies an enabled/disabled state for the CPU power saving. Select from [Enabled] or [Disabled]. The factory default setting is [Enabled].

Deeper Sleep in S1M

Specifies an enabled/disabled state for the Deeper Sleep mode. Select from [Enabled] or [Disabled]. The factory default setting is [Disabled].

PCI Clock Run

Specifies an enabled/disabled state for the PCI Clock Run protocols for Cardbus Controller. Select from [Enabled] or [Disabled]. The factory default setting is [Disabled].

◆ Integrated Device Control Sub-Menu

Specifies whether to enable or disable USB, LAN, and PCMCIA. In [ICH Control Sub-Menu], point the cursor to the [Integrated Device Control Sub-Menu] and press the [Enter] Key to display the following screen.

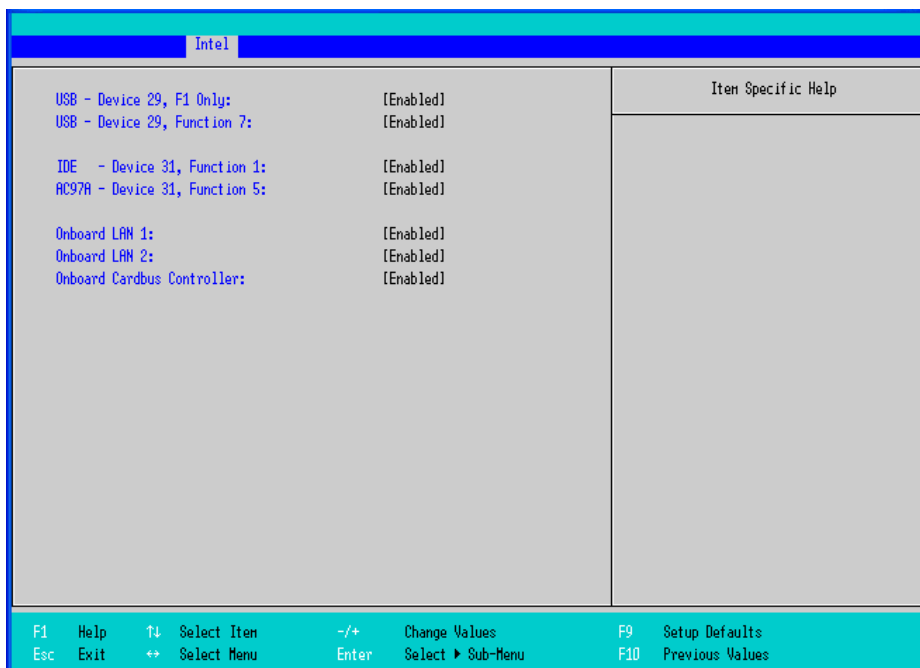

USB-Device 29, F1 only / USB-Device 29, Function 7

Specifies an enabled/disabled state for the USB device. Select from [Enabled] or [Disabled]. The factory default setting is [Enabled].

IDE-Device 31, Function 1

Specifies an enabled/disabled state for the IDE device. Select from [Enabled] or [Disabled]. The factory default setting is [Enabled].

AC97A-Device 31, Function 5

Specifies an enabled/disabled state for the AC97 Audio. Select from [Enabled] or [Disabled]. The factory default setting is [Enabled].

Onboard LAN 1, 2

Specifies an enabled/disabled state for the Onboard LAN 1,2. The choice is [Enabled] or [Disabled]. The factory default setting is [Enabled].

Onboard Cardbus Controller

Specifies an enabled/disabled state for the PCMCIA slot. The choice is [Enabled] or [Disabled]. The factory default setting is [Enabled].

■ ACPI Control Sub-Menu

Point the cursor to the [ACPI Control Sub-Menu] on the [Intel] menu and press the [Enter] Key, so that the following screen will be displayed.

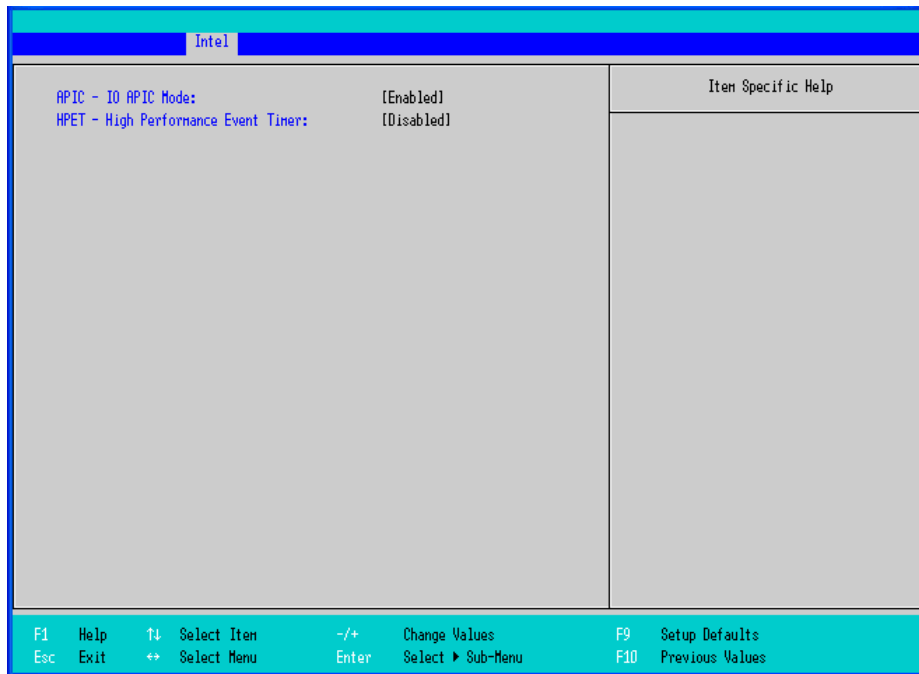

ACPI-IO APIC Mode

Specifies an enabled/disabled state for the APIC. Select from [Enabled] or [Disabled]. The factory default setting is [Enabled].

HPET-High Performance Event Timer

Specifies the timer setting for the High Precision Event Timer. Select from [Enabled] or [Disabled]. The factory default setting is [Disabled].

■ APM Control Sub-Menu

Point the cursor to the [APM Control Sub-Menu] on the [Intel] menu and press the [Enter] Key, so that the following screen will be displayed.

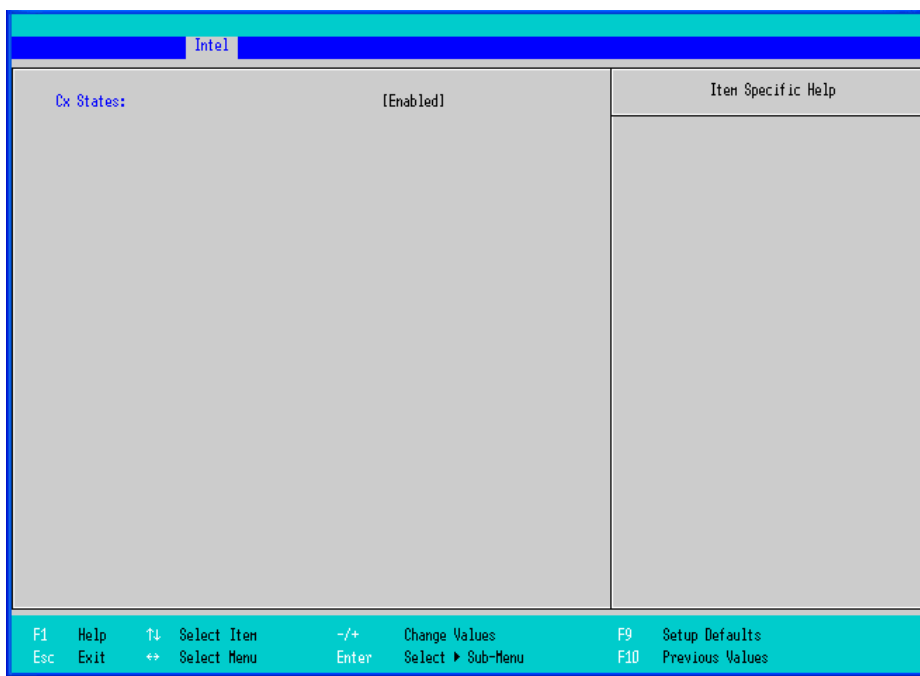

Cx States

Specifies whether you use a power saving state when using APM OS. Select from [Enabled] or [Disabled].

The factory default setting is [Enabled].

■ Workaround Control Sub-Menu

Point the cursor to the [Workaround Control Sub-Menu] on the [Intel] menu and press the [Enter] Key, so that the following screen will be displayed.

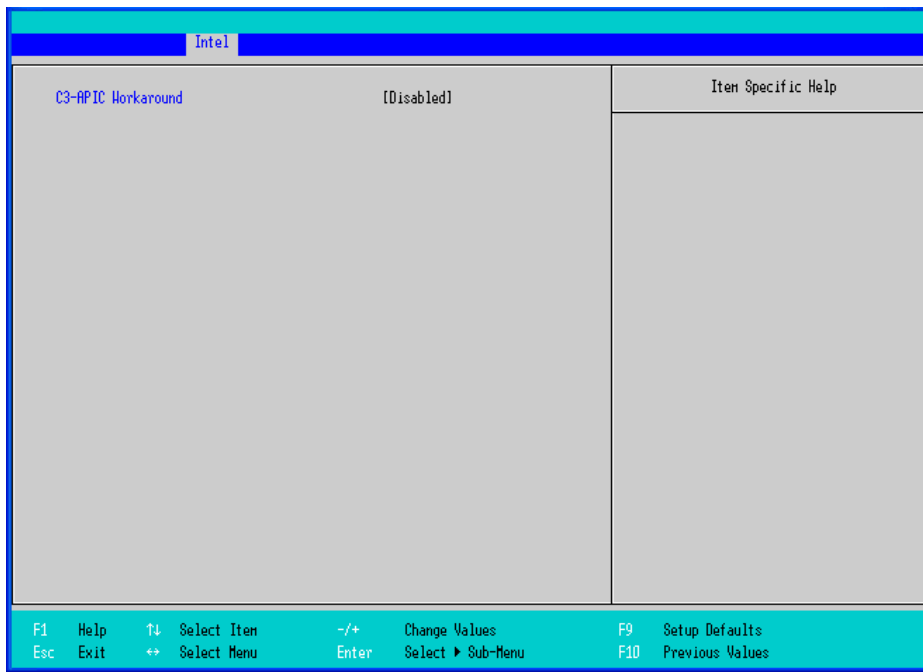

C3-APIC Workaround

Select from [Enabled], [Auto], or [Disabled]. The factory default setting is [Disabled].

2.2.4 Security

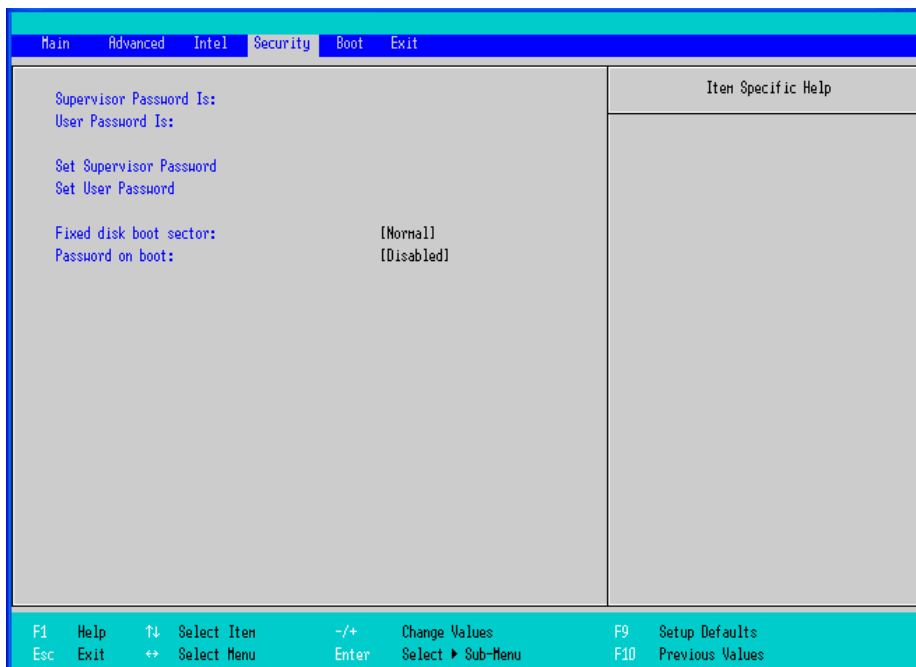

Supervisor Password Is

Displayed as “Set” when the password is set. Since no password has been set at factories, the factory default setting is [Clear].

User Password Is

Displayed as “Set” when the password is set. Since no password has been set at factory, the factory default setting is [Clear]. Note that BIOS setting is not allowed with a User Password.

Set Supervisor Password / Set User Password

Specifies a password. When any password is not needed, do not input any values in the new password setting and press just the [Enter] key.

Fixed disk boot sector

Specifies whether writing into the boot sector on the unit is not allowed. Select from [Normal] or [Write Protect]. The factory default setting is [Normal].

Password on boot

Specifies whether a password should be needed at the Start-Up. Select from [Enabled] or [Disabled]. The factory default setting is [Disabled].

2.2.5 Boot

Specifies an order for boot-up devices. The boot-up devices are specified in the Boot priority order list and are searched for from the top of the list in sequence. By using the [+] or [-] keys, change its order. To change the device to be booted up, use the [x] key to move the device from the Boot priority order list to the Excluded from boot order list and vice versa.

- NOTE**
- When a new hard disk or commercial USB memory which does not require boot-up is connected and such a device is given high priority in the Boot priority order list, the system may not boot up properly. Be sure to check the order of the devices in the Boot priority order list after you connect a new device.

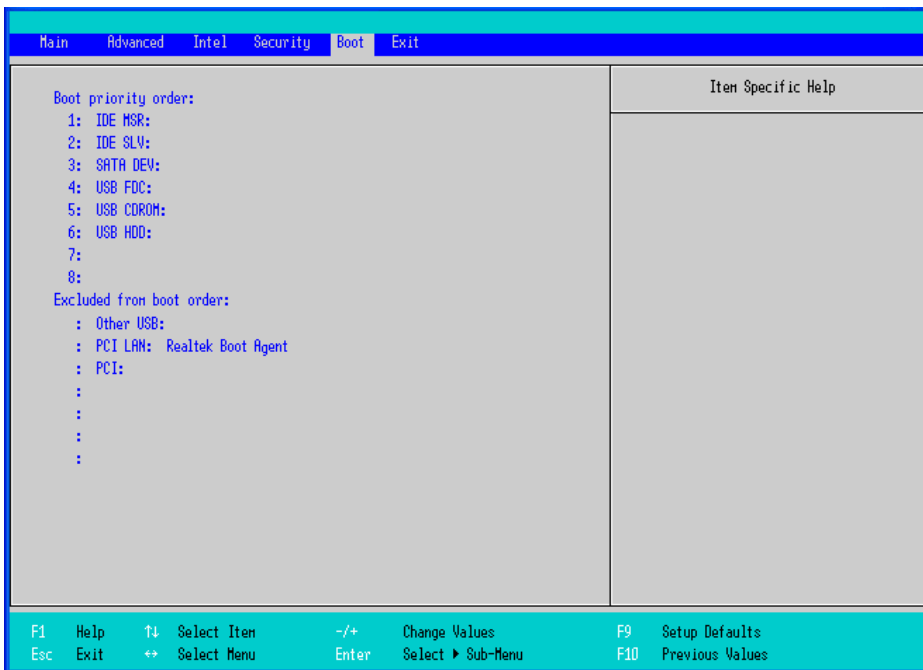

Boot priority order

Specifies the order of the boot-up devices. The factory default settings are as follows:

- | | | | |
|----|-----------|---|----------------------------|
| 1: | IDE MSR | : | IDE Master Device |
| 2: | IDE SLV | : | IDE Slave Device |
| 3: | SATA DEV | : | SATA Strage Device |
| 4: | USB FDC | : | USB Floppy Disk Driver |
| 5: | USB CDROM | : | USB CDROM (DVD ROM) Driver |
| 6: | USB HDD | : | USB Memory, etc. |
| 7: | | | |

Exluded from boot order

- | | | | |
|---|-----------|---|------------------------------------|
| : | Other USB | : | Other USB media |
| : | PCI LAN | : | LAN 2 (GigaBit Ether) PXE Boot ROM |
| : | PCI | : | Other PCI device |

2.2.6 Exit

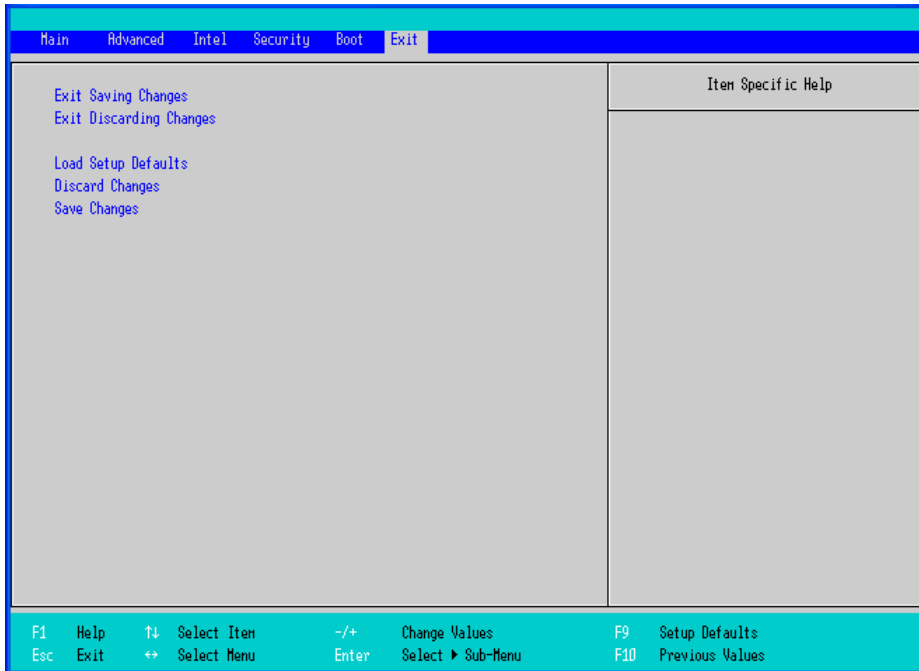

Exit Saving Changes

Point the cursor to the [Exit Saving Changes] on the [Exit] menu and press the [Enter] Key, the current configuration is saved and the setting procedure is ended.

Exit Discarding Changes

Point the cursor to the [Exit Discarding Changes] on the [Exit] menu and press the [Enter] Key, the current configuration is NOT saved but the setting procedure is ended.

Load Setup Defaults

Point the cursor to the [Load Setup Defaults] on the [Exit] menu and press the [Enter] Key, all of the current configuration is back to the factory default settings.

Discard Changes

Point the cursor to the [Discard Changes] on the [Exit] menu and press the [Enter] Key, the current modified configuration is canceled and the previous setting values are reloaded.

Save Changes

Point the cursor to the [Save Changes] on the [Exit] menu and press the [Enter] Key, the current configuration which you modified is saved.

3

PS-A Monitoring Features

1. RAS Features
2. Setting Menus
3. Monitoring the PS-A Status
4. Checking the Status of the PS-A Being Monitored
5. Checking the Error Log List
6. Monitoring Errors/Alerts from a Remote Server
7. Restarting/Shutting Down the PS-A from a Remote Server
8. Setup Guide for the System Monitor Property
9. Setup Guide for the System Monitor Screen
10. Displayed Messages
11. Restrictions

This chapter describes various ways to monitor the status of the PS-A.

3.1 RAS Features

3.1.1 RAS Features

IMPORTANT

- The RAS (Reliability Availability Serviceability) feature is supported only by the models equipped with a RAS port.

■ Errors/Alerts which can be Detected by RAS Features

RAS is a device-level monitoring function that provides a variety of features to improve the reliability of your PS-A system.

Though the standard set of RAS features used will vary depending on the devices used, the following features are used to provide Error/Alert Monitoring and External Input Signal support.

NOTE

- For the setting procedures for the RAS features, refer to the following.

SEE → 3.8 Setup Guide for the System Monitor Property (page3-28)

<p>Error/Alert Monitoring</p>	<ul style="list-style-type: none"> • Power Voltage Alarm Monitors the status of the PS-A unit’s built-in power supply and internal CPU power supply. • Cooling Fan RPM Alarm Monitors the CPU cooling fan RPM speeds. • Internal Temperature Alarm Monitors the internal temperature of the PS-A unit and the ambient temperature of the CPU. • Watchdog Timer Timeup • Touch Panel Alarm Monitors the status of the touch panel. • Backlight Alarm Monitors the status of the backlight. • SMART Alert Monitors the status of the hard disk and notifies the user that the disk should be exchanged before malfunction occurs.
<p>External Input Signal</p>	<p>General-Purpose Input ^{*1} (DIN 2-bit) Remote Reset Input ^{*2} (1 lamp)</p> <p>SEE → ◆ External Input Signals (page3-6)</p>

*1: General-Purpose Input will maintain Input Information.

*2: The remote reset feature’s input can be either enabled or disabled, however, the setting of DOUT output state cannot be set to trigger a forced system reset.

IMPORTANT

- An administrator Authentication is required for executing SMART Monitoring.
- A CF card doesn’t support SMART and therefore the status of the CF card cannot be monitored.
- When a hard disk except options made by Pro-face is used, the operation of SMART Monitoring cannot be guaranteed.

■ Error/Alert Notification

Also, when either the one of the above mentioned error/alert occurs, or an external signal input is received, the following types of alarm processing output signals and features are supported by the PS-A.

<p>External Output Signal</p>	<p>General-Purpose Output (DOUT 2-bit)</p> <p>SEE → ◆ <i>External Input Signals (page3-6)</i></p>
<p>Various Processing Functions</p>	<ul style="list-style-type: none"> • LED Indicator (3 colors, 1 lamp) The three-color LED on the front face is used to indicate the PS-A system conditions. It is also used as a power ON/OFF indicator. <p>SEE → ◆ <i>LED Indicator (page3-5)</i></p> <ul style="list-style-type: none"> • Pop-up Message Output This feature displays the system status via a Windows® pop-up message. • Buzzer Output This feature uses the PS-A unit’s built-in speaker to alert the operator about the system status. • System Shutdown This feature shuts down the PS-A unit’s OS. • System Reset This feature resets the system when the Watchdog Timer reaches “time up”.

Use the included System Monitor feature (utility software) to enable/disable the monitoring features and to set the alarm processing details.

SEE → 3.3 *Monitoring the PS-A Status (page3-11)*

In addition, you can use the included dynamic link library (API-DLL) to access the RAS features from user-created applications.

SEE → *Otasuke Pro! “PS-3650A/PS-3651A Series Reference Manual”*
<http://www.pro-face.com/otasuke/>

■ RAS Feature Overview

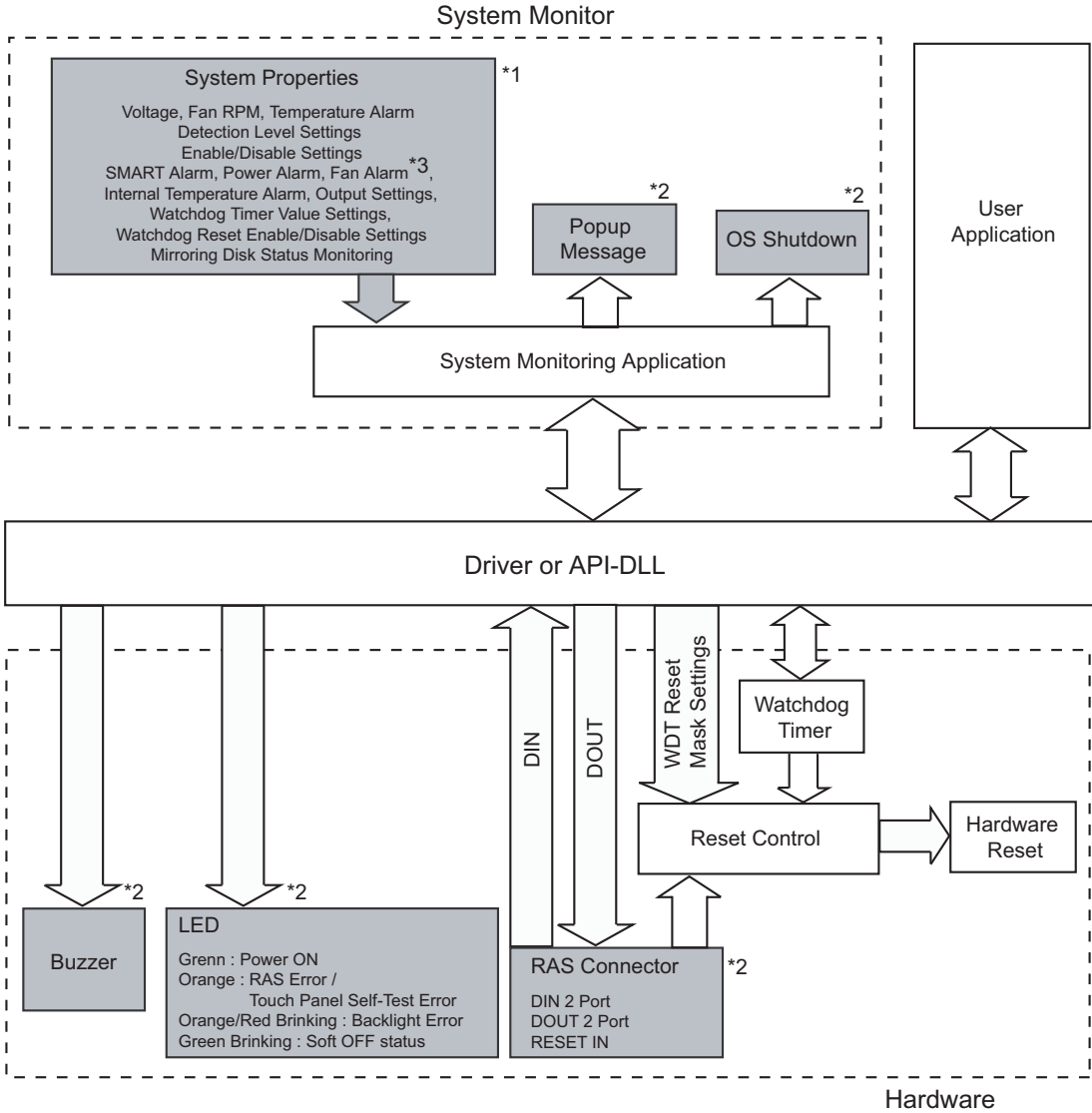

*1 Be sure to adjust these settings according to your system's specifications.

SEE → 3.3 Monitoring the PS-A Status (page3-11)

*2 Output via the RAS feature.

*3 The PS-3651A has no fans.

■ Error/Alert Notification

The method for notifying or handling errors/alerts can be selected from the following:

◆ LED Indicator

LED Color	System Status	output condition
Green (Lit)	Normal Operation (Power is ON)	None
Green (Blinking)	System is NOT running (Soft OFF)	None
Orange (Lit)	A RAS error/alert occurred	LED setting is enabled in the system monitor properties.
		None
Not Lit	Power is OFF	—
Orange/Red (Blinking)	Backlight error	None

◆ Pop-up Message Output

This feature displays system status via a Windows[®] pop-up message.

System Monitor Property is used to enable or disable this feature.

◆ Buzzer Output

This feature uses the PS-A unit's built-in speaker to alert the operator about the PS-A system status.

System Monitor Property is used to enable or disable this feature.

◆ System Shutdown

This feature shuts down the PS-A unit's OS.

System Monitor Property is used to enable or disable this feature.

◆ System Reset

This feature resets the system when the Watchdog Timer reaches "time up".

System Monitor Property is used to enable or disable this feature.

◆ External Input Signals

The PS-A’s RAS interface connector uses the following input signals.

- General-Purpose Input (DIN 2 bits)

This standard digital input is used for error/alert detection in external devices. The input signal uses two bits. The System Monitor property of the control panel or the API-DLL can be used to enable or disable this feature, as well as designate what type of processing is to be performed once a signal is received. (Only the “ON” state of the DIN circuit is detected. The “OFF” state of the DIN circuit cannot be monitored.)

- Remote Reset Input

This is the reset signal sent from an external device to the PS-A. When this signal is enabled, a forced reset of the PS-A is performed.

The System Monitor property of the control panel or the API-DLL can be used to enable or disable this feature.

- NOTE** • To enable Remote Reset Input, make sure to check the [Enable] in the Remote reset tab of System Monitor Property. For Remote reset of System Monitor Property, refer to the following.
- SEE →** 3.8.5 Remote reset (page3-33)

Input Voltage		DC12V to 24V
Input Method		Sink / Source Input
Input Current		10mA (DC24V)
Input Resistance		3.6kΩ
Input Points		2 points (common with external reset input)
Operation Range	ON voltage	DC10V or more
	OFF voltage	DC3V or less
Isolation Method		Photocoupler Isolation
Dielectric Strength Voltage		500V or more

(Interface Circuit)

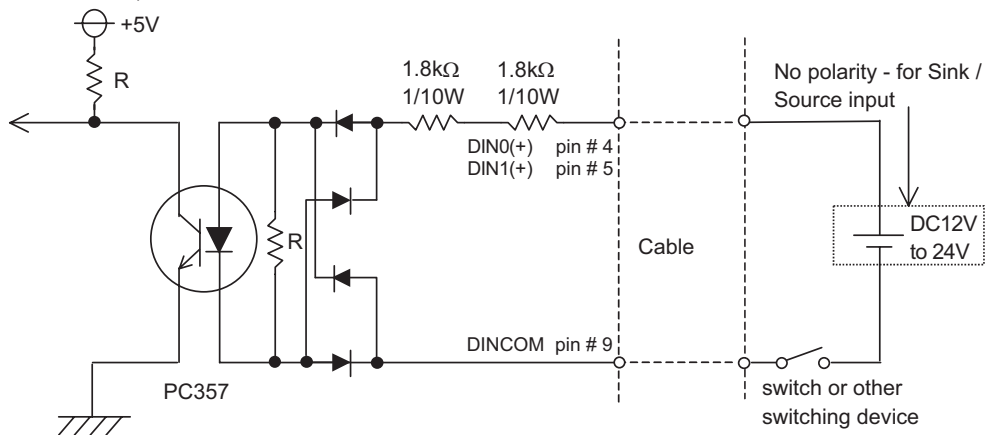

IMPORTANT

- General-Purpose Input (DIN) level must be 1.5 seconds or longer to be detected. It may not detect under 1.5 seconds.
- Be sure the voltage value between terminals is controlled via the input voltage, so that the PS-A is operated within its recommended range. If the input voltage exceeds this range, a malfunction or PS-A damage may occur.
- With Sink/Source input, even if the D(-), and RESET(-) are positive, and D(+), RESET(+) are negative, no problems are created. Be sure to operate the unit within the recommended voltage range.

NOTE

- For connection pin location details,
SEE → *PS-3650A/PS3651A Hardware Manual 2 Specifications*

◆ External Output Signal

The PS-A's RAS interface connector uses the following output signals.

- General-Purpose Output (DOUT 2 bits)

This general purpose digital output signal provides system condition information to external devices.

The System Monitor property of the control panel or the API-DLL is used by applications to control this signal.

The above mentioned general purpose digital output signals provide system condition information to external devices.

The System Monitor property can be used to enable or disable any of these output signals.

Rated Voltage	DC12V to 24V
Maximum Load Current	120mA/point
Out Voltage Drop	1.5V or less (at 100mA load current)
Output Points	2 points
Isolation Method	Photocoupler Isolation
Dielectric Strength Voltage	500V or more
External Power Supply	DC12V / 100mA

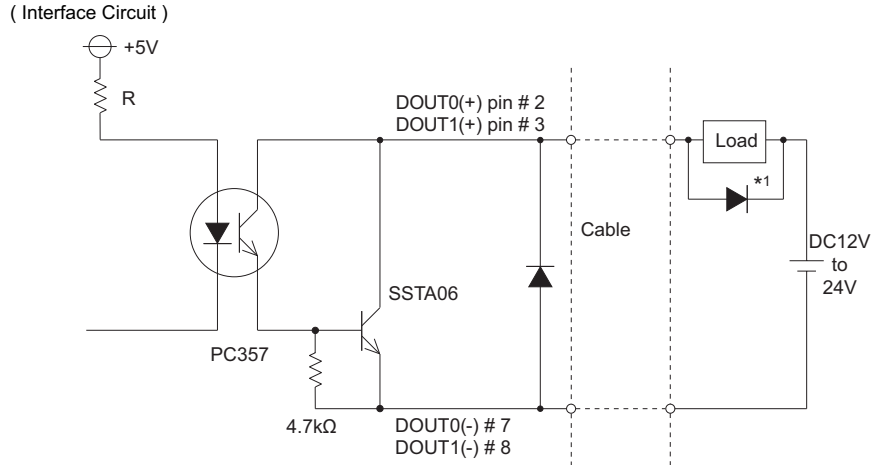

IMPORTANT

- Be sure to operate the unit within its maximum load current. If the maximum load current exceeds this range, a malfunction or PS-A damage may occur.
- Design your electrical system by adding the load current and voltage values to the terminal voltage. If load current value used is large, the voltage drop of 1.5V or less will occur between the terminals.
- When connecting an induction load, be sure to connect the above drawing's protection diode (*1).

NOTE

- For connection pin location details,

SEE →

PS-3650A/PS-3651A Series Hardware Manual 2 Specifications

3.2 Setting Menus

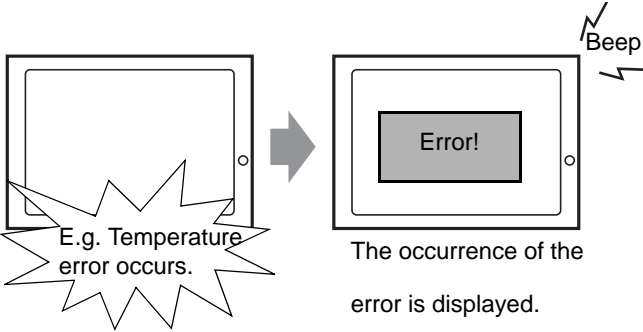
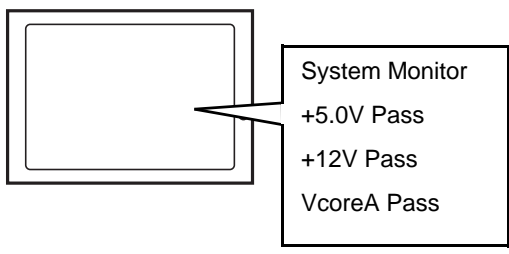
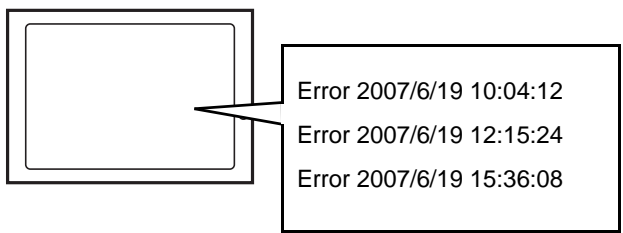
Monitoring the PS-A Status	
 <p>E.g. Temperature error occurs.</p> <p>The occurrence of the error is displayed.</p>	<ul style="list-style-type: none"> ☞ Description (page3-11) ☞ Setup Procedure (page3-11)
Checking the Status of the PS-A Being Monitored	
 <p>System Monitor +5.0V Pass +12V Pass VcoreA Pass</p>	<ul style="list-style-type: none"> ☞ Description (page3-16) ☞ Setup Procedure (page3-16)
Checking the Error Log List	
 <p>Error 2007/6/19 10:04:12 Error 2007/6/19 12:15:24 Error 2007/6/19 15:36:08</p>	<ul style="list-style-type: none"> ☞ Description (page3-17) ☞ Setup Procedure (page3-18)

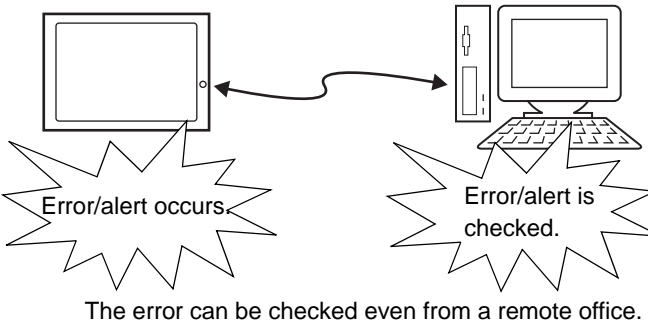
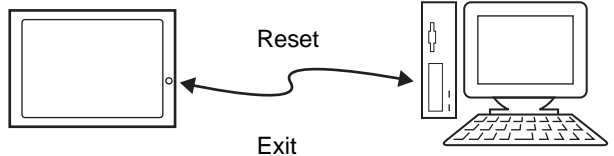
Monitoring Errors from a Remote Server	
 <p style="text-align: center;">The error can be checked even from a remote office.</p>	<ul style="list-style-type: none"> ☞ Description (page3-20) ☞ System Configuration (page3-21) ☞ Monitoring using Pro-Server with Pro-Studio or Pro-Server EX (page3-24)
Restarting/Shutting Down the PS-A from a Remote Server	
<p style="text-align: center;">Via the network</p>  <p style="text-align: center;">Remote operation from an office in a different location</p>	<ul style="list-style-type: none"> ☞ Description (page3-26) ☞ Setup Procedure (page3-27)

3.3 Monitoring the PS-A Status

3.3.1 Description

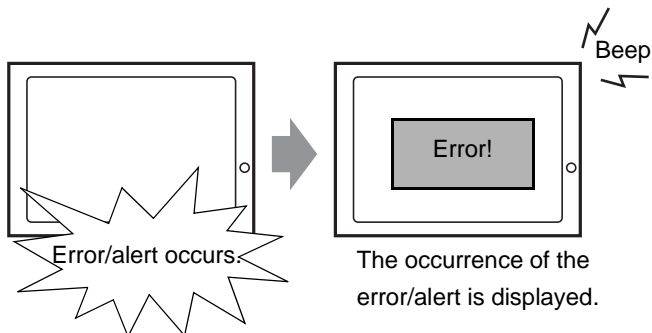

Before starting the setup procedure, specify the items you want to monitor with the RAS features.

When an error/alert occurs, notification is provided according to the specified method.

3.3.2 Setup Procedure

NOTE

- For details about the setup procedure, refer to the Setup Guide.

SEE → 3.9 Setup Guide for the System Monitor Screen (page3-34)

This section describes the procedure to set the PS-A to monitor a temperature error and provide notification with a buzzer and pop-up message.

- (1) Double-click [System Monitor Property] in [Control Panel] to display the [System Monitor Property].
- (2) Select the [Temperature] tab.

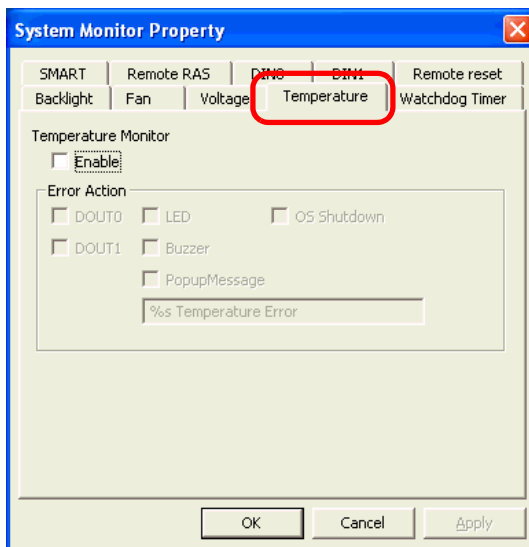

- (3) Check [Enable].

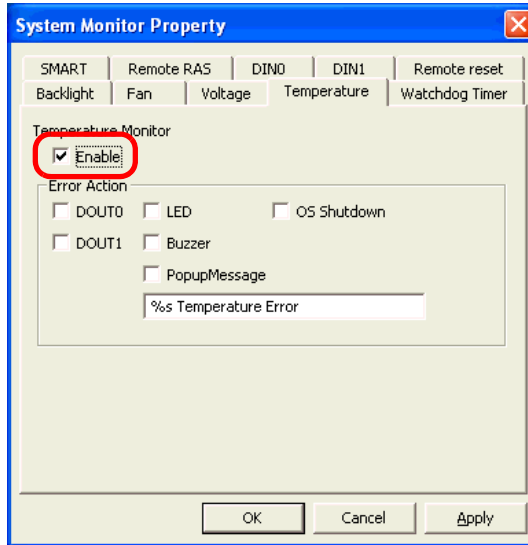

- (4) For [Error Action], check [Buzzer] and [PopupMessage].

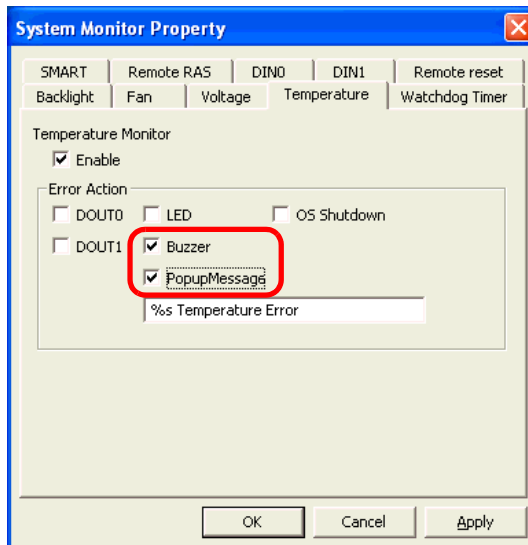

- (5) Click [Apply].
(6) Click [OK] to complete the setting.

When the monitoring starts, the System Monitor icon appears in the task tray.

NOTE

- System Monitor also operates as Windows’s Services. When System Monitor applications do not start, the System Monitor Service execute the RAS events setup in the System Monitor Property. You can check the System Monitor Service’s operation state by selecting [Control Panel] -> [Administrative Tools] -> [Services].

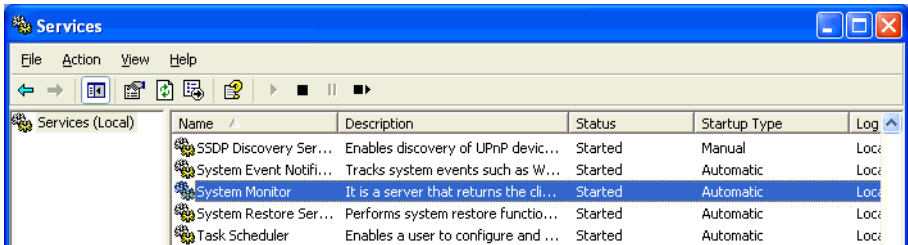

- The pop-up message displayed when the System Monitor Service detects an error/alert differs from ordinary ones.



3.3.3 When an Error Occurs

(1) A buzzer sounds and a pop-up message is displayed.

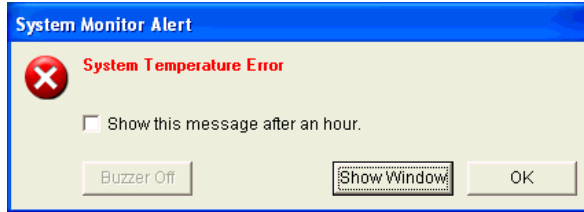

NOTE

- The Error Action is performed only one time when an error is detected for each monitoring item.
- To stop the buzzer, click the [Buzzer Off] button in the pop-up message dialog box. If the pop-up message is hidden, click the [Buzzer Off] button displayed in the [System Monitor] screen.
- You can also display the [System Monitor] screen by pressing [Show Window] on the pop-up message window.
- When you check the [Show this message after an hour] check box and press the [OK] button, the pop-up message window will close and will not open for an hour.

(2) An “x” mark appears on the icon in the System Tray, which indicates an error status, and the icon blinks. You can see the description of the error by double-clicking the icon.

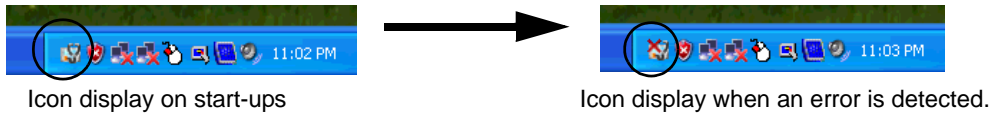

IMPORTANT

- Once an error is detected, the System Monitor holds the “error” status (Icon display indicating error detection). To recover from the error status, press the [Reset] button on the [System Monitor] screen or turn off the PS-A. After that, perform maintenance service for removing the cause of the error factor, and then turn on the power again.

3.3.4 When an Alert Occurs

(1) A buzzer sounds and a pop-up message is displayed.



NOTE

- The Alert Action is performed only one time when an alert is detected for each monitoring item.
- To stop the buzzer, click the [Buzzer Off] button in the pop-up message dialog box.
If the pop-up message is hidden, click the [Buzzer Off] button displayed in the [System Monitor] screen.
- You can also display the [System Monitor] screen by pressing [Show Window] on the pop-up message window.
- If you do not wish to have the pop-up message displayed again, put a check mark in the [Do not show this message again] checkbox.
Set the amount of days that the pop-up message will not be displayed in the * section of [Do not show this message for * days.] The amount of days can be set within a period ranging from 1 to 65,535 days.

(2) An “x” mark appears on the icon in the System Tray, which indicates an alert status, and the icon blinks. You can see the description of the alert by double-clicking the icon.

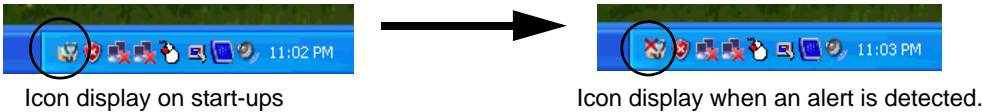

IMPORTANT

- Once an alert is detected, the System Monitor holds the “alert” status (Icon display indicating alert detection). To recover from the error status, press the [Reset] button on the [System Monitor] screen or turn off the PS-A. After that, perform maintenance service for removing the cause of the alert factor, and then turn on the power again.

3.4 Checking the Status of the PS-A Being Monitored

3.4.1 Description

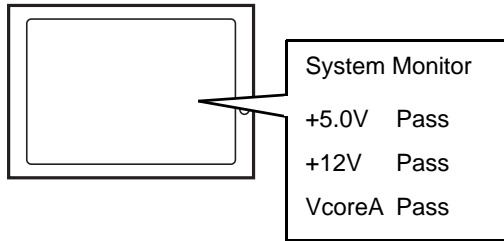

Check the status of the PS-A being monitored with the RAS features from the System Monitor screen. You can also use this screen to check error/alert details.

3.4.2 Setup Procedure

NOTE • For details about the setup procedure, refer to the Setup Guide.
SEE → 3.9 Setup Guide for the System Monitor Screen (page3-34)

- (1) When the System Monitor starts, the System Monitor icon appears on the task bar. Double-click the System Monitor icon to display the System Monitor screen.

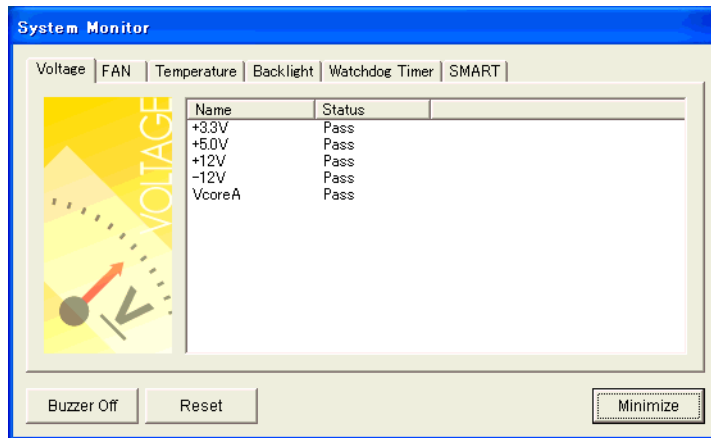

- (2) Click the tab of the item you want to check.

NOTE • When an error/alert occurs, the color of the corresponding tab changes.
 • As for Device No. of SMART, [0] means Master or HDD0 and [1] means Slave or HDD1.

3.5 Checking the Error Log List

3.5.1 Description

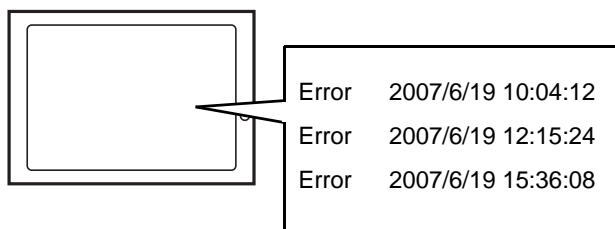

Check the location and action of the previous error/alert on the Event Viewer screen.

3.5.2 Setup Procedure

- (1) Select [Control Panel] - [Administrative Tools] - [Event Viewer] to display the Event Viewer screen.
Select [System] to display the system log list.

NOTE • The Hardware Reset from a Watchdog Timer Error and the reset input for the RAS port cannot be logged.

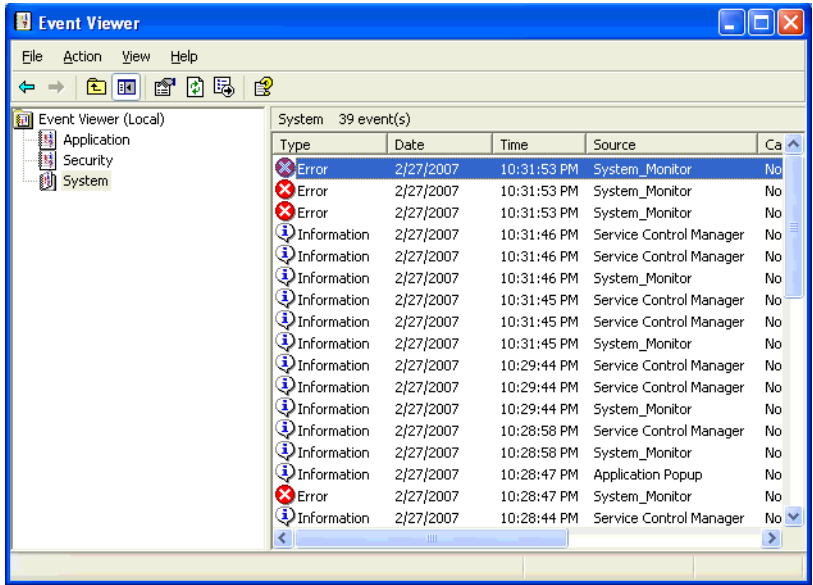

- (2) Error logs can be recognized by [System Monitor] displayed in the Source column.
Select the row of the error log you want to check and double-click it.

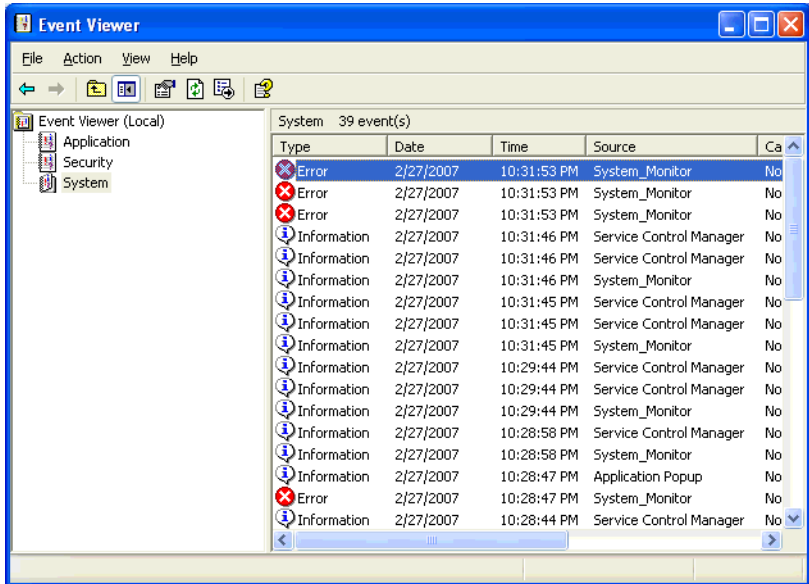

(3) The [Event Properties] screen appears.

The error message is displayed in the [Description] area.

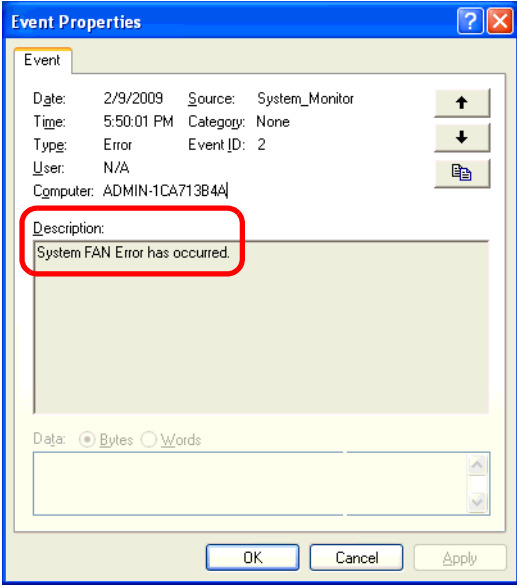

3.6 Monitoring Errors/Alerts from a Remote Server

3.6.1 Description

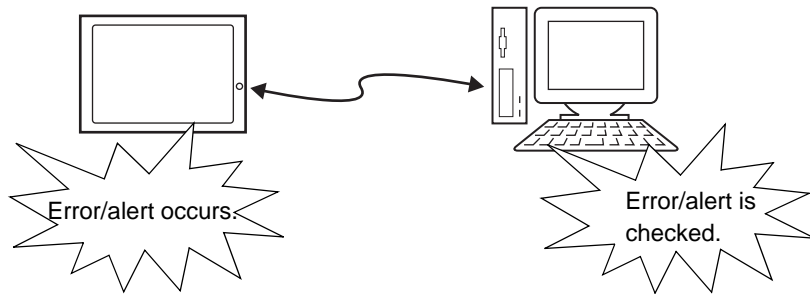

Monitor and control the System Monitor/RAS features remotely via the host PC in which Pro-face's Pro-Server with Pro-Studio (optional) or Pro-Server EX (optional) is installed.

To use this feature, you need Pro-Server with Pro-Studio Ver. 3.12 or higher, or, Pro-Server EX Ver.1.20 or higher. Please also refer to the manuals of the Pro-Server.

SEE → [3.6.3 Monitoring using Pro-Server with Pro-Studio or Pro-Server EX \(page3-24\)](#)

3.6.2 System Configuration

The system employing this feature is configured as illustrated below.

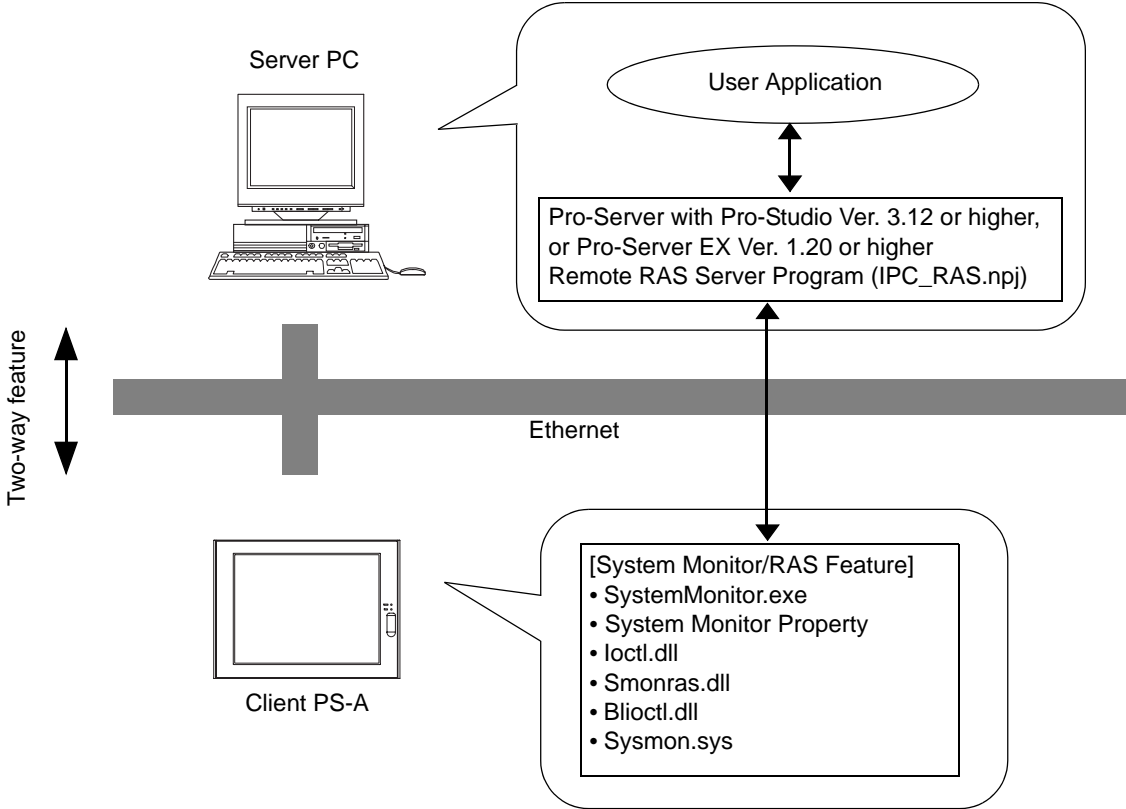

The status of the System Monitor/RAS feature is transferred to the Pro-Server via Ethernet from the System-Monitor.exe. This allows users to monitor errors/alerts by monitoring the device address assigned by Pro-Studio in which the shared memory has been stored.

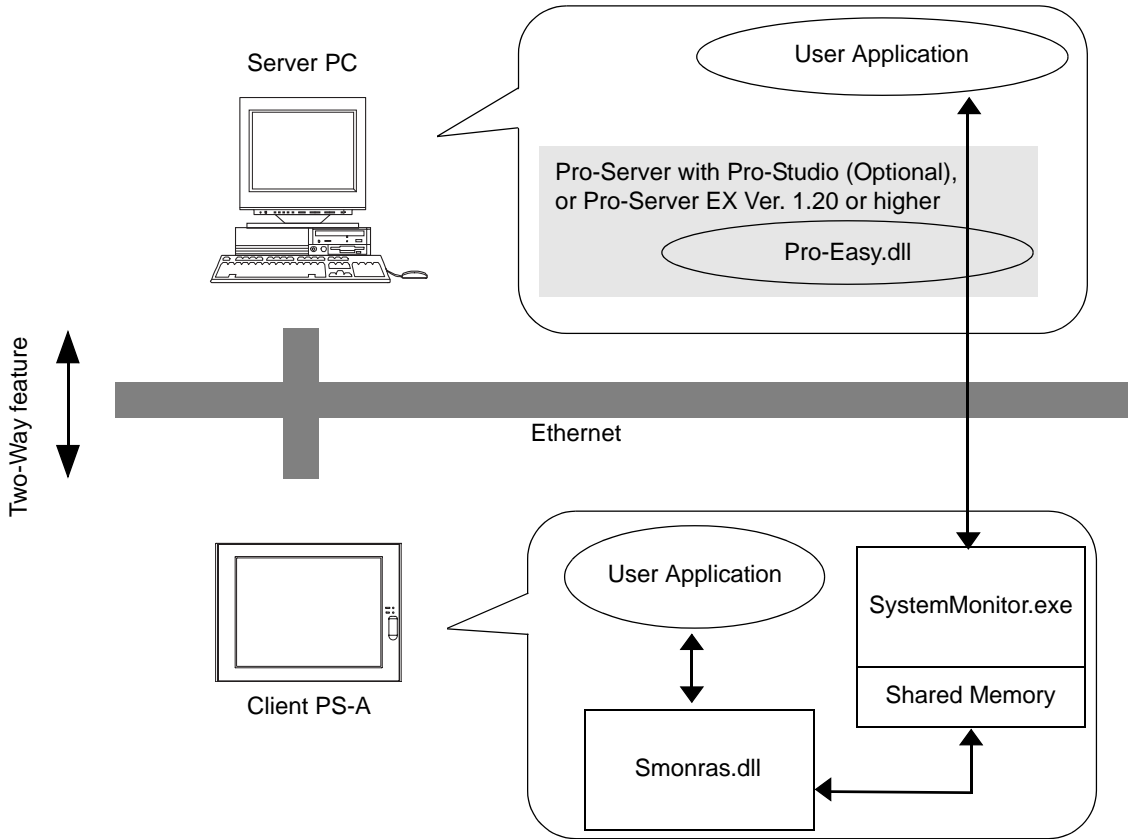

The user applications in the server PC monitors the RAS feature through the Pro-Easy.dll program provided from the Pro-Server.

The client PS-A shares the data with the user applications on the server PC by using the shared memory. The data transfers on both sides are processed via the Smonras.dll and Pro-Easy.dll programs.

■ List of Device Addresses

Device	Device Type	Device Symbol	Read/Write	Bit Access	16-bit Access	32-bit Access
VcoreA* ¹	WORD	VLT	Read	—	VLT0	—
+3.3V* ¹	WORD				VLT2	
+5.0V* ¹	WORD				VLT3	
+12V* ¹	WORD				VLT4	
-12V* ¹	WORD				VLT6	
Number of Revolution of System FAN * ²	WORD	FAN			FAN1	
System Temperature * ³	WORD	TMP			TMP0	
CPU Temperature * ³	WORD		TMP1			
DIN	WORD	DIN		DIN00-DIN01	DIN0	
DOUT	WORD	DOUT	Read/Write	DOUT00-DOUT01	DOUT0	
Error Event	WORD	ERR	Read	ERR00-ERR10	ERR0 ERR1	
Internal Memory Area * ⁴	WORD	LS	Read/Write	LS0000-LS0000F to LS02550-LS0255F	LS0000 to LS0255	LS0000 to LS0254
Shared Memory	WORD	PL		PL00000-PL0000F to PL02550-PL0255F	PL0000 to PL0255	PL0000 to PL0254
Software Reset Port * ⁵	WORD	RST		—	RST0	—
Error Mask * ⁶	WORD	ERRM	Read	ERRM00-ERRM10	ERRM0 ERRM1	—

*1 When monitoring the voltage with the device monitor, the unit is “mV”.

*2 When monitoring the number of revolutions with the device monitor, the unit is “rpm”.

*3 When monitoring Temperature with the device monitor, the unit is “°C”.

*4 Used for only the system to read/write the data and perform monitoring operation.

*5 Shuts down and restarts the operation system on the client PS-A.

*6 Indicates the error event that is being monitored by the PS-A.

IMPORTANT

- When “Forced Shutdown” or “Forced Reboot” is written to the device address, the system automatically shuts down/restarts the operation system without prompting the confirmation for saving the data on current applications. Take extra cautions when performing write operation in order to avoid accidental data loss.

Value to be Written		Operation
Decimal Number	Hexadecimal Number	
1	0001	Shutdown
2	0002	Reboot
257	0101	Forced Shutdown
258	0102	Forced Reboot

3.6.3 Monitoring using Pro-Server with Pro-Studio or Pro-Server EX

■ Setting Up the Client PS-A

- (1) Double-click [System Monitor Property] in [Control Panel] to display the [System Monitor Property].
- (2) On the [Remote RAS] tab, put a check mark in the [Enable] checkbox.

NOTE • For details about the setup procedure, refer to the Setup Guide.

SEE → 3.8.3 Remote RAS (page3-31)

- In order to actually activate the Remote RAS feature, you are required to start up the System Monitor (SystemMonitor.exe) within the PS-A.
- (3) Click [Apply].
- Click [OK] to exit the [System Monitor Property].

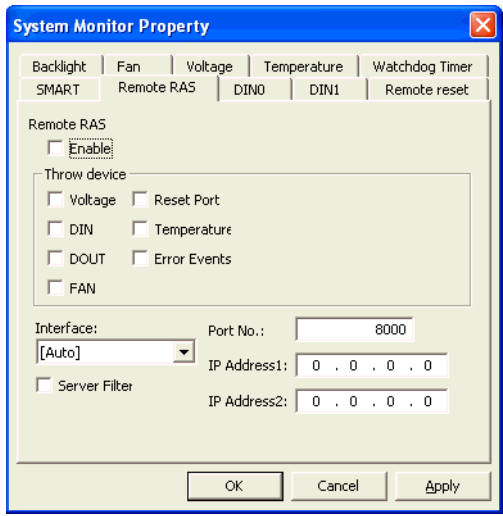

■ Setting Up the Server PC

- (1) On the server PC, download the software from the Pro-face support site “Otasuke Pro!”. Follow the attached instructions to copy the downloaded file to the designated file.
- (2) Start up the Pro-Studio.
- (3) Register the PS-A you want to include in the network to the network station, and edit the participant stations.

SEE → *Pro-Server with Pro-Studio for Windows Operation Manual*
Pro-Server EX Reference Manual

NOTE • When using the Pro-studio’s [Find Stations] command to register the PS-A to the network station, the System Monitor should be activated with the Remote RAS feature enabled in the PS-A.

- (4) Select [PL, PS-A, PS-B] for the PLC type on the network station editing.
- (5) Register the symbol. Refer to the following for the symbols that can be registered.

SEE → ■ *List of Device Addresses (page3-23)*

NOTE • You are not required to transfer the network project file created with the Pro-Studio to the client PS-A.

3.7 Restarting/Shutting Down the PS-A from a Remote Server

3.7.1 Description

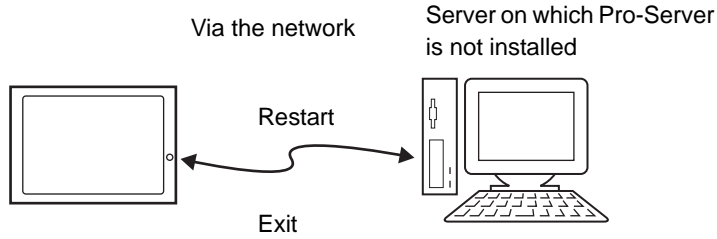

Restart or shut down the PS-A unit from a server on which Pro-Server is not installed.

It is assumed that the [Proface] folder has already been created on the unit at this location.

NOTE

- When using this function, LAN2 should be enabled. To enable LAN2, download the LAN driver from the Pro-face support site "Otasuke Pro!".

SEE → *1.4 PS-A Dedicated Software (page 1-9)*

- For the operation procedure of this feature, refer to the online help of the Remote Shutdown Application.
- Both applications (for server and client) can be installed on the PS-A to achieve self-control system. In such a case, however, the PS-A should be connected to a network.
- If the Remote Shutdown feature is executed, the PS-A unit will be in the Soft OFF Status. (Power is still supplied to a part of circuits.)

3.7.2 Setup Procedure

- (1) Execute the application on the server as well as on the PS-A.

The application is stored in the following folder.

	Application Name	File Name	Folder (Windows® XP)
Server	Remote Shutdown	RSSvr.exe	C:\Proface\Shutdown\Server
PS-A	Remote Shutdown	RSClt.exe	C:\Proface\Shutdown\Client

NOTE

- When the application does not exist, download the installer from the Pro-face support site "Otasuke Pro!".

<http://www.pro-face.com/otasuke/>

- (2) Check the IP address of LAN2 on the PS-A.
- (3) Shut down the OS of the PS-A. Make sure to keep the power supply to the PS-A.
- (4) Send MagicPacket from the server to the IP address of the PS-A checked in (2). Select the IP address to which you want to send the MagicPacket, right-click on the mouse, and select [Boot].

NOTE

- Download [Remote Shutdown], a tool to send the MagicPacket from the Pro-face support site "Otasuke Pro!".

- (5) The PS-A starts up.

■ Starting/Shutting Down the PS-A from the Standby or Sleep Mode

To start/shut down the PS-A from the standby or sleep mode, configuration of the [System] setting in the [Control Panel] is required.

NOTE

- To start/shut down the PS-A from the shut-down mode, it is not necessary to configure the [System] setting in the [Control Panel].

- (1) Start [Control Panel] from the Start menu.
- (2) Start the [System]. (You can find [System] in the Performance and Maintenance category.)
- (3) Start the [Device Manager] on the Hardware tab.
- (4) Double-click on [Realtek RTL8169/8110 Family] under the Network adapter.
- (5) Put a checkmark to the [Allow this device to bring the computer out of standby] box on the Power Management tab.

3.8 Setup Guide for the System Monitor Property

The System Monitor Property allows you to specify PS-A items you want to monitor with the RAS features and the notification method used when errors/alerts occur. When an error/alert occurs, notification is provided according to the method specified in the System Monitor Property.

NOTE • For procedure to set up the System Monitor Property, refer to the following section.
SEE → 3.3.2 Setup Procedure (page3-11)

- You can check the status of the PS-A unit you are monitoring with the RAS features on the System Monitor screen.

For details regarding the System Monitor screen, refer to the following.

SEE → 3.9 Setup Guide for the System Monitor Screen (page3-34)

The following table lists the operating settings that can be configured for each feature.

O: Setting available X: Setting not available

Feature	Operation						
	Buzzer	Popup Message	OS Shutdown	LED	DOUT 0, 1*2	Reset	Timeout (sec):
Watchdog Timer	O	O	O	O	O	O	O
Voltage	O	O	O	O	O	X	X
Fan*1	O	O	O	O	O	X	X
Temperature	O	O	O	O	O	X	X
SMART	O	O	X	O	O	X	X
DIN0, 1*2	O	O	O	O	O	X	X
Remote Reset*2	X	X	X	X	X	O	X
Backlight	O	O	X	O	O	X	X

*1: Nothing is displayed on PS-3651A.

*2: Nothing is displayed on PS3650A-T42S / PS3651A-T42S.

IMPORTANT • Administrator Authentication is required for executing SMART Monitoring. When a user who does not have the administrator authentication logs in, nothing is displayed in the item of SMART.

The following table lists the default settings of each feature.

O: Setting X: Not set X: Not applicable

Feature	Operation						
	Buzzer	Popup Message	OS Shutdown	LED	DOUT 0, 1*2	Reset	Timeout (sec):
Watchdog Timer	X	O	X	O	X	X	O (5sec)
Voltage	X	O	X	O	X	-	-
Fan*1	X	O	X	O	X	-	-
Temperature	X	O	X	O	X	-	-
SMART	X	O	-	O	X	-	-
DIN0, 1*2	X	O	X	O	X	-	-
Remote Reset*2	-	-	-	-	-	X	-
Backlight	X	O	-	O	X	-	-

*1: Nothing is displayed on PS-3651A.

*2: Nothing is displayed on PS3650A-T42S / PS3651A-T42S.

3.8.1 Voltage / Fan / Temperature / Backlight / DIN0 / DIN1

NOTE

- The Voltage, Fan, Temperature, Backlight and DIN1 tabs display the same setting items as the DIN0 tab.
- DIN1 tab cannot be set up when a checkmark is off in the [Enable] checkbox of Remote reset tab. Remote reset feature, refer to the following section.
SEE → 3.8.5 Remote reset (page3-33)
- The FAN tab is not displayed on the PS-3651A.
- The DIN0,1 tabs are not displayed on the PS3650A-T42S / PS3651A-T42S.

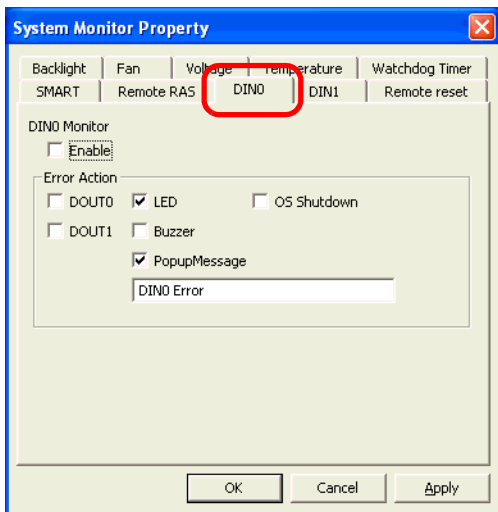

Item	Operation	
Enable	When this option is checked, monitoring of the item starts.	
Error Action	Specifies the action(s) taken when the System Monitor detects that the allowable range is exceeded. You need to check [Enable] before you can select actions.	
	LED	The front LED lights orange.
	Buzzer	Sounds a beep as an alarm. NOTE • Cannot be set up when a checkmark is put in the “OS Shutdown” checkbox.
	Pop-up Message	When [PopupMessage] is specified as an action, the characters entered in the field (e.g. DINO Error) are displayed as a popup message. For the details about the PopupMessage feature, refer to the following section. SEE → 3.3.3 When an Error Occurs (page3-14)
Error Action	DOUT0 to 1	Output from the RAS port. NOTE • Nothing is displayed on the PS3650A-T42S / PS3651A-T42S.
	OS Shutdown	Shuts down the operating system. NOTE • The shutdown confirmation message is not displayed.

3.8.2 SMART

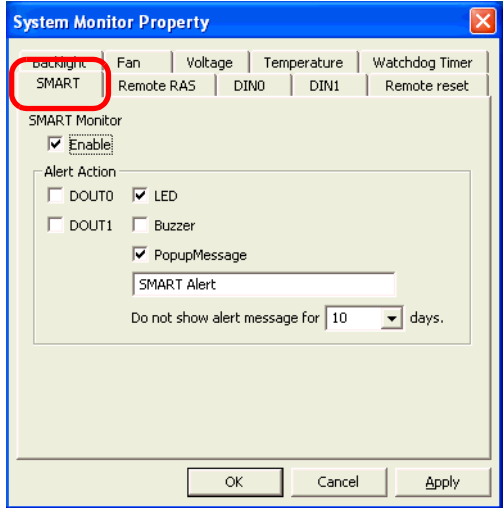

Item	Operation										
Enable	When this option is checked, monitoring of SMART starts.										
Alert Action	<p>Specifies the action(s) taken when the System Monitor detects that the allowable range is exceeded. You need to check [Enable] before you can select actions.</p> <table border="1" data-bbox="223 962 1203 1481"> <tr> <td data-bbox="223 962 600 1006">DOUT0 to 1</td> <td data-bbox="600 962 1203 1006">Output from the RAS port.</td> </tr> <tr> <td data-bbox="223 1006 600 1051">LED</td> <td data-bbox="600 1006 1203 1051">The front LED lights orange.</td> </tr> <tr> <td data-bbox="223 1051 600 1095">Buzzer</td> <td data-bbox="600 1051 1203 1095">Sounds a buzzer as an alarm.</td> </tr> <tr> <td data-bbox="223 1095 600 1325">Pop-up Message</td> <td data-bbox="600 1095 1203 1325"> When [PopupMessage] is specified as an action, the characters entered in the field (e.g. SMART Alert) are displayed as a popup message. For the details about the PopupMessage feature, refer to the following section. SEE → 3.3.4 When an Alert Occurs (page3-15) </td> </tr> <tr> <td data-bbox="223 1325 600 1481">Do not show alert message for 10 days.</td> <td data-bbox="600 1325 1203 1481"> Will not display the message specified in [PopupMessage] for a certain number of days only. Sets the amount of days that the message will not be displayed. The amount of days can be set within a period ranging from 1 to 65,535 days. </td> </tr> </table>	DOUT0 to 1	Output from the RAS port.	LED	The front LED lights orange.	Buzzer	Sounds a buzzer as an alarm.	Pop-up Message	When [PopupMessage] is specified as an action, the characters entered in the field (e.g. SMART Alert) are displayed as a popup message. For the details about the PopupMessage feature, refer to the following section. SEE → 3.3.4 When an Alert Occurs (page3-15)	Do not show alert message for 10 days.	Will not display the message specified in [PopupMessage] for a certain number of days only. Sets the amount of days that the message will not be displayed. The amount of days can be set within a period ranging from 1 to 65,535 days.
DOUT0 to 1	Output from the RAS port.										
LED	The front LED lights orange.										
Buzzer	Sounds a buzzer as an alarm.										
Pop-up Message	When [PopupMessage] is specified as an action, the characters entered in the field (e.g. SMART Alert) are displayed as a popup message. For the details about the PopupMessage feature, refer to the following section. SEE → 3.3.4 When an Alert Occurs (page3-15)										
Do not show alert message for 10 days.	Will not display the message specified in [PopupMessage] for a certain number of days only. Sets the amount of days that the message will not be displayed. The amount of days can be set within a period ranging from 1 to 65,535 days.										

3.8.3 Remote RAS

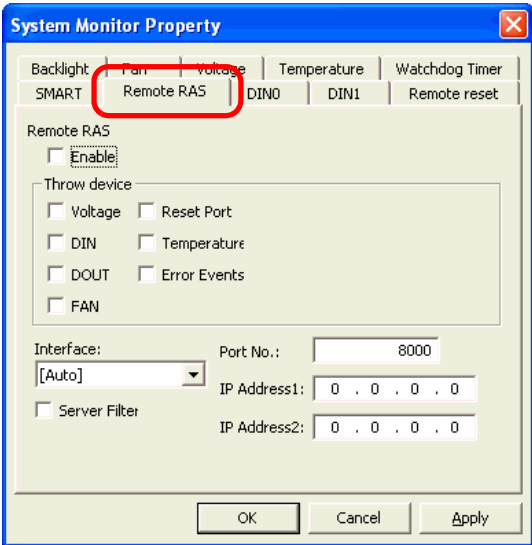

Item	Operation
Enable	When this option is checked, the remote RAS feature starts.
Throw device	Specifies the item(s) to be monitored.
Interface	Specifies the IP address used for the connection with the Pro-Server. <div style="border: 1px solid black; padding: 2px; display: inline-block; margin-bottom: 5px;">NOTE</div> <ul style="list-style-type: none"> When 2 or more IP Addresses are allocated to the PS-A unit, the [Auto] cannot be selected. Enter settings that allow the reading of a fixed IP Address from a DHCP server. For details, contact your company’s network administrator for getting the detailed information.
Server Filter	Check this option to communicate only with the server with a specific IP address.
Port No	Specifies the port No. of the server to communicate with.
IP	Specifies the IP address of the server to communicate with.

3.8.4 Watchdog Timer

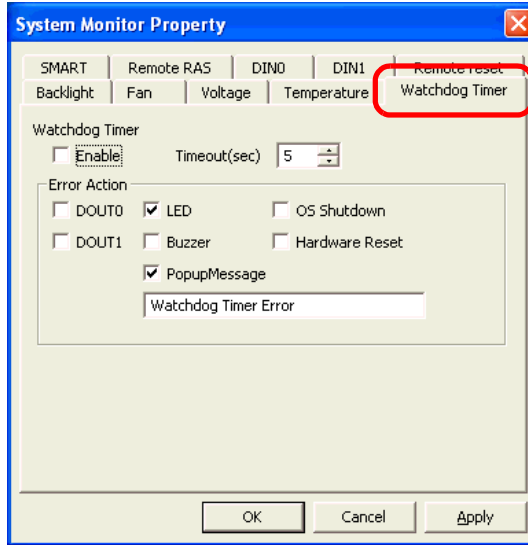

Item	Operation
Enable	When this option is checked, the Watchdog Timer is enabled.
Timeout(sec.);	Specifies the timer duration.
Error Action	Specifies the action(s) taken when the System Monitor detects that the allowable range is exceeded.
Pop-up Message	<p>When [PopupMenu] is specified as an action, the characters entered in the field (e.g. Watchdog Timer Error) are displayed as a popup message. For the details about the PopupMessage feature, refer to the following section.</p> <p>SEE → 3.3.3 When an Error Occurs (page3-14)</p>

3.8.5 Remote reset

NOTE • Nothing is displayed on PS3650A-T42S / PS3651A-T42S.

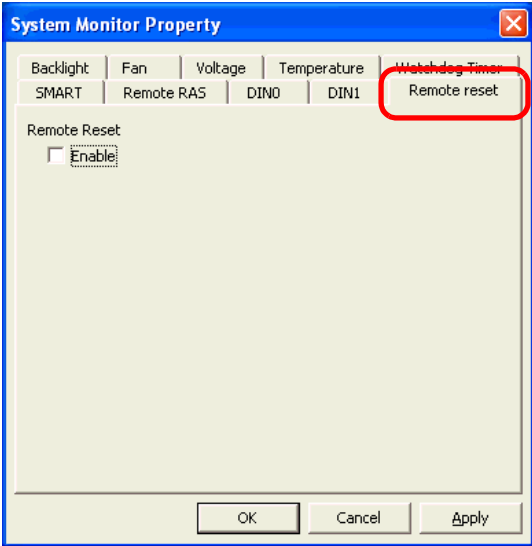

Item	Operation
Enable	When this option is checked, the Remote Reset is enabled.

3.9 Setup Guide for the System Monitor Screen

You can check the status of the PS-A being monitored.

Click the tab of the item you want to check.

- NOTE**
- PS-A items you want to monitor with the RAS features and the notification method used when errors/alerts occur are set from the System Monitor Property. For the System Monitor Property settings, refer to the following.
- SEE →** 3.8 Setup Guide for the System Monitor Property (page3-28)

3.9.1 Voltage / Fan / Temperature / Backlight / Watchdog Timer

- NOTE**
- The Temperature tab displays the same items as the Voltage tab.
 - The Backlight and Watchdog Timer tabs display [Status] only.
 - The FAN tab is not displayed on the PS-3651A.

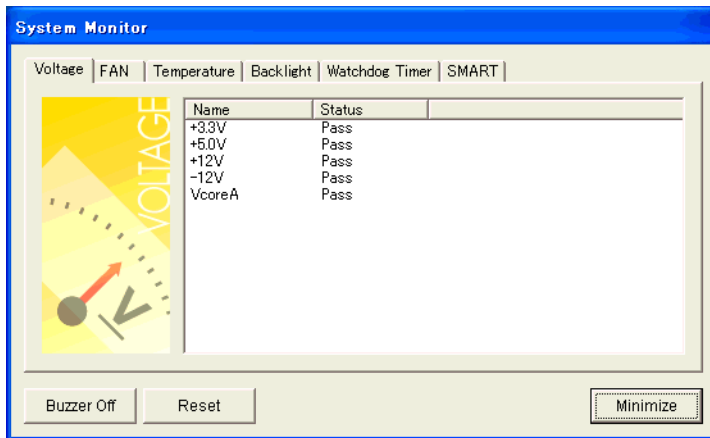

Item	Operation
Name	Displays the monitoring item.
Status	Specifies the item to be monitored. The status of each monitoring item is displayed. [Pass]: Normal [Error]: Abnormal [Disable]: Not monitored
Buzzer Off	When [Buzzer] is selected for the error notification method, you can stop the buzzer by clicking [Buzzer Off].
Reset	When an error is detected, clicking [Reset] recovers the System Monitor from the "error" status. NOTE <ul style="list-style-type: none"> After an error is resolved, make sure to reset. If reset is not performed, the error history remains, which causes the error to be detected again even if it was resolved. For the procedure to recover from an error status, refer to the following section. SEE → 3.3.3 When an Error Occurs (page3-14)
Minimize	Stores the System Monitor screen in the task tray.

3.9.2 SMART

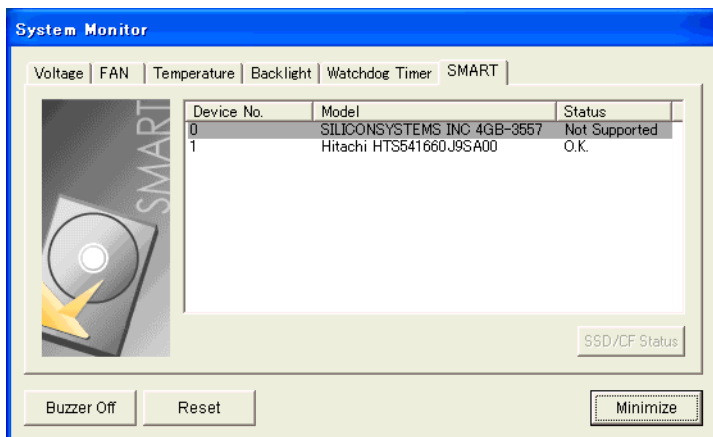

Item	Operation
Device No.	Displays the number assigned to the hard disk to be monitored.
Model	Displays the model of the hard disk.
Status	<p>Specifies the item to be monitored. The status of each monitoring item is displayed.</p> <p>[O.K.]: Normal [Alert]: Alert [Disable]: Not monitored [Not Supported]: Not supported</p> <p>NOTE</p> <ul style="list-style-type: none"> [Not Supported] is displayed when a device like a CF card, which does not support SMART, is detected.
Buzzer Off	When [Buzzer] is selected for the alert notification method, you can stop the buzzer by clicking [Buzzer Off].
Reset	<p>When an alert is detected, clicking [Reset] recovers the System Monitor from the "alert" status.</p> <p>NOTE</p> <ul style="list-style-type: none"> After an alert is resolved, make sure to reset. If reset is not performed, the alert history remains, which causes the alert to be detected again even if it was resolved. For alert recovery procedures, refer to the following section: <p>SEE → 3.3.4 When an Alert Occurs (page3-15)</p>
Minimize	Stores the System Monitor screen in the task tray.

3.10 Displayed Messages

■ Error/Alert Pop-up Messages

When an error/alert occurs while the "Popup Message" option is enabled for Error Action/Alert Action, the following messages appear on the pop-up message output screen under the factory settings.

Error/Alert Type	Message
VcoreA	"VcoreA Power Supply Error"
+3.3V	" +3.3V Power Supply Error"
+5V	" +5V Power Supply Error"
+12V	" +12V Power Supply Error"
-12V*1	" -12V Power Supply Error"
System FAN*1	"System FAN Error"
System Temperature	"System Temperature Error"
CPU Temperature	"CPU Temperature Error"
Watchdog Timer	"Watchdog Timer Error"
Backlight	"Backlight Blowout Error"
SMART	"SMART Alert"

*1: Nothing is displayed on PS-3651A.

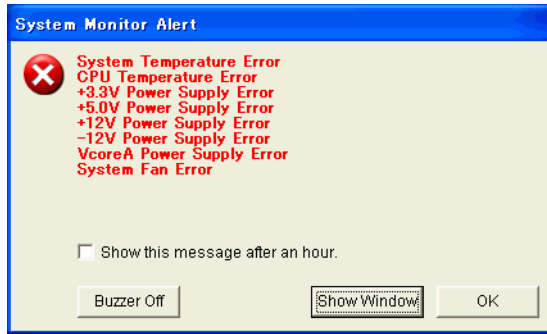

NOTE • The messages displayed on the pop-up message output screen can be modified on the System Monitor Property.

SEE → 3.3.1 Description (page3-11)

■ Messages Displayed on the Event Viewer Screen

The error types/locations shown by the Event Viewer are as follows.

Error/Alert Type	Message
Vcore A	VcoreA voltage Error has occurred.
+3.3V	+3.3V Error has occurred.
+5V	+5.0V Error has occurred.
+12V	+12V Error has occurred.
-12V*1	-12V Error has occurred.
System FAN*1	System Fan Error has occurred.
System Temperature	System Temperature Error has occurred.
CPU Temperature	CPU Temperature Error has occurred.
Watchdog Timer	Watchdog Timer Error has occurred.
Backlight	Backlight Error has occurred.
SMART	SMART Alert has occurred. Attribute (Attribute ID) (Attribute Name) Device (No.) (HD Model). The descriptions in the parentheses vary depending on details of occurring alerts and the device where alerts occur (0:Master, 1:Slave)

*1: Nothing is displayed on PS-3651A.

◆ Error/Alert Action

NOTE

- The data shown in the table's "□□" indicate the error/alert type/location.
- The actions to be taken after an error/alert occurs are set via the System Monitor Property.

Error/Alert Action	Message
Buzzer	Buzzer has sounded because of □□ error. Buzzer has sounded because of □□ alert.
Popup Message	Popup Message has been shown because of □□ error. Popup Message has been shown because of □□ alert.
OS Shutdown	Window has been shut down because of □□ error. Window has been shut down because of □□ alert.
DOUT0*1	DOUT0 has output because of □□ error. DOUT0 has output because of □□ alert.
DOUT1*1	DOUT1 has output because of □□ error. DOUT1 has output because of □□ alert.
LED	LED has output because of □□ error. LED has output because of □□ alert.

*1: Nothing is displayed on PS3650A-T42S / PS3651A-T42S.

■ Bit Assign of Error Event, and Error Mask

Device Name	Item	Bit
Error Event	VcoreA Voltage Error	ERR00
	VcoreB Voltage Error	ERR01
	+3.3V Voltage Error	ERR02
	+5.0V Voltage Error	ERR03
	+12V Voltage Error	ERR04
	+2.5V Voltage Error	ERR05
	-12V Voltage Error ^{*1}	ERR06
	System Fan Error ^{*1}	ERR08
	System Temperature Error	ERR0A
	CPU Temperature Error	ERR0B
	System2 Temperature Error	ERR0C
	Watchdog Timer Error	ERR0D
	Reserved	ERR0E
	Backlight Error	ERR0F
	SMART Alert	ERR10
Error Mask	Vcore Voltage Error	ERRM00
	VcoreB Voltage Error	ERRM01
	+3.3V Voltage Error	ERRM02
	+5.0V Voltage Error	ERRM03
	+12V Voltage Error	ERRM04
	+2.5V Voltage Error	ERRM05
	-12V Voltage Error ^{*1}	ERRM06
	System Fan Error ^{*1}	ERRM08
	System Temperature Error	ERRM0A
	CPU Temperature Error	ERRM0B
	System2 Temperature Error	ERRM0C
	Watchdog Timer Error	ERRM0D
	Reserved	ERRM0E
	Backlight Error	ERRM0F
	SMART Alert	ERRM10

*1: Nothing is displayed on PS-3651A.

■ Error Messages Displayed during Device Reading/Writing

Error Code		Error Message
Decimal Number	Hexadecimal Number	
9530	253Ah	RAS Initialization Error
9531	253Bh	Command not supported.
9532	253Ch	Access type not supported.
9533	253Dh	Read/Write type not supported.
9534	253Eh	Access to the device is rejected.
9535	253Fh	Value setting to the device/retrieval failed.
65535 (No Code)	FFFFh	Returned when read/write of invalid values or unsupported device is performed for Voltage, Temperature, and number of revolution of the FAN.

SEE → For error messages other than listed above, refer to “Pro-Server with Pro-Studio for Windows Operation Manual”.

3.11 Restrictions

■ Supported Pro-Server Features

The following table lists the features of the Pro-Server that are supported by the PS-A. For the details of each feature, refer to “Pro-Server with Pro-Studio for Windows Operation Manual”.

Pro-Server Feature	O: Supported X: Not Supported
DDE Feature	O
Simplified DLL Feature (ProEasy.dll)	SEE → ■ <i>Supported Simplified DLL Features (page3-40)</i>
OPC Server Interface	O
SRAM Backup Data	X
Action Feature	X
Distribution Feature	X
Data Viewer	O*1
VBA Feature Assist	O
Device Data Backup/Restore Feature	O
Capture Screen Save Feature	X
Security Feature	O
Device Monitor	O
Status Monitor	X
Read Time Measurement	O

*1: Pro-Server with Pro-Studio for Windows Ver. 4.0 or higher is required.

■ Supported Simplified DLL Features

The simplified DLL features supported by the PS-A are as follows:

- Direct Read Function
- Direct Write Function
- Cache Read Function
- Retrieval of Multithreading Handle
- Release of Multithreading Handle
- Loading of Network Project File
- Error Code String Conversion.
- Participant Station Status Readout Function
- Initialization of Simplified DLL
- Termination of Simplified DLL

NOTE

- Note that the PS-A-supported OS and features supported by Pro-Server are different.
- When using the Remote RAS feature together with Pro-Server in PS-A, be sure to select different port numbers.

4 | Troubleshooting

1. Problems and Countermeasures
2. Recovery Procedure

This chapter describes the countermeasures for problems with the PS-A and the recovery procedure for the OS.

4.1 Problems and Countermeasures

Problem	Countermeasure and reference page
<p>Nothing appears on the screen.</p>	<p>Is the power cable connected properly?</p> <p>SEE → <i>PS-3650A/3651A Hardware Manual 3 Hardware Installation</i></p>
	<p>Is the power supply/voltage within the range of the specifications?</p> <p>SEE → <i>PS-3650A/3651A Hardware Manual 2 Specifications</i></p>
	<p>Is the backlight lit? If the backlight is burnt out, replace it.</p> <p>SEE → <i>PS-3650A/3651A Hardware Manual 4 Maintenance</i></p>
	<p>Does the status LED illuminate in green?</p> <p>SEE → <i>If the status LED does not illuminate, contact your local PS-A distributor.</i></p>
<p>The OS does not operate properly.</p>	<p>Is [Type] in [IDE Slave] set to [Auto] in the IDE setting?</p> <p>SEE → <i>■ IDE Master / IDE Slave / SATA Port (page2-5)</i></p>
	<p>Did you connect a new hard disk drive or commercial USB memory which does not require boot-up?</p> <p>SEE → <i>2.2.5 Boot (page2-28)</i></p>
	<p>If this symptom occurs, setting [Power on Delay] to [Enabled] may solve the problem.</p> <p>SEE → <i>Power On Delay (page2-12)</i></p>
<p>“Delayed Write Failed” occurs frequently.</p>	<p>When some of the following conditions occur simultaneously, there is a high probability that the PS-A has failed while writing to files, resulting in this error.</p> <ul style="list-style-type: none"> • The same file is frequently accessed (opened, read, written, etc.). • The amount of implemented memory is small and cache memory is insufficient. • The file is highly fragmented. • The I/O load to the disk is high. • Delay writing fails. <p>Try performing maintenance on the drive. If the problem continues, replace the drive.</p>

Problem		Countermeasure and reference page
The OS does not operate properly.	I did not shut down or reboot the unit, but the "CMOS CHECK SUM ERROR" occurred.	<p>A possible cause is that clock data backup drained the battery. Replace the battery. Since the BIOS setting will be lost when the battery is removed, it should be configured again after replacing the battery. The following conditions may accelerate the battery drain.</p> <ul style="list-style-type: none"> • The temperature of the surrounding environment frequently changes from low to high. • The extended board in use exhausts more power of battery for clock data backup. <p>SEE → <i>PS-3650A/3651A Hardware Manual 4 Maintenance</i></p>
The connected peripheral device does not work.		<p>Is the power cable connected properly?</p> <p>SEE → <i>PS-3650A/3651A Hardware Manual 3 Hardware Installation</i></p>
		<p>Is the peripheral device connected properly?</p> <p>-> Refer to the manual for the connected device.</p>
		<p>Does the device require driver setup?</p> <p>-> Refer to the manual for the connected device and set the driver properly.</p>
		<p>Did you start the PS-A unit with a USB device connected?</p> <p>→If the PS-A unit is started while USB memory or another USB device is connected, the following phenomenon may occur depending on the device.</p> <ul style="list-style-type: none"> • It takes about 1 minute before the OS starts up. • If the USB device is not recognized, set [Power on Delay] to [Enable]. This may solve the problem.
The touch panel does not respond.		<p>You need to install the touch panel driver when you use the PS-A with no pre-installed OS.</p> <p>SEE → ■ <i>Touch Panel Driver (Mouse Emulator) (page1-10)</i></p>
The touch position recognized in the touch panel deviates from the actual touch.		<p>Have you calibrated the touch panel?</p> <p>SEE → ■ <i>Touch Panel Driver (Mouse Emulator) (page1-10)</i></p>
The touch panel does not respond even after the touch panel driver is installed.		<p>If the touch panel does not respond even after the touch panel driver is installed, possible causes are:</p> <p>The connected external device (including a keyboard and a mouse) may not be compatible with the PS-A. ->Disconnect the external device and check the touch operation.</p> <p>A touch panel driver (or drivers) other than the driver downloaded from the Pro-face support site "Otasuke Pro!" is installed in the PS-A. ->Uninstall such a driver(s) and make sure that only the driver downloaded from "Otasuke Pro!" is installed in the PS-A. Then check the touch operation.</p> <p>The touch panel driver setting has been changed. ->If the touch panel driver setting has been changed, touch actions may not work properly. Please contact your local PS-A distributor.</p>

Problem	Countermeasure and reference page
<p>The touch position recognized in the touch panel still deviates from the actual touch even after calibration.</p>	<p>If the touch position still deviates after calibration, possible causes are:</p> <ul style="list-style-type: none"> • There are flaws or unevenness on the surface of the PS-A. → If the bracket securing the PS-A is tightened too much, flaws or unevenness may result. Release the PS-A from the bracket and check whether the problem continues. • The touch panel calibration was not finished properly. → Uninstall the touch panel driver once, and then install the latest driver. The latest driver can be downloaded from the Pro-face support site "Otasuke Pro!". • The hardware in the touch recognition section is faulty. → Use the PS-A that operates properly and check whether the same problem occurs. If the problem occurs only with a specific unit, contact your local PS-A distributor for repair or replacement.
<p>I want to know what the LED indicator indicates.</p>	<p> ◆ <i>LED Indicator (page3-5)</i></p>
<p>A Touch Panel Self-Test Error occurred.</p>	<p>The touch panel is faulty. Please contact your local PS-A distributor.</p>
<p>A "Smart Alert" occurred</p>	<p>Predicts the malfunction and life expectancy of the hard disk. It is recommended that the disk be replaced before experiencing malfunction or reaching the end of its life.</p>

4.2 Recovery Procedure

4.2.1 PS-A with no Pre-installed OS

Refer to the manual for the installed OS and recover the OS.

When the OS is recovered, set up the software.

SEE → 1.2.2 *Setting Up the PS-A Dedicated Software (page1-2)*

4.2.2 PS-A with Pre-installed OS (Windows® XP)

IMPORTANT

- After performing recovery, the PS-A unit is returned to its factory shipped condition.
- For recovery, a commercial USB keyboard and DVD-ROM drive are required.
- Do not connect the external storage unit such as USB device and CF Card while the recovery.

Use the following steps to recover the system.

- (1) Turn on the power of PS-A and immediately press the [F2] key to enter the BIOS setup screen. Insert the Recovery media into the drive.
- (2) On the [Boot] menu, move the name of the drive inserted the Recovery Media to the top of the screen using the [+] key or the [-] key.

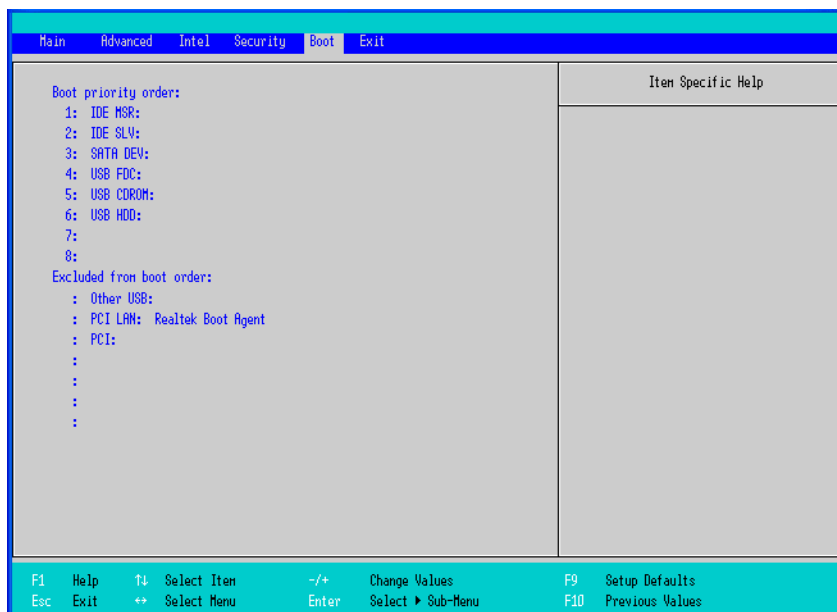

- (3) Press the [F10] key and select [Yes] for [Save configuration changes and exit now?] to save the settings and restart the PS-A unit.
- (4) After the PS-A unit restarts, the Symantec Ghost™ will automatically start.

- (5) After the Symantec Ghost™ starts, the [Question] dialog box will appear.

“Partition sizes correct?”

NOTE

- Touch operation is disabled on the Symantec Ghost™ screen. Operate the screen with the USB keyboard or USB mouse.

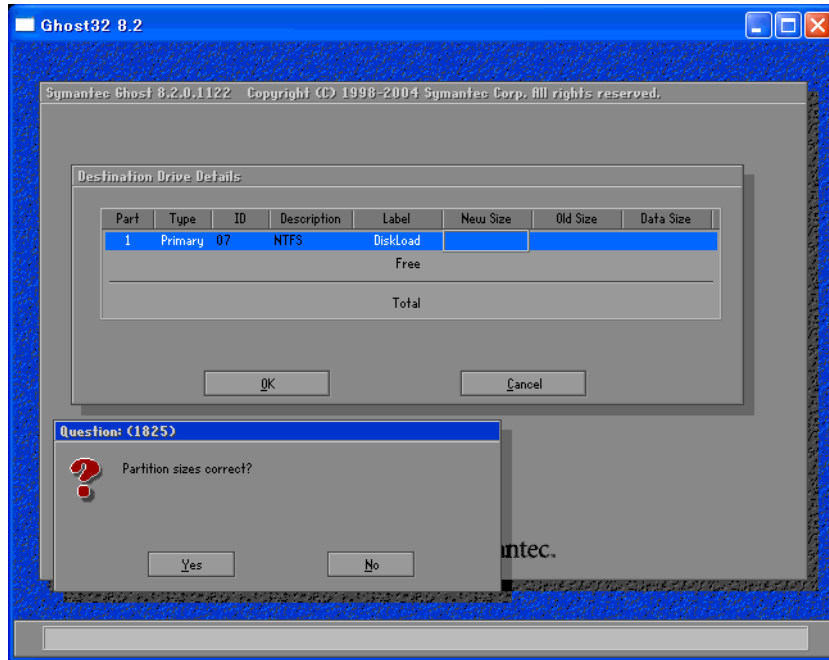

- (6) The volume displayed in New Size will be recovered. After confirming it, press the [Yes] button. To change it, press the [No] button and go to the [Destination Drive Details] dialog box. In the [Destination Drive Details] dialog box, change the size of the New Size and press the [OK] button.

- (7) The [Question] dialog box will appear. Press the [Yes] button. It will be reconfirmed that the data of the hard disk is all reset to the original values at the time of delivery.

“Proceed with disk restore? Destination drive will be permanently overwritten.”

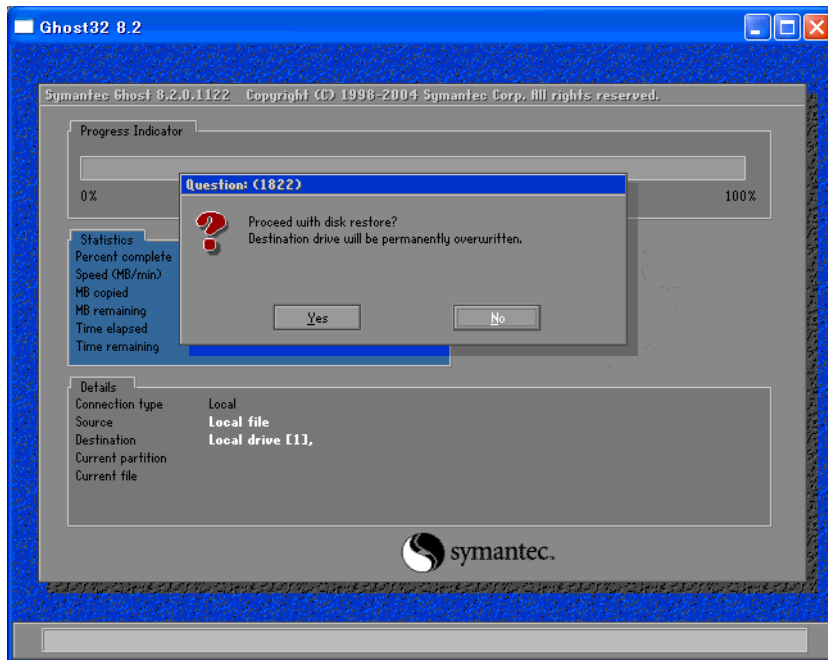

- (8) The hard disk recovery program will start. After the recovery operation finishes, the Symantec Ghost™ also will finish. When the message “Please turn off computer” displayed, turn off the power of PS-A.
- (9) Turn on the power of PS-A again and immediately press the [F2] key to enter the BIOS setup screen.
- (10) Press the [F9] key and select [Yes] for [Load default configuration now?] to set the BIOS setting to the factory setting. Press the [F10] key to save the setting and restart the PS-A unit.
- (11) After the unit restarts, set up your OS.

SEE → 1.3.1 Setting Up OS (page1-6)

IMPORTANT

- If BIOS does not recognize the boot drive or if there is a hardware malfunction, the drive cannot be recovered with Symantec Ghost™. In such cases, Pro-face recommends that you contact your local PS-A distributor for instructions about drive recovery or replacement.
- HDD unit has a product life. Pro-face recommends that you allow for the hardware specifications and regularly back up important HDD unit data to either floppy disks, or other type of suitable magnetic media.

A | Appendices

1. I/O Map
2. Memory Map
3. Interrupt Map
4. License Agreement

This chapter describes the hardware configuration of the I/O map, memory map, and interrupt map.

1 I/O Map

Address	AT System Device	System Device
0000H-001FH	DMA controller (8237)	
0020H-003FH	Interrupt controller (8259A)	
0040H-005FH	System timer (8254)	
0060H-006FH	Keyboard controller	
0070H-007FH	Real time clock, NMI mask	
0080H-009FH	DMA page register	
00A0H-00BFH	Interrupt controller 2 (8259A)	
00C0H-00DFH	DMA controller 2 (8237)	
00F0H-00FFH	Numeric data processor	
01F0H-01FFH	IDE	
0290H-0297H	Reserved	System monitor
02E8H-02EFH	Reserved	
02F8H-02FFH	Serial port 2 (COM2): General use	
03B0H-03BBH	Video controller (VGA)	
03C0H-03DFH	Video controller (VGA)	
03E8H-03EFH	Reserved	Serial port 3 (COM3)
03F8H-03FFH	Serial port 1 (COM1): General use	

NOTE

- The resources of the PCI BUS board that is installed by the user are automatically assigned to the free resource by the Plug and Play feature.

2 Memory Map

SMRAM	MAXMEM
FrameBuffer	MAXMEM-1MB
Expanded Memory	MAXMEM-9MB* ¹
System BIOS	1MB
Expanded ROM Area	F000:0000
PXE BIOS, VGA BIOS	D000:0000
Video RAM	C000:0000
Conventional Memory	A000:0000
	0000:0000

*1 The capacity allocated by “IGD-Memory Size“ of the “Video (Intel IGD) Control Sub-Menu“ screen of the BIOS setting is 1MB.

3 Interrupt Map

NOTE • The interrupts and DMA channel will change depending on the PnP features of PCI available.

■ Hardware Interrupt List

	Description
NMI	Parity Error or I/O Channel Check
IRQ 0	Timer (in the Chipset)
1	Reserved
2	Cascade from Controller 2
3	Serial Port 2 (COM2): General Use Port
4	Serial Port 1 (COM1): General Use Port
5	Available for users *
6	Reserved
7	Available for users *
8	Real Time Clock
9	ACPI
10	Serial Port 3 (COM3): General Use Port
11	Available for users *
12	Numeric Data Processor
13	IDE
14	IDE
15	USB Controller, Display Controller
16	Multimedia Device, Cardbus Controller
17	USB Controller
18	USB Controller, Network Controller
19	Network Controller
20	Reserved
21	Reserved
22	USB 2.0 Controller

IMPORTANT • The “*” mark indicates that, depending on the customer’s settings, the following devices are automatically allocated as Plug and Play devices.

Display Controller

SMBus Controller

Multimedia Device

Network Controller

USB Controller

■ DMA Channel List

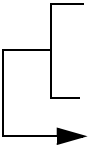
	Description		
	DMA 0	For 8-bit transmission	
	1		
	2		
	3		
	4	Cascade to controller 1	For 8-bit transmission
	5		
	6		
	7		

4 License Agreement

■ DMC Corporation Mouse Emulation Software (TSC-1310D/DD) Software License Agreement

Before unsealing and using this product, please read the following license agreement carefully:

This license agreement regarding the following software product (hereinafter called “product”) is concluded between you the individual or entity licensing the product (hereinafter called (“licensee”) and DMC Co., Ltd. (hereinafter called “DMC”). With unsealing, installing, copying or using the product, the licensee is regarded to agree this contract and the contract is in force. Please confirm and understand this agreement fully in advance. If you do not agree this contract, do not unseal, install, copy or use the software product at all. In such a case, please return the product at an unused state to the place you the licensee purchased it. Your payment will be returned to the licensee.

1. Copyright

The copyright of the software product belongs to Touch-Base, Ltd.

2. License

For the programs included in this product and the documents related to it, DMC grants untransferable nonexclusive license to licensee, which permits use of the product under the following conditions:

- (1) When a licensee does not purchase the license which permits the licensee to use a licensed product and its copy(s) and/or the license which permits use of the product on multiple computers, the licensee is granted the right to use the product on a single computer.
- (2) The licensee can create one copy of the product for archival purposes. For the other purposes, copying the whole or part of the product is strictly prohibited whichever medium you use.
- (3) The licensee shall display the copyright notice and other necessary information which is the same as that for the product on every copy of the product.
- (4) The intangible property right of the product and its copy(s) belong to DMC or the DMC supplier.

3. Term of use

This contract shall maintain its validity from conclusion of the contract to the cancellation by DMC or the licensee.

4. Termination of the right of use

- (1) The licensee can at any time terminate the right to use the product by expunging or destroying the product and all the copied contents.
- (2) When a licensee contravenes these license contents, DMC can notify the licensee of termination of the right to use the product. In this case, the licensee shall return the product or all the copied contents to DMC within one month.

5. Limited Warranty

- (1) DMC guarantees that 90 days after the licensee purchased the product, neither material nor manufacturing flaws shall be found at the medium where the product has been recorded or stored. If any errors related to the material or manufacturing is recognized when the product is installed, we shall replace the medium used to install the product on the condition that we are notified of it within the guaranteed period.
- (2) DMC shall grant the right to use the product at a state it has been supplied without explicit or implicit guarantee except for replacement of the medium containing product described in the above clause. Further, we do not guarantee that the product is suitable as useful for the licensee's specific purpose of use and that execution of the product is neither interrupted nor an error is found at its execution.
- (3) The responsibility attributable to DMC based on this agreement is limited to replacement of the medium containing the product, and DMC shall not assume any responsibility for the explicit or implicit guarantee including the other legal warranty against a defect and a liability for reparation given from a third party to the licensee regarding the licensee's profit loss caused by the product, damage arising from a special circumstance and the damage against data or intangible property right.

6. Licensee's obligation

The licensee shall recognize that the product shall possess the confidential information or property information including the intangible property right protected by the Copyright Act and shall not take the following actions:

- (1) Use and copying of the product against the terms of the license and disassembling, reverse engineering, and modifying the product.
- (2) Transfer, leasing and sublicensing of the product to the third party.
- (3) Deletion and/or change of display of the intangible property right including the copyright displayed on the medium containing the product.

7. Restrictions on Export

When the product is subjected to the regulation of the Foreign Exchange and Foreign Trade Control Act and the laws and regulations accompanying it and the Export, the licensee shall observe the corresponding laws and regulations and rules.



<http://www.dmccoltd.com>

Hironokougyoudanchi, Hirono-machi, Futaba-gun, Fukushima

979-0401, Japan

Phone: +81-240-27-4030 Fax: +81-240-27-4025

■ IN-fINITY soft Keyclick32

Digital Electronics Corporation shall be in no case liable for any loss or damages to you or any third party whatsoever arising from any faulty performance of IN-fINITY soft, nor shall be responsible to correct such error of the software program in question.