

PLB910-42/PLB911-42

Installation Guide



WARNINGS

Follow the instructions given below to ensure the correct and safe use of the PL.

- To prevent an electrical shock, be sure to connect the power cord to the PL before connecting it to the main power supply.
- A fire or electrical shock may result if voltages are used with the PL that are beyond the specified range. Be sure to only use the specified voltage.
- Before opening the PL's protective cover, be sure to turn the unit's power OFF. This is because the PL's internal parts carry high voltages.
- If metal particles, water or other types of liquids contact any of the PL's internal parts, immediately turn the unit's power OFF, unplug the power cord, and contact your local PL distributor.
- Read and understand Chapter 4 "Installation and Wiring" thoroughly in order to select an appropriate installation location for the PL.
- Before either plugging in or unplugging a board or interface connector, be sure to turn the PL's power OFF.
- To prevent a possible explosion, do not install the PL in areas containing flammable gases.
- The PL is not appropriate for use with aircraft control devices, aerospace equipment, central trunk data transmission (communication) devices, nuclear power control devices, or medical life support equipment, due to these devices' inherent requirements of extremely high levels of safety and reliability.
- When using the PL with transportation vehicles (trains, cars and ships), disaster and crime prevention devices, various types of safety equipment, non-life support related medical devices, etc. redundant and/or failsafe system designs should be used to ensure the proper degree of reliability and safety.

To Prevent Accidents

Follow the instructions given below to ensure the correct and safe use of the PL.

- Do not push on the PL's screen too strongly, with either your finger or with a hard object. Excessive pressure can scratch, crack or damage the screen. Do not use a pointed object, such as a mechanical pencil or screwdriver, to press any of the touch panel's switches, since they can damage the display.
- If the screen becomes dirty or smudged, moisten a soft cloth with diluted neutral detergent, wring the cloth well, and wipe the display. Do not use thinner or organic solvents.
- Avoid storing and operating the PL in direct sunlight, high temperatures and humidity, and in areas where excessive dust and vibration will occur.
- Avoid using the PL in areas where sudden, extreme changes in temperature can occur. This may cause condensation to form inside the unit, possibly leading to an accident.
- To prevent the PL from overheating, be sure its air circulation vents are clear and clean, and keep the unit's operation area well-ventilated.
- Avoid operating or storing the PL near chemicals, or where chemicals can come into contact with the unit.
- The Digital Electronics Corporation cannot be held responsible or provide any compensation for damage(s) caused by the loss of data stored in the PL™'s hard disk drive (HDD). It is therefore strongly suggested that all important data and software be backed up regularly to an external data backup device.
- After turning OFF the PL's power, wait until the internal HDD stops spinning before turning on the power again (approx. 5 seconds).

UL/c-UL (CSA) Application Notes

The PLB91*-4* is UL/c-UL 1950 recognized product. (UL File No. E171486). Please pay special attention to the following instructions when applying for UL/c-UL approval for machinery which includes any of these PL units.

The PL conforms as a component to the following standards:

UL 1950, Third Edition, dated March 1,1998 (Standard for Safety of Information Technology Equipment, including Electrical Business Equipment)

CSA-C22.2 No. 950-95 (Standard for Safety of Information Technology Equipment, including Electrical Business Equipment)

PLB910-4* (UL Registration Model No.: 2880056-02)

PLB911-4* (UL Registration Model No.: 2880056-01)

- Equipment with a PL mounted in it requires UL/c-UL evaluation for the combination of the PL and equipment.
- The PL must be used as a built-in component of an end-use product.
- Use the PL indoors only.
- When connecting the PL's power cable, be sure to use a cable that is appropriate for the current and voltage used and that has conductive wires that are 0.75 mm² or larger.
- When using the PL in an end-use product, be sure to install the PL unit's power cut-off switch where the operator can easily reach it.
- Danger of explosion if backup battery is incorrectly replaced. Replaced only with same or equivalent type recommended by the manufacturer. Dispose of used batteries according to the manufacturer's instructions.
- Be sure the unit the PL is built into uses a UL1950 compatible equipment structure.

CE Marking Notes

The PLGB91*-4* units are CE marked, EMC compliant products.

<Complies with the following Standards>

• **Safety**

EN60950

• **EMI (EN50081-2)**

EN55011 group1 (Class A)

• **EMS (EN50082-2)**

EN61000-4-2, EN61000-4-3, EN61000-4-4, EN61000-4-6, EN61000-4-8, ENV50204

If following requirements are not met, the PL may fail to meet EN60950 standard requirements.

- Equipment with a PL mounted in it requires UL/c-UL evaluation for the combination of the PL and equipment.
- The PL must be used as a built-in component of an end-use product.
- Use the PL indoors only.
- When connecting the PL's power cable, be sure to use a cable that is appropriate for the current and voltage used and that has conductive wires that are 0.75 mm² or larger.
- When using the PL in an end-use product, be sure to install the PL unit's power cut-off switch where the operator can easily reach it.
- There is a danger of explosion if the backup battery is incorrectly replaced. This battery should be replaced only with same or equivalent type recommended by the manufacturer. Dispose of used batteries according to the manufacturer's instructions.
- Be sure the PL unit's enclosure is an EN60950 approved sheet steel structure.

Package Contents

The PL package should include the following items:

■ **PL Unit**

(PL-B910/PL-B911)

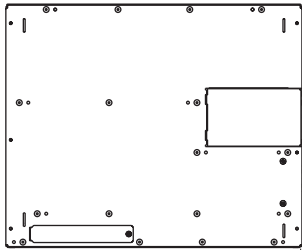

Be careful when installing the PL not to damage the built-in HDD.

■ **Power Cord**

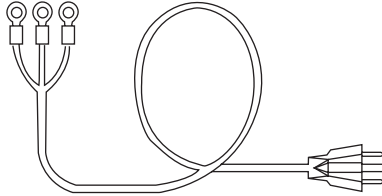

This cord is designed only for AC100/115V use. Any other voltage will require a different cable.

■ **Installation Brackets (1 set) and screws (6)**

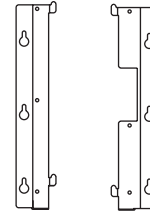

■ **Floppy Disks**

- “PL-X900 Series Driver & Utility Disk” for WIN95/NT (3)
- “PL-B910 Series Driver & Utility Disk” for WIN98SE (3)
- “USB Touch Panel Control Utility Disk” for WIN98SE (2)

■ **CD-ROM (1)**

contains PDF manual file



■ **Installation Guide (2 - English and Japanese)**

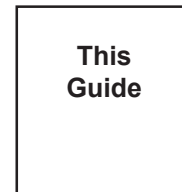

About The Manual

The CD-ROM contains the following PDF manual file.

PL-B910/B911 Series User Manual

Reading a PDF file requires installation of the Adobe Corporation’s Acrobat® Reader.

■ **Acrobat® Reader Installation:**

To install the Acrobat® Reader software, follow the steps given below.

- 1) This software, in the form of a self-extracting file, is located in this CD-ROM in the folder titled [reader]. Use the Explorer software to find the file [reader\ENG\ar405eng.exe], and double-click on the file icon to begin the Reader installation.
- 2) After Installation begins, follow the instructions given on the Installation screens.

■ **Viewing the PDF manual:**

To view the PDF manual contained in this CD-ROM, follow the steps given below.

- 1) Use the Explorer software to locate the file [manual\ENG\plb910e.pdf] in the folder titled [manual].
- 2) Double-click on the PDF file's icon. Acrobat® Reader will automatically start and the first page of the PDF manual will appear.

1 PL External Features

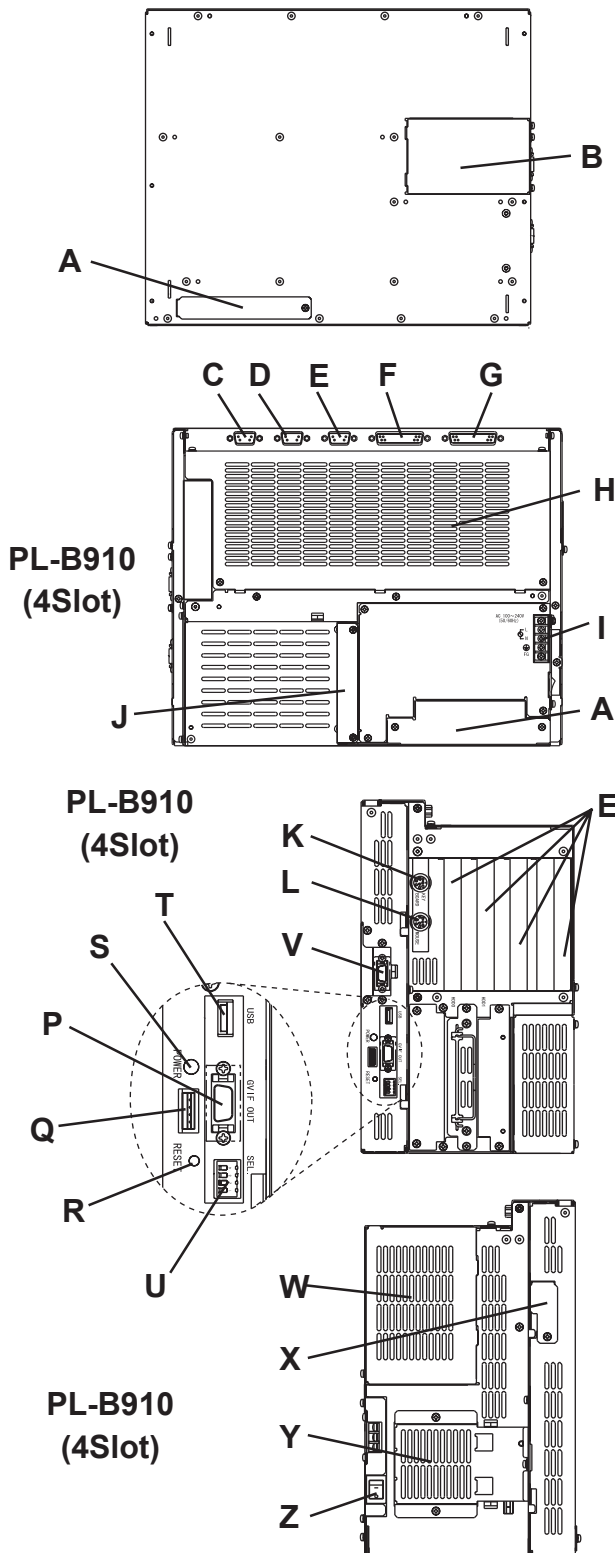

- A : Front Face FDD Unit Attachment Slot
- B : Display Expansion Board Cover
- C : RS-232C Connector (COM1)
- D : RS-232C Connector (COM2)
- E : RS-232C Connector (COM3)
- F : Printer Connector (LPT1)
- G : RAS Connector
- H : Rear Maintenance Cover
- I : Power Terminal Block
- J : IDE I/F Cover
- K : Keyboard Connector
- L : Mouse Connector
- M : Expansion Slots
- N : Side Mount FDD Slot
- O : HDD/FDD Expansion Slot
- P : Power LED
- Q : Power LED Output Connector
- R : Hardware Reset Switch
- S : Standard Display Connector (GVIF OUT)
- T : Standard USB Connector (USB)
- U : Dip Switches (SEL.)
- V : Expansion Display Connector
- W : Half Cover
- X : Analog RGB Connector Cover
- Y : Filter Cover
- Z : Power Switch

- Prior to attaching peripheral units to the PL, be sure the PL's power cord is disconnected from the main power supply.
- To prevent an electrical shock, be sure to disconnect the PL's power cord from the power supply before connecting the cord's power terminals or any peripheral devices to the PL.

2

PL Dimensions

• PL-B910 General Dimensions

(Unit: mm [in.] - excluding projections)

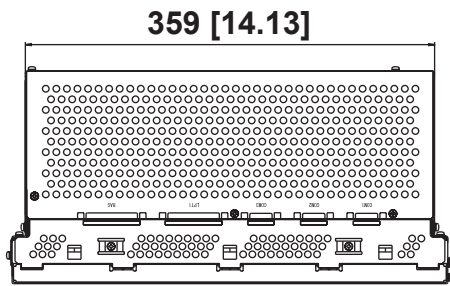

Top View

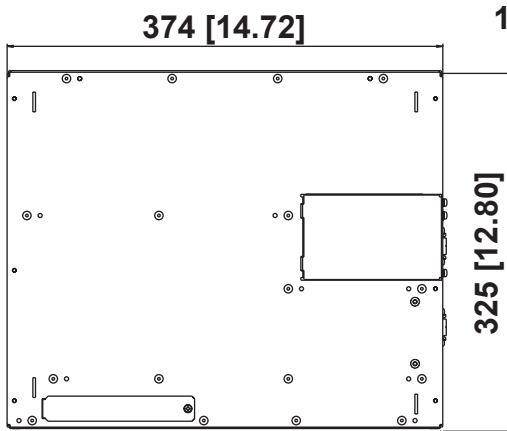

Front View

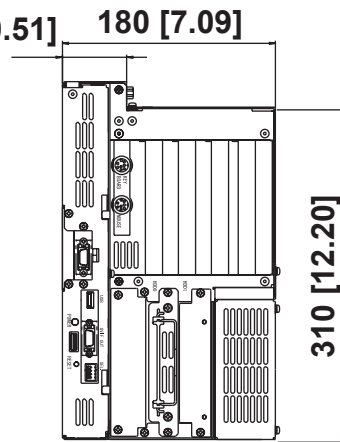

Side View

• PL-B911 General Dimensions

(Unit: mm [in.] - excluding projections)

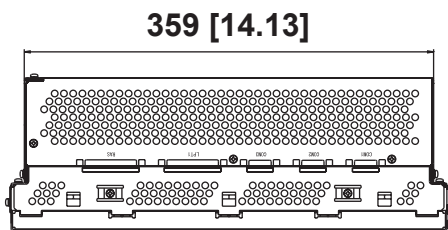

Top View

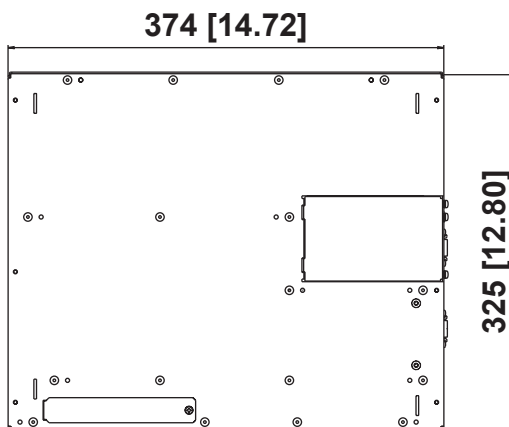

Front View

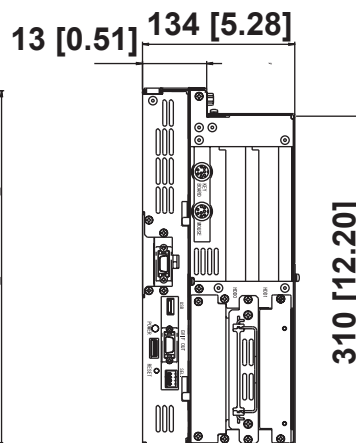

Side View

3 General Specifications

■ Electrical

	PL-B910	PL-B911
Input Voltage	AC 100V to AC 240V	
Rated Voltage	AC 85V to AC 265V	
Frequency	50/60Hz	
Allowable Voltage Drop	shorter than 1 cycle (however, pause occurrences must be more than 1 second apart)	
Power Consumption	less than 150VA	less than 100VA
Voltage Endurance	AC 1500V at 20mA for 1 minute (between charging and FG terminals)	
Insulation Resistance	Greater than 10MΩ at DC 500V (between charging and FG terminals)	

■ Structural

Ambient Operating Temperature (Cabinet Interior and Exterior)	W/Fan	5°C to 50°C
	W/out Fan *1	5°C to 40°C
Storage Temperature	-10 °C to 60 °C	
Ambient Humidity	30% RH to 85% RH (no condensation)	
Air Purity Level	Free of dust	
Atmosphere	Free of corrosive gas	
Vibration Resistance	19.6m/s ² at 10Hz to 25Hz in X, Y, Z directions for 30 minutes With HDD attached : 4.9m/s ² With FDD attached : 9.8m/s ²	
Noise Endurance (via noise simulator)	Noise Voltage: 1500V Pulse Duration: 50ns, 500ns, 1ms Rise Time : 1ns	
Electrostatic Discharge Immunity	4kV IEC 61000-4-2	
Noise Immunity	2kV IEC 61000-4-4	

*1 When the fan in the unit is uninstalled.

■ Environmental

	PL-B910	PL-B911
Grounding	Exclusive grounding only. Less than 100Ω, or your country's applicable standard.	
Installation Method	Inside a solid, flat panel	
Cooling Method	Via heat convection tubes and electric fan	
Weight	Less than 7.5 kg (16.5 lb) (with HDD and FDD installed)	Less than 6.5 kg (14.3 lb) (with HDD and FDD installed)
External Dimensions	W330 mm [12.99 in.] x H271 mm [10.67 in.] x D162 mm [6.38 in.] (excluding projections)	W330 mm [12.99 in.] x H271 mm [10.67 in.] x D116mm [4.57 in.] (excluding projections)
Dimensions Including Full-sized Cover	W385 mm [15.16 in.] x H271 mm [10.67 in.] x D162mm [6.38 in.] (excluding projections)	W385 mm [15.16 in.] x H271 mm [10.67 in.] x D116mm [4.57 in.] (excluding projections)
Dimensions Including Mirror Disk Unit	W330 mm [12.99 in.] x H271 mm [10.67 in.] x D166 mm [6.54 in.] (excluding projections)	W330 mm [12.99 in.] x H271 mm [10.67 in.] x D166 mm [6.54 in.] (excluding projections)

4 Interface Specifications

■ Printer Interface (LPT1)

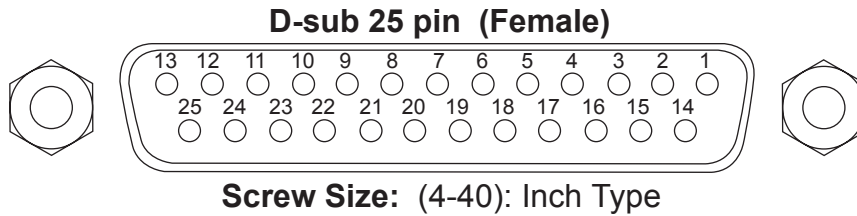

Pin No.	SPP/ECP Mode Signal Name	EPP Mode Signal Name	Direction	Electrical Specif.	Pin No.	SPP/ECP Mode Signal Name	EPP Mode Signal Name	Direction	Electrical Specif.
1	STRB	WRITE	In/Output	O.D/T.S	14	AUTOFD	DSTRB	In/Output	O.D/T.S
2	DATA0	DATA0	In/Output	T.S	15	ERROR	ERROR	Input	TTL
3	DATA1	DATA1	In/Output	T.S	16	INIT	INIT	In/Output	O.D/T.S
4	DATA2	DATA2	In/Output	T.S	17	SLCTIN	ADSTRB	In/Output	O.D/T.S
5	DATA3	DATA3	In/Output	T.S	18	GND	GND		
6	DATA4	DATA4	In/Output	T.S	19	GND	GND		
7	DATA5	DATA5	In/Output	T.S	20	GND	GND		
8	DATA6	DATA6	In/Output	T.S	21	GND	GND		
9	DATA7	DATA7	In/Output	T.S	22	GND	GND		
10	ACKNLG	ACKNLG	Input	TTL	23	GND	GND		
11	BUSY	WAIT	Input	TTL	24	GND	GND		
12	PE	PE	Input	TTL	25	GND	GND		
13	SLCT	SLCT	Input	TTL					

O.D : Open Drain, **T.S** : 3 state I/O, **TTLIN** : TTL Input

■ USB Interface (USB)

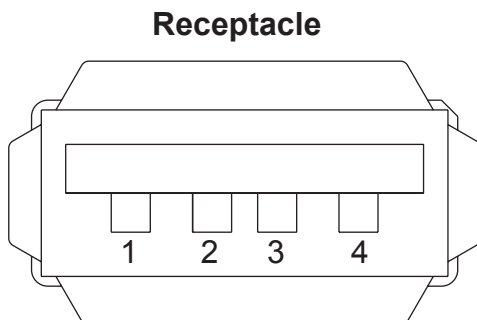

Pin No.	Name
1	Vcc
2	- Data
3	+ Data
4	GND

■ Keyboard Interface

Mini - DIN 6 pin (Female)

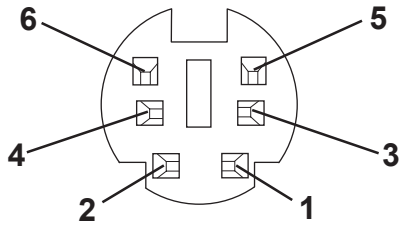

(The PL's front and side connectors are the same)

Pin No.	Signal Name
1	KEY DATA
2	NC
3	GND
4	+5V
5	KEY CLK
6	NC
SHIELD	GND

■ Mouse Interface

Mini - DIN 6 pin (Female)

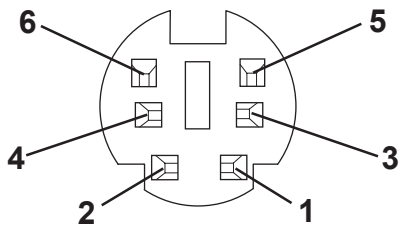

Pin No.	Signal Name
1	Mouse DATA
2	NC
3	GND
4	+5V
5	Mouse CLK
6	NC
SHIELD	GND

■ CRT Interface

D-sub 15 pin (Female)

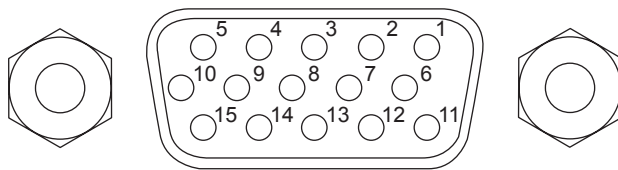

Screw Size: (4-40): Inch Type

Pin No.	Signal Name	Condition
1	Analog R	R signal input
2	Analog G	G signal input
3	Analog B	B signal input
4	Reserved	NC
5	GND	Digital signal ground
6	Return R	R signal GND
7	Return G	R signal GND
8	Return B	R signal GND
9	Reserved	NC
10	GND	Digital signal ground
11	Reserved	NC
12	Reserved	NC
13	H-SYNC	Horizontal signal input
14	Y-SYNC	Vertical signal input
15	Reserved	NC

■ RS-232C Interface (COM1/COM2/COM3)

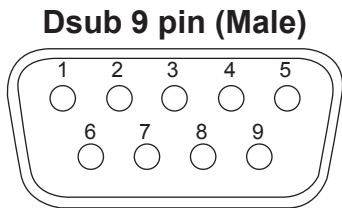

Screw Size: (4-40): Inch Type

Pin No.	Signal Name	Pin No.	Signal Name
1	CD	6	DSR
2	RXD	7	RTS
3	TXD	8	CTS
4	DTR	9	RI
5	GND		



The GND terminal is the signal ground. Be sure to connect the GND terminal to other unit's SG (signal ground).

■ RAS Interface

Dsub 25 pin (Male)

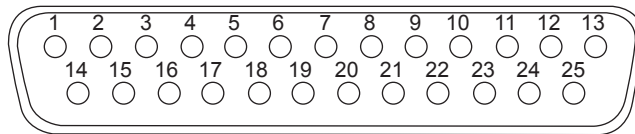

Screw Size: (4-40): Inch Type

Pin No.	Signal Name	Pin No.	Signal Name
1	GND	14	GND
2	+5V	15	+5V
3	+12V	16	NC
4	NC	17	NC
5	RESET INPUT (+)	18	NC
6	DIN 0 (+)	19	NC
7	DOUT (-)	20	NC
8	DOUT (+)	21	LAMP OUT (-)
9	ALARM OUT (-)	22	LAMP OUT (+)
10	ALARM OUT (+)	23	NC
11	RESET INPUT (-)	24	DIN1 (-)
12	DIN 0 (-)	25	NC
13	DIN 1 (+)		

■ Input Port (Dual use of DIN, Remote Set Input Port)

- External Power : DC12V to 24V connection possible
- Input Hold : Hold Diode
- Isolation : Used (Photo isolation)

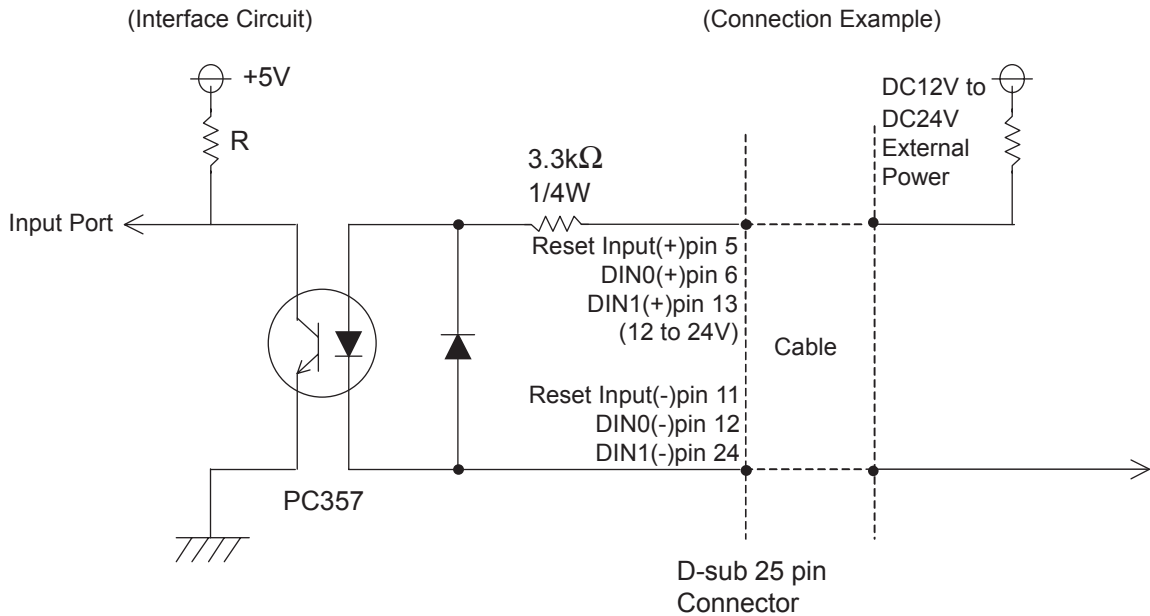

■ Output Port (DOUT, Alarm Output, Lamp Output Port)

- Output Spec. : DC 24V 100mA (MAX)
- Isolation : Used (Photo isolation)

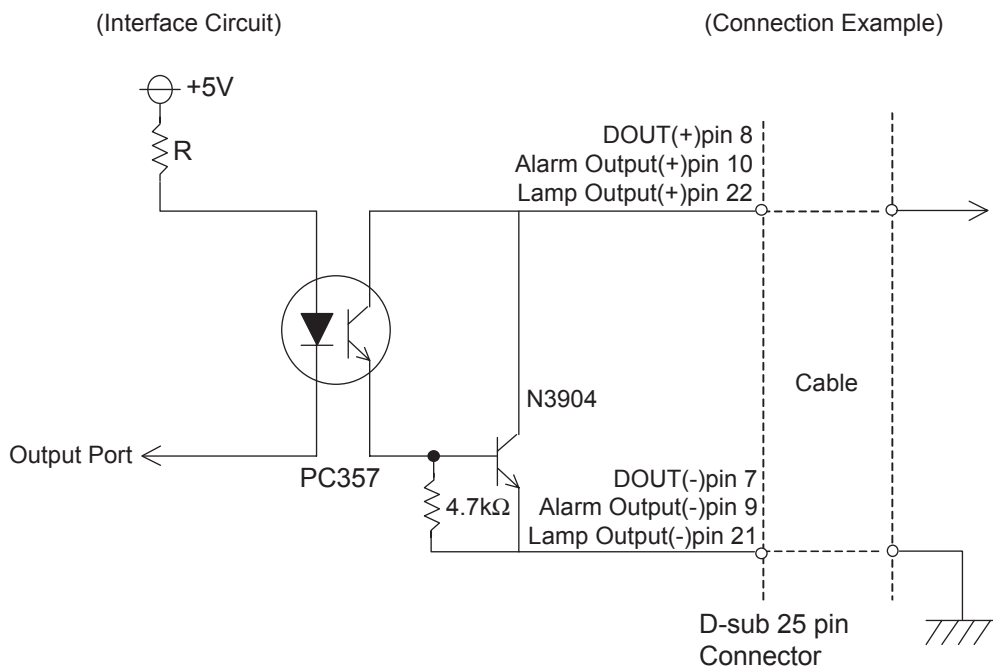

5 Installing the PL

Use the following procedures to install the PL into a solid panel.



Note: When using the optional 19 inch Mount Panel, refer to the PL-RM200 unit's Installation guide for details.

- 1) Use the six (6) attachment screws included in the PL's packing box to attach the mounting brackets to the PL main unit. Be careful that each bracket is attached to the correct side.

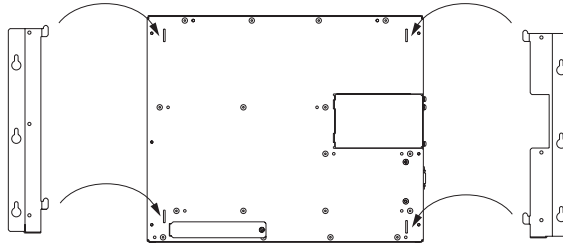

- 2) Drill the attachment holes in the Installation Panel. Be sure to follow the dimensions given for the attachment holes.

(Unit : mm [in.] - excluding projections)

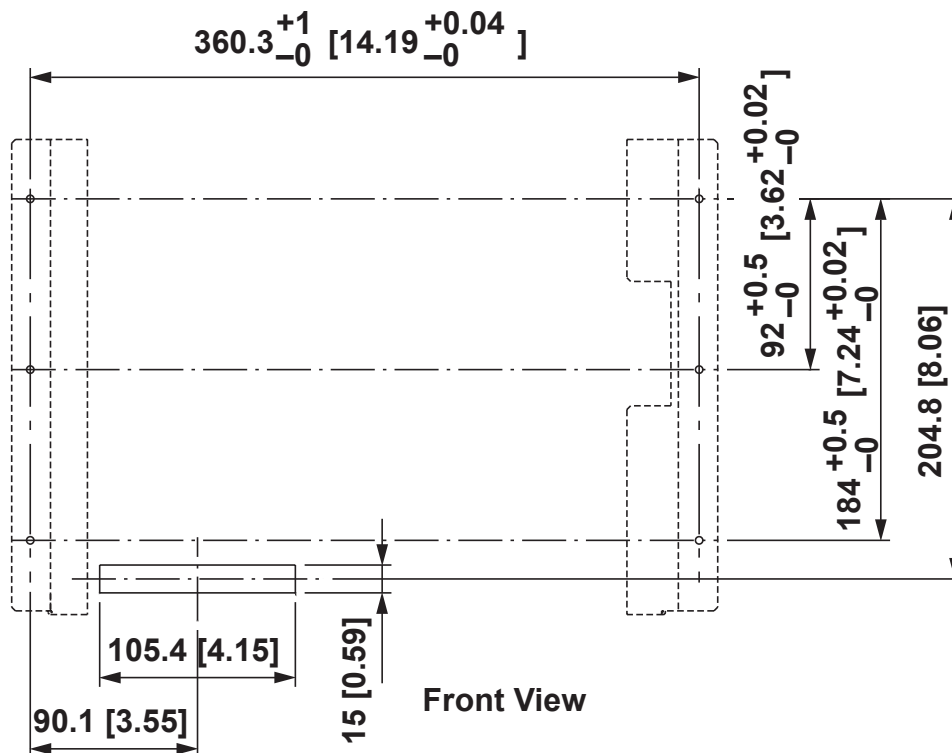

- Depending on the panel's material and design, the panel's installation surface may need to be strengthened. If high levels of vibration are expected and the PL's installation surface (i.e. an operation panel's door, etc.) can move (i.e. open or close) due consideration should be given to the PL's weight.
- Be sure all installation tolerances are maintained to prevent the unit from falling out of its installation panel.

3) Attach the PL to the Installation Panel with M4 screws.

First, insert the main unit attachment screws into the Installation Panel's holes, but do not tighten them. Then, place the PL main unit on the panel so that the bracket holes and the screw heads align. Next, slide the PL down so that the main unit is supported by these attachment screws. Last, tighten the screws until the PL is secured in place.



Do not use excessive force when tightening the main unit attachment screws. The torque required is from 0.5 to 0.6N•m.

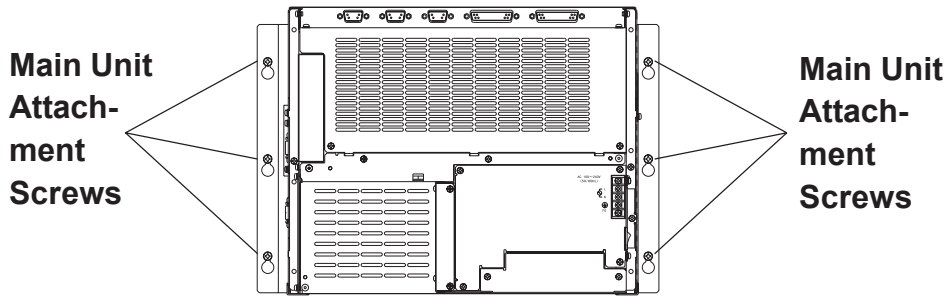

6 Wiring the PL

■ Connecting the power cord

(Side View of PL)

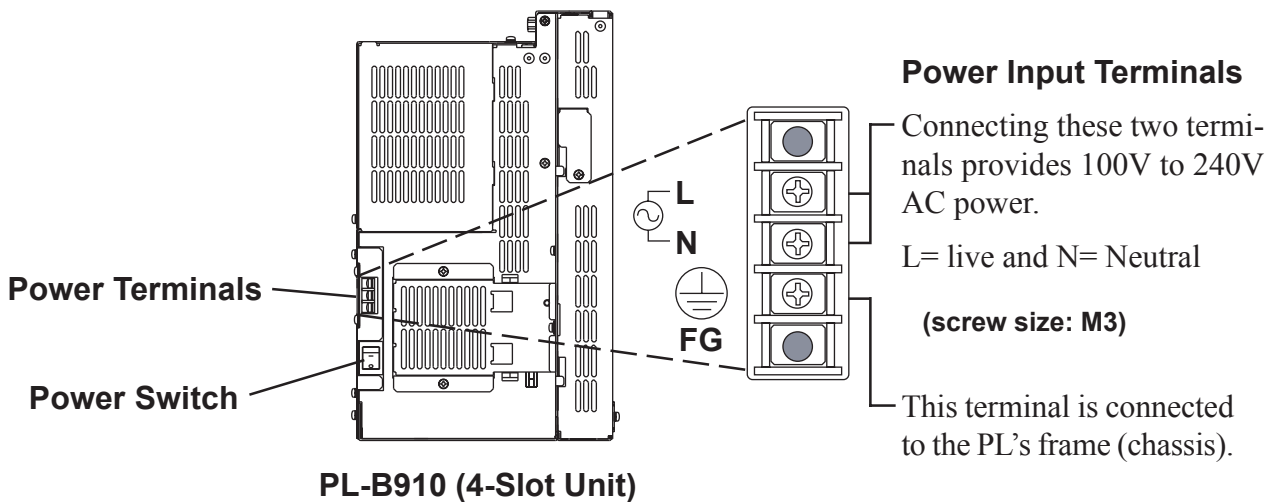

WARNINGS

- To prevent electric shocks, be sure to turn the PL's power supply OFF before connecting the power cord.
- To avoid the dangers of fire, electric hazards and equipment damage, be sure to use only the specified power supply voltage when operating the PL.

Use the following steps when connecting the power cord to the PL's power terminals.

POWER

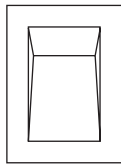

I :ON
o :OFF

1) Confirm that the PL unit's power switch is turned OFF. Then, remove the power terminal's transparent plastic cover.

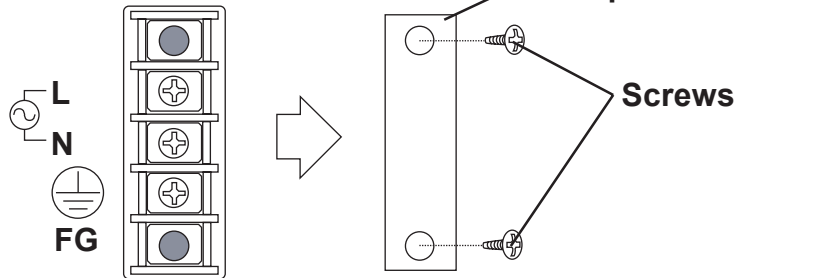

2) Loosen and remove the middle three(3) screws from the terminal strip. Align the crimp terminals with each screw hole, and tighten the screws.

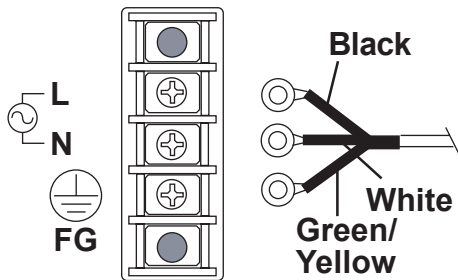

- Crimp Terminal Types : V1.25-3, by J.S.T. or equivalent (JIS standard part number : **RAV1.25-3**)
- Crimp terminals must be the same as shown below.

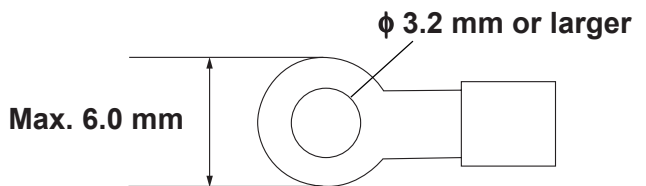

Attachment Screws



- The colors in the figure above are for the cable which came with the PL.
- This power cable is designed only for AC100/115V use. Be sure to use a different cable when using other than AC100/115V power.

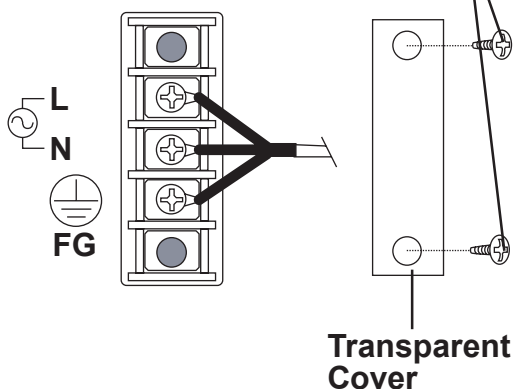

3) Reattach the terminal strip's transparent cover with the attachment screws.

7 Power Supply Cautions

When connecting the PL unit's AC power terminals, please be aware of the following:

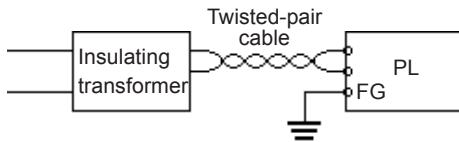
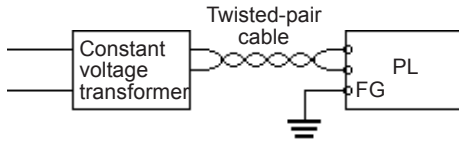

- If voltage fluctuations are expected to vary beyond the specified range, connect a constant voltage transformer.
- Use a low-noise power supply both between the lines and between the PL and its ground. If there is still excess noise, connect an insulating transformer (noise-prevention type).



Note: Be sure any constant or insulating transformer used has a capacity of 200VA or more.

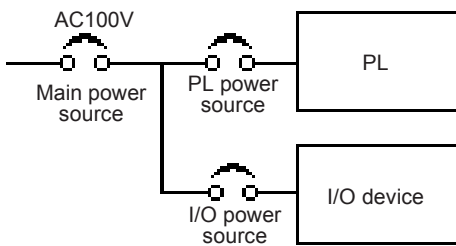

- Wire the power cords of the PL, I/O devices, and power supply devices separately.
- To improve noise immunity, it is recommended to attach a ferrite core to the power cord.

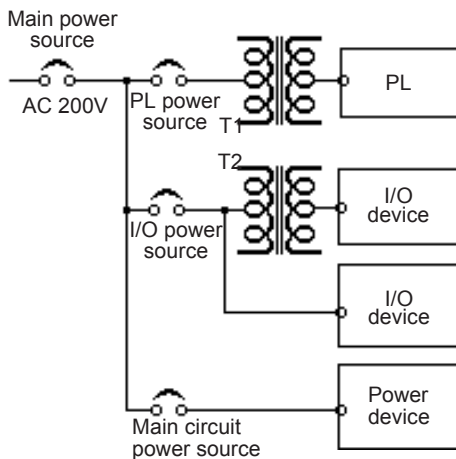

- Isolate the main circuit (high voltage, large current) line, I/O signal lines, and power cord, and do not bind or group them together.
- To prevent damage from lightning, connect a lightning surge absorber.

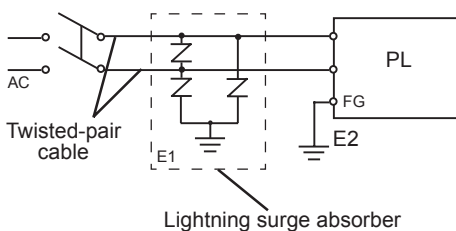

- Ground the lightning surge absorber (E1) and the PL (E2) separately.
- Select a lightning surge absorber which will not exceed the allowable circuit voltage, even when the voltage rises to the maximum.

8 Grounding Cautions

(a) Dedicated Ground



- Set up a dedicated ground when using the rear panel's FG terminal.

(b) Shared Ground - allowed

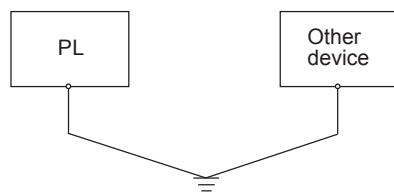

- If a dedicated ground is not possible, use a shared ground, as shown in figure (b).

(c) Shared ground - not allowed

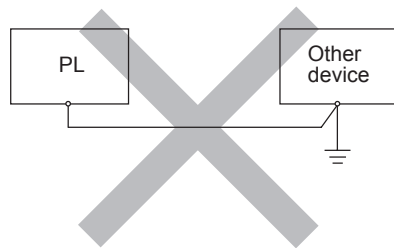

- The grounding point must be as close to the PL as possible, and the grounding wires must be as short as possible. If the wires must be long, use thick, insulated wires and run them through conduits.

9 Cautions When Connecting I/O Signal Lines

- I/O signal lines must be wired separately from the power circuit cable. If the power circuit cable needs to be wired together with the input/output (I/O) signal lines for any reason, use shielded cables and ground one end of the shield to the PL's FG terminal.
- To improve noise immunity, it is recommended to attach a ferrite core to the power cord.

Note

Be aware that the Digital Electronics Corporation shall not be held liable for any real or estimated damages or losses, or third party claims resulting from the use of this product.