

FP-3710K Series User Manual



Preface

Thank you for purchasing Digital's TFT type color display panel, the 'FP-3710K Series' (hereafter referred to as the FP unit).

Please read this manual completely to insure the correct use and complete understanding of the FP unit's functions.

NOTICE

1. Copying this manual's contents, either in whole or in part, is prohibited without the express permission of Digital Electronics Corporation, Japan.
2. The information contained in this manual is subject to change without notice.
3. If you find any errors or omissions in this document, please contact Digital Electronics Corporation to report your findings.
4. Please be aware that Digital Electronics Corporation shall not be held liable by the user for any damages, losses, or third party claims arising from the uses of this product.

Product names used in this manual are the trademarks / registered trademarks of their respective owners.





© 2008 Digital Electronics Corporation. All rights reserved.

Essential Safety Precautions







This manual describes safety instructions for correct use of the FP unit. Please keep this manual close at hand and refer to it when necessary.

Safety Icons

Throughout this manual, these icons provide essential safety information for FP operation procedures requiring special attention. These icons indicate the following levels of danger:

 WARNING	Indicates situations where severe bodily injury, death or major equipment damage can occur.
 CAUTION	Indicates situations where slight bodily injury or minor equipment damage can occur.
	Indicates actions or procedures that should NOT be performed.
	Indicates actions or procedures that MUST be performed to ensure correct unit operation.

WARNING

-  Because of the ever present danger of electrical shock, be sure to unplug the power cable from the FP unit before plugging the cable's other end into the wall.
-  Do not use power in excess of the unit's specified voltage range since it may cause a fire or electric shock.
-  Because the FP unit contains high voltage parts, an electric shock can occur when disassembling the unit. Therefore, be sure to always unplug the unit before disassembling it.
-  Do not modify the FP unit in any way, since it may cause a fire or electric shock.
-  Do not use touch panel keys to perform life-threatening or vitally important safety functions. Use separate mechanical switches for such keys.
-  Do not use the FP unit as a warning device for critical alarms that can cause serious operator injury, machine damage or production stoppage. Critical alarm indicators and their control/activator units must be designed using stand-alone hardware and/or mechanical interlocks.

- ⊘ In a situation that a detection function for the backlight burnout has been ineffective, if a burnout of the backlight happened, unlike in an extinction condition of the backlight of FP, the touch panel is still active. If an operator fails to notice that the backlight is burned out and touches the panel, a potentially dangerous machine miss-operation can occur. Therefore, do not set up switches on the touch panel of an FP that are likely to cause human error or physical damage triggered by mis-operation.

If your FP's backlight suddenly turns OFF, use the following steps to determine if the backlight is actually burned out.

1) If your current FP application or Auto off Disp function is not set, and the screen has gone blank, your backlight is burned out.

2) If your current FP application or Auto off Disp function is set, and if touching the screen does not cause the display to reappear, your backlight has been burned out.

- ⚠ If substantial amounts of metallic dust, water or liquids enter the FP unit, turn off the power supply immediately, unplug the power cord, and contact your local FP distributor.
- ⚠ When installing the FP unit, be sure to follow the instructions given in "Chapter 3 Installation and Wiring," to insure it is done correctly.
- ⊘ Do not use the FP in an environment with flammable gas, since it may cause an explosion.
- ⊘ The FP is not appropriate for use with aircraft control devices, aerospace equipment, central trunk data transmission (communication) devices, nuclear power control devices, or medical life support equipment, due to these devices' inherent requirements of extremely high levels of safety and reliability.
- ⚠ When using the FP with transportation vehicles (trains, cars and ships), disaster and crime prevention devices, various types of safety equipment, non-life support related medical devices, etc, redundant and/or failsafe system designs should be used to ensure the proper degree of reliability and safety.

 **CAUTION**

- ⊘ Do not press the screen's touch surface too strongly with either your finger or a hard object, since the touch surface may be damaged.
- ⚠ When the surface of the display screen becomes dirty or smudged, clean the display with a cloth soaked in a neutral detergent. Do not use paint thinner or organic solvent.
- ⊘ Do not press on the touch panel's face with sharp objects, such as a mechanical pencil or screwdriver, since it might damage the LCD panel.
- ⊘ Avoid using or storing the FP in direct sunlight, excessively dusty or dirty environments, or where chemicals or their vapors are present in the air.

- ⊘ Avoid restricting the FP's natural ventilation, or storing and using the FP in an environment that will increase the FP's internal temperature.
- ⊘ Do not use the FP in areas where sudden, large changes in temperature may occur. These changes can cause condensation to form inside the unit, possibly causing an accident.
- ⊘ Do not store or use the FP where chemicals (such as organic solvents, etc.) and acids can evaporate, or where chemicals and acids are present in the air.
- ⚠ When the product is disposed of, it should be done so according to your country's regulations for similar types of industrial waste.

LCD Panel Usage Precautions

Notes on the FP's Liquid Crystal Display (LCD)

For detailed LCD information, please contact Digital's Development department, Product Quality Assurance group.

- The FP's LCD contains a strong irritant. If the panel is damaged and the LCD unit's liquid contacts your skin, be sure to wash it with running water for at least 15 minutes. If any of this liquid should enter your eye, be sure to flush the eye with running water for more than 15 minutes, and see a doctor immediately.
- The FP unit's LCD screen may flicker or show unevenness in the brightness of certain images or at some contrast settings. This is an LCD characteristics and not a product defect.
- There's an individual difference in brightness and tone of LCD screen. Please be aware of this difference before using the lined-up plural units.
- There are minute grid-points on the LCD surface. These points are not defects.
- The displayed color will look different when viewed from an angle outside the specified view angle. This is also normal.
- Displaying a single screen image for long periods of time can cause an afterimage to remain. To correct this, turn the unit OFF for 5 or 10 minutes, then turn it ON again. This phenomenon is a common attribute of the LCD unit's, and not a defect. To prevent this effect, you can:
 - use the Display OFF feature, if the same image is to be displayed for a long period of time.
 - change the screen display periodically to prevent the displaying of a single image for a long period of time.

Connecting the FP to a PC

The FP-3710K Series is designed for the following resolutions.

Series	Full Resolution
FP-3710K Series	1024X768

Be aware that some types of devices for image signal output may not be within the ranges specified in this document, and, therefore, cannot be connected to the FP.

Also, if you change your PC's Analog RGB/DVI-D board, there is the possibility that the new board may not be able to be connected to the FP.

SEE →

4.1.3 Interface Specifications (page4-5)

IMPORTANT

- When a signal timing value not compatible with this device is entered, or if the entered timing is larger than can be displayed by the dot clock, an “Out of range” message is displayed. If this occurs, be sure to read your computer’s manual and enter a value that is compatible with this device.
- If no signal (synchronized signal) is entered, a “No signal” message is displayed.

Information Symbols

This manual uses the following icons:

IMPORTANT	Indicates a warning or a product limitation. Be sure to follow the instructions given with this icon to ensure the safe operation of the FP.
NOTE	Contains additional or useful information.
(1) (2)	Indicates steps used to accomplish a given task. Be sure to follow these steps in the order they are written.
*1	Indicates useful or important supplemental information.
SEE →	Indicates pages containing related information.

FP-3710K Series Models

The FP-3710K Series refers to the following FP model numbers:

Series	Product Name	Model Type	Power input type	Standards
FP-3710K Series	FP-3710K	FP3710-K41-U	AC	UL/c-UL Approved, CE Marked, FCC Statement

FP-3710K Series Package Contents

The FP unit's packing box contains the items listed below. Please check to be sure each item is included and is not damaged.

FP Unit (1)

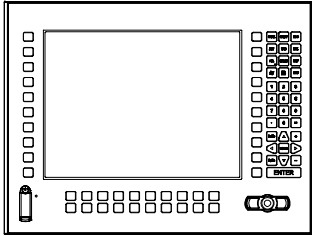

Installation Guide (1) (English / Japanese)

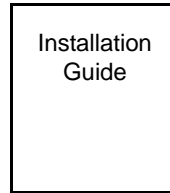

Installation Gasket (attached to the FP unit) (1)



Installation Fasteners (4 fasteners per set) (3 sets)

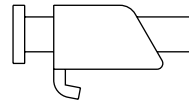

AC Power Connector (attached to the FP unit) (1)

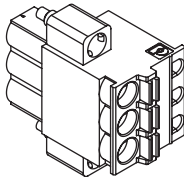

USB Cable Clamp (1)

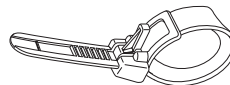

Warning Caution Information (1)

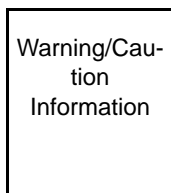

This unit has been carefully packed, with special attention to quality. However, should you find anything damaged or missing, please contact your local FP distributor immediately.

Main Features

FP-3710K Series displays are equipped with the following features.

■ FP-3710K Series

- High Quality TFT Color LCD Display

This unit is equipped with a 15.0 inch TFT type color LCD. Its superior brightness and wide viewing angle, not found in ordinary laptop-type TFT LCDs, widens your scope of applications.

The screen's maximum resolution is 1024(H) × 768(V) pixels and can display 16,770,000 colors.

- Easy Installation In User's Cabinets and Panels

The FP's slim and compact design makes installation a snap since it was designed specifically for use as an IA (Industrial Automation) or OA (Office Automation) system monitor. The flat, front panel provides protection equivalent to the rigorous IP65f standard. Even without its optional protective cover the front panel is highly resistant to both water and dust.

- Panel can be used as a VGA Display

Since the FP is equipped with an analog RGB interface and a DVI-D Interface, it can be connected to a PC and other, similar devices. (The PC's dot clock frequency, however, must be within the standard range.)

- Easy-to-use Built-In Touch Panel

The FP's built-in touch panel is standard equipment, allowing touch panel data to be output to a host PC via an RS-232C cable or USB cable. This is perfect for systems requiring both touch panel operation and data monitoring.

- USB-HUB function

This unit has USB-HUB function and can connect USB devices to the front USB connector.

- Keypad and Mouse Pointer

Because the keypad and the mouse pointer are installed, the keyboard operation and the mouse operation can be done with not only the touch operation but also the unit.

What is IP65f?

This unit's protection rating of IP65f is actually a composite code, consisting of the internationally recognized British "Ingress Protection" standard (BS EN 60529:1992) - "IP65", and the standard developed by the Japanese Electronics Manufacturer's Association (JEM) - "F". This code is used in this manual to identify a given product's degree of structural resistance to a variety of environmental elements and thus, prevent problems or accidents related to the inappropriate use of a product. The individual meaning of each character of this code is explained below.

I P 6 5 f
(1) (2) (3) (4)

(1)	Designates the type of protection provided.
(2)	Indicates the degree of protection provided to the human body by the unit, and the degree of protection provided by the unit's front face from particles/dust intrusion into the interior of the unit. Here, "6" indicates that the unit is completely protected from dust intrusion.
(3)	Indicates the degree of protection provided by the unit's front face from water intrusion into the interior of the unit. Here, "5" indicates that the unit is protected from water intrusion from a direct water jet.
(4)	Indicates the degree of protection provided by the unit's front face from oil particle intrusion into the interior of the unit. Here, "f" indicates that the unit is completely protected from oil intrusion via either oil particles or oil splashes from any direction (to the front panel).

Required Software /Reference Manual

The FP-3710K Series unit needs the following software for operation. As the FP user manual, provided by PDF media, describes its details, download the manual below and get the further information. Visit our support site below and get both software and reference manual.

Digital Electronics Corporation's support site - Otasuke Pro!

<http://www.pro-face.com/otasuke/>

- Software: Mouse Emulation Software
- Manual: FP-3710K Series User Manual

Installation prerequisites for standards

- UL listed products

Industrial Control Equipment	refer to UL508	see [a] in the "Product List"
Suitable for use in Class I, Division 2, Groups A, B, C, and D Hazardous (classified) locations, or Non-Hazardous Locations.	refer to ANSI/ISA 12.12.01	see [b] in the "Product List"

- c-UL listed products

Process Control Equipment	refer to CSA-C22.2 No.142	see [c] in the "Product List"
Suitable for use in Class I, Division 2, Groups A, B, C, and D Hazardous (classified) locations, or Non-Hazardous Locations.	refer to CSA-C22.2 No. 213	see [d] in the "Product List"

- Product List

Product Model No.	Registration Model No.	UL		c-UL	
		[a]	[b]	[c]	[d]
FP3710-K41-U	3620004-01	✓	✓	✓	✓

UL/c-UL File No.: E220851, E210412

For the detailed certification's information, refer to the Pro-face Home page.

<Cautions>

- The FP must be used as a built-in component of an end-use product.
- This unit should be installed in the front face of a metal panel.
- If this unit is installed so as to cool itself naturally, be sure to install it in a vertical panel.

Also, be sure that the FP unit is mounted at least 100 mm away from any adjacent structures or equipment. If these requirements are not met, the heat generated by the FP unit's internal components may cause the unit to fail to meet UL/c-UL standard requirements.

- For use in Pollution Degree 2 environment
- For use on a flat surface of a Type 4X (Indoor Use Only) and/or Type 12 Enclosure.
- Type 4X (Indoor Use Only) and/or 12 Enclosure, when the hatch for Front USB Port is secured by screw.
Type 1 Enclosure, when the hatch for Front USB Port is open.
- Receivable signals are only from isolated secondary source.
- All interface ports (except for Front USB Connector (Type A)) are not intended to be directly connected to a signal source greater than 30 volts and available current greater than 5mA.

<Compliance and Handling Cautions in Hazardous Locations>

- Suitable for use in Class I, Division 2, Groups A, B, C, and D Hazardous Locations only.
- **WARNING:** Explosion hazard - substitution of components may impair suitability for Class I, Division 2.
- **WARNING:** Explosion hazard - do not disconnect equipment while the circuit is live or unless the area is known to be free of ignitable concentrations.

<Control Drawing of USB I/F on FP's Front Module>

The information below concerns the use of the USB I/F located on the FP unit's front modules used in Class I, Division 2 Groups A, B, C, and D hazardous locations (from Doc No. 35016429).

FP's Front Module

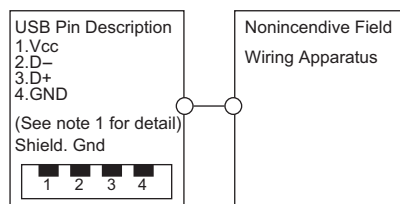

Notes:

- (1) Nonincendive Circuit Parameters:

Front USB I/F:

$V_{oc} = 5.0 \text{ V}$, $I_{sc} = 1.25 \text{ A}$, $C_a = 10 \text{ mF}$, $L_a = 16 \text{ mH}$

- (2) Selected Associated Nonincendive Field Wiring Apparatus shall satisfy the following:

Nonincendive Field Wiring Apparatus	-	Front module of FP unit
V_{oc}	\leq	V_{max}
I_{sc}	\leq	I_{max}
C_a	\geq	C_i+C cable
L_a	\geq	L_i+L cable

- (3) If the electrical parameters of the cable are unknown, the following values may be used:
Capacitance = 60pF/ft, Inductive = 0.20 $\mu\text{H}/\text{ft}$
- (4) Nonincendive Field Wiring must be installed in accordance with article 501.10(B) of the National Electrical Code ANSI/NFPA 70.
- (5) Nonincendive Field Wiring Apparatus shall not contain or be connected to another source of power.

The safety certificate can be downloaded from Pro-face Home Page.

Home Page URL

<http://www.pro-face.com/>

CE Marking

The FP-3710K Series are CE marked products complying with both the EMC Directive and low-voltage directive.

For the detailed information on CE Marked, be downloaded and refer the Declaration of Conformity from Pro-face Home Page.

Home Page URL

<http://www.pro-face.com/>

FCC Statement

United States FCC Part 15, Subpart B, Class A EMI Compliance Statement:

NOTE: This equipment has been tested and found to comply with the limits for a Class A digital device, pursuant to part 15 of the FCC Rules. These limits are designed to provide reasonable protection against harmful interference when the equipment is operated in a commercial environment. This equipment generates, uses, and can radiate radio frequency energy and, if not installed and used in accordance with the instruction manual, may cause harmful interference to radio communications. Operation of this equipment in a residential area is likely to cause harmful interference in which case the user will be required to correct the interference at his or her own expense.

About Revision

The nameplate on the FP has the revision number of the FP. In the example below, the asterisk, which is placed at the "A" position, shows that the revision number is "A".

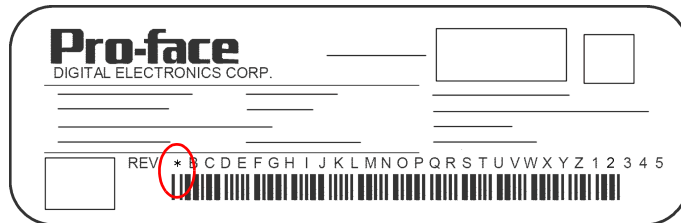

When FP is Rev. A

Table of Contents

Preface	1
Essential Safety Precautions	2
Connecting the FP to a PC	5
Information Symbols	6
FP-3710K Series Models	6
FP-3710K Series Package Contents	7
Main Features	8
What is IP65f?	9
Required Software /Reference Manual	9
Installation prerequisites for standards	10
CE Marking	12
FCC Statement	12
About Revision	12
Table of Contents	13
Chapter 1 System Design	
1.1 FP-3710K Series	1-2
1.2 Cables for connecting with computer	1-3
Chapter 2 Optional Equipment	
2.1 Optional Equipment	2-2
2.1.1 Cables	2-2
2.1.2 Maintenance Parts	2-6
2.1.3 Related Software	2-6
Chapter 3 Part Names and Functions	
3.1 FP-3710K Series	3-2
Chapter 4 Specifications	
4.1 FP-3710K Series	4-2
4.1.1 General Specifications	4-2
4.1.2 Functional Specifications	4-4
4.1.3 Interface Specifications	4-5
4.1.4 Dimensions	4-12

Chapter 5	Installation and Wiring	
5.1	Installation.....	5-2
5.1.1	Installation Procedures	5-2
5.2	Wiring.....	5-7
5.2.1	Connecting the Power Cord.....	5-7
5.2.2	The USB Cable Clamp	5-9
5.2.3	Connecting the Power Supply	5-10
5.2.4	Precautions: Grounding	5-11
5.2.5	Precautions: Input/Output Signal Lines	5-11
Chapter 6	Setting up and Adjusting the FP unit	
6.1	Operation Mode Setup.....	6-2
6.1.1	Preset Settings and Adjustments for Dip Switch and Slide Switch.....	6-2
6.1.2	Status of Front LED in Operation Modes	6-3
6.2	Screen Display Adjustment.....	6-4
6.2.1	Calibration of OSD Display Position	6-4
6.2.2	OSD Setting Icons	6-6
6.2.3	OSD Setting Item Details.....	6-7
Chapter 7	Touch Panel Data	
7.1	Touch Interface Data.....	7-2
Chapter 8	Keyboard Operation	
8.1	About KeyPad Module	8-2
8.2	Features of KPM.....	8-3
8.3	Scan Code List	8-4
8.4	Configuring the Keyboard Layout	8-6
8.5	Restrictions	8-13
Chapter 9	Troubleshooting	
9.1	Troubleshooting	9-2
9.1.1	Possible Device Problems	9-2
9.1.2	No Display	9-3
9.1.3	Touch Panel Does Not Respond	9-5
9.1.4	Trouble of keypad operation	9-6
9.2	Error Message	9-7

9.2.1 Error Message List	9-7
--------------------------------	-----

Chapter 10 Maintenance

10.1 Regular Cleaning	10-2
10.1.1 Cleaning the Display	10-2
10.1.2 Replacing the Installation Gasket.....	10-3
10.2 Periodic Check Points.....	10-5
10.3 Backlight Replacement	10-6
10.3.1 FP-3710K Series.....	10-6

1



System Design

1. FP-3710K Series
2. Cables for connecting with computer

1.1 FP-3710K Series

The FP can be connected to Pro-face's PS-2000B, PS-3000B, PS4000 series, PL3000 Series or to a Windows® compatible PC.

For image signal connection, cables vary depending on a device to be connected.

SEE → 1.2 Cables for connecting with computer (page1-3)

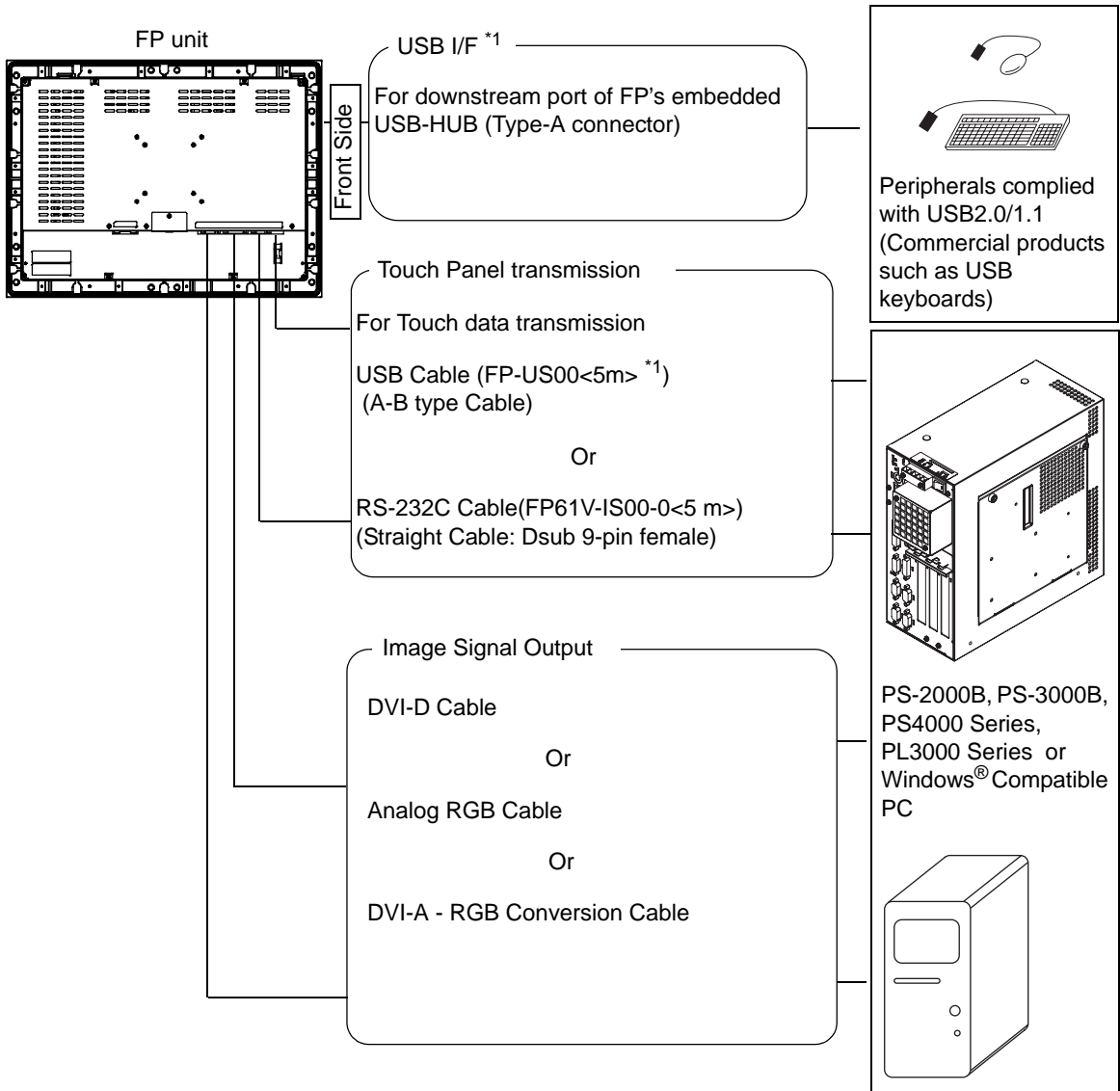

NOTE • The FP unit's slide switches set the type of cable(s) used for sending touch data (USB or RS232C).

SEE → 6.1.1 Preset Settings and Adjustments for Dip Switch and Slide Switch (page6-2)

*1 When a keyboard, mouse pointer, and USB I/F are used, it is necessary to connect the FP with a computer using the USB cable (FP-US00).

1.2 Cables for connecting with computer

This section describes cables to connect the FP with a computer.

Monitor	Interface	Cable	Interface	Computer
FP	DVI-D	FP-DV01-50 (DVI-D Cable 5m)	DVI-D	PS-2000B
		FP-DV01-100 ^{*1} (DVI-D Cable 10m)		
	Analog RGB	FP-CV02-45 (Analog RGB Cable)	Analog RGB	
	Analog RGB	FP-CV02-45 (Analog RGB Cable)	Analog RGB	PS-3000B
	DVI-D	FP-DV01-50 (DVI-D Cable 5m)	DVI-I	PS4000 Series ^{*2*3}
	Analog RGB	CA7-CBLCVRGB-01 (DVI-A - RGB Conversion Cable)		
		FP-CV02-45 + CA7-CBLCVRGB-01 (Analog RGB Cable + DVI-D/RGB Branch Cable)		
	DVI-D	FP-DV01-50 (DVI-D Cable 5m)	DVI-D ^{*4}	
	DVI-D	FP-DV01-50 (DVI-D Cable 5m)	DVI-I	PL3000 Series
		FP-DV01-100 ^{*1 *5} (DVI-D Cable 10m)		
	Analog RGB	CA7-CBLCVRGB-01 (DVI-A - RGB Conversion Cable)		
		FP-CV02-45 + CA7-CBLCVRGB-01 (Analog RGB Cable + DVI-D/RGB Branch Cable)		
	DVI-D	FP-DV01-50 (DVI-D Cable 5m)	DVI-D	Windows [®] Compatible PC ^{*6}
Analog RGB	CA7-CBLCVRGB-01 (DVI-A - RGB Conversion Cable)	DVI-I		
	FP-CV02-45 + CA7-CBLCVRGB-01 (Analog RGB Cable + DVI-D/RGB Branch Cable)			
	Analog RGB	P-CV02-45 (Analog RGB Cable)	Analog RGB	

*1 Cannot be connected to FP-3500T and 3600T series.

*2 Except for the models equipped with Atom Z510.

*3 For connection with an FP which is not marked on Rev. 2, use an analog RGB interface of the FP.

*4 Available only when an expansion DVI-D interface is added in PS4000B series.

*5 Supported when Rev. B or later PL3000 is used.

*6 For connection with the FP which is not marked on Rev. 2, connection may not be made with a DVI-D interface of the FP. In that case, use an analog RGB interface of the FP.

2



Optional Equipment

1. Optional Equipment

2.1 Optional Equipment

All optional items listed below are products of Digital Electronics Corporation.

2.1.1 Cables

For image signal connection, cables vary depending on a device to be connected.

SEE → 1.2 Cables for connecting with computer (page 1-3)

Product Name	Model No.	Description
RS-232C Cable	FP61V-IS00-O	Serial interface cable (5m) used for touch panel data transmission between the host and the FP. This is a straight Dsub9 pin female cable.
USB Cable	FP-US00	USB interface cable (5m) used for touch panel data transmission between the host and the FP. The cable type is A-B.
Analog RGB Cable	FP-CV02-45	Analog RGB interface cable when image signal is output to the FP from the host. (Dsub15 pin male) (4.5m)
DVI-D Cable	FP-DV01-50 FP-DV01-100*1	Digital Visual Interface cable used to send the image signal from the host to the FP. (DVI-D 24-pin male) (5 m or 10 m)
DVI-I - RGB Conversion Cable	CA7-CBLCVRGB-01	A cable converting DVI-A to RGB. (5m)

*1 Only when the FP-3710K series is connected with PS-2000B or PL3000 Series (Revision B or more), FP-DV01-100 can be used.

- Please turn on PS-2000B's internal dipswitch 4 when use FP-DV01-100 with PS-2000B. (The resolution that can be displayed is 1024 x 768 Become only (XGA).)
Please turn off dipswitch 4 when use FP-DV01-50.
- Please set PL3000 Series's internal dipswitch 5 to ● sign side when you use FP-DV01-100 with PL3000 Series.

We will recommend the resolution of PL3000 Series to change to the maximum display resolution of FP additionally.

Please set it on the opposite side of ● sign when use FP-DV01-50.

■ Optional Cable Diagrams

<RGB Interface Cable Pin Connections>

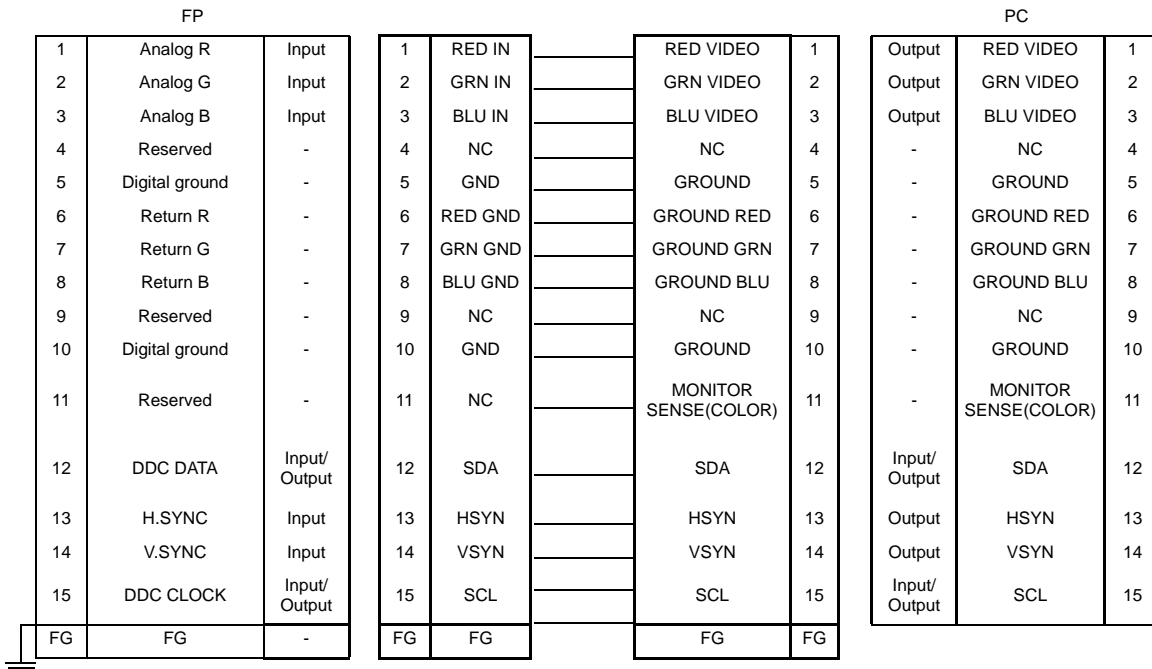

Signals and signal names used with the FP and the RGB cable (optional cable) are the same as those used for PCs. Also, the same pin is used on both sides of the optional cable so that you can connect the cable regardless of the cable direction.

Inch is used for the pitch of the connector screw on the PC. For this reason, inch (#4-40 UNC) is also used for the pitch of the connector screw for the cable and the FP.

<DVI-D Interface Cable Pin Connections>

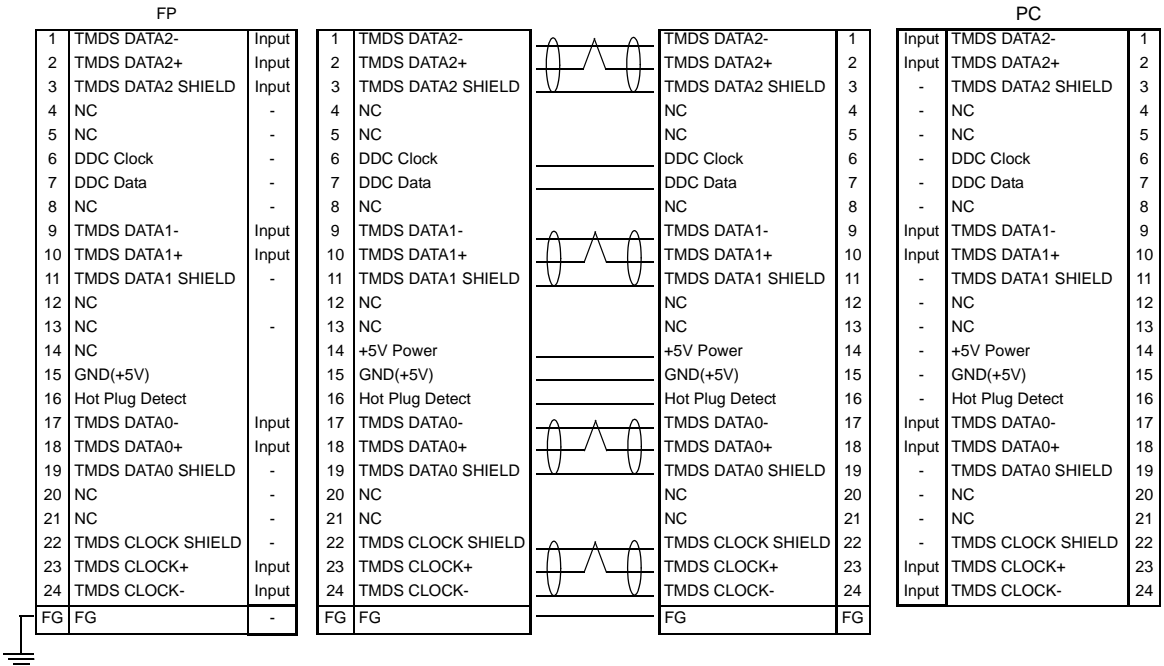

Signals and signal names used with the FP and the DVI-D cable (optional cable) are the same as those used for PCs. Also, the same pin is used on both sides of the optional cable so that you can connect the cable regardless of the cable direction.

Inch is used for the pitch of the connector screw on the PC. For this reason, inch (#4-40 UNC) is also used for the pitch of the connector screw for the cable and the FP.

- NOTE**
- The FP-DV01-100 cable's 6, 7, 14 and 15 pins are not connected.

<SIO Interface Cable Pin Connections>

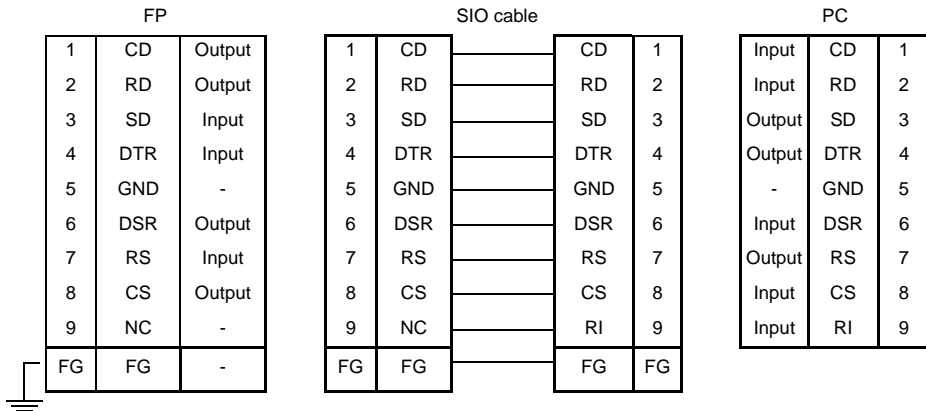

Signals and signal names used with the FP and the SIO cable (optional cable) are the same as those used for PCs. Also, the same pin is used on both sides of the optional cable so that you can connect the cable regardless of the cable direction.

Inch is used for the pitch of the connector screw on the PC. For this reason, inch (#4-40 UNC) is also used for the pitch of the connector screw for the cable and the FP.

<USB Interface Cable Pin Connections>

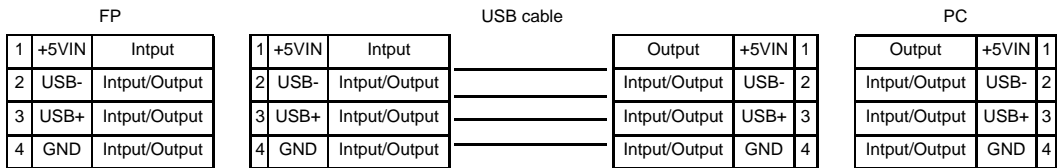

2.1.2 Maintenance Parts

Product Name	Model No.	Description
Installation Fasteners	CA3-ATFALL-01	Metal installation fasteners. (4 fasteners/set)
Installation Gasket	CA7-WPG15K-01	Replacement installation gasket, used when installing the FP. Same as the FP's original gasket.
Screen Protection Sheet	CA3-DFS15-01	Disposable and dirt resistant sheet for the FP's screen. The FP's touch panel can be used with this cover sheet attached. (5 sheets/set)
Backlight	CA7-BLU15-01	Replacement backlight (2/set)
AC Power Supply Connector (Straight)	CA7-ACCNL-01	Straight power supply connector for attaching power supply cable (5 connectors/set)

2.1.3 Related Software

- Mouse Emulation Software

IMPORTANT

- Use the latest version of the mouse emulation software whose operation has already been checked. You can find the operation-checked versions by selecting the following page in our site (<http://www.pro-face.com/>).

[FP3000 series operation-tested models]

- Visit Pro-face support site below and download the mouse emulation software.

Pro-face support site - Otasuke Pro!
<http://www.pro-face.com/otasuke/>

3



Part Names and Functions

1. FP-3710K Series

3.1 FP-3710K Series

Front

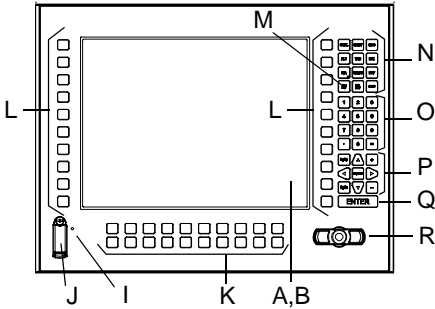

A:TFT Color LCD

The display monitor for your host unit.

B:Touch Panel

Allows you to switch screens or write data to the host.

C:Power Connector (socket)

Provides the input and ground terminals for a power cable.

D:Setting Switch

By opening the cover, the Dip switches and slide switch are seen. Each switch can set a operation mode.

SEE → 6.1 Operation Mode Setup (page6-2)

Rear

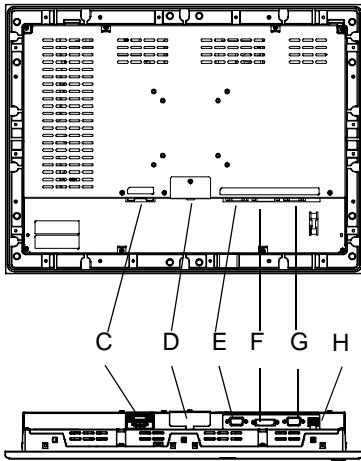

E:Analog RGB Connector

Connector for analog RGB interface

F:DVI-D Interface Connector

Connector for DVI-D interface

G: Serial Connector

Connector for Serial (RS-232C) interface. Used for sending touch panel data to between the hosts.

H:USB Connector (Type B)

Connector for USB interface. Used for sending touch panel data to the hosts, or used as an upstream port for USB-HUB.

I: Front LED

Used to indicate the condition of the power supply, a backlight burnout or image signal input.

SEE → 6.1.2 Status of Front LED in Operation Modes (page6-3)

Bottom

J: Front USB Connector (Type A)

A downstream port for embedded USB-HUB in conformity with USB2.0/1.1 standard, which is used for connecting USB devices.

The USB device can be connected.

Front

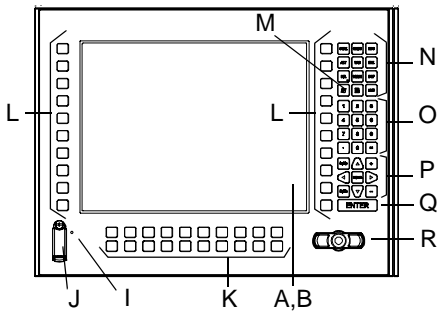

K:Function Keys

The character or the function is input.

L:Special Function Keys

The character or the special function is input.

M:F/A Key

Function/Alpha key. The function input is switched to the character input. It becomes a character input because of the LED lighting.

N:Window Keys

O:Ten Keys

P:Cursor Keys

Q:Enter Key

R:Mouse Pointer

Two button mouse.

NOTE

- It is necessary to connect an up-stream port of USB-HUB (H:USB connector) and the host to use front USB connector (J), keypad (K to Q), and mouse pointer (R).
- The keypad operates as a keyboard of the US layout.
Please confirm it is US keyboard layout when you input the character in the Alpha mode.

SEE →8.4 *Configuring the Keyboard Layout* (page8-6)

4 | Specifications

1. FP-3710K Series

This chapter describes the general, functional and interface specifications of the FP as well as its dimensions.

4.1 FP-3710K Series

4.1.1 General Specifications

■Electrical specifications

Items		Specifications
Power Supply	Rated Voltage	AC100 to 240V
	Allowable Voltage	AC85 to 264V
	Rated Frequency	50 / 60Hz
	Rated Frequency Range	40Hz to 72 Hz
	Allowable Voltage Drop	1 cycle or less (Voltage drop interval must be 1s or more)
	Current Consumption	AC 100V 1.1A or less (TYP 0.75A) AC 240V 0.7A or less (TYP 0.44A)
	In-Rush Current	60A or less
Voltage Endurance		AC1500V 20mA for 1 minute (between charging and FG terminals)
Insulation Resistance		DC500V 10M Ω or more (between charging and FG terminals)

■Environmental specifications

Items		Specifications
Physical	Surrounding Air Temperature	0°C to 50°C (The panel face should not incline more than 30°)
	Storage Temperature	-20°C to +60°C
	Ambient Operating Humidity	10%RH (Relative Humidity) to 90%RH (Wet bulb temperature: 39°C or less - no condensation.)
	Ambient storage Humidity	
	Air Purity (Dust)	0.1 mg/m ³ or less (No electrically conductive dust is allowed)
	Pollution Degree	For use in Pollution Degree 2 environment
	Corrosive gas	Free of corrosive gas
	Atomospherical pressure Resistance	800hPa to 1114hPa (Under above sea level 2000m)
Mechanical	Vibration Resistance	IEC61131-2 compliant 5Hz to 9Hz Half amplitude 3.5mm 9Hz to150Hz Constant acceleration 9.8m/s ² X, Y, Z each direction 10 cycles (100 minutes)
	Impact Resistance	IEC61131-2 compliant (147 m/s ² X, Y, Z each direction 3 times)
Electrical	Noise Immunity (via noise simulator)	Noise Voltage: 1,500Vp-p Pulse Duration: 1 μ s Rise Time: 1ns
	Electrostatic Discharge Immunity	6.0kV (EN61000-4-2 level3 compliant)
	Surge Resistance	Normal Mode: 1 kV Common Mode: 2kV (IEC61000-4-5 level3 compliant)

■ Structural specifications

Items		Specifications
Installation	Grounding	100 Ω or less, or your country's applicable standard.
	Structure	Rating ^{*1} : Equivalent to IP65f (JEM 1030)
	External Dimensions	W488mm [19.21in.] × H367mm [14.45in.] × D63mm [2.48in.]
	Weight	Approx. 8.0kg [17.6lb]
	Cooling Method	Natural air circulation

*1 The front face of the FP unit, installed in a solid panel, has been tested using conditions equivalent to the standards shown in the specification. Even though the FP unit's level of resistance is equivalent to these standards, oils that should have no effect on the FP can possibly harm the unit. This can occur in areas where either vaporized oils are present, or where low viscosity cutting oils are allowed to adhere to the unit for long periods of time. If the FP's front face protection sheet becomes peeled off, these conditions can lead to the ingress of oil into the FP and separate protection measures are suggested. Also, if non-approved oils are present, it may cause deformation or corrosion of the front panel's plastic cover. Therefore, prior to installing the FP be sure to confirm the type of conditions that will be present in the FP's operating environment.

If the installation gasket is used for a long period of time, or if the unit and its gasket are removed from the panel, the original level of the protection cannot be guaranteed. To maintain the original protection level, be sure to replace the installation gasket regularly.

4.1.2 Functional Specifications

■ Performance

Items		Specifications
Graphics		XGA (1024 × 768)
Display Unit		15 inch TFT XGA
Touch Panel I/F	Type	Resistive Film (Analog)
	Resolution	1024 × 1024
	Service Life	1,000,000 times or more
	Interface	Serial Interface (RS-232C) USB Interface (Type-B connector)
External Switch	No. of switches	74
	Switch type	Membrane switch
	Server Life	1,000,000 times or more
	Interface	USB
Video I/F		Analog RGB Interface DVI-D Interface

■ Display

Items	Specifications
Size	38cm(15 in.) (Meas. diagonally)
Type	TFT Color LCD
Resolution	1024(H) × 768(V) pixels (1pixel =R+G+B color dots)
Dot Pitch	0.297mm [0.01in.](H) × 0.297mm [0.01in.](V)
Display Colors	16,777,216 colors(R+G+B color 8 bits each)
Brightness Control*1	Available
Contrast Control	Available
Display Area	W 304.1 mm [11.97 in.] × H 228.1 mm [8.98 in.]
Display Modes*2	640×400, 640×480, 720×400, 800×600, 1024×768
Backlight	CCFL
Backlight Lifetime	Backlight is replaceable. (We offer replacement for backlights by sendback method.) 50,000 hours at an ambient temperature of 25°C*3

*1 Specified on OSD setting.

SEE → 6.2 Screen Display Adjustment (page6-4)

*2 For more information, refer to the following page.

SEE → 4.1.3 Interface Specifications (page4-5)

*3 50% decreased brightness indicates the backlight needs to be replaced. This value is only for reference and not a guaranteed value.

4.1.3 Interface Specifications

■ Analog RGB Interface

Input signal type	Analog RGB
Input signal characteristic	Image signal: analog RGB Synchronous signal: TTL level, negative polarity or positive polarity Scanning type: non-interlaced
Setting via OSD (On Screen Display)	<ul style="list-style-type: none"> • CONTRAST • H-POSITION • H-size • DIMMER (BACKLIGHT) • ALL RESET (DEFAULT) • BRIGHTNESS • V-POSITION • PHASE • SHARPNESS

◆ Display Area

The number of dots (pixels) displayed are as follows.

Size	H.Sync. (kHz)	V.Sync. (Hz)	Dot Clock (MHz)	Screen Resolution Expansion (H: Horizontal) (V: Vertical)	Display Resolution
640 × 400	24.827	56.420	21.053	× 1.6(H) × 1.92(V)	1024 × 768
640 × 400	31.469	70.000	25.175		
640 × 480	31.469	59.992	25.175	× 1.6	
640 × 480	37.500	75.000	31.500		
640 × 480	35.000	66.670	30.240		
720 × 400*1	31.469	70.000	28.320	× 1.42(H) × 1.92(V)	
800 × 600	37.879	60.317	40.000	× 1.28	
800 × 600	46.875	75.000	49.500		
1024 × 768	48.363	60.004	65.000	× 1.0	
1024 × 768	56.476	70.069	75.000		
1024 × 768	60.023	75.029	78.750		

*1 When you use this resolution, set "ON" for "720 × 400 Mode" in the OSD (On Screen Display) system settings.

◆ Analog RGB Interface Pin Assignments and Signal Names

Pin No.	Signal Name	Condition	Pin Location
1	Analog R	R signal input	
2	Analog G	G signal input	
3	Analog B	B signal input	
4	Reserved	NC (spare for input)	
5	Digital grounding	Digital signal GND	
6	Return R	R signal GND	
7	Return G	G signal GND	
8	Return B	B signal GND	
9	Reserved	NC (spare for input)	
10	Digital grounding	Digital signal GND	
11	Reserved	NC (spare for input)	
12	DDC DATA	DDC Data	
13	H. SYNC	Horizontal synchronous signal input	
14	V. SYNC	Vertical synchronous signal input	
15	DDC CLOCK	DDC Clock	

- Connector.....:Mini Dsub 15pin male
- Connector set screw:Inch type (#4-40 UNC)
- Cable.....:RGB cable manufactured by Pro-face
(FP-CV02-45 <4.5m>)

IMPORTANT • If a cable other than the specified RGB cable is used, product performance cannot be guaranteed due to the possibility of noise interfering with the FP unit's operation.

- Above-mentioned cables may not be used for computers to be connected.

For details, refer to the following page.



1.2 Cables for connecting with computer (page1-3)

■ DVI-D Interface

Input signal type	DVI-D
Setting by OSD (On Screen Display)	<ul style="list-style-type: none"> • CONTRAST • SHARPNESS • ALL RESET (DEFAULT) • BRIGHTNESS • DIMMER (BACKLIGHT)

◆ Display Area

The number of dots (pixels) displayed are as follows:

Size	H.Sync. (kHz)	V.Sync. (Hz)	Dot Clock (MHz)	Screen Resolution Expansion (H: Horizontal) (V: Vertical)	Display Resolution
640 × 400	24.827	56.420	21.053	× 1.6(H) × 1.92(V)	1024 × 768
640 × 400	31.469	70.000	25.175		
640 × 480	31.469	59.992	25.175	× 1.6	
640 × 480	37.500	75.000	31.500		
640 × 480	35.000	66.670	30.240		
720 × 400 ^{*1}	31.469	70.000	28.320	× 1.42(H) × 1.92(V)	
800 × 600	37.879	60.317	40.000	× 1.28	
800 × 600	46.875	75.000	49.500		
1024 × 768	48.363	60.004	65.000	× 1.0	
1024 × 768	56.476	70.069	75.000		
1024 × 768	60.023	75.029	78.750		

*1 When you use this resolution, set "ON" for "720 × 400 Mode" in the OSD (On Screen Display) system settings.

◆ DVI-D Interface Pin Assignments and Signal Names

Pin No.	Signal Name	Pin No.	Signal Name	Pin Location
1	TMDS DATA2-	13	NC	
2	TMDS DATA2+	14	NC	
3	TMDS DATA2 SHIELD	15	GND	
4	NC	16	Hot Plug Detect	
5	NC	17	TMDS DATA0-	
6	DDC Clock	18	TMDS DATA0+	
7	DDC Data	19	TMDS DATA0 SHIELD	
8	NC	20	NC	
9	TMDS DATA1-	21	NC	
10	TMDS DATA1+	22	TMDS CLOCK SHIELD	
11	TMDS DATA1 SHIELD	23	TMDS CLOCK+	
12	NC	24	TMDS CLOCK-	

Connector.....DVI-D 24-pin male

Connector set screwInch type (#4-40 UNC)

Cable.....DVI-D cable manufactured by Pro-face
(FP-DV01-50 <5 m>, FP-DV01-100 <10 m>)

IMPORTANT

- When the DVI-D cable by Pro-face is not used, and your own cable etc. are used, operation to the noise etc. cannot be guaranteed.
- Only when the FP-3710 K Series, PS-2000B or PL3000 Series (Revision B or more) is connected, FP-DV01-100 can be used.
- Please turn on PS-2000B's internal dipswitch 4 when use FP-DV01-100 with PS-2000B. (The resolution that can be displayed is 1024 x 768 Become only (XGA).)
Please turn off dipswitch 4 when use FP-DV01-50.
- Please set PL3000 Series internal dipswitch 5 to ● sign side when you use FP-DV01-100 with PL3000 Series.
We will recommend the resolution of PL3000 Series to change to the maximum display resolution of FP additionally.
Please set it on the opposite side of ● sign when use FP-DV01-50.
- Above-mentioned cables may not be used for computers to be connected.

For details, refer to the following page.



1.2 Cables for connecting with computer (page1-3)

■ Serial Interface

Serial Interface	Baud rate : 9600 bps
	Data length : 8 bits
	Parity : none
	Stop bit : 1
	Flow control : None

◆ RS-232C Interface Pin Assignments and Signal Names

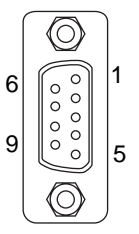
Pin No.	Signal Name	Condition	Pin Location
1	CD	Carrier Detect *1	
2	RD	Receive Data (FP->Host)	
3	SD	Send Data (FP<-Host)	
4	DTR	Data Terminal Ready*1	
5	GND	Ground	
6	DSR	Data Set Ready *1	
7	RS	Request to Send (FP<-Host)	
8	CS	Clear to Send (FP->Host)	
9	NC	(Used internally)	

*1 CD, DTR, and DSR are connected together inside of the FP.

ConnectorDsub 9 pin female

Connector set screwInch type (#4-40 UNC)

CableSIO cable manufactured by Pro-face
(FP61V-IS00-O)

NOTE

- Concerning Signal Names

Signal names used for the serial interface on FP units are designed to match the pin order used on most PC serial interfaces, so that a straight cable can be used to connect the two. Therefore, connect each pin's signal to the same signal name on the PC side.

For example, pin #2 'RD' should be connected to the 'RD' input terminal on the PC's connector.

Refer to section "2.4 Cable Diagrams" for each signal's direction.

SEE →

- Optional Cable Diagrams (page2-3)

IMPORTANT

- If a cable other than the specified RS-232C cable is used, product performance cannot be guaranteed due to the possibility of noise interfering with the FP unit's operation.

■ USB Interface (Up-stream port)

USB Interface	USB 2.0/1.1 compliant
	Supported speed <ul style="list-style-type: none"> • Low (1.5 Mbps) • Full (12 Mbps) • Hi (480 Mbps)
	Communication distance (Max): 5m
	The USB Interface is supported by a host PC equipped with Windows®2000(SP4) or later, or Windows®XP(SP1) or later.

◆ USB Interface Pin Assignments and Signal Names

Pin No.	Signal Name	Condition	Pin Location
1	USB1-5V	+5VIN	
2	USBD1(-)	USB data(-)	
3	USBD1(+)	USB data(+)	
4	GND	Ground	

Connector..... USB 2.0 / USB 1.1 compliant

Connector set screw..... Type B connector

Cable..... USB cable manufactured by Pro-face
(FP-US00)

IMPORTANT • If a cable other than the specified USB cable is used, product performance cannot be guaranteed due to the possibility of noise interfering with the FP unit's operation.

For using USB Interface, equal to or higher version of a Windows®2000(SP4) or Windows®XP(SP1) is required.

■ Front USB Interface (Down-stream port)

USB Interface	USB 2.0/1.1 compliant
	Supported speed <ul style="list-style-type: none"> • Low (1.5 Mbps) • Full (12 Mbps) • Hi (480 Mbps)
	Power supply voltage: 5 VDC \pm 5%, Output current: 500mA (max.)
	Communication distance (Max): 5m
	Connectable USB: 127* ¹
	Connection phase: 6 phases* ¹

*1 It is a number of totals seen from host PC. It is different according to the connected situation. Two USB-HUB are built into the FP. Touch panel controller is connected with one side, the keypad and the mouse pointer are connected on the other.

◆ USB Interface Pin Assignments and Signal Names

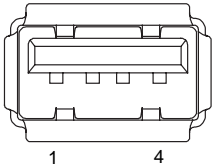
Pin No.	Signal Name	Condition	Pin Location
1	USB1-5V	+5VIN	
2	USBD1(-)	USB data(-)	
3	USBD1(+)	USB data(+)	
4	GND	Ground	

Connector: USB 2.0 / USB 1.1 compliant

Connector set screw: Type A connector

4.1.4 Dimensions

External Dimensions

Unit: mm [in.]

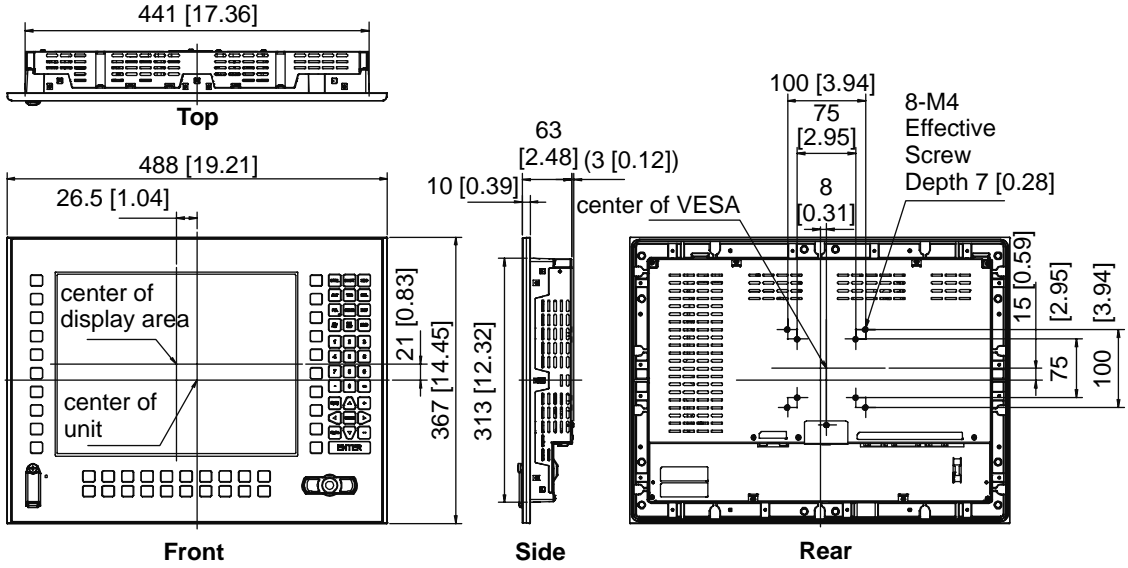

Dimensions with installation fasteners

Unit: mm [in.]

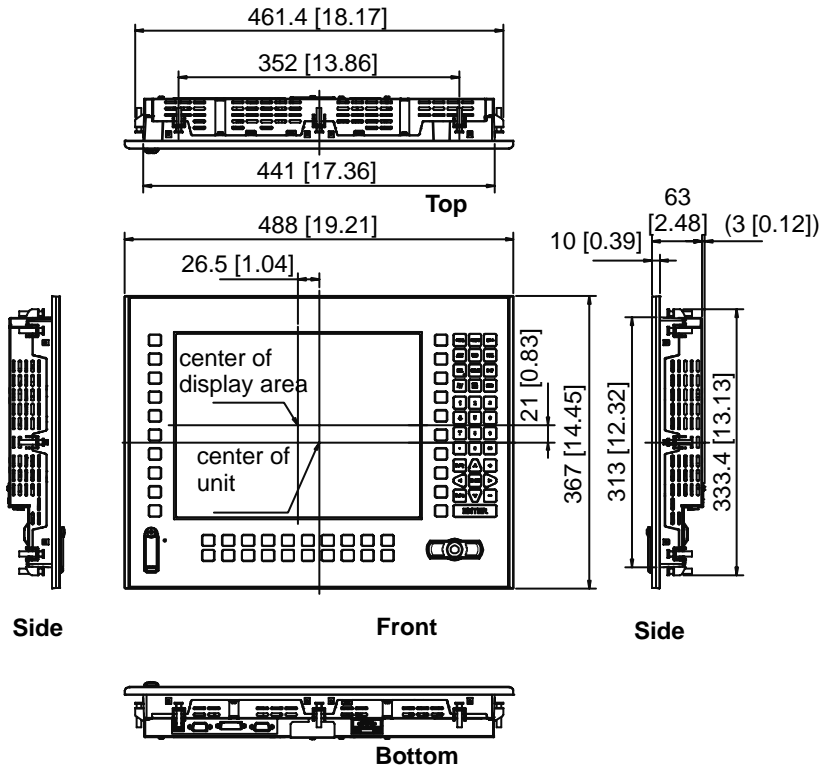

■ Dimensions with Cables

Unit: mm [in.]

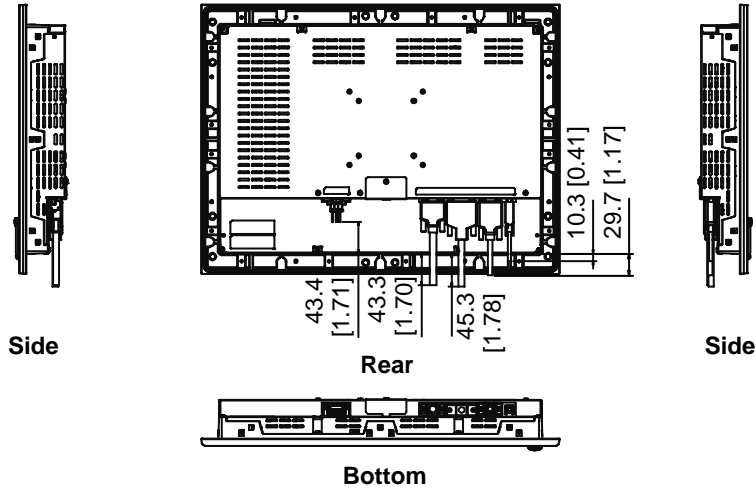

IMPORTANT

- All the above values are designed in case of cable bending. The dimensions given here are representative values depending on the type of connection cable used. Therefore, they are all intended for reference only.

■ Installation Fasteners

Unit: mm [in.]

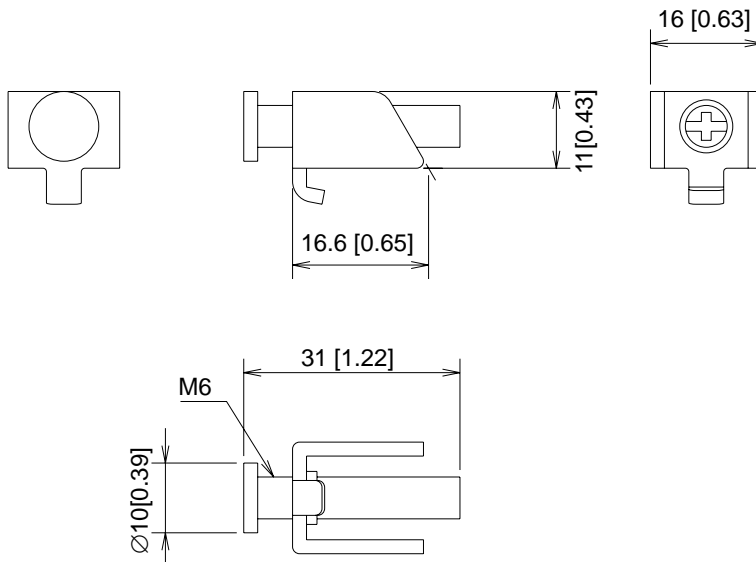

■ Panel Cut Dimensions

Unit: mm [in.]

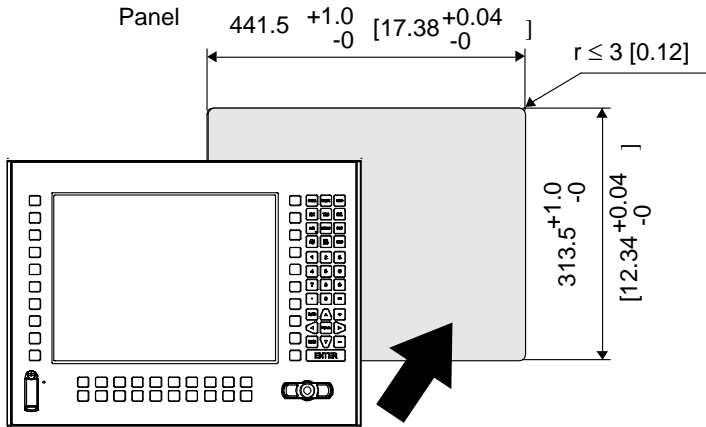

IMPORTANT

- Panel thickness should be between 1.6mm [0.06in.] and 10mm [0.39in.]. Decide the panel's thickness based on the level of panel strength required.
- Check that the installation panel or cabinet's surface is flat, in good condition and has no jagged edges.
- Create the correct sized opening required to install the FP, using the installation dimensions given.
- If desired, metal reinforcing strips can be attached to the inside of the panel, near the Panel Cut, to increase the panel's strength.

SEE →

■ *Structural specifications (page4-3)*

5



Installation and Wiring

1. Installation
2. Wiring

This chapter explains the installation method and the wiring method for the FP.

5.1 Installation

5.1.1 Installation Procedures

Follow the steps given below when installing the FP.

■ Check the Installation Gasket's Seating

It is strongly recommended that you use the installation gasket, since it absorbs vibration in addition to repelling water.

Place the FP on a level surface with the display panel facing downward. Check that the FP's installation gasket is seated securely into the gasket's groove, which runs around the perimeter of the panel's frame.

For details about installing the gasket, refer to

SEE → 10.1.2 Replacing the Installation Gasket (page 10-3)

IMPORTANT

- Before installing the FP into a cabinet or panel, check that the installation gasket is securely attached to the unit.
- A gasket which has been used for a long period of time may have scratches or dirt on it, and can lose much of its dust and drip resistance. Be sure to change the gasket periodically (or when scratches or dirt become visible).
- Be sure the gasket's seam is not inserted into any of the unit's corners, only in the straight sections of the groove. Inserting it into a corner may lead to its eventually tearing.
- To ensure the installation gasket's maximum level of moisture resistance, be sure the gasket's seam is inserted as shown into the panel's bottom face.

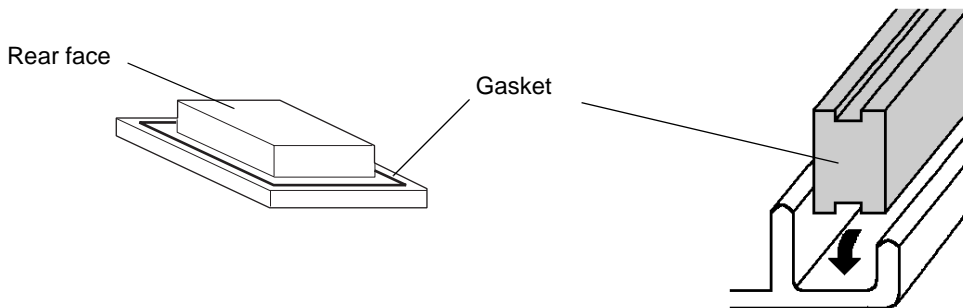

■ Creating a Panel Cut

Create the correct sized opening required to install the FP, using the installation dimensions given. The installation gasket, installation fasteners and attachment screws are all required when installing the FP. Decide the panel's thickness based on the level of panel strength required.

SEE → ■ *Panel Cut Dimensions (page4-14)*

NOTE

- Check that the installation panel or cabinet's surface is flat, in good condition and has no jagged edges. Also, if desired, metal reinforcing strips can be attached to the inside of the panel, near the Panel Cut, to increase the panel's strength.

■ Installation Requirements

- For easier maintenance, operation, and improved ventilation, be sure to install the FP at least 100 mm [3.94 in.] away from adjacent structures and other equipment.

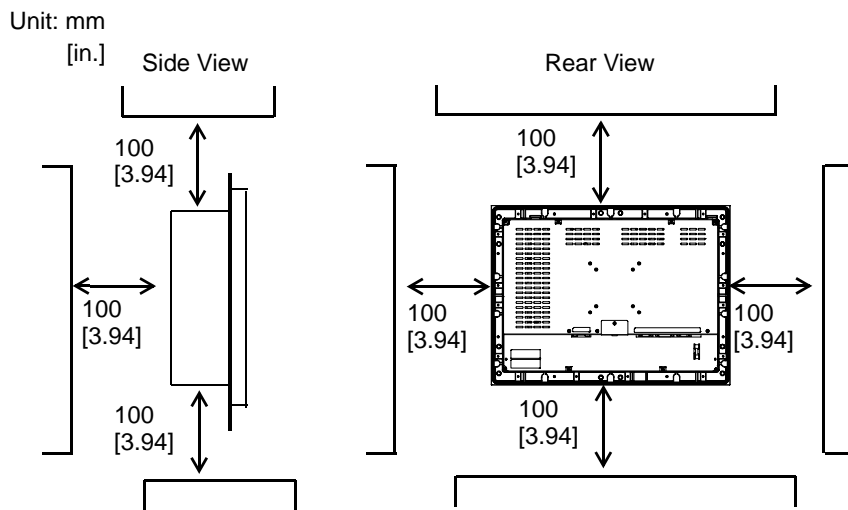

- Be sure that the ambient operating temperature and the surrounding operating humidity are within their designated ranges. (When installing the FP in a cabinet or an enclosure, “Ambient operation temperature” indicates both the panel face and cabinet or enclosure’s internal temperature.).

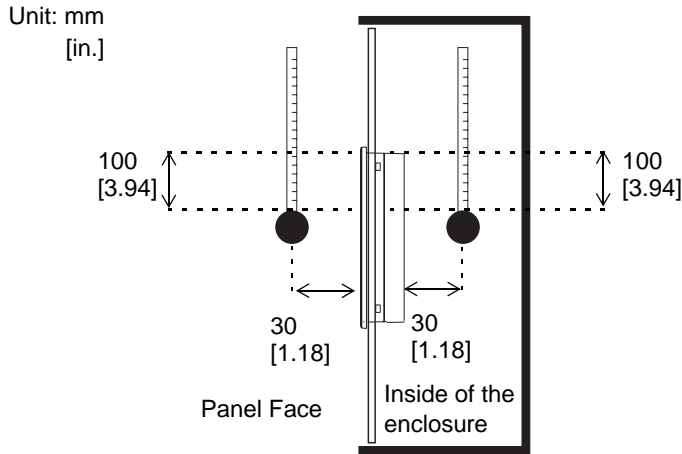

Ambient Operating Temperature: 0 to 50°C
Surrounding Operating Humidity: 10 to 90%RH

- Be sure that heat from surrounding equipment does not cause the FP to exceed its standard operating temperature.
- When installing the FP in a slanted panel, the panel face should not incline more than 30°.

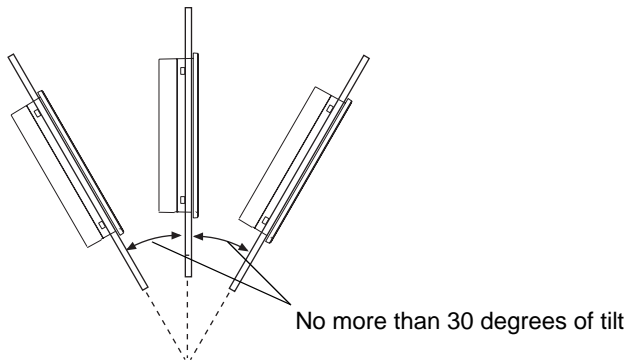

- When installing the FP in a slanted panel, and the panel face inclines more than 30°, the ambient temperature must not exceed 40 °C. You may need to use forced air cooling (fan, A/C) to ensure the ambient operating temperature is 40 °C or below.

■ Installing the FP

(1) Insert the FP into the panel cut, as shown here.

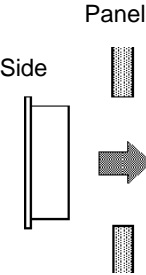
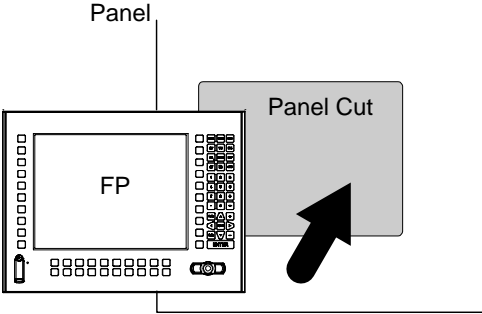

(2) Insert the installation fasteners into the FP's insertion 12 slots.

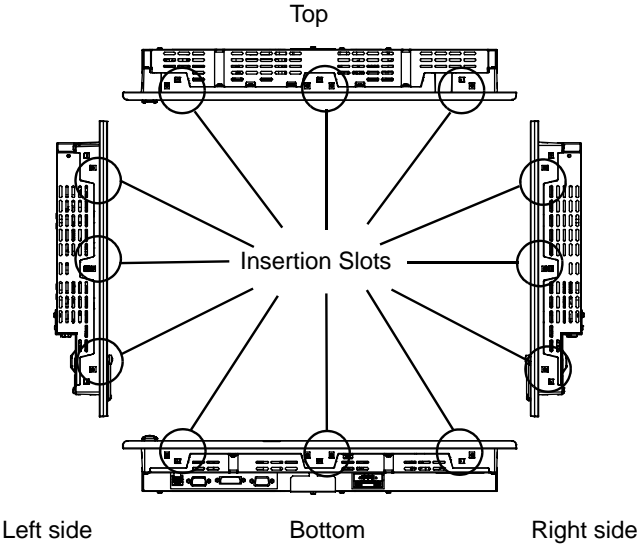

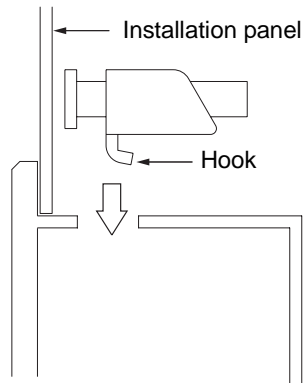

- (3) Insert each of the fasteners as shown below. Be sure to pull the fastener back until it is flush with the rear of the attachment hole.

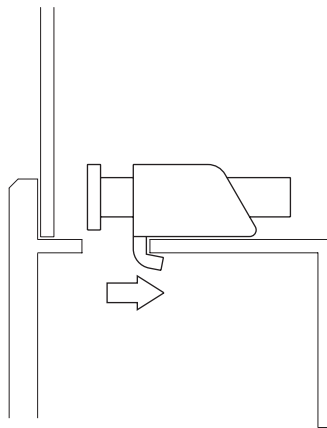

- (4) Tighten the fastener screws equally in a diagonal pattern by using a Phillips screw driver. When tightening them, slowly increase the torque. (12 places)

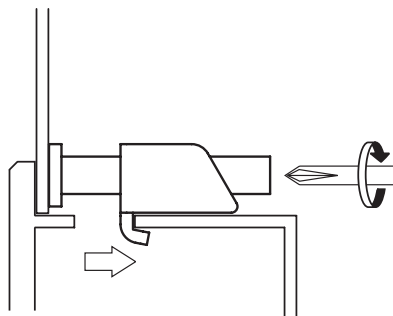

IMPORTANT • Do not use too much force, since it may damage the FP unit. A torque of only 0.8 N•m, are sufficient to tighten these screws.

5.2 Wiring

5.2.1 Connecting the Power Cord

⚠ WARNING

- ❗ To avoid an electric shock, when connecting the FP's power cord terminals to the power terminal block, confirm that the FP's power supply is completely turned OFF, via a breaker, or similar unit.
- ❗ To avoid the dangers of fire, electric hazards and equipment damage, be sure to use only the specified voltage when operating the FP.
- ❗ Since there is no power switch on the FP unit, be sure to attach a breaker-type switch to its power cord.

■ FP-3710K Series

◆ Power Cable specification

Use copper conductors only.

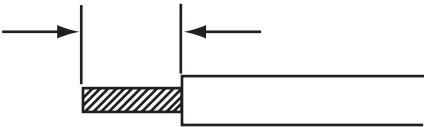
Power Cord Diameter	0.75 mm ² to 2.5 mm ² (18 AWG to 12 AWG)
Conductor Type	Simple or Twisted Wire
Conductor Length	<p style="text-align: center;">10 mm [0.39 in.]</p> 

- IMPORTANT** • If the Conductor's end (individual) wires are not twisted correctly, the end wires may either short against each other, or against an electrode.

◆ Power connector specification

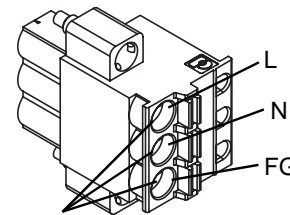
 <p>Power Cable Joint</p>	L	AC Input Terminal-live line
	N	AC Input Terminal-neutral line
	FG	Ground Terminal connected to the FP chassis

NOTE • Kind of power cord is FKC 2,5/3-STF-5,08 which are Phoenix Contact^{*1} products.

*1 Please contact Phoenix Contact for the details.

◆ Wiring

Use the following wiring for FP. Those are Phoenix Contact products.

Recommended Drivers	SZS 0.6X3.5 (1205053)
Recommended stick end terminal	AI 0.75-10GY(3201288)
	AI 1-10RD(3200182)
	AI 1.5-10BK(3200195)
	AI 2.5-12BU(3200962)
Crimp tool for recommended stick end terminal	CRIMPFOX ZA 3 (1201882)

◆ Connecting the Power Cord

When connecting the AC type power cord, be sure to follow the procedures given below.

- (1) Confirm that the power cord is unplugged from the power supply.
- (2) Push the Opening button by a small and flat screw driver to open the desired pin hole.
- (3) Insert each pin terminal into its each hole. Release the Opening button to clamp the pin place.

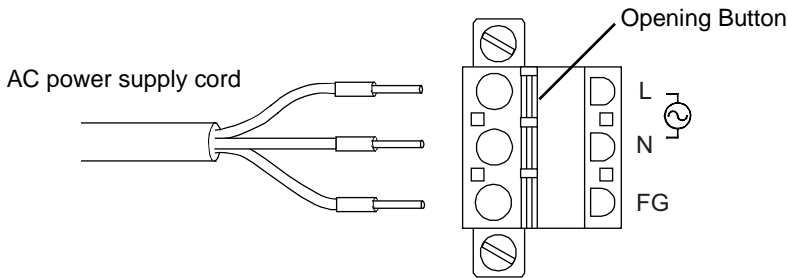

- (4) After inserting all three pins, insert the Power Plug into the Power Connector at FP. Fix the plug with two(2) minus screws.

IMPORTANT

- Confirm that all wires are connected correctly.
- The torque required to tighten these screws is 0.5 N•m - 0.6 N•m.
- To prevent the possibility of a terminal short, use a pin terminal that has an insulating sleeve.

5.2.2 The USB Cable Clamp

■ How to use the USB cable clamp

◆ USB Cable Clamp Attachment Procedure

- (1) Connect the USB cable to the connector.
- (2) Insert the cable clamp into the cable clamp holder as shown in figure 1, and tighten the clamp until the cable is secured in place.

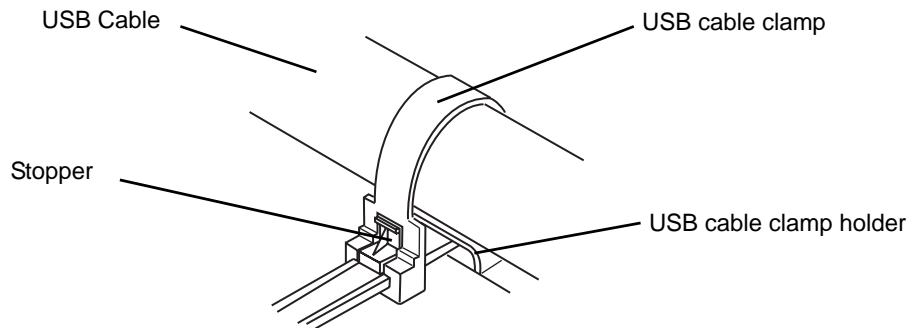
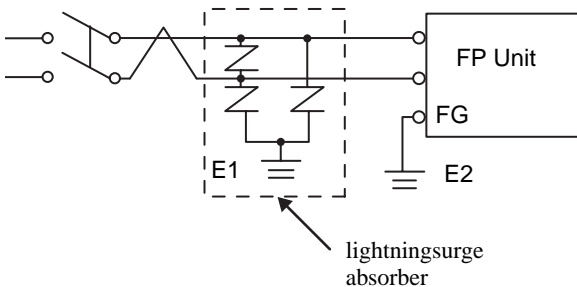
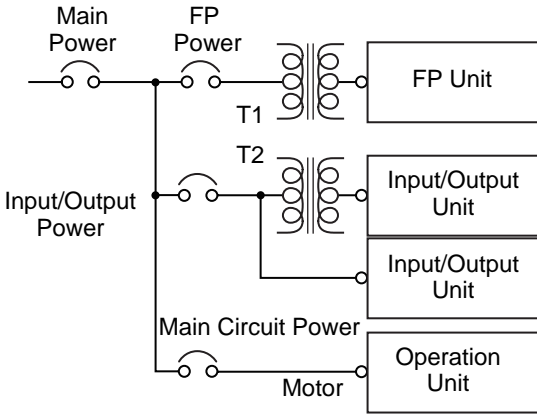
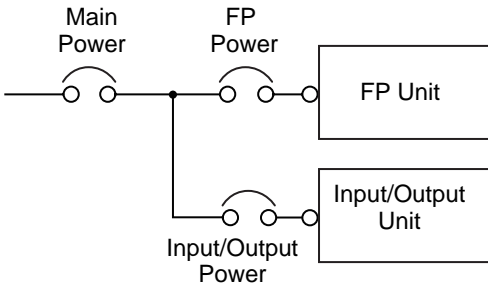
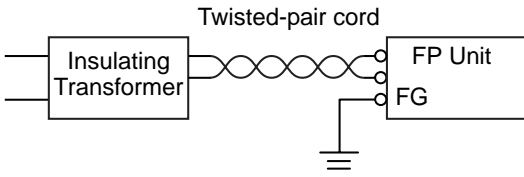
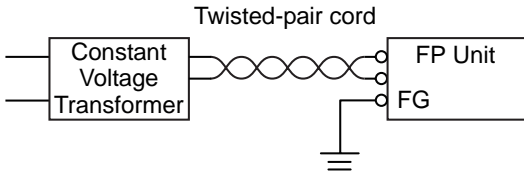

Figure 1

◆ USB Cable Clamp Removal Procedure

- (1) Push in the cable clamp's stopper until the cable clamp is unlocked, then remove the clamp.
- (2) Disconnect the USB cable.

5.2.3 Connecting the Power Supply



- If the power supply voltage exceeds the FP unit’s specified range, connect a constant voltage transformer.

SEE → 4 Specifications (page4-1)

- For between the line and ground or between the lines, select a power supply that is low in noise. If there is an excess amount of noise, connect an insulating transformer.

IMPORTANT • Use the constant voltage transformer and the insulating transformer with capacities of the rated value or more.

- When supplying power to the FP unit, please separate the input/output and operation unit lines, as shown.
- To increase the noise resistance quality of the power cable, simply twist each power wire before attaching the Ring Terminal.
- The power supply cable must not be bundled or positioned close to main circuit lines (high voltage, high current), or input/output signal lines.
- Connect a lightning surge absorber, as shown in the diagram, to deal with power surges.
- To avoid excess noise, make the power cable as short as possible.
- The temperature rating of field installed conductors: 75°C only.

IMPORTANT • Be sure to ground the surge absorber (E1) separately from the FP unit (E2).

- Select a surge absorber that has a maximum circuit voltage greater than the power supply’s peak voltage.

5.2.4 Precautions: Grounding

(a) Exclusive grounding (BEST)

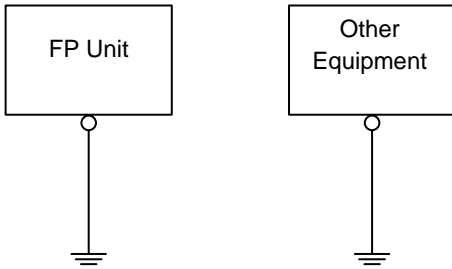

- Connect the FP's FG terminal to an exclusive ground. [diagram (a) - Grounding resistance of under 100Ω]

(b) Common grounding (OK)

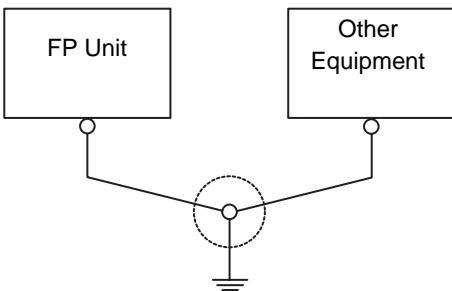

- If exclusive grounding is not possible, use a common connection point. [diagram (b)]
- The grounding wire should have a cross sectional area greater than 2mm^2 . Make the connection point as close to the FP unit as possible, and make the wire as short as possible. When using a long grounding wire, replace the thin wire with a thicker wire placed in a duct.

(c) Common grounding (BAD)

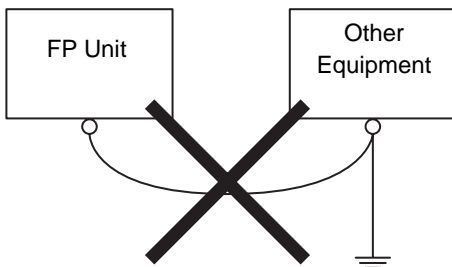

- If this equipment does not function properly when grounded, disconnect the ground wire from the FG terminal.

5.2.5 Precautions: Input/Output Signal Lines

- Input and output signal lines must be separated from operating circuit power cables.
- If this is not possible, use a shielded cable and connect the shield to the FP chassis.

6

Setting up and Adjusting the FP unit

1. Operation Mode Setup
2. Screen Display Adjustment

This chapter describes the settings of the operation mode and the OSD.

6.1 Operation Mode Setup

6.1.1 Preset Settings and Adjustments for Dip Switch and Slide Switch

The Dip Switches and Slide Switch are located in the bottom of the FP unit.

Loosen the screws of the cover with a Phillips head screwdriver and then remove the cover. After setting the dip switches and slide switches, reinstall the cover and screws with the screwdriver. The tightening torque for those screws is 0.5 to 0.6 N•m.

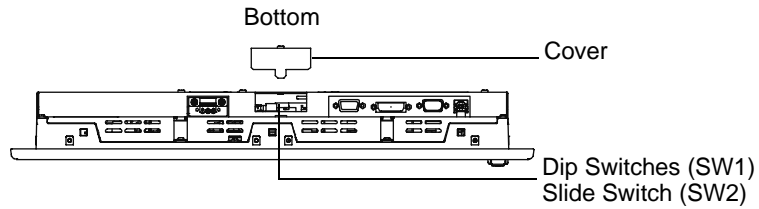

The factory default for the FP unit's Dip Switches and Slide Switch are as follows.

- IMPORTANT** • Only the settings when the power supply is turned on is effective to the Dip Switches and the Slide Switch. After changing the settings of the Dip Switches and the Slide Switch, be sure to restart your FP unit.

■SW1

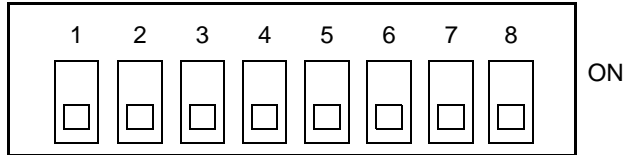

SW1-1	Reserved (Always OFF)
SW1-2	Display/Hide the OSD
SW1-3	Reserved (Always OFF)
SW1-4	Reserved (Always OFF)
SW1-5	Reserved (Always OFF)
SW1-6	Reserved (Always OFF)
SW1-7	Reserved (Always OFF)
SW1-8	Reserved (Always OFF)

- SW1-2

Dip Switch SW1-2 is used to display or hide the OSD.

To hide the OSD, set the switch to ON. To display the OSD, set the switch to OFF.

The default setting is OFF. (OSD is displayed.)

■SW2

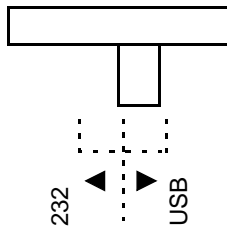

- Slide Switch is used to switch the data input/output (command control) method on the touch panel between USB and RS-232C.

The default setting is USB.

6.1.2 Status of Front LED in Operation Modes

LED	OFF	Green	Orange	Green/Red Flash	Orange Flash ^{*1}
Panel	Power OFF	Power ON	Power ON	Power ON	Power ON
Backlight	-	Normal	Normal	Burned-out	Burned-out
Input of Image	-	Yes	No	Yes	No

*1 Only while "No signal" is displayed.

6.2 Screen Display Adjustment

6.2.1 Calibration of OSD Display Position

You can operate the FP screen menus via the touch panel, and adjust screen image display to a minute level.

The feature is called OSD (On Screen Display).

This section describes items and functions that can be set with OSD.

(1) How to start the OSD

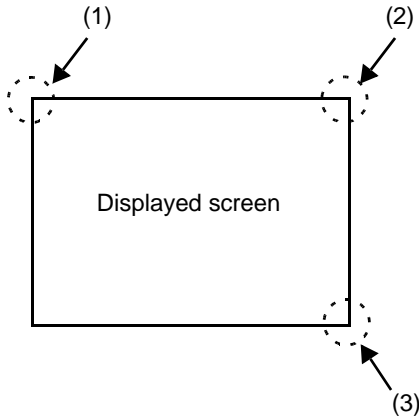

■ Starting the OSD

To start the OSD and enter OSD mode, press the three corners of the touch panel in the following order (upper left (1) a upper right (2) a lower right (3)) within 5 seconds. In OSD mode, the setting screen is displayed in the center of the screen. In this mode, the touch panel cannot be used to export data to external devices unless the settings for the OSD are completed.

NOTE

- OSD is not displayed when there is no input image.
- OSD is not displayed when a SW 1-2 is ON.

(2) Main Menu

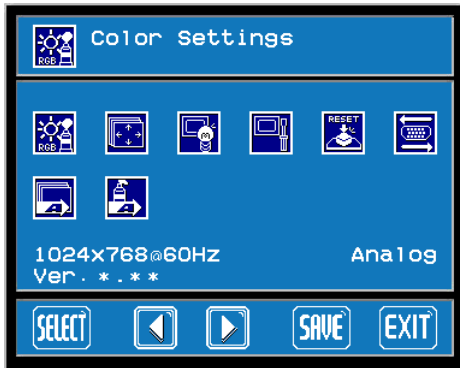



“Ver. *.*” indicates the version of the OSD.

■ Using the OSD

Icons on the screen are used to operate the OSD.

When you start up the OSD, the top menu displays.

Touching the icon of the item you want to adjust displays its submenu or setting change screen. In the

setting change screen,   icons are used to change the setting. To set the setting, press the

 button. Press the  button to save the defined settings.

■ Quitting the OSD

To quit the OSD, press the  or  button

in the top menu or leave the OSD as it is for at least 30 seconds.















IMPORTANT

- In the OSD, pressing the  button applies the set value and enables the setting. The set value won't be canceled unless the power is turned OFF or the value is reset.

If the power is turned OFF without saving the set value, that data will disappear. The last saved data will be read into the system when the FP starts. To enable the changed value, be sure to press the .

- All the setting values, even though in process of the OSD settings, will be retained in condition of letting the OSD leave more than 30 seconds or by pressing the  button. The OSD will keep those values and make them effective until power-off or a Reset command input.

6.2.2 OSD Setting Icons

Item		Function
	Color Settings	Adjusts the contrast and the brightness.
	Screen Settings	Adjusts the display position of the screen.
	Custom Display	Adjusts Sharpness and the backlight brightness.
	System Settings	Changes settings such as activating the click sound.
	All Reset	Resets the current OSD value to the default value.
	Input Source	Switches Analog RGB and DVI-D.
	Auto Adjust	Automatically adjusts the display position of the screen. (Analog RGB only)
	Auto Gain	Automatically adjusts the contrast and the brightness. (Analog RGB only)
	ESC	Cancels the setting and returns to the upper level.
	SET	Applies the setting and returns to the upper level.
	Arrow KEY	Changes the selection.
	SELECT	Selects icons or items.
	SAVE	Saves the current value and quits the OSD.
	EXIT	Quits the OSD.

6.2.3 OSD Setting Item Details

■ Main Menu

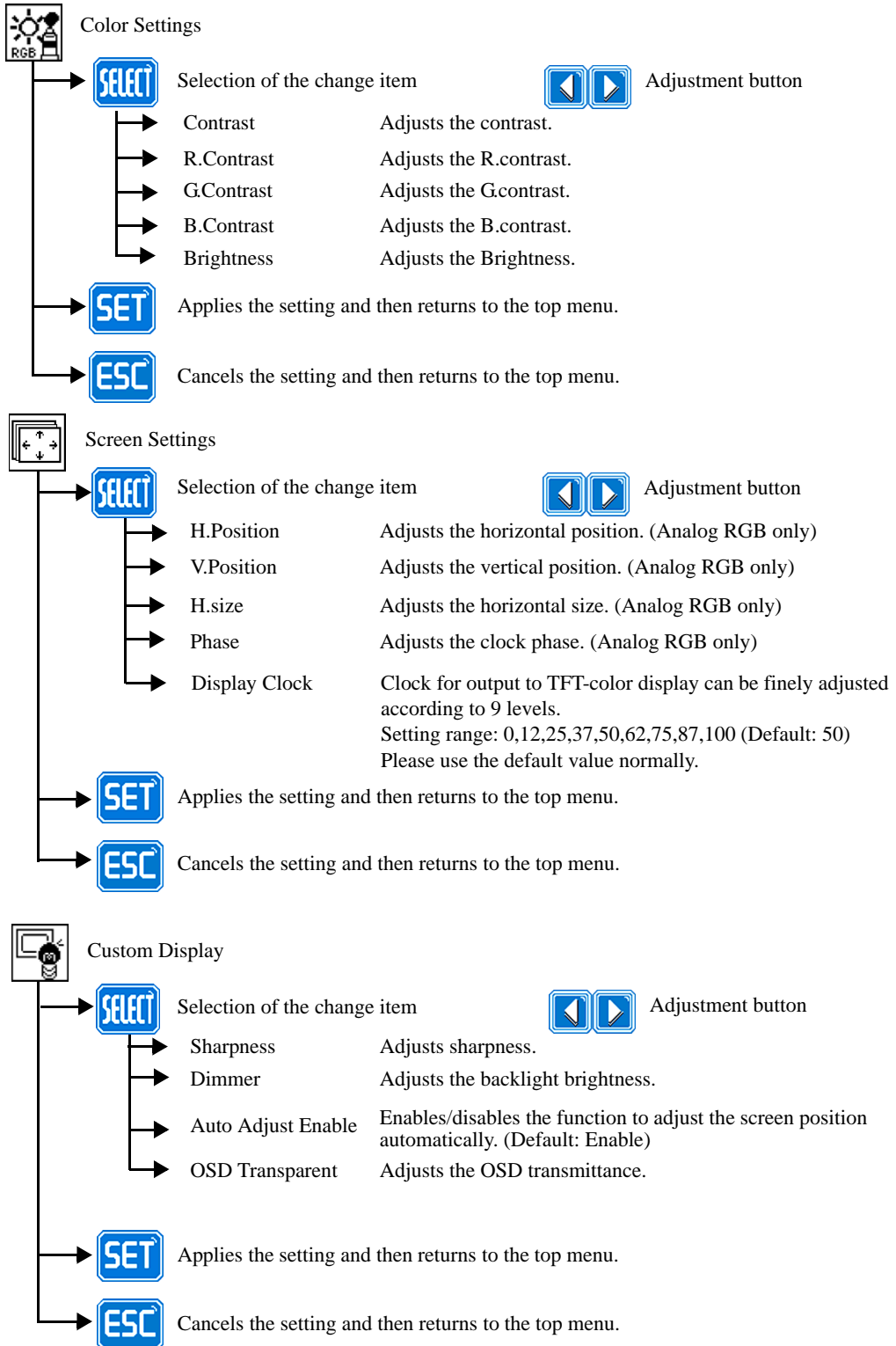

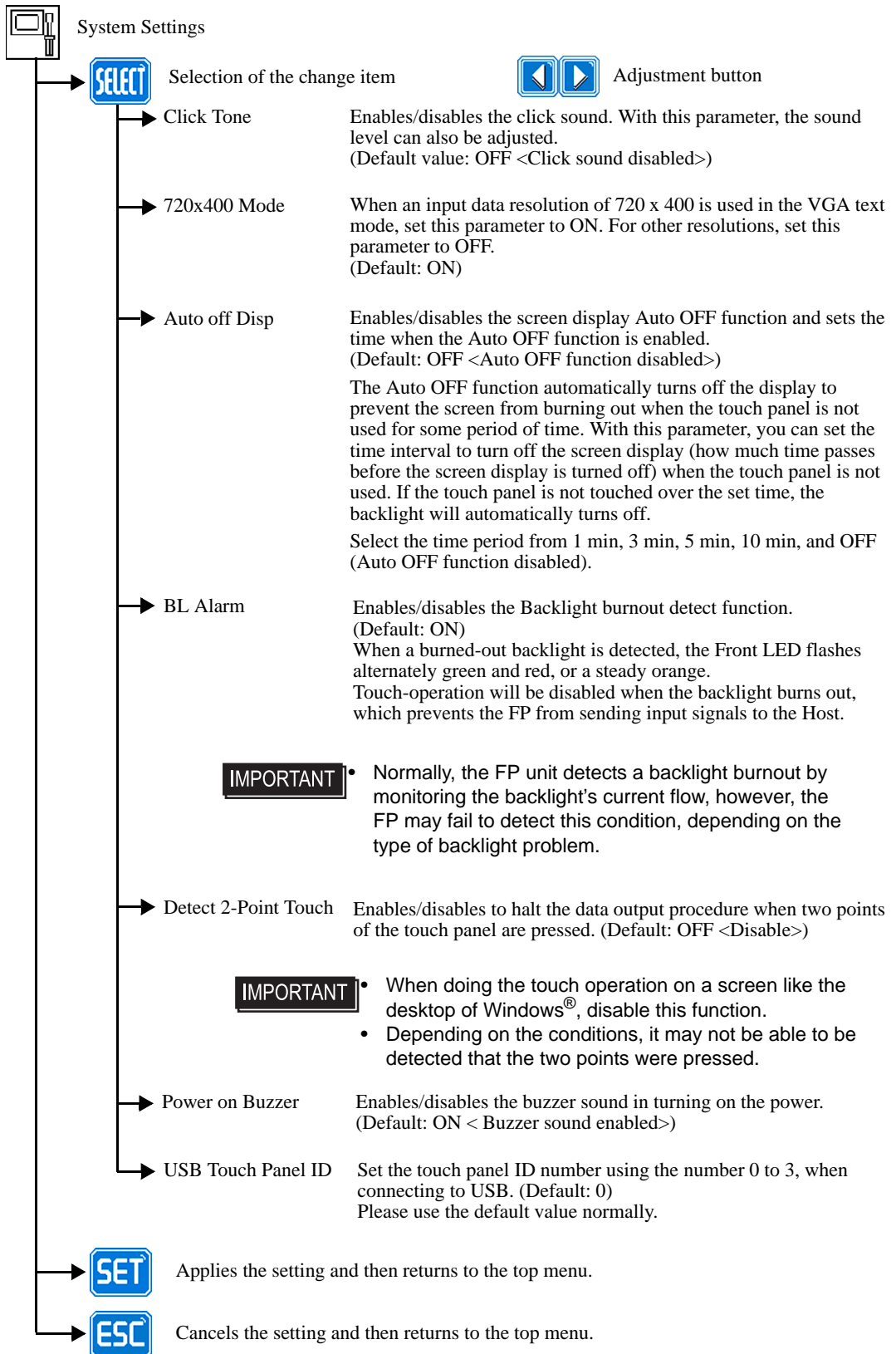

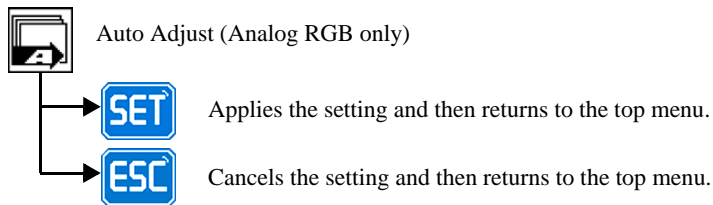
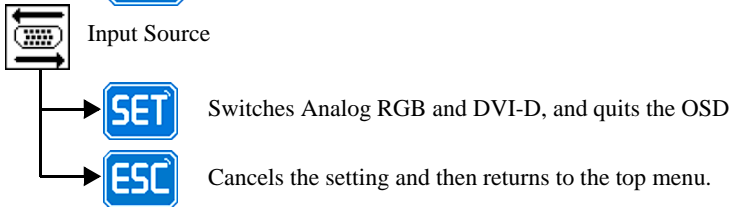
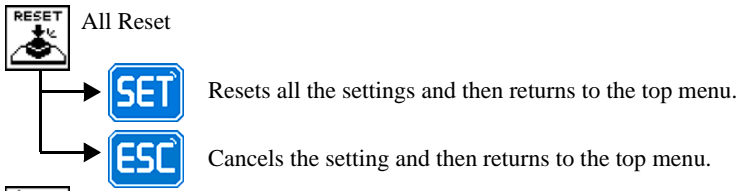

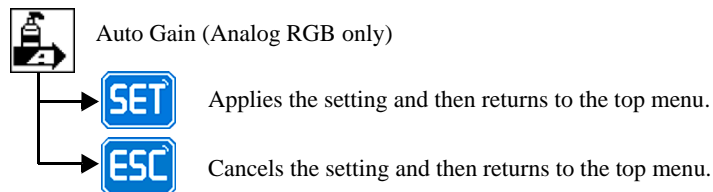

IMPORTANT • Be sure to perform the auto adjust while things except the black are displayed on the edge of the screen.



IMPORTANT • Be sure to perform the auto gain control when the screen has both 100% black and 100% white areas displayed.

 Icon decision

 Icon selection

 Saves the setting and quits the OSD. Saves all the adjusted settings in the EEPROM.

 End of OSD

7 | Touch Panel Data

1. Touch Interface Data

This chapter describes the outline of the software to input the touch panel data to the host computer.

7.1 Touch Interface Data

The FP-3710K Series units use an analog type touch panel. This touch panel needs a calibration program to adjust the actual touch position.

The display resolutions is 1024×768 .

The screen display origin point is at the upper left corner of the screen. Therefore, a mouse emulation software to convert the touch coordinates to display coordinates is needed.

IMPORTANT • For details on the mouse emulation software, refer to "Related Software".

SEE → 2.1.3 Related Software (page2-6)

■ Touch Panel Coordinate Data

(1) Resolution

Both the X and Y coordinates have a resolution of 1024.

The origin point (0,0) is located in the upper left corner of the screen.

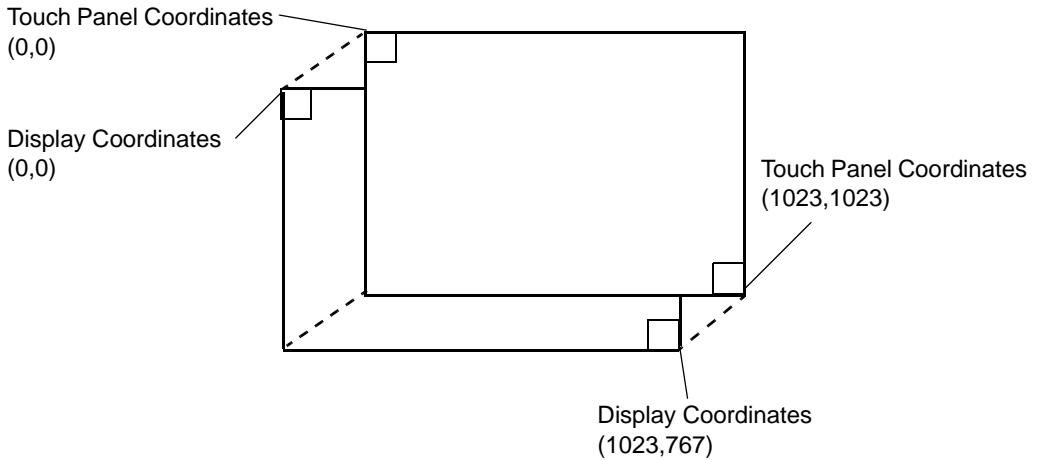

(2) Data Format

Touch Panel coordinate data is sent to the host using the following format.

All data is in binary format.

Header: 1 byte (11h= touched; 10h = released)

X coordinate: 2 bytes (0 to 3FFh)

Y coordinate: 2 bytes (0 to 3FFh)

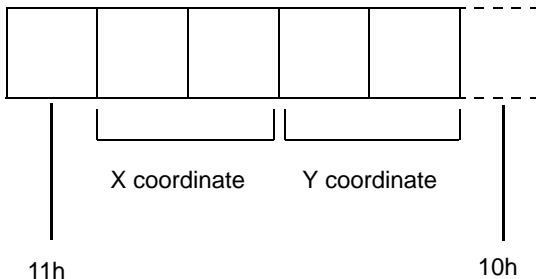

Added when touch is released.

<Example>

If the coordinate (X=23(11h), Y=500(1F4h)) is touched and moved to the coordinate (X=63(3Fh), Y=250(FAh)).

11h 0h 17h 1h F4h	touched
11h 0h 17h 1h F4h	continuous output with the same location
11h 0h 18h 1h F5h	moving without releasing touch
:	:
:	:
:	:
:	:
:	:
11h 0h 3Fh 1h FAh	continuous data output unless finger is released
11h 0h 3Fh 1h FAh 10h	when released, only 1 unit of data is sent

8

Keyboard Operation

1. About KeyPad Module
2. Features of KPM
3. Scan Code List
4. Configuring the Keyboard Layout
5. Restrictions

This chapter describes the features of KeyPad Module, which is included with the FP-3710K Series.

8.1 About Keypad Module

Keypad Module (hereafter referred to as "KPM") is a keyboard module that is included with the FP-3710K Series. You can operate the panels using the keypad and mouse pointer in the front panel of KPM.

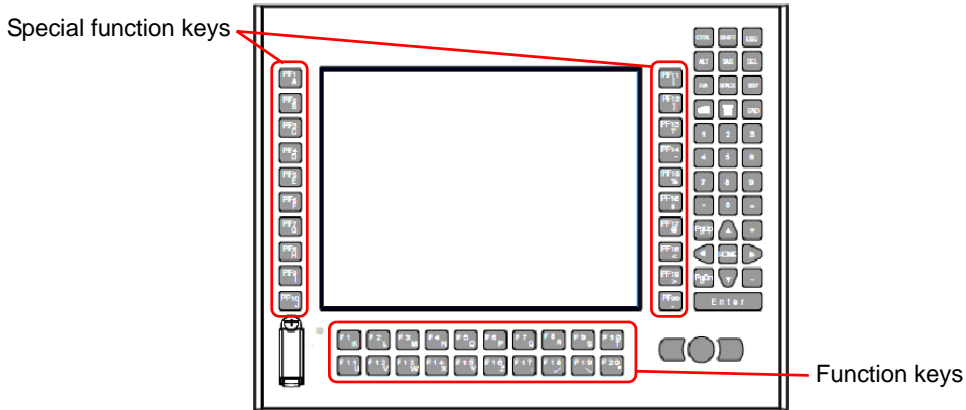

Using KPM, you can input text and operate shortcuts (key codes assigned to each application) in user applications running on Host.

NOTE

- For details about each component of KPM and its function, refer to the following section.

SEE → 3.1 FP-3710K Series (page 3-2)

- KPM will operate normally with US keyboard layout. When inputting another language, change to the keyboard layout of that language. Furthermore, the pre-installed OS features multi-language keyboard layouts, the US layout is set as the default.

For details about configuring the keyboard layout, refer to the following section.

SEE → 8.4 Configuring the Keyboard Layout (page 8-6)

- For details about each key's key code, refer to the following section.

SEE → 8.3 Scan Code List (page 8-4)

- In Windows® Device Manager, KPM is recognized as a USB 2.0 device because the device is being connected via a USB hub. However, this will not affect performance.

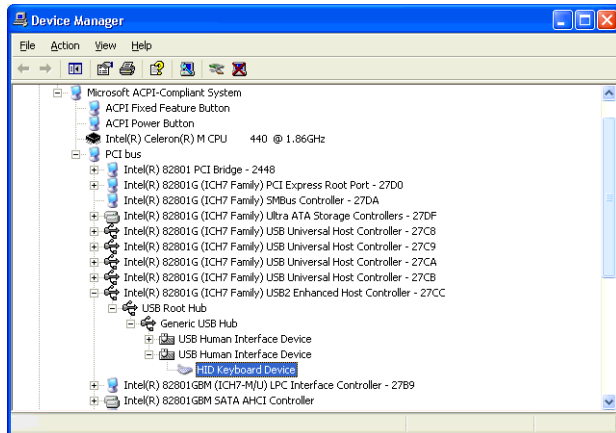

8.2 Features of KPM

KPM has function keys (F1/K to F20/*) and special function keys (PF1/A to PF20/~). These are used not only for text input but also as shortcut keys for applications. They can be used as shortcut keys by assigning key codes to each key in user applications.

■ Features of function keys and special function keys (About input mode)

In the input mode for function keys and special function keys, each has a Function mode and Alpha mode.

You can switch between input modes by pressing the [F/A] key. Switch the mode based on the task.

Function mode : Keys assigned in a user application

Alpha mode : Text/symbol input

NOTE

- You can check the mode by seeing whether the LED on the [F/A] key is on or off.

For details about how to switch modes, refer to the following section.

SEE → *n Switching between Function mode and Alpha mode (page 8-3)*

- Each key except for the [F/A] key can have key codes assigned to it for an application. Assign the key code based on the task. For details about key codes that can be assigned in applications, refer to the following section.

SEE → *8.3 Scan Code List (page 8-4)*

■ Switching between Function mode and Alpha mode

Use the [F/A] key to switch between input modes. Based on this, the function keys and special function keys will switch between Function mode and Alpha mode.

NOTE

- You can check the input mode by seeing whether the LED on the [F/A] key is on or off.

LED off: Function mode

LED on: Alpha mode

■ Function key and special function key output by mode

	Key	Function mode	Alpha mode		Key	Function mode	Alpha mode
Function keys	F1/K	F1	K	Special function keys	PF1/A	F21	A
	F2/L	F2	L		PF2/B	F22	B
	F3/M	F3	M		PF3/C	F23	C
	F4/N	F4	N		PF4/D	F24	D
	F5/O	F5	O		PF5/E	F25	E
	F6/P	F6	P		PF6/F	F26	F
	F7/Q	F7	Q		PF7/G	F27	G
	F8/R	F8	R		PF8/H	F28	H
	F9/S	F9	S		PF9/I	F29	I
	F10/T	F10	T		PF10/J	F30	J
	F11/U	F11	U		PF11/(F31	(
	F12/V	F12	V		PF12/)	F32)
	F13/W	F13	W		PF13/?	F33	?
	F14/X	F14	X		PF14/^	F34	^
	F15/Y	F15	Y		PF15/%	F35	%
	F16/Z	F16	Z		PF16/\$	F36	\$
	F17/:	F17	:		PF17/@	F37	@
	F18//	F18	/		PF18/<	F38	<
	F19/\	F19	\		PF19/>	F39	>
	F20/*	F20	*		PF20/~	F40	~

8.3 Scan Code List

You can use shortcuts by assigning key codes to each key in user applications.

Each key except for the [F/A] key can have key codes assigned to it for an application. Assign the key code based on the task.

■ Function keys/Special function keys (Function mode)

In Function mode, each function key and special function key can be assigned a function from F1 to F40.

(Refer to the following table.) Assign the key code to the application based on the task.

Function mode									
	Key label	Function	Make code	Break code		Key label	Function	Make code	Break code
Function keys	F1/K	F1	3B	BB	Special function keys	PF1/A	F21	1D 3B	9D BB
	F2/L	F2	3C	BC		PF2/B	F22	1D 3C	9D BC
	F3/M	F3	3D	BD		PF3/C	F23	1D 3D	9D BD
	F4/N	F4	3E	BE		PF4/D	F24	1D 3E	9D BE
	F5/O	F5	3F	BF		PF5/E	F25	1D 3F	9D BF
	F6/P	F6	40	C0		PF6/F	F26	1D 40	9D C0
	F7/Q	F7	41	C1		PF7/G	F27	1D 41	9D C1
	F8/R	F8	42	C2		PF8/H	F28	1D 42	9D C2
	F9/S	F9	43	C3		PF9/I	F29	1D 43	9D C3
	F10/T	F10	44	C4		PF10/J	F30	1D 44	9D C4
	F11/U	F11	2A 3B	AA BB		PF11/(F31	38 3B	B8 BB
	F12/V	F12	2A 3C	AA BC		PF12/)	F32	38 3C	B8 BC
	F13/W	F13	2A 3D	AA BD		PF13/?	F33	38 3D	B8 BD
	F14/X	F14	2A 3E	AA BE		PF14/^	F34	38 3E	B8 BE
	F15/Y	F15	2A 3F	AA BF		PF15/%	F35	38 3F	B8 BF
	F16/Z	F16	2A 40	AA C0		PF16/\$	F36	38 40	B8 C0
	F17/:	F17	2A 41	AA C1		PF17/@	F37	38 41	B8 C1
	F18//	F18	2A 42	AA C2		PF18/<	F38	38 42	B8 C2
	F19/\	F19	2A 43	AA C3		PF19/>	F39	38 43	B8 C3
	F20/*	F20	2A 44	AA C4		PF20/~	F40	38 44	B8 C4

NOTE • When entering keys using a commercially available USB keyboard, you can combine F1 to F10, Shift, Ctrl, and Alt to enter the same commands as F11 to F40 on KPM. For details about the key combinations and the key function that is output, refer to the following section.

SEE → *n Key combinations and key functions in Function mode (page 8-12)*

IMPORTANT • F11/F12 on commercially available USB keyboards and KPM differ. When you press F11/F12 in KPM, the result is the same as pressing Shift+F1/Shift+F2.

• In Function mode, when PF14/^ is pressed, the code for Alt+F4 on a commercially available USB keyboard is output. The applications starting on the host end because this code corresponds to the exit code of the Windows application.

• For details about function key/special function key operations, refer to the following section.

SEE → *n Key combinations and key functions in Function mode (page 8-12)*

■ Function keys/Special function keys (Alpha mode)

In Alpha mode, each function key and special function key can be assigned a character from A to Z and symbols. (Refer to the following table.)

Assign the key code to the application based on the task.

Alpha mode									
	Key label	Function	Make code	Break code		Key label	Function	Make code	Break code
Special function keys	PF1/A	A	1E	9E	Function keys	F1/K	K	25	A5
	PF2/B	B	30	B0		F2/L	L	26	A6
	PF3/C	C	2E	AE		F3/M	M	32	B2
	PF4/D	D	20	A0		F4/N	N	31	B1
	PF5/E	E	12	92		F5/O	O	18	98
	PF6/F	F	21	A1		F6/P	P	19	99
	PF7/G	G	22	A2		F7/Q	Q	10	90
	PF8/H	H	23	A3		F8/R	R	13	93
	PF9/I	I	17	97		F9/S	S	1F	9F
	PF10/J	J	24	A4		F10/T	T	14	94
	PF11/((2A 0A	AA 8A		F11/U	U	16	96
	PF12/))	2A 0B	AA 8B		F12/V	V	2F	AF
	PF13/?	?	2A 35	AA B5		F13/W	W	11	91
	PF14/^	^	2A 07	AA 87		F14/X	X	2D	AD
	PF15/%	%	2A 06	AA 86		F15/Y	Y	15	95
	PF16/\$	\$	2A 05	AA 85		F16/Z	Z	2C	AC
	PF17/@	@	2A 03	AA 83		F17/:	:	2A 27	AA A7
	PF18/<	<	2A 33	AA B3		F18//	/	35	B5
	PF19/>	>	2A 34	AA B4		F19/\	\	2B	AB
	PF20/~	~	2A 29	AA A9		F20/*	*	2A 09	AA 89

■ Keys other than the function keys/special function keys

You can assign to the application a key code to keys other than the function keys and special function keys.

(Refer to the following table.) Assign the key code to the application based on the task.

Function mode/Alpha mode							
Key label	Function	Make code	Break code	Key label	Function	Make code	Break code
CTRL	CTRL	1D	9D	7	7	08	88
SHIFT	SHIFT	2A	AA	8	8	09	89
ESC	ESC	01	81	9	9	0A	8A
ALT	ALT	38	B8	.	.	34	B4
TAB	TAB	0F	8F	0	0	0B	8B
DEL	DEL	E0 2A E0 53	E0 D3 E0 AA	=	=	0D	8D
F/A	--	--	--	PgUp	PgUp	E0 2A E0 49	E0 C9 E0 AA
SPACE	SPACE	39	B9	↑	↑	E0 2A E0 48	E0 C8 E0 AA
BSP	BACKSPACE	0E	8E	+	+	4E	CE
Windows	Windows Start menu	E0 2A E0 5B	E0 DB E0 AA	←	←	E0 2A E0 4B	E0 CB E0 AA
Application	Windows pop-up menu	E0 2A E0 5D	E0 DD E0 AA	HOME	HOME	E0 2A E0 47	E0 C7 E0 AA
END	END	E0 2A E0 4F	E0 CF E0 AA	→	→	E0 2A E0 4D	E0 CD E0 AA
1	1	02	82	PgDn	PgDn	E0 2A E0 51	E0 D1 E0 AA
2	2	03	83	↓	↓	E0 2A E0 50	E0 D0 E0 AA
3	3	04	84	-	-	4A	CA
4	4	05	85	ENTER	ENTER	1C	9C
5	5	06	86				
6	6	07	87				

NOTE

- Note that you cannot assign a key code to the [F/A] key.

8.4 Configuring the Keyboard Layout

KPM is configured so that it will operate normally with US keyboard layout. When inputting text in Alpha mode, make sure that the keyboard layout is set to US. For the procedure to configure the keyboard layout, refer to the following.

IMPORTANT

- Immediately after the Japanese language version of Windows® (preinstalled or otherwise) is installed, the keyboard layout is set to Japanese.

NOTE

- When the keyboard layout is set to the desired language, text input from KPM in that language is possible. However, some keyboard labels and key codes will differ.
KPM will operate normally only with a US keyboard layout.
- Operation has been tested on Windows® XP/XP Embedded and Windows® 2000.

■ Configuring keyboard layout in Windows® XP

- (1) Select [Control Panel] and then [Date, Time, Language and Regional Options].
Start [Regional and Language Options].

NOTE

- By default, the view setting for [Control Panel] is [Category View].
If the setting is [Classic View], select [Regional and Language Options].

- (2) Select the [Language] tab, then [Text services and input languages], and then [Details].

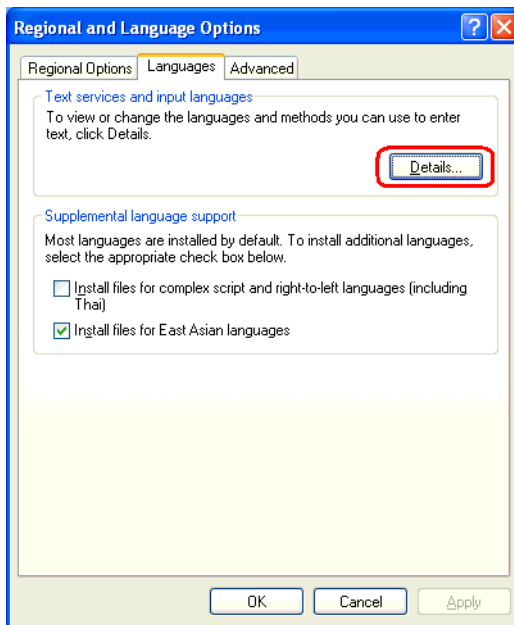

- (3) When the [Text Services and Input Languages] dialog box appears, select [Add] in [Installed services].

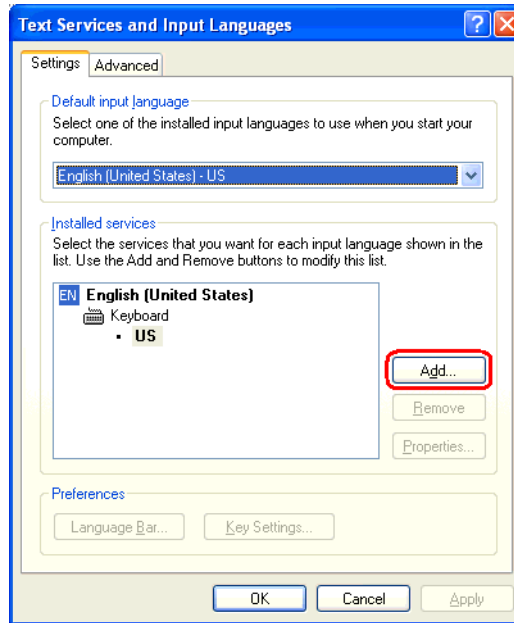

- (4) The [Add input language] dialog box appears. Select the desired language from the [Input language] combo box.

In [Keyboard layout/IME], select the keyboard layout of the keyboard to be attached and click [OK].

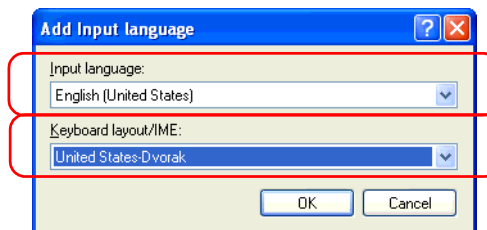

- (5) When the [Text Services and Input Languages] dialog box appears again, select the language from [Default input language]. Next, click [Apply] and then [OK]. Using this setting the selected language will be set as the default language.

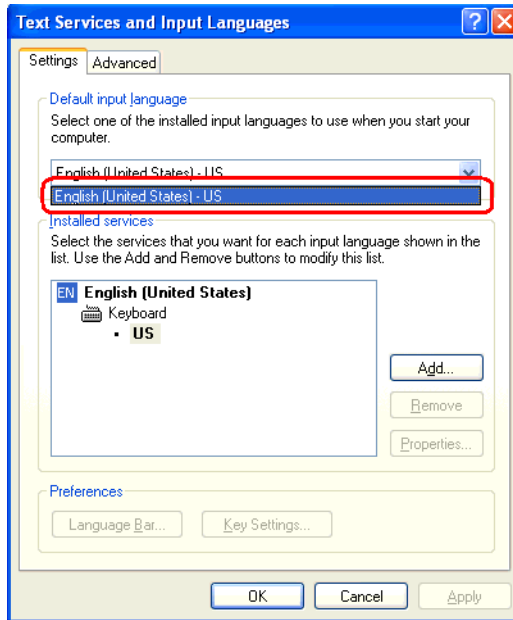

■ Configuring keyboard layout in Windows® 2000

- (1) Select [Control Panel] and then [Regional Options].
- (2) In the [Input Locales] tab, click [Add] in [Switch between input locales].

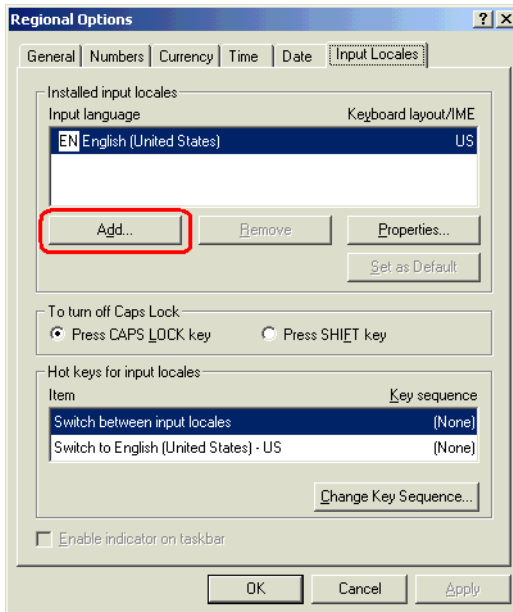

- (3) The [Add Input Locale] dialog box appears. Select a language from [Input locale]. In [Keyboard layout/IME], select the keyboard layout of the keyboard to be attached and click [OK].

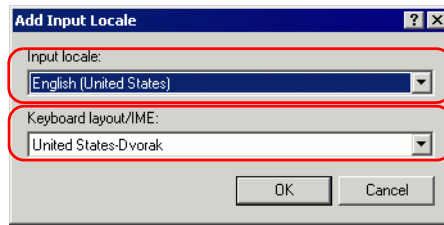

- (4) The [Regional Options] window appears again. From [Installed input locales], select the language selected earlier, and click [Set as Default]. Click [Apply] and then [OK]. Using this setting the selected language will be set as the default language.

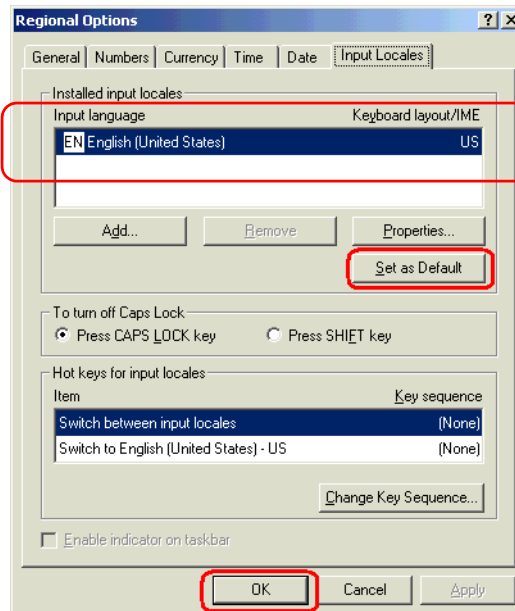

■ Using KPM to Operate Applications from Shortcuts

Assign a key or key code to KPM for each user application to enable shortcut operations.

NOTE

- Key codes can be assigned to all keys except the F/A key; however, it is recommended to assign key codes to function keys and special function keys.

- (1) Create a shortcut to an application, folder or file that you want to assign a shortcut operation.
- (2) Select the shortcut you have created, and right click on the selected shortcut to open Properties.
- (3) To set up an option argument for the application that you want to assign a shortcut operation, enter the argument after the application name displayed in the Link field.

NOTE

- For the details of the arguments, refer to the specifications of each application.

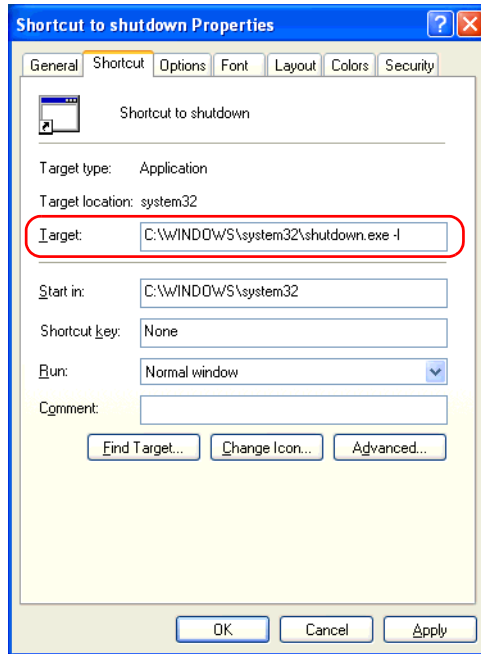

- (4) Select the [Shortcut Key] tab. Press the function key or special function key you want to assign a shortcut operation. The [Shortcut Key] field displays an automatically-selected combination of function key(s) or special function key(s).

NOTE

- For the details of combination of function key(s) or special function key(s), refer to the following section.

SEE → 8.3 Scan Code List (page 8-4)

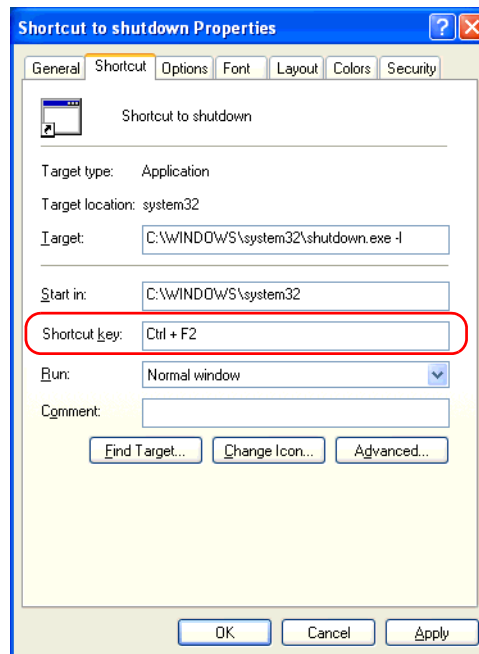

- (5) Click the [OK] button. Now shortcut operations for user applications can be performed for the function key(s) or the special function key(s).

■ Key combinations and key functions in Function mode

By combining F1 to F10, Shift, Ctrl, and Alt, you can create key functions unique to KPM or have the same operations as F11 to F40. For details about each key combination and the key function that is output, refer to the following.

IMPORTANT

- In Function mode, when PF14/^ is pressed, the code for Alt+F4 on a commercially available USB keyboard is output. The applications starting on the host end because this code corresponds to the exit code of the Windows application.

Function mode							
	Key combination	Function in KPM	Key label		Key combination	Function in KPM	Key label
Function keys	F1	F1	F1/K	Special function keys	Ctrl + F1	F21	PF1/A
	F2	F2	F2/L		Ctrl + F2	F22	PF2/B
	F3	F3	F3/M		Ctrl + F3	F23	PF3/C
	F4	F4	F4/N		Ctrl + F4	F24	PF4/D
	F5	F5	F5/O		Ctrl + F5	F25	PF5/E
	F6	F6	F6/P		Ctrl + F6	F26	PF6/F
	F7	F7	F7/Q		Ctrl + F7	F27	PF7/G
	F8	F8	F8/R		Ctrl + F8	F28	PF8/H
	F9	F9	F9/S		Ctrl + F9	F29	PF9/I
	F10	F10	F10/T		Ctrl + F10	F30	PF10/J
	Shift + F1	F11	F11/U		Alt + F1	F31	PF11/ (
	Shift + F2	F12	F12/V		Alt + F2	F32	PF12/)
	Shift + F3	F13	F13/W		Alt + F3	F33	PF13/ ?
	Shift + F4	F14	F14/X		Alt + F4	F34	PF14/ ^
	Shift + F5	F15	F15/Y		Alt + F5	F35	PF15/ %
	Shift + F6	F16	F16/Z		Alt + F6	F36	PF16/ \$
	Shift + F7	F17	F17/ :		Alt + F7	F37	PF17/ @
	Shift + F8	F18	F18/ /		Alt + F8	F38	PF18/ <
	Shift + F9	F19	F19/ \		Alt + F9	F39	PF19/ >
	Shift + F10	F20	F20/ *		Alt + F10	F40	PF20/ ~

NOTE

- When using the key combinations in the previous table with a commercially available USB keyboard, the result will be almost the same as the key functions in KPM.

IMPORTANT

- F11/F12 on commercially available USB keyboards and KPM differ.

8.5 Restrictions

- When inputting in Alpha mode with a keyboard that does not have US keyboard layout, some of the key labels will differ from what is output. Always use US keyboard layout except when inputting languages other than English.
- In KPM, the following key codes on a 101-key keyboard cannot be output.

Function	Make code	Break code	Function	Make code	Break code
`	29	A9	Num Lock	45	C5
!	2A 02	AA 82	Num 7	47	C7
#	2A 04	AA 84	Num 4	4B	CB
&	2A 08	AA 88	Num 1	4F	CF
-	0C	8C	Num /	E0 35	E0 B5
_	2A 0C	AA 8C	Num 8	48	C8
+	2A 0D	AA 8D	Num 5	4C	CC
[1A	9A	Num 2	50	D0
{	2A 1A	AA 9A	Num 0	52	D2
]	1B	9B	Num *	37	B7
}	2A 1B	AA 9B	Num 9	49	C9
;	27	A7	Num 6	4D	CD
'	28	A8	Num 3	51	D1
"	2A 28	AA A8	Num .	53	D3
	2A 2B	AA AB	Num Enter	E0 1C	E0 9C
,	33	B3	F11	57	D7
Right-Shift	36	B6	F12	58	D8
Right-Alt	E0 38	E0 B8	Print Screen	E0 2A E0 37	E0 B7 E0 AA
Right-Ctrl	E0 1D	E0 9D	Scroll Lock	46	C6
Insert	E0 2A E0 52	E0 D2 E0 AA	Pause	E1 1D 45 E1 D9 C5	

9



Troubleshooting

1. Troubleshooting
2. Error Message

9.1 Troubleshooting

9.1.1 Possible Device Problems

This chapter explains the main method of dealing with the trouble in the use of the FP.

NOTE

- For problems other than problems of the FP, please refer to the manual of each equipment.

Possible types of trouble while using this unit are as follows.

No display

- No display appears after the unit is switched on.
- The screen disappears during standard operation.
- The screen does not display normally.

Touch panel does not respond

- The touch panel does not respond when pressed. Its reaction time is abnormally long.

Trouble of keypad operation

- A different character is input.
- To input characters other than English.

WARNING



To prevent an electric shock, be sure the power cord is not connected when wiring the unit.

IMPORTANT

- This section assumes that the FP is the cause of a problem, not the host. When the host is the problem, please refer to its corresponding manual.

9.1.2 No Display

When the screen does not display when powering up, or if the screen turns OFF by itself, use the flowchart below to find an appropriate solution.

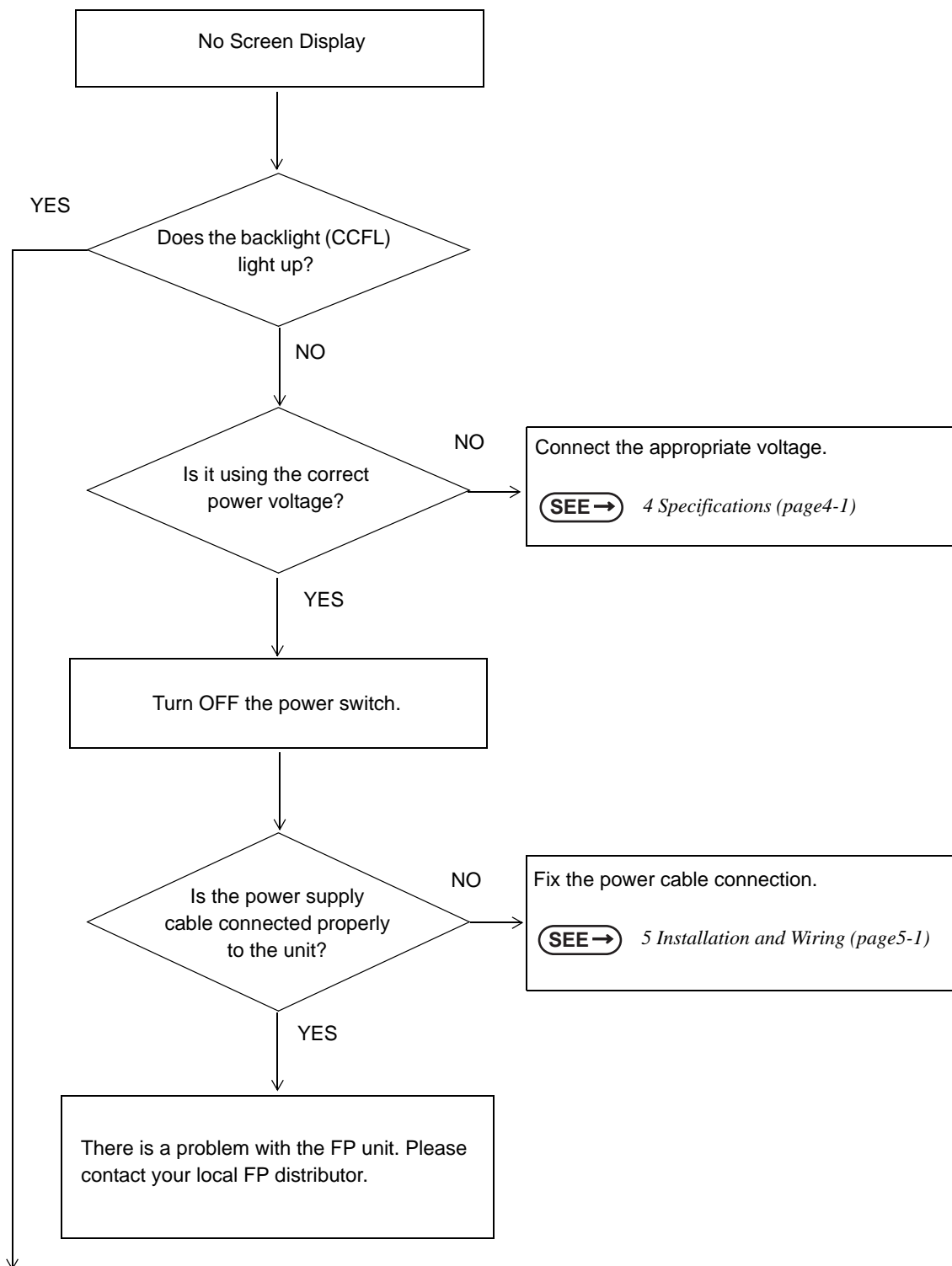

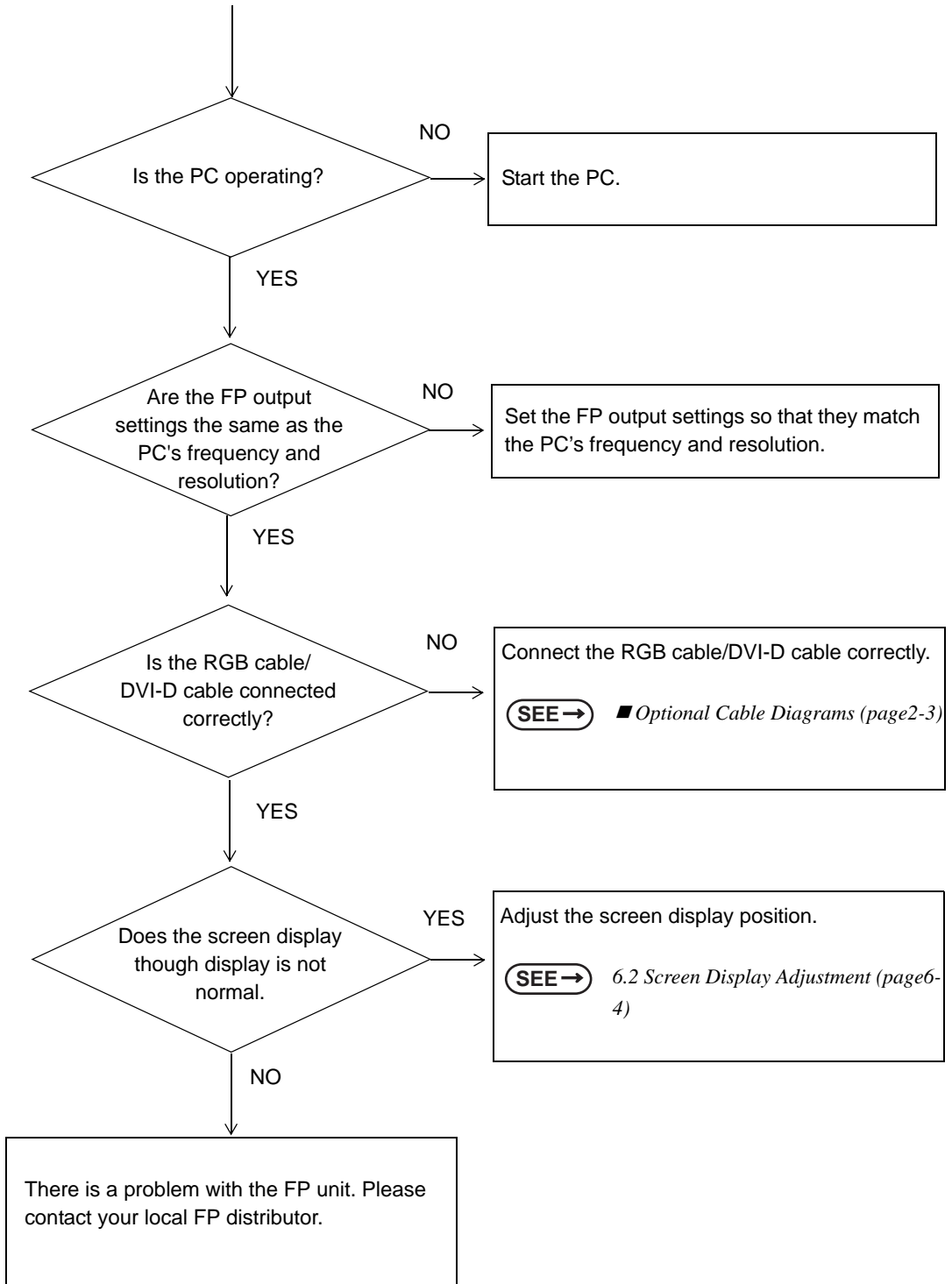

9.1.3 Touch Panel Does Not Respond

When the touch panel does not react, or its reaction is very slow after it is pressed, follow the flowchart below to find the origin of the problem and the appropriate solution.

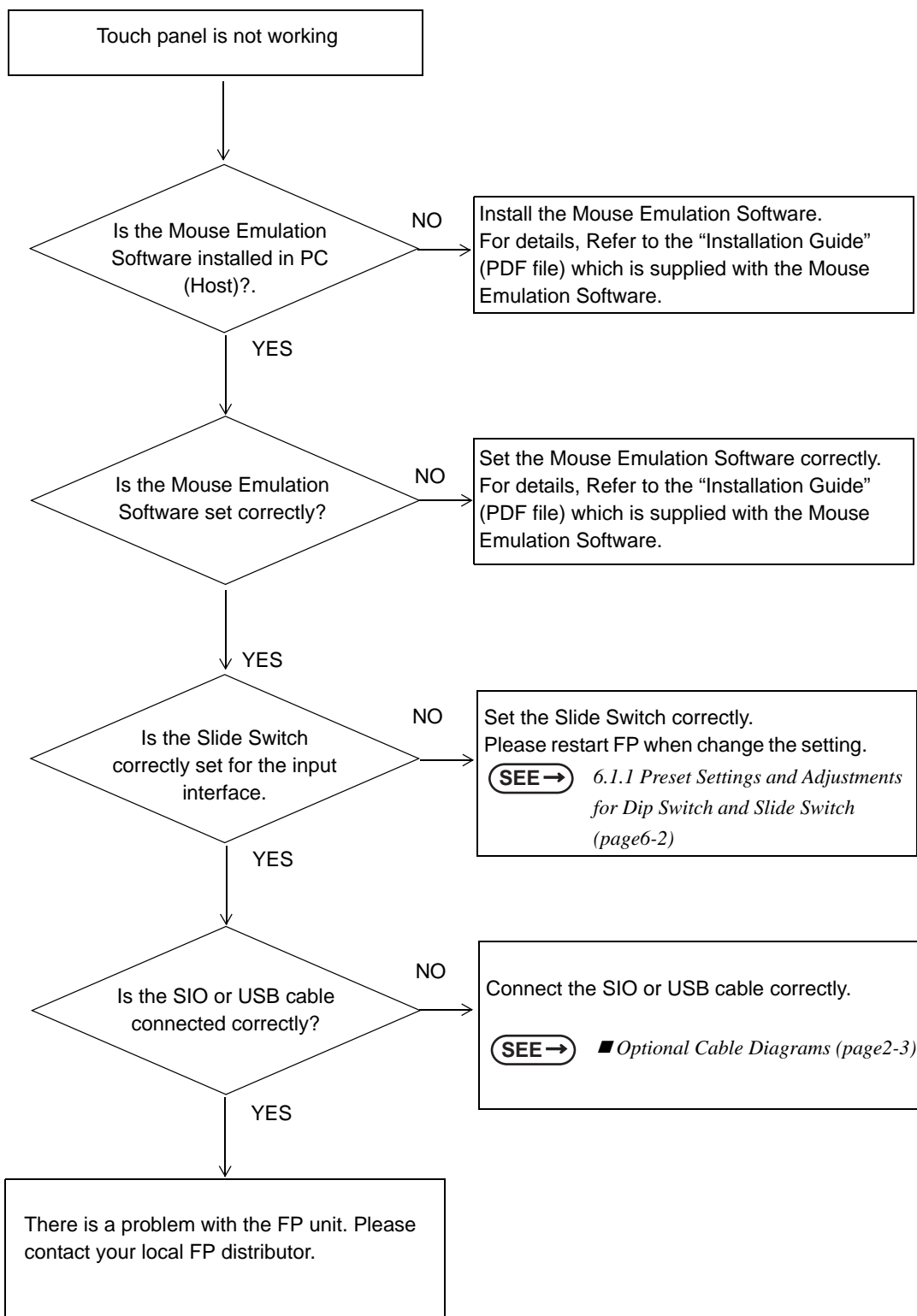

9.1.4 Trouble of keypad operation

Problem	Countermeasure and reference page
I want to know what the LED indicator indicates.	To tell the difference between Function mode and Alpha mode in KPM. SEE → ■ <i>Switching between Function mode and Alpha mode (page8-3)</i>
When inputting text in KPM, the text output is different from the text label.	Is the keyboard layout set to US? KPM is configured to operate normally with US keyboard layout. When inputting text in Alpha mode, make sure US keyboard layout is set. SEE → <i>8.4 Configuring the Keyboard Layout (page8-6)</i>
To input text other than English	Change the keyboard layout to the language to be input. SEE → <i>8.4 Configuring the Keyboard Layout (page8-6)</i>

9.2 Error Message

This section explains the messages that appear when an error has occurred in the FP unit during RUN mode. The problem causing the error message and its related countermeasure are explained in the table below.

(Only the latest error message will appear on the FP screen)

9.2.1 Error Message List

Error Message	Problem	Solution
Out of range	Signal timing has been input that is not compatible with the FP unit.	Set the FP Output settings so that they match the PC's frequency and resolution. SEE → 4.1.3 Interface Specifications (page4-5)
	The dot clock has greatly exceeded of the FP units usable timing range.	
	Resolution has been set that is not compatible with the FP unit.	
No signal	The PS-2000B unit, PL-3000B unit or a Windows-compatible PC's power has not been turned ON.	Turn on the PS-2000B unit, PL-3000B unit or a Windows-compatible PC's power.
	The PS-2000B unit, PL-3000B unit or a Windows-compatible PC has not been correctly connected to the FP unit.	Connect the RGB cable or DVI-D cable correctly.

10 | Maintenance

1. Regular Cleaning
2. Periodic Check Points
3. Backlight Replacement

This chapter indicates necessary cautions and inspection criteria to maintain your FP.

10.1 Regular Cleaning

10.1.1 Cleaning the Display

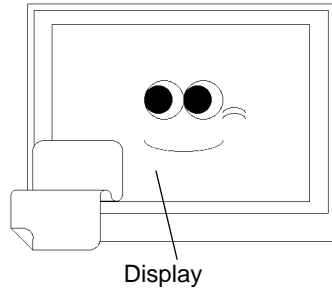
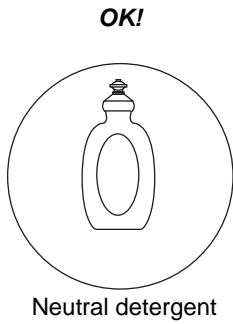

When the display surface or frame become dirty, use a soft cloth moistened with neutral detergent to wipe away any dust or stains.

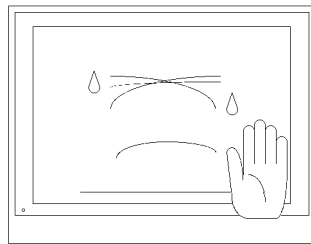
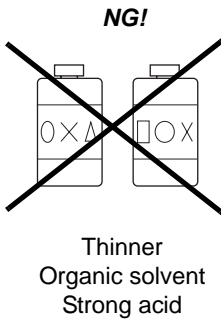

Do not clean the unit with thinner, organic solvents, or strong acids.

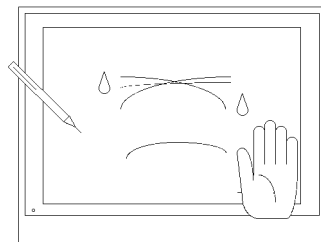

Do not use sharp or hard objects, such as a mechanical pencil or screwdriver, to push on the display. This could damage the unit.

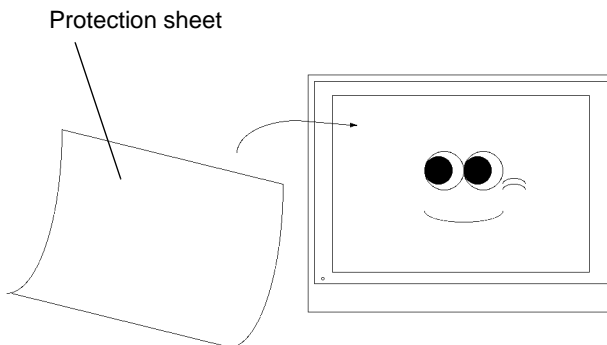

Attach the screen protection sheet when using the FP in extremely dirty or dusty areas.

10.1.2 Replacing the Installation Gasket

The installation gasket protects the FP and improves its water resistance. For instructions on installing the FP unit's gasket, refer to the following page.

SEE → 5 *Installation and Wiring (page5-1)*

- IMPORTANT**
- A gasket which has been used for a long period of time may have scratches or dirt on it, and could have lost much of its water resistance. Be sure to change the gasket at least once a year, or when scratches or dirt become visible.
 - The FP unit installation gasket's model number is as follows.

FP-3710K Series

CA7-WPG15K-01

■ Installation Gasket Replacement Procedure

- (1) Place the FP on a flat, level surface with the display facing downwards.
- (2) Remove the old gasket from the FP.
- (3) Attach the new gasket to the FP. Be sure to insert the gasket into the FP unit's groove so that the gasket's groove sides are vertical.
- (4) Check if the gasket is attached to the FP correctly.
The upper surface of the gasket should protrude approximately 2mm out from the groove.

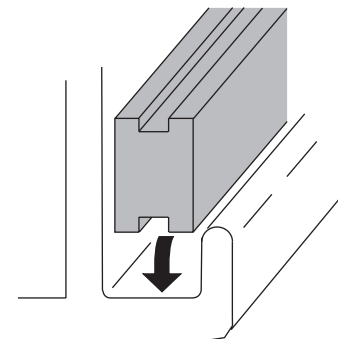

IMPORTANT

- The gasket must be inserted correctly into the groove for the FP unit's moisture resistance to be equivalent to IP65f.
- Since the gasket is flexible but not elastic, be careful not to stretch it unnecessarily, as doing so could tear the gasket.
- Be sure the gasket's seam is not inserted into any of the unit's corners, only in the straight sections of the groove. Inserting it into a corner may lead to its eventually tearing.
- Install the gasket as it comes to the under side of the display area. Otherwise it could not sufficiently prevent from dust and water.
- The upper surface of the gasket should protrude approximately 2mm out from the groove. Be sure to check that the gasket is correctly inserted before installing the FP into a panel.

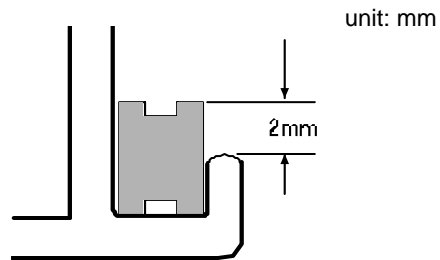

10.2 Periodic Check Points

To keep your FP unit in its best condition, please inspect the following points periodically.

■FP Operation Environment

- Is the environmental temperature within the allowable range (0°C to 50°C)?
- Is the environmental humidity within the specified range (10%RH to 90%RH, dry bulb temperature of 39°C or less)?
- Is the operating atmosphere free of corrosive gasses?

When using the FP unit inside a panel, the ambient environment refers to the interior of the panel.

■Electrical Specifications

- Is the Rated Voltage Range appropriate?

FP Model	Rated Voltage Range
FP3710-K41-U	AC85 to 264V

■Rated Items

- Are all power cords and cables connected properly? Have any become loose?
- Are all installation fasteners holding the unit securely?
- Are there any scratches or traces of dirt on the installation gasket?

10.3 Backlight Replacement

10.3.1 FP-3710K Series

FP units use a CFL, long-life type backlight. The actual life of the backlight however, will vary depending on the FP's operating conditions. It is recommended that it be replaced periodically. The service life (half brightness life) of the backlight when it is lit continuously at room temperature is as described below.

50,000 hours --- approx. 5.7 years (ambient temperature: 25°C, when lit continuously)

NOTE

- If the backlight or the display unit is damaged, the screen display will go out. Even if the screen goes out, however, there is a possibility that the touch panel is still operating correctly. Therefore, since any type of touch panel contact could have an unexpected or dangerous effect or result, be sure not to touch the screen when this condition occurs.
- A backlight burnout is detected by monitoring the consumed current. Depending on the condition of the backlight, a backlight burnout may not be detected or it may be detected before the backlight burns out completely.

! WARNING

! [Electric shock]

- Whenever changing the backlight, be sure the FP's power cord has been disconnected and that the unit is cooled down.
- When the FP's power cord is connected and the FP is ON, high voltage runs through the wires in the backlight area, do not touch them!

! [Burn]

- When the FP's power has just been turned OFF, the backlight area is still very hot! Be sure to wear gloves to prevent being burned.

! [Glass]

- The backlight is very fragile. Do not touch the glass tube directly or try to remove its power cord, if the glass tube breaks you may be injured.

■ Preparation

Please have the following ready beforehand.

- Replacement backlight (Model:CA7-BLU15-01 (Set of two lights))
- One pair of clean (preferably new) cotton gloves.
- Phillips screwdriver (no.2)

■ Replacing CA7-BLU15-01

IMPORTANT

- The backlights are located at the top and bottom of the LCD. These two lights must be replaced together.

Be sure to wear gloves when exchanging the backlight, and follow the following procedures.

- (1) Turn OFF the power switch of the FP and remove the power cable.
- (2) Remove the FP unit from the equipment (panel etc.) to which the unit has been incorporated, and place the FP unit on a flat, level surface facing the display face downwards.

IMPORTANT

- Be sure to perform the backlight changeover on a flat, level surface. This will prevent damage to the FP unit and the accidental cutting of any of its power cord.
 - Be sure to protect the display surface to prevent damage during the operations.
- (3) Unscrew the elevens (11) attachment screws securing the rear cover on the front module.

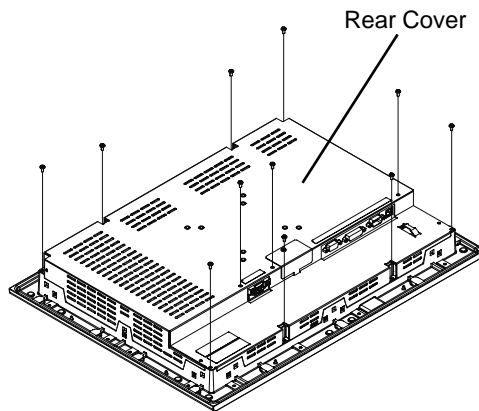

- (4) Remove the rear cover of the module..

IMPORTANT

- If the rear cover feels warm to the touch, you may get burned by the cover. Replace the backlight after the FP unit is cooled down enough.

- (5) Loosen the eight (8) screws from the LCD holder.

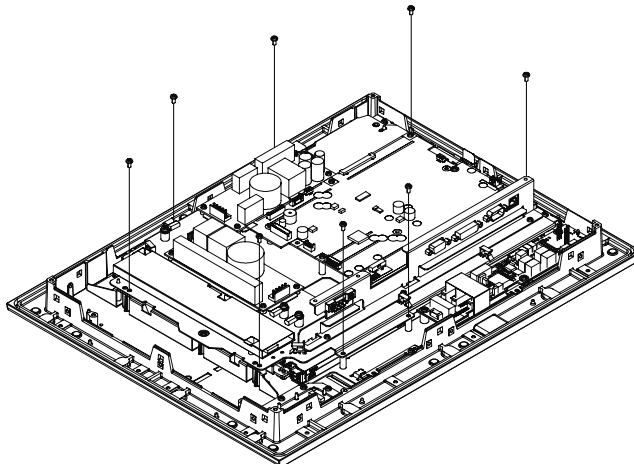

- (6) Loosen the upper and lower backlight attachment screws.

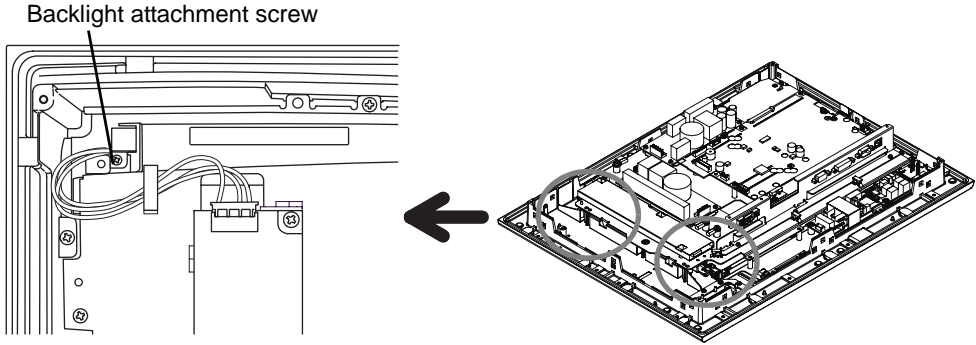

- (7) Disconnect the cable of the backlight unit from the backlight connector on the inverter board, and remove it from the cable clamp.

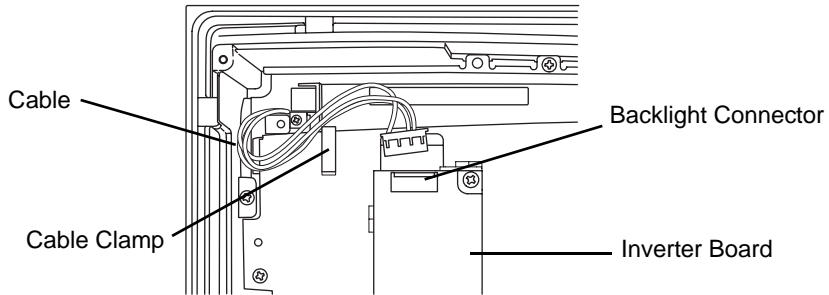

- (8) Lift the LCD holder up as shown in the figure and pull the cable in the direction of the arrow. The backlight unit can be drawn out from the port.

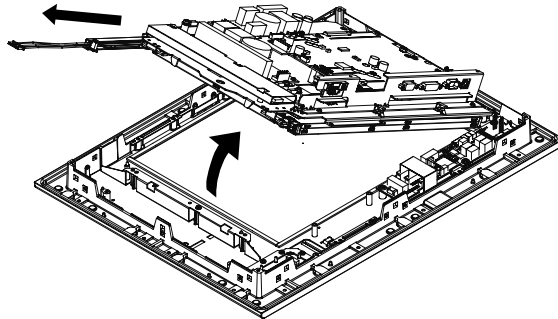

- (9) Insert a new backlight unit into the port.

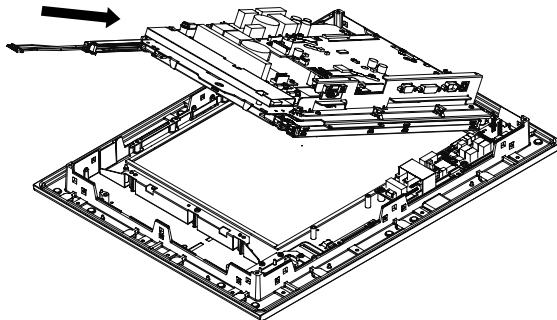

- (10) Lower the LCD holder, connect the backlight cables to the backlight connectors, and secure the cables with the clamp. (Repeat the steps (7) through (10) for the other backlight unit.)

IMPORTANT

- Be sure to insert the cable into the connector securely. Failure to do so may damage the connector.
 - To prevent the cable from being caught when reassembling the FP unit, be sure to secure the backlight cables with the clamp before installing the rear cover.
- (11) Secure the backlight unit with the upper and lower backlight attachment screws. The torque should be 0.147 N•m.
- (12) Confirm that the backlight unit is secured in place, and then secure the LCD holder with the eight screws. The torque should be 0.5 N•m.
- (13) Install the rear cover on the front module with the eleven (11) attachment screws.

IMPORTANT

- Pay attention not to catch the cable in the gap between the rear cover and the front module.
 - If any of the screws is missing, check if it fell inside the FP unit's chassis. If the power is turned ON while a screw is inside, it may cause an accident or fire.
- (14) Perform steps (1) to (4) in reverse order.

