

Preface

Thank you for purchasing Digital's color display panel, the 'FP-775S' (hereafter referred to as "the FP").

The FP is an STN type color liquid crystal display monitor for IBM-PC compatible personal computers.

Please read this manual completely to insure the correct use and complete understanding of the FP's functions.

The FP's analog RGB interface is designed to comply with VESA standards. Please be aware, however, that this unit may not be able to be connected with all currently available RGB interfaces. Thus, before using an RGB interface in an application with the FP, be sure to confirm that the interface works as expected. For further information, please refer to this chapter's "PC Connection Notes" section.

<Note>

- 1) It is forbidden to copy the contents of this manual, in whole or in part, except for the user's personal use, without the express permission of the Digital Electronics Corporation of Japan.
- 2) The information provided in this manual is subject to change without notice.
- 3) This manual has been written with care and attention to detail; however, should you find any errors or omissions, please contact the Digital Electronics Corporation and inform them of your findings.
- 4) Please be aware that the Digital Electronics Corporation is not responsible for any damages resulting from the use of our products, regardless of article 3 above.

All Company/Manufacturer names used in this manual are the registered trademarks of their respective companies.

© Copyright 1998 Digital Electronics Corporation

Safety Symbols

This section describes the safety precautions necessary for the correct use of the FP. Please keep this manual close at hand and refer to it when necessary.

■ Safety Symbol Types

The following symbols are used throughout this manual to ensure the safe use of the FP. Please be sure to follow all instructions given since they explain important safety points.



Warning

This mark warns of a situation that could cause either serious or fatal injury if the instruction is ignored and/or the unit is used incorrectly.



Caution

This mark warns of a situation that could cause either personal injury or property damage if the instruction is ignored and/or the unit is used incorrectly.



Safety Instructions

For the safe use of this unit, be sure to follow these guidelines:

- Because of the danger of electrical shock, be sure to unplug (disconnect) the power cable from the FP before plugging the cable's other end into the power supply.
- Do not use power in excess of the unit's specified voltage range since it may cause a fire, an electrical shock, or damage the unit.
- Because the FP contains high voltage parts, an electric shock can occur when disassembling the unit. Therefore, be sure to always unplug the unit before disassembling it.
- Do not modify the FP in any way, since it may cause either a fire or an electrical shock.
- When changing the backlight, be sure to turn off the unit's power first, to prevent an electric shock.
- Do not use touch panel keys to perform life-threatening or vitally important safety functions. Use separate hardware switches to provide machine emergency stop or other safety functions.
- If substantial amounts of metallic dust, water or liquids enter the FP's case, turn off the FP's power immediately, unplug the power cord, and contact your local FP distributor.
- When installing the FP, be sure to follow the instructions given in "Chapter 3. Installation and Wiring," to insure it is performed correctly.
- Do not use the FP in an environment with flammable gas since it may cause an explosion.
- The FP is not intended for applications requiring extremely-high reliability and safety, such as aircraft equipment, aerospace equipment, central communication equipment, nuclear control equipment or life-supporting medical equipment.
- When the FP is used for equipment that must provide high reliability and safety in its functions and accuracy, the entire system that uses the FP must have its safety features designed to include redundancy and error-prevention.

Examples of such usage are: transportation (trains, automobiles, ships, etc.), disaster/crime-prevention devices, numerous safety devices, and medical equipment not related to life support.



Safety Instructions

For the correct use of this unit, please follow these guidelines:

- Do not press the screen's touch surface too strongly with either your finger or a hard object, since the touch surface may be damaged.
- Do not press on the touch panel's face with sharp objects, such as a mechanical pencil or a screwdriver, since it can damage the panel surface.
- When the surface of the display screen becomes dirty or smudged, clean the display with a cloth soaked in a neutral detergent. Do not use paint thinner or organic solvent.
- Avoid using or storing the FP in direct sunlight, excessively dusty or dirty environments, or where chemicals or their vapors are present in the air.
- Please avoid using the FP in areas where sudden, large changes in temperature may occur. These changes can cause condensation to form inside the unit, possibly causing an accident.
- Avoid restricting the FP's natural ventilation, or storing and using the FP in an environment that will raise the FP's internal temperature above its designated limits.
- Do not use or store the FP in areas where chemical vapors are present or where chemicals may come into contact the unit.

Notes on the FP's Liquid Crystal Display (LCD)

- Depending on the type of information being displayed on the FP's screen, or the current contrast setting, subtle variations in brightness may appear. This phenomenon is a common attribute of LCD's and is not a defect.
- There are minute grid-points on the LCD surface. These points are not defects.
- Occasionally crosstalk (shadows appearing on extended display lines) will appear on the display. This phenomenon is a common attribute of LCD's and is not a defect.
- The displayed color will look different when viewed from an angle outside the specified view angle. This phenomenon is a common attribute of LCD's and is not a defect.
- Displaying a single screen image for long periods of time can cause an afterimage to remain on the screen. To correct this, turn the unit OFF for a short period (5 to 10 minutes), then ON again. This phenomenon is a common attribute of the LCDs, and not a defect. To prevent the creation of an afterimage, you can change the screen display periodically to prevent the displaying of a single image for a long period of time.

When the FP's Liquid Crystal Display (LCD) is Damaged

- If the FP's display is damaged or cracked, be sure to avoid any contact with the display's internal liquid.
- If any part of the user's clothing or body comes in contact with the damaged/cracked FP display's internal liquid, be sure to wash that area immediately with detergent and water. If this liquid enters the user's eye, be sure to flush with water immediately and see a doctor.
- Do not inhale any of the damaged/cracked FP display's fumes.
- Dispose of the damaged/cracked FP display in accordance with your local area's toxic material disposal regulations.

UL Application Notes

The FP-775S is a (c)UL 1950 recognized product. (UL File No.190533). Please pay special attention to the following instructions when applying for UL approval for machinery which includes one of these FP units built in. Machinery with an FP unit mounted in it requires UL inspection for the combination of the FP and the machinery.

- The FP-775S conforms as a component to the following standards:
 - UL 1950, Third Edition, dated April 30, 1998 (Standard for Safety of Information Technology Equipment, including Electrical Business Equipment)
 - CSA-C22.2 No. 950-M95 (Standard for Safety of Information Technology Equipment, including Electrical Business Equipment)
 - FP-775S (UL Registration Model No.: 0880048)

- If the FP is installed so as to cool itself naturally, be sure to install the unit in a vertical position. Also, be sure that the FP is installed so that it is at least 100mm away from any adjacent structures or devices. If these requirements are not met, the heat generated by the PL's internal components may cause the unit to fail to meet UL standard requirements.

CE Marking Notes

The FP-775S is a CE marked, EC compliant product.

<Complies with the following EC Directives>

EMC Directives 89/336/EEC, 92/31/EEC, 93/68/EEC

Low Voltage Directives 73/23/EEC, 93/68/EEC

<Complies with the following Standards>

■ **Safety**

DIN EN 60950 (VDE 0805): 1997-11

EN 60950:1992,A1:1993,A2:1993,A3:1995,A4:1997

IEC 950:1991,A1:1992,A2:1993,A3:1995,A4:1996

■ **EMI (EN50081-2)**

EN55022:1994(Class A), EN61000-3-2:1995, EN61000-3-3:1995

■ **EMS (EN50082-2)**

EN61000-4-2 :1995, EN61000-4-4:1995, EN61000-4-5:1995,

EN61000-4-11:1995, ENV50204:1995, ENV50140:1993,

ENV50141:1993

What is IP65f?

This unit's protection rating of IP65f is actually a composite code, consisting of the internationally recognized British "Ingress Protection" standard (BS EN 60529:1992) - "IP65", and the standard developed by the Japanese Electronics Manufacturer's Association (JEM) - "f". This code is used in this manual to identify a given product's degree of structural resistance to a variety of environmental elements and thus, prevent problems or accidents related to the inappropriate use of a product.

The individual meaning of each character of this code is explained below. This code indicates the degree of ingress protection provided from the front face of the PL, and assumes that the PL is securely mounted into a metal panel.

IP 6 5 f

(1) (2) (3) (4)

(1) Designates the type of protection provided.

(2) Indicates the degree of protection provided to the human body by the unit, and the degree of protection provided by the unit's front face from particles/dust intrusion into the interior of the unit.

Here, "6" indicates that the unit is completely protected from dust intrusion.

(3) Indicates the degree of protection provided by the unit's front face from water intrusion into the interior of the unit.

Here, "5" indicates that the unit is protected from water intrusion from a direct water jet.

(4) Indicates the degree of protection provided by the unit's front face from oil particle intrusion into the interior of the unit.

Here, "f" indicates that the unit is completely protected from oil intrusion via either oil particles or oil splashes from any direction (to the front panel).



For information about the FP's protective structure, refer to page 2-3.

Table of Contents

Preface	i
Safety Symbols	ii
Warning: Safety Instructions	iii
Caution: Safety Instructions	iv
UL Application/CE Marking Notes	v
What is IP65f?	vi
Table of Contents	vii
PC Connection Notes	ix
FP-775S Features	x
Package Contents	xi
Symbol Information	xii

Chapter 1—Introduction

1-1 Connecting the FP to a PC	1-1
1-2 Optional Equipment	1-3

Chapter 2—Specifications

2-1 General Specifications	2-1
1 Electrical Specifications	2-1
2 Environment Specifications	2-1
3 Structural Specifications	2-2
2-2 Functional Specifications	2-2
2-3 Interface Specifications	2-3
1 Analog RGB Interface	2-3
2 Serial Interface	2-4
3 Keyboard Interface	2-5
4 Mouse Interface	2-5
5 PC Interface	2-5
2-4 Option Cable Pin Diagrams	2-6
2-5 Names and Descriptions of FP Parts	2-8
2-6 Flat Panel (FP) Dimensions	2-9
1 FP-775S External Dimensions	2-9
2 Installation Brackets	2-10
3 FP Installation Hole Dimensions	2-10

Chapter 3—Installation and Wiring

3-1 Installation	3-1
1 Installation Procedures	3-1
3-2 Wiring	3-4
1 Power Cable Connection Precautions	3-4
2 FP Power Cable Connection Procedures	3-6
3 FP Power Supply Connection Procedures	3-7
4 FP Grounding Cautions	3-7
5 FP Input/Output Signal Line Cautions	3-7
3-3 Setup of Operation Mode and Positioning of Display	3-8
1 Operation Mode Setup and Adjustment	3-8
2 Touch Panel Display Adjustment	3-10
3 Contrast Adjustment	3-11
4 Color/Hue Adjustment	3-11

Chapter 4—Touch Panel Commands

4-1 Serial Command List	4-1
4-2 Touch Panel Data Input	4-3
4-3 Boot-up Initialization/Reset	4-7

Chapter 5—Troubleshooting

5-1 Troubleshooting	5-1
1 Possible Device Problems	5-1
2 No Display	5-2
3 Touch Panel Does Not Respond	5-4

Chapter 6—Maintenance

6-1 Cleaning the FP's Display	6-1
6-2 Periodic Check-Up	6-2
6-3 Backlight Replacement	6-3

Index

PC Connection Notes

The FP's analog RGB interface offers normal display performance within the following ranges:

VESA standard display mode	Size	Horizontal frequency	Vertical frequency	Dot clock frequency
VGA	640 x 480	31.5 kHz	60 Hz	25.175 MHz \pm 0.4 %
XGA	1024x 768	48.4 kHz	60 Hz	65.000 MHz \pm 0.4 %
		56.5 kHz	70 Hz	75.000 MHz \pm 0.4 %
		60.0 kHz	75 Hz	78.750 MHz \pm 0.4 %
US Text	720 x 400	31.5 kHz	70 Hz	28.300 MHz \pm 0.4 %

Both the VGA and US Text mode displays can only use the "Centering" option.

Since some commercially-available video interface equipment also accommodates tracking ranges in excess of those shown above, they may not offer normal display performance when used with the PC. Before using a video interface, be sure to check its specifications.

Also, even if the same type personal computer is used to transfer data to the PC, the above mentioned problems can also occur when the PC's video board is replaced.

The touch panel's PS/2 mouse connector can be used with equipment conforming to PS/2 mouse standards, however specified performance cannot be guaranteed with every PC and mouse combination.

Also, certain restrictions may apply to the touch panel's PS/2 mouse connector depending on the OS being used.

If an extended mouse/keyboard cable is connected through the FP, the FP may not operate normally, depending on the combination of the host and mouse/keyboard or its cable length. In such a case, connect the mouse/keyboard cable directly to the host.

While the FP('s OS) is starting up, please do not touch the screen's touch panel.

FP-775S Features

- **Large-sized, high-quality color LCD**

The monitor uses a 15 inch STN type color LCD, and its wide range of display colors allow a wide variety of screen designs.

- **FP's large-sized display is compatible with XGA mode**

The FP is compatible with XGA mode, allowing a large variety of information to be displayed.

- **PC data can be displayed on the FP**

Since the FP is connected to the host through an analog RGB interface, it can be easily connected to a personal computer and used as a display.

Reference For the available display modes, see this chapter's "*PC Connection Notes*")

- **Panel-mount design allows the FP to be built into other equipment**

The slim and compact body is designed specifically to be built into machine cabinets and panels. Since the FP can be easily used with other equipment, it can be used as a monitor for your PC-based FA or PA system. Also, the FP front panel's moisture resistant gasket provides a dust and drip-resistant seal between the FP's front face and the installation panel. Thus, the FP can be used even in harsh industrial environments.

- **Touch panel can be operated while PC data is monitored (Standard feature)**

The FP's touch panel is standard equipment and is suitable for monitoring systems that require touch operations. Also, the FP provides two types of interfaces between the touch panel and the host: an RS-232C interface and PS/2 output via the mouse port. These interfaces can be selected according to your system configuration needs.

Package Contents

The FP's packing box contains the items listed below. Please check to be sure each is included and is not damaged.

- FP unit (FP775-S42)**

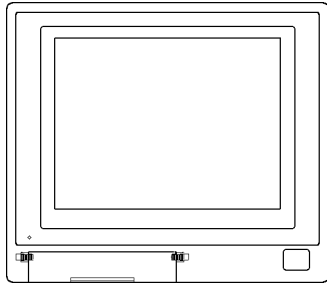

- Flat Panel Display FP-775S User's Manuals
(English and Japanese)**

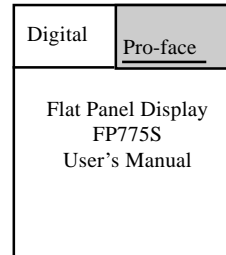

- 3.5 inch floppy disk (1)^{*1}**

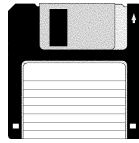

- Mounting brackets (12)**



- Moisture-resistant gasket (1)**







These items have all been carefully packed with special attention to product quality. However, should you find any item(s) damaged or missing, please contact your local distributor immediately for prompt service.

*1 For description and usage of the application programs stored in the floppy disk, see that disk's English "README" file.

Symbol Information

The list below describes the symbols used in this manual.

Symbol	Meaning
 Warning	Used to indicate situations where severe bodily injury, death or major machine damage can occur.
 Caution	Used to indicate situations where slight bodily injury or machine damage can occur.
 Important	Used to indicate important information or procedures that <u>must</u> be followed for correct and risk-free software/device operation.
*1	Footnote marker used to provide useful or important supplemental information.
1) , 2)	Indicates steps in a procedure. Be sure to perform these steps in the order given.
 Reference	Used to refer to useful or important supplemental information.
 Note:	Used to provide useful or important supplemental information.

Chapter 1

Introduction

1. Connecting the FP to a PC
2. Optional Equipment

The following diagram illustrates the connection options available between the FP and a PC.

1-1 Connecting the FP to a PC

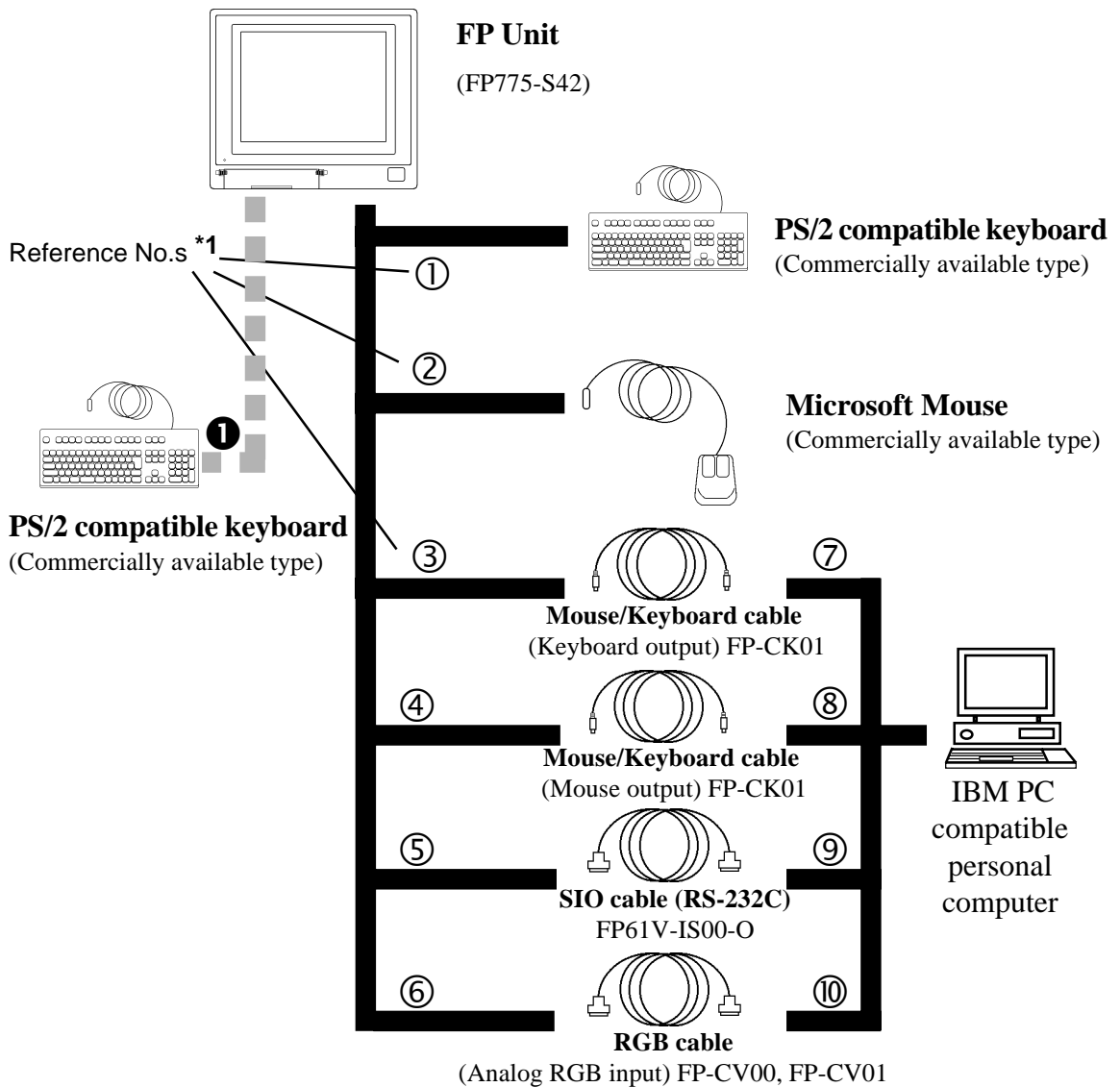

1 For a description of each reference no. used (⑥, etc.) refer to the next page.*



Optional Parts

(Sold separately)

	Display Protection Sheets (5 sheets/set) FP77-COVER-5P
---	---

Maintenance Parts

These parts are included in either the FP or its package as standard equipment, and are also optionally available for FP maintenance.

	Backlight (2 lights/set) FP775S-BL00-MS
	Mounting Brackets (4 brackets/set) GP070-AT00-MS
	Moisture-Resistant Gasket FP77-WP00-MS

Page 1-1	Reference Number	Description
		FP Interface (inside front maintenance cover)
	❶	KEYBOARD/Keyboard
		FP Interface (rear face connectors)
	①	KEYBOARD/Keyboard
	②	MOUSE/Mouse
	③	KEYBOARD/PC
	④	MOUSE/PC
	⑤	RS-232C connector
	⑥	Analog RGB I/F connector
		Reference 2-5 Names and Descriptions of FP Parts
		Personal computer interface
	⑦	Keyboard interface
	⑧	Mouse interface
	⑨	Serial interface
	⑩	Analog RGB interface

Introduction

1-2	Optional Equipment
------------	---------------------------

All items listed below are products of the Digital Electronics Corporation.

	Item Name	Model No.	Description
Interface Cable Types	SIO cable	FP61V-IS00-O	Serial interface cable used for transmission of touch panel data between the FP and various hosts (PCs), and for the transmission of commands to the FP. (5 m) Compatible with PC/AT (D-sub 9-pin female connector) computers
	RGB cable	FP-CV00	Analog RGB interface cable used to output image signals from various host (PCs) to the FP. (2.5 m) Compatible with analog RGB interface (D-sub 15-pin male connector).
	RGB cable	FP-CV01	Analog RGB interface cable used to output image signals from various host (PCs) to the FP. (5 m) Compatible with analog RGB interface (D-sub 15-pin male connector).
	Mouse/Keyboard cable	FP-CK01	Used to connect a mouse or keyboard between the host and the FP. (2.5 m) Compatible with PS-2 (mini DIN 4-pin/6-pin male connectors) devices
Maintenance Parts	Backlight	FP775S-BL00-MS	Replacement Backlight Set (2 lights/set - upper and lower lights)
	Mounting brackets	GP070-AT00-MS	Used to secure the FP to its installation panel. (4 brackets/set)
	Display Stand	FP77-DS00	Used to support the FP-775S. Provides a nearly vertical viewing face and is intended for maintenance or development purposes only.
	Moisture resistant gasket	FP77-WP00-MS	Used to prevent moisture from entering the FP's chassis. Same gasket as originally included with the FP.
Optional Parts	Display protection sheets	FP77-COVER-5P	Disposable sheets that protect the display from dust and dirt. The touch panel can be used when one of these sheets is attached. (5 sheets/set)



Chapter 2

Specifications

1. General Specifications
2. Functional Specifications
3. Interface Specifications
4. Option Cable Pin Diagrams
5. Names and Descriptions of FP Parts
6. Flat Panel (FP) Dimensions

2-1	General Specifications
------------	-------------------------------

2-1-1 Electrical Specifications

Input Voltage	AC 85 V to 265 V 50/60 Hz
Power Consumption	Less than 65 VA
Allowable Power Failure	Within 20 ms
Maximum Voltage	AC 1500 V 20 mA 1 minute (between the live wire and grounding terminals)
Isolation Resistance	DC 500 V greater than 10 MΩ (between the live wire and grounding terminals)

2-1-2 Environment Specifications

Operating Temperature	0 to 40 degrees Celsius
Storage Temperature	- 10 to 60 degrees Celsius
Ambient Humidity	30% RH to 85% RH (non-condensing)
Vibration Resistance	2 Gs at 10 to 25 Hz (X, Y, Z directions: 30 minutes each)
Atmosphere	Must be free of corrosive gas
Noise Immunity (via noise simulator)	Noise voltage : 1500 Vp-p
	Pulse length : 50 ns/500 ns/ 1 μs
	Arise time (rise/fall): 1 ns
Grounding^{*1}	Less than 100Ω or your country's applicable standard
Rating^{*2} (with front panel closed)	Equivalent to IP65f (JEM1030)

*1 (See the next page's note)

(From previous page)

- *1 For details, please contact your local FP distributor.*
- *2 The front face of the GP unit, installed in a solid panel, has been tested using conditions equivalent to the standard shown in the specification . Even though the GP unit's level of resistance is equivalent to the standard, oils that should have no effect on the GP can possibly harm the unit. This can occur in areas where either vaporized oils are present, or where low viscosity cutting oils are allowed to adhere to the unit for long periods of time. If the GP's front face protection sheet becomes peeled off, these conditions can lead to the ingress of oil into the GP and separate protection measures are suggested. Also, if non-approved oils are present, it may cause deformation or corrosion of the front panel's plastic cover. Therefore, prior to installing the GP be sure to confirm the type of conditions that will be present in the GP's operating environment.*

If the installation gasket is used for a long period of time, or if the unit and its gasket are removed from the panel, the original level of the protection cannot be guaranteed. To maintain the original protection level, you need to replace the installation gasket regularly.

2-1-3 Structural Specifications

External Dimensions (mm)	405 W x 350 H x 75 D (Unit only, including rear projections)
Weight	7.5 kg or less (Unit only)
Cooling System	Natural air circulation

2-2	Functional Specifications
------------	----------------------------------

Display Media	STN color LCD
No. of Display Colors	4096
Contrast Adjustment	Possible via adjustment knob, located inside of front face maintenance cover
Dot Pitch (mm)	0.297 W x 0.297 H
Touch Panel Resolution	1024 x 1024 (Max.)
Display Area (mm)	307 W x 231 H
Display Mode (selected with a switch)	640 x 480 (VGA) 720 x 400 (US Text) 1024 x 768 (XGA)
Interfaces	Analog RGB input, RS-232C input, PS/2 input and output (both mouse and keyboard)
Backlight	CFL (under continuous 24 hour operation, lifetime = 17,000 hours)

Specifications

2-3 Interface Specifications



Please use Digital's optional cable. If any other cable is used, due to possible noise interference, Digital cannot guarantee the FP will perform as specified.

2-3-1 Analog RGB Interface

Input signal type	Analog RGB
Input signal characteristics	Image signal : analog RGB Synchronous signal : TTL level, negative true or positive true Scanning type : non-interlaced
Adjustment features	Flicker adjustment (DOT CLOCK) Contrast adjustment Horizontal display positioning Vertical display positioning

VESA standard display mode	Size	Horizontal frequency	Vertical frequency	Dot clock frequency
VGA	640 × 480	31.5 kHz	60 Hz	25.175MHz ± 1 %
XGA	1024 × 768	48.4 kHz	60 Hz	65.000MHz ± 1 %
		56.5 kHz	70 Hz	75.000MHz ± 1 %
		60.0 kHz	75 Hz	78.750MHz ± 1 %
US Text	720 × 400	31.5 kHz	70 Hz	28.300MHz ± 1 %



The VGA and US Text modes can only use the centering display.

Pin Assignments and Signal Names for Analog RGB Connector

Pin No.	Signal Name	Condition	Pin Location
1	Analog R	R signal input	
2	Analog G	G signal input	
3	Analog B	B signal input	
4	Reserved	NC (reserved for input)	
5	Digital Ground	Digital signal GND	
6	Return R	R signal GND	
7	Return G	G signal GND	
8	Return B	B signal GND	
9	Reserved	NC (reserved for input)	
10	Digital Ground	Digital signal GND	
11	Reserved	NC (reserved for input)	
12	Reserved	NC (reserved for input)	
13	H. SYNC	Horizontal synchronous signal input	
14	V. SYNC	Vertical synchronous signal input	
15	Reserved	NC (reserved for input)	

- Connector :** Mini Dsub 15 pin male
- Connector set screw :** Inch type (4-40)
- Cable :** Digital Electronic Corporation RGB cable (FP-CV00,FP-CV01)

2-3-2 Serial Interface

Serial Interface	Baud rate :	9600 bps
	Data length :	8 bits
	Parity :	None
	Stop bit :	1

Pin Assignments and Signal Names for Serial Interface Connector

Pin No.	Signal Name	Condition	Pin Location
1	CD	Carrier Detect (FP → Host)	
2	RD	Receive Data (FP → Host)	
3	SD	Send Data (FP ← Host)	
4	DTR	Data Terminal Ready (FP ← Host)	
5	GND	Ground	
6	DSR	Data Set Ready (FP → Host)	
7	RS	Request to Send (FP ← Host)	
8	CS	Clear to Send (FP → Host)	
9	NC	No connection	

Connector : Dsub 9 pin female

Connector set screw : Inch type (4-40)

Cable : Digital Electronic Corporation SIO cable (FP61V-IS00-O)

Signal Names

Signal names used for the FP's serial interface are designed to match the pin order used on most PC serial interfaces, so that a straight cable can be used to connect the two. Therefore, connect each pin's signal to the same signal name on the PC connector.

For example, pin #2 'RD' should be connected to the PC's 'RD' pin (terminal).

Refer to section "2-4 Option Cable Pin Diagrams" for information about each signal's direction.

Specifications

2-3-3 Keyboard Interface (KEYBOARD - Keyboard)

Mini DIN 6-pin (Female)

(Common to front and rear)

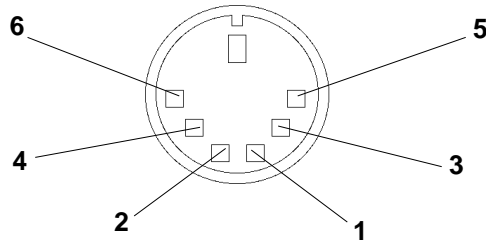

<Manufactured by Hoshi Electronics, Inc.:
TCS7568-43-201 or equivalent>

Pin No.	Signal name
1	KEY DATA
2	NC
3	GND
4	+5V
5	KEY CLK
6	NC

Possible keyboards: FKB1424-001 (compact type) manufactured by Fujitsu, Inc.
FKB4874-101 manufactured by Fujitsu, Inc.

2-3-4 Mouse Interface (MOUSE - Mouse)

Mini DIN 6-pin (Female)

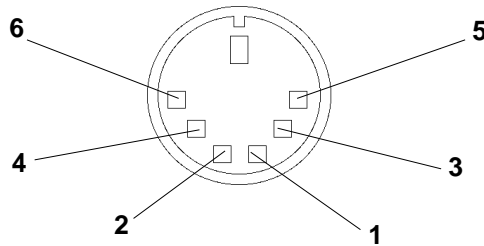

<Manufactured by Hoshi Electronics, Inc.:
TCS7568-43-201 or equivalent>

Pin No.	Signal name
1	MOUSE DATA
2	NC
3	GND
4	+5V
5	MOUSE CLK
6	NC

Suggested Mouse: Microsoft (Corp.)'s Microsoft mouse (PS/2 type)

2-3-5 PC Interface (MOUSE-PC/KEYBOARD-PC)

Mini DIN 4-pin (Female)

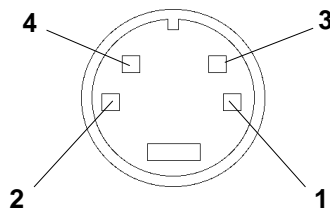

Pin No.	Signal name
1	GND
2	+ 5V
3	CLK
4	DATA

<Connector Maker: JST, MD-S6100 or equivalent>

2-4	Option Cable Pin Diagrams
------------	----------------------------------

RGB Interface Cable Pin (Optional cable: VGA specification) Assignments

FP Connector			RGB cable					PC Connector		
1	Analog R	Input	1	RED IN	RED VIDEO	1	Output	RED VIDEO	1	
2	Analog G	Input	2	GRN IN	GRN VIDEO	2	Output	GRN VIDEO	2	
3	Analog B	Input	3	BLU IN	BLU VIDEO	3	Output	BLU VIDEO	3	
4	Reserved	-	4	NC	NC	4	-	NC	4	
5	Digital ground	-	5	GND	GROUND	5	-	GROUND	5	
6	Return R	-	6	RED GND	GROUND RED	6	-	GROUND RED	6	
7	Return G	-	7	GRN GND	GROUND GRN	7	-	GROUND GRN	7	
8	Return B	-	8	BLU GND	GROUND BLU	8	-	GROUND BLU	8	
9	Reserved	-	9	NC	NC	9	-	NC	9	
10	Digital ground	-	10	GND	GROUND	10	-	GROUND	10	
11	Reserved	-	11	NC	MONITOR SENSE(COLOR)	11	-	MONITOR SENSE(COLOR)	11	
12	Reserved	-	12	NC	MONITOR SENSE(MONO)	12	-	MONITOR SENSE(MONO)	12	
13	H.SYNC	Input	13	HSYN	HSYN	13	Output	HSYN	13	
14	V.SYNC	Input	14	VSYN	VSYN	14	Output	VSYN	14	
15	Reserved	-	15	NC	NC	15	-	NC	15	
FG	FG	-	FG	FG	FG	FG	-	FG	FG	

- Signal names for the FP's RGB interface are designed to match the same pin order as the RGB interface on standard PCs. Since this cable (FP-CV00, FP-CV01) is designed to use the same pin numbers for the FP and the PC, it can be connected in either direction.
- Since the PC connector's pitch is designated in “inch” units, the interface cable and the FP connector's pitch are also designated in “inch” units (4-40).

Specifications

Pin Connections for the SIO Interface Cable (Optional cable: PC/AT specification)

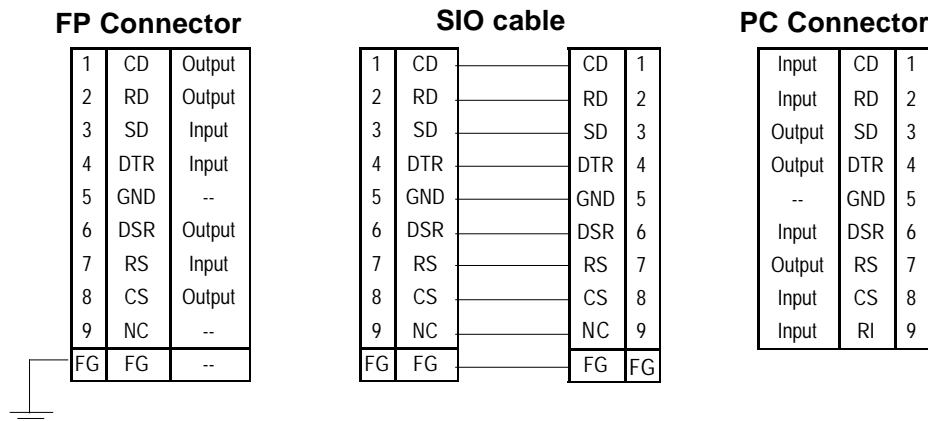

Signal names for the FP's SIO interface are designed to match the same pin order as the SIO interface on standard PCs. As a result, the FP61V-IS00-O can be connected in either direction.

Since the PC connector's pitch is designated in "inch" units, the interface cable and the FP connector's pitch are also designated in "inch" (4-40) units.

Mouse/Keyboard Cable Pin Numbers

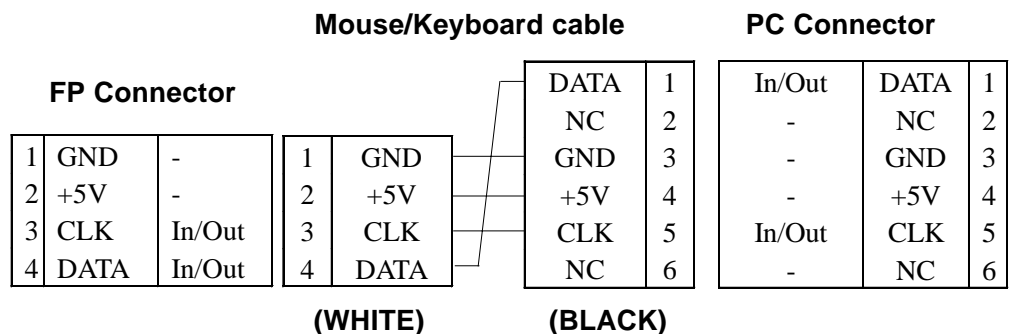

The signal names of the FP unit interface and the mouse/keyboard cable (FP-CK01) conform to those of the personal computer interface. To prevent accidents and connector damage, please be aware that the ends of this connector are different. Connect the 4 pin (white) connector to the FP, and the 6 pin (black) connector to the PC.

Front View

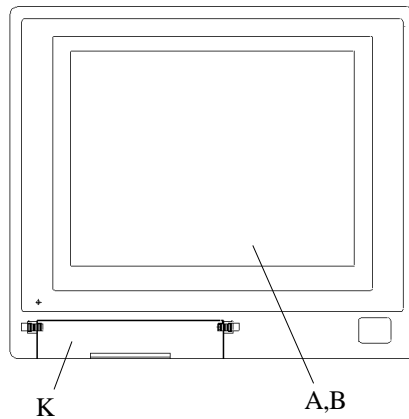

A: STN type color LCD

The FP units' output display. Data from the host are displayed.

B: Touch panel

Used to switch screens and write data into the host.

C: Power input terminal block

Used to connect the power supply cable.

D: Setting switches (DIP switches)

Used to set the FP's operation mode.

E: Analog RGB I/F connector

Analog RGB interface connector

F: RS-232C connector

RS-232C (serial) interface connector used to send touch panel data between the FP and host, and to send commands to the FP.

G: MOUSE/Mouse connector

Accepts standard mouse input.

H: MOUSE/PC connector

Used to output mouse data from the FP (to a PC). Cable from here connects to any PS/2 compatible mouse input connector.

I: KEYBOARD/Keyboard connector

Used to connect the PS/2 compatible keyboard.

J: KEYBOARD/PC connector

Used for FP keyboard data output. Connects to the PS/2 compatible keyboard input connector.

K: Front maintenance cover

Protects the FP's RESET switch, keyboard connector and contrast adjustment knob.

Rear View

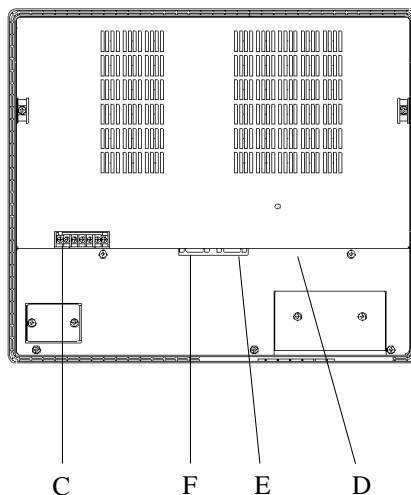

Bottom View

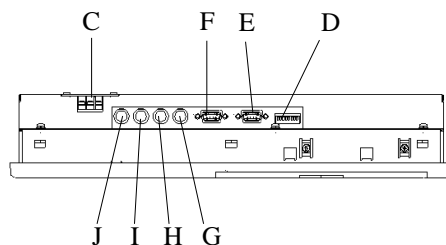

Be sure that all cables are connected correctly and that the FP is turned OFF before any cables are disconnected, since either of these can cause the FP to malfunction.

Specifications

2-6	Flat Panel (FP) Dimensions
------------	-----------------------------------

2-6-1 FP-775S External Dimensions

Unit: mm

Note: For detailed dimension information, please contact your local FP distributor.

Top View

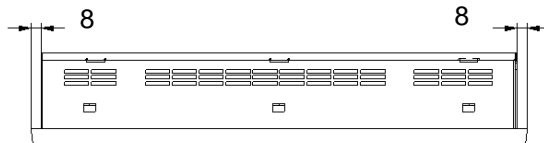

Front View

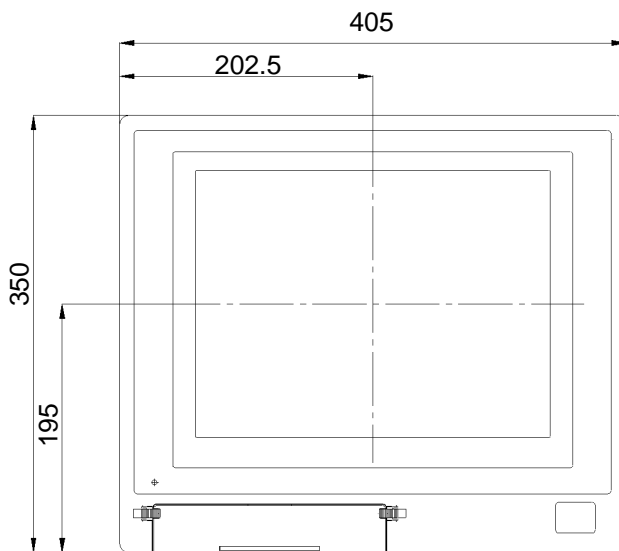

Side View

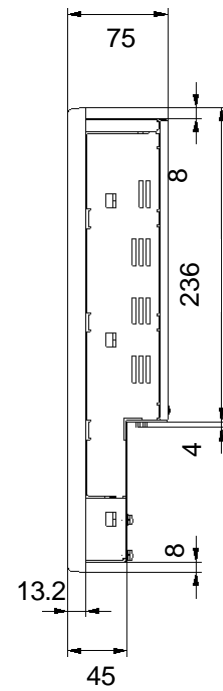

Rear View

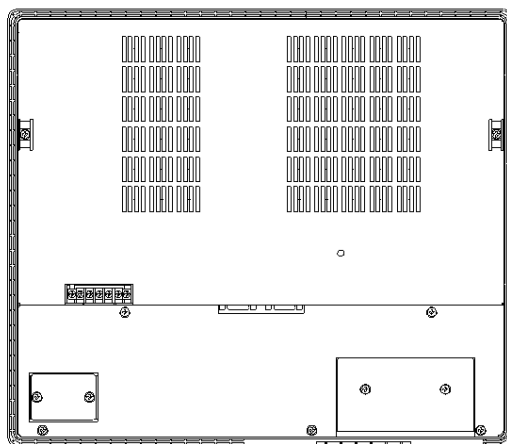

2-6-2 Installation Brackets

Unit: mm

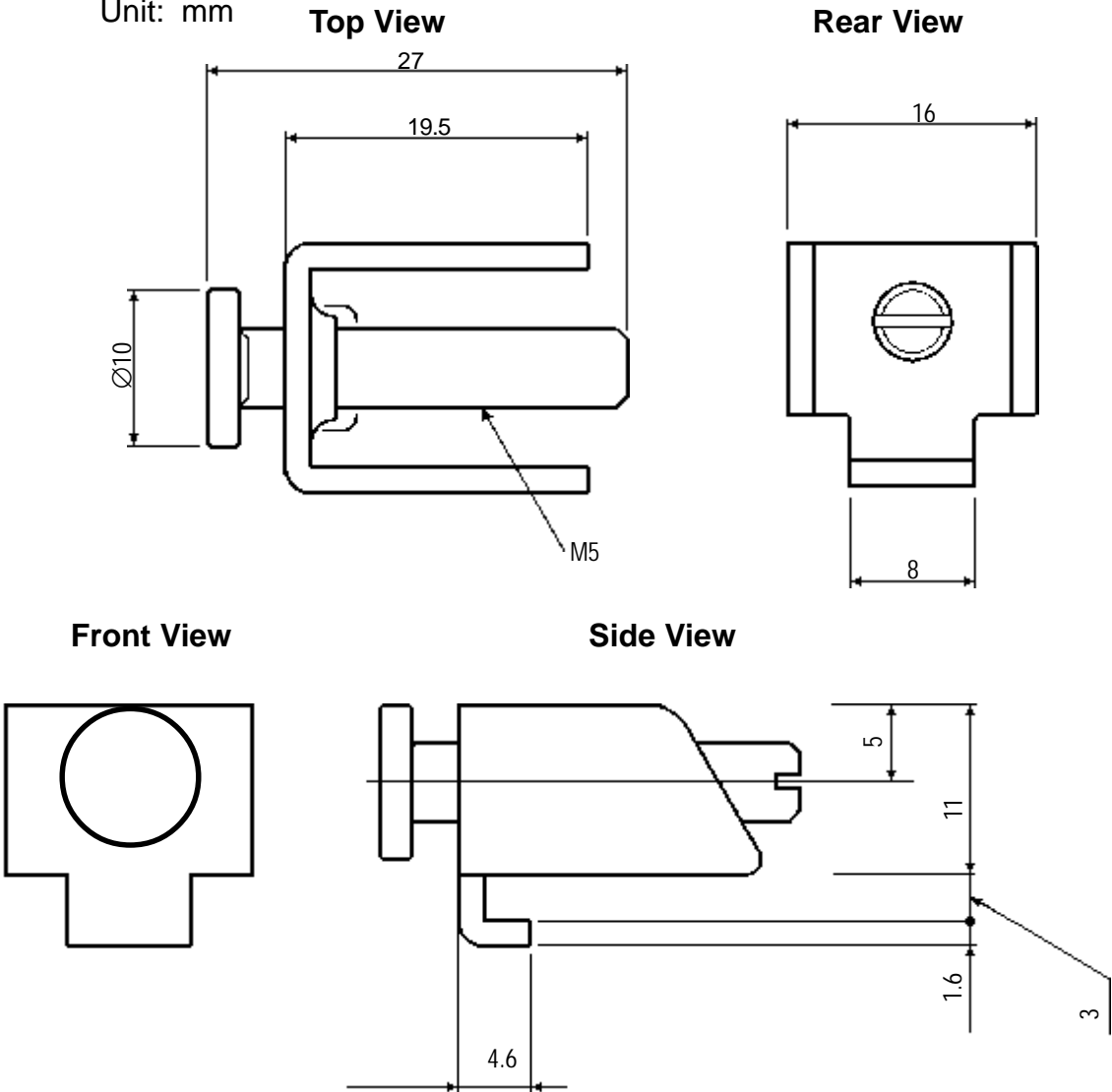

2-6-3 FP Installation Hole Dimensions

Unit: mm

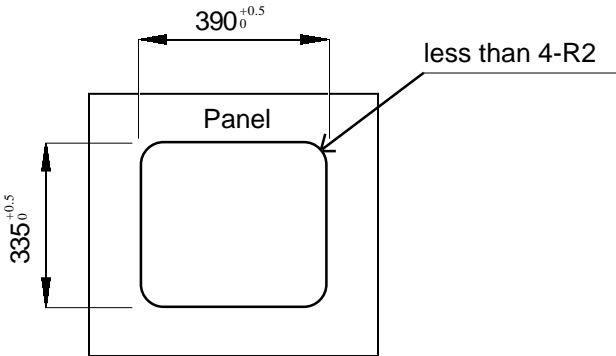

If the FP's mounting panel is not sufficiently thick or strong, the specified level of moisture-resistance may not be possible.

Chapter 3 Installation and Wiring

1. Installation
2. Wiring
3. Setup of Operation Mode and Positioning of Display

3-1 Installation

3-1-1 Installation Procedures



- Before installing the FP, be sure the moisture-resistant gasket is securely attached.

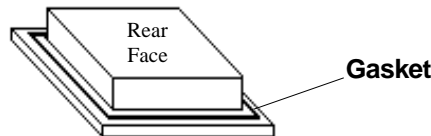

■ Create an Installation Hole

Using these FP installation dimensions as a guide, create (cut) the correct sized installation opening. The FP's seal, installation brackets and screws are all required when installing the FP. **Reference** 2-6-3 FP Installation Hole Dimensions

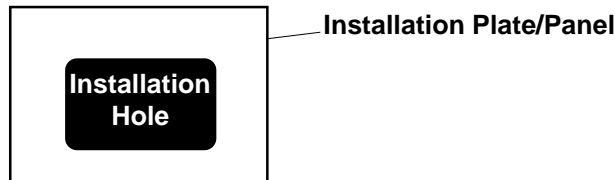

- It is important that the plate/panel surface is flat, clean, and without any jagged edges. If the panel is thin and may warp, attach a reinforcing plate to the panel.
- The Plate/Panel thickness should be between 1.6 and 10.0mm.

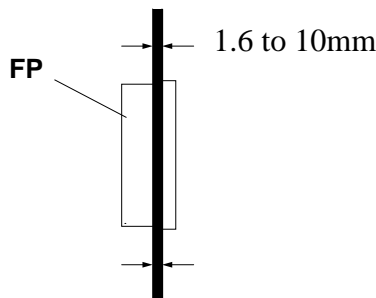

- If the plate/panel used is too thin or weak, a satisfactory moisture-resistant seal may not be created.

Installation and Wiring



- For easier maintenance and operation, and improved ventilation, be sure the FP is installed at least 100 mm away from any adjacent structures or objects.

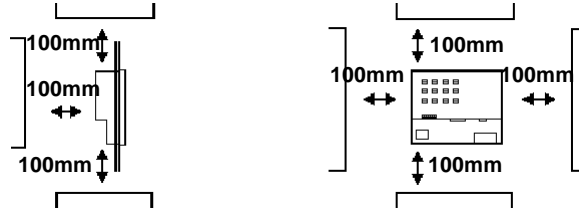

- The FP uses natural ventilation through its outer shell for cooling. When installing the unit horizontally or sideways (portrait style), use a fan or air conditioning unit to prevent overheating.

Horizontal Installation

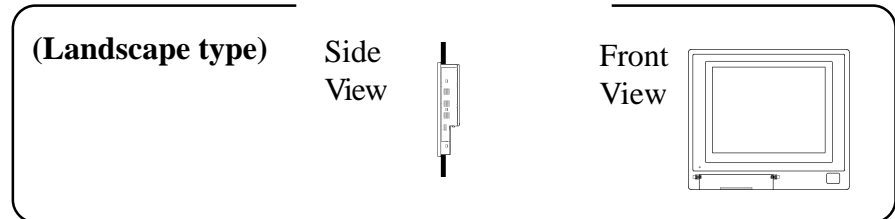

- Check that heat from surrounding equipment will not cause the FP to overheat.
- The FP should not be used in areas where the ambient temperature will exceed 40 degrees centigrade.
- Be sure this unit is located as far away as possible from electromagnetic circuits, non-fuse type breakers, and other equipment that can cause arcing.
- When installing the FP in a panel with an angled face, the face should not incline either backwards or forwards more than 30°.

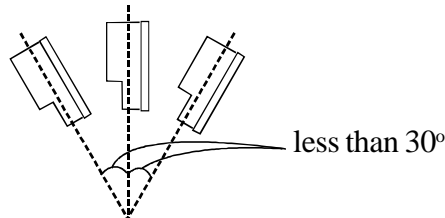

Insert the FP into the installation hole from the front of the panel.

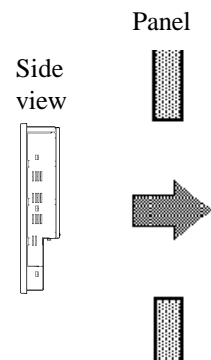
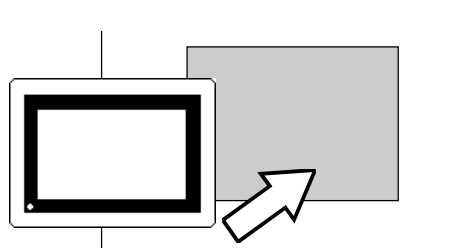

Installation and Wiring

■ Secure the FP in place using the mounting brackets.

Insert the mounting bracket hooks into the slots provided on the top, bottom and sides of the FP (three slots on the top and bottom and three slots in the right and left sides, respectively).

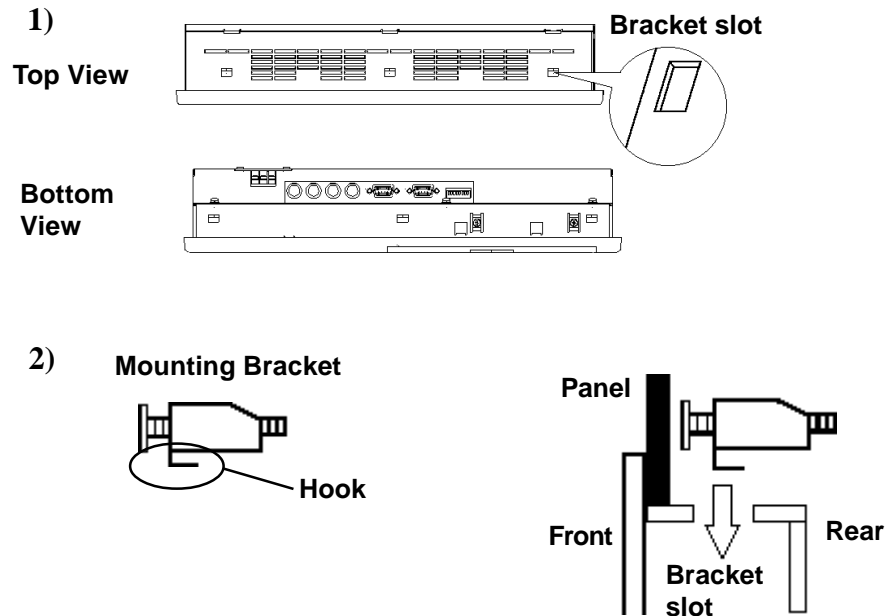

3) After inserting the hook into the slot, move the bracket backward. Then, use a screwdriver to tighten the screw and secure the FP in place.

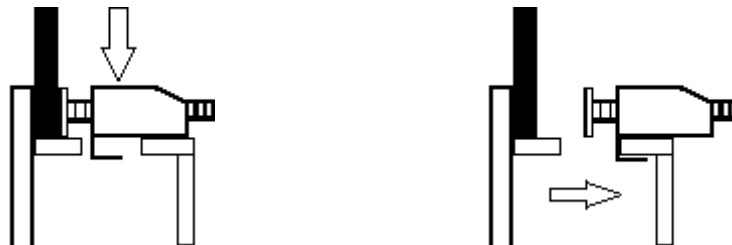

4) Tighten the mounting bracket's screw with a screwdriver. To ensure the FP's front panel is sufficiently moisture-resistant, tighten the screw with no more than 0.5 to 0.6 N•m of torque.

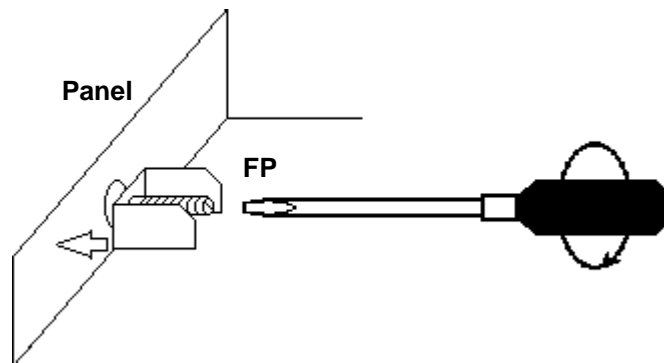

Excessive torque may cause damage to the unit.

3-2 Wiring

This section describes wiring installation precautions and the FP's power cable wiring procedures.

3-2-1 Power Cable Connection Precautions



Warning

- When connecting the power cable, be sure that power is not supplied to the FP due to the danger of electric shock.
- If a voltage exceeding the FP's specified power range is applied, both the FP and the power supply units will be damaged.
- Since the FP has no power switch, be sure to set up a separate circuit breaker.



Important

- When the frame ground (FG) terminal is not connected, the FP is easily affected by noise interference. Be sure to ground the unit.



Note:

- Use thick wire (2 mm² max.) for the FP's power cord. Be sure that the cord wire ends are twisted before attaching the ring terminals.
- Use ring terminals with the following dimensions:

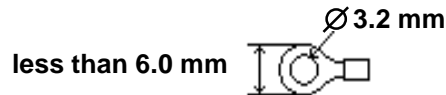

- To prevent the power terminals from being short-circuited due to a loose screw, use ring terminals with insulating sleeves.

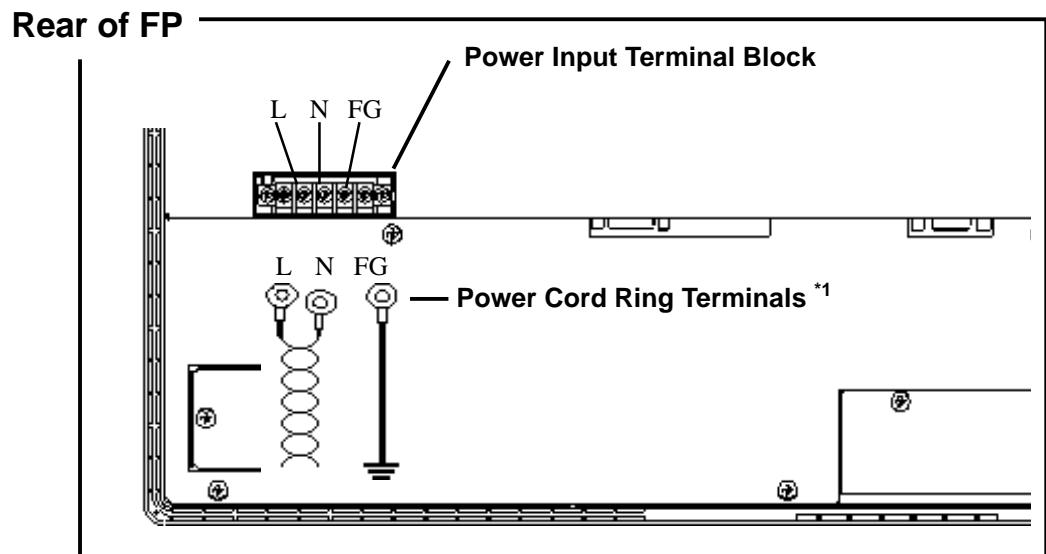

*1 L = Live line for AC power input
 N = Neutral line for AC power input
 FG = Ground terminal - to be connected to the FP housing
 Recommended ring terminal: V2-MS3 or equivalent (Manufactured by JST Co.)

Installation and Wiring

3-2-2 FP Power Cable Connection Procedure

- 1) Check to make sure the FP's power cord is disconnected from the main power supply.
- 2) Remove the terminal block's transparent cover.
- 3) Remove the screws from the 3 middle terminals, align the ring terminals and re-attach the screws. (Check that each wire is securely connected)
- 4) Replace the terminal block's transparent plastic cover.



Note: Use no more than 0.5~0.6N•m of torque to tighten the screws.

3-2-3 FP Power Supply Connection Procedures

Please pay special attention to the following points when connecting the power cord to the FP-775S's Power Input Terminal Block.

Fig. 1 - Connecting a Voltage Transformer

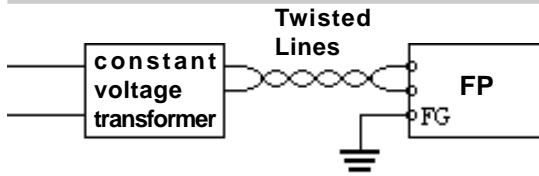

If the voltage supplied exceeds the FP's designated range, connect a voltage transformer. **Reference** Chapter 2, "Specifications", for the allowable voltage range.

Fig. 2 - Connecting an Insulating Transformer

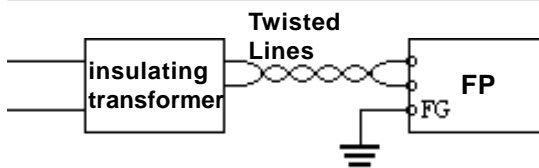

Between the line and ground, select a power supply that is low in noise. If there is an excessive amount of noise, connect an insulating (noise reducing) transformer.



Note: Use Voltage and Noise Reducing transformers with capacities in excess of 100VA.

Fig.s 3 & 4 - Separating Signal Lines

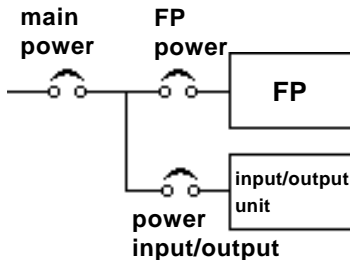

When supplying power to the FP, separate the power input/output and operation signal lines as shown in figure 3.

To increase the FP's noise resistance, twist the power cord's wire ends before connecting them to the FP.

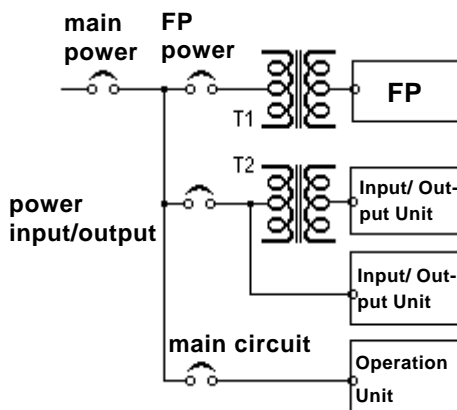

The power cord must not be bundled or kept close to the main circuit lines (high voltage, high current), or input/output signal lines.

Installation and Wiring

Fig. 5 - Connecting a Surge Absorber

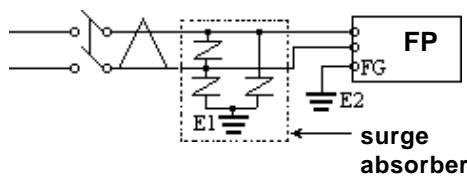

Connect a surge absorber, as shown in the diagram, to deal with power surges.

To prevent noise, make the power cord as short as possible.



Note: Be sure the surge absorber (E1) is grounded separately from the FP (E2).

Select a surge absorber that has a maximum circuit voltage greater than the power supply's peak voltage.

3-2-4 FP Grounding Cautions

Exclusive Grounding (BEST)^{*1}

Connect the FP's FG terminal to an exclusive ground.

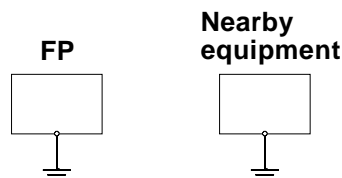

Common Grounding (OK)^{*1}

If exclusive grounding is not possible, use a common grounding point.

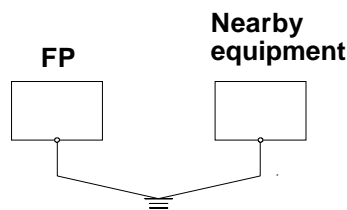

- Make the connection point as close to the FP as possible, and make the wire as short as possible. When using a long grounding wire, use a thicker wire placed in a duct.
- If the FP does not function properly when grounded this way, disconnect the ground wire from the FP's FG terminal.

Common grounding (BAD)

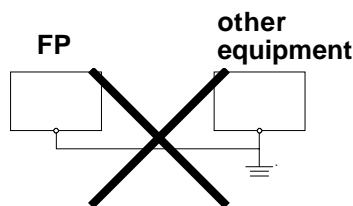

3-2-5 FP Input/Output Signal Line Cautions

- Input and output signal lines must be separated from power cables.
- If this is not possible, use a shielded cable and connect the shield to the FP chassis.

^{*1} Use a grounding resistance of less than 100Ω and a 2mm² or greater thickness wire, or your country's applicable standard. For details, contact your local FP distributor.

3-3 Setup of Operation Mode and Positioning of Display

3-3-1 Operation Mode Setup and Adjustment

The setup switches (dip-switches) are located in the rear of the FP.

FP-775S (rear view)

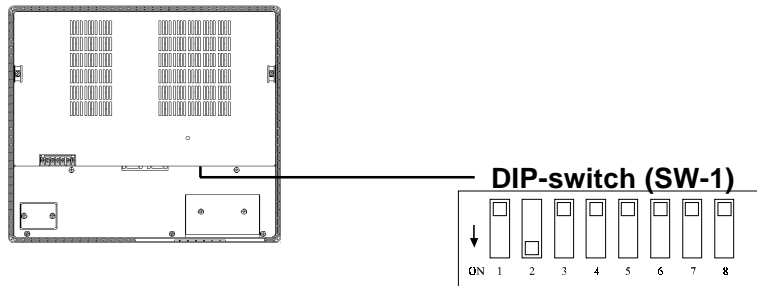

Prior to shipment, the FP's DIP switches (collectively called SW1) have been set as shown above. These 8 DIP switches control the items listed below:

No.	Function	OFF	ON
1	Touch Panel Output Method	RS-232C output	PS/2 mouse compatible output
2	Backlight Setting 1	See table on next page	
3	Backlight Setting 2		
4	Backlight Setting 3		
5	Calibration	Normal mode	Calibration mode
6	Click Sound	Click sound OFF	Click sound ON
7	Reserved	Set this switch to OFF	
8	Reserved	Set this switch to OFF	

• SW1-1

Designates the touch panel data output method.

OFF: SIO (RS-232C) output

When the FP is connected to the host (PC), emulation software (e.g TT-WIN) is required to perform touch operation.

ON: PS/2 mouse compatible output

Touch panel data is converted to PS/2 mouse-compatible format, and output through the mouse output port.

When the FP is connected to the Host's PS/2 mouse port, you can perform touch operation without using special emulation software or a special driver.



• **The use of PS/2 mouse compatible output may be limited, depending on the OS being used.**

Reference 4-2 Touch Panel Data Input

Installation and Wiring

• SW1-2, SW1-3, and SW1-4

These switches are used in various combinations to control the backlight brightness used at start-up, automatic dimming, and automatic switch-off of the backlight after 2.5 and 5 minute intervals of no SIO communication or touch panel operation.

Once SIO communication or touch operation is performed, the backlight is returned to its initial condition.

SW1-2	SW1-3	SW1-4	Brightness at start-up	After 2.5 minutes without SIO communication or touch operation	After 5 minutes without SIO communication or touch operation
OFF	OFF	OFF	Low brightness		
ON	OFF	OFF	High brightness		
OFF	ON	OFF	Low brightness	OFF	
ON	ON	OFF	High brightness	OFF	
OFF	OFF	ON	Disabled		
ON	OFF	ON	High brightness	Low brightness	
OFF	ON	ON	Disabled		
ON	ON	ON	High brightness	Low brightness	OFF



Important

• **When the FP receives a display-related SIO command from the host, the backlight's automatic brightness reduction/power-off functions are canceled.**

• **To perform simultaneous keyboard and touch panel operation, do not enable the backlight's automatic dimming/switch-off functions, since during keyboard operation these functions cannot be reactivated.**

• SW1-5

This switch is used to enable recalibration of the PS/2 mouse compatible output mode (when the SW 1-1 is ON). This feature allows the User to correct any displacement that way have developed between the screen's displayed position and the actual touch position.

Use the following steps to recalibrate the screen:

- 1) Set the SW1-5 switch to ON to start the recalibration mode. (The FP's buzzer sounds, and touch panel data output is halted)
- 2) Press the upper right corner of the display. (A)
- 3) Press the lower left corner of the display.(B)



• **In calibration mode, removing your finger from the screen will enable that position and cause a short beep to sound.**

• **When the input is incorrect (due to the procedures being performed out of order, etc.) a warning beep will sound and the unit will wait for the correct input.**

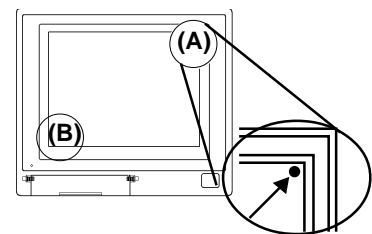

- 4) Set the SW1-5 switch to OFF to quit the recalibration mode. (The FP stores the calibration data, sounds the buzzer, and re-starts touch panel data output)



Important

The buzzer will sound continuously while the calibration data is being saved. While the buzzer is sounding, do not reset the unit or turn it OFF.

• SW1-6

This switch is used to set the FP touch panel's click sound.

When set to ON, every time the touch panel is touched in the PS/2 mouse compatible output mode (when SW 1-1 is ON), a click will sound.

• SW1-7

This switch is reserved for future system expansion.

Set this switch to OFF.

• SW1-8

This switch is reserved for future system expansion.

Set this switch to OFF.

3-3-2 Touch Panel Display Adjustment

Press both the RESET switch located in the front maintenance panel and the upper left corner of the FP display to start display adjustment mode.

In display adjustment mode, specified areas on the touch panel are used as setting switches (see the figure below). These switches can be used to adjust the dot clock phase/frequency and display position. (The following figure is a schematic view only for explanation. An actual screen will show host output data)

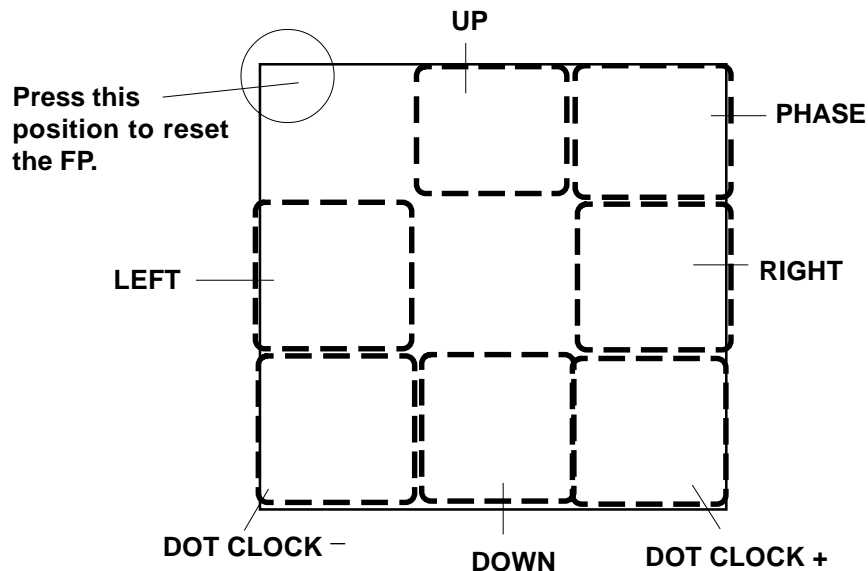

DOT CLOCK +	Adjusts the dot frequency up to compensate for flicker.
DOT CLOCK -	Adjusts dot frequency down to compensate for flicker.
UP/DOWN	
UP	Adjusts the display's position up.
DOWN	Adjusts the display's position down.
RIGHT/LEFT	
RIGHT	Adjusts the display's position to the right.
LEFT	Adjusts the display's position to the left.
PHASE	Adjusts the dot clock phase.

Installation and Wiring

To perform display adjustments, use the following procedures:

- 1) Press the RESET switch located in the front maintenance panel while touching the upper left corner of the FP display to start the display adjustment mode.
- 2) Use the setting switches to change the value of the selected item.
- 3) Press the upper left corner of the FP display again to exit the display adjustment mode.



Important

When adjustment data is being saved, the FP's buzzer will sound. Be sure to wait until the buzzer is silent before turning the FP OFF.

3-3-3 Contrast Adjustment

The FP's contrast can be adjusted via the volume adjustment slide, located inside the Front Maintenance Cover. Simply move this slide until the desired level of contrast is achieved.

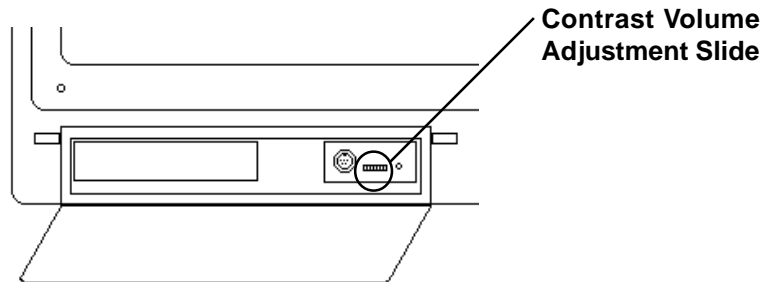

3-3-4 Color/Hue Adjustment

When the FP's color is incorrect or requires special adjustment, the color/hue level can be adjusted via the Color/Hue Adjustment Opening. Use a small, thin screwdriver to turn the knob located inside this hole, until the desired color is achieved.

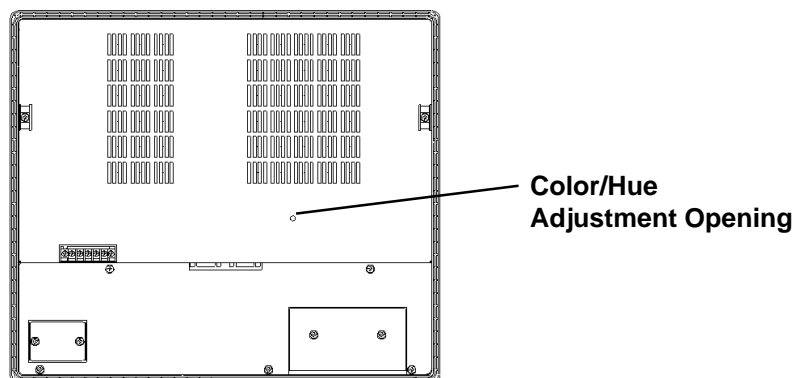

Important

Be sure to use a small ceramic or plastic type screwdriver to prevent static electricity from harming any of the FP's components, or causing a malfunction.



Note: Color/Hue flicker may be caused by the use of half-tone colors. To prevent this, try to always use only the FP's standard colors.



Chapter 4

Touch Panel Commands

1. Serial Command List
2. Touch Panel Data Input
3. Boot-up Initialization/Reset

4-1 Serial Command List

This section describes the serial commands available with the FP (command transmission from the host (PC) to the touch panel (FP)).

<Serial Command List>

Code	Function
65h	Turns on the backlight at high brightness.
66h	Turns on the backlight at low brightness.
67h	Turns off the backlight. (Automatic reset)
69h	Turns on the click sound.
6Ah	Turns off the click sound.
71h	Turns on the buzzer.
72h	Turns off the buzzer.
73h	Turns on calibration mode.
74h	Turns off calibration mode.
75h	Turns on touch panel data output.
76h	Turns off touch panel data output.



• **All codes other than those shown here are reserved. These commands should never be issued when using the FP.**



• **All data and command codes are expressed in hexadecimal numbers. (Example: 65h = 65HEX)**

Backlight ON (High brightness) 65h

Turns on the backlight at high brightness.

Backlight ON (Low brightness) 66h

Turns on the backlight at low brightness.

Touch Panel Commands

Backlight OFF (Automatic reset) 67h

Turns off the backlight. When either SIO communication or touch operation is performed, the backlight is turned on.



Note: The backlight condition after reset depends on the DIP switch settings (SW1-2, SW1-3, and SW1-4).

Click sound ON 69h

Every time you touch the display panel a click will sound.

Click sound OFF 6Ah

Turns off the click sound.

Buzzer ON 71h

Turns on the buzzer output

Buzzer OFF 72h

Turns off the buzzer output.



Note: Priority is given to buzzer output over the click sound. Thus, when both the buzzer output and click sound are set to ON, the buzzer output is activated.

Buzzer	Click	Status
ON	ON	Buzzer ON
ON	OFF	Buzzer ON
OFF	ON	Click sound ON
OFF	OFF	Buzzer and click sound OFF

Calibration mode ON 73h

Starts touch panel calibration mode. (Same function as when SW1-5 is ON.)

Calibration mode OFF 74h

Ends touch panel calibration mode. (Same function as when SW1-5 is OFF.)

Touch data ON 75h

Enables touch panel data output.

Touch data OFF 76h

Disables touch panel data output.

Touch Panel Commands

4-2 Touch Panel Data Input

Two connection methods are available for sending touch panel data from the FP to the host: an RS-232C connection and a PS/2 mouse compatible connection. This section includes instructions for creating both.

RS-232C connection (When SW1-1 is OFF)

When the touch panel is used during the RS-232C (SIO) connection mode, coordinate output data sent from the FP to the host is not exactly equal to the coordinates used on the display device. Therefore, an I/F program is necessary to convert the coordinates on the touch panel into those used on the display device. It is also necessary to calibrate individual differences, depending on the touch panel used.

The mouse emulation software listed below can automatically convert the coordinates with simple initial settings.

OS	I/F program	Calibration	Application	SW1-1 setting
Windows® 95	PL-ME000*1	Included in I/F program	i.e. FIX-32*1	OFF (RS-232C output)
WindowsNT™4.0	TT-WIN/NT*1	Included in I/F program	i.e. FIX-32*1	
Windows® 3.1	TT-WIN*1	Included in I/F program	i.e. FIX-DMACS*1	
Other OS	Prepared by user		Depending on the specifications of the program	

A separate conversion program is required for a different user-prepared OS. To create a conversion program for a different OS, please observe the following instructions:

(1) Resolution

The FP has “1024” resolution in both the X and Y axes. The origin point (0,0) is in the upper right corner.

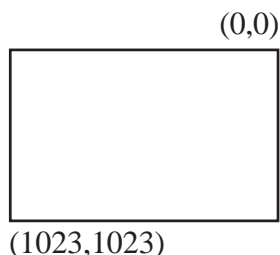

The display device however provides “1024 x 768” resolution with the origin point located in its upper left corner. Therefore, the FP's touch panel data must be converted to the actual display coordinates.

*1 The following software programs are sold separately:

- PL-ME000: Mouse simulation software for Windows 95, manufactured by the Digital Electronics Corporation
- TT-WIN: PC/AT-compatible mouse simulation software for Windows 3.1, manufactured by GUNZE LIMITED
- TT-WIN/NT: PC/AT-compatible mouse simulation software for Windows NT, manufactured by GUNZE LIMITED
- FIX-DMACS: Personal computer instrumentation package software, manufactured by INTELLUTION
- FIX-32: Personal computer instrumentation package software, manufactured by INTELLUTION

Touch Panel Commands

(2) Data Format

All data is in 8-bit ASCII format, and is structured in the following 11 byte strings.

Header: 1 byte (T = touched; R = released)
 X coordinate: 4 bytes (0000 ~ 1023)
 Separator: 1 byte (,)
 Y coordinate: 4 bytes (0000 ~ 1023)
 Termination code: 1 byte (CR = 0Dh)

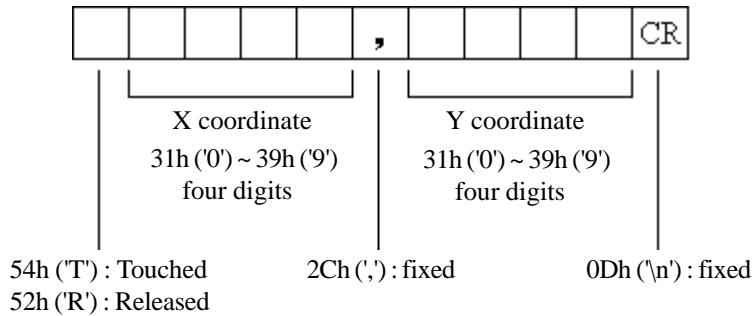

<Example> If the coordinate (X=23, Y=500) is touched.

- T0023, 0500CR — touched
 - T0023, 0500CR — continuous output at the same location
 - T0024, 0500CR — moving the finger without releasing touch
 - T0024, 0499CR
 - ⋮
 - ⋮
 - T0022, 0501CR
 - T0023, 0500CR
 - R0023, 0500CR — when released, only 1 unit of data is sent
- } continuous data output unless finger is released

(3) Sampling Rate

A maximum of 87 points per second.



- **The PL's touch panel provides a resolution of “1024” (10 bit). However, the resolution of the actual output data is only 20 to 990 (approx.). Therefore, the coordinates of the horizontal axis pixels cannot be detected.**

(4) Cable Connection

Connect the RS-232C connector provided at the rear of the FP to the host's serial interface through the optional SIO cable.

Reference Chapter 1 Introduction

Touch Panel Commands

Connecting a PS/2 mouse (When SW1-1 switch is ON)

When the FP's PS/2 mouse connection mode is selected and the User's OS supports the PS/2 mouse, touch panel data is converted to PS/2 mouse data, and output through the MOUSE/PC connector. In this case, the I/F program that converts the coordinates output from the FP to the host (PC) into the display device coordinates is not necessary.

(1) Setting up the mouse according to the current OS

Turn the FP and host (PC)'s power on, and set up your OS's mouse and driver settings so that the PS/2 mouse can be used.



- **For information about the mouse's setup procedure, refer to your OS maker's Operation manual.**

(2) Connecting the data cable

Connect the optional mouse/keyboard cable to the MOUSE/PC connector provided at the rear of the FP and to the host (PC)'s mouse connector port.



Reference Chapter 1 Introduction

(3) Connecting the mouse

The FP's touch panel can be used together with a mouse. Connect the mouse to the MOUSE/Mouse connector at the rear of the FP.



- **After connecting the mouse, re-start the FP's OS.**
- **When Windows 95 or Windows NT is used, set the "Control panel - Mouse - Operation" feature to the slowest pointer speed and hide the pointer trace.**



Important

- **Do not connect this cable when the power to the FP and the host (PC) are both ON.**
- **When a mouse is connected to the FP, it may not operate normally, depending on the combination of host (PC) and mouse used, as well as the cable length.**
- **The mouse connection can be used for all equipment conforming to the PS/2 mouse standards. However, Digital cannot guarantee the FP will operate normally for all types of host and mouse combinations. This unit was developed using the Microsoft Mouse®. Microsoft's other mouse products, the "IntelliMouse" and the "3 Button" mouse may not be used with this unit.**

Touch Panel Commands

Conditions and restrictions : Connecting a PS/2 mouse

The following conditions and restrictions apply when a PS/2 type mouse is used with the FP-775S. Due to the effect of the combination of the type of PC, mouse and OS used, the FP-775S's touch panel may not operate correctly.

- (1) Please be sure that the mouse driver used is the "Microsoft PS/2 Port Mouse". In the Windows 95/NT "Control Panel" settings area, double-click on the Mouse icon to bring up the Mouse settings. First, click on the "Motion" tab, then drag the "Pointer Speed" setting bar to the far left for the fastest movement. Next, be sure the "Pointer Trail" "Show Pointer Trail" checkbox is not checked.
- (2) The "double-click" feature should be used only for maintenance or when developing applications, due to mouse operability problems that may occur.
- (3) The following PC's may have some coordinate positioning errors.
 - When the FP-775S is connected to a PC running the Windows NT OS, if the video controller used is the S3 TRIO64 ViRGE, the touch position may be slightly skewed.

This phenomenon has been confirmed on the IBM-PC350 and the Fujitsu FMV-620T6C7 personal computers.
 - When using a laptop-type PC, or PC that utilizes both mouse and non-mouse pointing devices, or a PC that accepts "Hot Swappable" type devices, the touch position may be slightly skewed.

This phenomenon has been confirmed on the Toshiba Dynabook 440CDT, and the SONY VAIO laptop PCs.
- (4) This unit is not compatible with OS/2 PCs and devices.

Since OS/2 PCs and devices use the function is not compatible, it cannot use in this unit.

When using the FP-775S in your system, be sure to test the unit carefully with all the connected devices.

Touch Panel Commands

4-3 Boot-up Initialization/Reset

When the power is turned ON, the touch panel is initialized as follows.

- Clears its internal buffer.
- Initializes the serial communication mode.

Baud rate	9600bps
Data length	8 bits
Parity	None
Stop bit	1 bit

- Initializes the system default values.

Function	Default setting
Backlight	ON
Backlight condition	Depending on the SW1-2,3,4 settings
Click sound	Depending on the SW1-6 setting
Buzzer	OFF
Calibration mode	OFF
Touch panel data output	ON



Chapter 5

Troubleshooting

1. Troubleshooting

5-1	Troubleshooting
------------	------------------------

5-1-1 Possible Device Problems

Two possible types of trouble are as follows.

- **No display**
 - No display appears after the unit is switched on.
 - The screen disappears during RUN mode.
 - The screen display is not normal.
- **Touch Panel Does Not Respond**

The touch panel does not respond when pressed, or its response time is abnormally slow.

Troubleshooting procedures for these problems are described in the flowcharts on the following pages.

 Warning
--

- | |
|---|
| <ul style="list-style-type: none">• Because of the danger of an electric shock, be sure the power cable is not connected when wiring the unit.• When changing the backlight, since there is a danger of an electric shock or burn, be sure to turn the FP off and wear gloves. |
|---|



This section assumes that the FP is the cause of a problem, not the host (PC). When the host is the problem, please refer to that device's manual.

5-1-2 No Display

When the screen does not display when powering up, or if the screen turns OFF by itself, use the flowchart below to find an appropriate solution.

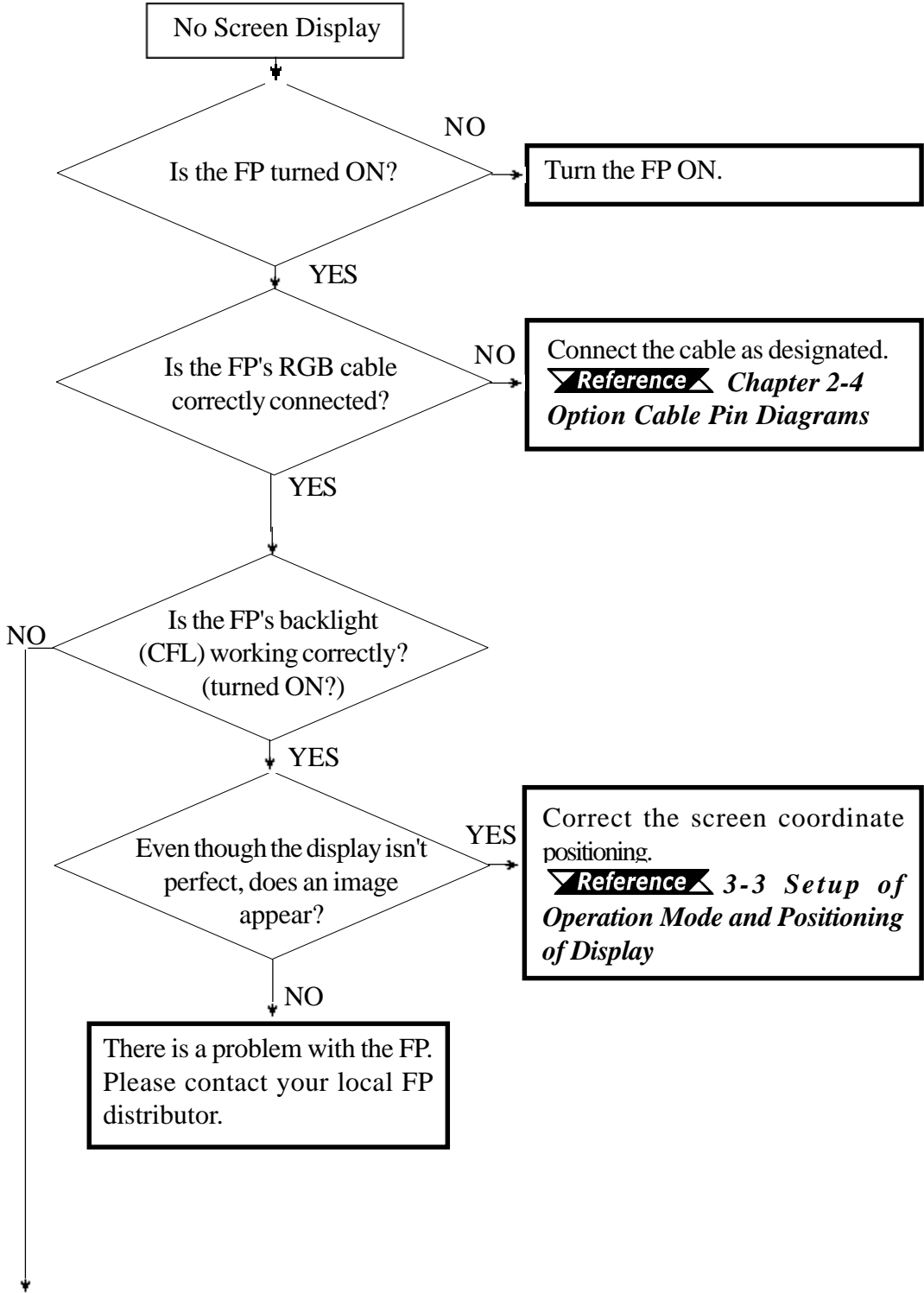

Troubleshooting

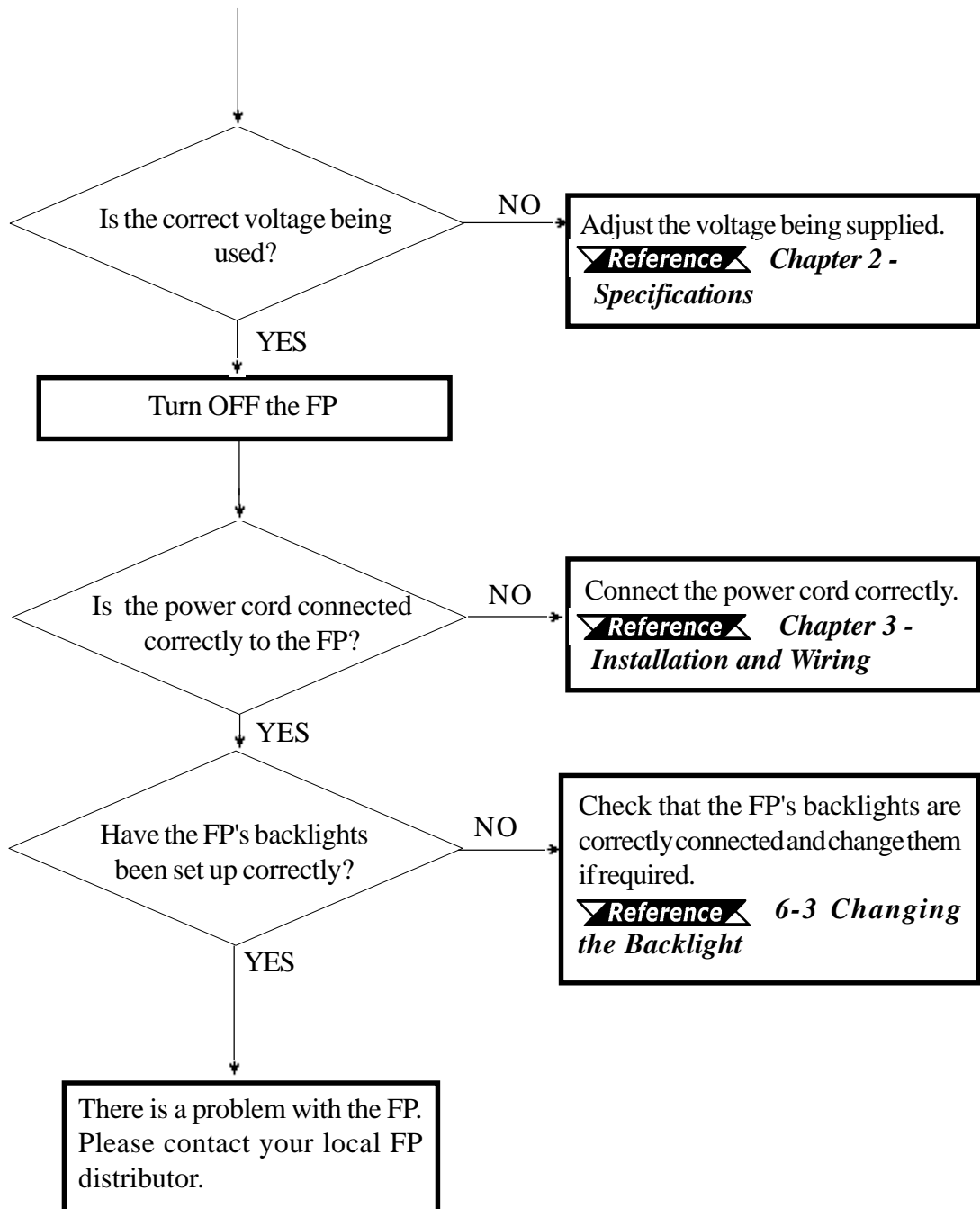

5-1-3 Touch Panel Does Not Respond

When the touch panel does not react to your touch, use the flowchart below to find the origin of the problem and the appropriate solution.



Note:

- To use the SIO connection mode, a touch panel communication program is required.
- To use the mouse connection mode, it is necessary to set up the PS/2 mouse driver included in your OS.

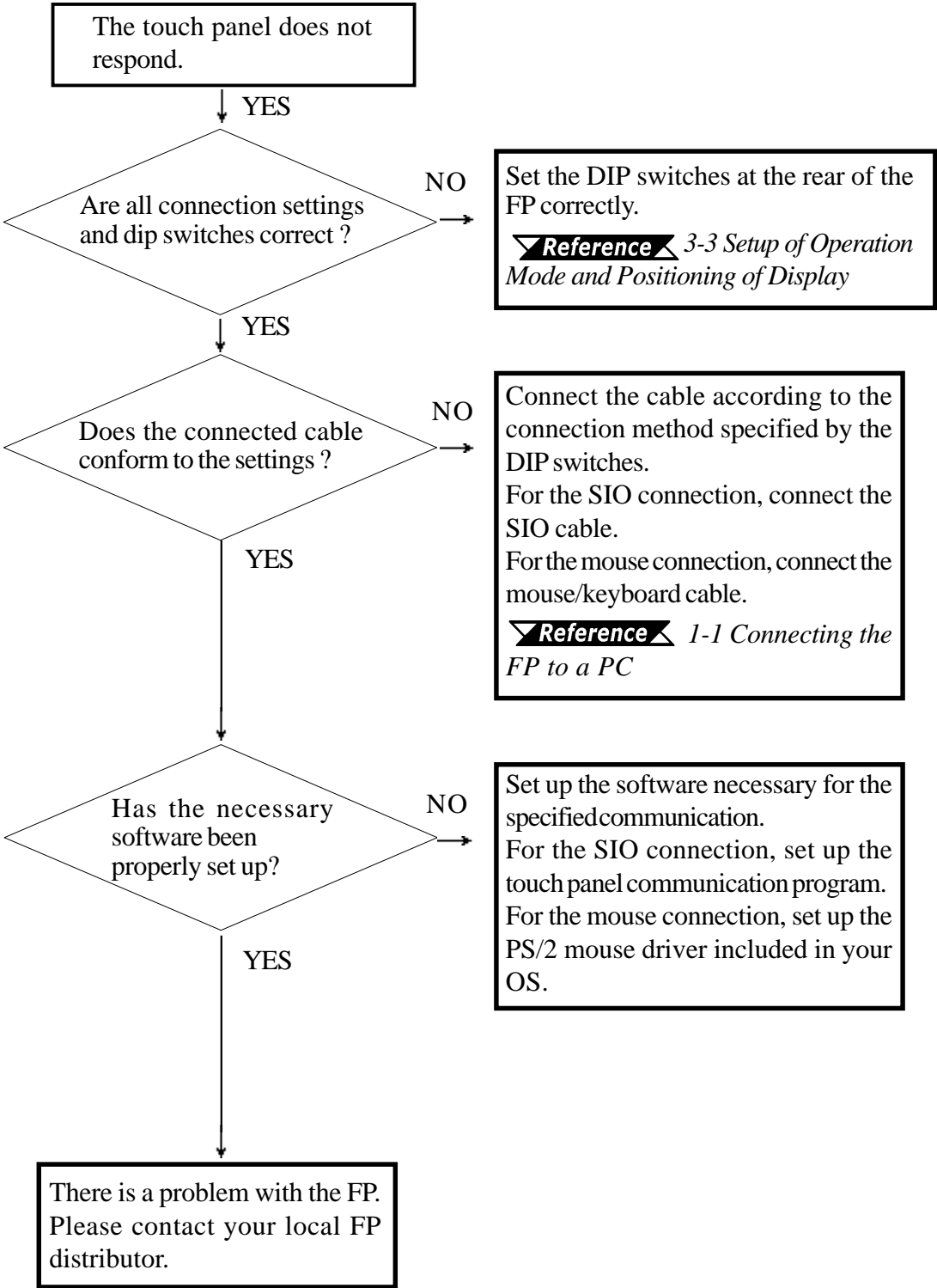

Chapter 6

Maintenance

1. **Cleaning the FP's Display**
2. **Periodic Check-up**
3. **Backlight Replacement**

This chapter describes the precautions and inspection procedures necessary to ensure satisfactory FP performance.

6-1 Cleaning the FP's Display



Neutral detergent

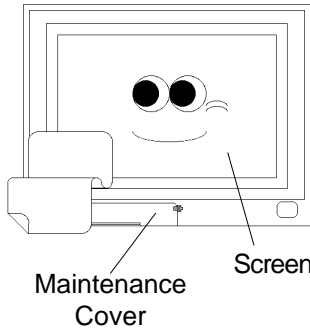

When the FP's display or case becomes dirty, use a neutral detergent applied to a damp soft cloth to clean the surface.

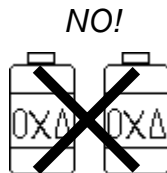

Paint thinner
Organic solvent
Acidic agents

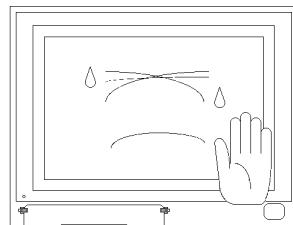

Do not use paint thinner, organic solvents, or highly-acidic agents to clean the unit.

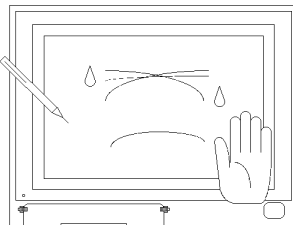

Do not press the touch panel display with sharp objects, such as a mechanical pencil; otherwise, the display may be damaged.

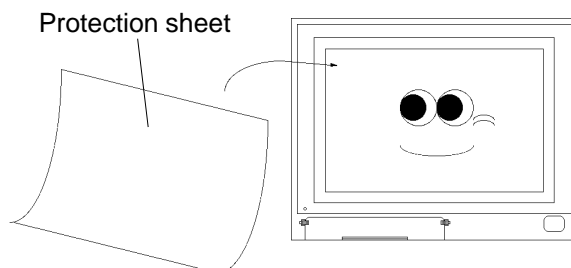

Attach the protection sheet when using the FP in a harsh environment.

6-2 Periodic Check-Up

To maintain your FP in its best condition, please check the unit periodically.

Inspection Items:

(When the FP is mounted into a cabinet, the conditions inside the cabinet are considered to be the environment)

Surrounding Environment

- Is the surrounding temperature within the allowable range? (0 to 40°C)
- Is the humidity within the specified range? (30 to 85% RH)
- Is the atmosphere free of corrosive gas?

Electrical Specifications

- Is the input voltage appropriate? (85 to 265 VAC)
- Is the power supply voltage stable ?
- Is the power supply frequency correct (50/60 Hz) ?

Attachments

- Is the cable connected properly? Is it loose?
- Are the mounting brackets holding the unit securely?
- Are there many scratches, cuts or traces of dirt on the moisture-resistant seal?

6-3 Backlight Replacement

Warning

- Whenever changing the backlight, be sure the power has been turned OFF.
- When the unit is hot, be sure to use gloves to prevent burns.
- When the unit is still ON, high voltage runs through the backlight area—*do not touch!*
- When the power has just been turned OFF, both the unit and backlight are still very hot.

Replace the backlight according to the procedure below. (The following explanation assumes that the FP has already been removed from the panel)

- ① Place the FP on a flat worktable with the front facing down.
- ② Loosen the screws at the seven positions shown on the rear of the FP, and remove the Rear Cover.

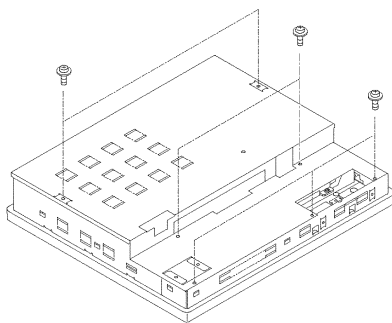

- ③ Loosen the screws at the three positions shown inside the FP, and remove the Side Bracket.

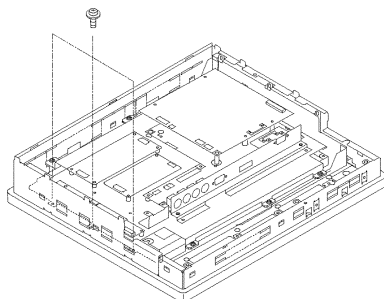

- ④ Remove the four (4) Backlight Mounting Plate attachment screws.

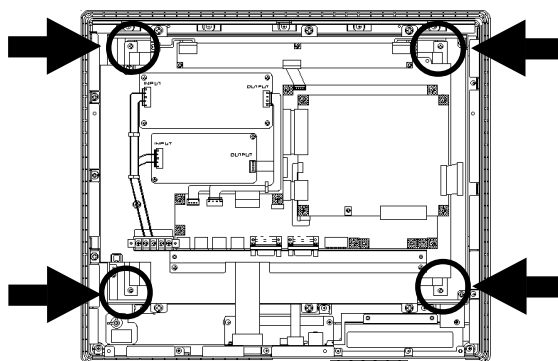

- ⑤ Remove each side's backlight power connector (top and bottom).

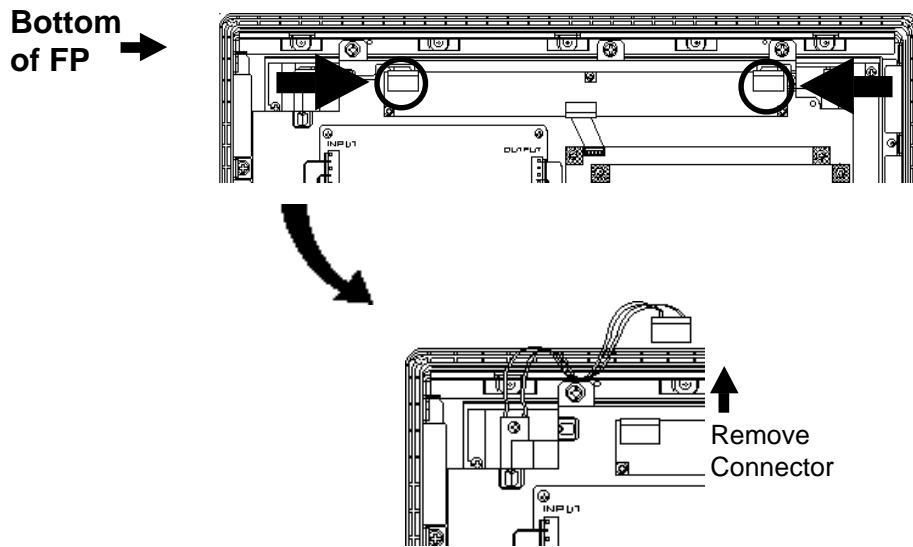

- ⑥ After removing the bottom backlight's connectors, pull out each backlight horizontally from its LCD unit holder.

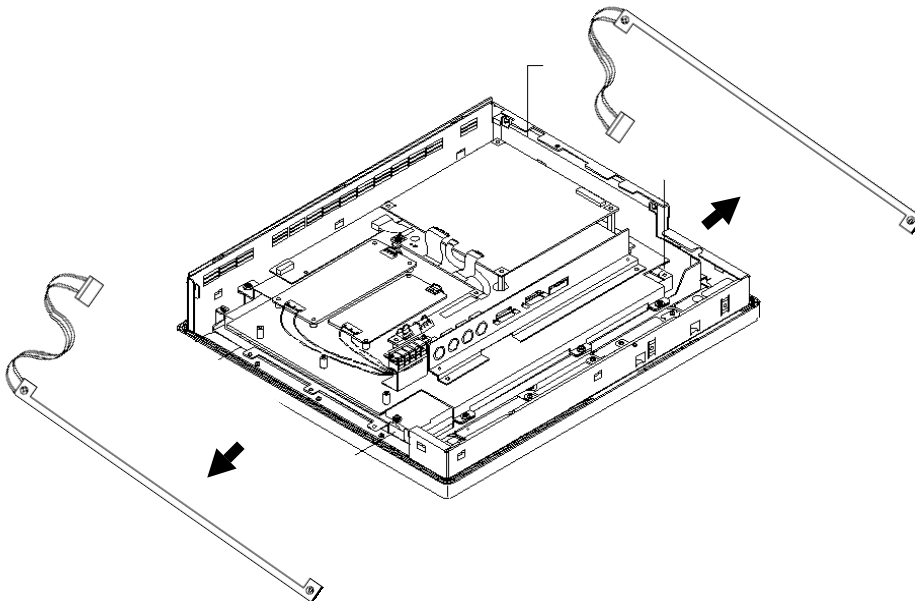

- ⑦ Insert each replacement backlight completely into its holder, and re-connect both power connectors.
- ⑧ Reattach the four (4) backlight mounting plate attachment screws.
- ⑨ Secure the Side Bracket in place with its three (3) attachment screws.
- ⑩ Secure the Rear Cover in place with its seven (7) attachment screws.

Index

Symbols

640 x 480 pixels
Features viii

A

Adjusting the Touch Panel's Display 3-9
Afterimage iii
Analog RGB
 features viii
Analog RGB Interface 2-3
Analog RGB Interface Cable 1-1
Angled Face
 Installation 3-2
Arcing 3-2
ATPH.EXE 4-3

B

Boot-up Initialization 4-2
Brightness
 conditions iii
 variations iii
Bundled Software
 Communication Programs 5-1
Buzzer 4-1
Buzzer output 4-5

C

Cable Diagrams 2-5
CALIB.EXE 4-3
Calibration mode 5-8
Calibration program 4-3, 5-1
Caution
 explanation i
Cleaning the Display
 Maintenance 7-1
Cleaning the display iii
Click sound 4-1
Color displacement 3-10
Command List 4-1
Common grounding 3-7
Connecting the FP to a PC 1-1
Contrast Volume 3-10

D

Damages
 responsibility iv
Data Format
 8-bit ASCII 4-4
Default Contrast Volume Setting 3-10
Dip switches 3-8
Disassembling the unit ii
Display coordinates 5-3
Display mode vii
Displayed color iii
Dot Clock 3-9

E

Easy Installation Features viii
Electrical shock ii
 Wiring 3-5
Electrical Specifications 2-1
Environmental Specifications 2-1
Excessively dusty or dirty environments iii
Exclusive grounding 3-7

F

FA (Factory Automation) viii
Fire (Hazard) ii
Flammable gas (environment) ii
Flat Panel (FP) Dimensions 2-8
Forced Reset 4-1
FP InstallationDimensions 2-9
FP Part Names and Functions 2-7
Functional Specifications 2-1, 2-2

G

General Specifications 2-1
GLOBAL WINDOW SETUP
 GLOBAL WINDOW 5-5
Flat Panel Display
 Auxiliary Input/Output 2-7
 FP-775S External Dimensions 2-9
 Installation Brackets 2-10
 Installation Hole Dimensions 2-10
 Names and Functions of Parts 2-8
 Power Input Terminal Block 3-4
 Serial Interface 2-7
 Ventilation 3-2
Ground wire
 Wiring 3-5
Grounding wire 3-7
Guidelines ii

H

- Header
 - Data Format 4-4
- High voltage ii

I

- I/O cover
 - Contrast Adjustment 3-10
- Infinite wait
 - Touch Panel Input 5-5
- Insertion Slot 3-3
- Inspection Items
 - Maintenance 7-2
- Installation 3-1
- Installation brackets
 - Dimensions 2-9
 - Packaging ix
- INT 59H Function List 5-5
- Interface Specifications 2-3
- Internal buffer 4-2
- IP65F standard 2-1

L

- Liquid Crystal Display (LCD) iii

M

- Main circuit
 - Wiring 3-6
- Main Menu 4-2, 4-3
- Metallic dust ii
- Mouse simulation driver 4-3

N

- Natural ventilation iii, 3-2
- No Screen Display
 - Troubleshooting 6-2
- Noise resistance
 - Wiring 3-6
- Non-Digital cable 2-3

O

- OA (Office Automation) viii
- Operating Environment
 - Oil Resistance 2-1
- Operation Mode Setup 3-8
- Optional Equipment 1-2
- Overheating 3-2

P

- Packaging
 - Contents ix
- PC Connectivity
 - Notes vii
- Periodic Check-Up
 - Maintenance 7-2
- Pin Assignments 2-3
- Possible Device Problems 6-1
- Power Cable Connection
 - Wiring 3-5
- Power Terminal
 - Wiring 3-5
- Power Terminal Block 3-5
 - Wiring 3-5
- Power Terminals 3-2
- Precautions: Grounding 3-7
- Precautions: Input/Output Signal Lines 3-7
- Precautions: Power Supply 3-6
- Printer Connection 3-1, 3-8
- Printer Interface 2-3
- Priority
 - Buzzer and Click sounds 4-6

R

- Reserved
 - Commands 4-6
- RGB Interface Cable
 - Pin connections 2-5
- Rubber gasket 3-1

S

- Safety Instructions ii
- Sampling Rate
 - Screen 4-4
- Screen display iii
- Screen display origin 4-3
- Screen flicker 3-10
- Serial communication mode 4-2
- Serial Interface 2-4
- Shielded cable
 - Wiring 3-7
- Sideways Installation 3-2
- Signal Names 2-3, 2-4
- SIO Interface Cable 1-1
- SIO transmission 3-9
- Specifications
 - Electrical 2-1
 - Environmental 2-1
 - Interface 2-3
 - Structural 2-3

Structural Specifications 2-3
Surge Absorber 3-7
Surge absorber 3-7
Switch SW1-4 2-3
Symbols i
System default values
 Initialization 4-2
SYSTEM ENVIRONMENT SETUP 5-3
 SYSTEM SETUP 5-3, 5-7
SYSTEM SETUP
 Touch Buzzer sound 5-3

T

Terminals
 Crimp On Ring 3-5
Termination code
 Data Format 4-4
TFT Color LCD viii
Touch Interface Data 4-3
Touch Panel Command 4-1
Touch Panel Commands 4-5
Touch Panel Coordinate Data 4-3
Touch panel coordinates 5-3
Touch Panel Data Calibration
 CALIB.EXE 5-7
Touch Panel Does Not Work
 Troubleshooting 6-4
Touch panel input
 Infinite Wait 5-5
 Instant Return 5-5
 Non-renewing 5-5
Touch Panel Input Drivers
 Bundled Software 5-3
Touch Panel programs
 Floppy disk ix
Troubleshooting 6-1
TT-WIN95 4-3

U

User's Manual ix

V

Vector number 5-4
Vertical Installation 3-2
VGA board vii
VGA text mode
 Right side 80 pixels 2-3
Viewing angle
 Definition 2-2
Voltage Transformer 3-6

W

Wiring 3-5
 Grounding 3-7
 Input/Output Signal Lines 3-7
 Power Cable 3-5
 Power Supply 3-6

MEMO