

Pro-face

PS-600G Series
User Manual

Preface

Thank you for purchasing a Pro-face PS-600G Series Unit (PS600G-T41-E124V), hereafter referred to as the PS-G unit.

Please read this manual carefully before installing the PS-G unit.

Important

- 1 The reproduction, copying or distribution of this equipment or its manual, either in whole or in part, without written permission from Digital Electronics Corporation is prohibited.
- 2 The information provided in this manual is subject to change without notice.
- 3 Every effort has been made to ensure the information provided in this manual is accurate. Digital Electronics Corporation would appreciate being informed of any errors or omissions.
- 4 Please be aware that Digital Electronics Corporation shall not be held liable by the user for any damages, losses or third party claims arising from the use or application of this equipment.

© 2001, Digital Electronics Corporation. All rights reserved.





Windows is a registered trademark of Microsoft Corporation.
All other trademarks and registered trademarks are property of their respective owners.

Documentation Conventions

In this manual the following warning symbols are used to indicate important points concerning safe and proper operation of the PS-G unit. Prior to operating the PS-G unit, be sure to read these points carefully.

Warning Symbols

This manual's warning symbols indicate the following levels of danger.

 WARNING	Failure to fully comply with points indicated by this symbol may result in death or serious injury.
 CAUTION	Failure to fully comply with points indicated by this symbol may result in injury or equipment damage.
	Indicates actions or procedures that should NOT be performed.
	Indicates actions or procedures that MUST be performed to ensure proper operation.









The following mark is also used in this manual.

	Refers to related information or an additional explanation.
--	---











Essential Safety Precautions

General Handling:

WARNINGS

-  Do not use the PS-G unit with aircraft control devices, aerospace equipment, central trunk data transmission (communication) devices, nuclear power control devices, or medical life support equipment, due to these devices' inherent requirements of extremely high levels of safety and reliability.
-  Do not use the PS-G unit as a warning device for critical alarms that can cause serious operator injury, machine damage or production stoppage. Critical alarm indicators and their control/activator units must be designed using stand-alone hardware and/or mechanical interlocks.
-  Do not use the PS-G unit in an environment where flammable gases are present. This may result in an explosion.
-  Do not disassemble or modify the PS-G unit in any way (except for replacing the backlight). Doing so may result in a fire or an electric shock.
-  When using the PS-G unit with transportation vehicles (trains, cars and ships), disaster and crime prevention devices, various types of safety equipment, non-life support related medical devices, etc. redundant and/or failsafe system designs should be used to ensure the proper degree of reliability and safety.
-  Please be sure to design your system so that equipment will not malfunction due to a communication fault between the PS-G and its host controller. This is to prevent any possibility of injury or damage.
-  Safety and emergency switches must be installed as separate hardware devices.
-  Do not create PS-G touch panel switches that could possibly endanger the safety of equipment and personnel. This is because damage to the PS-G, its I/O unit(s), cable(s), and other related equipment can cause an output signal to remain continuously ON or OFF and possibly cause a major accident. To prevent this type of accident, design monitoring circuits using devices such as limit switches, etc. to detect incorrect device movement. Also, to prevent accidents related to incorrect signal output, or incorrect operation, design your system so that all switches used to control vital machine operations are operated via a control system that is separate from the PS-G.

CAUTIONS

-  Do not strike the panel of the PS-G unit with a hard, heavy or pointed object, or press the panel with excessive force. Doing so may result in panel damage or injury.
-  Do not allow liquids (including water), or metal objects to enter the PS-G unit. This may result in a malfunction or an electric shock.
-  Do not block the PS-G unit's ventilation opening does not become blocked and avoid using it in areas where heat accumulates. Additionally, do not store or use it under high-temperature conditions.
-  Do not use or store the PS-G unit in locations subject to direct sunlight, or where excessive dust or dirt is present.
-  Since the PS-G unit is a precision instrument, do not store or use it where large shocks or excessive vibration can occur.
-  Do not store or use the PS-G unit in environments subject to chemical evaporation (such as that of organic solvents), or where there are chemicals and acids present in the air.
-  Do not use paint thinner or organic solvents to clean the PS-G unit.
-  Important PS-G unit screen data should be backed up regularly.
-  The installation environment for the PS-G unit must satisfy the following requirements. Failure to do so may cause the unit to malfunction.
Ambient temperature: 0°C to 50°C
Relative Humidity: 10%RH to 90%RH (Non-condensing)
-  The LCD panel contains a powerful irritant. If for any reason the panel is damaged and this liquid contacts any part of your body, wash that area with running water for 15 minutes. Similarly, if any of this liquid enters your eye, flush your eye with running water for 15 minutes and consult a physician.

During Installation:

WARNINGS

- ⊘ Do not use voltage levels other than those specified for the PS-G unit. Use of voltages outside this range may result in a fire or an electric shock.
PS600G-T41-E124V: DC 24 V \pm 20%
- ❗ To reduce wire-to-wire or wire-to-earth noise as much as possible, use a low-noise power supply. In addition, use a twisted-pair power cord.
- ❗ Separate the PS-G unit's power line from the power lines to other input/output or motor-driven devices.
- ❗ Install a surge protector to protect against power surges.
- ❗ Use a grounding resistance of 100 Ω or less, or use your country's applicable standard.
- ❗ Confirm that the main power supply is turned OFF prior to connecting the power cord terminals. Failure to do so may result in an electric shock.
- ❗ Since the PS-G is not equipped with a power switch, be sure to connect a breaker-type power switch to the power cord.
- ❗ Install the PS-G unit in a vertical position - the unit is not designed to be operated in the horizontal position.
- ❗ If the PS-G unit is to be installed in a slanted panel, the panel should not incline more than 30° from the vertical. If the panel inclines more than 30°, be sure to use forced-air cooling to ensure that the ambient operation temperature does not exceed 50°C.

During Maintenance:

WARNINGS

- ❗ Turn OFF the PS-G unit's power supply prior to performing maintenance. Failure to do so may result in burns or an electric shock.
- ❗ Wear gloves when replacing the backlight. Failure to do so may result in burns.

PS-600G Series Model Numbers

The PS-600G Series is comprised of the following models.

Series	Model	Description	International Ratings
PS-600G	PS600G-T11-J1	Preinstalled with Windows® CE 3.0 (Japanese). Input voltage AC100V.	Not supported
	PS600G-T41-J124V	Preinstalled with Windows® CE 3.0 (Japanese) Input voltage DC24V.	CE Marked, UL/c-UL (CSA) compliant.
	PS600G-T41-E124V	Preinstalled with Windows® CE 3.0 (English) Input voltage DC24V.	CE Marked, UL/c-UL (CSA) compliant.

This manual's explanation is the PS600G-T41-E124V unit.

PS-G Unit Application Software

The PS-G unit is pre-installed with the Windows® CE Operating System, which allows the PS-G unit to run customer-developed applications.

For information concerning application software development environments and software integration methods, please refer to the "PS Series Type G Application Development Kit (ADK) Developer Manual".

UL/c-UL (CSA) Approval

The PS600G-T41-E124V and PS600G-T41-J124V is a UL/c-UL listed product. (UL file No. E182139)

The PS600G-T41-E124V and PS600G-T41-J124V conforms as a product to the following standards:

- UL 508 – Industrial Control Equipment
- UL 1604 – Electrical Equipment for use in Class I and II, Division 2, or Class III Hazardous (locations).
- CAN/CSA-C22.2, No. 1010-1
MEASUREMENT AND CONTROL EQUIPMENT
(Safety requirements for electrical equipment for measurement and laboratory use)
PS600G-T41-E124V/PS600G-T41-J124V (UL Registration Model: 2880045-22)

Installation Precautions

- The PS-G unit must be used as a built-in component of an end-use product.
- The PS-G unit should be installed so that it faces out from a panel.
- If the PS-G unit will be reliant on natural cooling, be sure to install it in a vertical panel. Also, be sure that the PS-G unit is installed 100 mm away from any adjacent structures or other equipment. If these requirements are not met, the heat generated by the PS-G unit's internal components may cause the unit to fail to meet UL and C-UL (CSA) standard requirements.

UL 1604 — Compliance and Handling Cautions

1. Power and input/output wiring must be in accordance with Class I, Division 2 wiring methods – Article 501 – 4(b) of the National Electrical Code, NFPA 70 within the United States, and in accordance with Section 18-152 of the Canadian Electrical Code for units installed within Canada.
2. Suitable for use in Class I, Division 2, Groups A, B, C, and D, Hazardous Locations.
3. WARNING: Explosion hazard- substitution of components may impair compliance to Class I, Division 2.
4. WARNING: Explosion hazard – when in hazardous locations, turn the power OFF before replacing or wiring modules.
5. WARNING: Explosion hazard – confirm that the power supply has been turned OFF before disconnecting equipment, or confirm that the location is not subject to the risk of explosion.

CE Marking

The PS600G-T41-E124V and PS600G-T41-J124V is a CE marked product that conforms to EMC directives EN55011 Class A, and EN50082-2.

Package Contents

The PS-G unit comes with the following items. After opening the packing box, please confirm that the following items are included.

PS-G Unit (1)

Model Number: PS600G-T41-E124V

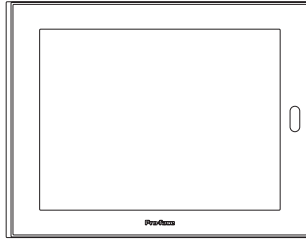

Installation Fasteners (4)

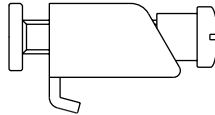

Installation Gasket (1)

(Pre-installed)



Operation Instructions (1)

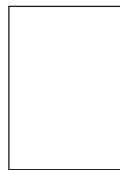

CD-ROM (1)



CD-ROM Contents

The following items are included in the CD-ROM.

Product Name	Description
PS-600G Series User Manual	PS-600G Series User Manual PDF file
Acrobat® Reader 5.0	Required for viewing PDF files (Self-extracting files)

Liquid Crystal Display (LCD) Characteristics

- Depending on the contents being displayed and the contrast settings of the PS-G unit, a wavelike pattern of varying brightness (contouring) may appear. This is not a defect.
- There are minute grid-points (dark and light) on the Display Panel's surface. This is part of the PS-G unit's design and not a defect.
- The colors on the display panel may appear to change when viewed from the side. This is a common attribute of LCDs and is not a defect.
- An afterimage may appear on the display panel after a single screen that has been displayed for many hours is changed to a different screen. The display panel will return to normal if switched off for a short period of time. This is a common attribute of LCDs and is not a defect.

To prevent afterimages:

- Use the PS-G unit's "Automatically turn off backlight" feature if you need to display the same screen for long periods.
Refer to "Chapter 3 2.2 Control Panel Settings".
- Periodically change the screen display.

For more information concerning other PS-G specifications, please contact your local Pro-face sales representative.

Backlight Burnout Precautions

After the PS-G unit's backlight burns out the screen will darken and the display will disappear. If the operator fails to notice that the backlight is burned out and touches the panel, a potentially dangerous machine operation error can occur.

WARNINGS

- ⊘ Do not use PS-G touch switches for the control of any equipment safety mechanisms, such as Emergency Stop switches, etc. that protect humans and equipment from injury and damage.

If your PS-G unit's backlight suddenly turns OFF, use the following steps to determine if the backlight has actually burned out.

- If your PS-G is not set to "Standby Mode" and the screen has gone blank, your backlight has burned out.
- Or, if your PS-G is set to Standby Mode, but touching the screen does not cause the display to reappear, your backlight has burned out.

Also, to prevent accidental machine operation, Pro-face suggests you use the built-in "Disable Input After Backlight Burnout" feature, that will automatically detect a burnout and disable the designated input devices.

Refer to "Chapter 3 2.2 Control Panel Settings".

Table of Contents

Preface	1
Documentation Conventions	2
Essential Safety Precautions	3
PS-600G Series Model Numbers	6
PS-G Unit Application Software	6
UL/c-UL (CSA) Approval	7
CE Marking	7
Package Contents	8
CD-ROM Contents	9
Liquid Crystal Display (LCD) Characteristics	10
Backlight Burnout Precautions	10
Chapter1 Introduction	
1 System Design	1-2
2 Part Names and Functions	1-4
3 Dimensions	1-8
Chapter2 Installation	
1 Installation Procedures	2-2
2 Connecting the Power Cord	2-8
3 Interface Specifications	2-10
3.1 Serial Interface	2-10
3.2 Printer Interface	2-12
3.3 Keyboard and Mouse Connections	2-13
3.4 USB Interfaces	2-14
3.5 Ethernet Interface	2-14
3.6 RAS Interface	2-15
3.7 Sound Output	2-16
3.8 CF Card Insertion and Removal	2-18
Chapter3 Start Up and Shut Down	
1 Start Up	3-2
2 Unit Settings	3-3
2.1 Dip Switch Settings	3-3
2.2 Control Panel Settings	3-4
3 Internal Application	3-11

3.1 Version Information Psgver.exe	3-11
3.2 Auto Start AutoRun.exe	3-11
3.3 Terminal Services Connection Wizard TsConWiz.exe	3-12
3.4 Applications for Pro-Designer Runtime Installation PDLload.exe/PortChanger.exe	3-14
4 Shut Down	3-14

Chapter4 Maintenance and Inspection

1 Regular Cleaning	4-2
2 Periodic Check Points	4-2
3 Replacing Consumable Items	4-3
3.1 Replacing the Installation Gasket	4-3
3.2 Replacing the Backlight	4-4

Chapter5 Troubleshooting

1 Troubleshooting Checklists	5-2
1.1 No display (Windows CE does not start)	5-3
1.2 Touch panel does not respond	5-3
1.3 Connected devices cannot be used.	5-4

Appendices

1 Specifications	A-2
1.1 Electrical	A-2
1.2 Environmental	A-2
1.3 Structural	A-3
1.4 Performance	A-4
1.5 Display	A-4
1.6 Touch Panel	A-5
2 RAS Function	A-6
2.1 Overview	A-6
2.2 RAS Function - Details	A-7
2.3 RAS Function Diagram	A-11
3 Accessories	A-12

Index

1 Introduction

- 1 System Design
- 2 Part Names and Functions
- 3 Dimensions

1 System Design

PS600G-T41-E124V

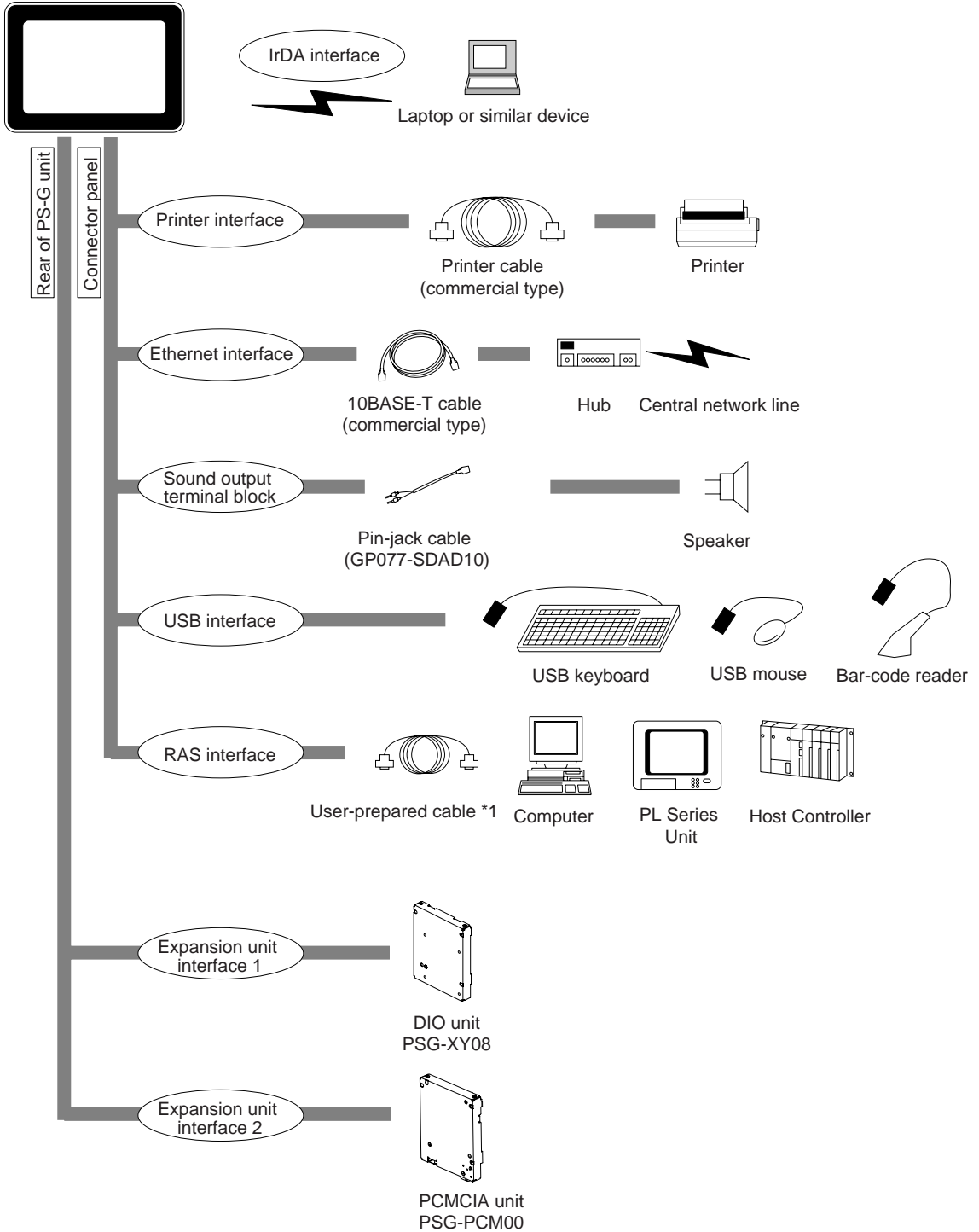

*1 Select a cable compatible with your system design. Refer to "Chapter 2 3.6 RAS Interface".

PS600G-T41-E124V

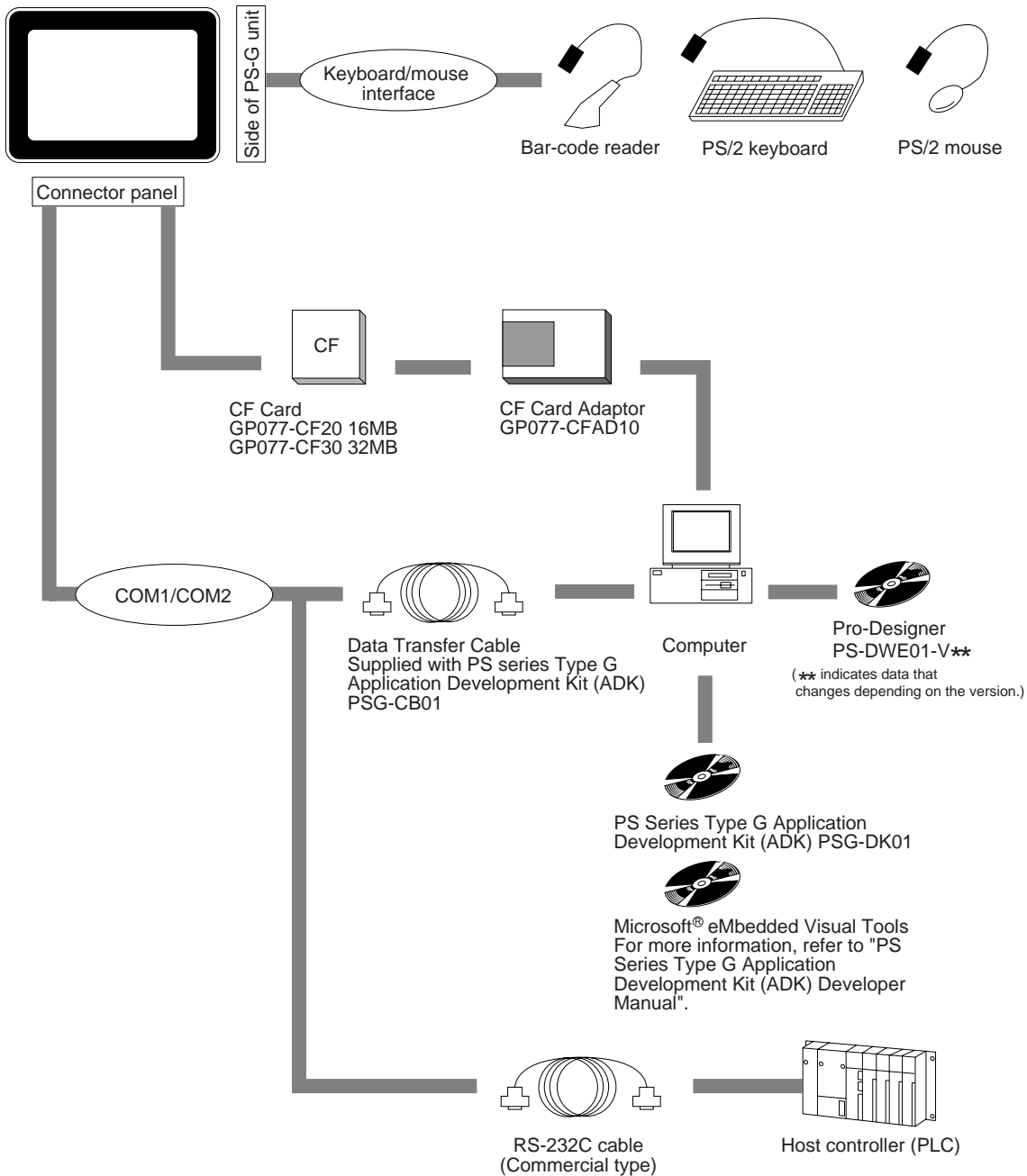

2 Part Names and Functions

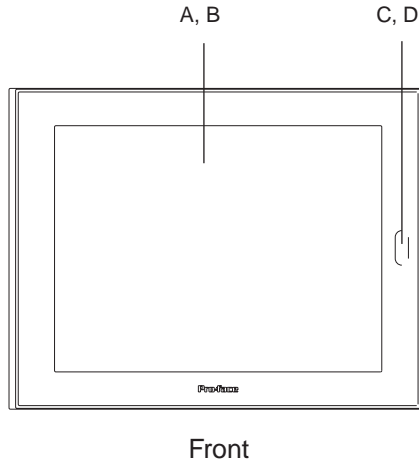

- A : Display Panel
Displays PS-G unit screen data.
- B : Touch Panel
Provides “mouse-less” screen control.
- C : Status LED
Indicates the PS-G unit’s status.
Green : Power ON/ Normal operation
At Start Up, the LED lamp changes from Red to Green
Orange : Indicates the RAS function and Backlight burnout
Red : System Error
- D : IrDA Interface
Provides infrared data transmission.

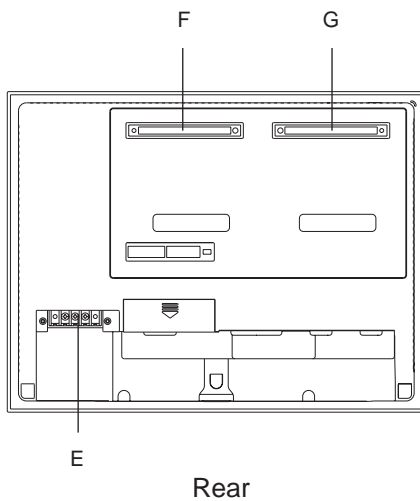

- E : Power Input Terminal Block
Connects the terminal block to the DC 24 V power source.
- F : Expansion Unit Interface 1 (EXT1)
For DIO units.
- G : Expansion Unit Interface 2 (EXT2)
This is a PCMCIA Bus interface.
For PCMCIA units.

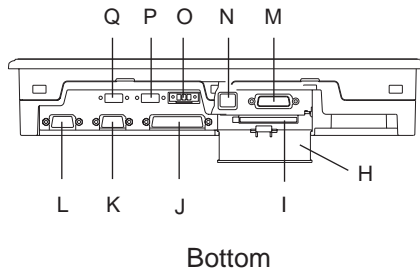

- H : CF Card Cover
Protects the CF Card slot.
- I : CF Card Slot
Accepts a standard CF Card.
- J : Printer Interface (PIO)
Connect your printer cable here. (Parallel)
- K, L : Serial Interfaces (COM1, COM2)
Connect RS-232C cables here.
- M : RAS Interface (RAS)
Connect a RAS cable here.
- N : Ethernet Interface (10BASE-T)
Connect a 10BASE-T Ethernet cable here.
- O : Sound Output Terminal Block.
Connect a speaker or line output here.
- P, Q : USB Interfaces 1 & 2 (USB1, USB2)
Connect USB (USB ver.1.0) compliant devices (keyboard, mouse, etc.) here.



Side (Left)

R : Keyboard/Mouse Interface (PS/2)
Connect a PS/2 compatible keyboard or mouse here.

3 Dimensions

PS-600G

(Unit: mm [in.])

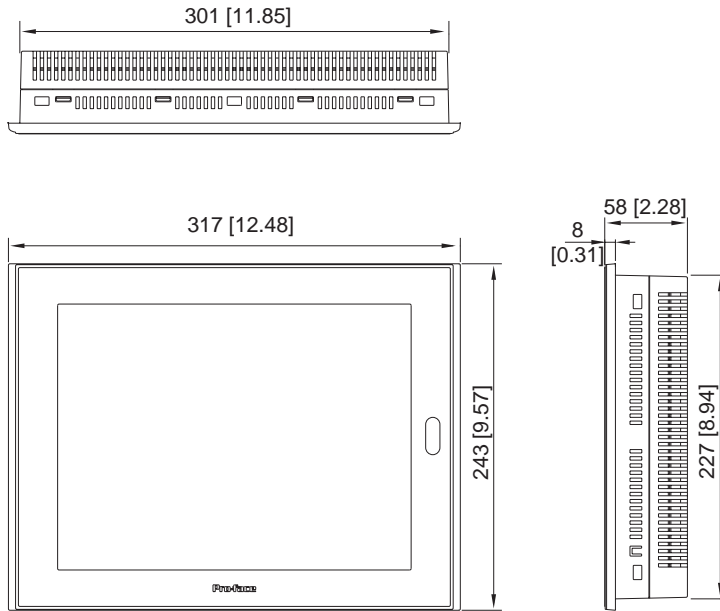

Installation Fasteners

(Unit: mm[in.])

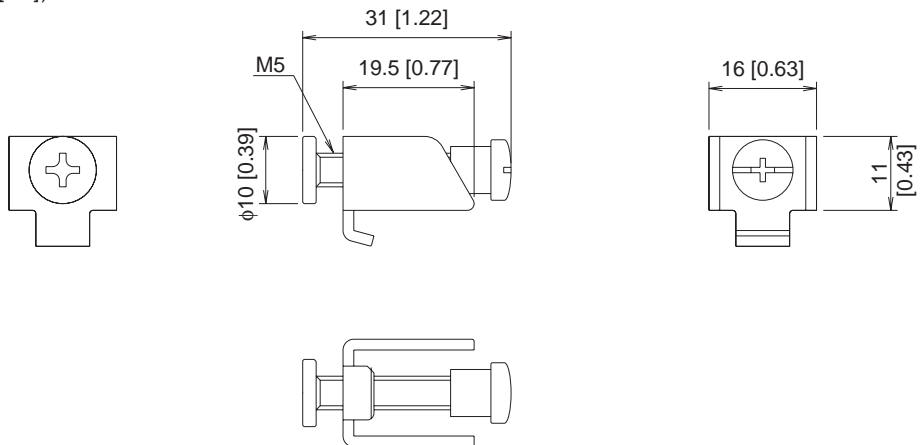

2

Installation

- 1 Installation Procedures
- 2 Connecting the Power Cord
- 3 Interface Specifications
 - 3.1 Serial Interface
 - 3.2 Printer Interface
 - 3.3 Keyboard and Mouse Connections
 - 3.4 USB Interface
 - 3.5 Ethernet Interface
 - 3.6 RAS Interface
 - 3.7 Sound Output
 - 3.8 CF Card Insertion and Removal

1 Installation Procedures

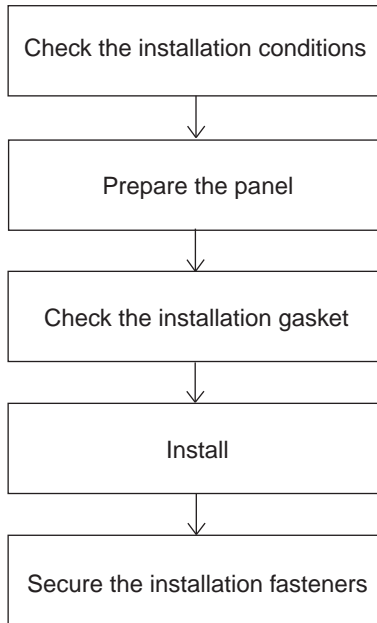

Installation Requirements

- For easier maintenance, operation, and better ventilation, the space between the PS-G unit and adjacent structures or equipment should be at least 100mm.

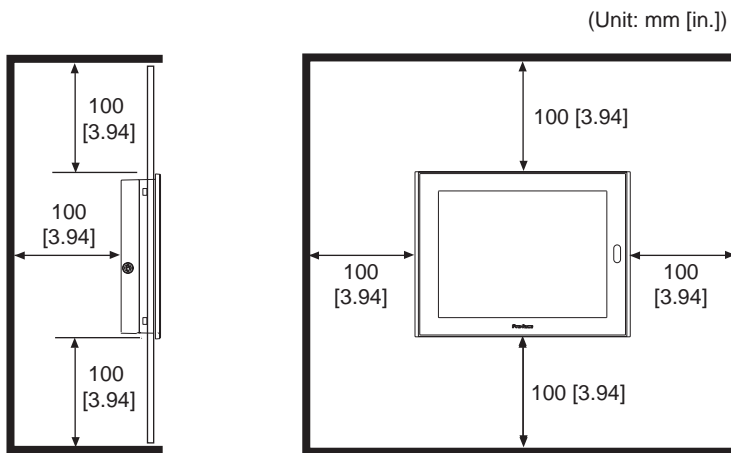

- The ambient temperature of the PS-G unit should be between 0° C and 50° C. (Ambient temperature refers to the temperatures measured in the panel interior and on the panel face.) The ambient humidity should be 10% RH to 90% RH.

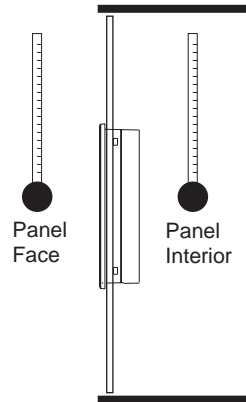

- Standard installation for the PS-G unit is in a vertical panel. If the PS-G unit is to be installed in a slanted panel, the panel should not incline more than 30° from the vertical.

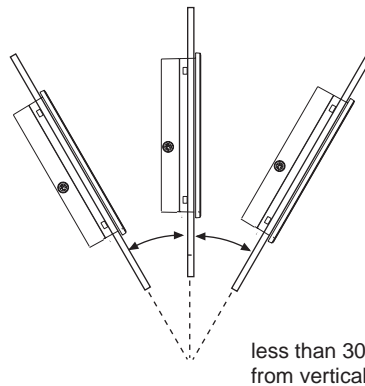

- If the PS-G panel is to be installed in a slanted panel that inclines more than 30°, use forced-air cooling to ensure the ambient operation temperature does not exceed 50° C.
- Horizontal installation (that is, rotating the panel so that one of its sides is the base) is not supported.

Panel Preparation

The thickness of the panel should be from 1.6 mm to 10 mm [0.06 in. to 0.39 in.].

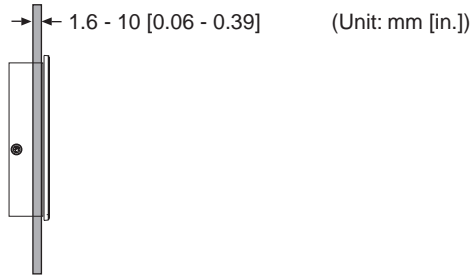

MEMO To ensure a sufficient level of water-resistance, make sure the panel is not warped, damaged, or uneven. Attaching reinforcement strips also increases the effectiveness of the PS-G unit’s installation gasket.

Panel Cut Dimensions

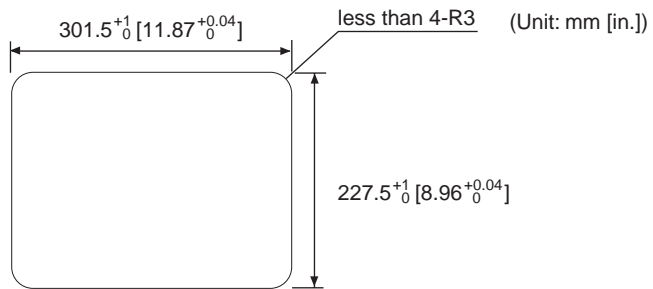

Installation Gasket

The PS-G unit should always be installed using the pre-fitted installation gasket, even at locations where water resistance is not required.

The installation gasket must be installed properly to ensure a sufficient level of water-resistance. Before installing the PS-G unit please refer to “Chapter 4 3.1 Replacing the Installation Gasket”, to confirm that the gasket is fitted properly.

Installation

Install the PS-G unit as follows:

1. Insert the PS-G unit into the cutout section of the panel with the touch screen facing outward.

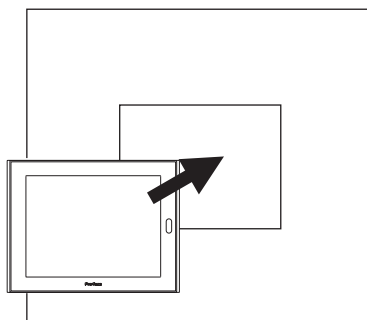

2. Insert the installation fastener hooks into the four (4) insertion slots (2 on the top and 2 on the bottom).

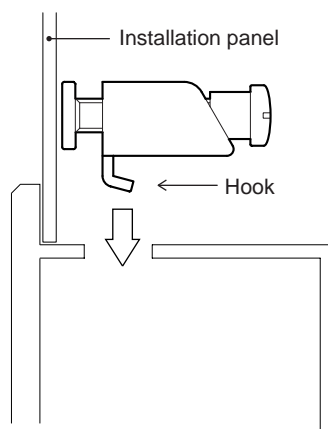
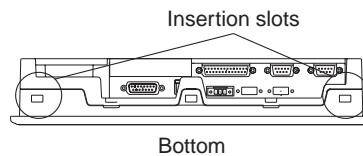
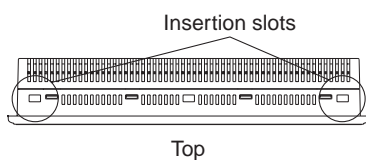

3. Slide the fastener toward the rear of the PS-G unit.

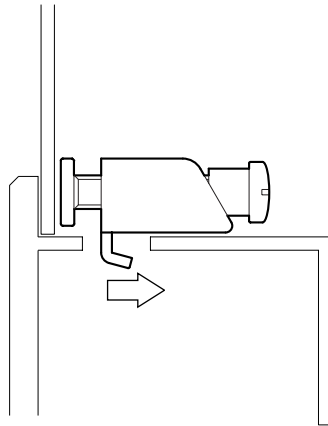

4. Slowly tighten each fastener attachment screw in sequence (top, bottom, left side, right side), until all fasteners are evenly and securely tightened. The proper torque for tightening an attachment screw is 0.5N·m

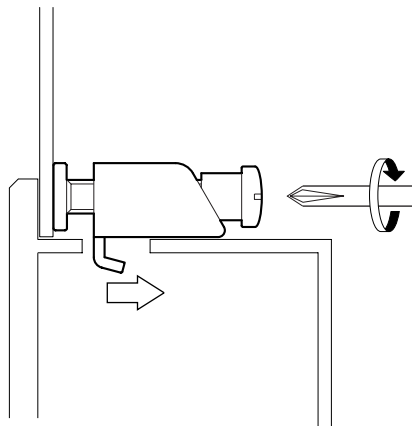

⚠ CAUTIONS

- ❗ Fastener attachment screws must be perpendicular to the panel. If they are not, the PS-G unit may fall out of the panel.
- ❗ Make sure the screws are tightened within the specified range of torque. Over-tightening the fastener attachment screws may damage the PS-G unit.

MEMO

- Depending on the strength of the panel, increasing the number of installation fasteners can increase the PS-G unit's water-resistance.

2 Connecting the Power Cord

⚠ WARNING

- ❗ Confirm that the main power supply is turned OFF prior to connecting the power cord terminals. Failure to do so may result in an electric shock.

⚠ CAUTIONS

- ❗ The power supply for the PS600G-T41-E124V should be DC24V. Supplying any other level of power can damage the PS unit or the power supply.
- ❗ Since the PS-G is not equipped with the power switch, be sure to connect a breaker-type power switch to the PS-G's power cord.

Power Cord Cautions

- To reduce wire-to-wire or wire-to-earth noise as much as possible, use a low-noise power supply.
- The PS-G unit power cords, the cables for input and output devices, and the power cords for motor-driven equipment must be located separately.
- To increase the noise resistance of the power cord's wires, twist the strands before attaching the Ring Terminals.
- The main circuit cables (high voltage and high current), the input and output signal cables, and the power cables should not be bundled together or placed near each other.
- A surge protector should be installed to protect against electrical surges.
- Power cords should be as short as possible to reduce noise.

Grounding

- Use a grounding resistance of less than 100Ω or your country's applicable standard.
- The grounding for the PS-G unit should be independent of other devices. Use exclusive grounding or a common grounding point.
- FG and SG terminals are internally connected in the PS-G. When connecting to another device, be sure to create an SG shorting loop in your system.

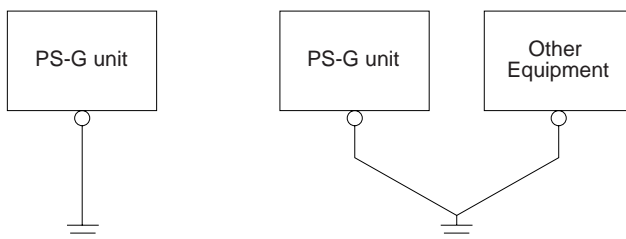

- Be sure to separate the grounding for the surge protector and for the PS-G unit.

Connecting the Power Cord

- Wherever possible, use thick wires (max. 2mm²) for the power cord. The wires should be braided together.

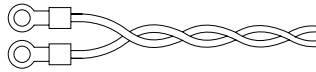

- Use the following size sleeve-type ring terminals.
Recommended sleeve-type ring terminal: V2-MS3 compatible (J.S.T. Mfg. Co., Ltd)

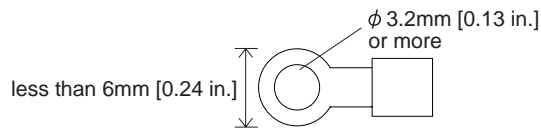

Connection Procedure

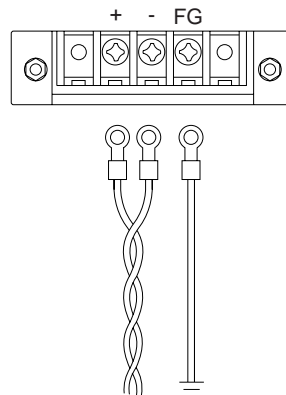

1. Confirm that the main power is OFF.
2. Remove the terminal block cover's attachment screws.
3. Remove the terminal block cover.
4. Remove the screws from the three (3) middle terminals.
5. Align the power wires (braided) and the grounding (FG) wire as shown above.
6. Reinsert and tighten the terminal screws.
(Torque should be 0.5 to 0.6 N•m)
7. Reattach the terminal block cover and tighten its screws.
(Torque should be 0.5 to 0.6 N•m)

3 Interface Specifications

3.1 Serial Interface

The PS-G unit's COM1 and COM2 interfaces are used for connecting RS-232C cables.

Pin Configuration

(Viewed from the connector face.)

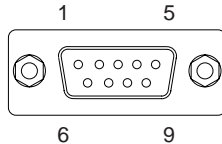

COM1

Pin Number	Signal Name	Description	Direction
1	CD	Carrier Detect	Input
2	RD (RXD)	Receive Data	Input
3	SD(TXD)	Send Data	Output
4	ER(DTR)	Data Terminal Ready	Output
5	SG	Signal Ground	-
6	DR(DSR)	Data Set Ready	Input
7	RS(RTS)	Request Send	Output
8	CS(CTS)	Clear Send	Input
9	CI(RI)	Call Indication	Input

COM2

Pin Number	Signal Name	Description	Direction
1	NC	Not Connected	-
2	RD(RXD)	Receive Data	Input
3	SD(TXD)	Send Data	Output
4	NC	Not Connected	-
5	SG	Signal Ground	-
6	NC	Not Connected	-
7	RS(RTS)	Request Send	Output
8	CS(CTS)	Clear Send	Input
9	VCC	+5V (for external supply)	-

Serial Cable

- The connector used is a Dsub 9-pin plug-type connector. Please use a Dsub 9-pin socket-type cable.
Recommended connector : Dsub 9-pin socket XM2D-0901 (Omron)
Recommended cover : For use with Dsub 9-pin sockets, XM2S-0913 (Omron)
If necessary Omron jack screws XM2Z-0073 can also be used.
Recommended cable : CO-MA-VV-5B5P-28AWG (Hitachi)
- Connect the FG line to the connector's shell.
- Use inch type attachment screws (#4-40UNC).
- The current rating for COM2, number 9 pin (DC 5 V) output is 0.20 A MAX.
- COM1 and COM2, number 5 pin (SG) connections should always be to the SG terminal.
- FG and SG terminals are internally connected in the PS-G. When connecting to another device, be sure to create an SG shorting loop in your system.

3.2 Printer Interface

The PS-G unit uses a parallel interface.

MEMO The Windows CE printer driver is HP-PCL command compliant.

Pin Configuration

(Viewed from the connector face.)

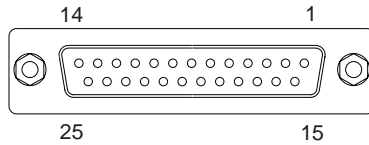

Pin Number	Signal Name	Description	Direction
1	PSTB	Strobe Signal	Output
2	PDB0	8-bit Data	Input/Output
3	PDB1		Input/Output
4	PDB2		Input/Output
5	PDB3		Input/Output
6	PDB4		Input/Output
7	PDB5		Input/Output
8	PDB6		Input/Output
9	PDB7		Input/Output
10	ACK	Acknowledge	Input
11	BUSY	Busy Signal	Input
12	PE	Paper End	Input
13	SLCT	Select Status	Input
14	AF	Auto Feed	Output
15	ERROR	Printer Error	Input
16	INIT	Initialize Signal	Output
17	SLCTIN	Select Signal	Input
18	GND	Ground	-
19	GND	Ground	-
20	GND	Ground	-
21	GND	Ground	-
22	GND	Ground	-
23	GND	Ground	-
24	GND	Ground	-
25	GND	Ground	-

Printer Cable

- Use a Dsub 25-pin socket-type connector and a Dsub 25-pin plug-type cable.
Recommended connector : Dsub 25-pin plug XM2A-2501 (Omron)
Recommended cover : Standard cover for Dsub 25-pin plugs, XM2S-2513 (Omron)
If necessary, Omron jack screws XM2Z-0073 can also be used.
- Connect the FG cable to the shell.
- Use inch type attachment screws (#4-40UNC)

3.3 Keyboard and Mouse Connections

Pin Configuration

(Viewed from the connector face.)

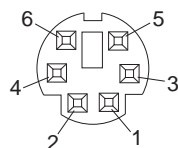

Pin Number	Signal Name	Description	Direction
1	KEY DATA	Key Data	Input/Output
2	MOUSE DATA	Mouse Data	Input/Output
3	GND	Ground	-
4	VCC	+5V	-
5	KEY CLK	Key Clock	Input/Output
6	MOUSE CLK	Mouse Clock	Input/Output

Keyboard and Mouse Type

Please use a PS/2 (mini-DIN)-type keyboard or mouse.

3.4 USB Interfaces

Any commercial type USB device can be used.
(USB ver1.0)

Pin Configuration

USB1 and USB2 use the same pin configuration.

Cables

Any commercial type USB interface cable can be used.

MEMO

Certain types of USB compatible keyboards, when attached to the PS-G via the USB interface, may fail to operate correctly. Therefore, prior to using this type keyboard, be sure to check that it operates correctly. Currently, the following USB keyboard has been tested by Pro-face.

- Microsoft Corporation Natural® keyboard Pro

However, the, Microsoft Corporation's Natural® Keyboard Pro's "PS/2 keyboard" feature, and the "extended key" feature cannot be used.

3.5 Ethernet Interface

The PS-G unit's Ethernet (10BASE-T) interface conforms to IEEE802.3 standards.

Pin Configuration

Use a RJ-45 type modular jack connector.

Cable Type

Any commercial type Ethernet (10BASE-T) cable can be used.

3.6 RAS Interface

For more information concerning the RAS function, refer to “Appendix 2 RAS Function”.

Pin Configuration

(Viewed from the connector face.)

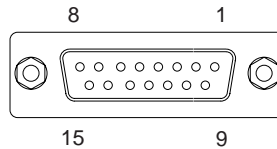

Pin Number	Signal name	Description
1	ALARM-OUT (-)	Alarm Output (-)
2	DOUT (-)	General-purpose Output (-)
3	RESET-IN (-)	Remote Reset Input (-)
4	DIN0 (-)	General-purpose Input 0 (-) *1
5	DIN1 (-)	General-purpose Input 1 (-) *1
6	NC	No Connection
7	RESERVE	Reserved
8	RESERVE	Reserved
9	ALARM-OUT (+)	Alarm Output (+)
10	DOUT (+)	General-purpose Output (+)
11	RESET-IN (+)	Remote Reset Input (+)
12	DIN0 (+)	General-purpose Input 0 (+) *1
13	DIN1 (+)	General-purpose Input 1 (+) *1
14	RESERVE	Reserved
15	RESERVE	Reserved

RAS Cable

- Use a Dsub 15-pin socket-type connector and a Dsub 15-pin plug-type cable.
 Recommended connector : Dsub 15-pin plug XM2A-1501 (Omron)
 Recommended cover : Standard cover for Dsub 15-pin plugs, XM2S-1513 (Omron)
 If necessary, Omron jack screws XM2Z-0073 can also be used.
- Connect the FG cable to the shell.
- Use inch type attachment screws (#4-40UNC).

*1 General-purpose Input will latch Input Information

3.7 Sound Output

Either line output or speaker lines can be attached to this connector.

Pin-Jack Cable Pin Assignments

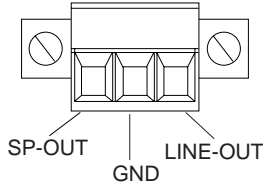

Signal Name	Description	Direction
SP-OUT	Speaker Output	Output
GND	Ground	-
LINE-OUT	Line Output	Output

Sound Output Cable

The following example connects a speaker to the PS-G unit using a Pro-face pin-jack cable (GP077-SDAD10). The procedure for connecting a Line Output cable is the same, however a separate amplifier will be required.

Connection Procedure

- 1) Check that the PS-G power cord is disconnected.
- 2) Loosen the terminal block attachment screws and remove the terminal block.

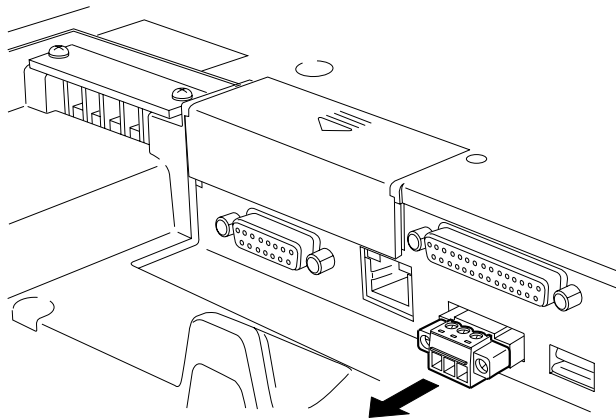

- 3) Loosen the set screw of each terminal outlet to be used (as shown below).

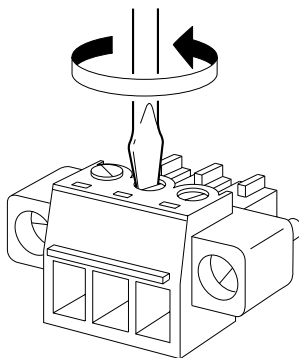

- 4) Insert each pin-jack cable pin into its corresponding outlet.

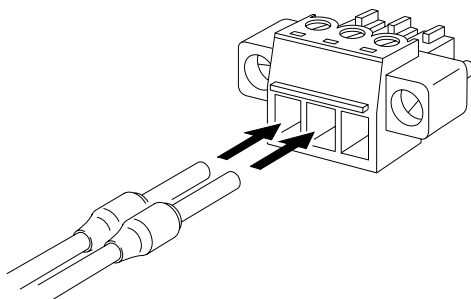

- 5) Re-tighten each set screw.

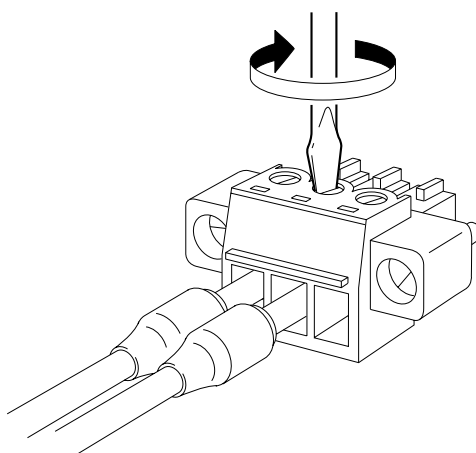

- 6) Reinsert the terminal block.

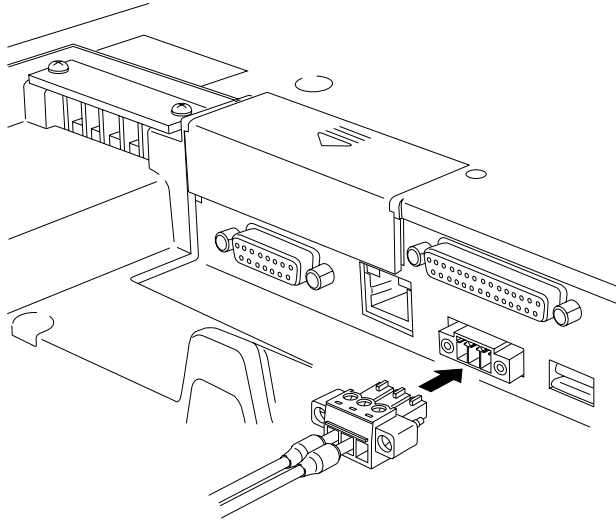

- 7) Tighten the terminal block attachment screws.
- 8) Connect the other end of the pin-jack cable to the speaker.

3.8 CF Card Insertion and Removal

Here we will explain the methods for inserting and removing a CF Card.

⚠ CAUTIONS

- ⊘ While the CF Card is being accessed, do not turn OFF the power to the PS-G unit, perform remote reset input, or remove the CF Card.
- ⚠ Prior to inserting the CF Card, carefully check the orientation of the CF Card and the connector. Incorrect CF Card orientation may damage the CF Card or destroy its data.

- MEMO**
- Use only Pro-face CF Cards. Other vendor CF Cards may fail to meet PS-G specifications.
 - Be sure to backup your CF Card data regularly.

Inserting a CF Card

- 1) Push the cover in the direction indicated by the ▼, and lift it open.

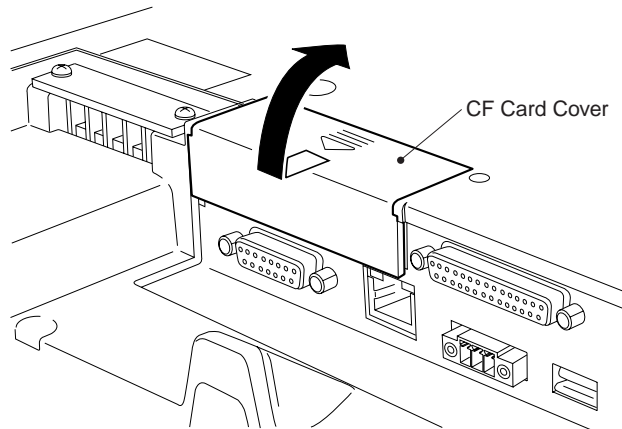

- 2) Check the orientation of the CF Card before inserting it into the CF Card slot. Insert the CF Card until the Eject Button pops forward.

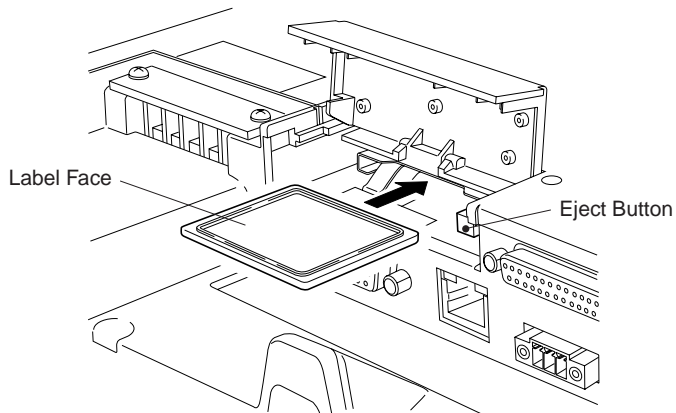

- 3) Close the CF Card cover, then push it in the direction shown by the ▼, until it clicks shut.

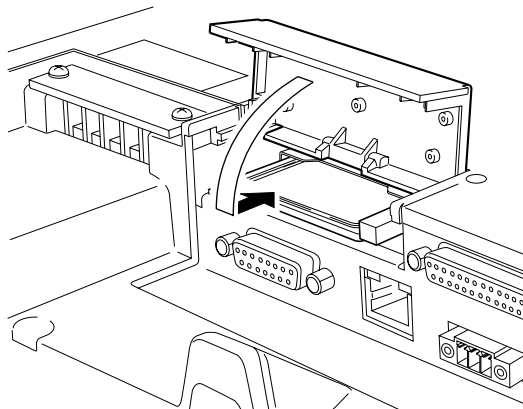

Removing a CF Card

- 1) Push the cover in the direction indicated by the ▼, and lift it open.

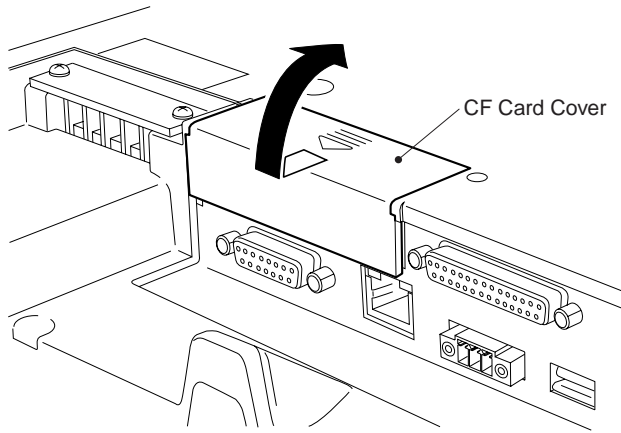

- 2) Push the Eject Button until the CF Card pops forward.

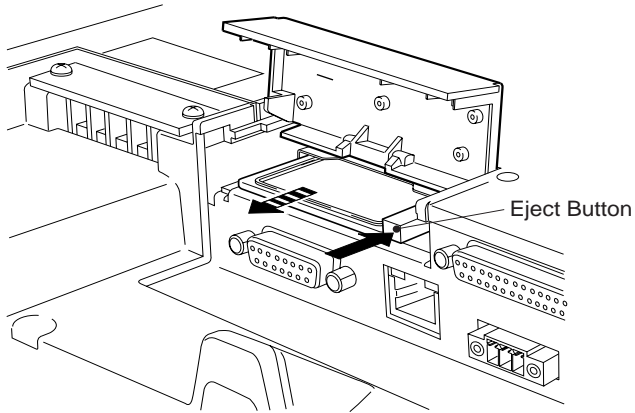

- 3) Close the CF Card cover, then push it in the direction shown by the ▼ until it clicks shut.

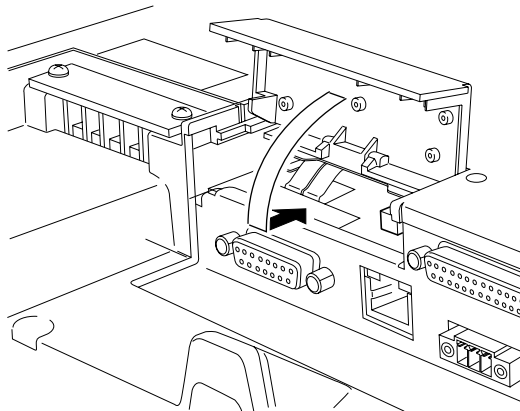

3

Start Up and Shut Down

- 1 Start Up
- 2 Unit Settings
 - 2.1 Dip Switch Settings
 - 2.2 Control Panel Settings
- 3 Internal Application
 - 3.1 Version Information Psgver.exe
 - 3.2 Auto Start AutoRun.exe
 - 3.3 Terminal Services Connection Wizard
TsConWiz.exe
 - 3.4 Applications for Pro-Designer Runtime Installation
PDLoad.exe/PortChanger.exe
- 4 Shut Down

1 Start Up

When the PS-G unit's power is turned ON, Windows CE starts up automatically.

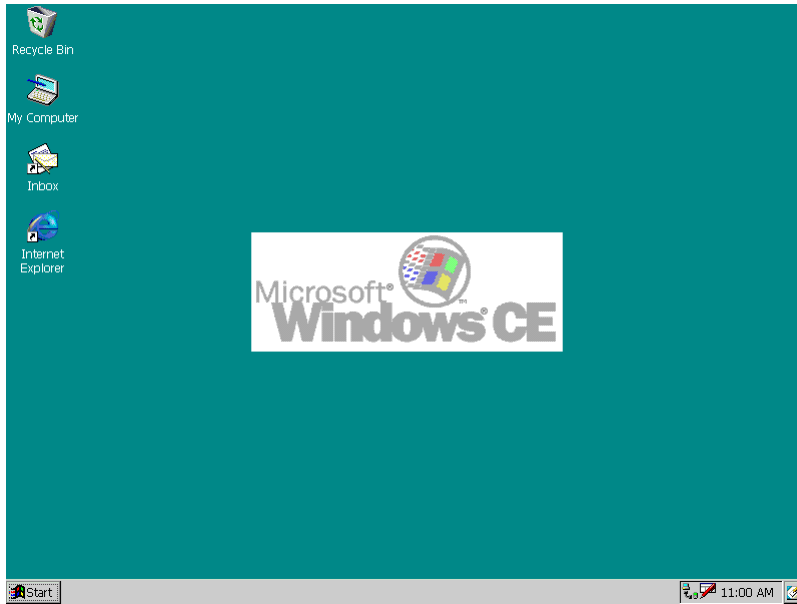

MEMO

- To restart the PS-G unit, turn the power OFF, wait about 5 seconds, then turn the power ON again. Occasionally, the PS-G unit will not start up correctly.
- When data has been backed up to a CF Card on a PS-G unit running the new OS-ROM (Ver.2.02), that CF Card should not be used to start up a PS-G unit running an older version of the OS-ROM. Doing so could cause a malfunction.
Refer to "3.1 Version Information Psgver.exe"

2 Unit Settings

2.1 Dip Switch Settings

The Dip Switches are located inside the CF Card cover.

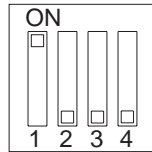

Switch Number	Description
1 - 4	Reserved

The PS-G unit's factory settings are:

Dip switch No. 1 : ON

Dip switches No. 2 to 4 : OFF

Normally, these settings should not be changed.

2.2 Control Panel Settings

PS-G unit settings can be changed via the “Control panel”.

Panel display procedure

- 1) Click on the [Start] button.
- 2) From the [Start] menu that appears, select [Settings].
- 3) From the [Settings] menu, select [Control Panel].

The Control Panel contains the following icons.

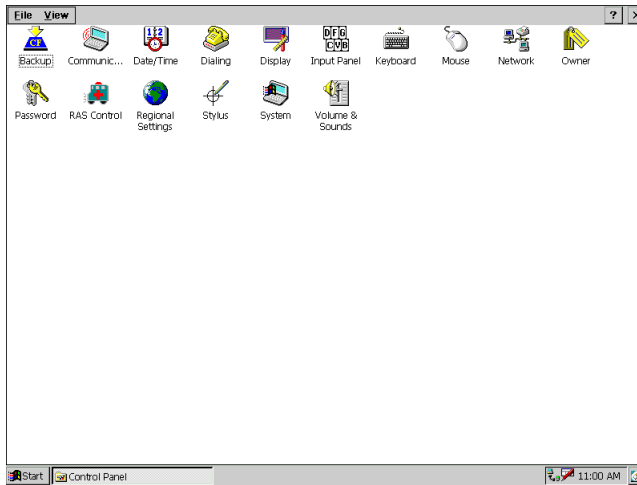

Backup
Communications
Date/Time
Dialing
Display
Input Panel
Keyboard
Mouse
Network
Owner
Password
RAS Control
Regional Settings
Stylus
System
Volume & Sounds

The following explanations describe the Stylus, Backlight (accessible via the [Display] icon), Backup, RAS Control, and Volume and Sounds programs.
For detailed information on other programs, refer to the PS-G unit's [Help] screen.

MEMO

- To display the [Help] screen, click the [Start] button and select [Help]. You can also click the [?] mark in any program's dialog box.
- All Control Panel settings revert to factory settings when the PS-G unit's power cord is disconnected. If you want to save any setting changes, use the Control Panel's "Backup" feature to save these changes to the CF Card.

Stylus

This program calibrates the touch panel.

Calibration Procedure

- 1) Double click on the [Stylus] icon (Control Panel).
- 2) Select the [Calibration] tab.
- 3) Click the [Recalibrate] button.
- 4) Click on and hold the + mark that appears at the center of the screen. When the coordinates are recognized, the + mark will move in order from the center to the top left, bottom left, bottom right, and top right. Click on and hold the + mark at each point.

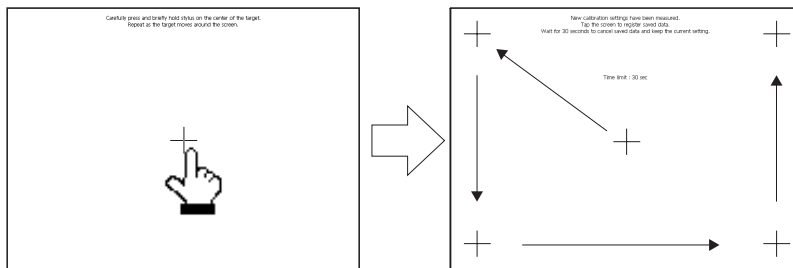

Backlight

This program adjusts the Backlight settings.

- **Set Brightness**
The backlight can be set to any of 4 levels of brightness.
- **Disable Input After Backlight Burnout**
This setting either enables or disables signals from input devices (touch panel, keyboard, mouse). If set to “disable”, input signals from designated devices will not be accepted when a backlight burnout is detected. This helps to prevent accidental operation of the PS-G unit. The factory setting is for all input devices to be disabled when a backlight burnout occurs (Checkbox ON).

MEMO

- Certain types of backlight failures may not be able to be detected. This is because backlight burnout is detected by monitoring the PS-G unit’s power consumption.
 - When backlight burnout occurs, the panel’s status LED lamp will turn orange. Then, a dialog box indicating that backlight burnout has occurred will appear on the screen.
- **Automatically turn off backlight**
Standby Mode helps to extend the PS-G unit’s backlight lifetime by automatically switching the backlight OFF after a set period of idle time. Idle time is when there is no input via the touch panel, keyboard or mouse. The factory setting for this feature is OFF (Checkbox OFF).

Backlight Settings - Adjustment Procedure

- 1) Double click the Control Panel’s [Screen] icon.
- 2) Select the [Backlight] tab.

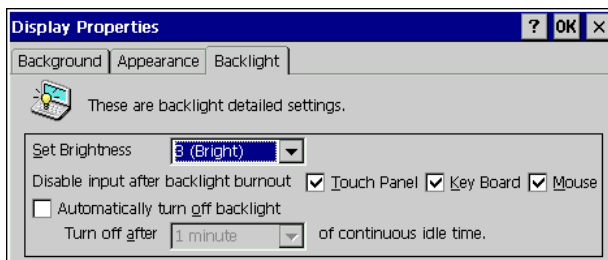

- 3) Select the required level of brightness.
- 4) Select the devices to be deactivated in case of backlight burnout.
- 5) Set Standby Mode to either ON or OFF. If you select ON, you will also need to specify the desired period of idle time.

Backup

Changes made to the Object Store*¹ by your application software or via Control Panel settings can be backed up to a CF Card. However, the files that can be backed up are limited to those in the [ProgramFiles] folder, [Windows] folder, and Registry settings.

All other files cannot be backed up to a CF Card.

When a CF Card with setting data is reinserted into the PS-G Unit, the setting data will be read automatically at Start Up and the Object Store will be restored.

Backup Procedure

- 1) Double click the [Backup] icon on the Control Panel.
- 2) Insert the CF Card.
- 3) Click the [Backup] button and the Object Store data will be backed up to the CF Card.



MEMO

When data has been backed up to a CF Card on a PS-G unit running the new OS-ROM (Ver.2.02), prior to backing up data to the card using a PS-G unit running an older version of the OS-ROM, be sure to use Explorer to delete the CF Card's [Strage Card1] folder's [_Backup_] folder. Refer to "3.1 Version Information Psgver.exe"

*1 Object Store refers to a memory storage area that is used to save settings.

RAS Control

The RAS Control Properties area is used to enable the following RAS functions. Each condition is monitored, and system alarms and standard signal input are detected via the RAS function settings.

The following settings are available.

- Watchdog Timer settings — enable, disable, and timer settings (5 sec. to 255 sec.)
- Receive Standard Signal Input — Enable/Disable
- Remote Reset Input — Enable/Disable

The Watchdog Timer’s counter is activated by user applications that perform counter Start, Stop, and Restart commands. Applications that periodically restart counters should be designed in accordance with API-DLL specifications. For more information, refer to the “PS Series Type G Application Development Kit (ADK) Developer Manual”.

The following settings are available for Watchdog Timeouts, Standard Signal Input, and Remote Reset Input.

	Alarm Out	Buzzer	Pop-up Message	Reset	DOUT
Watchdog Timer	O	O	O	O*1	X
External Input Signals 0,1	O	O	O	X	O
Remote Reset	X	X	X	O*1	X

- O : Setting possible
- X : Setting not possible

Alarm Out	Outputs an alarm signal
Buzzer	Outputs a buzzer signal
Pop-up Message	Displays Pop-up Messages on the PS-G Unit
Reset	Resets the PS-G unit
DOUT	Outputs external signals

*1 Using a Watchdog Timer “Timeout” command to perform a Reset will cause the PS-G unit to reboot. Exceeding “Reset” with a Remote Reset Input Signal will reset the PS-G unit hardware.

Set Up Procedure

- 1) Double click the Control Panel's [RAS Control] icon in the Control Panel.
- 2) Click the [Watchdog Timer] tab and select Enable or Disable. If you select Enable you will also have to set the timer period (5 sec. to 255 sec.) and specify the actions required after a timeout.

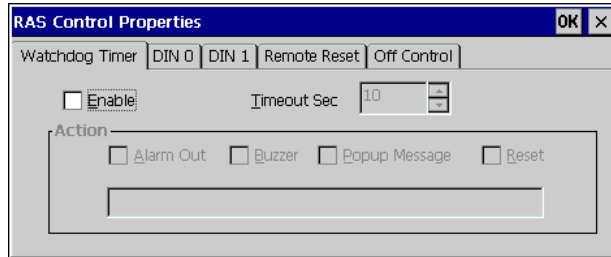

- 3) Select the [Din 0] tab and the [Din 1] tab to enable or disable standard signal input. If you enable standard signal input you will also have to specify the actions performed when an standard signal is received.

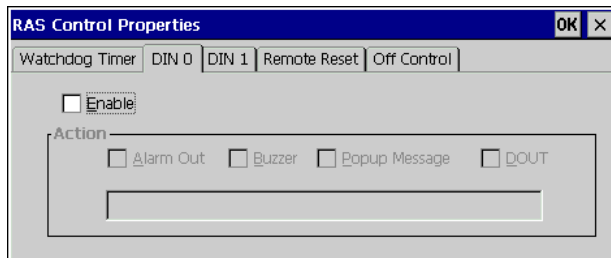

- 4) Select the [Remote Reset] tab to enable or disable Remote Reset Input.

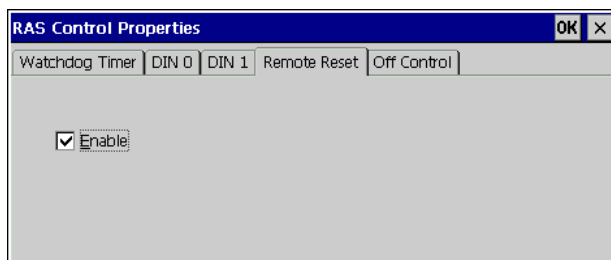
**MEMO**

Use the [Off Control] tab to turn OFF the alarm features set in RAS Control. To turn a feature OFF, simply click on that feature's OFF button.

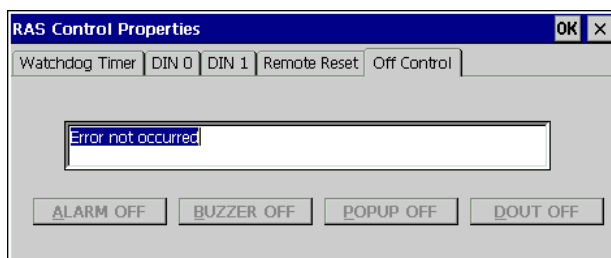

Volume & Sounds

This setting either enables or disables the buzzer sound used when the screen is touched. The factory setting is for the buzzer to be enabled (Checkbox ON).

Volume & Sounds Setting Procedure

- 1) Double click the [Volume & Sounds] icon on the Control Panel.
- 2) Select the [Volume] tab. Next, set the [Enable Buzzer for screen taps] to either ON or OFF.

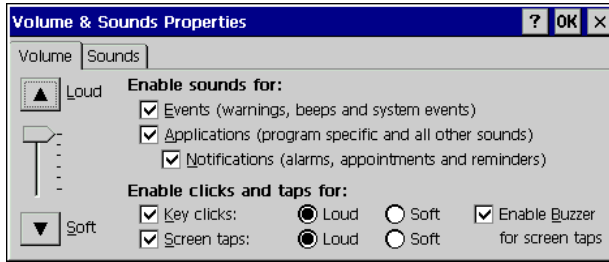

Network

When connecting your PS unit to a network via an Ethernet cable, the following settings are required.

- 1) Double click on the Control Panel's [Network] icon.
- 2) In the [Network Configuration] dialog box, select the [Adaptor] tab's [LANC1:PSG Built-In Ethernet Controller Driver] and click [OK].

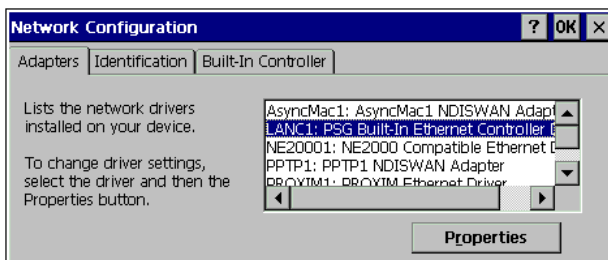

MEMO

When the IP Address is not automatically allocated by the DHCP Server, click on the above dialog box's [Properties] button to call up the [PSG Built-In Ethernet Controller Driver Settings] dialog box. There, enter the necessary settings. For details about these settings, please contact your network administrator.

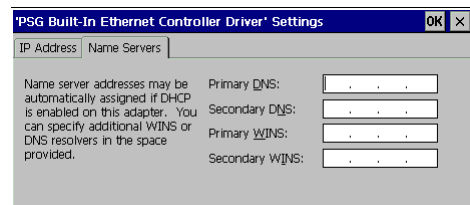
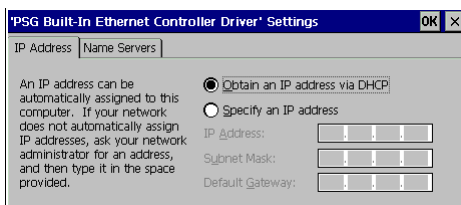

- 3) Perform a backup and save the settings to the CF Card.

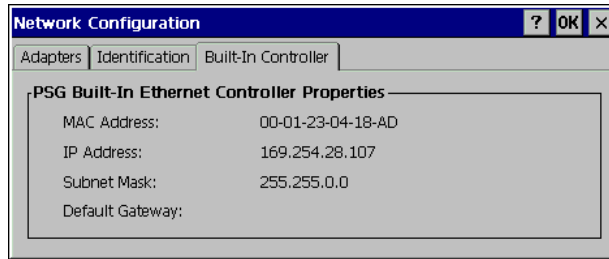

MEMO

After restarting the PS-G unit, be sure to check the current settings via the [Network Configuration] dialog box's Built-In Controller tab's data. RInternal Application the [Windows] folder.

3 Internal Application

This section explains each of the PS-G unit's internal applications.

3.1 Version Information Psgver.exe

This application will call up the PS-G unit's version information. It is located in the [Windows] folder.

3.2 Auto Start AutoRun.exe

The application saved in the CF card can be automatically started when the PS-G unit is turned ON. The following explanation describes this procedure.

- (1) Create a shortcut in the [Windows\Startup] folder pointing to [AutoRun.exe] in the PS-G unit's [Windows] folder.
- (2) Open the Properties of the shortcut created in step (1), open the [Shortcut] tab and set the application to run automatically by changing the link destination in the "Target" field as follows.

Target: "\Windows\AutoRun.exe" "\Storage Card1\Application name"

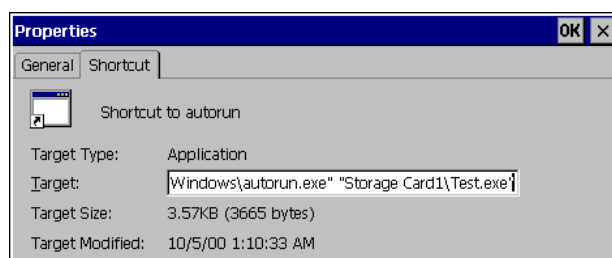

- (3) Click the **OK** button.
- (4) Insert a CF Card into the PS-G, and click the  icon in the Control Panel.
Backup
- (5) Reboot the PS-G with the CF Card inserted.
- (6) Once Windows CE starts, the PS-G unit will read the environment data from the CF Card and launch the application registered in the [\\Windows\\Startup] folder.

3.3 Terminal Services Connection Wizard TsConWiz.exe

This application is used to connect the PS-G unit with a terminal service. The steps to connect the PS-G are as follows:

- 1) Start the [\\Windows\\TsConWiz.exe] program.
- 2) Enter the Connection name and Server name or IP Address, and click on [Next].

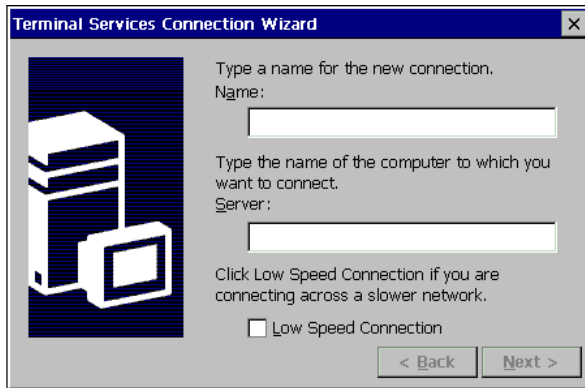

- 3) If required, enter the Username, Password and Domain name.



MEMO

To automatically enter the User name and Password when you connect, click on the [Automatic Logon] checkbox.

- 4) Designate any application that should be automatically started.

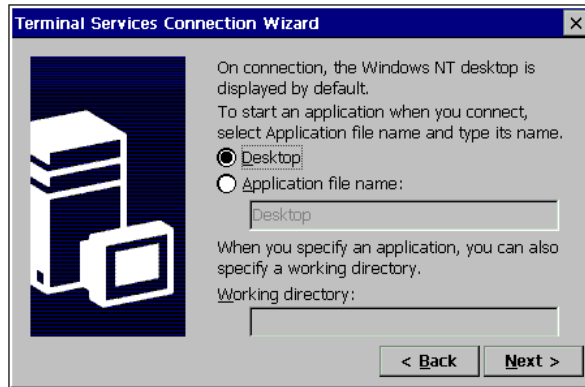

- 5) Click on the [Finish] button and a connection shortcut icon will appear on the desktop.

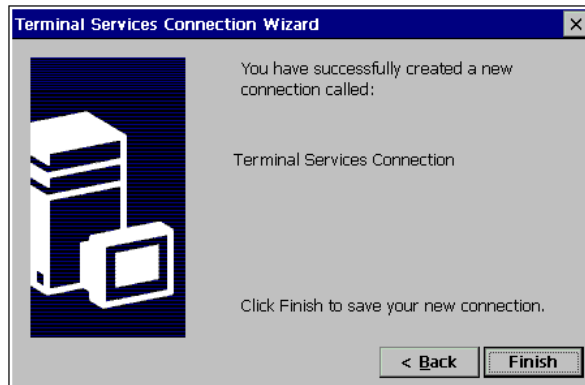

- 6) Double-click this shortcut and confirm that the Terminal Service connection process is successful.
- 7) Perform a backup and save the data to the CF Card.

MEMO

When connecting for the first time, license agreement information will be created. Also, in order to save the licence data, be sure to confirm that the connection process operates correctly before backing up data.

3.4 Applications for Pro-Designer Runtime Installation

PDLoad.exe/PortChanger.exe

Pro-Designer Runtime Installer PDLoad.exe

This application is required when installing Pro-Designer Ver. 3.0.1 or earlier in the PS-G unit. For details, please refer to [Pro-Designer On-line Help].

Port Number Changer PortChanger.exe

This application is used to change the Port Number when installing the Pro-Designer Runtime, using the Pro-Designer Runtime Installer. For details, refer to [Pro-Designer Online Help (Ver. 3.1 or earlier)].

4 Shut Down

Since the PS-G unit operates using ROM-based Windows CE, there is no need to perform a Shut Down procedure. To shutdown the unit, simply disconnect the power cord.

MEMO

Always save your application software data prior to disconnecting the power cord.

4

Maintenance and Inspection

- 1 Regular Cleaning
- 2 Periodic Check Points
- 3 Replacing Consumable Items
 - 3.1 Replacing the Installation Gasket
 - 3.2 Replacing the Backlight

1 Regular Cleaning

When the PS-G unit's display panel or frame becomes dirty, soak a soft cloth in water with a mild detergent, wring the cloth tightly, and wipe the display.

CAUTION

-  Do not use paint thinner, organic solvents or strong acid-based cleaners to clean the PS-G unit.

MEMO

If the PS-G unit is to be used in an environment where the display and frame can easily become dirty, use a PS Series screen protection sheet (PSL-DF00).

2 Periodic Check Points

To keep your PS-G unit in the best possible condition, periodically check the following points.

Operation Environment

- Is the ambient operating temperature within specifications (0° C to 50° C)?
- Is the ambient operating humidity within specifications (relative humidity 10% RH to 90% RH)?
- Is the operating atmosphere free of any corrosive gases?

Power Supply

- Is the power supply within specifications?
PS600G-T41-E124V: DC 24 V (± 20%)

Unit Condition

- Are all the power cords and cables connected properly?
- Are all the PS-G unit's installation fasteners secure?
- Is the installation gasket free of abrasions and dirt?

Unit Operation

- Is the display panel darker than normal?

3 Replacing Consumable Items

3.1 Replacing the Installation Gasket

The installation gasket provides protection against dust and moisture.
The PS-G unit installation gasket's model number is GP570-WP10-MS.

⚠ CAUTION

❗ A gasket which has been used for a long period of time may have scratches or dirt on it, and could have lost much of its water resistance. Be sure to change the gasket at least once a year, or when scratches or dirt become visible.

MEMO Do not stretch the gasket. The gasket is not elastic and may tear if stretched.

Replacement Procedure

- 1) Place the PS-G unit on a flat surface with the display facing down.

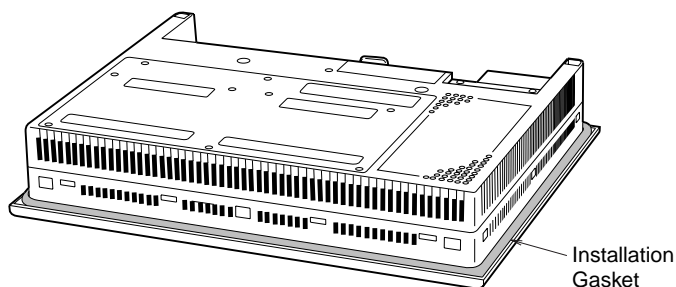

- 2) Remove the old gasket.
- 3) The corners of the PS-G unit have ribs that hold the installation gasket in place. Insert the new gasket into the groove and check that the long side of the gasket is vertical.

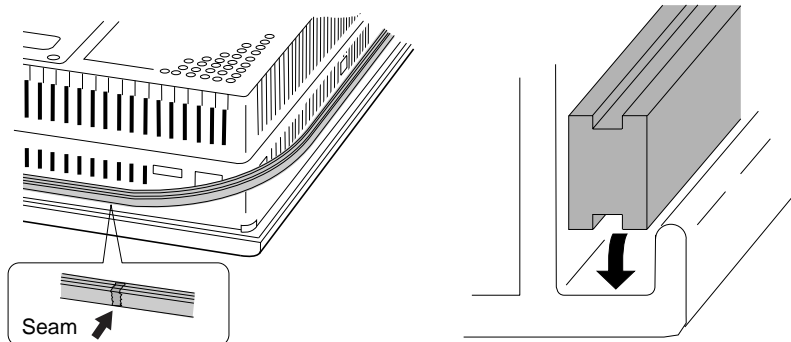

MEMO Make sure the gasket is not inserted with its seam (bonded part of the gasket) in any of the corners. If too much force is concentrated on the seam, it may tear.

- 4) Insert the gasket in the remaining corners.
- 5) Check that the gasket is fitted properly.

MEMO

- If the gasket is not inserted correctly into the groove, it will not provide a level of water resistance equivalent to IP65f.
- The gasket must uniformly extend approximately 2 mm out of the groove. Always check that the gasket is fitted correctly before installing the PS-G unit.

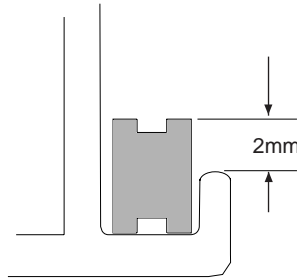

3.2 Replacing the Backlight

The backlight is a long-life product. The average life of the backlight (the time for brightness to fall to half its normal level) is 50,000 hours in an environment with an ambient temperature of 25°C. Replace the backlight when necessary.

The replacement backlight model number is PS600-BU00.

MEMO

- Use of any other model of backlight may result in an accident or a PS-G unit breakdown.
- For backlight replacement information, refer to the replacement backlight's installation guide (replacement backlights are sold separately).

5

Troubleshooting

- 1 Troubleshooting Checklists
 - 1.1 No display (Windows CE does not start)
 - 1.2 Touch panel does not respond
 - 1.3 Connected devices cannot be used

This section explains how to find and resolve PS-G unit problems.

The PS-G unit can be connected to a wide range of devices, including a host (PLC), however, this manual will not discuss every possible device, or problem. For problems not directly related to the PS-G unit, refer to that device's manual.

The main problems that occur during use of the PS-G unit are:

- 1) The panel display is blank (Windows CE does not start).
- 2) The touch panel does not respond.
- 3) Connected devices cannot be used.

1 Troubleshooting Checklists

When a problem occurs, be sure to first read each checklist item and follow the instructions given. If this does not solve the problem, please contact your local PS-G distributor.

When a problem cannot be solved

For hardware and software problems, contact the distributor where you bought the PS-G unit.

1.1 No display (Windows CE does not start)

Step	Check Item or Operation	Check result	Action required
1	Turn the PS-G unit's power supply OFF.		
2	Is the power cord connected correctly?		Connect the power cord correctly. Refer to "Chapter 2.2 Power Connections"
3	Is the power supply voltage within specifications?		Refer to "Appendix 1 Specifications"
4	Is the first Dip Switch inside the CF Card set to ON, and the second through fourth Dip Switches to OFF?		Set the first Dip Switch to ON, and the second through fourth Dip Switches to OFF. Refer to "Chapter 3.2.1 Dip Switch Settings"
5	Turn the power supply ON.		
6	Does the power indicator light up?		Power indicator does not light up → <H>
7	Does the power indicator change from red to green after the sounding of a short buzzer?		Does not change to green. Buzzer sounding continuously → No startup disk → <H>
8	Is the backlight on?		If the backlight has burned out, replace it. Refer to "Chapter 4.3.2 Replacing the Backlight"
	Was the problem solved by the above actions?		No → <H>

1.2 Touch panel does not respond

Step	Check Item or Operation	Check result	Action required
1	Has the touch panel been calibrated?		Calibrate the touch panel. Refer to "Chapter 3.2.2 Control Panel Settings" Touch panel cannot be calibrated → <H>
	Was the problem solved by the above action?		No → <H>

1.3 Connected devices cannot be used.

Step	Check Item or Operation	Check result	Action required
1	Turn the PS-G unit's power supply OFF.		
2	Is the power cord connected correctly?		Connect the power cord correctly. Refer to "Chapter 2 2 Connecting the Power Cord"
3	Are the peripheral devices connected correctly?		Following the instructions described in the respective manual.
4	Turn the power supply ON.		
5	Does this device require driver setup?		Refer to the device's manual and setup the driver.
	Was the problem solved by the above action?		No → <H>

A | Appendices

- 1 Specifications
 - 1.1 Electrical
 - 1.2 Environmental
 - 1.3 Structural
 - 1.4 Performance
 - 1.5 Display
 - 1.6 Touch Panel
- 2 RAS Function
 - 2.1 Overview
 - 2.2 RAS Function - Details
 - 2.3 RAS Function Diagram
- 3 Accessories

1 Specifications

1.1 Electrical

Input Voltage	DC24V
Rated Voltage	DC19.2V to DC28.8V
Allowable Voltage Drop	10 ms or less
Power Consumption	50W or less
In-rush Current	30A or less
Voltage Endurance	Voltage Endurance AC1000V, 20mA for up to 1 minute (between charging and FG terminals)
Insulation Resistance	Insulation Resistance 10M Ω or more at DC500V (between charging and FG terminals)

1.2 Environmental

Ambient Operating Temperature (Panel interior and Panel face)	0°C to 50°C*1
Storage Temperature	-20°C to +60°C
Ambient Humidity	10%RH to 90%RH (non-condensing, dry bulb temperature : 39°C or less)
Dust	0.1mg/m ³ or less (Non-conductive particles)
Atmosphere	Free of corrosive gases
Air-pressure Resistance (Operating altitude)	800 hPa to 1114 hPa (2000 meters or lower)
Vibration Resistance	IEC61131-2 (JIS B 3501) compliant When vibration is NOT continuous 10Hz to 57Hz 0.075 mm, 57Hz to 150Hz 9.8m/s ² When vibration is continuous 10Hz to 57Hz 0.035 mm, 57Hz to 150Hz 4.9m/s ² X,Y,Z directions for 10 times (80min.)
Noise Immunity (via noise simulator)	Noise Voltage: 1500 Vp-p Pulse Duration: 1x10 ⁻⁶ sec. Rise Time: 1ns
Electrostatic Discharge Immunity	Contact Discharge 6kV (IEC 61000-4-2 Level 3)

*1 If the PS-G's operating temperature exceeds 40 °C for an additional period of time, the display quality, such as the contrast, etc., may degrade. If, however, the operating temperature is reduced to 40°C or less, the display quality will return to normal.

1.3 Structural

Grounding	100Ω or less, or your country's applicable standard
Ratings*1	(Front face of installed unit) Equivalent to IP65f (JEM 1030) Design Type: Modular Installation method: panel mounting
Cooling Method	Natural air circulation
Weight	Approx. 3.5kg [7.7lb]
Dimensions (W×H×D)	317 mm [12.48 in.]×243 mm [9.57 in.]×58 mm [2.28 in.]

- *1 The front face of the PS-G unit, when installed in a solid panel, has been tested using conditions equivalent to the standards shown in the specification. Even though the PS-G unit's level of resistance is equivalent to these standards, oils that should have no effect on the PS-G can possibly harm the unit. This can occur in areas where either vaporized oils are present, or where low viscosity cutting oils are allowed to adhere to the unit for long periods of time. If the PS-G's front face protection sheet becomes peeled off, these conditions can lead to the ingress of oil into the PS-G and separate protection measures are suggested. Also, if non-approved oils are present, it may cause deformation or corrosion of the front panel's plastic cover. Therefore, prior to installing the PS-G be sure to confirm the type of conditions that will be present in the PS-G's operating environment.
- If the installation gasket is used for a long period of time, or if the unit and its gasket are removed from the panel, the original level of the protection cannot be guaranteed. To maintain the original protection level, you need to replace the installation gasket regularly.

1.4 Performance

CPU	200MHz SH4	
Memory	Application: 32MB Backup: 512KB (Application data)	
Graphics	SVGA (800 X 600 pixels) 64,000colors	
Video Memory	2MB	
Interfaces	Serial	Serial interface (COM1/COM2) Dsub 9-pin plug-type connector
	Printer	Complies with Centronics Standards Dsub 25-pin socket-type connector
	Keyboard/Mouse	KEYBOARD/MOUSE PS/2 compatible Mini DIN 6-pin connector
	Ethernet	10BASE-T Complies with IEEE802.3 10BASE-T modular jack connector
	Memory Card	1 slot CF Card
	USB	USB1, USB2 (USB ver.1.0)
	RAS	Dsub 15-pin socket-type connector
	Expansion Bus	Expansion unit interface 1 (EXT1) Expansion unit interface 2 (EXT2)
	IrDA	Supports SIR IrDA V1.0
	Sound	Sound output terminal block provides Monaural: 1CH Speaker Output: 70mW(Rated load: 8Ω, Frequency:1KHz) Sound Line Output: 2.0Vp-p(Rated load: 10KΩ) Recomended wiring: AWG#28 to 16

1.5 Display

Type	TFT Color LCD
Resolution	800 × 600 pixels
Dot pitch	0.3075 mm × 0.3075 mm
Effective Display Area	246 mm × 184.5 mm
Colors (Levels)	64,000 colors out of 16,770,000 colors
Backlight	CCFL (user replaceable)
Brightness control	4 levels via touch panel
Contrast control	None
Backlight	50,000 hours or more (time required for backlight brightness to dim to 50% of original level - at 25°C and 24 hr. operation)

1.6 Touch Panel

Resolution	1024 × 1024
Type	Resistive Film (analog)

2 RAS Function

2.1 Overview

RAS, which stands for Reliability, Availability, and Serviceability, is a device-level monitoring function that provides a variety of features to improve the reliability of your PS-G system. Though the standard set of RAS features used will vary depending on the devices used, the following features are used to provide Alarm Monitoring and External Input Signal support.

Alarm Monitoring	Watchdog Timer Time-up
External Input Signal	Standard Signal Input *1 (DIN 2-bit) Remote Reset Input *2

Also, when either the one of the above mentioned alarm occurs, or an external signal input is received, the following types of alarm processing output signals and features are supported.

External Output Signal	Standard Signal Output (DOUT 1-bit) Alarm Output (single lamp)
Various Processing Functions	LED indicator (3 colors at 1 point) Pop-up Message Output Buzzer Output System Reset

Additionally, each of the above items and signals can either be enabled or disabled, or perform a variety of alarm processing using the RAS Control on the PS-G unit's Control Panel. Refer to "Chapter 3 2.2 Control Panel Settings".

There is also an Application Interface Library (API-DLL) available which allows RAS functions to be used by other applications. For more information, refer to the "PS Series Type G Application Development Kit (ADK) Developer Manual".

*1 Standard Signal Input will latch Input Information

*2 The remote reset feature's input can be either enabled or disabled, however, the alarm output setting cannot be set to trigger a forced system reset.

2.2 RAS Function - Details

Alarm Monitoring

This feature alternately writes Time Up Count values from the CPU to the RAS feature's special programmable timer and then periodically clears them, which provides a means of monitoring the CPU's performance. If the clearing of this count value is stopped, the timer will overflow and an alarm will be detected. The System Monitor utility can be used to enable or disable this feature, as well as designate what type of processing is to be performed.

External Input Signals

The RAS interface connector accepts the following input signals.

Standard Purpose Signal Input (DIN)

This standard digital input is used for alarm detection in external devices. The input signal uses two bits. The Control Panel's RAS Control or an API-DLL can be used to enable or disable this feature, as well as designate what type of processing is to be performed once a signal is received. The input will latch Input Information. (This detects only the DIN circuit's ON state. OFF is not monitored.)

Remote Reset Input

This is the reset signal sent from an external device to the PS-G unit. When this signal is enabled, a forced reset of the PS-G unit is performed. The Control Panel's RAS Control or an API-DLL can be used to enable or disable this feature.

External Input Signal (DIN, common use with Remote Reset Input)

- Power : DC12V to DC24V connections possible
- Input Protection : Protection Diode
- Isolation : Used (Photo isolation)

Example Connection (Interface circuits)

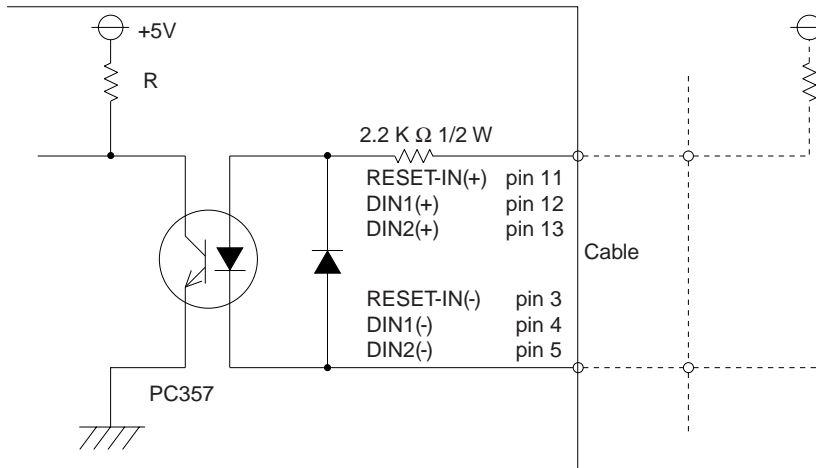

MEMO

For information concerning the RAS Connector Pin Configuration, refer to "Chapter 2 3.6 RAS Interface".

External Output Signals

The RAS interface connector on the PS-G unit is prepared for the following output signals.

General Purpose Signal Output (DOUT)

This is a digital output signal for reporting system conditions to external devices. It can be controlled via either the Control Panel's RAS Control, or by an API-DLL.

Alarm Output (single lamp)

This general purpose digital output signal provides system condition information to external devices.

The Control Panel's RAS Control or an API-DLL can be used to control this signal.

External Output Signals (DOUT, common use with Alarm Output)

- Output specifications : DC24V 100mA (MAX)
- Isolation : Used (Photo isolation)

Example Connection

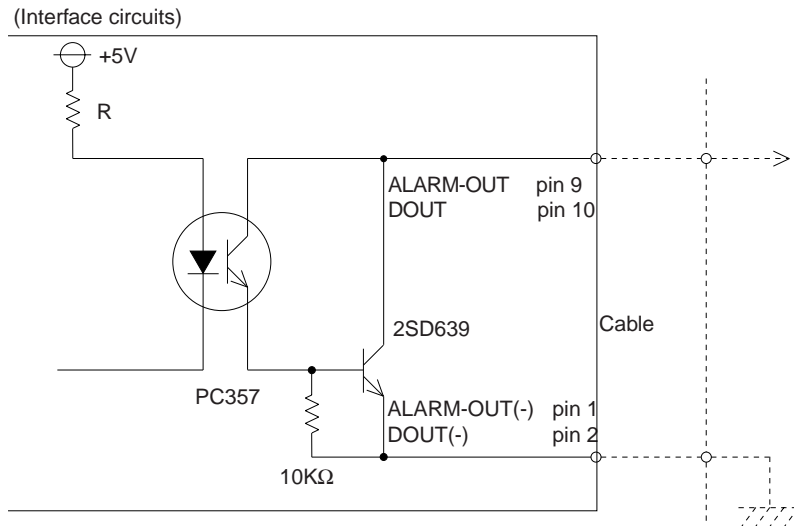

MEMO

For information concerning the RAS Connector Pin Configuration, refer to "Chapter 2 3.6 RAS Interface".

Processing Functions

The PS-G unit provides system condition information via the following items.

LED indicator

In addition to indicating if the unit's power is ON or OFF, the 3-state LED indicator (power lamp) provides the following system condition information.

Color	System Condition	Output Requirement
Green	Normal operation (Power ON)	——
Orange	RAS feature has detected an alarm.	Alarm output must be enabled at RAS Control.
	Backlight burnout occurs	——
Red	System error	——

Pop-up Message Output

This feature uses the Windows system's pop-up message feature to indicate that an alarm has occurred. Use the Control Panel's RAS Control or an API-DLL to enable or disable this feature.

Buzzer Output

This feature uses the PS-G unit's internal speaker to indicate the system's condition.

System Reset

Reboots the PS-G unit's OS.

Use the Control Panel's RAS Control or an API-DLL to enable or disable this feature.

2.3 RAS Function Diagram

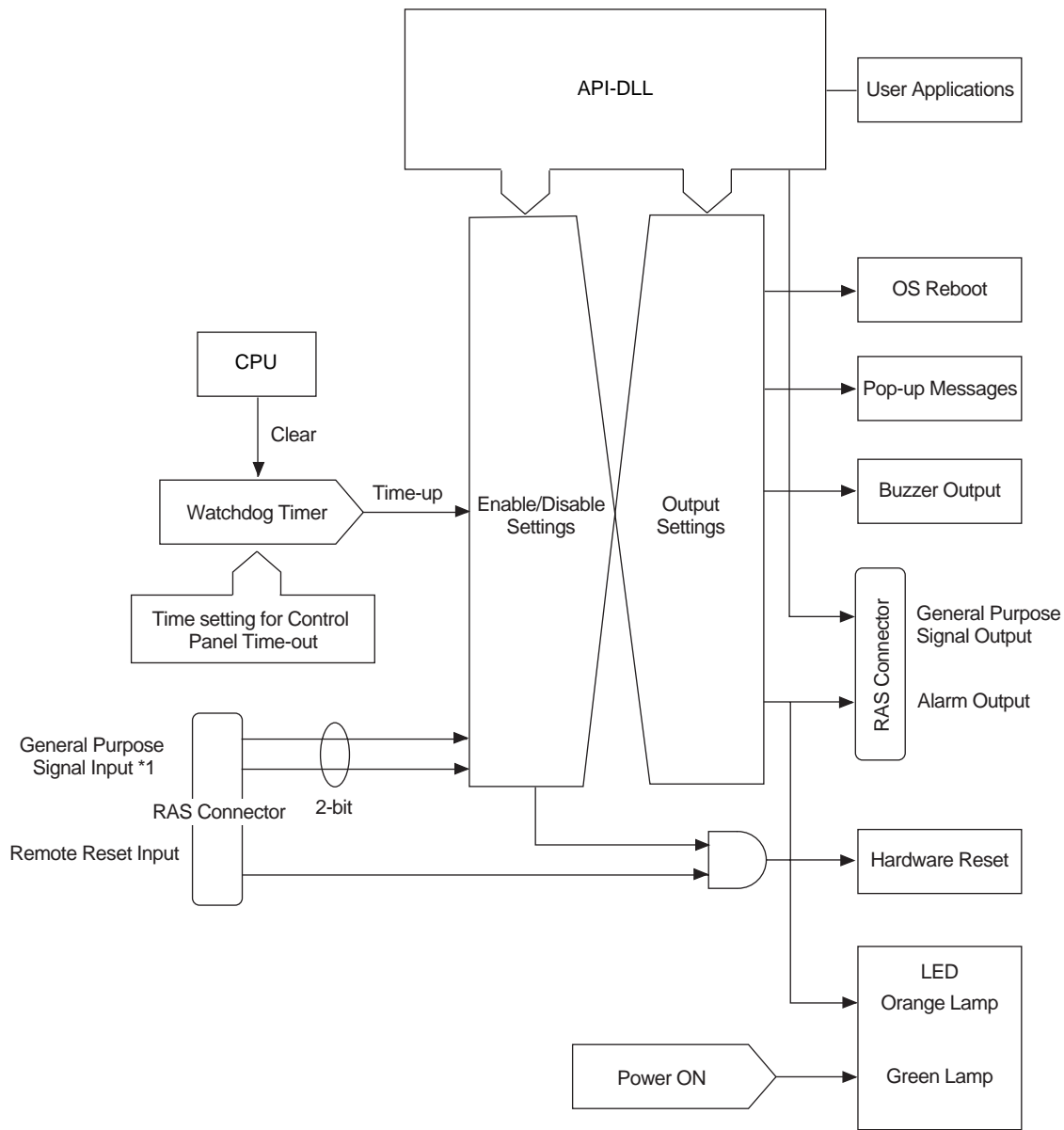

*1 General Purpose Signal Input will latch Input Information

3 Accessories

PS Unit Accessories

Product Name	Model No.	Description
PS Series Screen Protection Sheet	PSL-DF00	Five (5) disposable protection sheets for protecting the display from dirt.
PS Series Type G Application Development Kit (ADK)	PSG-DK01	Used to create applications for use on PS series Type G units. (Provide download cable)
Pro-Designer	PS-DWE01-V** (* indicates data that changes depending on the version.)	The package software used to create the HMI Development environment for the Multi-platform (RUN environment) system requires purchase of the Run-time Licence (PS-DGR01).

General Accessories

Product Name	Model No.	Description
CF Card*1	GP077-CF20	CF Card (16 MB)
	GP077-CF30	CF Card (32 MB)
CF Card Adaptor	GP077-CFAD10	CF Card adaptor for a standard PC Card slot
Pin-jack Cable	GP077-SDAD10	Pin-jack cable for sound output terminal block.
DIO Unit	PSG-XY08	External I/O Unit providing 8 digital input and 8 digital output points.
PCMCIA Unit	PSM-PCM00	Allows use of a PCMCIA card with the PS-G unit.
Wall Mount Adaptor	CA1-WMALRG-01	Allows the PS-G unit to be attached to a wall.
Desktop Stand	CA1-STDLRG-01	Allows the PS-G unit to be used on a desktop or flat surface.
Rear Cover	CA1-RCVLRG-01	Attaches to the rear face of the PS-G unit. Used together with the Wall Mount Adaptor,

Maintenance Accessories

Product Name	Model No.	Description
Installation Fasteners	GP070-AT01	Fasteners to attach the PS-G unit to a panel (4/set)
Installation Gasket	GP570-WP10-MS	Water-resistant gasket that fits around the PS-G unit
Backlight	PS600-BU00	Replacement Backlight
Connector Cover	PS-BH00	Cover for rear-side of connector (3/set)
Data Transfer Cable	PSG-CB01	Included with PS Series Type G Application Development Kit (ADK).

*1 The CF Card is formatted using the FAT32 file system, which uses a small amount of CF Card space. As a result, the actual amount of usable CF Card free space will be slightly less than the CF Card capacities given here (i.e. 8, 16 or 32MB).

Index

A		K	
Accessories	A-12	Keyboard and Mouse Connections	2-13
Auto Start AutoRun.exe	3-11	Keyboard/Mouse Interface	1-7
B		L	
Backlight	3-6	Liquid Crystal Display (LCD) Characteristics ...	10
Backlight Burnout Precautions	10	N	
Backup	3-7	Network	3-10
C		O	
CE Marking	7	Overview	A-6
CF Card	2-18	P	
CF Card Cover	1-6	Package Contents	8
CF Card Insertion and Removal	2-18	Part Names and Functions	1-4
CF Card Slot	1-6	PCMCIA units	1-5
Connecting the Power Cord	2-8	Performance	A-4
Control Panel Settings	3-4	Periodic Check Points	4-2
D		Port Number Changer PortChanger.exe	3-14
Dimensions	1-8	Power Cord	2-9
DIO units	1-5	Power Cord Cautions	2-8
Dip Switch Settings	3-3	Power Input Terminal Block	1-5
Display	A-4	Printer Interface	1-6
Display Panel	1-4	Pro-Designer Runtime Installer PDLoad.exe ..	3-14
Documentation Conventions	2	PS-600G Series Model Numbers	6
E		PS-G Unit Application Software	6
Electrical	A-2	R	
Environmental	A-2	RAS Control	3-8
Essential Safety Precautions	3	RAS Function	A-6
Ethernet Interface	1-6, 2-14	RAS Interface	1-6
Expansion Unit Interface	1-5	Regular Cleaning	4-2
G		Replacing the Backlight	4-4
Grounding	2-8	Replacing the Installation Gasket	4-3
I		S	
Installation Gasket	2-4	Serial Interfaces	1-6
Installation Procedures	2-2	Shut Down	3-14
Installation Requirements	2-2	Sound Output	2-16
Internal Application	3-11	Sound Output Terminal Block	1-6
IrDA Interface	1-4	Start Up	3-2
		Status LED	1-4
		Structural	A-3
		Stylus	3-5
		System Design	1-2

T

Terminal Services Connection Wizard	
TsConWiz.exe	3-12
Touch Panel	A-5
Troubleshooting Checklists	5-2

U

UL/c-UL (CSA) Approval	7
USB Interfaces	1-6

V

Version Information Psgver.exe	3-11
Volume & Sounds	3-10

Global Head Office

Digital Electronics Corporation
8-2-52 Nanko-higashi,
Suminoe-ku, Osaka 559-0031 JAPAN
Tel: +81 (0)6 6613 3116 Fax: +81(0)6 6613 5888
<http://www.pro-face.com> support@digital.co.jp

South Korea

Pro-face Korea Co., Ltd.
Room #701, Jaeyoung Building
678-10 Deungchon-dong
Kangseo-Ku, Seoul 157-030 KOREA
Tel: +82 (0)2 658 6835 Fax: +82 (0)2 3664 6839
<http://www.proface.co.kr> proface@proface.co.kr

Taiwan

Pro-face Taiwan Co., Ltd.
2F, No.69, Fushing North Road
Taipei 105 TAIWAN R. O. C.
Tel: +886 (0)2 2772 5208 Fax: +886 (0)2 8773 7892
<http://www.proface.com.tw> proface@proface.com.tw

North/South America

Pro-face America, Inc. Xycom
750 North Maple Road Saline, MI 48176 U.S.A.
Tel: +1 734 429 4971 Fax: +1 734 429 1010
<http://www.profaceamerica.com>
support@profaceamerica.com

European Head Office

Pro-face Europe B.V.
Amsteldijk 166
1079 LH Amsterdam THE NETHERLANDS
Tel: +31 (0)20 6464 134 Fax: +31(0)20 6464 358
<http://www.proface.com> support@proface.com

Italy

Pro-face HMI B.V. Italy
Via Carcano 44
20033 Desio (MI)
ITALY
Tel: +39 0362 33 71 63 Fax: +39 0362 30 77 25
supporto_tecnico@proface.com

Germany

Pro-face Deutschland GmbH
Albertus-Magnus-Strasse 11
42719 Solingen
GERMANY
Tel: +49 (0)212 258 260 Fax: +49 (0)212 258 2640
<http://www.pro-face.de> support@pro-face.de