

PREFACE

Thank you for purchasing the GP Screen Editor Software, "GP-PRO/PB III for Windows Ver. 6.3" for use with Pro-face's GP series operator interfaces.

Please read this manual carefully in order to use this software properly, and be sure to keep this manual handy for future reference.

NOTES

- (1) The copyrights to all programs and manuals included in the GP-PRO/PB III for Windows Ver. 6.3 (hereinafter referred to as "this product") are reserved by the Digital Electronics Corporation. Digital grants the use of this product to its users as described in the "Software Operating License Conditions" documentation, included with this product's CD-ROM. Any actions violating the above-mentioned conditions are prohibited by both Japanese and foreign regulations.
- (2) The contents of this manual have been thoroughly inspected. However, if you should find any errors or omissions in this manual, please inform your local GP representative of your findings.
- (3) Regardless of article (2), the Digital Electronics Corporation shall not be held responsible for any damages or third party claims resulting from the use of this product.
- (4) Differences may occur between the descriptions found in this manual and the actual functioning of this product. Therefore, the latest information on this product is provided in data files (i.e. Readme.txt files, etc.) and in separate documents. Please consult these sources as well as this manual prior to using the product.
- (5) Even though the information contained in and displayed by this product may be related to intangible or intellectual properties of the Digital Electronics Corporation or third parties, the Digital Electronics Corporation shall not warrant or grant the use of said properties to any users and/or other third parties.
- (6) The specifications set out in this manual are for overseas products only. As a result, some differences may exist between the specifications given here and for those of the identical Japanese product. Digital Electronics Corporation accepts no liability for issues related to the intellectual property rights of third parties or any issues related to the use of the information contained in or displayed by this product.

© Copyright 2003 Digital Electronics Corporation. All rights reserved.
Digital Electronics Corporation, September 2003

For the rights to trademarks and trade names, see "TRADEMARK RIGHTS".

TRADEMARK RIGHTS

All company or product names used in this manual are the trade names, trademarks (including registered trademarks), or service marks of their respective companies.

This product omits individual descriptions of each of these rights.

Trademark / Trade Name	Right Holder
Microsoft, MS, MS-DOS, Windows, Windows 95, Windows 98, Windows Me, Windows NT, Windows 2000, Windows XP, Windows Explorer, Microsoft Excel	Microsoft Corporation, USA
Intel, Pentium	Intel Corporation, USA
Pro-face	Digital Electronics Corporation (in Japan and other countries)
Ethernet	Western Digital Electric Corporation, USA
IBM, VGA, IBM Compatible	International Business Machines Corporation (IBM), USA

The following terms differ from the above mentioned formal trade names and trademarks.

Term used in this manual	Formal Trade Name or Trademark
Windows 95	Microsoft® Windows® 95 Operating System
Windows 98	Microsoft® Windows® 98 Operating System
Windows Me	Microsoft® Windows® Me Operating System
Windows NT	Microsoft® Windows NT® Operating System
Windows 2000	Microsoft® Windows® 2000 Operating System
Windows XP	Microsoft® Windows® XP Operating System

LIST OF SUPPORTED MODELS

The following table lists the models compatible with GP-PRO/PB III for Windows Ver.6.3 The following series names or product names are used in the descriptions contained in this manual.

■ List of Supported GPs

Series	Product Name	Model	GP Type	
GP70 series	GP-H70 series	GP-H70L	GPH70-LG11-24V	GPH70L
			GPH70-LG41-24VP	
		GP-H70S	GPH70-SC11-24V	GPH70S
			GPH70-SC41-24VP	
	GP-270 series	GP-270L	GP270-LG11-24V	GP270L
			GP270-LG21-24VP	
			GP270-LG31-24V	
		GP-270S	GP270-SC11-24V	GP270S
			GP270-SC21-24VP	
			GP270-SC31-24V	
	GP-370 series	GP-370L	GP370-LG11-24V	GP370L
			GP370-LG21-24VP	
			GP370-LG31-24V	
			GP370-LG41-24VP	
		GP-370S	GP370-SC11-24V	GP-370S
			GP370-SC21-24VP	
			GP370-SC31-24V	
			GP370-SC41-24VP	
	GP-470 series	GP-470E	GP470-EG11	GP470
			GP470-EG21-24VP	
			GP470-EG31-24V	
	GP-570 series	GP-570L	GP570-LG11-24V	GP570L
			GP570-LG21-24V	
		GP-570S	GP570-SC11	GP570
			GP570-SC21-24VP	
			GP570-SC31-24V	
		GP-570T	GP570-TC11	GP570
GP570-TC21-24VP				
GP570-TC31-24V				
GP-57JS		GP57J-SC11	GP570VM	
GP-570VM		GP570-TV11		
GP-571 series	GP-571T	GP571-TC11	GP571T	
GP-675 series	GP-675S	GP675-SC11	GP675	
		GP675-TC11		
	GP-675T	GP675-TC41-24VP		
GP-870 series	GP-870VM	GP870-PV11	GP870VM	
GP-37W2 series	GP-37W2B	GP37W2-BG41-24V	GP37W2	
GP-377 series	GP-377L	GP377-LG11-24V	GP377L	
		GP377-LG41-24V		
	GP-377S	GP377-SC11-24V	GP377S	
		GP377-SC41-24V		
GP77R series	GP-377R series	GP377R-TC11-24V	GP377R	
		GP377R-TC41-24V		
	GP-477R series	GP477R-EG11	GP477R	
		GP477R-EG41-24VP		
	GP-577R series	GP-577RS	GP577R-SC11	GP577R
			GP577R-SC41-24VP	
		GP-577RT	GP577R-TC11	
			GP577R-TC41-24VP	

Series		Product Name	Model	GP Type
GP2000H series	GP-2301H series	GP-2301HL	GP2301H-LG41-24V	GP2301HL
		GP-2301HS	GP2301H-SC41-24V	GP2301HS
	GP-2401H series	GP-2401HT	GP2401H-TC41-24V	GP2401H
GP2000 series	GP-2300 series	GP-2300L	GP2300-LG41-24V	GP2300L
		GP-2300S	GP2300-SC41-24V	GP2300S
		GP-2300T	GP2300-TC41-24V	GP2300
	GP-2301 series	GP-2301L	GP2301-LG41-24V	GP2301L
		GP-2301S	GP2301-SC41-24V	GP2301S
		GP-2301T	GP2301-TC41-24V	GP2301
	GP-2400 series	GP-2400T	GP2400-TC41-24V	GP2400
	GP-2401 series	GP-2401T	GP2401-TC41-24V	GP2401
	GP-2500 series	GP-2500L	GP2500-LG41-24V	GP2500L
		GP-2500S	GP2500-SC41-24V	GP2500S
		GP-2500T	GP2500-TC11	GP2500
		GP2500-TC41-24V		
	GP-2501 series	GP-2501L	GP2501-LG41-24V	GP2501L
		GP-2501S	GP2501-SC11	GP2501S
		GP-2501T	GP2501-TC11	GP2501
	GP-2600 series	GP-2600T	GP2600-TC11	GP2600
			GP2600-TC41-24V	
	GP-2601 series	GP-2601T	GP2601-TC11	GP2601

■ List of Supported GLCs

Series		Product Name	Model	GP Type
GLC100 series	GLC100 series	GLC100L	GLC100-LG41-24V	GLC100L
		GLC100S	GLC100-SC41-24V	GLC100S
GLC300 series	GLC300 series	GLC300T	GLC300-TC41-24V	GLC300T
GLC2000 series	GLC2300 series	GLC2300L	GLC2300-LG41-24V	GLC2300L
		GLS2300T	GLC2300-TC41-24V	GLC2300
	GLC2400 series	GLC2400T	GLC2400-TC41-24V	GLC2400
	GLC2600 series	GLC2600T	GLC2600-TC41-24V	GLC2600

■ List of Supported STs

Series	Product name	Model	GP Type
ST 400 series	ST 400	ST 400-AG41-24V	ST 400
	ST 401	ST 401-AG41-24V	ST 401
	ST 402	ST 402-AG41-24V	ST 402

■ List of Supported Factory Gateway

Product name	Model	GP Type
Factory Gateway	FGW_SE41_24V	Factory Gateway FGW-SE



To use the GPWeb and GPViewer functions with the Factory Gateway, you must have GPPRO/PB III C-Package02 or later installed.

HOW TO USE THIS MANUAL

■ Structure of this Manual

The "Tag Reference manual" is the second of four manuals for this product, and explains how to use the "GP-PRO/PB III for Windows Ver. 6.3" software (hereafter referred to as "this product"). Please refer to all of these manuals when using this product.

In addition to these manuals, data files containing supplemental information on updated functions are also provided.

To read these files, click on the [Start] button in your Windows OS main screen and select the [Programs]→[Pro-face]→[ProPB3Win] menu. Then click on the [Read Me] selection.

For detailed information about GP series products, please refer to each GP's "User Manual" . (Optionally available)

Vol. 1	Operation Manual	Describes this product's operation procedures and all standard functions. (provided as PDF data)
Vol. 2	Tag Reference Manual (This Manual)	Describes the functions and detailed settings for all GP-PRO/PBIII Tags. (provided as PDF data)
Vol. 3	Parts List	Describes this product's pre-made Parts and symbols. (provided as PDF data)
Vol. 4	Device/PLC Connection Manual	Describes the methods for connecting the GP to other, supported manufacturer Device/PLCs. (provided as PDF data)

Screen Data Layout Sheets are useful for designing tag address settings, etc. and example sheets are installed as part of the GP-PRO/PBIII for Windows standard installation.

The following two layout sheets, "Device Allocation Table" and "Tag Layout Sheet", are in Microsoft Excel format and are located in the PDF Manual CD-ROM.

The following folder and file names are used.

Folder Name	File Name	Contents
Pro-face\ propbwin\sheet	Device1E.xls	Device Allocation Table
	TAG1E.xls	Tag Layout Sheet
	TAG2E.xls	
	TAG3E.xls	
	TAG4E.xls	

For information on the use of Microsoft Excel, please refer to the Excel software's User Manual.

■ Designation of Supported Models

The functions and settings supported by each model may vary depending on the supported models. In this manual, explanations given are based on the variation of the "Series" and "Product name" described in the "List of Supported Models".

MANUAL SYMBOLS AND TERMINOLOGY





This manual uses the following symbols and terminology.

If you have any questions about the contents of this manual, please contact your local GP distributor.

Also, If you have any question about your personal computer or Windows, please contact your PC distributor or manufacturer.





■ Safety Symbols and Terms

This manual uses the following symbols and terms to identify important information related to the correct and safe operation of this product.

Symbol	Description
 <i>Warning</i>	Indicates a potentially hazardous situation that could result in serious injury or death.
 <i>Caution</i>	Indicates a potentially hazardous situation that could result in minor injury or equipment damage.
 <i>Important</i>	Indicates a potentially damaging action or dangerous situation that could result in abnormal equipment operation or data loss.
 <i>Careful!</i>	Indicates instructions or procedures that must be performed to ensure correct product use.
	Indicates instructions or procedures that must not be performed.

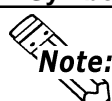
■ General Information Symbols and Terms

This manual uses the following symbols and terms for general information.

Symbol	Description
 <i>Note:</i>	Provides hints on correct product use, or supplementary information.
 <i>Reference</i>	Indicates an item's related information (manual name, chapter, section, sub-section).
 	Refers to keys on the computer keyboard. <i>Reference</i> ■ <i>Keyboard Compatibility List</i>
IBM Compatible	Indicates a PC that can run the Windows® operating system.
PLC	PLC (Programmable Logic Controller, sequencer), including thermoregulator, inverter, etc.
GP	Generic name for the "GP Series" of programmable operator interface made by the Digital Electronics Corporation. For a list of compatible GP products please see "Compatible Products and Environmental Specifications". <i>Reference</i> <i>LIST OF SUPPORTED MODELS</i> ■ <i>List of Supported GPs</i>
GLC	Generic name for the GLC Series of Graphic Logic Controllers made by Digital Electronic Corporation. <i>Reference</i> <i>LIST OF SUPPORTED MODELS</i> ■ <i>List of Supported GLCs</i>

WHEN USING GLC2000 SERIES UNITS

GLC2000 Series units are equipped with the same features as GP2000 units, with the addition of control-related features. As a result, please change the word “GP” to “GLC” when reading this manual. However, please remember that GLC Series units cannot use AUX output or Sound output.

Be sure to understand this manual thoroughly before using your GLC unit.

WHEN USING ST SERIES UNITS

In this manual, read the word “GP” (“GP2301L”) as “ST”. However, ST units have certain restrictions owing to hardware specification differences with GP-2301L units. Be sure to understand this manual thoroughly before using your ST unit. Functions incompatible with your ST unit, **▼Reference▲** *Operation Manual [GENERAL GP RESTRICTIONS] section, Operation Manual 2.11.2 Restrictions*

TABLE OF CONTENTS

PREFACE	1
TRADEMARK RIGHTS	3
LIST OF SUPPORTED MODELS	3
HOW TO USE THIS MANUAL	5
WHEN USING GLC2000 SERIES UNITS	7
WHEN USING ST SERIES UNITS	7
TABLE OF CONTENTS	8

1 GP Display Data Types

1.1 Screen File Types	1-1
1.2 Active Image Functions	1-2
1.3 Tag List (Alphabetical Order)	1-5
1.4 Tag List (Function Order)	1-8
1.5 Tag List of Support	1-12
1.6 Tag Setting Cautions	1-16

2 Active Image Functions

2.1 A-tag (Alarm Summary TEXT Display)	2-21
2.1.1 Overview	2-21
2.1.2 About A-tags	2-21
2.1.3 Using A-tags	2-26
2.1.4 A-tag Example	2-35
2.1.5 Color Settings.....	2-38
2.2 a-tag (Alarm Summary Display)	2-41
2.2.1 Overview	2-41
2.2.2 About a-tags	2-41
2.2.3 Using a-tags	2-43
2.2.4 Alarm Summary Display Notes	2-45

2.3	C-tag (Time Display)	2-47
2.3.1	Overview	2-47
2.3.2	About C-tags	2-47
2.3.3	Using C-tags	2-49
2.4	D-tag (Statistical Graph Display)	2-51
2.4.1	Overview	2-51
2.4.2	About D-tags	2-51
2.4.3	Using D-tags	2-52
2.5	d-tag (Statistical Data Display)	2-55
2.5.1	Overview	2-55
2.5.2	About d-tags	2-55
2.5.3	Using d-tags	2-57
2.6	E-tag (Extended N-tag Function)	2-61
2.6.1	Overview	2-61
2.6.2	About E-tags	2-61
2.6.3	Using E-tags	2-63
2.6.4	Indirect Word Addressing Examples	2-76
2.7	F-tag (Free Library Display)	2-79
2.7.1	Overview	2-79
2.7.2	About F-tags	2-79
2.7.3	Using F-tags	2-81
2.8	G-tag (Graph Display)	2-85
2.8.1	Overview	2-85
2.8.2	About G-tags	2-84
2.8.3	Using G-tags	2-86
2.9	g-tag (Extended G-tag Function)	2-91
2.9.1	Overview	2-91
2.9.2	About g-tags	2-91
2.9.3	Using g-tags	2-93

TABLE OF CONTENTS

2.10	H-tag (Moving Mark Display) *1	2-101
2.10.1	Overview	2-101
2.10.2	About H-tag	2-101
2.10.3	Using H-tags *1	2-102
2.10.4	Object Drawing Data *1	2-104
2.11	J-tag (Moving Mark Display)	2-109
2.11.1	Overview	2-109
2.11.2	About J-tags	2-109
2.11.3	Using J-tags	2-111
2.12	K-tag (Key Input)	2-115
2.12.1	Overview	2-115
2.12.2	About K-tags	2-115
2.12.3	Using K-tags	2-118
2.12.4	Data Input Example	2-131
2.12.5	Notes on Entering BCD Data	2-132
2.12.6	Auto Clear Example	2-134
2.12.7	Using Arithmetic Operations	2-135
2.13	k-tag (Keyboard Setup)	2-136
2.13.1	Overview	2-136
2.13.2	About k-tags	2-136
2.13.3	Using k-tags	2-138
2.14	L-tag (Library Display)	2-142
2.14.1	Overview	2-142
2.14.2	About L-tags	2-142
2.14.3	Using L-tags	2-144
2.14.4	Library Display Coordinates	2-147
2.14.5	Display Timing	2-149
2.14.6	Erase Mode Settings	2-150
2.14.7	Offset Settings	2-151

2.14.8	Notes on XOR Display	2-152
2.14.9	How to Avoid Overlapping Erase Images	2-153
2.14.10	Overlapping Colors on a Color GP	2-154
2.15	I-tag <small L> (Library Status Display)	2-160
2.15.1	Overview	2-160
2.15.2	About I-tags	2-161
2.15.3	Using I-tags	2-162
2.15.4	Bit Offset and Bit Length Settings	2-164
2.16	M-tag (Mark Display)	2-166
2.16.1	Overview	2-166
2.16.2	About M-tags	2-166
2.16.3	Using M-tags	2-168
2.16.4	Mark Display Using Indirect Mode	2-170
2.17	N-tag (Numeric Display)	2-172
2.17.1	Overview	2-172
2.17.2	About N-tags	2-172
2.17.3	Using N-tags	2-174
2.17.4	Relative Data Display Settings	2-180
2.18	n-tag (Alarm Range Display)	2-182
2.18.1	Overview	2-182
2.18.2	About n-tags	2-182
2.18.3	Using n-tags	2-183
2.19	P-tag (Numeric Display in Pre-designated Format)	2-186
2.19.1	Overview	2-186
2.19.2	About P-tags	2-186
2.19.3	Using P-tags	2-188
2.19.4	P-tag Example Settings	2-192
2.20	Q-tag (Alarm Summary Display)	2-194
2.20.1	Overview	2-194

TABLE OF CONTENTS

2.20.2	About Q-tags	2-194
2.20.3	Q-tag Restrictions	2-199
2.20.4	Using Q-tags	2-200
2.20.5	Q-tag Examples	2-207
2.20.6	Sub Display Example	2-209
2.20.7	About Freeze Mode	2-212
2.20.8	Roll Up and Roll Down Keys	2-213
2.20.9	GP System Area Q-tag settings	2-214
2.20.10	Example of CSV Storage of Q-tag Alarm Summary	2-224
2.21	R-tag (Rail Settings)	2-226
2.21.1	Overview	2-226
2.21.2	About R-tags	2-226
2.21.3	Using R-tags	2-227
2.22	S-tag (String Display)	2-230
2.22.1	Overview	2-230
2.22.2	About S-tags	2-230
2.22.3	Using S-tags	2-232
2.23	T-tag (Touch Panel Input)	2-236
2.23.1	Overview	2-236
2.23.2	About T-tags	2-236
2.23.3	Using T-tags	2-239
2.23.4	One-Shot Buzzer for T-tag momentary	2-248
2.23.5	Setting Up T-tags	2-250
2.23.6	Changing Screens	2-251
2.23.7	Screen Level Change Direction	2-255
2.24	t-tag (Selector Switch Input)	2-258
2.24.1	Overview	2-258
2.24.2	About t-tags	2-258
2.24.3	Using t-tags	2-260

2.25	Tih / Tiw-tags (Inching Function) *	2-262
2.25.1	Overview	2-262
2.25.2	About Tih / Tiw-tags	2-263
2.25.3	Using Tih-tags *	2-264
2.25.4	Using Tiw-tags	2-265
2.26	U-tag (Window Display)	2-266
2.26.1	Overview	2-266
2.26.2	About U-tags	2-266
2.26.3	Global Window Display	2-268
2.26.4	Local Window Display	2-269
2.26.5	Using U-tags	2-270
2.26.6	U-tag Examples	2-272
2.26.7	GP System Area Global Window Display Settings	2-273
2.27	V-tag (Video Window Display)	2-274
2.27.1	Overview	2-274
2.27.2	About V-tags	2-274
2.27.3	Using V-tags *	2-276
2.27.4	V-tag Examples *	2-279
2.28	v-tag (Extended Video Window Display)	2-281
2.28.1	Overview	2-280
2.28.2	About v-tags	2-280
2.28.3	Using v-tags	2-285
2.28.4	v-tag Examples	2-286
2.29	W-tag (Write to Device)	2-291
2.29.1	Overview	2-291
2.29.2	About W-tags	2-292
2.29.3	Using W-tags	2-293
2.29.4	W-tag Examples	2-297

2.30	X-tag (Display Text Data)	2-298
2.30.1	Overview	2-298
2.30.2	About X-tags	2-298
2.30.3	Using X-tags	2-300
2.30.4	X-tag Examples	2-303
2.31	Trend Graph Display	2-306
2.31.1	Overview	2-306
2.31.2	About Trend Graphs	2-306
2.31.3	Using Trend Graphs	2-309
2.31.4	Channel Settings	2-318
2.31.5	Block Display Mode (for PLC Direct Access)	2-321
2.31.6	Principles of Historical Function	2-325
2.31.7	Trend Graph Data's CSV File Storage Example	2-331

3 Special Features

3.1	D-Script / Global D-Script	3-1
3.1.1	Overview	3-1
3.1.2	About D-Script	3-1
3.1.3	Using D-Script	3-5
3.1.4	D-Script / Global D-Script Limitations	3-62
3.1.5	Notes on Operation Results	3-66
3.1.6	Logical Operation Examples	3-67
3.1.7	Bit Operation Examples	3-68
3.1.8	Conditional Branches	3-69
3.1.9	Application Example (1)	3-70
3.1.10	Application Example (2)	3-73
3.1.11	Extended SIO Data Transfer Settings	3-74
3.2	Extended SIO Script	3-93
3.2.1	Overview	3-93
3.2.2	Details	3-94

3.2.3	Setting Parameters	3-99
3.2.4	Example Communication Using Extended SIO	3-160
3.3	Data Sampling Settings	3-172
3.3.1	Overview	3-172
3.3.2	About Data Sampling Settings	3-172
3.3.3	Using Channel Settings	3-173
3.3.4	Data Sampling CSV File Storage Example	3-177
<hr/>		
4	Advanced Features	
4.1	Sound Output	4-1
4.1.1	Overview	4-1
4.1.2	About Sound Output	4-1
4.1.3	Sound Output Settings	4-2
4.1.4	Sound Output Setting Examples	4-4
4.1.5	Sound Data Output	4-8
4.2	Filing Data (Recipe) Function	4-13
4.2.1	Overview	4-13
4.2.2	Filing Data (Recipe) Function	4-12
4.2.3	Filing Data Setting	4-21
4.2.4	Filing Data List	4-25
4.2.5	Filing Data Setup	4-37
4.2.6	Automatic Filing Data Transmission	4-36
4.2.7	Manual Filing Data Transmission Example 1	4-38
4.2.8	Manual Filing Data Transmission Example 2	4-45
4.3	Logging Function	4-49
4.3.1	Logging Function	4-51
4.3.2	Logging Data Read Timing	4-55
4.3.3	Using the Logging Function	4-57
4.3.4	Display Settings	4-70
4.3.5	Print Settings	4-81

TABLE OF CONTENTS

4.3.6	Excel Display of Logging Data	4-92
4.3.7	Data Logging Display Usage Example	4-95
4.3.8	Economy Mode	4-100
4.4	CSV Data Transfer Function	4-105
4.4.1	Overview	4-105
4.4.2	Details	4-107
4.4.3	List of Condition Settings	4-108
4.4.4	Condition Setting	4-111
4.4.5	CSV File List	4-114
4.4.6	Automatic Transfer Operation on the GP	4-116
4.4.7	Manual Transfer Operation on the GP	4-137
4.4.8	Example of Automatic Transfer for Filing Application (Conditional Operation)	4-140
4.4.9	Example of Automatic Transfer for Filing Application (Address Operation)	4-144
4.4.10	Example of Manual Transfer for Filing Application	4-149
4.4.11	Example of Transfer for Logging Application (1)	4-150
4.4.12	Example of Transfer for Logging Application (2)	4-152
4.5	CSV Data Display Function	4-158
4.5.1	Overview	4-158
4.5.2	Details	4-158
4.5.3	Setting Parameters	4-158
4.5.4	CSV Data Display (Combination)	4-162
4.5.5	CSV Data Editing Function	4-167
4.5.6	Printing CSV Data	4-169
4.6	File Manager Display Function	4-171
4.6.1	Overview	4-171
4.6.2	Details	4-171
4.6.3	Setting Parameters	4-173
4.6.4	File Manager Display Function	4-175

4.7	Using the CF Card	4-180
4.7.1	Overview	4-180
4.7.2	CF Card Features	4-181
4.7.3	CF Card Usage Cautions	4-180
4.7.4	External Storage of GP-PRO/PB III data	4-182
4.7.5	CF Card Data Output Folder Settings	4-185
4.7.6	Transferring Data from Output Folder to CF Card	4-184
4.7.7	Using the GP's OFFLINE Mode	4-185
4.7.8	Transferring Data from Backup SRAM to CF Card	4-187
4.7.9	Making a Backup of Backup SRAM	4-191
4.7.10	Screen Capture	4-197
4.7.11	Checking the CF Card's Available Capacity	4-205
4.8	Serial-Code Reader Compatibility	4-206
4.8.1	Overview	4-206
4.8.2	Compatible Serial-Code Readers	4-207
4.8.3	Outline of Operation	4-207
4.8.4	Action Settings	4-206
4.8.5	GP System Settings	4-213
4.8.6	LS Storage Start Address Settings	4-213
4.8.7	Extended Settings	4-212
4.8.8	Extended SIO Communication Settings	4-214
4.9	Bar-Code Reader Compatibility	4-215
4.9.1	Overview	4-215
4.9.2	Bar-Code Reader Features	4-214
4.9.3	Tested Bar Code Readers	4-217
4.10	256-color Mode	4-229
4.10.1	Overview	4-228
4.10.2	256-color Mode Correspondence	4-228
4.10.3	Monochrome (eight levels of gray) mode	4-230

4.11	Backup SRAM Capacity	4-232
4.11.1	Overview	4-233
4.11.2	Backup SRAM Amounts for each type of GP	4-233
4.11.3	Backup SRAM Applications	4-233
4.12	Extended Functions of VM Unit	4-235
4.12.1	Displaying Video Window	4-235
4.12.2	Video Control Area	4-236
4.12.3	Standard Mode	4-237
4.12.4	Extended Mode	4-242
4.12.5	Video Control Area Example	4-250
4.12.6	Vide Control Area Settings	4-261
4.12.7	VGA/SVGA Display Function	4-267
4.12.8	Converting GP-530VM/GP-570VM Screens	4-269

Index

1 GP Display Data Types

The GP unit provides a real-time interactive display of data stored in the host (PLC). This chapter describes the many types of functionality you can create on your GP's screen.

1.1 Screen File Types

Please look at the following list of GP file/screen types. This program utilizes six types of files/screens, each of which has a different purpose.

Screen Type	Screen File Number	Description	Maximum Screen Size
Base Screen (B file)	B1 - B8999	Appears on the GP display while the GP is operating. Objects used as either a static graphic or in a moving image can be called up from other Base screens and used like building blocks. Base screen objects can be also registered as a window, which can then be opened temporarily on another screen.	Approx. 16 KB
Mark Screen (M file)	M1 - M8999	Displays user-created dot-based marks or symbols up to a maximum of 48 x 48 pixels. These marks can be either fixed or moving images on the Base screens.	Approx. 576 bytes
Trend Graph screen (T file)	T1 - T8999	Displays graph axes and graduations, and sets the parameters used for trend graphs. This screen can be called up and used on a Base screen.	Approx. 16 KB
Keyboard screen (K file)	K1 - K8999	Displays a keypad, which is used for entering alphanumeric characters or symbols. This screen can be called up and used on a Base screen.	Approx. 16 KB
Text screen (X file)	X1 - X8999	Displays only text, or character data. A Text screen can be created by entering characters directly, or by pasting text data previously edited with a text editor. This screen is used with screens that contain moving images.	Approx. 53 KB
Image Library screen (I file)	I1 - I8999	Contains graphic images converted from bitmap data. Image screens can be either fixed, or used with Base screens that contain moving images.	Approx. 58 KB
Video screen (V file)	V1 to V512	This screen is used to set the display of video input. Images can be used from video cameras, PC monitors or JPEG files.	Approx. 16 KB
Window screen (U file)	U1 to U2000	This screen is used for making Window settings. Windows created on the Base screen or Window screen are called up and displayed on the Base screen.	Approx. 16 KB

The initial letter of each file's name is called its "*Screen Header*."



Note: With the GP-PRO/PB III, even though up to 8,999 screens can be created for each of the above mentioned file types (up to 512 video screens and up to 2000 window screens), the number of files storable in the GP depends on the size of each screen and the computer's available memory, floppy disk or hard disk space.

1.2 Active Image Functions

The GP displays data from the host (PLC) in real time, using pictures, text, and graphic images the user has created via the GP-PRO/PBIII drawing software. The GP also has touch panel keys which, together with these functions, send the data you enter to the host (PLC). These functions are referred to as “Active Image” functions. When using Active Image screens, information such as which data in the host (PLC) to use, data’s format and location on the screen, must all be defined in advance and stored in the GP. These Active Image screens change the GP panel from a simple display monitor to an intelligent and valuable operation panel.

■ Wide Range of Functions

Active Image type display functions include 23 different kinds of pre-made “Parts” and 31 different kinds of “Tags,” as well as an “Alarm Message Display,” “Trend Graph Display”, “D Script”, “Extended SIO Script”, “Data Sampling Settings”, as well as “CSV Data Transfer Function”, “Filing Data Function”, “Logging Function”, and “Sound Output” which all widen the application usage.

“Parts”, seen in the GP-PRO/PBIII Editor screen’s right side icon box, are a collection of pre-made, often used object’s icons.

Creating an Active Image display is easy. Simply click on the type of Part you wish to use, designate the necessary PLC addresses, and position the item on your current screen. This simplicity greatly reduces the amount of time required to create and edit a given screen.

“Tags”, which are explained in detail in this manual, are useful for when you wish to create unique, original screens. This manual has been created expressly to explain the types of Tags available, and how they can add useful object movement functionality to your GP unit’s applications.

■ Creating Active Images

Use your screen editing software, GP-PRO/PB III for Windows, to create project files containing Active Image screens. This project file will then be downloaded to the GP, together any necessary system data. The GP will then use this information to communicate with the host (PLC).

■ Exception Tags

While most Parts and Tags are placed on Base screens, there are the following exceptions:

Exception 1:

k-tags are normally, first, placed on the Keyboard screens, and then later, called up on a Base screen. (Can also be placed directly on a Base screen)

▼ Reference ▲ *k-tag (Keyboard Setup)*

Exception 2:

U-tags are normally placed on the Base screen. Windows can be registered in a Window screen (U file) or in a Base screen. U-tags for Global Windows can be set in the “GP System”, and the window’s display is controlled in the System Area.

▼ Reference ▲ *Window Display (U-tag), Operation Manual , 3.7 Window Display: (U) Screen and Base (B) Screen*

Exception 3:

a-tags and Q-tags are normally created on Base screens, however, some parameters such as display messages must be registered on Alarm Editor screens.

▼ Reference ▲ *Alarm Summary Display (a-tag), Alarm History Display (Q-tag)*

Exception 4:

A-tags and X-tags are normally created on Base screens, however, Display Message Registration and other features must be set in a Text screen.

▼ Reference ▲ *Alarm Summary (Text) Display (A-tag), Text Data Display (X-tag)*

■ Create an “Alarm Message Display”

To create an Alarm Message display, use the Alarm Editor to edit the messages and set the related parameters. You can also use the Alarm Editor to set the order in which messages are displayed or to display the messages in the order that they occur. After all settings are entered, save the screen and download it to the GP. The GP will then display alarm messages based on your settings.

■ Create a “Trend Graph Display”

To create a Trend Graph display, use the Trend Graph screen to enter the required parameters. After creating the screen, save it and load it onto a Base screen. Next, download all the related screens to the GP, which will then display.

■D-Script Reduces Your PLC Programming

“D-Script” programs are created via the D-Script editor. As a substitution to the PLC ladder program for display, language type script programming (D-Script) can be used to create a display program. Thus, the GP can perform data processing internally, thereby reducing the PLC’s processing load.

■Communicate with Extended SIO (Extended serial interface) via the Extended SIO Script

The “Extended SIO Script” is a D-Script dedicated to communication between the Extended SIO (extended serial interface) built into the GP and the I/O device connected to the GP.

The Extended SIO Script will function as program-independent from the tag processing on the screen.

■Register “Filing Data” via the Filing Data List

Use the Filing Data List to register filing data. The filing data function represents a function to register set values, such as recipes as files to the GP and to send those values to the PLC devices due to an event, etc. This Filing Data is stored in either the GP’s internal memory or in a CF card. To send Filing Data to a PLC, place a File Name Display and select the desired data to be sent.

■Log PLC Data Using the “Logging Function”

Using the “Logging Function”, PLC device data is logged and stored in the back-up SRAM via the settings registered as the “Logging Settings”. This logged data can also be stored on a CF card.

■Register Sounds via “Sound Data”

Previously created “Sound Data” is registered in the GP as sound data. This data can be stored in the GP’s internal memory or on a CF card. Sounds are then output from a speaker using the settings registered in the sound settings area.

■Transfer data files in CSV format using CSV Data Transfer Function

The CSV Data Transfer Function enables the transfer of data in CSV file format (CSV data) between the CF Card and PLC. Since the data are transferred in the form of a CSV file, data creation and editing can be performed with general-purpose spreadsheet software.

1.3 Tag List (Alphabetical Order)

Tag Names	Description	Comments
Alarm Summary TEXT Display (A-tag)	Displays text messages registered on Text screens in rows, according to the host's (PLC's) bit address data changes. The desired rows can be displayed in an Alarm Summary. Using combinations of other tags, sub screens corresponding to each message can also be displayed.	*1
Alarm Summary Display (a-tag)	Lists the alarm messages registered in the Alarm Editor, according to the host's (PLC's) bit address data changes.	*1
Time Display (C-tag)	Displays the time, based on the GP's internal clock.	
Statistical Graph Display (D-tag)	Displays a statistical graph, which represents data in the host's (PLC's) consecutive related word addresses as percentages of a total.	
Statistical Data Display (d-tag)	Displays numeric values according to the data in the host's (PLC's) consecutive related word addresses.	
Numeric Data Display (expanded N-tag function) (E-tag)	Displays numeric data in real time, as the data in the host's (PLC's) word address changes. The color of the display can be set to show movement within preset data ranges. Data can be displayed in decimal, hexadecimal, BCD, binary, octal, and floating-point format.	
"Free" Library Display (F-tag)	Brings up a library object in the position designated by the PLC word address data. The object may then be moved to any position on the GP display.	
Graph Display (G-tag)	Uses bar, pie, or half-pie graphs to display host (PLC) word address data in real time.	
Graph Display (expanded G-tag function) (g-tag)	Uses bar, pie, or half-pie graphs to display host (PLC) word address data in real time. The color of the display can be set to show movement within preset data ranges.	
Object Drawing (H-tag)	Draws objects such as straight lines, rectangles circles, etc. at the desired screen coordinates using host (PLC) Word Address data.	*4
Moving Mark Display (J-tag)	Places an object and moves it along a preset rail (created by an R-tag). (Use in conjunction with the R-tags.)	
Key Input (K-tag)	Allows you to enter character or numeric data through either a touch keyboard (set up via k-tags), a barcode reader, or a standard PC keyboard. This data is stored in the host's (PLC's) designated word address.	*1
Keyboard Setup (k-tag)	Provides a touch keyboard for inputting data settings to touch panel switches. Use in combination with the K-tags.	*1
Library Display (L-tag)	Displays Base or Image Library screen objects or text previously registered in libraries. These items will be either displayed or not displayed, according to the host's (PLC's) data.	
Library State Change Display (I [small L] -tag)	A variety of Base or Image Library screen data previously registered as library items can be set to appear whenever there is a change in the hosts (PLCs) word device data, activates a response. This is a special L-tag function.	
Mark Display (M-tag)	Marks, which are bit-mapped icon images created in Mark screens, are used on Base screens to reflect changes in host (PLC) data.	

Tag Names	Description	Comments
Numeric Display (N-tag)	Used to display a numeric value from the host's (PLC's) word address.	
Alarm Boundary Display (n-tag)	Displays the upper and lower limits of the alarm range set in K-tags.	
Numeric Display in Pre-defined Format (P-tag)	Displays host (PLC) word address data as an absolute value, using a pre-defined format.	
Alarm Summary Display (Q-tag)	Lists alarm messages registered in the Alarm Editor in historical order, and in response to host (PLC) bit changes. The messages in the summary display can be listed as either active, history, or log. When used in combination with other tags, messages can be checked, deleted, sub-displayed and so on.	*1
Rail Settings (R-tag)	Defines the rail (track) along with a preset Mark (set via a J-tag) moves. Used together with the J-tag.	
String Display (S-tag)	Displays character string data stored in the host's (PLC's) word address.	*1 *4
Touch Panel Input (T-tag)	T-tags interpret touch area on the Graphic Panel for the host (PLC). When the user presses one of these defined touch area, the action defined by the associated T-tag is performed.	*1
Selector Switch Input (t-tag)	Provides a touch panel object which looks and operates like a selector switch. Each time the object "switch" is pressed, one switch address turns OFF and another address bit turns ON.	*1
Inching Function (Tih and Tiw tags)	Sends "inching output" from the touch panel (GP) directly to a digital input (DIN) relay on the host (PLC) via the GP's AUX I/O interface (hereafter referred to as "AUX I/F". This allows instantaneous fine adjustment to be performed, using just the touch panel keys.	*2
Window Display (U-tag)	In response to host (PLC) word address changes, this function places a window screen over the currently displayed Base screen.	
Video Window Display (V-tag)	This tag is supported by the GP-570VM and GP-870VM units, and the GP2500/2600 series units (with optional VM unit attached). This tag lays a special window screen, used for displaying video input data, over the currently displayed Base screen.	
Extended Video Window Display (v-tag)	For use with GP-2500/GP-2600 Series interfaces. Requires attachment of optional VM unit. Displays video input screens on a Base screen.	
Write to Device (W-tag)	Writes data to a word address, or either sets or resets a bit in response to host (PLC) word address changes.	
Display Text Data (X-tag)	Displays text data (only characters) registered on a Text screen in response to host (PLC) word address changes.	*1
Alarm Message Display	In response to changes in the host's (PLC's) bit address, lists alarm messages registered in the Alarm Editor at the bottom of the screen.	*1
Trend Graph Display	Displays a trend graph that shows the change of a value overtime in the host's (PLC's) word address data.	*1

Tag Names	Description	Comments
D-Script	Design your own program and execute it on the GP to provide additional display functions. D-Script programs also help to reduce the PLC's data display load.	
Extended SIO Script	D-Script dedicated to communication between the Extended SIO (extended serial interface) built into the GP and the I/O device connected to the GP.	*3
Data Sampling Settings	Designated Word Address data can be stored in the LS Area in time series order.	*4
Filing Data Function	Filing data such as the previously registered recipe data can be sent to the PLC as desired.	*5
Logging Function	Logs and stores the PLC's data to the backup SRAM periodically or when the PLC triggers. Also, the logged data can be stored in a CF card.	*5
CSV Data Transfer Function	Data files can be transferred between the CF Card and PLC in CSV format (CSV data).	*6
Sound Output	Sounds are output according to the host's bit changes.	*7
Vibration	Runs the internal motor and vibrates the GP. (Vibration function)	*8

*1 Contains items whose functions change according to the GP's screen size and installation orientation (i.e. portrait or landscape).

▼Reference▲ Chapter 2 Active Image Functions

*2 GP-270, GP-370, GP-H70, GP-377, GP-377R, GP37W2 and GP-2000 Series units do not support this feature.

▼Reference▲ 1.5 Tag List of Support

*3 Available only with GP2000 Series units featuring built-in Extended SIO (Excluding GP-2301, GP-2401, GP-2501 and GP-2601 Series).

*4 GP-270 does not support this feature.

▼Reference▲ 1.5 Tag List of Support

*5 Available only with the GP77R, GP-377 and GP2000 Series units. The CF card interface comes standard with the GP2000 Series units. When attaching the multi unit to the GP77R units, the CF card can be used. The CF card cannot be used with the GP-377 Series units.

▼Reference▲ Operation Manual, Functions for GP-PRO/PBIII for Windows to Ver. 6.2

*6 This function is supported only by GP2000 Series units

*7 This feature is available only with GP-477R, GP-577R, and GP2000 Series units (except GP-2300, GP-2301, and GP2000H Series units). An optional Multi Unit (sold separately) is required for outputting sound data from the GP with GP-477R, GP-577R, GP-2401, GP-2501 and GP-2601 Series units.

Feature	GP2000 Series (except GP-2300/2301/2000H)	GP-2501, GP-2601 Series + Large-size Multi Unit (bus conversion unit)	GP-477R/577R + Large-size Multi Unit
Sound Output	○	○	○

*8 This function is supported only by GP2000H Series units (excluding GPH70 compatible mode).

1.4 Tag List (Function Order)

Screen Operation	Function Name	Outline	Comments
Touch Switch	k-tag (Key board Setup)	Provides a touch keyboard for inputting data settings to touch panel switches. Use in combination with the K-tags.	*1
	T-tag (Touch Panel Input)	T-tags interpret touch area on the Graphic Panel for the host (PLC). When the user presses one of these defined touch areas, the action defined by the associated T-tag is performed.	*1
	t-tag (Selector Switch Input)	Provides a touch panel object which looks and operates like a selector switch. Each time the object "switch" is pressed, one switch address turns OFF and another address bit turns ON.	*1
	Tih and Tiw tags (Inching Function)	Sends "inching output" from the touch panel (GP) directly to a digital input (DIN) relay on the host (PLC) via the GP's AUX I/O interface (here after referred to as "AUX I/F"). This allows instantaneous fine adjustment to be performed, using just the touch panel keys.	*2
Numeric Display	C-tag (Time Display)	Displays the time, based on the GP's internal clock.	
	E-tag (Numeric Data Display: expanded N-tag function)	Displays numeric data in real time, as the data in the host's (PLC's) word address changes. The color of the display can be set to show movement within preset data ranges. Data can be displayed in decimal, hexadecimal, BCD, binary, octal, and floating-point format.	
	K-tag (Key Input)	Allows you to enter character or numeric data through either a touch keyboard (set up via k-tags), a barcode reader, or a standard PC keyboard. This data is stored in the host's (PLC's) designated word address.	*1
	N-tag (Numeric Display)	Used to display a numeric value from the host's (PLC's) word address.	
	n-tag (Alarm Boundary Display)	Displays the upper and lower limits of the alarm range set in K-tags.	
	P-tag (Numeric Display in Pre-defined Format)	Displays host (PLC) word address data as an absolute value, using a pre-defined format.	
Graph Display	D-tag (Statistical Graph Display)	Displays a statistical graph, which represents data in the host's (PLC's) consecutive related word addresses as percentages of a total.	
	d-tag (Statistical Data Display)	Displays numeric values according to the data in the host's (PLC's) consecutive related word addresses.	
	G-tag (Graph Display)	Uses bar, pie, or half-pie graphs to display host (PLC) word address data in real time.	

Screen Operation	Function Name	Outline	Comments
Graph Display	g-tag (Graph Display: expanded G-tag function)	Displays bar, pie, or half-pie graphs to display host (PLC) word address data in real time. The color of the display can be set to show movement within preset data ranges.	
	Trend Graph Display	Displays a trend graph that shows the change of a value overtime in the host's (PLC's) word address data.	*1 *4
Animation	F-tag ("Free" Library Display)	Brings up a library object in the position designated by the PLC word address data. The object may then be moved to any position on the GP display.	
	H-tag (Object Drawing)	Draws objects such as straight lines, rectangles circles etc. at the desired coordinates using the host (PLC) Word Address data .	*4
	J-tag (Moving Mark Display)	Places an object and moves it along a preset rail (created by an R-tag). (Used in conjunction with the R-tags.)	
	L-tag (Library Display)	Displays Base or Image Library screen objects or text previously registered in libraries. These items will be either displayed or not displayed, according to the host's (PLC's) data.	
	I [small L] -tag (Library State Display)	A variety of Base or Image Library screen data previously registered as library items can be set to appear whenever there is a change in the host's (PLC's) word device data. This is a special L-tag function.	
	M-tag (Mark Display)	Marks, which are bit-mapped icon images created in Mark screens, are used on Base screens to reflect changes in host (PLC) data.	
	R-tag (Rail Settings)	Defines the rail (track) along which a preset Mark (set via a J-tag) moves. Used together with the J-tag.	
Character Display	A-tag (Alarm Summary TEXT Display)	Displays text messages registered on Text screens in rows, according to the host's (PLC's) bit address data changes. The desired rows can be displayed in an Alarm Summary. Using combinations of other tags, sub screens corresponding to each message can also be displayed.	*1
	a-tag (Alarm Summary Display)	Lists the alarm messages registered in the Alarm Editor, according to the host's (PLC's) bit address data changes.	*1
	Q-tag (Alarm Summary Display)	Lists alarm messages registered in the Alarm Editor in historical order, and in response to host (PLC) bit changes. The messages in this summary display can be listed as either active, history, or log. When used in combination with other tags, messages can be checked, deleted, or sub-displayed.	*1 *5
	S-tag (String Display)	Displays character string data stored in the host's (PLC's) word address.	*1 *4
	X-tag (Display Text Data)	Displays text data (only characters) registered on a Text screen in response to host (PLC) word address changes.	*1
Action	W-tag (Write to Device)	Writes data to a word address, or either sets or resets a bit in response to host (PLC) word address changes.	

Screen Operation	Function Name	Outline	Comments
Window Display	U-tag (Window Display)	In response to host (PLC) word address changes, this function places a window screen over the currently displayed Base screen.	
	V-tag (Video Window Display)	This tag is supported only by the GP-570VM, GP-870VM models, and GP2500/2600 with a VM unit. This tag lays a special window screen, used for displaying video data, over the currently displayed Base screen. Up to three different video channels can be used.	
	Extended Video Window Display (v-tag)	For use with GP-2500/GP-2600 Series interfaces. Requires attachment of optional VM unit. Displays video input screens on a Base screen.	
Special Function	D-Script	Design your own program and execute it on the GP to provide additional display functions. D-Script programs also help to reduce the PLC's data display load.	
	Extended SIO Script	D-Script dedicated to communication between the Extended SIO (extended serial interface) built into the GP and the I/O device connected to the GP.	*3
	Data Sampling Setting	A desired Word Address data can be stored in the LS Area in time series.	*4
Advanced Feature	Filing Data Function	Filing data such as the previously registered recipe data can be sent to the PLC as desired.	*5
	Logging Function	Logs and stores the PLC data to the backup SRAM periodically or when the PLC triggers. Also, the logged data can be stored in a CF card.	*5
	CSV Data Transfer Function	Data files can be transferred between the CF Card and PLC in CSV format (CSV data).	*6
	Sound Output	Sounds are output according to the host's bit changes.	*7
	Vibration	Runs the internal motor and vibrates the GP. (Vibration function)	*8

*1 Contains items whose functions change according to the GP's screen size and installation orientation (i.e. portrait or landscape).

Reference Chapter 2 Active Image Functions

*2 GP-270, GP-370, GP-H70, GP-377, GP-377R, GP37W2 and GP2000 Series units do not support this feature.

Reference 1.5 Tag List of Support

*3 Available only with GP2000 Series units featuring built-in Extended SIO (GP-2301, GP-2401, GP-2501 and GP-2601 Series).

*4 GP-270 does not support this feature.

Reference 1.5 Tag List of Support

*5 Available only with the GP77R, GP-377 and GP2000 Series units. The CF card interface comes standard with the GP2000 Series units. When attaching the multi unit to the GP77R units, the CF card can be used. The CF card cannot be used with the GP-377 Series units.

▼Reference▲ Operation Manual, Functions for GP-PRO/PBIII for Windows Ver. 6.2

*6 This function is supported only by GP2000 Series units

*7 This feature is available only with GP-477R, GP-577R, and GP2000 Series units (except GP-2300, GP-2301, and GP2000H Series units). An optional Multi Unit (sold separately) is required for outputting sound data from the GP with GP-477R, GP-577R, GP-2401, GP-2501 and GP-2601 Series units.

Feature	GP2000 Series (except GP-2300/2301/2000H)	GP-2501, GP-2601 Series + Large-size Multi Unit (bus conversion unit)	GP-477R/577R + Large-size Multi Unit
Sound Output	○	○	○

*8 This function is supported only by GP2000H Series units (excluding GPH70 compatible mode).

1.5 Tag List of Support

GP70 Series

○ : Supported ● : Depends on model X : Not supported

Function Name	Item	GP-H70 GP-370 GP-57JS	GP-270	GP-470	GP-570	GP-571	GP-675	GP-570VM	GP-870VM	GP-377L/S	GP377 W2B
Alarm summary Text display A-tag	General function	○	○	○	○	○	○	○	○	○	○
	Text screen, sub- display screen: indirect setting	×	×	×	×	×	×	×	×	○	○
	Blank Line Display	×	×	×	×	×	×	×	×	○	○
Alarm summary display a-tag	General function	○	○	○	○	○	○	○	○	○	○
Time display C-tag	General function	○	○	○	○	○	○	○	○	○	○
	Back ground color (Bg) tiling	○	×	○	○	○	○	○	○	○	○
Statistical graph display D-tag	General function	○	○	○	○	○	○	○	○	○	○
Statistical data display d-tag	General function	○	○	○	○	○	○	○	○	○	○
Numeric data display (Expanded function) E-tag	General function	○	○	○	○	○	○	○	○	○	○
	Corresponding range: indirect setting	○	×	○	○	○	○	○	○	○	○
	Back ground color (Bg) tiling	○	×	○	○	○	○	○	○	○	○
	Color: indirect setting	○	×	○	○	○	○	○	○	○	○
"Free" Library Display F-tag	General function	○	○	○	○	○	○	○	○	○	○
Graph Display G-tag	General function	○	○	○	○	○	○	○	○	○	○
	Back ground color	×	×	×	×	×	×	×	×	○	○
Graph Display (Expanded function) g-tag	General function	○	○	○	○	○	○	○	○	○	○
	Corresponding range: indirect setting	○	×	○	○	○	○	○	○	○	○
	Color blocks display	○	×	○	○	○	○	○	○	○	○
	Color: indirect setting	○	×	○	○	○	○	○	○	○	○
Object drawing H-tag	General function	○	○	○	○	○	○	○	○	○	○
	Graphic drawing function	○	×	○	○	○	○	○	○	○	○
Moving mark display J-tag	General function	○	○	○	○	○	○	○	○	○	○
Key input K-tag	General function	○	○	○	○	○	○	○	○	○	○
	Color: indirect setting	○	×	○	○	○	○	○	○	○	○
	Change color using bits	○	×	○	○	○	○	○	○	○	○
Keyboard setup k-tag	General function	○	○	○	○	○	○	○	○	○	○
Library display L-tag	General function	○	○	○	○	○	○	○	○	○	○

Function Name	Item	GP-H70 GP-370 GP-57JS	GP-270	GP-470	GP-570	GP-571	GP-675	GP-570VM	GP-870VM	GP-377L/S	GP-37W2B
Mark display M-tag	General function	○	○	○	○	○	○	○	○	○	○
Numeric display N-tag	General function	○	○	○	○	○	○	○	○	○	○
Alarm boundary display n-tag	General function	○	○	○	○	○	○	○	○	○	○
Numeric display in pre-defined format	General function	○	○	○	○	○	○	○	○	○	○
Alarm summary display Q-tag	General function	○	○	○	○	○	○	○	○	○	○
	Q-tag sub display	○	×	○	○	○	○	○	○	○	○
	Q-tag display mode Date and Time	×	×	×	×	×	×	×	×	×	×
	Q-tag display format setting	○	×	○	○	○	○	○	○	○	○
	Q-tag second display	○	×	○	○	○	○	○	○	○	○
	Q-tag color print setting	×	×	×	○	○	○	○	○	×	×
	Q-tag backup	×	×	●	●	○	○	×	×	○	○
	Q-tag alarm block creation	×	×	×	×	×	×	×	×	○	○
	Q-tag batch print	×	×	×	×	×	×	×	×	×	×
Q-tag external operation	×	×	×	×	×	×	×	×	○	○	
Rail settings R-tag	General function	○	○	○	○	○	○	○	○	○	○
String display S-tag	General function	○	○	○	○	○	○	○	○	○	○
	S-tag background color (Bg) tiling	○	×	○	○	○	○	○	○	○	○
Touch panel input T-tag	General function	○	○	○	○	○	○	○	○	○	○
	T-tag digit add/subtract function	×	×	×	×	×	×	×	×	○	○
	T-tag interlock touch available condition	×	×	×	×	×	×	×	×	○	○
	T-tag radio switch function	○	×	○	○	○	○	○	○	○	○
	T-tag Auto-off (group)	×	×	×	×	×	×	×	×	○	○
Selector switch input t-tag	General function	○	○	○	○	○	○	○	○	○	○
Inching function Tih and Tiw tags	Inching output switch (Tih and Tiw -tags)	×	×	○	○	○	○	○	○	×	×
Window display U-tag	General function	○	○	○	○	○	○	○	○	○	○
Video window display V-tag	General function	×	×	×	×	×	×	○	○	×	×
Write to device W-tag	General function	○	○	○	○	○	○	○	○	○	○

GP77R/GP2000 Series

Function Name	Item	GP-377R	GP-477R	GP-577R	GP-2300	GP-2301 GP-2301H GP-2401H	GP-2400 GP-2401 GP-2501 GP-2601	GP-2500 GP-2600
Alarm summary Text display A-tag	General function	<input type="radio"/>	<input type="radio"/>	<input type="radio"/>	<input type="radio"/>	<input type="radio"/>	<input type="radio"/>	<input type="radio"/>
	Text screen, sub-display screen: indirect setting	<input type="radio"/>	<input type="radio"/>	<input type="radio"/>	<input type="radio"/>	<input type="radio"/>	<input type="radio"/>	<input type="radio"/>
	Blank Line Display	<input type="radio"/>	<input type="radio"/>	<input type="radio"/>	<input type="radio"/>	<input type="radio"/>	<input type="radio"/>	<input type="radio"/>
Alarm summary display a-tag	General function	<input type="radio"/>	<input type="radio"/>	<input type="radio"/>	<input type="radio"/>	<input type="radio"/>	<input type="radio"/>	<input type="radio"/>
Time display C-tag	General function	<input type="radio"/>	<input type="radio"/>	<input type="radio"/>	<input type="radio"/>	<input type="radio"/>	<input type="radio"/>	<input type="radio"/>
	Back ground color (Bg) tiling	<input type="radio"/>	<input type="radio"/>	<input type="radio"/>	<input type="radio"/>	<input type="radio"/>	<input type="radio"/>	<input type="radio"/>
Statistical graph display D-tag	General function	<input type="radio"/>	<input type="radio"/>	<input type="radio"/>	<input type="radio"/>	<input type="radio"/>	<input type="radio"/>	<input type="radio"/>
Statistical data display d-tag	General function	<input type="radio"/>	<input type="radio"/>	<input type="radio"/>	<input type="radio"/>	<input type="radio"/>	<input type="radio"/>	<input type="radio"/>
Numeric data display (Expanded function) E-tag	General function	<input type="radio"/>	<input type="radio"/>	<input type="radio"/>	<input type="radio"/>	<input type="radio"/>	<input type="radio"/>	<input type="radio"/>
	Corresponding range: indirect setting	<input type="radio"/>	<input type="radio"/>	<input type="radio"/>	<input type="radio"/>	<input type="radio"/>	<input type="radio"/>	<input type="radio"/>
	Back ground color (Bg) tiling	<input type="radio"/>	<input type="radio"/>	<input type="radio"/>	<input type="radio"/>	<input type="radio"/>	<input type="radio"/>	<input type="radio"/>
	Color: indirect setting	<input type="radio"/>	<input type="radio"/>	<input type="radio"/>	<input type="radio"/>	<input type="radio"/>	<input type="radio"/>	<input type="radio"/>
"Free" Library Display F-tag	General function	<input type="radio"/>	<input type="radio"/>	<input type="radio"/>	<input type="radio"/>	<input type="radio"/>	<input type="radio"/>	<input type="radio"/>
Graph Display G-tag	General function	<input type="radio"/>	<input type="radio"/>	<input type="radio"/>	<input type="radio"/>	<input type="radio"/>	<input type="radio"/>	<input type="radio"/>
	Back ground color	<input type="radio"/>	<input type="radio"/>	<input type="radio"/>	<input type="radio"/>	<input type="radio"/>	<input type="radio"/>	<input type="radio"/>
Graph Display (Expanded function) g-tag	General function	<input type="radio"/>	<input type="radio"/>	<input type="radio"/>	<input type="radio"/>	<input type="radio"/>	<input type="radio"/>	<input type="radio"/>
	Corresponding range: indirect setting	<input type="radio"/>	<input type="radio"/>	<input type="radio"/>	<input type="radio"/>	<input type="radio"/>	<input type="radio"/>	<input type="radio"/>
	Color blocks display	<input type="radio"/>	<input type="radio"/>	<input type="radio"/>	<input type="radio"/>	<input type="radio"/>	<input type="radio"/>	<input type="radio"/>
	Color: indirect setting	<input type="radio"/>	<input type="radio"/>	<input type="radio"/>	<input type="radio"/>	<input type="radio"/>	<input type="radio"/>	<input type="radio"/>
Object drawing H-tag	General function	<input type="radio"/>	<input type="radio"/>	<input type="radio"/>	<input type="radio"/>	<input type="radio"/>	<input type="radio"/>	<input type="radio"/>
	Graphic drawing function	<input type="radio"/>	<input type="radio"/>	<input type="radio"/>	<input type="radio"/>	<input type="radio"/>	<input type="radio"/>	<input type="radio"/>
Moving mark display J-tag	General function	<input type="radio"/>	<input type="radio"/>	<input type="radio"/>	<input type="radio"/>	<input type="radio"/>	<input type="radio"/>	<input type="radio"/>
Key input K-tag	General function	<input type="radio"/>	<input type="radio"/>	<input type="radio"/>	<input type="radio"/>	<input type="radio"/>	<input type="radio"/>	<input type="radio"/>
	Color: indirect setting	<input type="radio"/>	<input type="radio"/>	<input type="radio"/>	<input type="radio"/>	<input type="radio"/>	<input type="radio"/>	<input type="radio"/>
	Change color using bits	<input type="radio"/>	<input type="radio"/>	<input type="radio"/>	<input type="radio"/>	<input type="radio"/>	<input type="radio"/>	<input type="radio"/>
Keyboard setup k-tag	General function	<input type="radio"/>	<input type="radio"/>	<input type="radio"/>	<input type="radio"/>	<input type="radio"/>	<input type="radio"/>	<input type="radio"/>
Library display L-tag	General function	<input type="radio"/>	<input type="radio"/>	<input type="radio"/>	<input type="radio"/>	<input type="radio"/>	<input type="radio"/>	<input type="radio"/>
Library state change display I (small L) tag	General function	<input type="radio"/>	<input type="radio"/>	<input type="radio"/>	<input type="radio"/>	<input type="radio"/>	<input type="radio"/>	<input type="radio"/>
Mark display M-tag	General function	<input type="radio"/>	<input type="radio"/>	<input type="radio"/>	<input type="radio"/>	<input type="radio"/>	<input type="radio"/>	<input type="radio"/>
Numeric display N-tag	General function	<input type="radio"/>	<input type="radio"/>	<input type="radio"/>	<input type="radio"/>	<input type="radio"/>	<input type="radio"/>	<input type="radio"/>

Function Name	Item	GP-377R	GP-477R	GP-577R	GP-2300	GP-2301 GP-2301H GP-2401H	GP-2400 GP-2401 GP-2501 GP-2601	GP-2500 GP-2600
Alarm boundary display n-tag	General function	○	○	○	○	○	○	○
Numeric display in pre-defined format P-tag	General function	○	○	○	○	○	○	○
Alarm summary display Q-tag	General function	○	○	○	○	○	○	○
	Q-tag sub display	○	○	○	○	○	○	○
	Q-tag display mode Date and Time	×	×	×	○	○	○	○
	Q-tag display format setting	○	○	○	○	○	○	○
	Q-tag second display	○	○	○	○	○	○	○
	Q-tag color print setting	○*1	×	○	●	×	○	○*3
	Q-tag backup	○	○	○	○	○	○	○
	Q-tag alarm block creation	○	○	○	○	○	○	○
	Q-tag batch print	○*1	○	○	○	×	○	○
	Q-tag external operation	○	○	○	○	○	○	○
Rail settings R-tag	General function	○	○	○	○	○	○	○
String display S-tag	General function	○	○	○	○	○	○	○
	S-tag background color (Bg) tiling	○	○	○	○	○	○	○
Touch panel input T-tag	General function	○	○	○	○	○	○	○
	T-tag digit add/subtract function	○	○	○	○	○	○	○
	T-tag interlock touch available condition	○	○	○	○	○	○	○
	T-tag radio switch function	○	○	○	○	○	○	○
	T-tag Auto-off (group)	○	○	○	○	○	○	○
Selector switch input t-tag	General function	○	○	○	○	○	○	○
Inching function Tih and Tiw tags	Inching output switch (Tih and Tiw tags)	×	○	○	×	×	×	×
Window display U-tag	General function	○	○	○	○	○	○	○
Video window display V-tag	General function	×	×	×	×	×	×	○*2,4

1. A middle-size Multi Unit E is required to enable this function.
2. A GP2000 Series VM unit is required to enable this function.
3. Not supported by the GP2500L unit.
4. Not supported by the GP2500L and GP2500S units.

1.6 Tag Setting Cautions

Please be aware of the following when setting tags on GP screens.

■ Tag Descriptions

A Description can be entered whenever you create a tag. Entering a description, allows you to see the descriptions when you input or edit the tag.

- ◆ Left click on the Description field. A maximum of 20 single-byte or 10 double-byte characters can be entered.

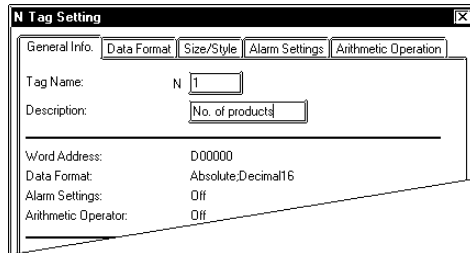

- ◆ Tag descriptions can be read in the Tag List.

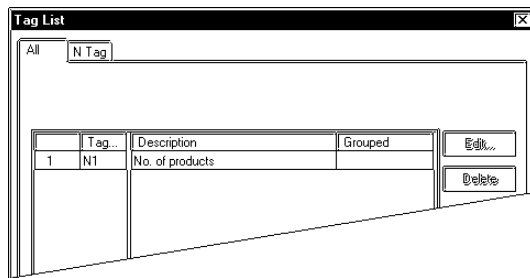

■ Tag Limits

The maximum number of tags that can be displayed on a screen (including currently displayed window screens) is as follows.

GP Series	GP-470 GP-570 GP-675 Series	GP-270 GP-370 GP-H70 Series	GP-377R GP-477R GP-577R Series	GP-377 Series	GP2000 Series
Number of valid tags	256	128	384	384	384
Number of R-tag positions	512	256	512	512	512

R-tags have another limitation in addition to the number of tags; R-tags can use up to 512 positions in total (up to 256 positions for GP-270, GP-370, and GP-H70). Parts and D-Scripts are also included in the tag count. However, there are some parts, such as library parts, which are not counted as one tag per part. The D-Script count will vary according to the program size. As a guide, three addresses used in D-Script programming are counted as a single tag.

Please refer to the following diagram for the number of effective tags.
 <E.g.: When using a GP-470>

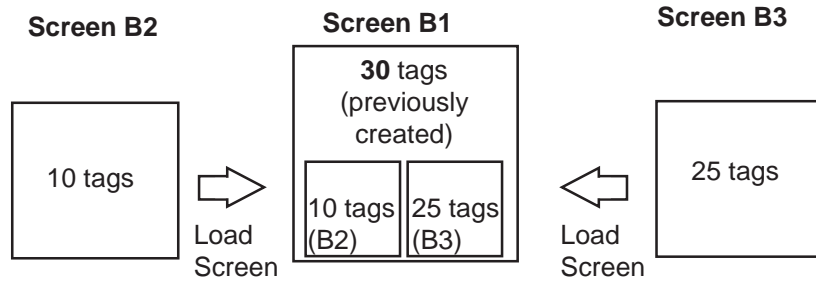

$$\text{Combined number of Tags} = 10(\text{B2}) + 25(\text{B3}) + 30(\text{B1}) = 65 \leq 256$$

The total number of tags used can be monitored in the Editor's Screen Data window.

Reference GP-PRO/PBIII Operation Manual, 4.2.5 Information Display



- When placing multiple tags on a screen, if the tags and Parts superimpose each other, the display may not appear correctly. Be careful when placing tags and Parts.
- When a screen has been loaded into another screen, it cannot be edited in the screen it has been loaded onto. For example, in the previous diagram, although B2 and B3 tags count as tags in the B1 screen, these screens and tags cannot be displayed or edited on that screen (the Screen Creation Area and Tag List). Edit these tags by opening the Base screen with the original tags.
- Activating the Device Monitor function occupies the capacity of about 90 reserved tags. If the total tag count on the current screen exceeds the limit after Device Monitor is started, the monitor function may not operate correctly, and the message "TAG COUNT OVER" may appear. Do not use Device Monitor if the screen displays such a message.



The number of tags set in windows displayed in the RUN mode must also be considered in the maximum count.

■ **GP Orientation**

Even if the Display Type is set to portrait, X and Y coordinates used for F-tags (Area), U-tags (indirect designation), H-tags (Object drawing), v-tag (Indirect) Video Setting and D-Script (Object drawing functions) will be still the same as the normal Display Type setting.

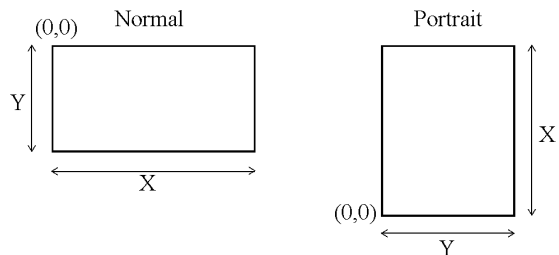

■ **Valid Number of Tags**

Valid tags are counted in the order tags were registered. Any tags set beyond the maximum number of screens are not valid. When other screens being called up also have tag settings, the number of tags for these screens are counted after the tags in the original screen have been counted.



- **The Indirect Designation feature cannot be used with logic symbols.**
- **When setting up object movement Tags on a screen, be aware of the remaining screen capacity and tag size limitations as well as the maximum number of tag settings available per screen.**

<Tag Size List>

The following table lists the maximum number of available tag settings. The numbers indicate the maximum tag numbers that can be set up on a Base (B) screen on which no other settings are made. However, the screen size of the GP and display size of the tags are not taken into consideration.

Tag Names	Features	Tag Size (unit: byte)	Maximum number of tag settings available		
			70 Series	GP-377 Series GP-77R Series GP-2000 Series	GP-270 Series GP-370 Series GP-H70 Series
A	Alarm Summary TEXT Display	56	1* ¹	1* ¹	1* ¹
a	Alarm Summary Display	34	1* ¹	1* ¹	1* ¹
C	Time Display	28	1* ¹	1* ¹	1* ¹
D	Statistic Graph Display	48	256	337	128
d	Statistic Data Display	74	219	219	128
E	Numeric Data Display (Expanded N-tag Function)	32 - 128	127 - 256	127 - 384	128
F	"Free" Library Display	42	256	384	128
G	Graph Display	40	256* ⁵	384	128
g	Graph Display (Expanded G-tag function)	40 - 158	103 - 256	103 - 384	103 - 128
H	Object Drawing	42	256	384	128
J	Moving Mark Display	38	256	384	128
K	Key Input	46, 58	256	384	128
k	Keyboard Setup	28	256	384	128
L	Library Display	34	256	384	128
I	Library State Change Display	40 - 102	159 - 256	159 - 384	128
M	Mark Display	34	256	384	128
N	Numeric Display	36	256* ⁵	384	128
n	Alarm Boundary Display	30	256	384	128
P	Numeric Display in Pre-defined Format	118	138	138	138
Q	Alarm Summary Display	46, 66, 102	256	384	128
R	Rail Settings	20	30* ²	30* ²	30* ²
S	String Display	32	256	384	128
T (includes Tih and Tiw)	Touch Panel Input	36, 54	256	384	128
t	Selector Switch Input	56	128* ³	192	64
U	Window Display	34	256* ⁴	384	128
V	Video Window Display	30	32* ⁷	32* ⁶	-
v	Extended Video Window Display	42	-	384* ⁴ * ⁶	-
W	Write to Device	32	256	384	128
X	Display Text Data	40	256	384	128

- *1 Only one can be used per screen. A single screen can contain either an a-tag's Alarm display, or a C-tag's clock display.
- *2 Although it is possible to set up to 30 (Rail) R-tags per screen, the total number of display positions for all a screen's R-tags combined cannot exceed 406. However, by loading in other screens, a total of 512 positions can be used. (For the GP-270, GP-370, and GP-H70, a total of 256 positions can be used)
- *3 The maximum numbers of t-tags that can be set for each unit are as follows:

GP Series	GP-470 GP-570 GP-675 Series	GP-270 GP-370 GP-H70 Series	GP-377R GP-477R GP-577R Series	GP-377 Series	GP2000 Series
Number of valid tags	256	128	384	384	384
Number of R-tag positions	512	256	512	512	512

- *4 The maximum number of windows that can display simultaneously on one screen is three (one Global Window and two Local Windows).
- *5 These tags cannot be used if the Display Type is set to portrait.
- *6 Available only with the GP2500/GP2600 units equipped with the optional VM unit. This value assumes the use of either of these units.
- *7 Available only with the GP-570M/GP-870VM units.



2 Active Image Functions

This chapter outlines the A-tag's functions, describes the parameters available, for this tag and the provides notes on setting up the Tag.

2.1 A-tag (Alarm Summary TEXT Display)

2.1.1 Overview

A-tags display, in rows, messages (text data) registered in Text screens. Only rows that are necessary are displayed. When used in combination with other tags (such as L and T tags), you can display a *sub-display* (sub-screen) which corresponds to each message. This is useful for troubleshooting of your system.

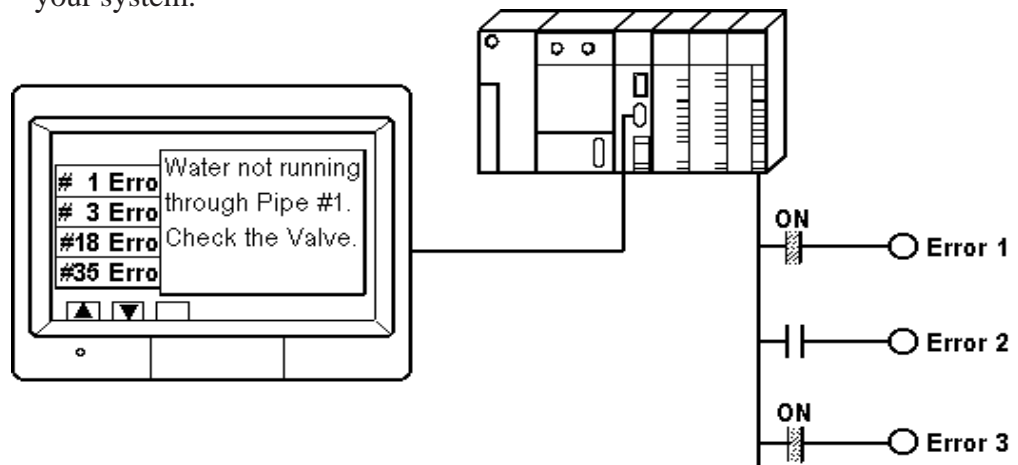

2.1.2 About A-tags

- Each message (text data) is registered in a Text screen.
 - ▼ **Reference** ▲ *Operation Manual, 3.4 Text Input: the Text Screen*
- Allocate a monitor bit address to each row of text in the Text screen. By designating the start address, the monitor bits for the rest of the rows are allocated automatically. Setup tags using word address units.
- Only rows whose corresponding monitor bits are activated display in the list. These rows disappear when the monitor bits turn OFF.
- In a Text screen, a maximum 512 rows of text data can be registered. A message summary of up to 512 rows can be displayed. However, with most GPs only 40 rows can display at one time on a screen.*1 If the messages cannot display on one screen, create multiple Base screens set with A-tags, and display the other messages by switching Base screens. In such cases, set the Start Line number for each A-tag to continue from the previous screen.

*1 The GP-675 can display up to 50 rows.



Note: • Using the sub-screen function may slow down data communication.

- Screen file numbers for Base screens (or Text screens) used by the sub-screen function must be registered consecutively and match the order of text data in the summary display.
- When using the sub-screen function, Touch Panel keys for selecting the text line, which the sub-screen corresponds to, must be set. (in T-tag’s “A-tag Select Key” function)



Reference 2.23 T-tag (Touch Panel Input)

Note: Sub-screen is carried out indirectly. Designate one word for the sub-screen display data storage address. The GP automatically distributes stored data from other items and makes the settings.

- Also, when a monitor bit’s corresponding message row is left empty, the A-tag allows you to delete (hide) that row. As a result, you can then display only those rows which contain messages in the Alarm Summary Display. Regardless whether the Blank Line Display feature is ON or OFF, a total of 512 rows of text can be shown in either case. This feature is available only with Digital’s GP77R Series, GP377, GP37W2 and GP2000 Series units.

<Relationship between text screens and monitor addresses>

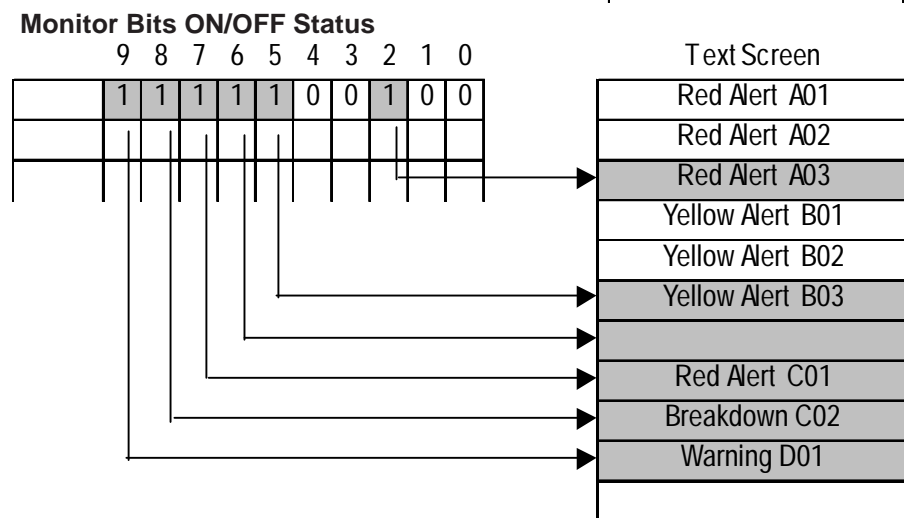
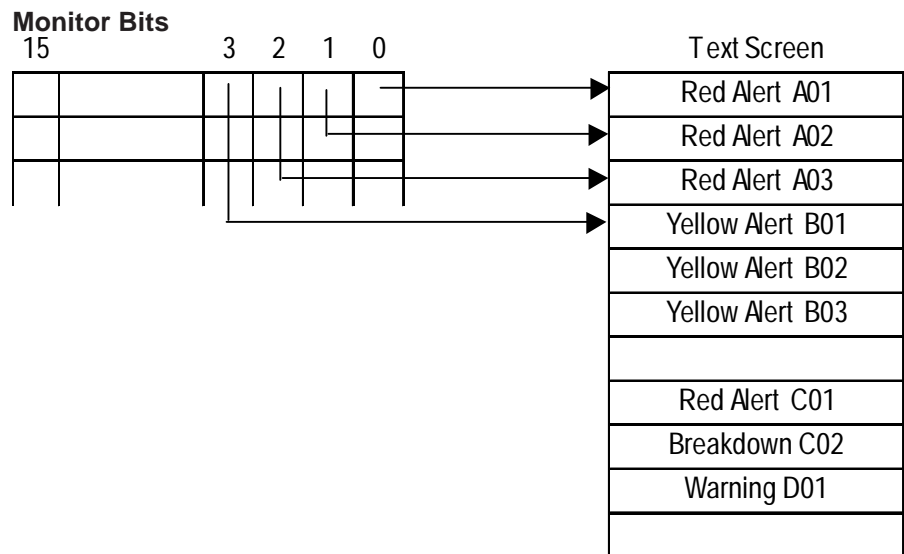

<When Blank Line Display is ON>

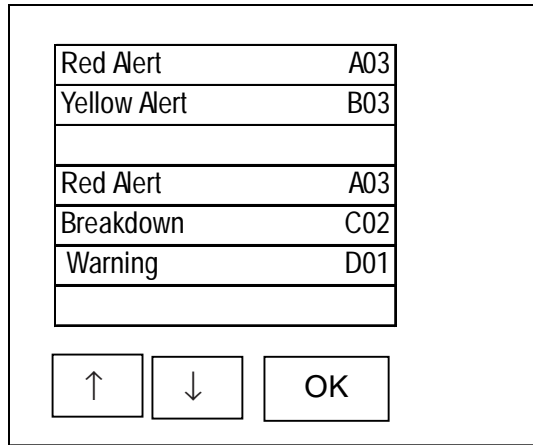

<When Blank Line Display is OFF>

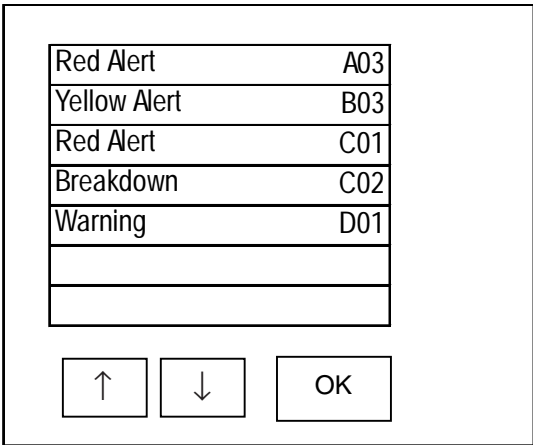

■ Relationship Between Monitor Addresses and Text Data

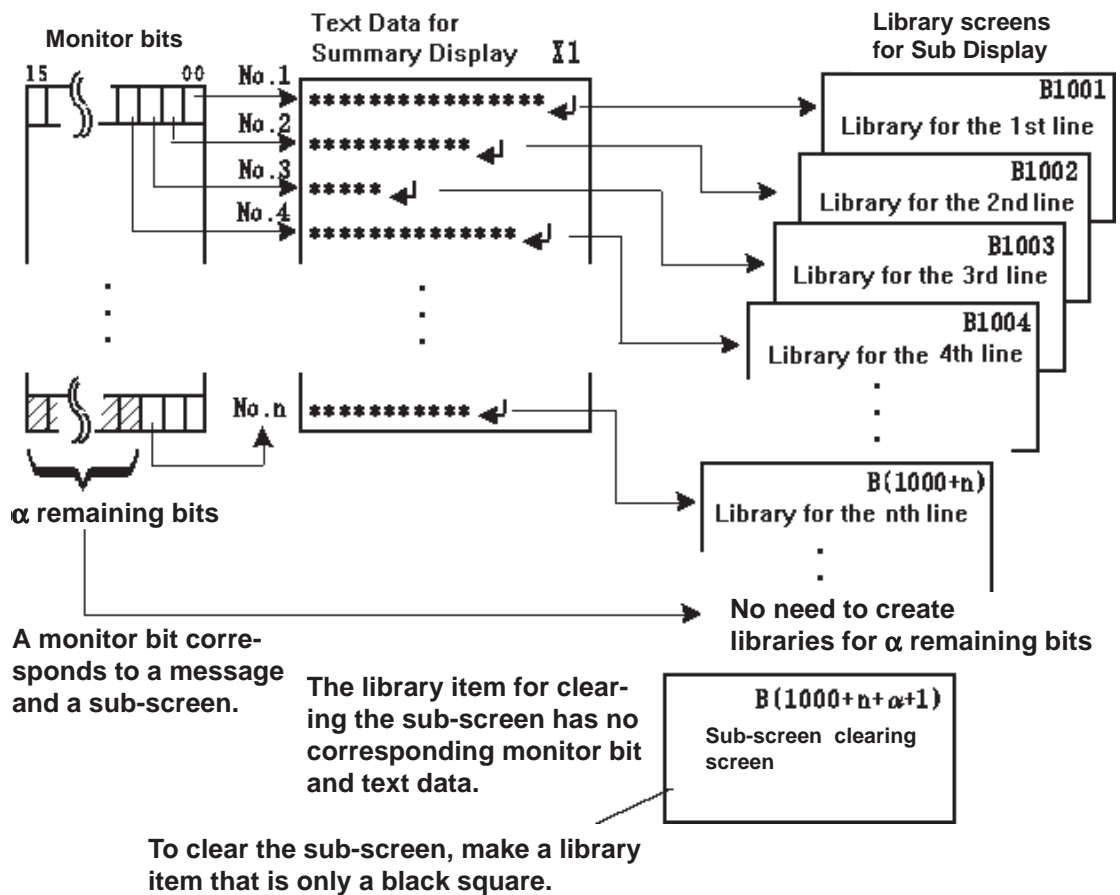

■ When the GP is Operating :

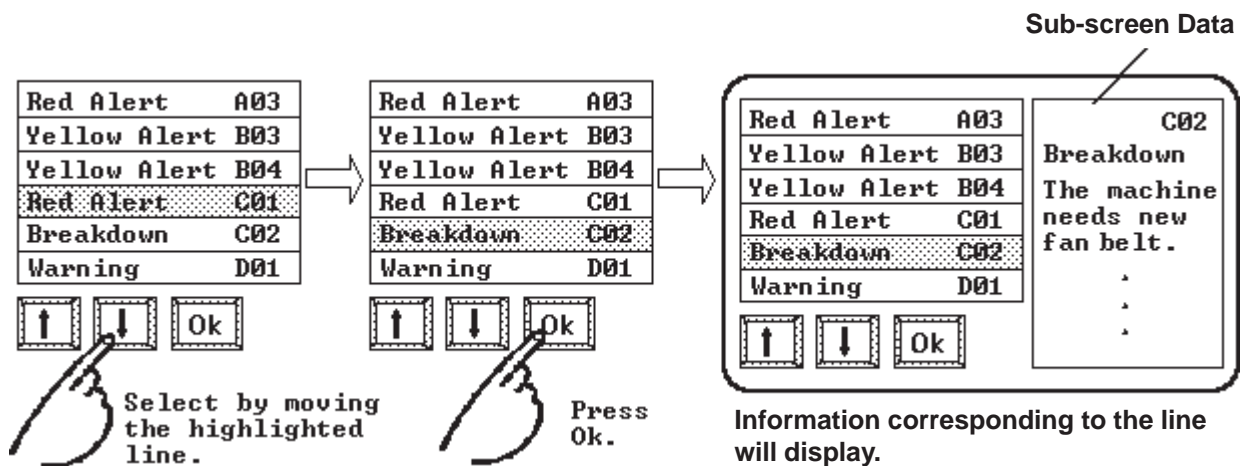
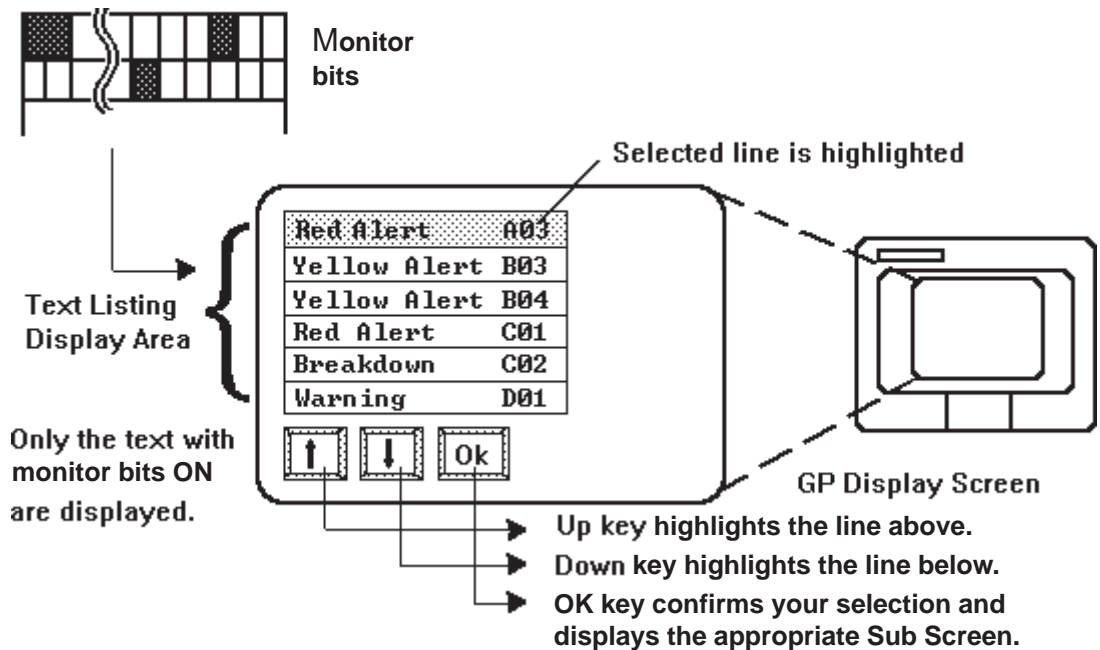

2.1.3 Using A-tags

■ General Info.

A Tag Setting

General Info. | Display Format | Size/Color | Sub Display | Display Angle

Tag Name: A 0000

Description: []

Display Start Line: 1

Monitor Address: D00000

No. of Monitor Words: 1

Text Screen No.: 1

No. of Display Lines: []

No. of Display Char.: []

The General Info. page provides information about the current settings for the A-tag.

Tag Name

Must be no more than five Single-byte or two Double-byte characters long and composed of letters and/or symbols.

Description

Up to 20 Single-byte or 10 Double-byte characters can be entered as a description of the tag.

■ Display Format

A Tag Setting

General Info. | Display Format | Size/Color | Sub Display | Display Angle

Monitor Address

Monitor Word Address: 0000

No. of Monitor Words: 1

Border Type

No Border

[] (border)

[] (table)

Display Format

Direct Indirect

Text Screen No.: 1 Blank Line Display

Display Start Line: 1

No. of Display Lines: 12

No. of Display Char.: 40

OK Cancel Help

Monitor Address

Monitor Word Address

Defines the starting word address for the monitor bits.

No. of Monitor Words

Defines the number of word addresses used for the monitor bits. Set it according to the number of rows registered in the Text screen. A Maximum of 32 words can be entered.

Monitor Words use 16 bits per word.

When a Device address uses 32 bits, be sure to use only the even numbered bits, i.e. 2, 4, 6, ...). When the Device Address uses 32 bits, 1 address uses 2 words.

Border Type

Defines the type of border from “No Border” “ [] (border)” and “ [] (table)”

Display Format

Direct

Defines the text screen number directly in the Text Screen No. area.

Text Screen No.

Defines the screen file number for the Text screen to be displayed.

Display Start Line

Defines which row of Text screen to begin the display with when the monitor bit has been activated.

No. of Display Lines

Defines the maximum number of rows for the message display on a single screen. Maximum 40 rows can be set.

No. of Display Char.

Designates the maximum character display length available for each row of messages. A Maximum of 80 characters can be set.

Blank Line Display

When a monitor bit's corresponding message row is left empty, the A-tag allows you to delete (hide) that row. As a result, you can then display only those rows which contain messages in the Alarm Summary Display. Regardless whether the Blank Line Display feature is ON or OFF, a total of 512 rows can be shown in either case. This feature is available only with Digital's GP77R, GP377 and GP2000 Series.

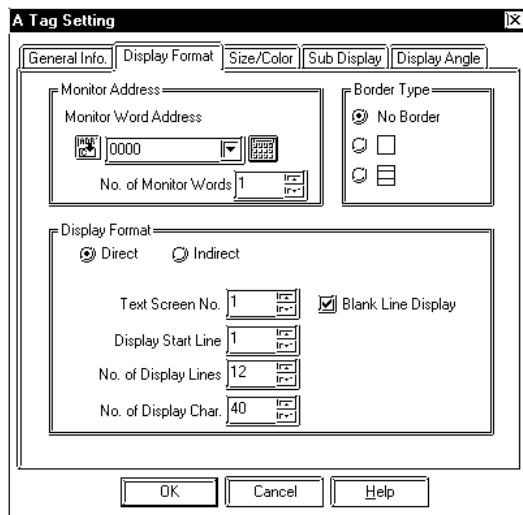

Display Format

Indirect

Used when the text screen number is designated indirectly. This setting is valid only for GP77R, GP377 and GP2000 Series.

Text Screen No. Word Address

Designates a Word Address to store the Text screen to be displayed. The Text screen numbers are designated as binary numbers. Also, when changing a screen to another, be sure that the number of text lines contained in each screen is always the same.

Blank Line Display

When a monitor bit's corresponding message row is left empty, the A-tag allows you to delete (hide) that row. As a result, you can then display only those rows which contain messages in the Alarm Summary Display. Regardless whether the Blank Line Display feature is ON or OFF, a total of 512 rows can be shown in either case. This feature is available only with Digital's GP77R, GP377 and GP2000 Series.



Note: When the number of rows of text will not fit into a single screen display, the Start Line as shown below:

Screen 1, Start Line = normally 1

Screen 2, Start Line = previous screen Display Lines + Start Line

⋮

Screen n, Start Line = previous screen Display Lines × (n-1) + Start Line

• For details about the Border:

▼ **Reference** “2.2.4 Alarm Summary Display Notes”, a-tag

- The possible number of display lines and characters is designated by the GP screen size and orientation, and the Display Size setting.
- When the Text screen changes, its sub-display and cursor will be turned OFF.

■ Size/Color

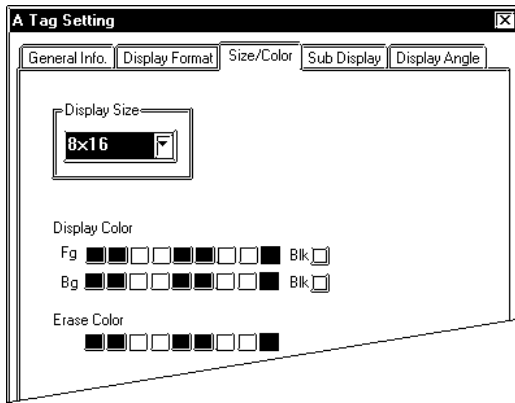

Display Size

The Display Size of characters can be specified here. With the GP2000 series, the scale ratio can be selected from integers 1 through 8. With other models, the scale ratio for the display can be selected from 1, 2, 4, and 8 times. The basic unit of measurement, "1 x 1" times, is a character measuring 16 dots by 16 dots.

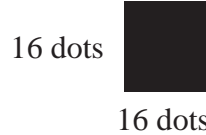

<Double-byte Character>

When using Single-byte numerals or symbols, [6 X 10 dot], [8 X 13 dot] and [13 X 23 dot] extended fonts can be used.



Since extended font sizes are fixed, objects containing these characters cannot be enlarged or reduced while pressing down the [Ctrl] key.

Display Color

Fg (foreground) and Bg (background) colors, and Blk (blink) ON/OFF are designated here.

Erase Color

Defines the color attributes for the area where data is not being displayed. If the GP screen is monochrome, this should be set as black.

Reference ▲ "2.1.5 Color Settings", A-tag

■ Sub Display

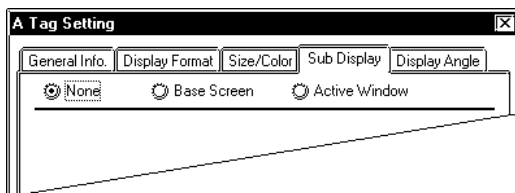

None

Turns OFF the sub-screen display.

Base Screen

Runs the sub-screen display.

Active Window

Runs all the sub-screens and window displays.

■ Sub Display/Base Screen

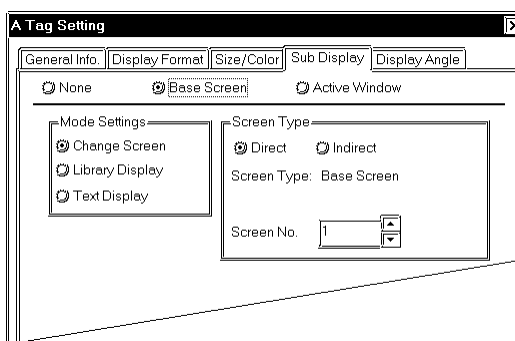

Base Screen

Mode Settings

Change Screen

Changes the display screen to another screen. (Same as the normal screen change operation.)

Library Display

Displays a library screen (Base screen) as a sub-screen at the location set by the L-tag.

Text Display

A sub-screen of text data (Text screen) will display at the location set by the X-tag.

Change Screen

Screen Type

Direct

Designates the screen file number (Base screen) to be displayed next directly in the Screen No. area.

Screen No.

Enter the screen file number (Base screen) to be displayed next. This data must be in binary format.

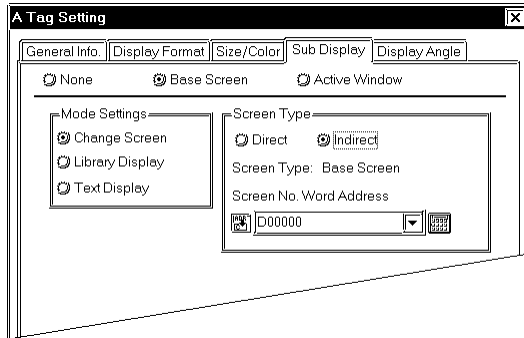

Screen Type

Indirect

Designates the screen file number (Base screen) to be displayed next as indirect. This setting is valid only for the GP77R, GP377 and GP2000 Series.

Screen Number Word Address

Designates a Word Address to store screen file number (Base screen) to be displayed. Be sure to designate screen file numbers as binary numbers.

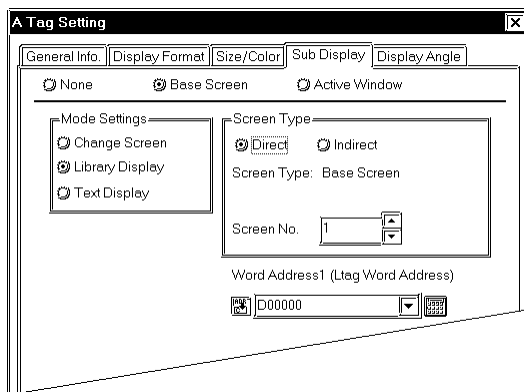

Library Display

Screen Type

Direct

Designates the number of the Base screen to be displayed as a sub-screen directly in the Screen No. area.

Screen No.

Enter the start number of the Base screens created as sub-screens.

Word Address1(Ltag Word Address)

Enter a Word Address where data used for the sub-display is stored. Must agree with the L-tag's Word Address, used for the base screen No.'s storage address.

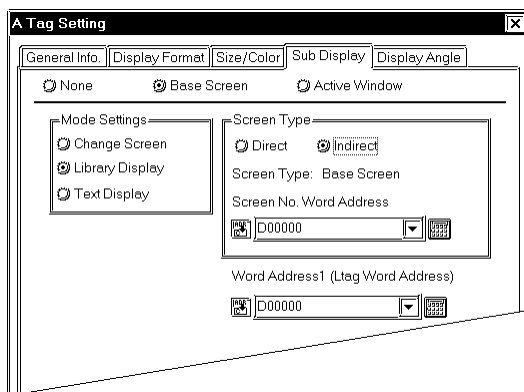

Screen Type

Indirect

Designates the Text screen number for sub-screen display indirectly. This setting is valid only for the GP77R, GP377 and GP2000 Series.

Screen No. Word Address

Enter a Word Address where the start number of the Text screens for sub-screen display. Designates the start number of the Text screens as a binary number.

Word Address1(Ltag Word Address)

Enter a Word Address where data for the sub-screen display is stored. Must agree with the word address set for storing the L-tag's base screen number storage address.

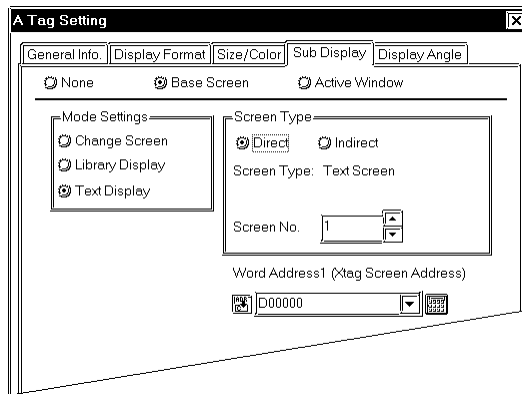

Text Display Screen Type

Direct

Designates the number of the Text screen for sub-screen display directly in the Screen No. area.

Screen No.

Enter the start number of the Text screens to be used as sub-screens.

Word Address1(Xtag Screen Address)

Enter a Word Address where data for the sub-screen display is stored. The address set for storing the Text screen file number during the X-tag setting must be used.

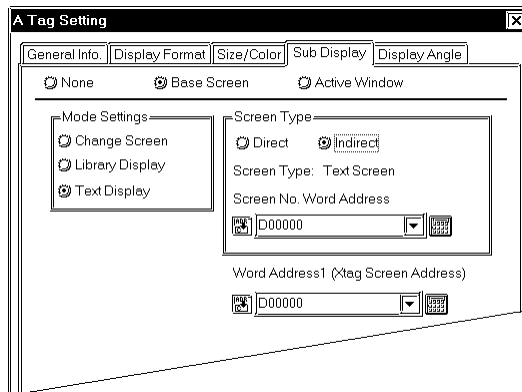

Screen Type

Indirect

Designates the Text screen number for sub-screen display indirectly. This setting is valid only for the GP77R, GP377 and GP2000 Series.

Screen No. Word Address

Enter a Word Address where the start number of the Text screens for sub-screen display. Designates the start number of the Text screens as a binary number.

Word Address1(Xtag Screen Address)

Enter a Word Address where data for the sub-screen display is stored. The address set for storing the Text screen file number during the X-tag setting must be used.

■Sub Display/Active Window

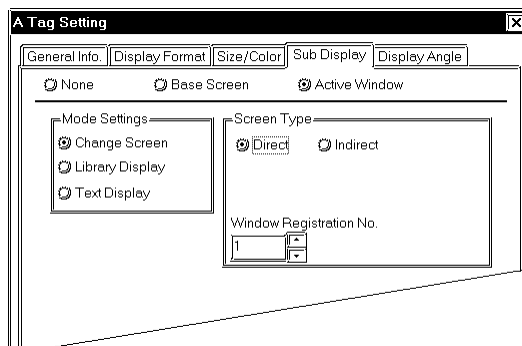

Active Window

Mode Settings

Change Screen

Displays the window designated to change to.

Library Display

Displays a library item's screen (Base screen) as a sub-screen at the location set by the L-tag.

Text Display

A sub-screen of text data (Text screen) is displayed at the location set by the X-tag.

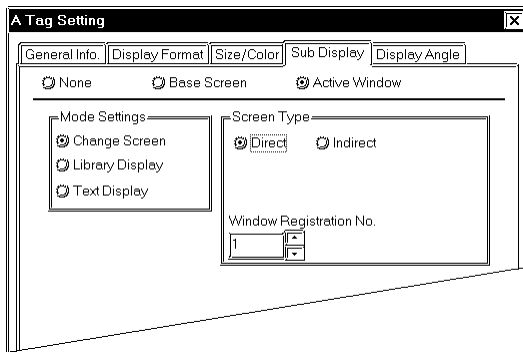

**Change Screen
Screen Type**

Direct

Designates directly the window to be displayed in the Window Registration No. area.

Window Registration No.

Enter the registration number of a window to be displayed.

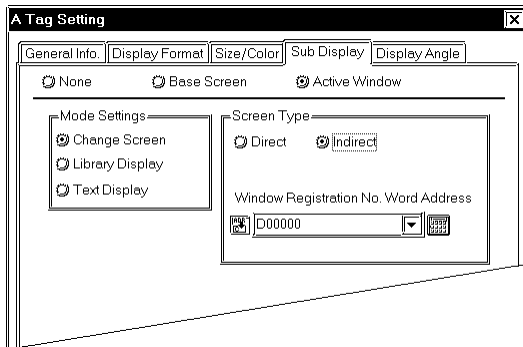

Screen Type

Indirect

Designates a window to be displayed indirectly. This setting is valid only for the GP77R, GP377 and GP2000 Series.

Window Registration No. Word Address

Enter a Word Address where the registration start number of windows to be displayed is stored. Designate the registration start number as a binary number.

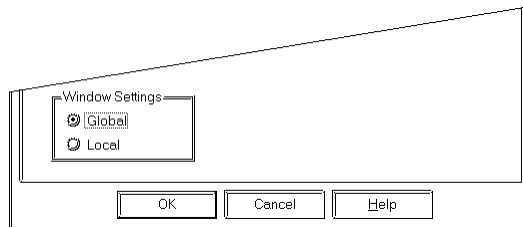

Window Settings

Global

Displays a window globally.

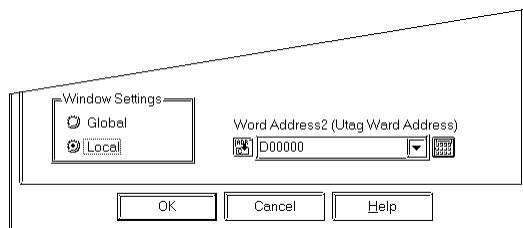

Window Settings

Local

Displays a window locally.

Word Address2(Utag Word Address)

Must agree with the address set for controlling the window via the U-tag settings.

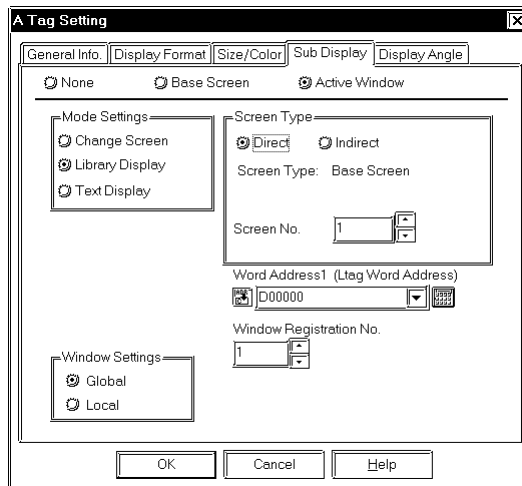

Library Display Screen Type

Direct

Directly designates the starting number of the Base screens for sub-screen display via the Screen No. area.

Screen No.

Enter the start number of the Base screens for the sub-screen display.

Word Address1 (Ltag Word Address)

Enter a Word Address where data for the sub-screen display is stored. The address set for storing the Base screen number during L-tag settings must be used.

Window Registration No.

Enter the registration number of the window to be displayed.

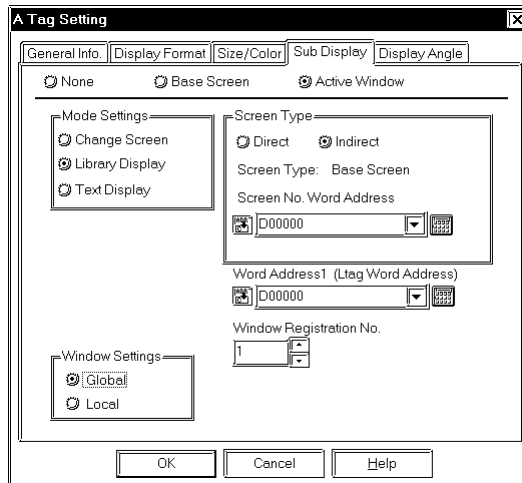

Screen Type

Indirect

Designates the start number of the Base screens for sub-screen display indirectly. This setting is valid only for the GP77R, GP377 and GP2000 Series.

Screen No. Word Address

Enter a Word Address where the start number of the Base screens for sub-screen display is stored. Designate the start number as a binary number.

Word Address1 (Ltag Word Address)

Enter a Word Address where the screen file number for the sub-screen is stored. The address set for storing the Base screen file number during the L-tag setting must be used.

Window Registration No.

Enter the registration number for the window to be displayed.

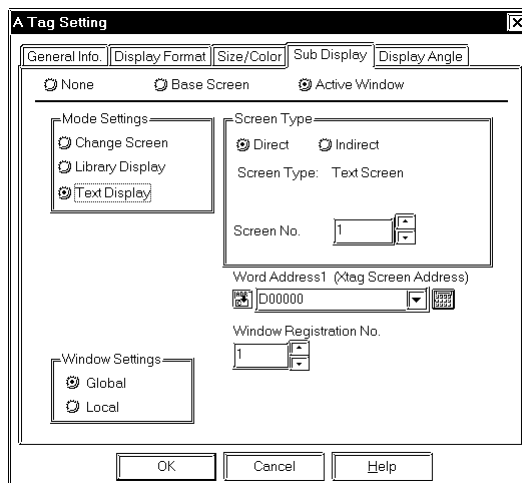

Text Display Screen Type

Direct

Designate the start number of the Text screens for the sub-screen display directly in the Screen No. area.

Screen No.

Enter the start number of the Text screens created for the sub-screen display.

Word Address1(Xtag Screen Address)
 Enter a Word Address where data for sub-screen display is stored. The address designated for storing Text screen number during X-tag settings must be used.

Window Registration No.
 Enter the registration number for the window to be displayed.

Text Display Screen Type

Indirect
 Designates the start number of the Text screens created for the sub-screen display indirectly. This setting is valid only for the GP77R, GP377 and GP2000 Series.

Screen No. Word Address
 Enter a Word Address where the start number of the Text screens created for the sub-screen display is stored. Designate the start number as a binary number.

Word Address (X-tag Screen Address)
 Enter a Word Address where the data for the sub-screen display is stored. The address set for storing the Text screen file number during the X-tag setting must be used.

Window Registration No.
 Enter a registration number for the window to be displayed.

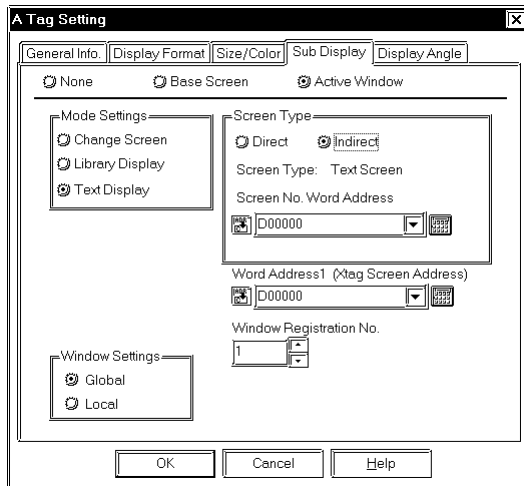

■ Display Angle

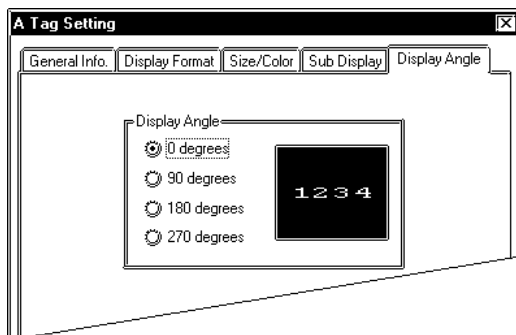

Display Angle
 Set up the rotation for the display. Select 0(zero), 90, 180, or 270 degrees.



- When setting a U-tag, L-tag, or X-tag used with an A-tag, select **Indirect** in the Designated Window area for the U-tag, **Indirect** in the Designated Screen area for the L-tag, and **Indirect** in the Mode/Word/Display Start Line area for the X-tag. Be sure to set each tag's Data Format to Bin.
- The Text screen and Base screen can use as many screens as (16 × monitor words) + one, on a sub-screen. These screens cannot be used for other purposes.

2.1.4 A-tag Example

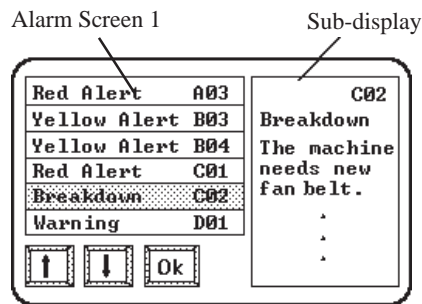

<Specifications>

- Up to 50 lines of alarm messages
- Maximum of 20 characters per line
- Monitor bits starting from address M0800
- Sub-screen (Library) used on the same Base screen
- Start Screen No. of sub-screen libraries is B1000

- Since there are up to 50 alarm messages, the text data that contains the messages must also use 50 rows. Allocate a monitor bit address to each row, starting from address M0800. The total monitor bits used will add up to 4 words: $(50 \div 16 = 3 \text{ remainder } 2 \rightarrow 4 \text{ words})$
- Library screens used for the sub-screen must be registered in the same order as the alarm messages, as consecutive screen file numbers.
- If bits remain unused in monitor addresses (in this example words M0850 to M0863), keep them as reserves. Allocate screen file numbers for these remaining bits as well. Then create a Library screen for blanking the sub-screen. The screen file number for the sub-screen blanking library is : Sub-screen Library Start file screen number (Base screen) + Monitor Address Words $\times 16$.

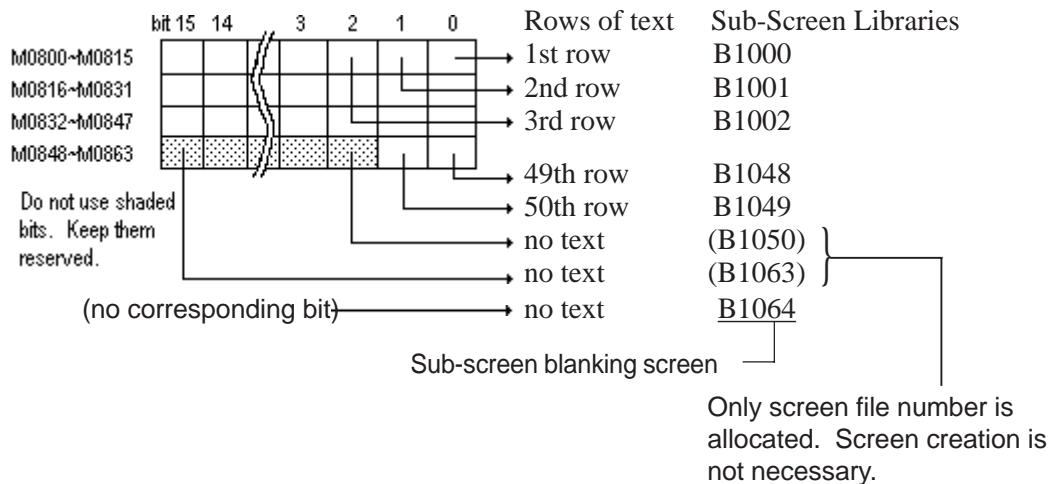

- A library screen that blanks the sub-screen after using the sub-screen function must be made. For each library, first draw a black filled rectangle. Then, draw what you want to display on the screen, over the filled rectangle. For the sub-screen blanking library, draw only a black filled rectangle.

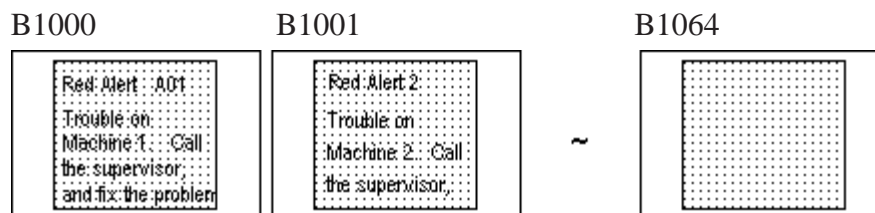

Create drawings over the filled rectangles Only black filled rectangle

Reference 2.14.9 “How to Avoid Overlapping Erase Images”, L-tag

- Since the maximum number of alarm message display rows is 20, three alarm screens become necessary to display all 50 rows.

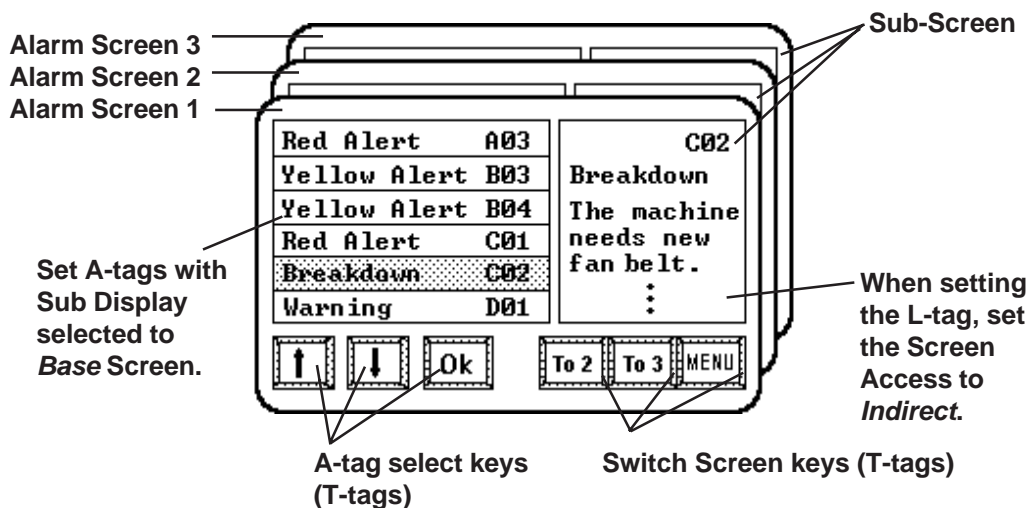

Enter the same address in the A-tag’s Word Address (L-tag Word Address) and L-tag’s Word Address. This example uses the GP internal LS area. Enter similar contents for Base screens 2 and 3.



Note: The T-tag OK button (above diagram) can overlap the same area as the Up or Down buttons. In this case, be sure to set up the Up and Down buttons before the OK button. Do not overlap the Up and Down buttons.

◆ A-tag Settings

A-tag

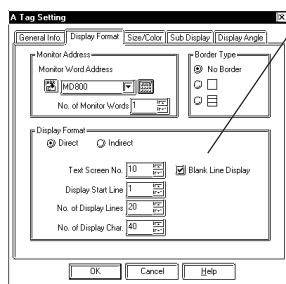

When there are multiple alarm screens, the Start Line must be "Display lines x number of Screens." On the first screen, the value is normally one, and increases by the number of rows set.

A-tag

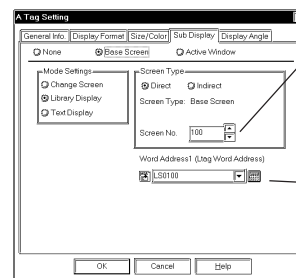

Consecutively registered Sub-display screen start number.

Sub-display screen address where the Library screen file number for sub-screen is registered. (same address as L-tag)

L-tag

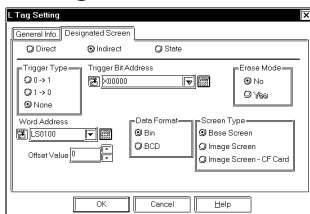

Select Indirect on the Screen Access page, and set the Data Format to Bin.

T-tag

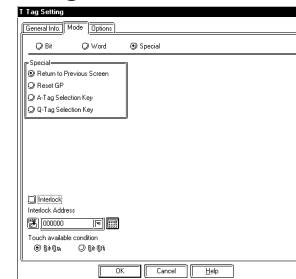

- Only the text rows whose monitor bits are ON will display in consecutive order. Display a sub-display that corresponds to the message by simply selecting a row. When the monitor bit is turned OFF, the sub-display clears. (In reality, the sub-screen blanking library is overlaid on top.)

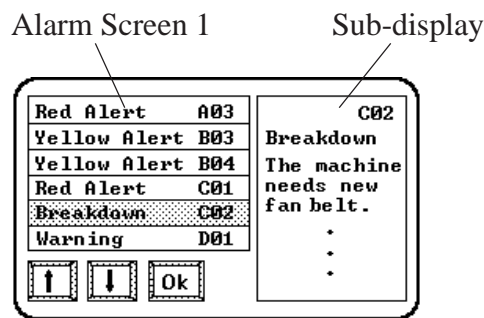

When the monitor bit for the selected message turns OFF...

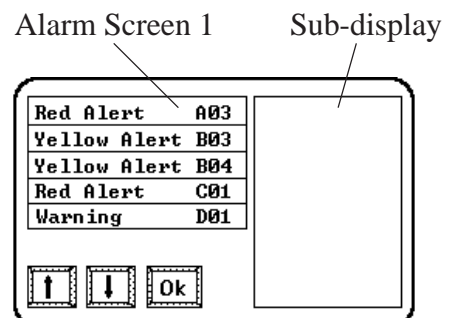

The sub-display is cleared by the sub-screen blanking library item.



- When *Text Display* is selected for the Mode Set in the sub-screen setting, then the sub-screen blanking library is not required. The display area will be cleared by the Clear Color function in X-tag.
- Treat all left over (not used) in the sub-screen clearing library items, as well as the 16 monitor address files as reserved and do not use them for another purpose.
- When using a Global Window, L-tags, or U-tags for sub-screen display, select the *Indirect* option and set the Data Format to *Bin*.
- If a screen is switched with the sub-screen left ON, the GP will set the designated Word Address of the L-tag, X-tag, or U-tag to zero (clears the sub-screen) before switching to the next screen. As in the above example, if there is an A-tag setting with the same monitor bit address on the switched screen, then because of delays from communication timing, you may see the sub-screen for a moment. The communication time could be shortened, if the GP internal LS Area device is used as the word addresses for L-tag, X-tag, and U-tag.
- When *Indirect* is selected for the Screen Type in the sub-screen settings, the start screen number and window registration number become valid by turning ON/OFF the sub-screen display. Also, during the sub-screen display, even if data for these items are changed, the display is not changed.
- When the start screen number for the sub-screen display is set to *Indirect*, set up from the start to erase screens. Also, **DO NOT** change the start screen number during sub-screen display.
- When *Indirect* is selected for the sub-screen display settings, a single Tag is counted as two tags.

2.1.5 Color Settings

The foreground (Fg) and background (Bg) color settings use the color bar illustrated below, where you can select from 8 different colors. Also, the Blink option can be set ON/OFF by clicking the Blk box.

◆ **When using 8 colors:**



◆ **When using 64 colors:**



◆ **When using 256 colors:**



- Note:**
- When using a monochrome GP, Black, Blue, Green, and Cyan display in black. Red, Magenta, Yellow, and White will appear white.
 - Do not select Black with the Blk option turned ON for tags and alarm messages.

Follow the steps below to set Blink, Reverse, and Blink + Reverse settings.

◆ **Blink:**  **flashing display**



White: Flash
 Black: Normal display (No Blinking)

◆ **Reverse:**  **reverse display**



Black: Normal display (No Blinking)
 White: Normal display (No Blinking)

◆ **Blink + Reverse:**  **reverse and flashing display**

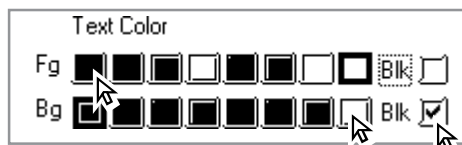

Black: Normal display (No Blinking)
 White: Blinking



2.2 a-tag (Alarm Summary Display)

2.2.1 Overview

Displays the Alarm Editor registered message on the Base screen or on the window in a summary display. This function is most suited for the Alarm Summary display.

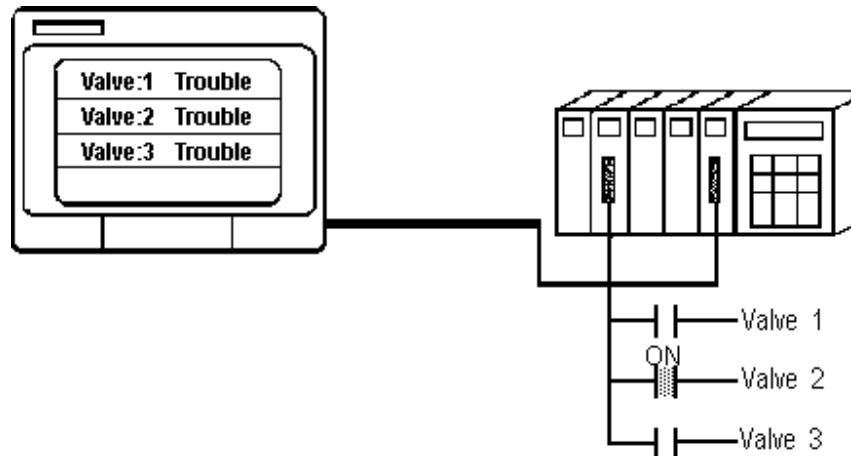

2.2.2 About a-tags

- When registering an alarm message with the Alarm Editor, set the alarm type to “Summary” to display the message as part of the Alarm Summary display.
▼Reference▲ *Operation Manual, 5.1 Alarm Creation and Editing*
- The Alarm Summary display lists only Alarm messages whose alarm type is “Summary” and the corresponding monitor bits turn ON. These messages disappear when the monitor bits turn OFF.
- A maximum of 1600 Alarm messages can be displayed in the list. However, on one screen a maximum of 40 rows of messages can be displayed. If messages exceed the maximum amount, create other Base screens with the a-tag and change screen setting, to display all possible Alarm messages. Set up the a-tag start number so that it is forced to display the next messages screen (20 messages).
 E.g. When 20 rows of messages are displayed, enter “21” as the a-tag Start Number to bring up the next 20 messages.
- Up to 160 Single-byte characters can be registered on the Alarm Editor for a single message. However, when this message displays on the GP, the maximum number of characters per row and the maximum number of rows per screen are designated by the GP’s type and Display orientation setup used. **▼Reference▲** *“2.1.2 About A-tags / Maximum number of Characters and Lines”, A-tag*

- You may designate Display Size and Display Border options.
- Alarm Message displays start from the lowest monitor bit address. Succeeding alarm messages will appear, beginning with the allocated to the lowest monitor bit address, from the top of the alarm display.



Alarm messages that exceed the length of the designated display area will be truncated to the allowable display length.



Note: Only one a-tag can be created on each Base screen. If you desire more than one in a Base screen, use a window display with an a-tag setting.

2.2.3 Using a-tags

■ General Info.

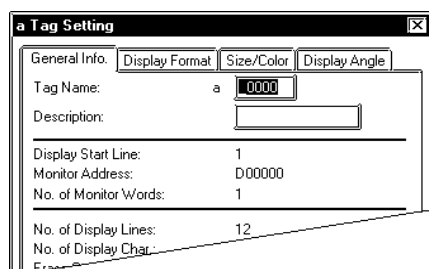

The General Info. page provides information about the current settings for the a-tag.

Tag Name

Must be no more than five Single-byte or two Double-byte characters long and composed of letters and/or symbols.

Description

Up to 20 Single-byte or 10 Double-byte characters can be entered as a description.

■ Display Format

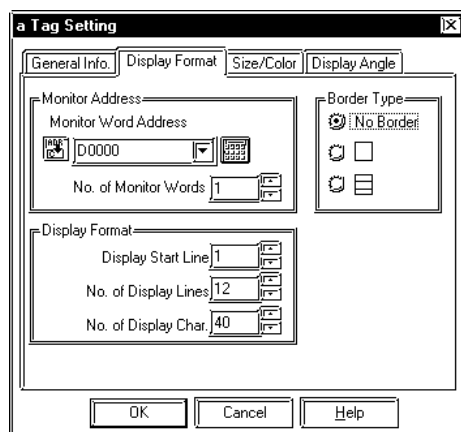

Monitor Address

Monitor Word Address

Defines the starting word address for the monitor bits set with the Alarm Editor.

No. of Monitor Words

Defines the number of word addresses used for the monitor bits. Maximum 100 words. Monitor Words use 16 bits per word. When a Device address uses 32 bits, be sure to use only the even numbered bits, i.e. 2, 4, 6, ...). When the Device Address uses 32 bits, 1 address uses 2 words.

Border Type

Defines the type of border from “No Border” “ (border)” and “ (table)”

Display Format

Display Start Line

Defines which line of alarm messages with activated monitor bits, to begin the display with.

No. of Display Lines

Defines the number of rows for the Alarm Summary display on one screen. Maximum is 40 rows.

No. of Display Char.

Defines the maximum character display length available for each alarm message.

◆ Border Example

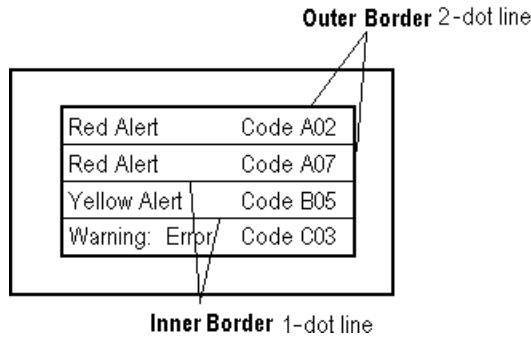

- The message character display colors are designated in the Alarm Editor.
- The number of rows and characters on a screen will vary depending on the GP screen size, panel orientation, and character size.



Note:

- **Reference** “2.1.2 About A-tags / Max. No. of Characters and Lines”, A-tag
- When all the Alarm messages cannot fit on one screen, set up the Start Line as shown below.

Screen 1 Start Line = normally “1”

Screen 2 Start Line = previous screen Display Lines + Start Line

:
:
:

Screen n, Start Line = previous screen Display Lines × (n-1) + Start Line

- The possible number of display lines and characters is designated by the GP screen size and installation orientation, and the display size setting.

■ Size/Color

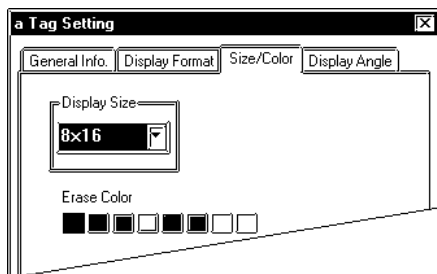

Display Size

The Display Size of characters can be specified here. With the GP2000 series, the scale ratio can be selected from integers 1 through 8. With other models, the scale ratio for the display can be selected from 1, 2, 4, and 8 times. The basic unit of measurement, "1 x 1" times, is a character measuring 16 dots by 16 dots. The Display Size setting applies to the ":", "H" (hour), and "M" (minute) displays.

16 dots



16 dots

<Double-byte Character>

When using Single-byte numerals or symbols, [6 X 10 dot], [8 X 13 dot] and [13 X 23 dot] extended fonts can be used.



Note:

Since extended font sizes are fixed, objects containing these characters cannot be enlarged or reduced while pressing down the [Ctrl] key.

Erase Color

Defines the color attributes for areas where messages are not displayed. If the GP screen is monochrome, this should be set to black.

Display Angle

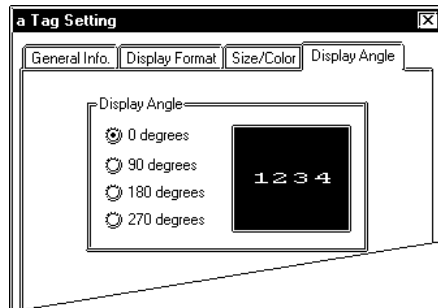

Display Angle

Set up the rotation for the display. Select 0(zero), 90, 180, or 270 degrees.

2.2.4 Alarm Summary Display Notes

- Alarm messages display from the lowest monitor bit address.
- Be sure to allocate the monitor bits to consecutive addresses.

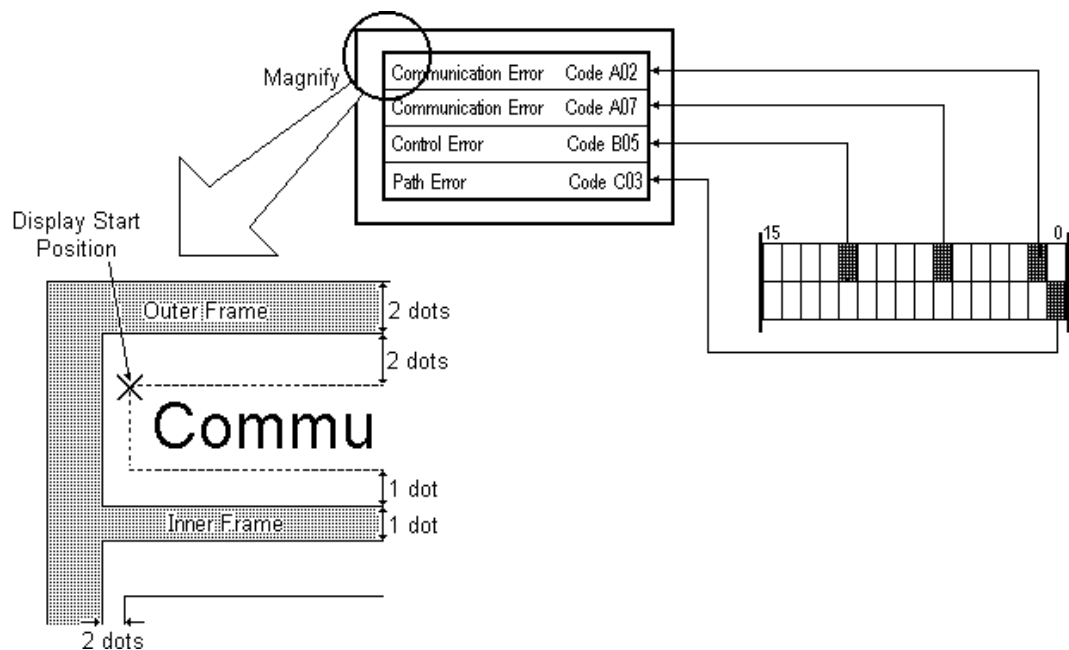

- If there are many Alarm messages with the same monitor bit, only the Alarm message with the smallest alarm number will display. Avoid duplicating monitor bit addresses.
- Monitor bit addresses cannot be used with different devices.
- Use the Alarm Summary display area exclusively for alarms. Do not overlap the Alarm Summary display with other screen objects.



2.3 C-tag (Time Display)

2.3.1 Overview

C-tags display the current time, based on the GP's internal clock.

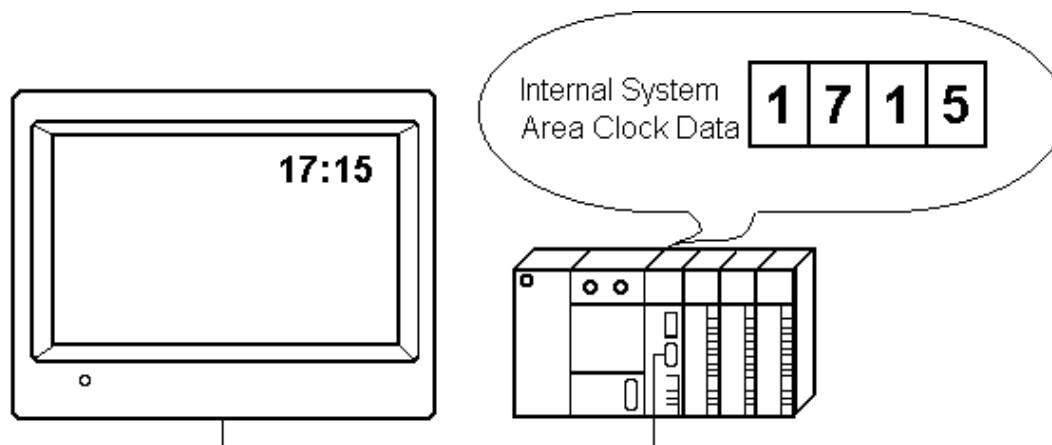

2.3.2 About C-tags

- Time displays in 24 hour (military) format.
- Position, size, and color attributes of the Time Display are adjustable.
- When using a C-tag, data used for the C-tag display is stored in either System Data Area address +5 (direct access type), or addresses 7 and 8 (memory link type).
- C-tags display only time. To display the date, set an N-tag to use System Data Area address +2, 3, and 4 for direct access type applications, or 4, 5, and 6 for memory link type applications.



Note: • Only one C-Tag may be used per screen. If multiple C-Tags have been used on a single screen, only the first will be valid (enabled).

• For the system data area of the direct address method and memory link method:

▼ **Reference** ▲ *Device/PLC Connection Manual, Chapter 1 Direct Access Communication, Chapter 3 Memory Link Communication*

2.3.3 Using C-tags

■ General Info.



The General Info. page provides information about current settings for C-tag.

Tag Name

Not more than five Single-byte or two Double-byte characters long and composed of letters and/or symbols.

Description

Up to 20 Single-byte or 10 Double-byte characters can be entered as a description of the tag.

■ Size/Color

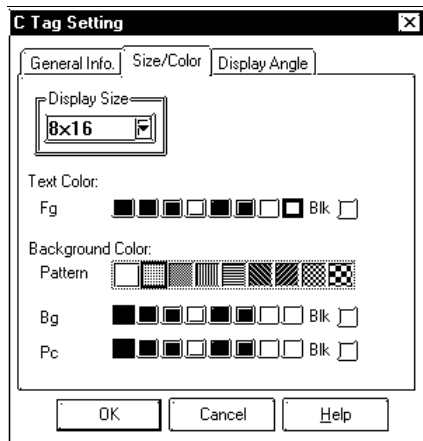

Display Size

The Display Size of characters can be specified here. With the GP2000 series, the scale ratio can be selected from integers 1 through 8. With other models, the scale ratio for the display can be selected from 1, 2, 4, and 8 times. The "1 x 1" character size is a single-byte character measuring 8 dots by 16 dots, and a double-byte character measuring 16 dots by 16 dots. The Display Size setting applies to the ":", "H" (hour), and "M" (minute) displays.

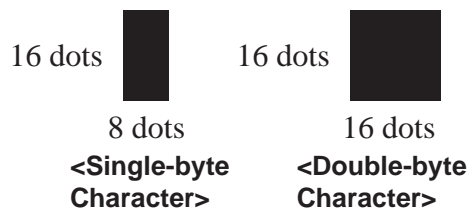

When using Single-byte numerals or symbols, [6 X 10 dot], [8 X 13 dot] and [13 X 23 dot] extended fonts can be used.



Since extended font sizes are fixed, objects containing these characters cannot be enlarged or reduced while pressing down the [Ctrl] key.

Text Color

Defines the color attributes (Fg - foreground, Bg - background, Blk - blink) to be used in the display.

Background Color

Specifies a pattern's background color (Bg), and blink ON/OFF status (Blk). The background pattern's color (Pc) is specified in the Pattern area. Combinations of Background Colors and Pattern colors (Pc) are possible. For the GP-270, only Pattern "0" (white), can actually be used.

Reference *"2.1.5 Color Settings", A-tag*

■ Display Angle

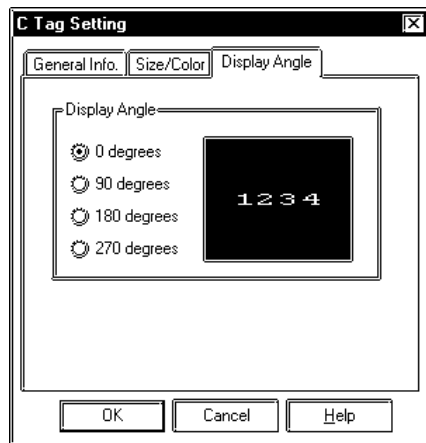

Display Angle

Set up the rotation for the display. Select 0 (zero), 90, 180, or 270 degrees.



2.4 D-tag (Statistical Graph Display)

2.4.1 Overview

D-Tags display statistics in two different types of graphs: bar graphs and pie graphs.

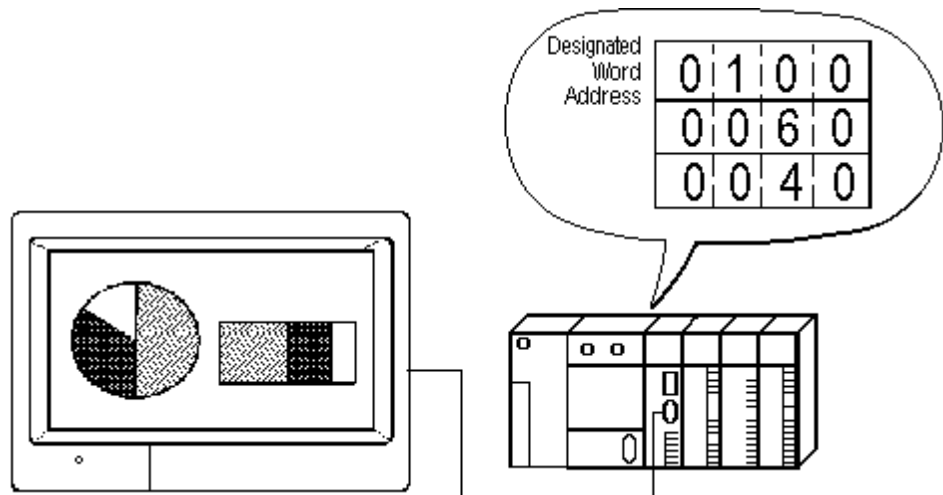

2.4.2 About D-tags

- Statistical graphs display the data in the host's (PLC's) consecutive related word addresses as percentages of a total.
- Statistic graphs can be divided into a maximum of eight parts. This means up to eight words of data can be displayed as a statistical graph.
- Data stored in the host (PLC) can be either Binary or BCD, but not both.
- Setting up the first word address for the data stored, enables the next word addresses corresponding to the number of graphs divisions, to be occupied automatically.
- The word address data (all data) is totaled, and the allocation (division) of graphic display areas is performed automatically based on that total.
- Set up the display attributes (foreground and background colors, fill pattern, and blinking) for each data value.



Note:

Using a d-tag allows a display of the D-tag statistic graph's actual numeric values or percent values.

▼ **Reference** ▲ 2.5 *d-tag (Statistical Data Display)*

2.4.3 Using D-tags

■ General Info.

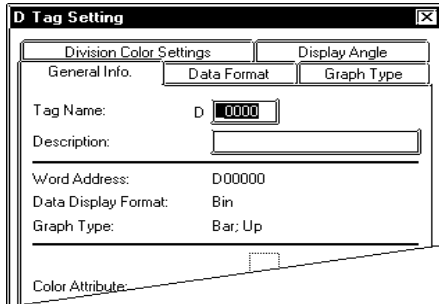

The General Info. page provides information about the current settings for D-tag.

Tag Name

Must be no more than five Single-byte or two Double-byte characters long and composed of letters and/or symbols.

Description

Up to 20 Single-byte or 10 Double-byte characters can be entered as a description of the tag.

■ Data Format

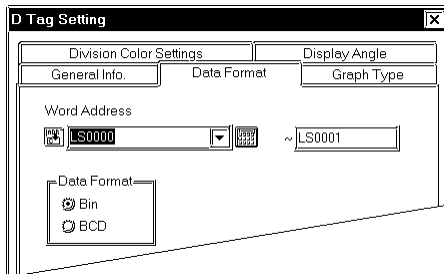

Word Address

Defines the first word address of consecutive word addresses that contains display data for a statistic graph.

Data Format

Bin

BCD

Defines the format for the data in the word addresses.

■ Graph Type/Bar Graph

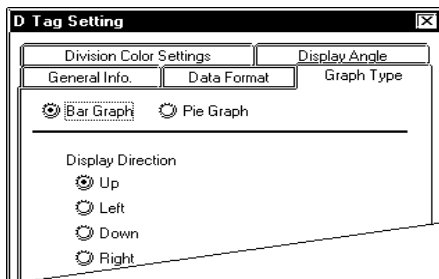

Bar Graph

Select this option to display bar graphs.

Pie Graph

Select this option to display pie graphs.

Display Direction

When using a bar graph, select the graph's display orientation, from Up, Left, Down, and Right.



When setting up the bar graph inside its rectangle border, make the graph's display area one dot smaller. If you make the graph display area the same as the drawing, the border will disappear. It is not necessary to draw display borders when using pie graphs.



To set up a bar graph's display position, designate two opposite points or draw a rectangle. For a pie graph, designate its center point and size of the internal and external circles. The radius for the internal circle must be either zero, or more than 20 dots. To create an internal circle of zero, after setting the external circle, move the cursor to the center until the internal circle disappears and then left-click.

■ Graph Type/Pie Graph

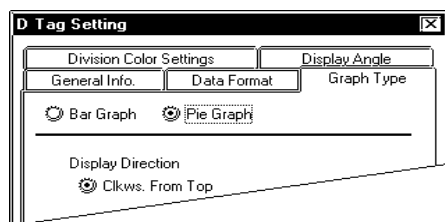

The direction of pie graph data is fixed to “Clkws. From Top”: the graph data always starts from the top of the graph and extends clockwise. When using a pie graph, it is unnecessary to set the Direction attribute.

Clockwise



■ Division Color Settings

◆ Bar Graphs

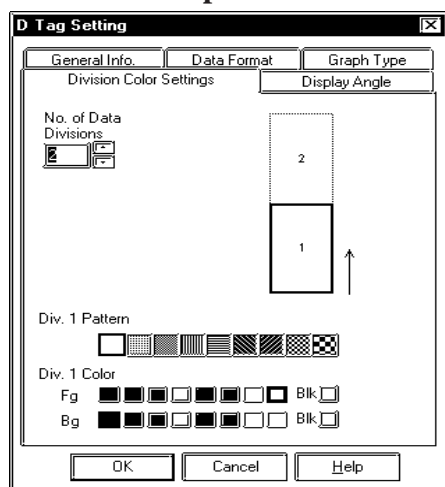

No. of Data Divisions

Defines the number of parts you want the graph divided into. You can designate from two to eight divisions. The same number of word addresses from the designated Word Address, will be automatically occupied for storing graph data.

Div.1 Pattern, Div.1 Color Fg, Bg, and Blk
Defines foreground (Fg) and background (Bg) colors, blink (Blk) and fill pattern for each division of the graph. After clicking a division on the sample graph, set color attributes.

◆ Pie Graphs

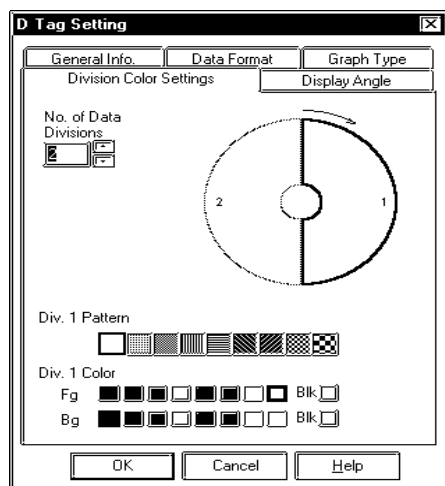

No. of Data Divisions

Defines the number of parts you want the graph divided into. You can designate from two to eight divisions. The same number of word addresses from the designated Word Address, will be automatically occupied for storing graph data.

Div.1 Pattern, Div.1 Color Fg, Bg, and Blk
Defines foreground (Fg) and background (Bg) colors, blink (Blk) and fill pattern for each division of the graph. After clicking a division on the sample graph, set color attributes.

Reference “2.1.5 Color Settings”, A-tag



Note: When setting up the No. of Divisions, the sample graph will be separated into the designated number of divisions, with the currently designated section having a heavy black border. Click on part of a division, or enter a division number displayed in the graph to designate color setup for that division.

■ Display Angle (For Pie Graphs only)

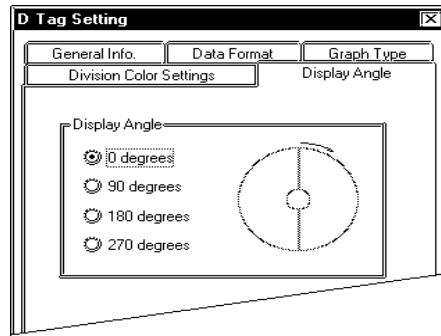

Display Angle

Designate the angle at which graph data begins, in pie graph setup only. Select 0 (zero), 90, 180, or 270 degrees.



Note: The display angle selection is not available when creating bar graphs. Use the [Graph Type] area's Display Direction settings for the bar graph.

2.5 d-tag (Statistical Data Display)

2.5.1 Overview

The d-tag feature is used to display statistical data in numeric format.

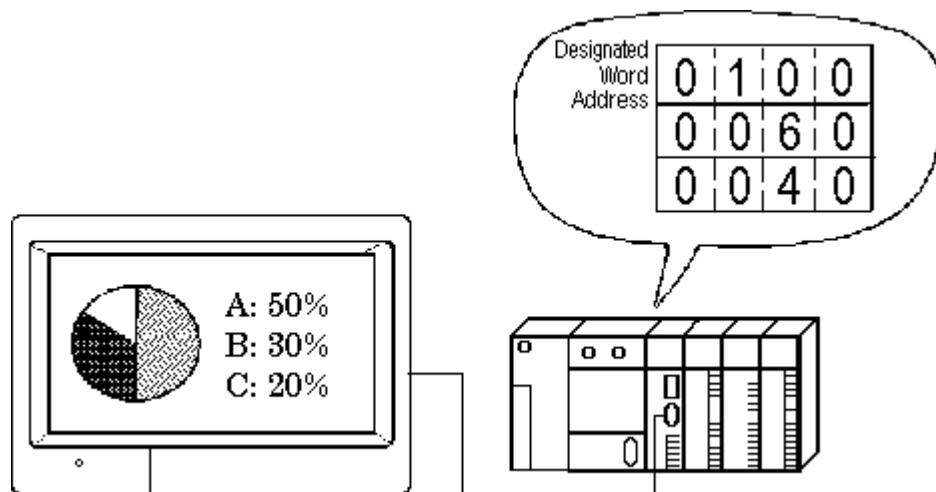

2.5.2 About d-tags

- Numeric values are displayed, according to the data in the host's (PLC's) consecutive word addresses.
- It is mainly used in combination with D-tags to display D-tag's data as a numeric value. However, it may be used independently without D-tag settings.
- There are three ways of displaying statistical data: "% Display," "Data Display," and "Data Display and % Display."
- Statistical data can be divided into a maximum of 8 parts.
- Data stored in the host (PLC) can be either binary or BCD, but not both.
- Setting up first word address for data stored enables automatic setup of the next word addresses, using the Denominator value.
- Word address data (all data) is totaled, and allocation (division) of display areas is performed automatically based on that total.

- Set up display attributes (foreground and background colors and blink attribute) for each data value.
- When using Data Display option, display style can be selected. For % Display option, display style is fixed at “Shift Right”, “Zero Suppression enabled”, and “Display Digits = 3.”



When the % Display option has been selected, the division operation may create results that, when totaled, do not add up to exactly 100.



When using a d-tag in combination with a D-tag, set the “Word Address” and “No. of Data Divisions” data to match the D-tag settings.

Reference “2.4.3 Using D-tags”, D-tag

2.5.3 Using d-tags

■ General Info.

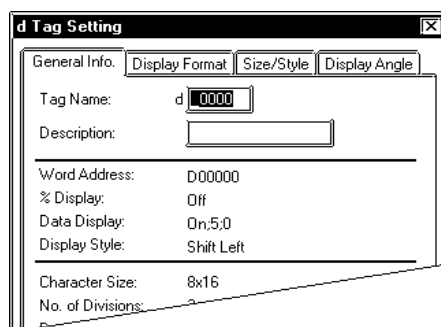

The General Info. page provides information about current settings for the d-tag.

Tag Name

Must be no more than five Single-byte or two Double-byte characters long and composed of letters and/or symbols.

Description

Up to 20 Single-byte or 10 Double-byte characters can be entered as a description of the tag.

■ Display Format

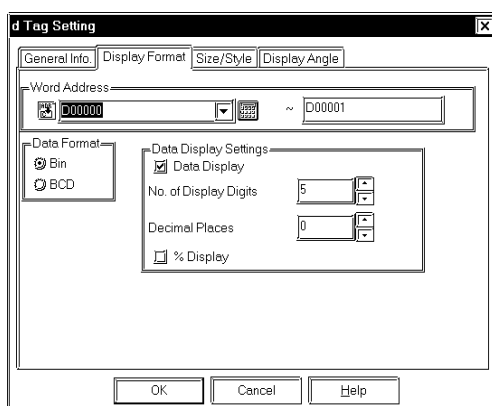

Word Address

Defines the first word address of the consecutive word addresses that contain display data for a statistic data display.

Data Format

Bin

BCD

Defines the format for the data in the word addresses.

Data Display Settings

Data Display

When the Data Display is selected, data (Bin or BCD) is displayed the way it is stored in the word addresses.

No. of Display Digits

Defines the number of places available for the display. Include the decimal numbers, but not the decimal point.

Decimal Places

Defines the number of places available after the decimal point. The allowable values are zero through 10.

% Display

When % Display is selected, statistic data is calculated as a percentage, and displays with the percent mark (%). If the Data Display is set OFF, then this setting is fixed ON.

■Size / Style

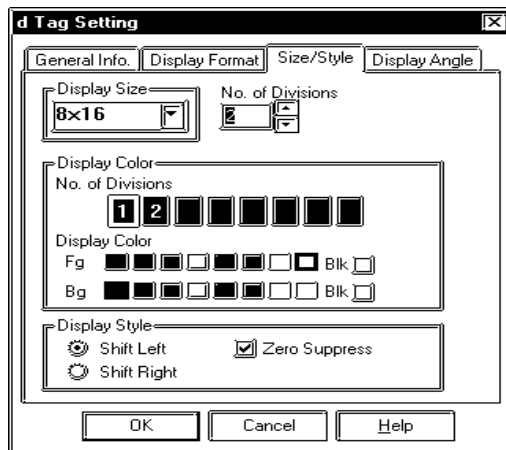

Display Size

The Display Size of characters can be specified here. With the GP2000 series, the scale ratio can be selected from integers 1 through 8. With other models, the scale ratio for the display can be selected from 1, 2, 4, and 8 times. The basic unit of measurement, "1 x 1" times, is a character measuring 16 dots by 16 dots.

16 dots



8 dots

<Single-byte Character>

When using Single-byte numerals or symbols, [6 X 10 dot], [8 X 13 dot] and [13 X 23 dot] extended fonts can be used.



Note:

Since extended font sizes are fixed, objects containing these characters cannot be enlarged or reduced while pressing down the [Ctrl] key.

No. of Divisions

Designate the number of data divisions to use. Addresses corresponding only to the levels set up here will be automatically allocated from Word Address data.

Display Color

No. of Divisions

To define colors and blink attributes for each data, click a data division number in the Divide Color Attributes area, and set the color attributes below.

Display Color

After selecting a data division number, select foreground (Fg) and background (Bg) colors, and blink (Blk) ON/OFF here for the data division.

Set the display styles: Shift Left, Shift Right, and Zero Suppress. When selecting the "% Display" option, the display style is fixed at "Shift Right," "Zero Suppress" on, and "Display Digits = 3."

Shift Left, Shift Right

Select either Shift Right or Left. Data will appear, aligned to the side designated here.

Zero Suppress

If this option is selected, leading zeros are not displayed. If not, zeroes are automatically added before the numeric values as necessary to correspond to the specified length of Display Digits. (e.g. When the Display Digit is 4 and the 0 Suppress option is not selected, 25 will appear as 0025)

 **Note:** For details about Color Attributes settings
 ▼ **Reference** ▲ 2.1.5 Color Settings, A-tag

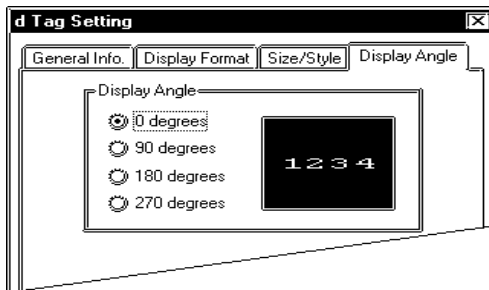
■ Display Angle**Display Angle**

Set up the rotation for the display. Select 0 (zero), 90, 180, or 270 degrees.



2.6 E-tag (Extended N-tag Function)

2.6.1 Overview

Displays data as a numeric display. The E-tag adds the following extended functions to the N-tag.

- The E-tag can change the display color when data is changed through the designation of up to 16 data ranges and colors.
- Supports Binary and Float (floating point decimal) data formats.

Reference [2.17 N-tag \(Numeric Display\)](#)

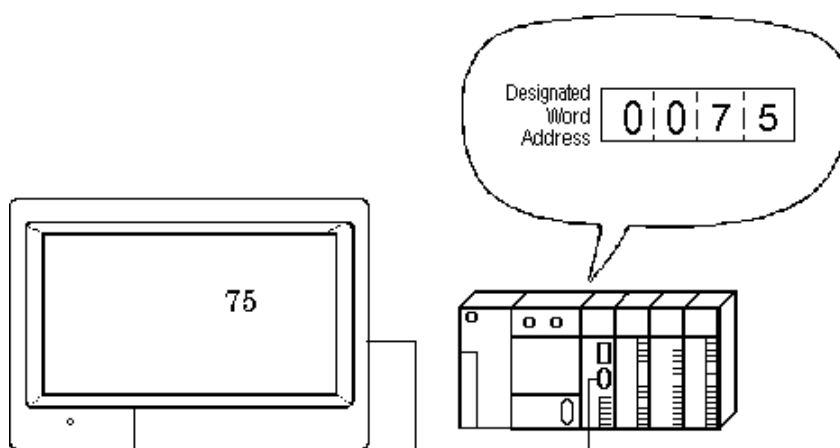

2.6.2 About E-tags

- E-tags display numeric data in real time, as the data in the host's (PLC's) word address changes.
- Word addresses which contain data to be displayed can be indirectly designated. The pointer word device type can be the same or different from the one used for indirect designation.
- Setting up the numeric data's "Number of Ranges" and "Range/Color" will allow different colors to be used for each data range.
- When [Range Type] is set to indirect, variables can also be used. To do so, the word addresses storing the ranges' minimum values are automatically set as consecutive word addresses.

E.g.

- Number of Ranges 3
- 32-bit data
- Designated Word Address for display data = n

n	— Display Data
n+1	
n+2	— Range 2 lower value
n+3	
n+4	— Range 3 lower value
n+5	

- Decimal, BCD, hexadecimal, binary, octal, and floating point formats are available.
- Both Absolute data display and Relative data displays are available. For Absolute display, the host (PLC) can store data as binary or BCD data. Relative value display uses only Binary data.
- The decimal point does not affect the number of display positions.
- Character size is adjustable.
- In Relative value display, data read by the host (PLC) responds to the designated input range (valid range) and output range and displays after being converted automatically.

This eliminates the need for a program performing compensatory calculations of data in the host (PLC) when the E-tag is used to display such things as temperature or number of rotations.

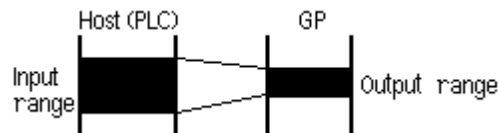

- With Absolute data, negative values are computed using *2's complement*. Relative data are computed using either a *2's complement* or *MSB code*.
- The results of an arithmetic operation on stored data can be displayed; however, for Float data-format, operations cannot be performed.
- The display styles (Shift Right/Shift Left/Centered, Zero Suppress) can be set up.
- When the host (PLC) data is 0 (zero), the display can be set so that the zero will not appear.



Note:

For information about the higher and lower word addresses when using 32-bit data:

▼ **Reference** ▲ *Device/PLC Connection Manual, "Supported Devices"*

2.6.3 Using E-tags

■ General Info.

The General Info. page provides information about the current settings for the E-tag.

Tag Name

Must be no more than five Single-byte or two Double-byte characters long and composed of letters and/or symbols.

Description

Up to 20 Single-byte or 10 Double-byte characters can be entered as a description of the tag.

■ Data Format / Absolute

Absolute

When the Absolute option is selected, the E-tag displays the data in the related word addresses as a numeric value, using the format designated for the Data Display Format attribute.

Word Address

The E-tag displays the data in the word address setup here. If the Indirect option is selected, the Word Address helps to designate where data is stored.

Indirect

Designates the Word addresses which contain the data as indirect.

Reference *“2.6.4 Indirect Word Addressing Examples”*

Addresses

The indirectly designated address is within the same device bank or area as the Word Address designated above.

Device Type & Address

Both a device type and an address are indirectly designated using device and address codes. Then, you need to enter, and the address code in the next word address.

Reference *Device/PLC Connection Manual*

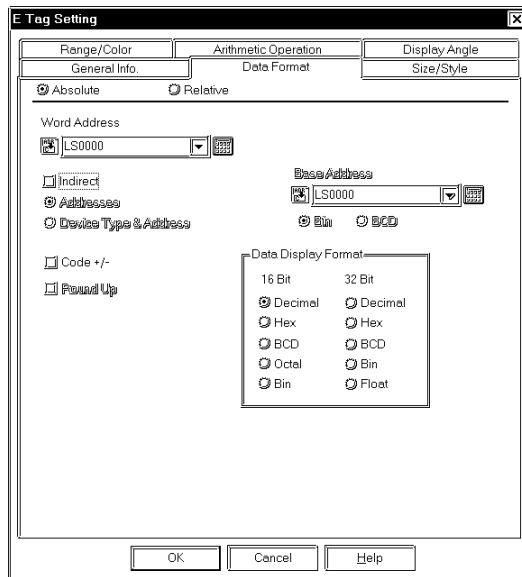

Base Address

Appears Only when the Indirect-Address option is selected. The Base address and word address are added to create the display data address.

Bin

BCD

E-tag uses the data format designated here to display the data. When Device Type & Address option is selected, the data format is fixed to Bin.

Code +/-

Use Code +/- when handling negative values. Only available when setting Decimal data.

Round Up

This option can be selected when Data Display Format is specified as “Float”(32 bit). The decimal point numbers created during data conversion will be rounded up if the number is 5 or above, and rounded down if the number is anything under five. When this option is not selected, these decimal point numbers will be rounded off (cut).

Data Display Format

The absolute data display can use 16- or 32-bit data. Select the radix from Decimal, Hex, BCD, Octal, Binary, and Float (floating point). The Octal is available for 16-bit data only, while the Float, for 32-bit data (IEEE 754 Format) only.



An error may occur due to the [Float] feature’s display digit limit. Also, if an indirectly designated address is out of range or does not exist, a communication error may occur, effecting the screen update. Check all indirectly designated data and store a correct value in the host’s (PLC) related addresses to recover the screen update.



- When using 32-bit data, the relationship of high order and low order word data will differ according to the host (PLC) type.
- Use address and device codes to indirectly designate both addresses and devices.

Reference *Device/PLC Connection Manual “Supported Devices”*

■ Data Format / Relative

The screenshot shows the 'E Tag Setting' dialog box with the 'Relative' tab selected. The 'Word Address' is set to 000000 and 'Bit Length (1-16)' is set to 16. The 'Base Address' is set to LS0000. Under 'Input Code Format', 'No Code' is selected. Under 'Display Format', 'Decimal' is selected. Under 'Input/Display Designation', 'Direct' is selected. Under 'Select Indirect Address Area', 'Area After Display Address' is selected. The 'Input Range' and 'Display Range' both have a minimum value of 0 and a maximum value of 65535. The 'OK', 'Cancel', and 'Help' buttons are at the bottom.

Relative

When the Relative option is selected, the E-tag displays a numeric value converted from the data in the designated Word Addresses based on the Input Range. If the Indirect option is selected, the data in the indirectly designated address will be converted.

Word Address

The E-tag displays the data in the address designated here.

Bit Length (1-16)

Setup the valid bit length of the data stored in the Word Address.

Indirect

Word addresses which contain the data to appear in the E-tag are indirectly designated.

Reference *“2.6.4 Indirect Word Addressing Examples”*

Addresses

The indirectly designated address is within the same device as the Word Address designated above.

Device Type & Address

Both a device type and an address are indirectly designated using device and address codes. Write the device code in the designated word address, and the address code in the next word address.

Reference *Device/PLC Connection Manual*

Base Address

Defines the base address. The E-tag displays data in the designated address by adding the base address number to the data in the Word Address.

Bin

BCD

The E-tag uses the data format designated here to display the data in the related word address. When the Device Type & Address option is selected, the data format is fixed to Bin.



Note:

For more about the Relative value input range settings

Reference *“2.17.4 Relative Data Display Settings”, N-tag*

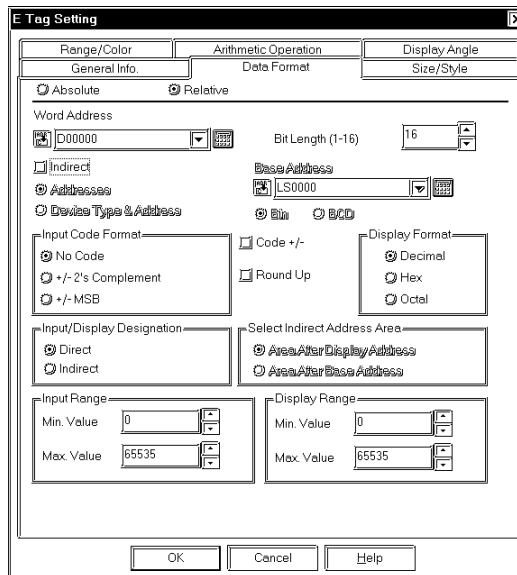

Input Code Format

No Code

Displays positive values only.

+/- 2's Complement

Uses 2's complement to express negative values.

+/- MSB

Uses MSB code system to express negative values.

Code +/-

Select the Code +/- option when displaying negative values. Only available when setting Decimal data.

Round Up

The decimal point numbers created during relative data range conversion will be rounded up if the number is 5 or above, and rounded down if the number is anything under five.

When this option is not selected, these decimal point numbers will be rounded off.

Display Format

Select from Decimal, Hex, or Octal. The relative data display can use only 16-bit data.

Input/Display Designation

Direct

The Input and Display Ranges are designated directly.

Indirect

The Input and Display Ranges can be indirectly specified. When Indirect is specified, select "Select Indirect Address Area". This setting is not enabled on the GP-270.

Word Address	+0	Display Data
	+1	Input range - Max.
	+2	Input range - Min.
	+3	Display range - Max.
	+4	Output range - Min.

Select Indirect Address Area

Area After Display Address

The input and display ranges are automatically allocated according to the indirectly specified display data address. The allocated address is displayed in the Input

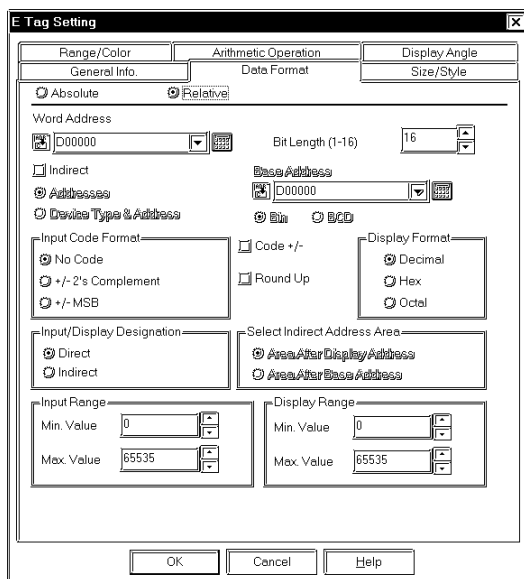

Range and Display Range fields' Max./Min. fields.

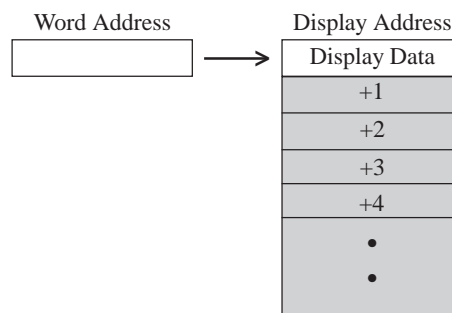

Area After Base Address

The input and output ranges are automatically allocated according to the display data address specified in the Word Address field. The allocated address is displayed in the Input Range and Output Range fields' Max/Min fields.

◆ **Address Allocation in Indirect Designation**

+0	Index
+1	Range 2 lower limit
+2	Range 3 lower limit
+3	Input range - Max.
+4	Input range - Min.
+5	Display range - Max.
+6	Display range - Min.

Indirect Designation Area "After Base Address"
Input/Display Designation "Indirect"
Color Designation "Indirect"
No. of Ranges: 3

+0	Display Data
+1	Range 2 lower limit
+2	Range 3 lower limit
+3	Input range - Max.
+4	Input range - Min.
+5	Display range - Max.
+6	Display range - Min.

Indirect Designation "Area After Display Address"
Input/Display Designation "Indirect"
No. of ranges: 3

+0	Index
+1	Input range - Max.
+2	Input range - Min.
+3	Display range - Max.
+4	Display range - Max.
+5	Color code

Indirect Designation "Area After Display Address"
Input/Display Designation "Indirect"
Color Designation "Indirect"

+0	Display Data
+1	Input range - Max.
+2	Input range - Min.
+3	Display range - Max.
+4	Display range - Max.
+5	Color code

Indirect Designation "Area After Display Address"
Input/ Display Designation "Indirect"
Color Designation "Indirect"

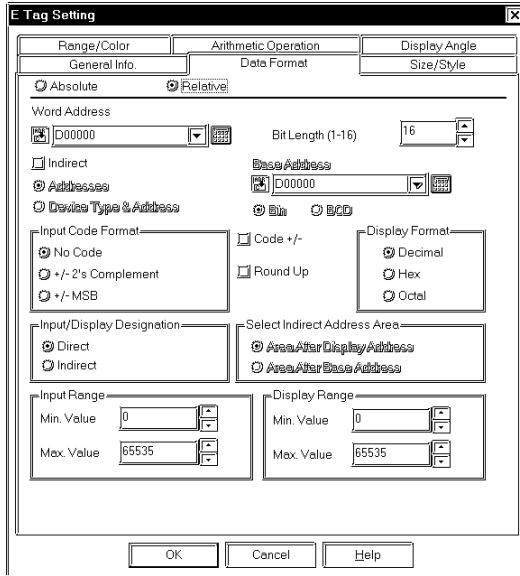

Input Range

Min. Value

Max. Value

Defines the range of values used in data conversion in the Word Address. The possible ranges depend on the Code Input setting used. When the Indirect option is selected, set the data storage range in the indirectly designated address.

Display Range

Min. Value

Max. Value

Defines the range of values displayed after data conversion. The possible ranges depend on the Display Format and Code +/- settings.

<Minimum and Maximum Values of the Input and Output Ranges>

	Data Format		Input Range	Display Range
	Code Input	Code +/-		
Dec	No Code	+/-	0 - 65535	-32768 - 32767
		+		0 - 65535
	2's complement	+/-	-32768 - 32767	-32768 - 32767
		+		0 - 65535
MSB	+/-	-32767 - 32767	-32768 - 32767	
	+		0 - 65535	
Hex	No Code	/	0 - 65535	0 - FFFF (h)
	2's complement	/		0 - FFFF (h)
	MSB	/	-32767 - 32767	0 - FFFF (h)
Oct	No Code	/	0 - 65535	0 - 177777 (o)
	2's complement	/	-32768 - 32767	0 - 177777 (o)
	MSB	/	-32767 - 32767	0 - 177777 (o)

■Size/Style

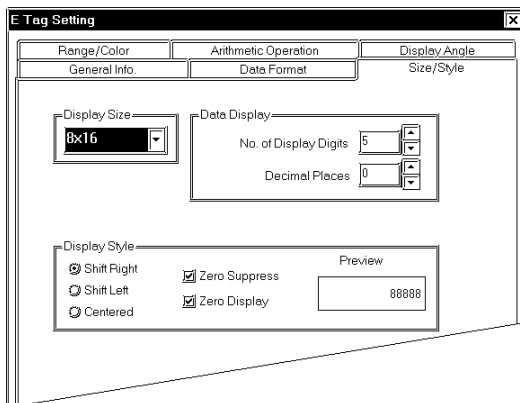

Display Size

The Display Size of characters can be specified here. With the GP2000 series, the scale ratio can be selected from integers 1 through 8. With other models, the scale ratio for the display can be selected as either 1, 2, 4 or 8 times. The Display Size should be selected as either 1, 2, 4 or 8 times for "Half (h)" mode. The basic unit of measurement, "1 x 1" times, is 8 dots by 8 dots in Half mode, and 8 dots by 16 dots in Full mode. "Half" mode is available with GP77R, GP377 and GP2000 series units.

When using Single-byte numerals or symbols, [6 X 10 dot], [8 X 13 dot] and [13 X 23 dot] extended fonts can be used.



Note: Since extended font sizes are fixed, objects containing these characters cannot be enlarged or reduced while pressing down the [Ctrl] key.

Data Display

No. of Display Digits

Defines the number of digits the E-tag can contain.

Decimal Places

Defines the number of digits displayed after the decimal point (the decimal point is not included).

Display Style

Shift Left

Shift Right

Centered

Select one from the Shift Left, Shift Right, and Centered options. The E-tag displays data starting from the position designated here.

Zero Suppress

Normally, when 0 suppression is ON (clicked), all unnecessary 0's are not displayed. When turned OFF, 0's are added to the front of numbers to match the Display Length. (e.g. When the Display Digit is 4 and 0 suppression is OFF, value 25 will appear as 0025.)

Zero Display

When the display value is 0 (zero), and when this option is not clicked, that "0" value will not display.

■ Range/Color

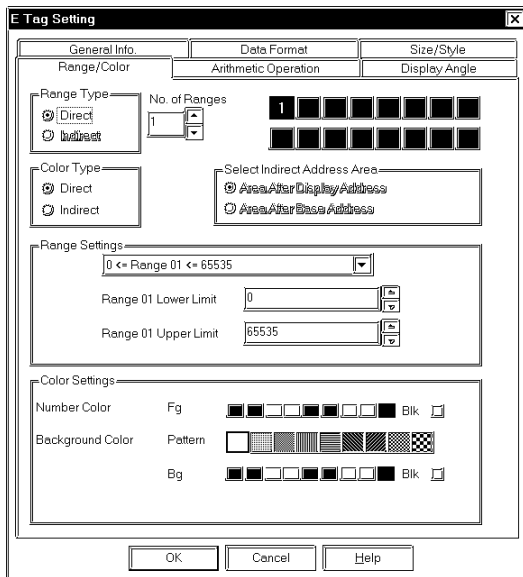

Range Type

Direct

If the Direct option is selected, set the upper and lower limits of the range while creating the tag.

Indirect (Enabled when No. of Ranges is 2 or more)

Indirect option will be valid when 2 or a larger value is set in the Number of Ranges attribute. The ranges are then designated by variables. The addresses to store the lower limits for each range will be automatically allocated to the word addresses immediately following the Word Address designated on the Data Format page. If Indirect is selected on the Data Format page, use the Select Indirect Address Area to select how range limit addresses are designated.

No. of Ranges

If you want to change the E-tag color as the value increases or decreases beyond a certain range, designate the number of value ranges. The range is 2 to 16.

Color Type

Direct

Specifies the color attributes for each Range No.

Indirect

This option is valid when No. of Ranges are 1. Specify the color attributes for the address displayed in the Color Settings field. However, this setting is not enabled on the GP-270.

Reference “2.10.4 Object Drawing Data/Color attributes”, H-tag

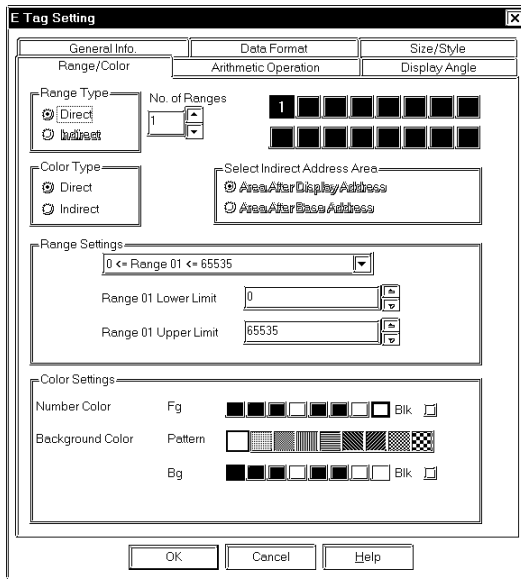

Select Indirect Address Area

Area After Display Address

Defines range values in consecutive addresses following the data display addresses. The allocated address is displayed in either “Range Settings” or “Color Settings” field.

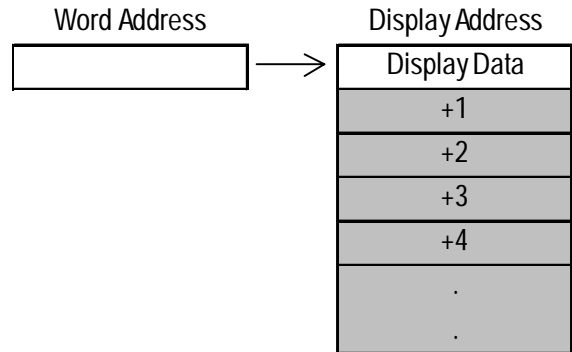

After Base Address

Defines range values in consecutive addresses following the Base Addresses. If the Device Type & Address option is selected on the Data Format page, these addresses will be allocated from the second and later Word Addresses from the Word Address. The allocated address is displayed in either “Range Settings” or “Color Settings” field.

◆Address Allocation in Indirect Designation

+0	Index
+1	Range 2 lower limit
+2	Range 3 lower limit
+3	Input range - Max.
+4	Input range - Min.
+5	Display range - Max.
+6	Display range - Min.

Indirect Designation Area
 "After Base Address"
 Input/Display Designation
 "Indirect"
 Color Designation "Indirect"
 No. of Ranges: 3

+0	Display Data
+1	Range 2 lower limit
+2	Range 3 lower limit
+3	Input range - Max.
+4	Input range - Min.
+5	Display range - Max.
+6	Display range - Min.

Indirect Designation
 "Area After Display
 Address
 Input/Display Designa-
 tion "Indirect"
 No. of ranges: 3

+0	Index
+1	Input range - Max.
+2	Input range - Min.
+3	Display range - Max.
+4	Display range - Max.
+5	Color code

Indirect Designation "Area
 After Display Address
 Input/Display Designation
 "Indirect"
 Color Designation "Indirect"

+0	Display Data
+1	Input range - Max.
+2	Input range - Min.
+3	Display range - Max.
+4	Display range - Max.
+5	Color code

Indirect Designation "Area
 After Display Address
 Input/ Display Designation
 "Indirect"
 Color Designation "Indirect"

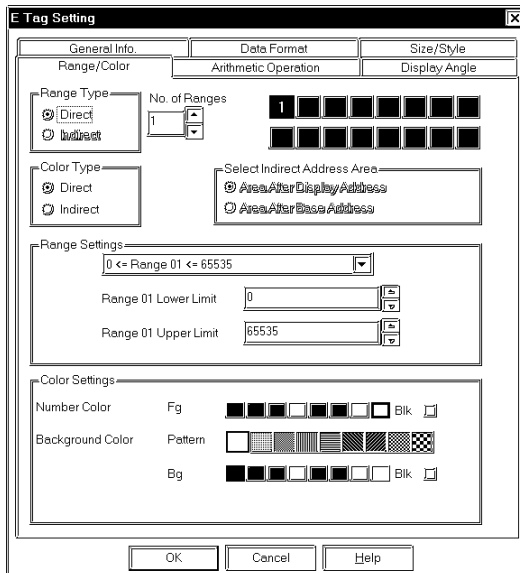

Range Settings
 Current Value

The selected range number's range is displayed. Here, the range number can also be selected.

Range 01 Lower Limit
 Range 01 Upper Limit

The selected range number's upper and lower limit values are displayed.

Color Settings
 Number Color

The value foreground (display) (Fg) color and blink (Blk) status are specified.

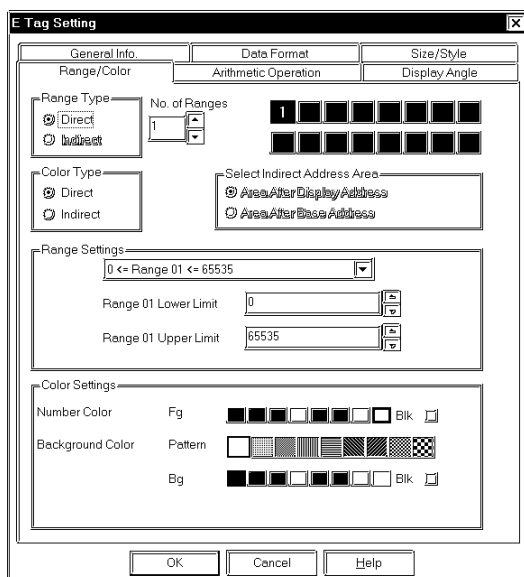

Background Color

The value background pattern, background color (Bg), and blink condition (Blk) are specified. The pattern's background color (Pc) is specified by this value background pattern setting. The background pattern colors are the combination of Bg and Pc colors. However, for GP-270, even though colors can be selected on your PC's screen, only the pattern "0" (white) will appear on the GP.

Reference "2.1.5 Color Settings", A-tag



Note: For more about the Relative value input range setup:

Reference "2.17.4 Relative Data Display Settings", N-tag

Eg.)

16 bit data/3Ranges

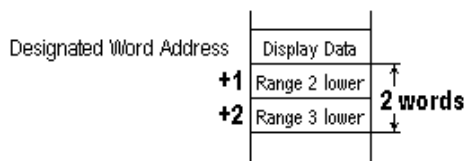

32 bit data / 3Ranges

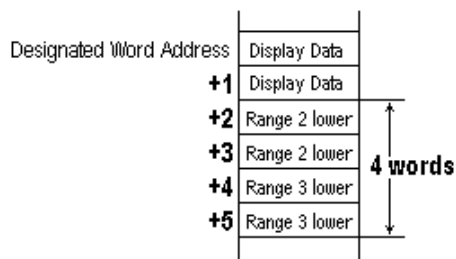

<Data Format Range>

Data Format			Range
		Code +/-	
16 Bit	Dec	+/-	-32768 - 32767
		+	0 - 65535
	Hex	/	0 - FFFF (h)
	Oct	/	0 - 177777 (o)
	Bin	/	0 - FFFF (h)
	BCD	/	0 - 9999
32 Bit	Dec	+/-	-2147483648 - 2147483647
		+	0 - 4894967295
	Hex	/	0 - FFFFFFFF (h)
	Bin	/	0 - FFFFFFFF (h)
	BCD	/	0 - 99999999
	Float	/	-9.9e ¹⁶ - 9.9e ¹⁶

■ Arithmetic Operation

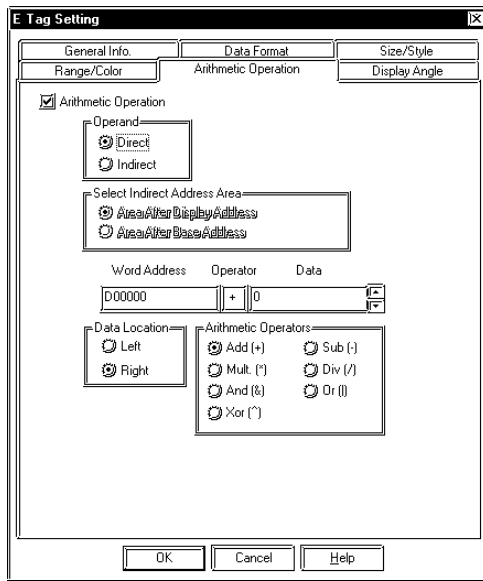

Arithmetic Operation

If this item is selected, an arithmetic operation will be performed to the data retained from the word address, and the resulting data is displayed. This function works only when the Number of Ranges attribute on the Range Setting page is set to one.

Operand

Direct

Select this option to directly designate the operand.

Indirect

Select this option to indirectly designate the operand using the Word Address. If the Indirect option is not selected on the Data Format page, that page's Word Address data and the following address will be the operand. If the Indirect option is selected, the Area After Display Address settings shown below will be valid.

Select Indirect Address Area

Area After Display Address

Arithmetic operations take place using the values stored in the display data address, and the address that follows.

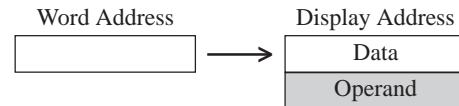

Area After Base Address

The operand storing addresses will be the consecutive addresses following the Word Address set on the Data Format page. If the Device Type & Address option is selected on the Data Format page, these addresses will be allocated to the third and later addresses from the Word Address setting.



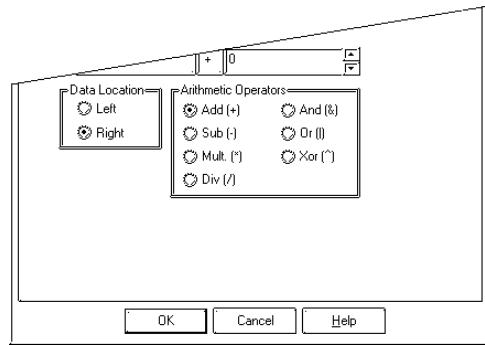

Data

When operand setting is Direct, the data designated here will be the operand.

Data Location

Select the data location from Left and Right.

Arithmetic Operators

Select an operator for the arithmetic operation.



When “Arithmetic Operation/Arithmetic Operation Data/Indirect” is selected with the following two conditions valid, “**+2” displayed as a result of the arithmetic operation actually means “****+1”.**

- When selecting Indirect, Device Type & Address, and Display Data Type/32 bits in the Data Format area during tag settings.
- When the device code stored in the Base Address is 32 bit device.

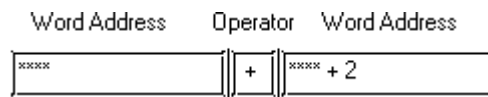

- Only when the Number of Ranges setting in the Range Setting page is 1, and the Data Format area’s Absolute setting is selected, the Arithmetic Operator is enabled.
- Any overflowing digits resulting from an arithmetic operation are ignored.
- If division produces a remainder, an error may occur as a result of rounding the decimal.
- These operations cannot be performed when the Float data format is selected.

Reference “2.6.4 Indirect Word Addressing Examples”

■ Display Angle

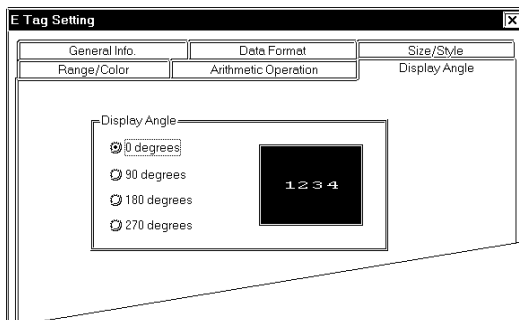

Display Angle

Set up the rotation for the display. Select 0(zero), 90, 180, or 270 degrees.

2.6.4 Indirect Word Addressing Examples

Example 1: The Indirect and Address options are selected, and Word address D35 is indirectly designated.

The following example assumes that D00100 is designated as the Word Address, and D0010 (BCD) as the base address.

PLC (Word Address)

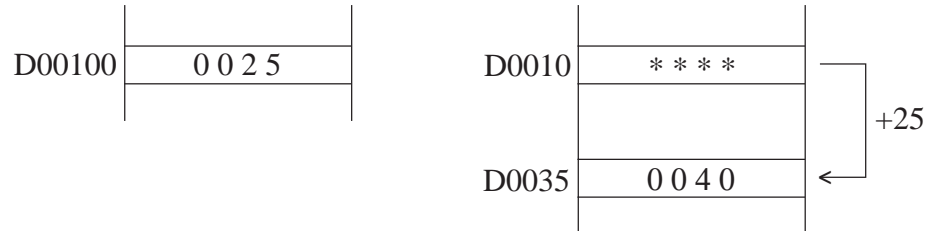

The data in the specified Word Address D00100 will be regarded as the offset value from the specified base address.

GP Display

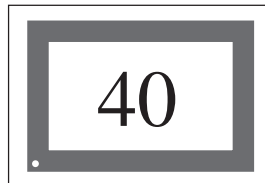

The Word Address value (D00100) "25" is added to the base address value (D0010) and is placed in D0035 and the summed value; the data "40" is displayed.

Example 2: The Indirect option and Device Type & Address option are selected, and the Word address CN35 is indirectly designated.

The following example assumes that D00100 (BCD) is designated as the Word Address (when using a Mitsubishi A Series PLC).

PLC (Word Address)

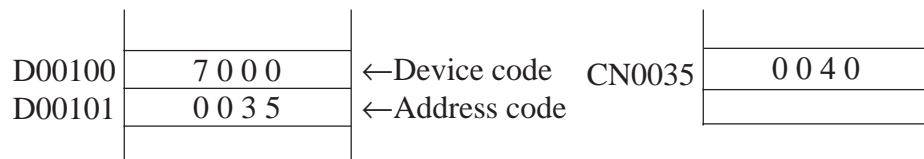

The Data in the specified Word Address D00100 will be regarded as the device code and the data of +1 in the D00101 as the address code.

Device code CN : 7000h

Address code 0035

GP Display

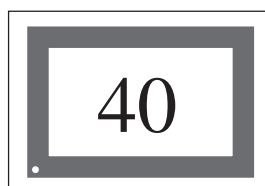

As a result, the E-tag will display address CN0035's data specified with D00100 and D00101.



For details about indirect designation:

Reference *Device/PLC Connection Manual, “A2.1 PLC Devices and Address Codes (by Maker)”*

Example 3: The Indirect option is selected on the Range Setting or Arithmetic Operator page.

◆ **When the After Display Address option is selected:**

Previous page’s example 1

Previous page’s example 2

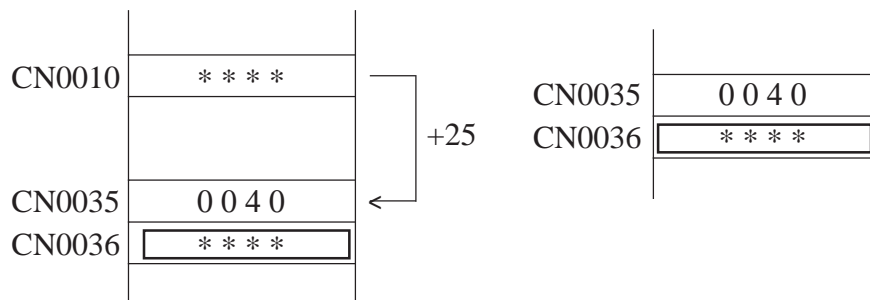

In both cases, CN0036 will be used for range setting and arithmetic operations. Addresses used will be allocated to the number of addresses designated by the Number of Ranges attribute.

◆ **When the After Base Address option is selected:**

Previous page’s example 1

Previous page’s example 2

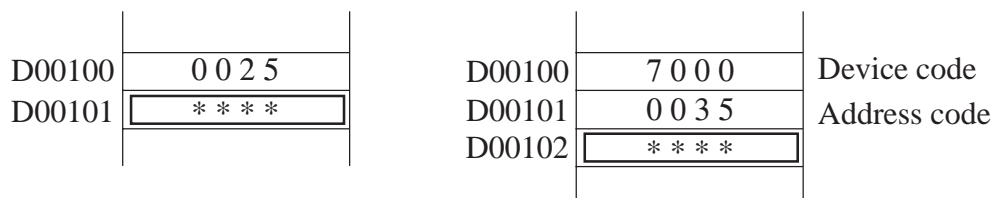

The range setting or arithmetic operation address will be D00101, which follows the Word Address D00100 in example 1. In example 2, the address will be D00102 because two word addresses, will be used for designating device and address codes. For the Range setting, the required addresses will be automatically allocated from D00101 or D00102.



2.7 F-tag (Free Library Display)

2.7.1 Overview

F-Tags can be used to bring up Base or Image Library screens (library *1) in the position indicated by the data of the host (PLC) word address. F-tags make the display of moving objects possible, anywhere on the screen.

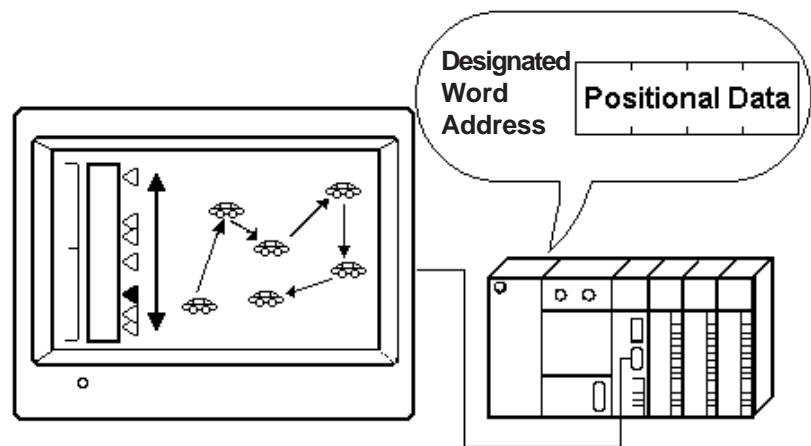

*1. When a drawing or screen is used often, You can create the image on a Base Screen and register it, as a library item. The library's registered image is then displayed in the designated area, with the image's center point being placed at the desired position. This option is designated relative to a given start point.

2.7.2 About F-tags

- There are two Operation Mode settings in the F-tag:

Area movement and Two Point movement.

Area Movement

The library object moves within the selected area. Reserve two words for the data coordinates.

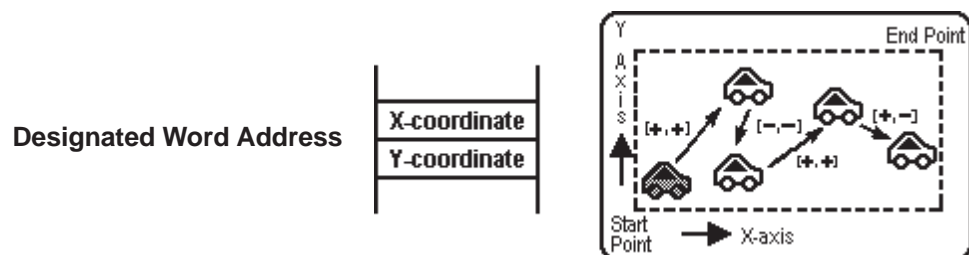

Two Point Movement

The library object moves directly between two points. Reserve one word for the movement data.

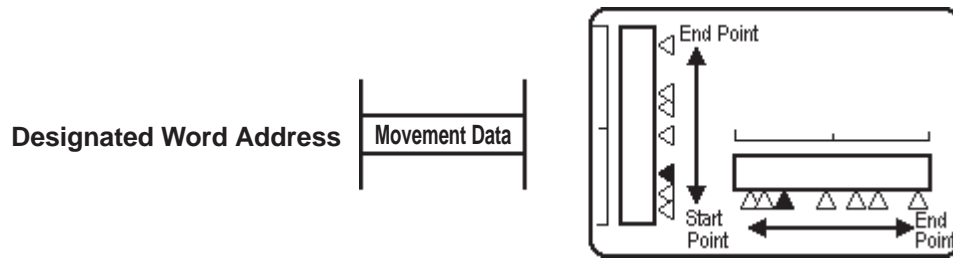

- The GP converts coordinate or movement data stored in the Word Address and calls in the library item to the designated coordinates.
- Displays the library of the designated screen. There are two types of Screen Access setups: Direct and Indirect.
- When Screen Access is Direct, the library's screen number is fixed.
- When Screen Access is Indirect, the library's screen number is variable.
- An offset is available for designating the screen number.



- **When creating multiple F-tags, make sure that an F-tag's moving objects do not overlap others on the display. When they do, the objects will not display properly.**
- **When there is another drawing in the F-tag library movement area, if the drawing and library object overlap, the display will disappear due to the GP's XOR display logic.**
- **Called objects using 3-dot or 5-dot line types will not display.**



Libraries that contain filled drawings take time to redraw. Avoid using fills in libraries retrieved using F-tags.

- The coordinates for area movement will be designated by the Display Type setting (normal or portrait).

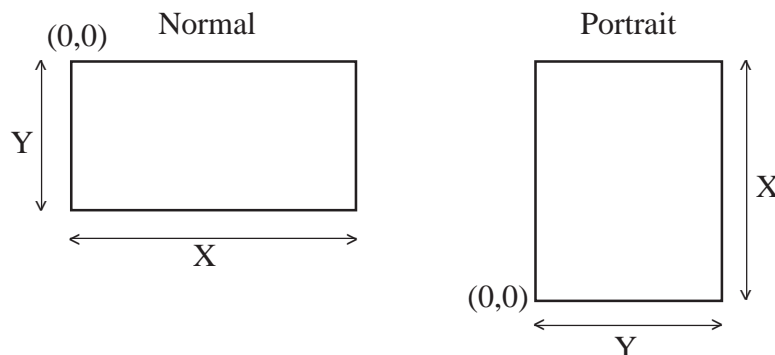

2.7.3 Using F-tags

■ General Info.

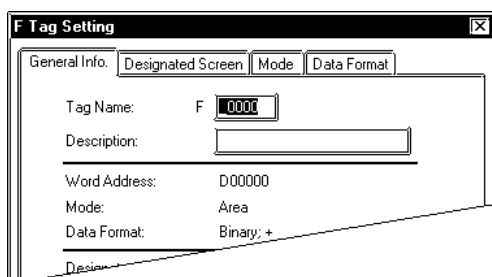

The General Info. page provides information about the current settings for the F-tag.

Tag Name

Must be no more than five Single-byte or two Double-byte characters long and composed of letters and/or symbols.

Description

Up to 20 Single-byte or 10 Double-byte characters can be entered as a description of the tag.

■ Designated Screen/Direct

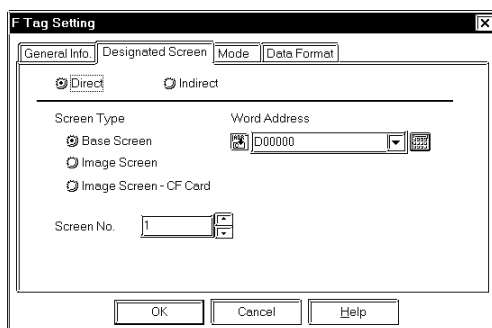

Direct

Select this option to directly designate a library's screen number in the Screen No. field.

Screen Type

Base Screen

Image Screen

Select the type of screen you want to display, Base screen or Image screen.

Image Screen-CF Card

Select this when you want to designate the Image screen saved to the CF Card.

Word Address

Defines the word address containing the data used in determining the movement of the library item.

Screen No.

Enter the screen number (Base screen or Image screen) of the library item that you would like to display.

■ Designated Screen/Indirect

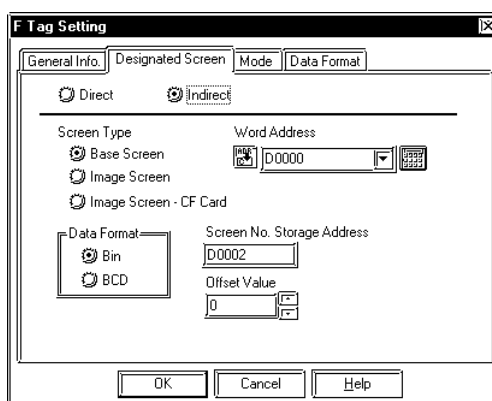

Indirect

Select this option to indirectly designate the library item's screen number via the Word Address.

Screen Type

Base Screen

Image Screen

Select the type of screen you want to display, Base screen or Image screen.

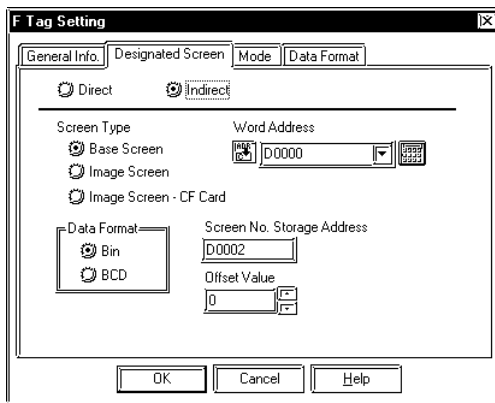

Image Screen-CF Card

Select this when you want to designate the Image screen saved to the CF Card.

Word Address

Defines the word address containing the data library item's movement.

Data Format

Bin

BCD

Defines the type of data stored in the (coordinate or movement data) Word Address.

Word Address

Defines the word address containing the screen number.

Offset Value

Defines an offset value to be added to the Word Address data (screen number). When not using the Offset, enter a value of 0.

Reference "2.14.7 Offset Settings", L-tag

■ Mode/Area Move

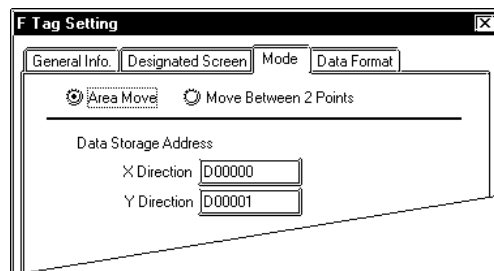

Area Move

Moves the library image to any point in the designated F-tag area by defining the X and Y coordinates. In this case, two word addresses are used to store the coordinate data. Thus, two consecutive addresses from the designated Word Address are used for data storage. Address +0 is for the X-coordinate data, and +1 is for the Y-coordinate data.

Data Storage Address

X Direction

Y Direction

Two word addresses, related to the Word Address designated on the Screen Access page, will display here.

■ Mode/Move Between 2 Points

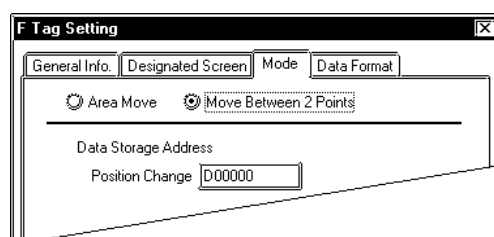

Move Between 2 Points

Moves the library between two designated points. For this type, only one word address is required for storing movement data.

■ Data Format

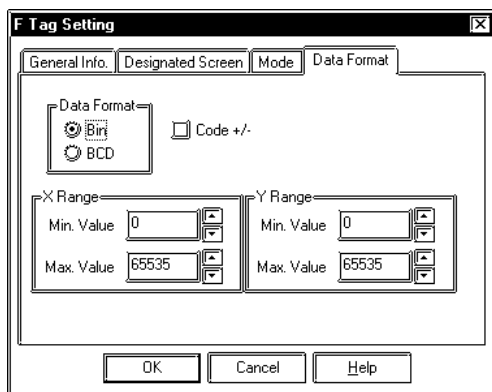

Data Storage Address

Position Change

The Word Address designated on the Screen Access page will be displayed here. This address is used to store movement data.

Data Format

Bin

BCD

Defines the type of data stored in the Word Address used for coordinate and movement data.

Code +/-

Defines whether or not negative values can be used. Available only when set to Bin format.

X Range

Min. Value

Max. Value

Defines the minimum and maximum values for the X coordinate. These fields appear when the Area option has been selected on the Operation Mode page.

Y Range

Min. Value

Max. Value

Defines the Y coordinate's minimum and maximum values. These fields appear when the Area option has been selected on the Operation Mode page.

<Data Format - Data Range>

Data Format		Range
	Code +/-	
Bin	+/-	-32768 - 32767
	+	0 - 65535
BCD		0 - 9999



Note: Do not store data in the designated Word Addresses that is outside the X Range, Y Range, or Move ranges.



2.8 G-tag (Graph Display)

2.8.1 Overview

Displays data in any of three graph types: bar, pie, and half pie.

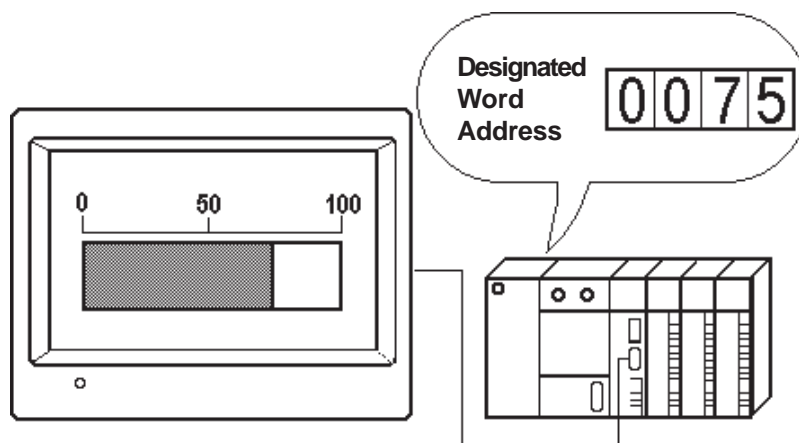

2.8.2 About G-tags

- Data stored in the Host's designated word address (PLC) is displayed on the graph in real-time.
- Absolute and Relative data formats are available. Both binary and BCD formats can be designated for Absolute data, however only binary format is available for Relative data.
- When using Relative data, data read by the host (PLC) is automatically converted in accordance with the designated Input Range. Therefore, a data calculation program in the host (PLC) can be omitted.
- With Absolute data, negative values are calculated using 2's complement. With Relative data, select either 2's complement or MSB code.
- By designating an upper and lower display data limit, an Alarm function can be used to warn of data values exceeding these limits.
- For Relative data, an alarm can be used when the data is outside the designated valid range.
- Alarm values can be set as indirect or fixed. When the alarm is set as indirect, the addresses for storing the upper and lower limits are automatically allocated to the word addresses immediately following the graph's display data storage address.
- Graph patterns can be selected from the following two types: Pattern (which fills the data display portion, Single-byte type), and Meter (which displays the data using a needle).
- Display direction, color attributes and fill patterns can be selected.

2.8.3 Using G-tags

■ General Info.

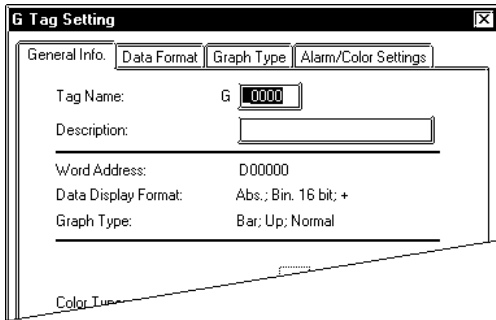

The General Info. page provides information about the current settings for the G-tag.

Tag Name

Must be no more than five Single-byte or two Double-byte characters long and composed of letters and/or symbols.

Description

Up to 20 Single-byte or 10 Double-byte characters can be entered as a description of the tag.

■ Data Format/Absolute

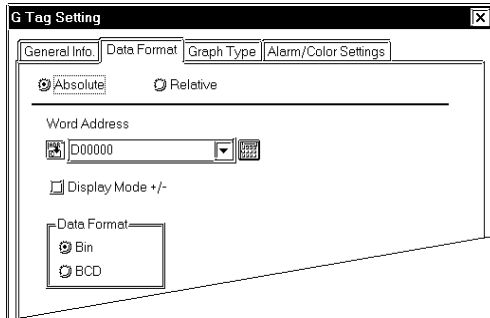

Absolute

Select this option to display the absolute value data. The data can be binary or BCD format.

Word Address

Defines the address containing the display data (16-bit data).

Display Mode +/-

Use this setting to display negative data. Only available for binary data.

- **Checked** : Displays negative data (-100 to 100)

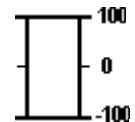

- **Not Checked** : Does not display negative data. (0 to 100)

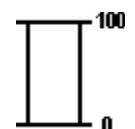

Data Format

Bin

BCD

Defines the format of the Word Address's data.

■ Data Format/Relative

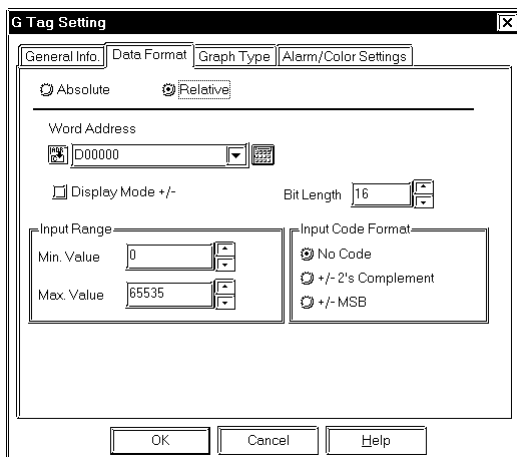

Relative

If you select this option, data is converted using the designated Input Range.

Word Address

Defines the word address containing the display data (16-bit data).

Display Mode +/-

Use this setup to display negative data.

Bit Length

Enter a value between one and 16. Defines the valid bit length of the data stored in the Word Address.

Input Range

Min. Value

Max. Value

Set up the range of the data stored in the Word Address. The setup range limits vary with the Code Input.

Input Code Format

No Code

Displays positive values only.

+/- 2's Complement

Uses 2's complement to express negative values.

+/- MSB

Uses MSB code system to express negative values.

<Min./Max. Input Range Values>

Input Code Format	Input Range
No Code	0 - 65535
2's Complement	-32768 - 32767
+/- MSB	-32767 - 32767

■ Graph Type/Bar Graph

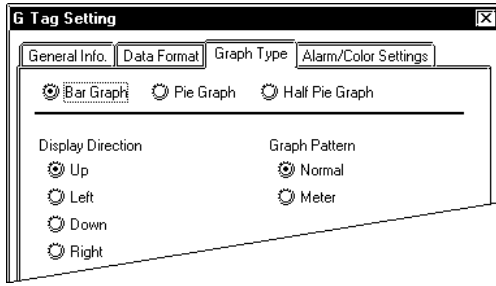

Bar Graph

Select this option to display data via a bar graph.

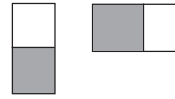

Display Direction

Defines whether the graph data points Up, Down, Left, or Right.

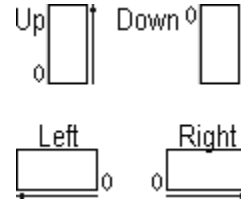

Graph Pattern

Normal

Meter

When Meter is selected, the needle uses the foreground color, and the meter face uses the background color.

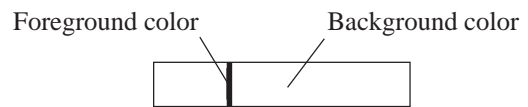

Treat this setting as a normal color attribute when using the Alarm.

■ Graph Type/Pie Graph

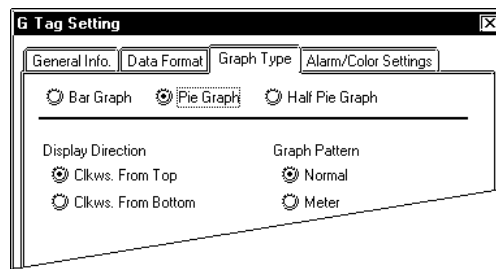

Pie Graph

Select this option to display a pie graph.



Display Direction

Clkws. From Top

Clkws. From Bottom

Defines the direction of the data display.



Clkws. From Top Clkws. From Bottom

■ Graph Type/Half Pie Graph

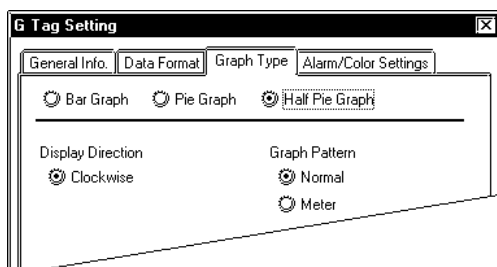

Graph Pattern

Normal

Meter

When Meter is selected, the needle uses the foreground color, and the meter face uses the background color.

Half Pie Graph

Select this option to display a half-pie graph.



Display Direction

Clockwise

The direction is fixed to clockwise.



Graph Pattern

Normal

Meter

When Meter is selected, the needle uses the foreground color, and the meter face uses the background color.



Important

When drawing a rectangular frame for the bar graph, be sure to draw the frame so that it is one dot outside the graph display area. If the graph and frame overlap, the frame will disappear. However, it is unnecessary to draw a frame for the Pie or Half-Pie graph.



Note:

When setting up the Bar graph's display position, two opposite points need to be set up in the same manner as when draw a rectangle. When setting up the Pie or Half-pie, set up the center point, then the radius of the outer and inner circles. The radius of the inner circle must be at least 20 dots. To omit the inner circle, after setting the external circle, move the cursor to the center until the internal circle disappears, and left-click.

■ Alarm/Color Settings

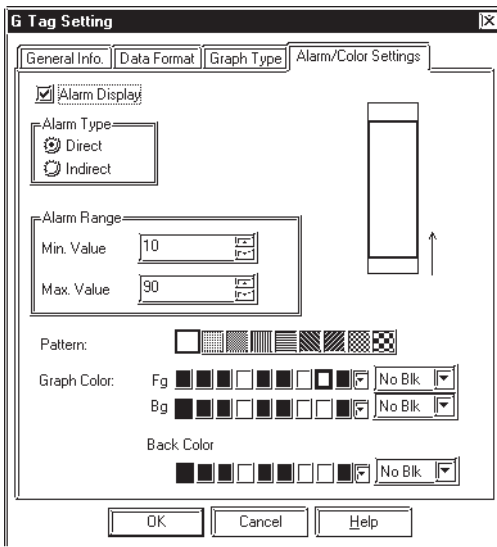
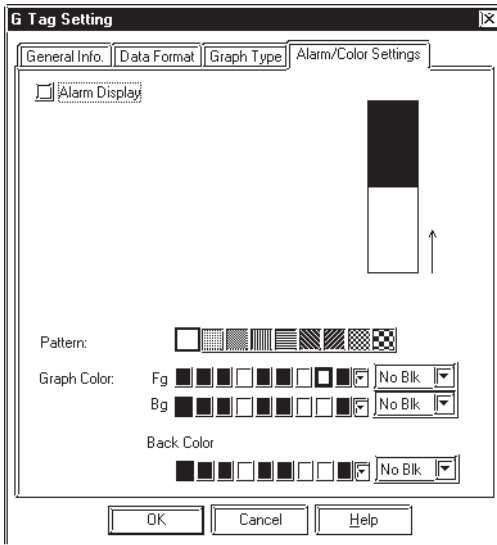

Pattern

Defines the fill pattern for the graph.

Graph Color

Defines the foreground and background colors and the blink attribute for the graph.

Reference “2.1.5 Color Settings”, A-tag

Back ground color

Defines the Background (Bg) color. Available with GP377, GP77R, GLC300 and GP/GLC2000 series units.

Alarm Display

Select this option to use the alarm function.

Alarm Type

Direct

Select this option to directly designate the upper and lower limits of alarm values.

Indirect

Select this option to indirectly designate the upper and lower limits of alarm values. The data in the address immediately following the Word Address designated in the Data Format page will be the upper limit, and the data in the next address will be the lower limit.

Alarm Range

Min. Value

Max. Value

If the Alarm Type has been set to Direct, designate the upper and lower limits of the alarm values.

Pattern

Select the fill pattern for the selected portion of the graph.

Graph Color

After clicking on the upper or lower range of the left-side’s sample graph, select the foreground and background colors and blink attribute for that range.

Back Color

Designates the Background (Bg) color. Available with GP377, GP77R, GLC300 and GP/GLC2000 series units.



Note: When “Meter” is specified for the graph pattern, the graph color Settings’ foreground color (Fg) will be the meter’s needle color, and background (Bg) will be the entire graph color.

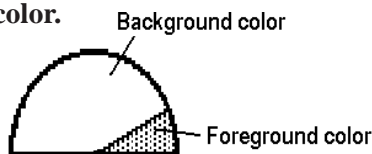



2.9 g-tag (Extended G-tag Function)

2.9.1 Overview

Displays data in one of three graph types: bar, pie, and half-pie. A g-tag is a G-tag's extension, and depending on what color attributes and data ranges have been set up, allows the color of the displayed data values to be changed. Up to 16 data ranges and colors can be set up.

Reference [2.8 G-tag \(Graph Display\)](#)

LEGEND

Data range 0~50  Color
Data range 50~100  Color

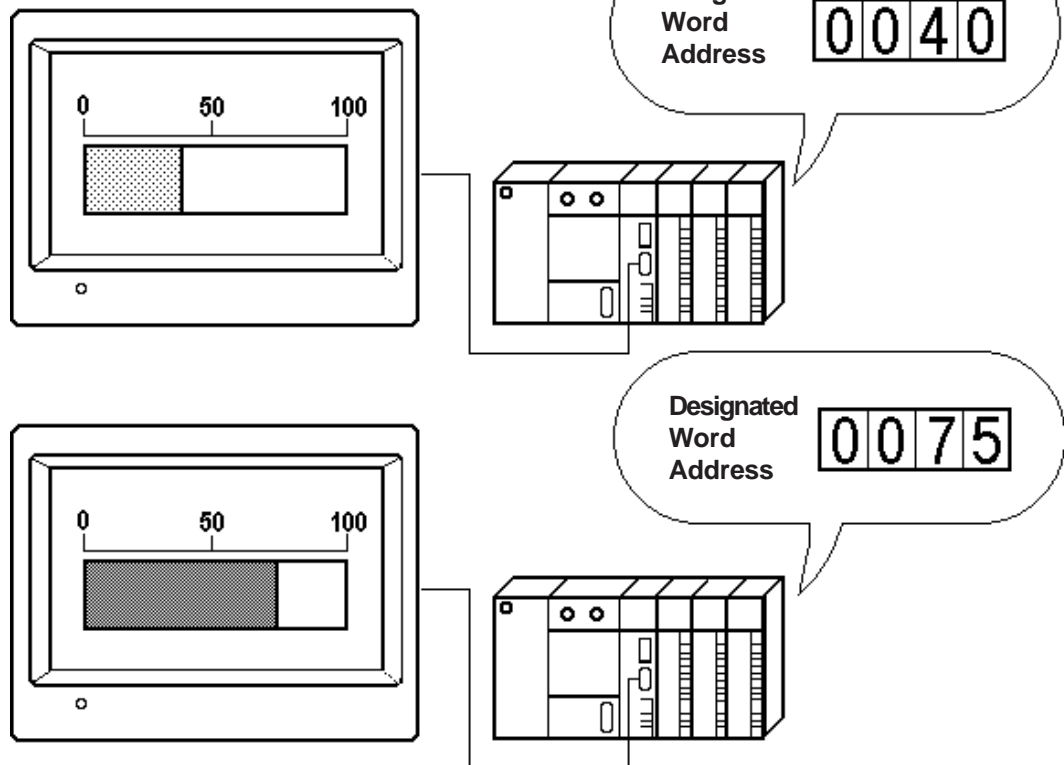

2.9.2 About g-tags

- g-tags use bar, pie, or half-pie graphs to display host (PLC) word address data in real-time.
- Absolute and Relative data formats are available. Both binary and BCD formats can be designated for Absolute data, however only binary format is available for Relative data.

- When using Relative data, data read by the host (PLC) is automatically converted according to the designated Input Range. A program for re-calculation of the host (PLC) data can be omitted.
- With Absolute data, negative values are computed using 2's complement. With Relative data, select 2's complement or MSB code.
- Setup the number of ranges for the display data, then designate the range limits and select the display colors for each data range. The data in each range will appear in the designated color.
- The data ranges can be set as indirect or fixed. When ranges are set as indirect values, the addresses for storing the range's lower limits data are automatically allocated to the word addresses that follow the graph's data storage address.

E.g.

• No. of Ranges 3	n	Display Data
• 16 bit data	n+1	Range 2 lower limit value
• Display data storage address = n	n+2	Range 3 lower limit value

- For Relative data, when display data is outside the designated range, the color changes to the maximum or minimum range's colors.
- Graph patterns can be selected from the following two types:
 - Pattern (which fills the data display portion, Single-byte type)
 - Meter (which displays the data using a needle)

2.9.3 Using g-tags

■ General Info.

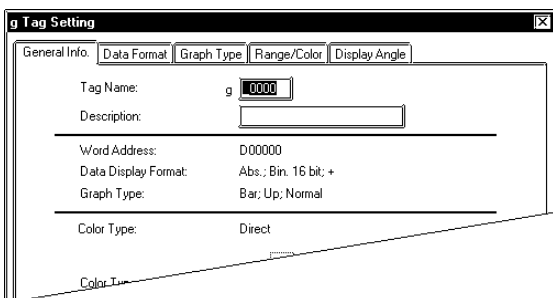

The General Info. page provides information about the current settings for the g-tag.

Tag Name

Must be no more than five Single-byte or two Double-byte characters long and composed of letters and/or symbols.

Description

Up to 20 Single-byte or 10 Double-byte characters can be entered as a description of the tag.

■ Data Format/Absolute

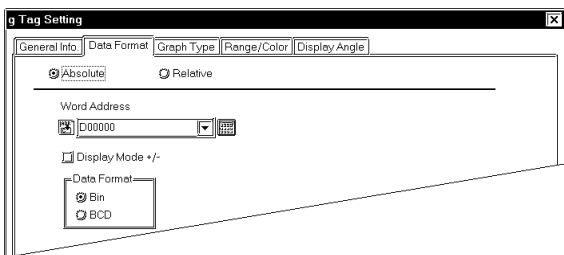

Absolute

Displays the absolute value data. Binary or BCD data format is available.

Word Address

Defines the address containing the display data (16-bit data).

Display Mode +/-

Use this setup to display negative data. Only available for Binary data.

- **Checked** : Displays negative data. (-100 to 100)

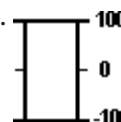

- **Not Checked** : Does not display negative data. (0 to 100)

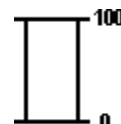

Data Format

Bin

BCD

Defines the type of data stored in the Word Address.

■ Data Format/Relative

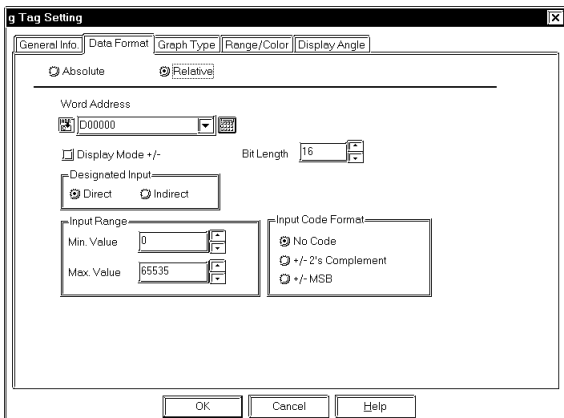

Relative

Data contained in the Word Address is converted according to the Input Range settings before being displayed.

Word Address

Defines the word address containing the display data (16-bit data).

Display Mode +/-

Use this setup to display negative data.

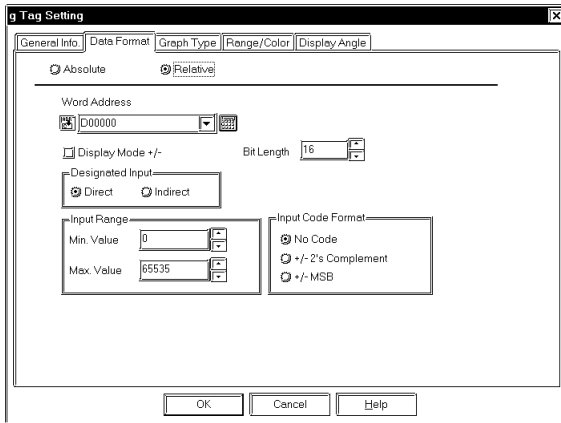

Bit Length

Defines the bit length of the data stored in the Word Address.

Designated Input

Direct

Directly specifies Word Address's range, via the Input Range field.

Indirect

Indirectly specifies the range of the data stored in the Word Address. The Word Addresses used to store the input range's maximum/minimum values are displayed in the Input Range field. The GP-270, however, does not have this setting.

Word Address

+0	Display Data
+1	Input range – Max.
+2	Input range – Min.

Input Range

Min. Value

Max. Value

Setup the range of the data stored in the Word Address. The setup range limits vary with the Code Input.

Input Code Format

No Code

Displays positive values only.

+/- 2's complement

Uses 2's complement to express negative values.

+/- MSB

Uses MSB code system to express negative values.

<Min./Max. Input Range Values>

Input Code Format	Input Range
No Code	0 - 65535
2's Complement	-32768 - 32767
+/- MSB	-32767 - 32767

■ Graph Type/Bar Graph

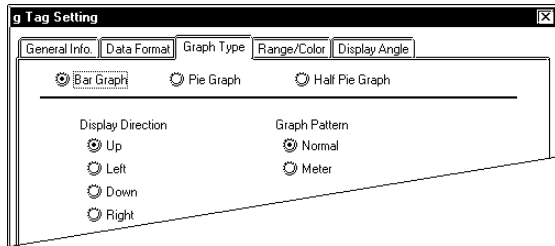

Bar Graph

Select this option to display a bar graph.

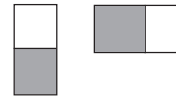

Display Direction

Defines whether the graph points Up, Down, Left, or Right.

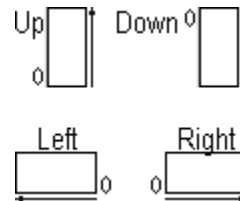

Graph Pattern

Normal

Meter

When Meter is selected, the needle uses the foreground color, and the meter face uses the background color.

Treat these settings as the normal color attributes when using the Alarm.

■ Graph Type/Pie Graph

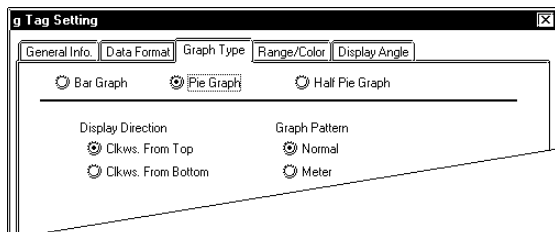

Pie Graph

Select this option to display a pie graph.



Display Direction

Clkws. From Top

Clkws. From Bottom

Defines the direction of the data display.



Clkws. From Top

Clkws. From Bottom

Graph Pattern

Normal

Meter

When Meter is selected, the needle uses the foreground color, and the meter face uses the background color.

■ **Graph Type/Half Pie Graph**

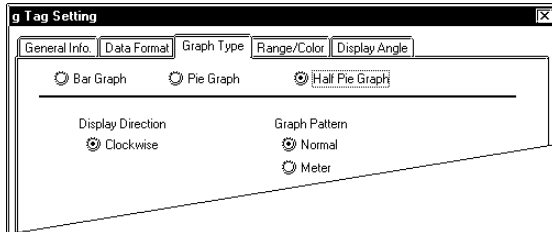

Half Pie Graph

Select this option to display a half-pie graph.



Display Direction

Clockwise

The direction is fixed to clockwise.



Graph Pattern

Normal

Meter

When Meter is selected, the needle uses the foreground color, and the meter face uses the background color.



When drawing a rectangular frame for the bar graph, be sure to draw the frame so that it is 1 dot outside the graph display area. If the graph and frame overlap, the frame will disappear. However, it is unnecessary to draw a frame for the Pie or Half-Pie graph.



When setting up the Bar graph's display position, two opposite points need to be setup in the same manner as when drawing a rectangle. When setting up the Pie or Half-pie, first, designate the center point, then the radius of the outer and inner circles. The radius of the inner circle must be at least 20 dots. To omit the inner circle, after setting the external circle, move the cursor to the center until the internal circle disappears, and left-click.

■ Range/Color

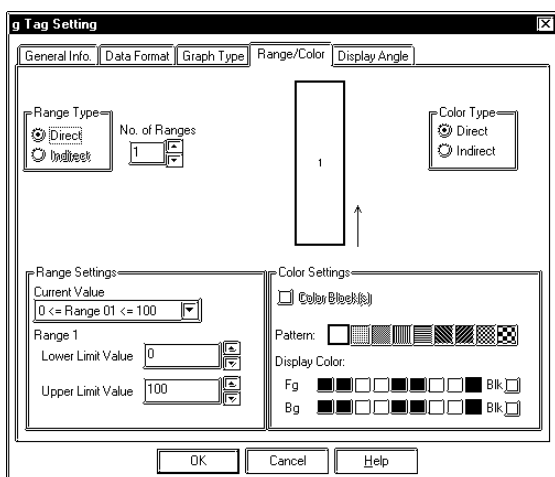

Range Type

Direct

Select this option to directly designate the data range.

Indirect

This option is enabled when the “No. of Ranges” setting is set to 2 or more. If this option is selected, the data range will be variable. The address will be automatically allocated to the word addresses immediately following the Word Address designated in the [Data Format] “Word Address” area.

No. of Ranges

Defines the number of ranges from 2 to 16. Then, you need to set the upper and lower limits and the colors for each range.

Color Type

Direct

The Color Settings are specified directly.

Indirect

This option is valid when No. of Ranges is “1”. The Color Settings can be specified indirectly. The color attributes are specified for the Address displayed in the Color Settings field. The GP-270, however, does not have this setting.

▼Reference▲ “2.10.4 Object Drawing Data”, H-tag

Range Settings

Current Value

The range currently selected in the sample graph will appear here.

Lower Limit Value

Upper Limit Value

After selecting a range number in the sample graph, designate the upper and lower limits for that range here.

Color Settings

<Eg.> When Range Designation is “Indirect”, and No. of Ranges is “3”:

Designated Word Address

	Display Data
+1	Range 2 Lower limit data
+2	Range 3 Lower limit data

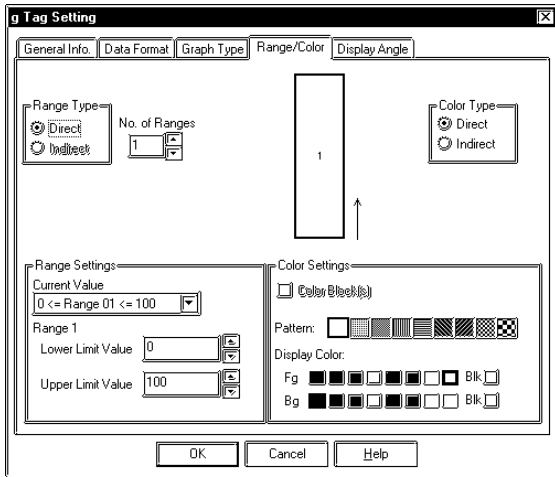

<Eg.>

When the Input Designation is “Indirect”, the Range Designation is specified to “Indirect”, and No. of Ranges is “3”.

Designated Word Address

	Display Data
+1	Range 2 Lower limit data
+2	Range 3 Lower limit data
+3	Input range – Max.
+4	Input range – Min.

Color Block(s)

This setting is valid when No. of Ranges is “2” or more. When this number is “2” and the data value exceeds the one specified for Range 1, with the Color Block function selected, Range 1 and Range 2 will be displayed in the previously specified colors. When the Color Block function is not selected, the color will be changed to the one specified for Range 2. The GP-270, however, does not have this setting.

<Eg.>

When Color Block is selected:



When Color Block is not selected:

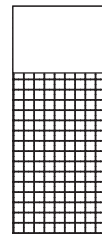

Pattern

Select the fill pattern for the graph.

Display Color

After selecting a range number in the sample graph, set the display color for that range here.

Reference “2.1.5 Color Settings”, A-tag

■ Display Angle

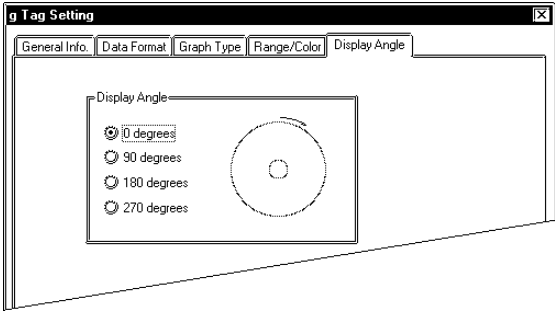

Display Angle

Setup the data's display rotation angle, for a Pie or Half-pie graph. Select 0(zero), 90, 180, or 270 degrees.

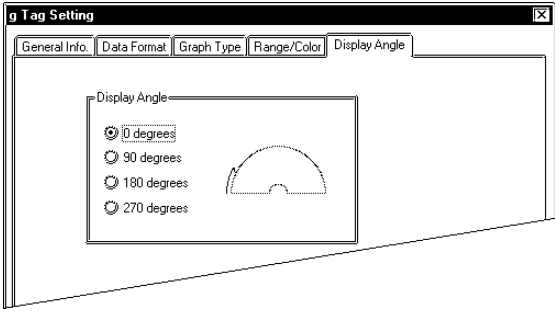



2.10 H-tag (Moving Mark Display) *1

2.10.1 Overview

Straight lines, rectangles, circles, and dots can be drawn at desired coordinates using the host Word Address data.

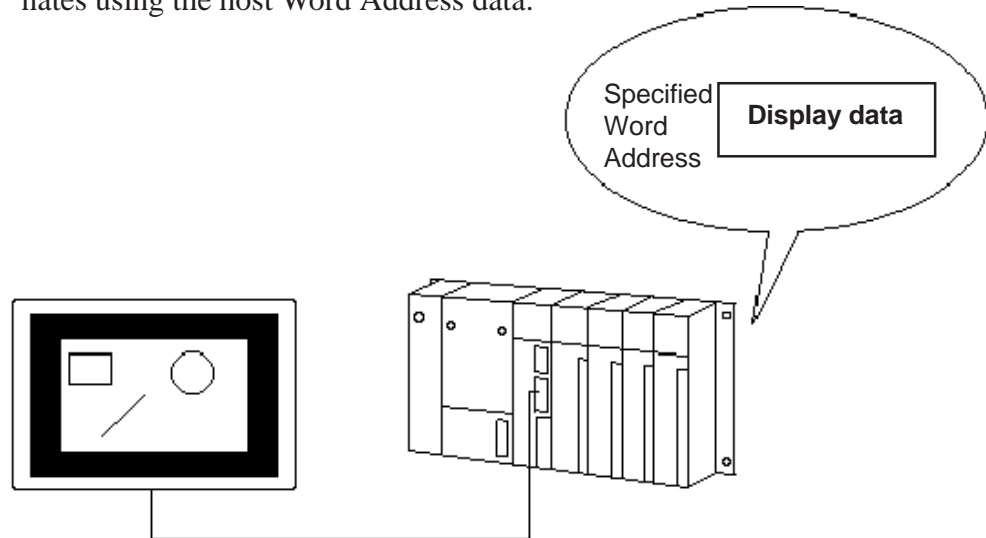

2.10.2 About H-tag

- Straight lines, rectangles, circles, and dots can be drawn.
- For straight lines, the display attributes such as line type and arrows can be specified.
- Drawn objects' color attributes can be specified.
- Desired coordinates can be specified in the X and Y directions.
- Objects drawn when the display trigger bit address is specified to "OFF"→ "ON". The drawn objects will overwrite the currently displayed objects.
- To delete objects, call up the delete screen by specifying the delete trigger bit address to "ON"→ "OFF".

*1 The GP-270 does not support this function.

2.10.3 Using H-tags *1

■ General Info.

H Tag Setting

General Info. | Address Settings

Tag Name: H

Description:

Trigger Bit Address: X00000
 Read Out After Trigger: On
 Erase Trigger Bit Address: X00000
 Erase Screen No.: B 1
 Data Storage Start Address: D00000
 Read Out Data Size: 6 Word

OK Cancel Help

The General Info. page provides information about the current settings for the J-tag.

Tag Name

Must be no more than five Single-byte or two Double-byte characters long and composed of letters and/or symbols.

Description

Up to 20 Single-byte or 10 Double-byte characters can be entered as a description of the tag.

■ Address Settings

H Tag Setting

General Info. | Address Settings

Trigger Bit Address:

Read Out After Trigger

Erase Trigger Bit Address:

Erase Screen No.:

Data Storage Start Address:

Read Out Data Size:

OK Cancel Help

Trigger Bit Address

Enter the trigger bit to draw objects. When this trigger bit is turned ON, the GP begins to draw an object. After the GP completes drawing the object, the GP turns OFF the trigger bit. Preserve the object drawing data while the host's trigger bit is ON.

Read Out After Trigger *2

When this check box is checked, object drawing data will be read out after the trigger bit changes. When the object drawing data is a large volume or when many H-tags have been set in one screen, check this check box for each H-tag, to increase other tag display speeds.

Erase Trigger Bit Address

Enter the trigger bit to delete a drawn object. When the erase trigger bit is turned ON, the GP overwrites the current screen with an erase screen. After the erase screen display is completed, the GP turns OFF the erase trigger bit.

*1 The GP-270 does not support this function.

*2 This feature cannot be used with some PLCs. For a complete list of these PLC's refer to **Reference** "1.3 Tag List"

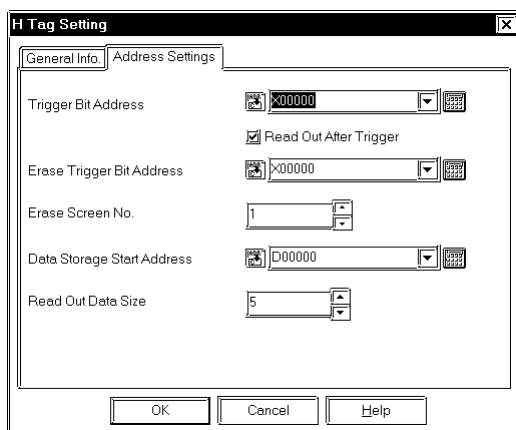

Erase Screen No.

A screen number (Base screen) to erase a drawn object is specified. This screen needs to be prepared beforehand.

Data Storage Start Address

The first Word Address to store the object drawing data is specified.

Read Out Data Size

The number of the words for the object drawing data is specified.



Note: Bin data can only be stored for object drawing data. BCD data cannot be used.

2.10.4 Object Drawing Data ^{*1}

This section explains the details about object drawing data, starting from the Operation Mode's Data Start Address.

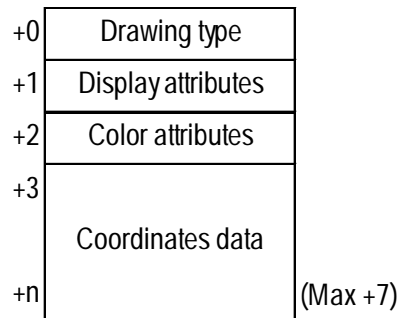

◆ Drawing type (+0)

Straight lines, rectangles, circles, and dots are drawn via the data stored here.

1: Straight line, 2: Rectangles, 3: Circle, 5: Dot

◆ Display attributes (+1)

Each drawing type's display attributes can be specified via the data stored here. The display attributes will vary depending on each drawing type, such as line type, fill pattern, etc. When drawing dots, this data will be ignored.

• Straight line

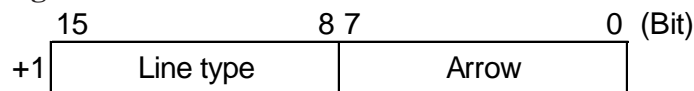

Line type

00: ——— (Solid line), 01: - - - - - (Dotted line),

02: - - — (One dotted broken line), 03: - - - — (Two dotted broken line),

04: ——— (Thick, solid line), 05: - - - - - (Thick dotted line),

06: - - — (Thick, one dash broken line),

07: - - - — (Thick two dash broken line),

08: ——— (3-dot thick solid line), 09: ——— (5-dot thick solid line)

Arrow

00: None 01: At line end 02: Both ends

<E.g.>

When drawing a 3-dot thick solid line without arrows:

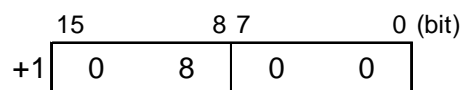

^{*1} The GP-270 does not support this function.

• **Rectangular**

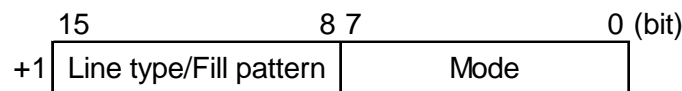

Line type

- 0: (Solid line), 1: (Dotted line),
- 2: (One dotted broken line), 3: (Two dotted broken line),
- 8: (3-dot thick solid line), 9: (5-dot thick solid line)

Fill pattern

- 0: , 1: , 2: , 3: , 4: ,
- 5: , 6: , 7: , 8:

Mode

- 00: Line drawing 01: Fill

• **Circle**

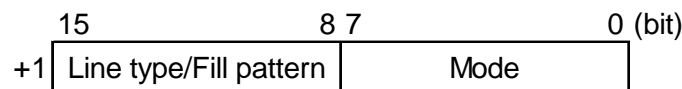

Line type

- 0: (Solid line), 1: (Dotted line),
- 2: (One dotted broken line), 3: (Two dotted broken line),
- 8: (3-dot thick solid line), 9: (5-dot thick solid line)

Fill pattern

- 0: , 1: , 2: , 3: , 4: ,
- 5: , 6: , 7: , 8:

Mode

- 00: Line drawing 01: Fill

*1 The GP-270 does not support this function.

◆ **Color attributes (+2)**

The foreground and background color attributes can be specified via the data stored here.

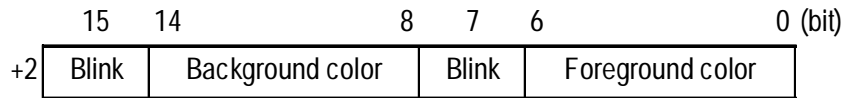

Color code (Commonly used for both foreground and background colors)

00h: Black 01h: Blue 02h: Green 03h: Light blue 04h: Red
05h: Purple 06h: Yellow 07h: White

80h: Black blinking 81h: Blue blinking 82h: Green blinking 83h: Light blue blinking
84h: Red blinking 85h: Purple blinking 86h: Yellow blinking 87h: White blinking

When using the 64 color display GP

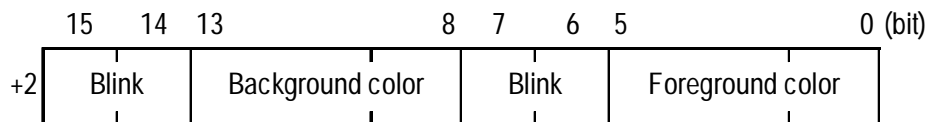

<GP-571>

7 (15) bits	6 (14) bits	Blink Status
0	0	OFF
1	0	ON

<Any model compatible with 3 Blink features (i.e. GP-675 etc.)>

7 (15) bits	6 (14) bits	Blink Status
0	0	OFF
0	1	ON (blinks two times faster than standard)
1	0	ON (standard)
1	1	ON (blinks at half speed of standard)

When using the 256 color display GP

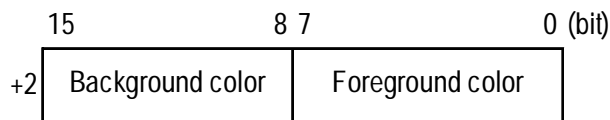

Note: For more detail about color codes,

Reference “2.14.10 Overlapping Colors on a Color GP”, L-tag

*1 The GP-270 does not support this function.

◆ **Coordinates data (+3)**

The display coordinates for each drawing type can be specified via the data stored here.

• **Straight line**

+3	X starting coordinate
+4	Y starting coordinate
+5	X end coordinate
+6	Y end coordinate

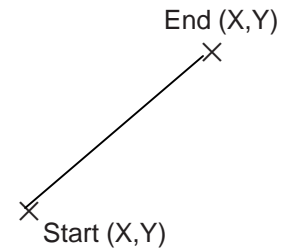

• **Rectangles**

+3	X starting coordinate
+4	Y starting coordinate
+5	X end coordinate
+6	Y end coordinate

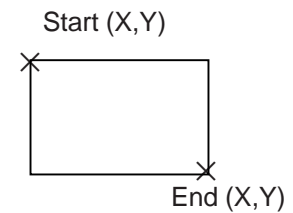

• **Circle**

+3	X center coordinate
+4	Y center coordinate
+5	Radius

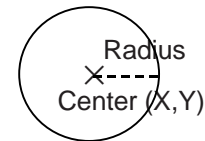

Radius: "0" cannot be used.

• **Dot**

+3	X center coordinate
+4	Y center coordinate



*1 The GP-270 does not support this function.



While drawing an object, the GP is monitoring the trigger bit address activation. When drawing objects continuously, take the time of the tag scanning time or communication cycle time or more for the bit OFF time.



DO NOT specify incorrect object drawing data.



- **If screens are switched during the time from the trigger bit address is turned ON to completion of object drawing or deleting, the trigger bit address will not be turned OFF.**
- **The origin point of the coordinates is the left top point of the screen. When drawing an object on the window, the registered window's left top point is the origin point.**

◆ **Object Drawing Example**

When drawing a straight line with an arrow at the end, the line type of Solid line, in white:

Trigger bit address: M00000

Start Address: D00100

Data Size: 7

1) Drawing data set

Trigger bit address

M00000 OFF

Drawing



Data storage address

D00100	0 0 0 1 (h)
D00101	0 0 0 1 (h)
D00102	0 0 0 7 (h)
D00103	0 0 3 2 (h)
D00104	0 0 6 4 (h)
D00105	0 0 6 4 (h)
D00106	0 0 3 2 (h)

2) Trigger bit ON

Trigger bit address

M00000 ON

Drawing

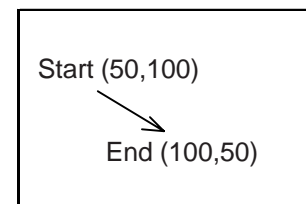

Data storage address

D00100	0 0 0 1 (h)
D00101	0 0 0 1 (h)
D00102	0 0 0 7 (h)
D00103	0 0 3 2 (h)
D00104	0 0 6 4 (h)
D00105	0 0 6 4 (h)
D00106	0 0 3 2 (h)

*1 The GP-270 does not support this function.

2.11 J-tag (Moving Mark Display)

2.11.1 Overview

The J-tag displays the Mark created in pixel units and registered in a Mark screen, on the rail positions (setup using R-tags). In conjunction with R-tags (Rails), the J-tag displays a moving Mark. This will be useful to indicate the object movement in a production line system and can be used for display of PV graph levels.

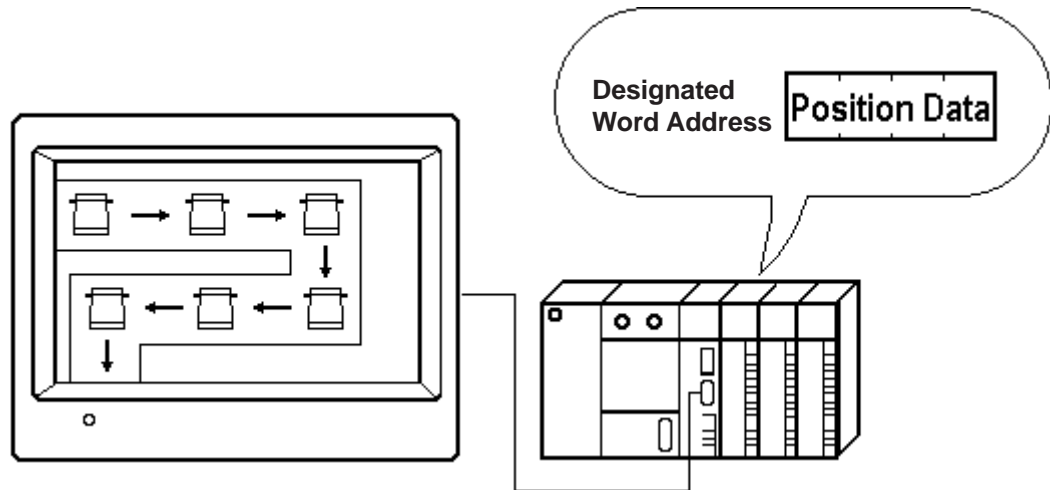

The positions for moving the Mark image are set on an R-tag. The position data refers to the position numbers designated in the R-tag.

2.11.2 About J-tags

- Absolute and Relative data formats are available in the position data setup process.
- When using Absolute data, the movement position data format can be set up as Bin 16 bit or BCD 16 bit. When using a Relative data setup, data becomes Binary format, so to manage negative data select either 2's complement format or MSB code format.
- Displays the Mark screen file number, whose Mark is accessed directly or indirectly.
- When Mark Access is Direct, the Mark screen file number is fixed.
- When Mark Access is Indirect, the Mark screen file number is variable.

- An Alarm setup is possible for the Mark when the data (movement position number) is outside the maximum or minimum values setup.
- An Offset of the screen file number is also possible.



When a Mark's display area (40x24 or 48x48 dots), designated using J-tags, overlaps another tag display area, the display will not appear correctly.

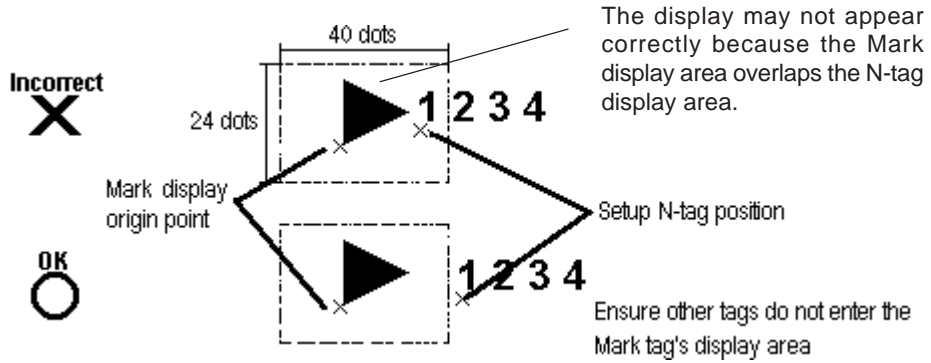

- **Overlapping the Mark's rail position with other tags causes an incorrect display.**

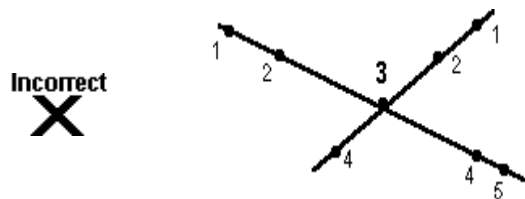

- When using a single J-tag, a Mark cannot display in more than one position at one time.
- A Mark will not display when the position data is zero.

2.11.3 Using J-tags

■ General Info.

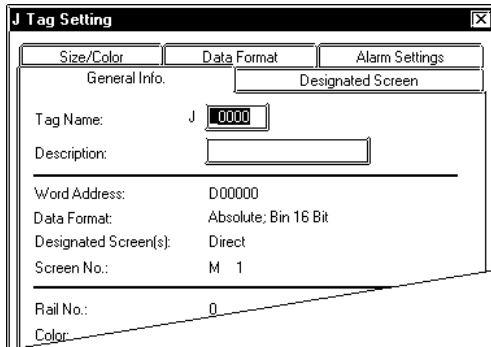

The General Info. page provides information about the current settings for the J-tag.

Tag Name

Must be no more than five Single-byte or two Double-byte characters long and composed of letters and/or symbols.

Description

Up to 20 Single-byte or 10 Double-byte characters can be entered as a description of the tag.

■ Designated Screen/Direct

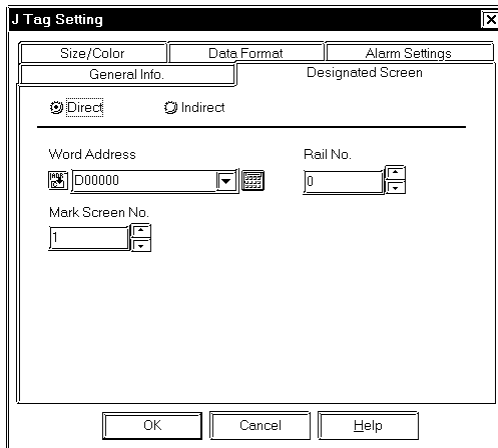

Direct

Designate the Mark Screen No. to be displayed. The number designated in the Mark Screen No. area becomes this setting attribute.

Word Address

Designate the word address containing the movement position number.

Mark Screen No.

Designate the screen file number of the Mark to be displayed.

Rail No.

The Mark display positions are designated on the rail designated here. Must match the rail number set for an R-tag.

■ Designated Screen/Indirect

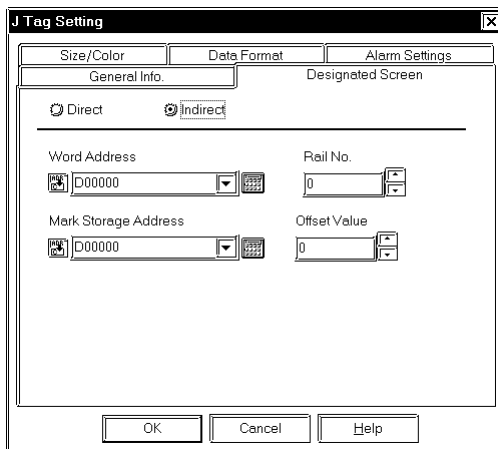

Indirect

With this option selected, the Mark Screen No. becomes variable. The Mark Screen No. should be stored in the designated Mark Storage Address.

Word Address

Designate the Word Address where the Mark movement position number is stored.

Mark Storage Address

Designate the Word Address where the Mark Screen No. is stored.

Rail No.

The Mark display positions are designated on the rail designated here. Must match the rail number set for an R-tag.

Offset Value

Defines an offset value to be added to the Mark Word Address data. When not using the Offset, enter a value of zero.

Reference “2.14.7 Offset Settings”,
L-tag



Note: When the Mark Access is set to Indirect, the Mark of the screen file number corresponding to the data in the Mark Word Address is displayed. Using this method, different Marks can be displayed on a single rail; however, different Marks cannot appear in the same position at the same time.

■ **Size/Color**

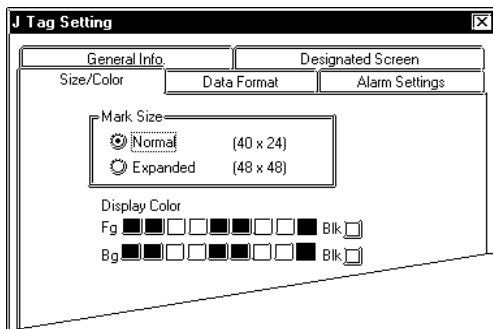

Mark Size

Select one from the two options: Normal (40 × 24 dots) and Extended (48 × 48 dots) according to the size of the Mark to be displayed.

Normal (40 × 24)

Select this option when using a Mark created within the thick lined area in the diagrams below, or when using a Mark created previous to GP-PRO/PBIII panel editor program (GP-PRO II).

Expanded (48 × 48)

Select this option when using a Mark that exceeds the thick lined area in the diagrams below.

Vertical mark

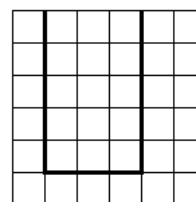

Horizontal mark

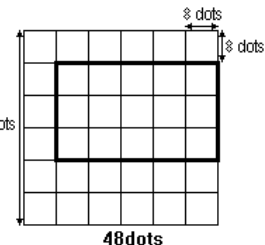

Mark screen

When Mark Access is Indirect, and multiple Marks are being used, the Extended option must be used even if there is only one Mark that exceeds the thick lined area.

Display Color

Set up the foreground (Fg) and background (Bg) colors, and the blink (Blk) option.

Reference “2.1.5 Color Settings”,
A-tag

■ Data Format/Absolute

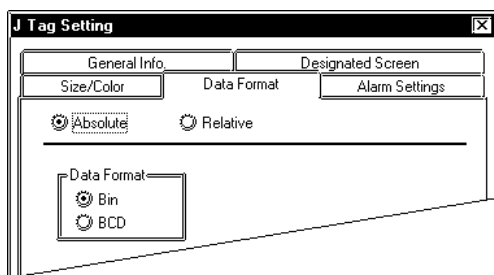

Absolute

The stored data is the actual number that identifies the R-tag display position.

Data Format

Bin

BCD

Defines the format of the data in the word address.

■ Data Format/Relative

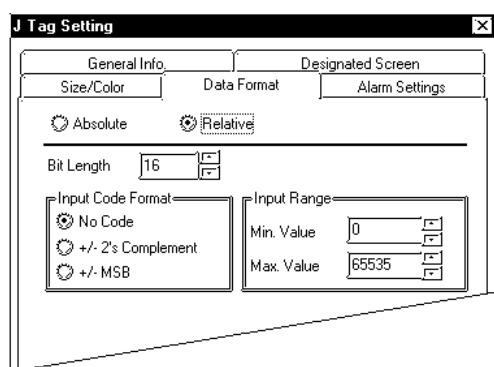

Relative

The host (PLC) data is compared with the setup range and converted accordingly to identify the display position. The data is treated in binary format.

Bit Length

Defines the valid bit length of data stored in the Word Address.

Input Code Format

No Code

Displays positive values only.

+/- 2's Complement

Uses 2's complement to express negative values.

+/- MSB

Uses MSB code system to express negative values.

Input Range

Min. Value

Max. Value

Set up the range of the data stored in the Word Address. The setup range limits vary with the Code Input. The GP will display percentage converted based on the range designated here. The possible values depend on the Code Input setting.

<Min./Max. Input Range Values>

Input Code Format	Input Range
No Code	0 - 65535
2's Complement	-32768 - 32767
+/- MSB	-32767 - 32767

■ Alarm Settings

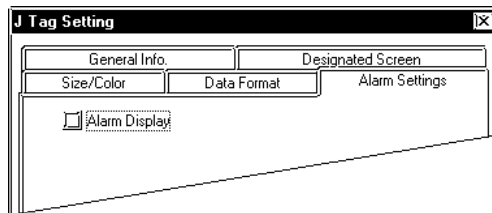

Alarm Display

Select this option when desiring an alarm display.

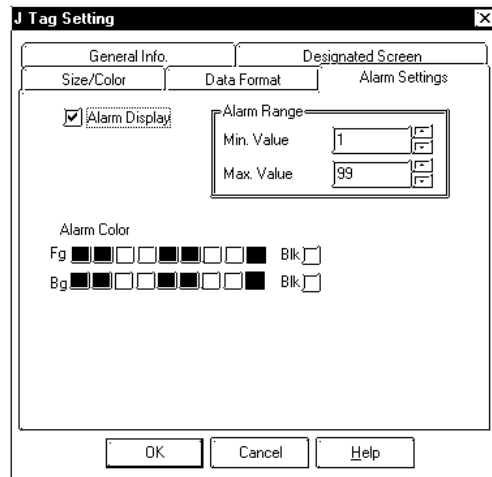

Alarm Range

Min. Value

Max. Value

When data (movement position number) read from the host (PLC) falls outside the range set here, the Mark changes to the alarm display.

Alarm Color

The alarm display colors can be different from the normal display colors.

2.12 K-tag (Key Input)

2.12.1 Overview

K-tags display numeric or character string data, input into the designated word address using touch keypads (created with k-tags) or a bar code reader.

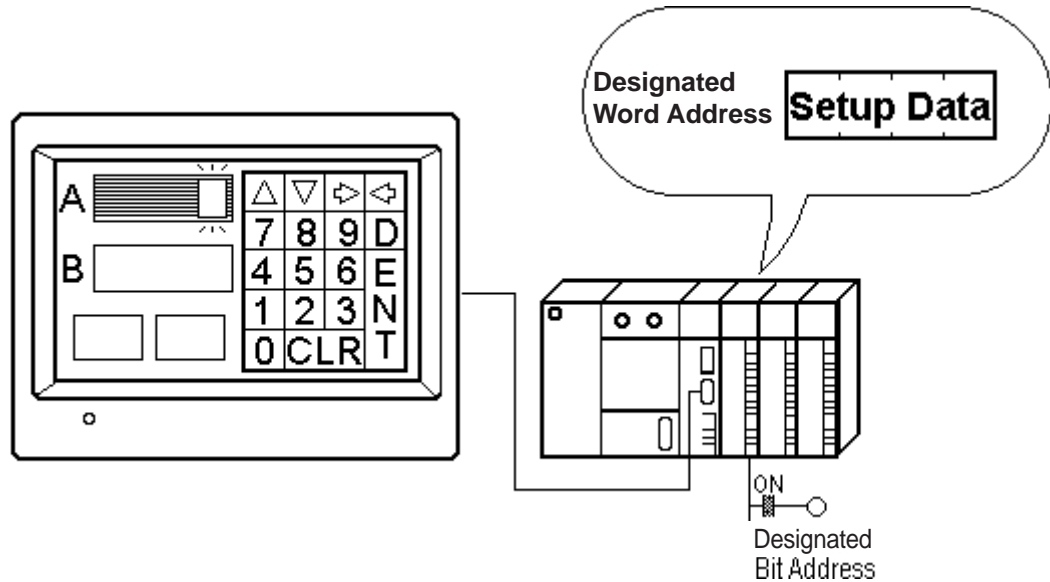

2.12.2 About K-tags

- Designate the trigger bit and the data storage address. The trigger bit is a bit which triggers the display's input operation, and the data storage address stores the set data.
- When the trigger bit value is 1, the data storage address waits for input.
- Numeric data (Bin/BCD/Float) and both Single-byte and Double-byte character strings can be entered.
- Absolute and Relative data formats are available for numeric data. Binary, BCD, and Float data formats can be designated for Absolute data, however only Binary data can be used with the Relative format.

- The same trigger bit address can be designated for multiple K-tags. When using a common trigger bit, K-tags are activated automatically in the order of their Tag Names.

E.g.

Tag names K1, K2, K3, K10: will await input in the order:
K1, K10, K2, K3.

and Tag names K01, K02, K03, K10: will await input in the order:
K01, K02, K03, K10.

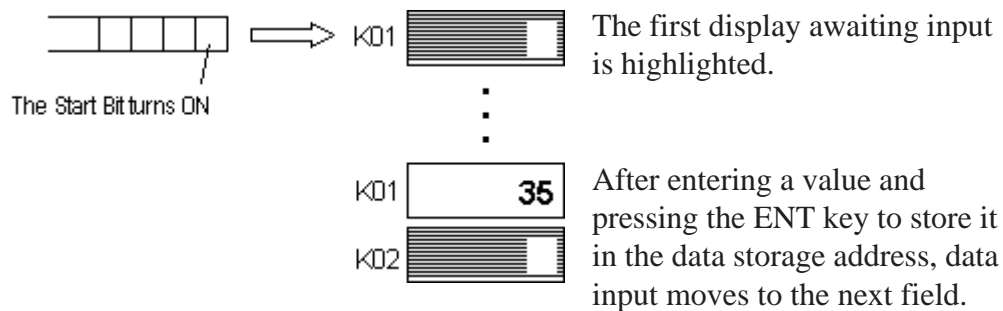

- When using Relative data, the data written to the host (PLC) is converted automatically based on the Input Range settings.

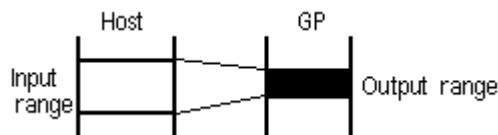

A data calculation program in the host (PLC) can be omitted.

- With Absolute data, negative values are computed using 2's complement. With Relative data, select a method: either 2's complement or MSB code.
- The decimal point is not included in the Display Digit.
- An alarm function is available by designating the upper and lower limits.
- For Relative values, data that falls outside the valid range can be used as the alarm values.



Note:

Only data within the valid range can be written to the host (PLC). Using data outside the valid range causes the GP to beep three times.

- data successfully written: one beep
- data not written: three beeps

- When the [ENT] key is pressed, Status's "03 bit" in the system area will be reversed.

Reference *Device/PLC Connection Manual, 1.1.4 Contents and Range of System Data Area*

- Alarm may be set with variable values when the alarm uses the Indirect setup. In this setup, the upper and lower limits are stored in the consecutive word addresses directly following the designated data storage Word Address.

- E.g.
- 32 bit data
 - Designated storage address for the display data = n

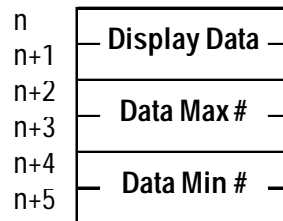

- Using the Bar Code reader ^{*1} connected to the GP, data can be read then written to the data storage address setup. Or, you can create K-tags exclusively for touch keypad input, prohibiting data input from barcode reader.

When inputting data using the barcode reader input...

- Data read using the barcode reader is written automatically to the data storage address. It is unnecessary to use the ENT key on the touch keyboard.
- If you enter a change screen command during barcode input, because the screen change priority is higher, the data being input will be ignored, so please use with caution.
- Ending data write causes the System Area's Status 03 bit to reverse. Using this, you can figure out the data write timing.

- The results of data input operations carried out can be written, except operations that use the Float data format.
- When displaying a character-string, the maximum number of characters that can appear in the display is eighty.
- Setups for the character size and display color attributes are available.
- Shift-right/shift-left and zero-suppress setups are available for the display style.
- When host data contain zeros, set display to zero suppress.



- **The upper and lower limits of the alarm range can be displayed on the screen using the n-tag.**

▼ **Reference** ▲ 2.18 *n-tag (Alarm Range Display)*

- **For details about the touch keyboard**

▼ **Reference** ▲ 2.13 *k-tag (Keyboard Setup)*

- **For more about the relationship of high and low order word address data when the 32-bit data is used**

▼ **Reference** ▲ *Device/PLC Connection Manual, "Supported Devices"*

- The word address to store the display data can be indirectly designated. The device of the source word address can be the same or different from that of the destination address for the indirect designation.

▼ **Reference** ▲ 2.6.4 *Indirect Word Addressing Examples, E-tag*

*1 Usable barcode readers are restricted to those recommended in your User's Manual.

2.12.3 Using K-tags

■ General Info.

K Tag Setting

Alarm Settings | Arithmetic Operation | Display Angle

General Info. | Data Format | Size/Style

Tag Name: K 0000

Description: _____

Trigger Bit Address: X00000

Word Address: D00000

Base Address: ...

Data Format: _____

The General Info. page provides information about the current settings for the K-tag.

Tag Name

Must be no more than five Single-byte or two Double-byte characters long and composed of letters and/or symbols. Specifying the same Trigger Bit Address for two or more tags automatically enables the inputs in the order of the character code of the tag names.

Do not duplicate tag names.

Description

Up to 20 Single-byte or 10 Double-byte characters can be entered as a description of the tag.

■ Data Format/Absolute

K Tag Setting

Alarm Settings | Arithmetic Operation | Display Angle

General Info. | Data Format | Size/Style

Absolute Relative Char. String

Word Address: D00000 | Trigger Bit Address: X00000

Indirect | Base Address: D00000

Addressed

Device Type & Address Bin BCD

Code +/-

Round Up

Display & Write Data Format:

16 Bit | 32 Bit

Decimal Hex

Hex BCD

BCD Bin

Octal Float

Bin Float

OK | Cancel | Help

Absolute

If this option is selected, 16- or 32-bit data can be used.

Word Address

Defines the data storage word address.

Trigger Bit Address

Defines the address of the bit that enables touch key input.

Indirect

If this option is selected, the word address containing display data is indirectly designated.

Reference “2.6.4 Indirect Word Addressing Examples”, *E-tag*

Address

The indirectly-designated address is within the same device as the Word Address designated above.

Device Type & Address

Both a device type and an address are indirectly designated using device and address codes. Write the device code in the word address designated in the Word Address attribute, and the address code in the next word address.

Reference *Device/PLC Connection Manual*

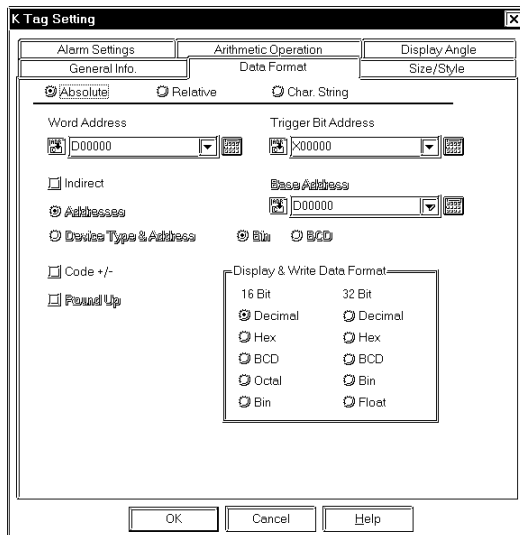

Base Address

Defines the base address. The K-tag displays the address designated by adding the base address number to the data in the designated Word Address.

Bin

BCD

The K-tag uses the data format designated here to display the data in the related Word Address. When the Device Type & Address option is selected, the data format is fixed to Bin.

Code +/-

Available only when using the Decimal numeric format. Select the Code +/- option when you wish to display negative data.

Round Up

This option is valid only when the display data format is set to Float. Here, at the number of display digits designated, values will be rounded up if the number of the last digit is 5 or above, and rounded down if the number of the last digit is anything under 5. However, when this option is not selected, the decimal point numbers will be always rounded down from the designated digit.

E.g. Number of Decimal point digits = 2
Value: 1.9999.....

When this option is selected: Rounded up to 2.00

When this option is not selected: Rounded off to 1.99

Data Display and Write Format

Set the data format to Decimal, BCD, Hex, Octal, Binary, or Float. In the case of Octal numbers, use only 16 bit data, and in the case of Float numbers, use only 32 bit data (IEEE 754 Format).



If the indirectly-designated address is out of range or does not exist, a communication error may occur, effecting the screen update. Check the indirectly-designated data and write the correct value to the host's (PLC's) addresses to restore the screen update. If an error occurs in writing data, turn the power OFF, then ON to restore the system.



When using 32-bit data, the relationship of high order and low order word data will differ according to the host (PLC) type.

Reference *Device/PLC Connection Manual, "Supported Devices"*

■ Data Format/Relative

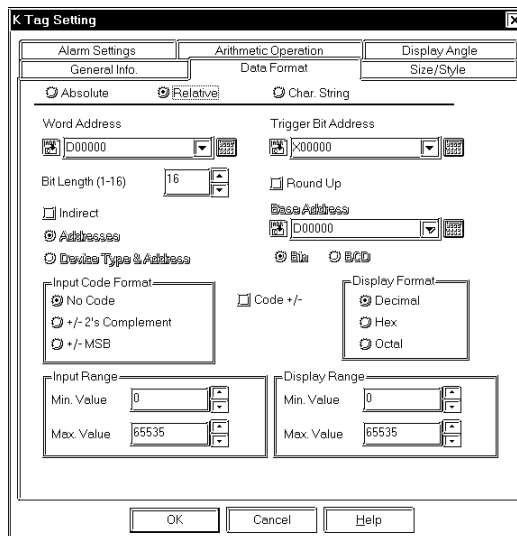

Relative

When this option is selected, the bit length of the data being read can be designated in the range of 1 to 16.

Word Address

Defines the data storage word address.

Trigger Bit Address

Defines the address of the bit that enables touch key input.

Bit Length (1-16)

Set up the valid bit length of the data stored in the Word Address.

Round Up

The decimal point numbers created during relative value range conversion will be rounded up or off. When this option is not selected, those numbers will be rounded off.

Indirect

If this option is selected, the data storage word addresses are indirectly designated.

Address

The indirectly-designated address is within the same device as the Word Address designated previously.

Device Type & Address

Both a device type and an address are indirectly designated using device and address codes. Write the device code in the word address designated in the Word Address, and the address code in the next word address.

Reference *Device/PLC Connection Manual*

Base Address

Defines the base address. The K-tag displays the address designated by adding the base address number to the data in the Word Address.

Bin

BCD

The K-tag uses the data format designated here to display the data in the related word address. When the Device Type & Address option is selected, the data format is fixed to Bin.

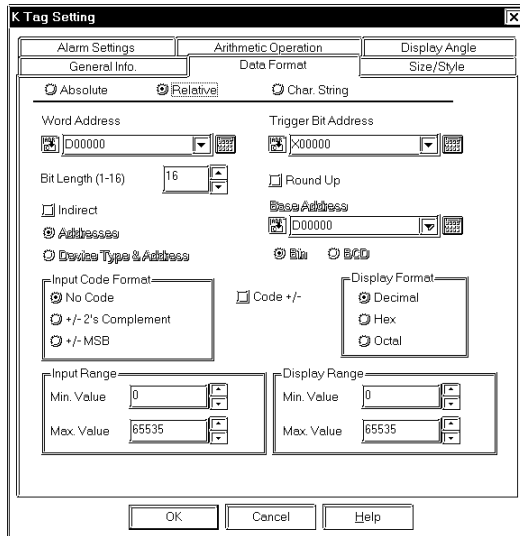

Input Code Format

No Code

Displays positive values only.

+/- 2's complement

Uses 2's complement to express negative values.

+/- MSB

Uses MSB code system to express negative values.

Code +/-

Select the Code +/- option when handling negative values. Only available when setting Decimal data.

Display Format

Decimal

Hex

Octal

Select a numeric format from Decimal, Hex, and Octal.

Input Range

Min. Value

Max. Value

Set up the min/max limits for data in the storage word address. The possible setup limits change with different Code Inputs.

Display Range

Min. Value

Max. Value

Set up the limits for data conversion. The possible setup limits vary according to the data's numeric format and the Code +/- setting.



Note:

- For details about the Relative value input:
Reference *"2.17.4 Relative Data Display Settings", N-tag*
- For details about indirect designation:
Reference *"2.6.4 Indirect Word Addressing Examples", E-tag*
- Confirm that the Display Range does not exceed the Input Range. Otherwise, a processing error may prevent display of the input data.

<Minimum and Maximum Values of the Ranges>

Data Format		Input Range	Display Range
	Code Input	Code +/-	
Dec	No Code	+/-	0 - 65535
		+	-32768 - 32767
	2's complement	+/-	0 - 65535
		+	-32768 - 32767
	MSB	+/-	-32768 - 32767
		+	-32767 - 32767
Hex	No Code	/	0 - FFFF (h)
	2's complement	/	0 - FFFF (h)
	MSB	/	-32767 - 32767
Oct	No Code	/	0 - 177777 (o)
	2's complement	/	0 - 177777 (o)
	MSB	/	-32767 - 32767

■ Data Format/Char. String

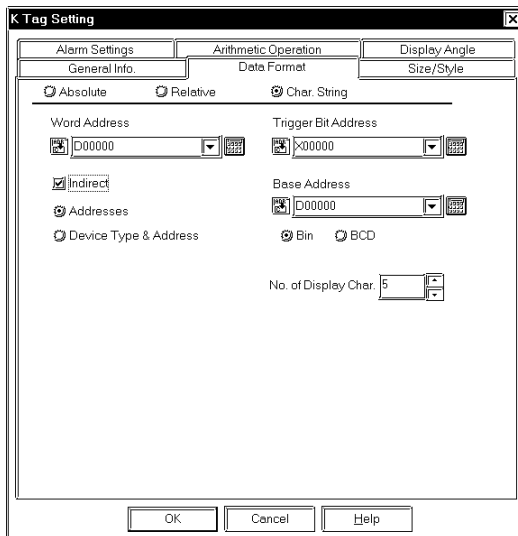

Char. String

Using the touch keys designated with k-tags, ASCII code text input to the host (PLC) is possible. The maximum length of the text to be stored should be designated.

Word Address

Defines the data storage word address.

Trigger Bit Address

Defines the address of the bit that enables touch key input.

Indirect

If this option is selected, the data storage word addresses are indirectly designated.

Addresses

The indirectly-designated address is within the same device as the Word Address designated above.

Device Type & Address

Both a device type and an address are indirectly designated using device and address codes. Write the device code in the word address designated in the Word Address attribute, and the address code in the next word address.

Reference *Device/PLC Connection Manual*

Base Address

Defines the base address. The K-tag displays the address designated by adding the base address number to the data in the Word Address.

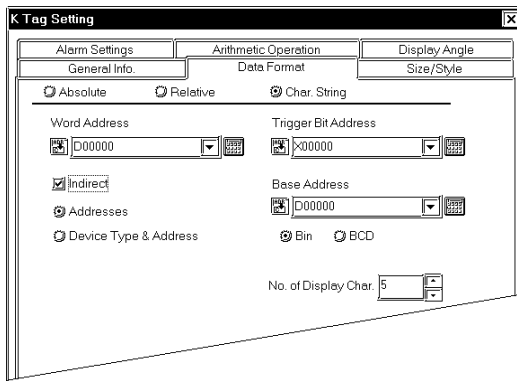

**Bin
BCD**

The K-tag uses the data format designated here to display the data in the related Word Address. When the Device Type & Address option is selected, the data format is fixed to Bin.

No. of Display Character

Set up the number of display places for the character-string. The maximum length is 80.



Note:

- For details about indirect designation: **Reference 2.6.4 Indirect Word Addressing Examples”, E-tag**
- The possible number of display lines and characters is determined by the GP screen size and orientation, and the text size setting.
- If the no. of characters entered is less than the number designated for No.of Display Character, spaces (20H) which will balance the number will be stored.

<When No.of Display Character is 6, and 4 characters are entered>

If the No. of Display Character cannot be divided by 2. (When PLC’s one device is 16-bit length)

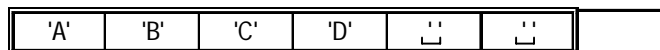

<When No.of Display Character is 5, and 4 characters are entered :when PLC’s one device is 16-bit length>

If the No. of Display Character cannot be divided by 4 (when PLC’s one device is 32-bit length), NULL(00H) will be stored at the end.



Size/Style

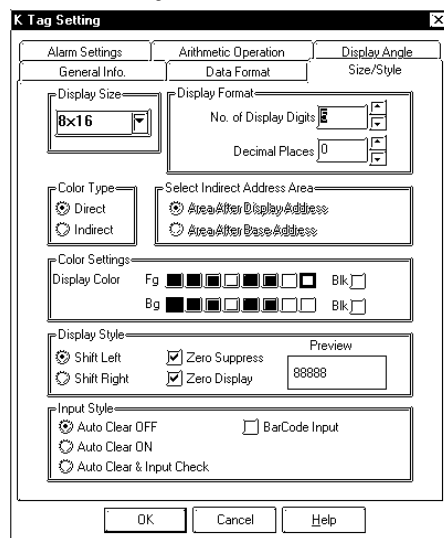

Display Size

The Display Size of characters can be specified here. With the GP2000 series, the scale ratio can be selected from integers 1 through 8. With other models, the scale ratio for the display can be selected from 1, 2, 4, and 8 times. The basic unit of measurement, "1 x 1" times, is a character measuring 16 dots by 16 dots.

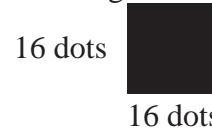

<Double-byte Character>

When using Single-byte numerals or symbols, [6 X 10 dot], [8 X 13 dot] and [13 X 23 dot] extended fonts can be used.

Since extended font sizes are fixed, objects containing these characters cannot be enlarged or reduced while pressing down the [Ctrl] key.

Display Format

No. of Display Digits

Defines the number of digits for the display, usually 1-11. The length set here includes digits after the decimal point, but excludes the decimal point.



Note:

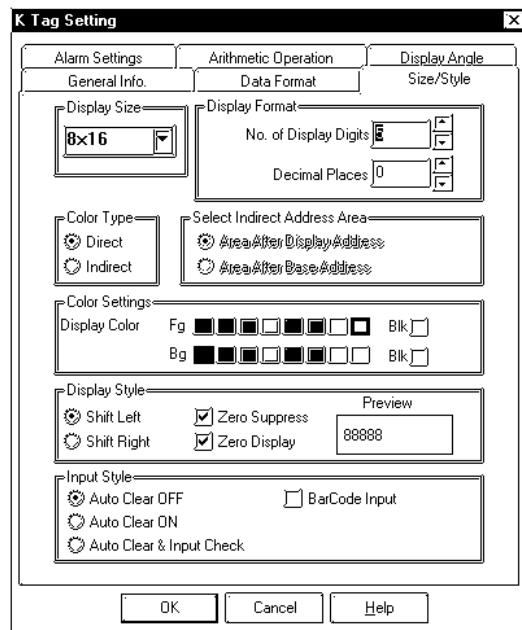

Decimal Places

Defines the number of digits displayed after the decimal point. This setting is valid only for Decimal and BCD formats. The number set here must be less than the value set as the Display Length. The setup range is 0 - 10. Set to zero if not using the fractional digit display.

Color Type

Direct

Directly specifies the Color Settings.

Indirect

This option is valid when the data format is specified to “Absolute” and no alarm has been set. The Color Settings can be indirectly specified. The color attributes are specified in the address displayed in the Color Setting field. However, GP-270 does not have this setting.

Reference “2.10.4 Object Drawing Data/Color Attributes”, H-tag

Color Settings

Display Color

Defines the display color (Fg), background color (Bg), and blink attributes (Blk) of the touch keys. When the alarm color is set, think of the color attributes set here as the normal display. When displaying a numeric value using a K-tag on a filled object, set up the background colors the same for both the object and K-tag.



Note: For details about the color attributes setting

Reference “2.1.5 Color Settings”, A-tag

Display Style

Shift Left

The data appears aligning to the left.

Shift Right

The data appears aligning to the right.

Zero Suppress

Selecting this option eliminates the leading zeros of the displayed data. If not selected, zeros will appear preceding the value to fill the Display Digit (e.g. when the Display Digit is set to 4, data 25 appears as 0025).

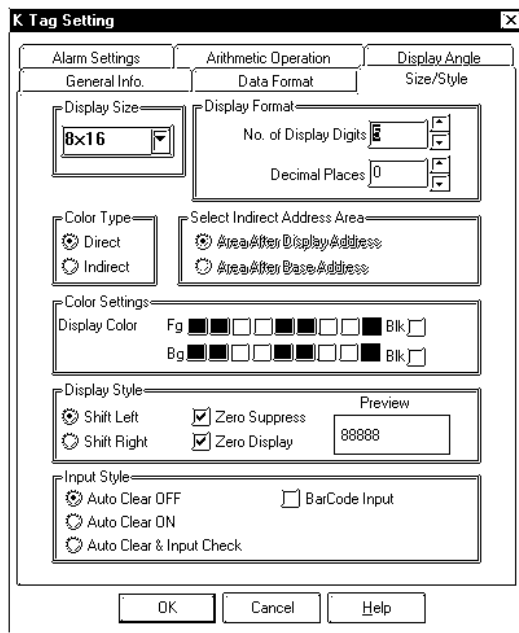

Input Style

Auto Clear OFF

Without clearing the previous value, the setup area displays and waits for you to input the next values. If you want to clear the display, press the [CLR] key on the touch keyboard.

Auto Clear ON

The first character entered (except cursor movement, [ENT], [DEL], and [BS] key entry) clears the previous display.

Auto Clear & Input Check

Performs automatic clearing when barcode reader inputs are used. Also, it checks the validity of the input data length with the Display Digit setup. Data will not be written to the word address if it is not valid. When using touch keyboard input, only Auto Clear takes place.

Bar Code Input

When this option is selected, both the touch keyboard and barcode reader inputs will be acceptable.

■ Alarm Setting

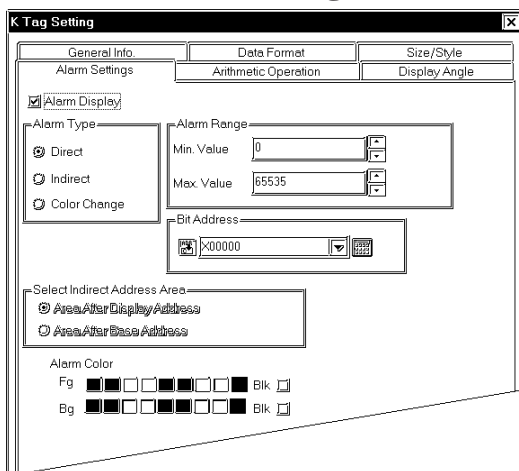

Alarm Display

Set the Alarm ON to use the Alarm display setting.

Alarm Type

Direct

Select this option to directly designate the fixed minimum and maximum values of the alarm range.

Indirect

Select this option to use variables to designate the minimum and maximum values of the alarm range. These limits are indirectly designated in word addresses.

Color Change

When the bit specified in the bit address is turned ON, Alarm will be displayed.

Alarm Range

Min. Value

Max. Value

If the Direct option has been selected, designate the minimum and maximum values of the alarm range. If the Indirect option has been selected, this field indicates

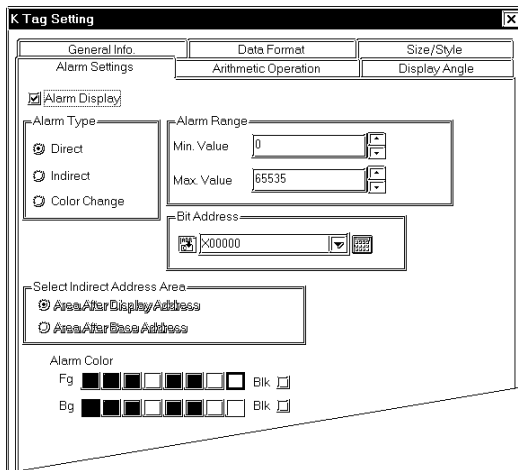

the word addresses which will contain the minimum and maximum values. These addresses will be automatically determined according to the setting of the Word Address designated on the Data Format page. For the Relative value input, the Output Range values designated on the Data Format page will be automatically designated as the minimum and maximum values. The possible values depend on the settings on the Data Format page.

Bit Address

The alarm display bit address to be used when the Alarm Type's Color Change is selected is specified. When the bit specified here is turned ON, the address will be displayed in the set alarm color. In this case, the maximum and minimum values cannot be displayed in the alarm color. Also, the GP-270 does not support this function.

Alarm Type	Alarm Range	Bit Address
Direct	Min./Max. Values	_____
Indirect	Word Address	_____
Color Change	_____	Bit Address

Select Indirect Address Area

Area After Display Address

The addresses storing upper and lower limits will be allocated to the consecutive addresses immediately following the indirectly designated address which contains display data.

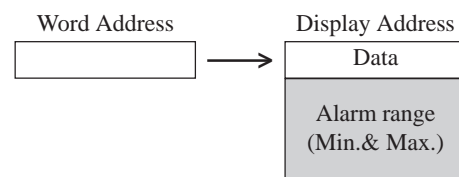

Area After Base Address

The addresses storing upper and lower limits will be allocated to the consecutive addresses immediately following the address designated in the Word Address attribute on the Data Format page. If the Device Type & Address option has been selected on the Data Format page, these addresses

will be allocated to the second and later word addresses from the designated Word Address.

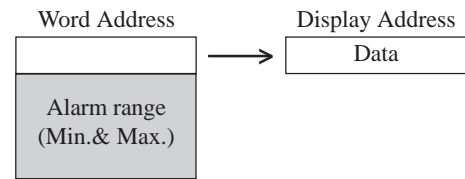

Alarm Color

Set alarm display colors different from the normal display colors.

Eg.1) When selecting the K Tag Indirect [Address]

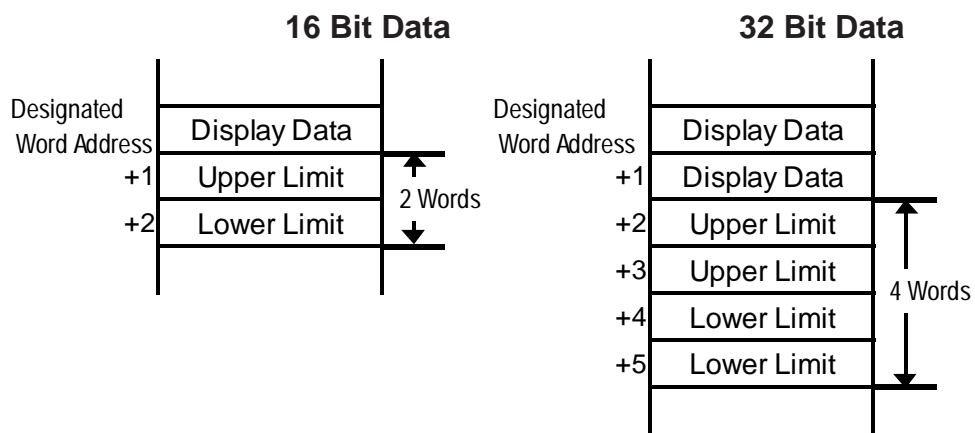

Eg.2) When selecting the K Tag Indirect [Device Type and Address]

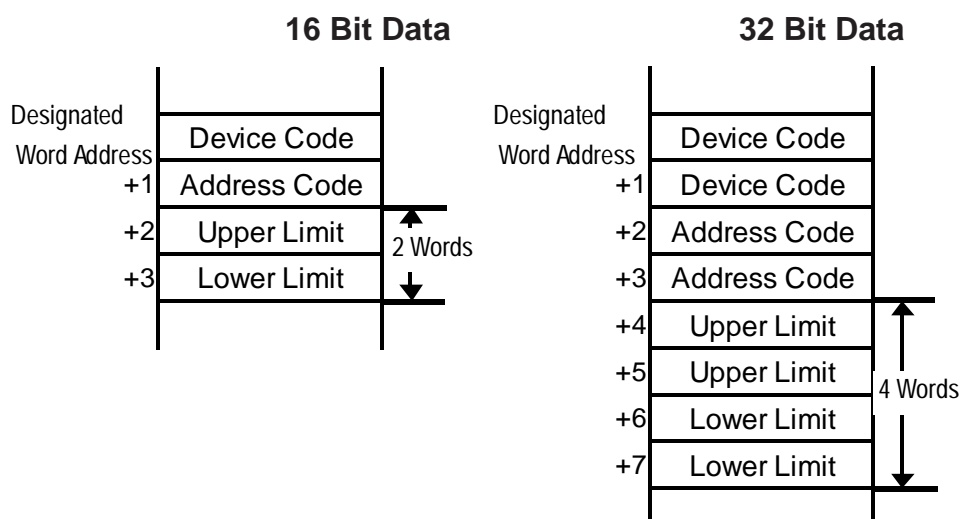

<Alarm Ranges>

Data Format			Alarm Range
		Code +/-	
16 Bit	Dec	+/-	-32768 - 32767
		+	0 - 65535
	Hex		0 - FFFF (h)
	Oct		0 - 177777 (o)
	Bin		0 - FFFF (h)
	BCD		0 - 9999
32 Bit	Dec	+/-	-2147483648 - 2147483647
		+	0 - 4894967295
	Hex		0 - FFFFFFFF (h)
	Bin		0 - FFFFFFFF (h)
	BCD		0 - 99999999
	Float		-9.9e ¹⁶ - 9.9e ¹⁶

■ Arithmetic Operation

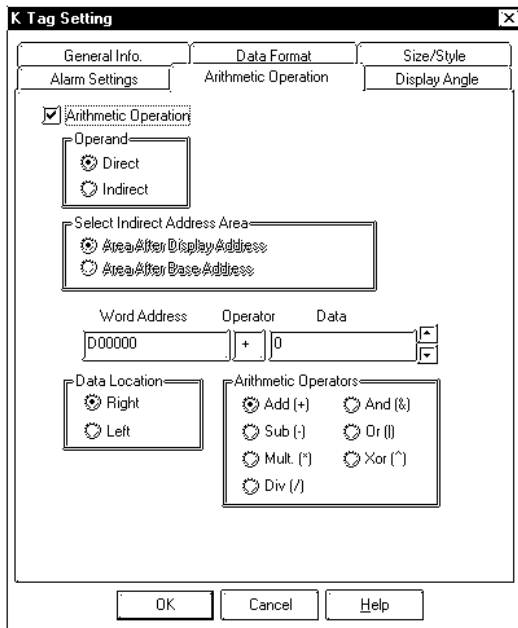

Arithmetic Operation

Select this option to perform an arithmetic operation. Although Storage Address Data can be calculated and displayed, PLC internal data cannot be overwritten.

Operand

Direct

Select this option to directly designate the operand.

Indirect

Select this option to indirectly designate the operand in a word address. If the Indirect option has not been selected on the Data Format page, the data in the Word Address set on that page and the immediately following address will be calculated. If selected, the next attribute Select Indirect Address Area will be valid.

▼Reference “2.6.4 Indirect Word Addressing Examples”, E-tag

Select Indirect Address Area

Area After Display Address

The address storing the operand will immediately follow the indirectly designated address where display data is stored.

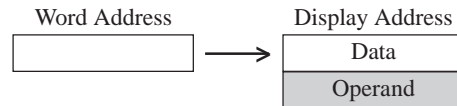

Area After Base Address

The operand storing addresses will be allocated to the consecutive addresses immediately following the Word Address set on the Data Format page. If the Device Type & Address option is selected on the Data Format page, these addresses will be allocated to the second and later addresses from the designated Word Address.



Data

Defines the data used for the arithmetic operation.

Data Location

Select the data location from Left and Right.

Arithmetic Operators

Select an operator for the arithmetic operation.



When “Arithmetic Operation/Designated Arithmetic Operation Data/Indirect” is selected with the following two conditions valid, when “**+2” is displayed as a result of an arithmetic operation, it actually means “****+1”.**

- When selecting Indirect, Device Type & Address, and Display Data Type/32 bits in the Data Format area during tag settings.
- When the device code stored in the Base Address is 32 bit device.

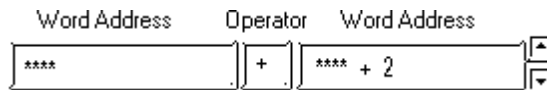

- With the Absolute Value Display, the arithmetic operation can be set only when the Alarm option is not selected. Note that the arithmetic operation is disabled if the Data Display Format is set to Float.
- Any overflowing digits resulting from an arithmetic operation are ignored.

■ Display Angle

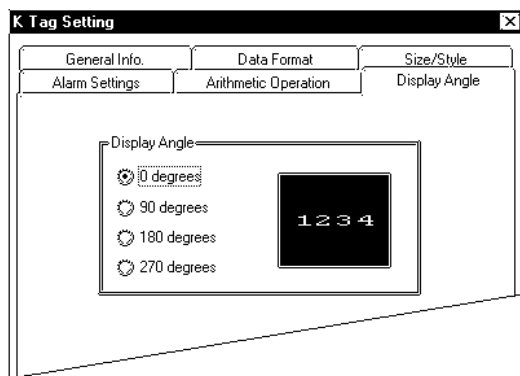

Display Angle

Setup the rotation for the display. Select 0 (zero), 90, 180, or 270 degrees.

2.12.4 Data Input Example

The following provides an example of data input on the GP.

1. Three K-tags have been set to the same trigger bit address.

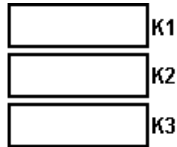

2. When the trigger bit in the host is set high (0 to 1)

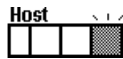

3. First, the K1 field highlights and awaits input.



4. Then enter a value from the GP touch keypad.

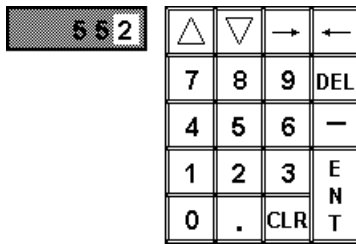

5. And press the ENT key.



6. The data is stored in the K1 tag's word address. Then the next tag, K2, highlights and awaits input.

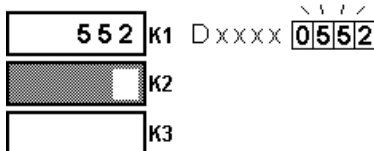

- Note:**
- Turn OFF the Trigger Bit to hide the cursor.
 - Use the bit switch and a T-tag to set the trigger bit high (0 → 1). If the T-tag Operation Mode is set to Invert, then the same T-tag can also reset (1 → 0) the trigger bit. **Reference** 2.23 T-tag (Touch Panel Input)
 - For details on using a touch keyboard **Reference** 2.13 k-tag (Keyboard Setup)

2.12.5 Notes on Entering BCD Data

(1) Usable Keys

The following keys can be used to enter BCD data.

MODE		Valid Keys
Alarm enabled	with decimal places	'0' - '9' and '.' (decimal point) * The decimal point will be used as a cursor movement key*.
	no decimal places	'0' - '9'
Alarm disabled	with decimal places	'0' - '9' and '.' (decimal point), '-'(minus), '+'(plus), 'E', and ':'(colon) * The decimal point will be used as a cursor
	no decimal places	'0' - '9' and '.' (decimal point) * When a decimal point is entered, the code "0Dh" is written to the host to represent a decimal point.

* When decimal places are in use, the decimal point on the touch keyboard becomes a cursor movement key which switches the cursor between the integer and decimal area. This operation also applies when the Data Format is set to Dec.

E.g.)

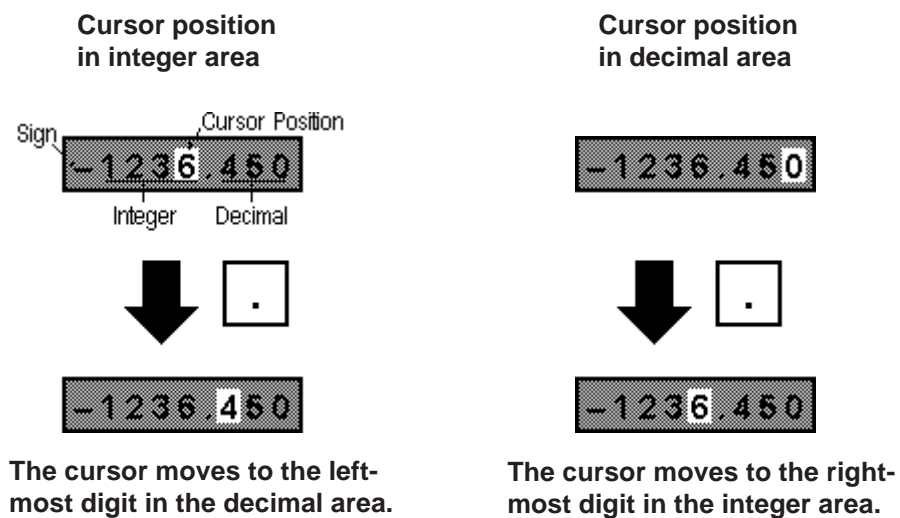

(2) Using the Negative Code

When entering BCD data, the negative code is included in the Display Digit value. However, the negative code can only be used when Alarm is disabled and Fraction is set to zero.

E.g.1) When the data format is 16-bit BCD and the display digit is 4-digit; If you input “-123” with the keypad on the touch panel, “F123h” will be sotred in the data storage address.



E.g.2) When the data format is 32-bit BCD and the display digit is 5-digit;
 If you input “-1234” with the keypad on the touch panel, “F0001234h” will be stored in the data storage address.

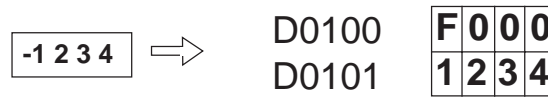

- The negative code is not included in the Display Digit value when using the Dec data format.
- Hex and Oct formats do not use negative data.
- After entering negative data, press the plus (+) key to change it into positive data.

E.g. To change -1234 into 1234...

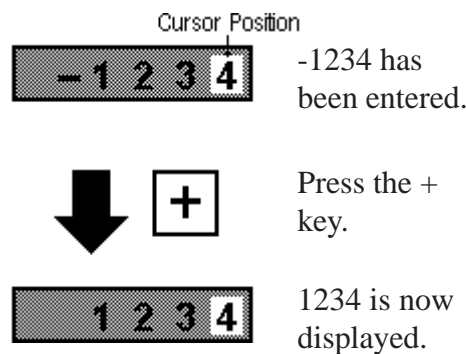

E.g. When the data format is “16-bit BCD” and the number of displayed digits is “4 digits,” enter “-1” to store “F001h” in the data storage address using the key board on the touch panel.

Display of data storage address during input



Display of data storage address after input

- 001

Even if zero suppression is enabled, a “0” after the minus (-) sign is displayed.

2.12.6 Auto Clear Example

When Auto Clear On has been selected in the Input Style, and the cursor is on the first character, pressing any character key ^{*1} performs the operation below.



When the cursor is on the first character...



And you press a character key...
The previous data clears, and the number 4 is entered.

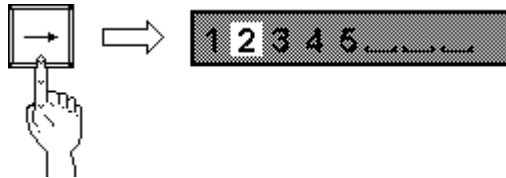

If you press an arrow key (cursor movement)...
The cursor position shifts without erasing the previous data.



Note:

- If the cursor is not in the first position, then entering a character will not clear the previous data.
- The K-tag display operates the same for barcode inputs.

**1 Character keys exclude the cursor movement, ENT, DEL, and BS keys.*

2.12.7 Using Arithmetic Operations

■ When Setting up Data

- Displays the value as was set up.
- The value written to the Word Address is the result of a reverse calculation for a regular arithmetic operation (ADD/SUB/MUL/DIV), or the result of a logical arithmetic operation (AND/OR/XOR).

E.g. When the Word Address is “D00100”, the operator is “+” and the data is “3”, the set value minus 3 is written to the Word Address by the K-tag.

Write Value A (Arithmetic Operator) data = Set Value B

D00100 + 3 = Value display with the K-tag

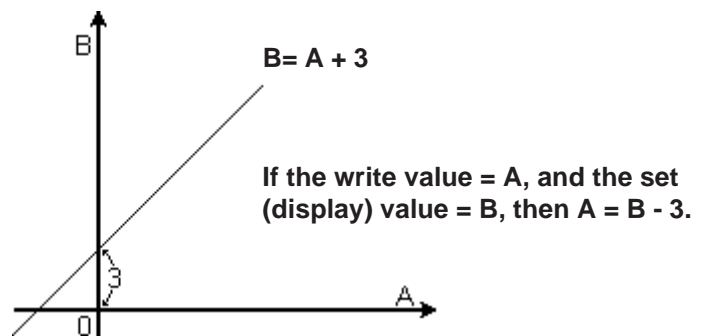

- If a division operation results in a remainder, a slight error may occur as a result of the rounding-up operation.
- Logical arithmetic operations (AND/OR/XOR) are performed in bit operations.

■ Data Display (when trigger bit = 0)

- Displays the results of the arithmetic operation performed on the data in the Word Address (same as N-tag).

< Arithmetic Operation Table >

Display Time		Setup Time
ADD	↔	SUB
SUB	↔	ADD
MUL	↔	DIV
DIV	↔	MUL
AND	↔	AND
OR	↔	OR
XOR	↔	XOR

2.13 k-tag (Keyboard Setup)

2.13.1 Overview

k-tags can be used to create lettered or numbered data input switches. Use these in combination with K-tags, which writes the data input through k-tags to the designated word addresses.

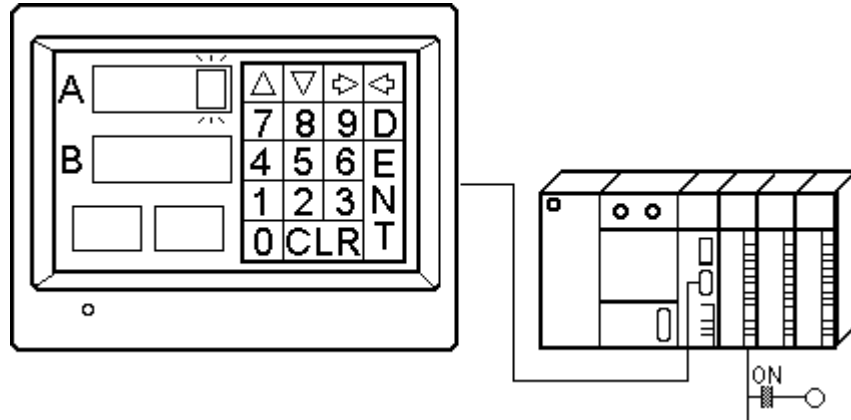

* The setup data is displayed and written to the host (PLC) using the K-tag.

2.13.2 About k-tags

- ◆ The operation keys listed below can be created using k-tags.
 - Character Input key
 - DEL (delete) key
 - CLR (clear) key
 - BS (back space) key
 - ENT (enter) key
 - Cursor movement (left, right, previous tag, next tag) key
 - Keyboard Change Screen key
 - Logging Cancel key
- ◆ Use k-tags (small letter “k”) combination with K-tags (capital letter “K”). The K-tag displays the data input through the k-tags, and writes it to the host (PLC). The data can be written only when K-tag data input is in the standby status. **▼Reference▲** “2.12.4 Data Input Example”, K-tag
- ◆ When all the keys for the keypad do not fit on a single screen, use a keyboard Change Screen function so that the rest of the keys become available.

- ◆ Create k-tags on a Keypad screen, then load and use the Keypad screen on a Base screen. Although you can create k-tags directly on a Base screen, an obvious disadvantage will be that the keypad Change Screen function is unavailable on the Base screen.



Note: Only 1 Keypad screen can be called into a Base screen.

- ◆ In the GP-470/570, pressing a touch-key can cause a buzzer sent from the AUX interface, located on the back of the unit. Buzzer output operations cannot be performed on the GP-270, GP-370, GP-377R, GP-377, GP-H70, GP-2300, GP-2301 and GP2000H.



- Several sample keyboards are included with your screen editing package.
- For details about how to use the sample keypad:

Reference *Operation Manual, 3.3 Creating a Keypad: the Keypad Screen ■ Application of Sample Keypads*

2.13.3 Using k-tags

■ General Info.

The General Info. page provides information about the current settings for the k-tag.

Tag Name

Must be no more than five Single-byte or two Double-byte characters long and composed of letters and/or symbols.

Description

Up to 20 Single-byte or 10 Double-byte characters can be entered as a description of the tag.

■ Mode

Mode

Select the operation for the particular key.

<ENT>

Sends the inputted data to the host (PLC).

<BS>

Backspace (Moves the cursor back one position, deleting the character in that position.)

<CLR>

Erases the current input data.

Deletes a single character in the current cursor position.

<ASCII>

Sets up character keys.

<UP>

Moves cursor to the preceding input field.

<DN>

Moves cursor to the next input field.

<LT>

Moves the cursor one position to the left.

<RT>

Moves the cursor one position to the right.

<Change Screen>

Becomes a key to switch the keypad.

<Cancel> for Logging Setting

Becomes a Cancel key for the logging function.

Although settings for the FEP can be specified in language environments other than Japanese, these will not work on the GP.



Note:

When switching between different sized keypad, set the Clear Area to cover all exceeding portions.

Reference For information on the “Clear Area” order, refer to *Operation Manual, 3.3 Creating a Keypad: the Keypad Screen.*



Note: Even when switching to a smaller sized keypad, drawings and text hidden by the previous larger keypad will not be visible. As a result, do not make any drawings (except a touch keypad) in the portion covered by the Clear Area.

■ Operation Examples

<CLR>

- Zero-suppress is OFF

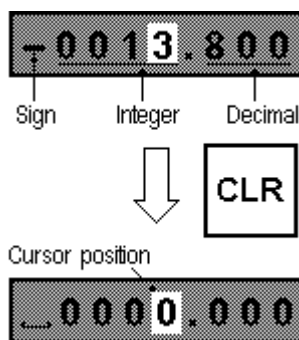

The sign is replaced by a blank space, and the rest of the numbers are cleared to zero. The cursor appears in the lowest integer position.

- Zero-suppress is ON

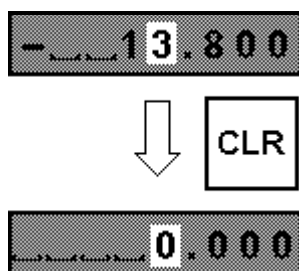

The integer and decimal sections are cleared to zero as the integer part is reduced to a single digit, the zero in the unit position. The cursor appears in the lowest integer position.

<UP>



<LF>

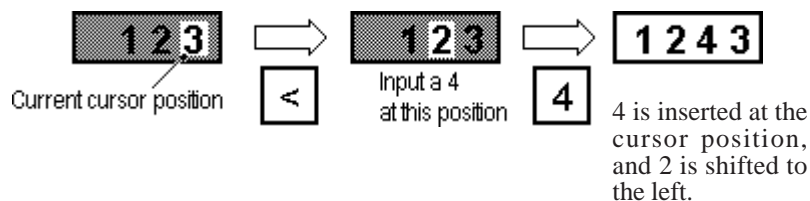

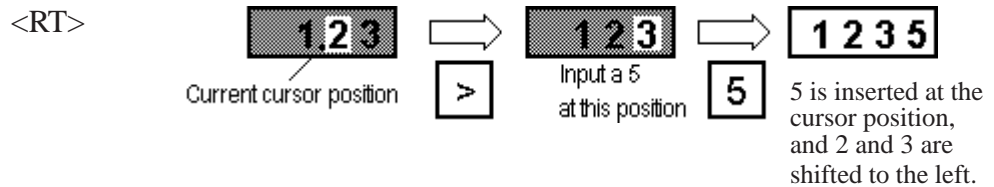

Options

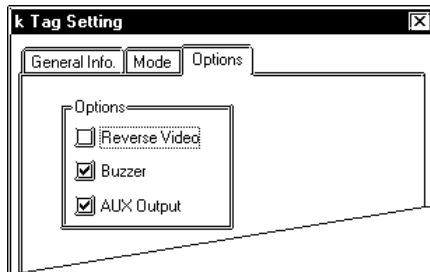

Options

Reverse Video

Determines whether the touch area highlights while pressed.

Buzzer

Set the Buzz Sound ON or OFF. When set ON, a buzz sound activates while the key is pressed. However, there is no ON/OFF option for the buzz sound when the Character Code is set to <ENT>, as the Buzz Sound is fixed ON in this case.

AUX Output

Buzzer output from the AUX interface can be set to ON or OFF while a key is pressed. The GP-270, GP-370, GP-H70, GP-377R, GP-377, GP-2300, GP-2301 and GP2000H do not support this function.



Note:

When using a touch panel key drawn with a fill, and Reverse is set ON, regardless of the color attributes setup, the filled area will blink on the GP screen. When the key uses fills, set Reverse OFF except when necessary.



2.14 L-tag (Library Display)

2.14.1 Overview

Graphics and text in other screens, registered as Libraries, can be called into the Base screen in RUN mode. Responding to changes in word address data, the screen can perform active image displays. Use the L-tag in situations such as displaying a lamp's ON/OFF condition.

A screen image may be composed of a single shape or character string and then used much like a part, called in as a library. An L-tag sets up the overlapping display position for the library's center point.

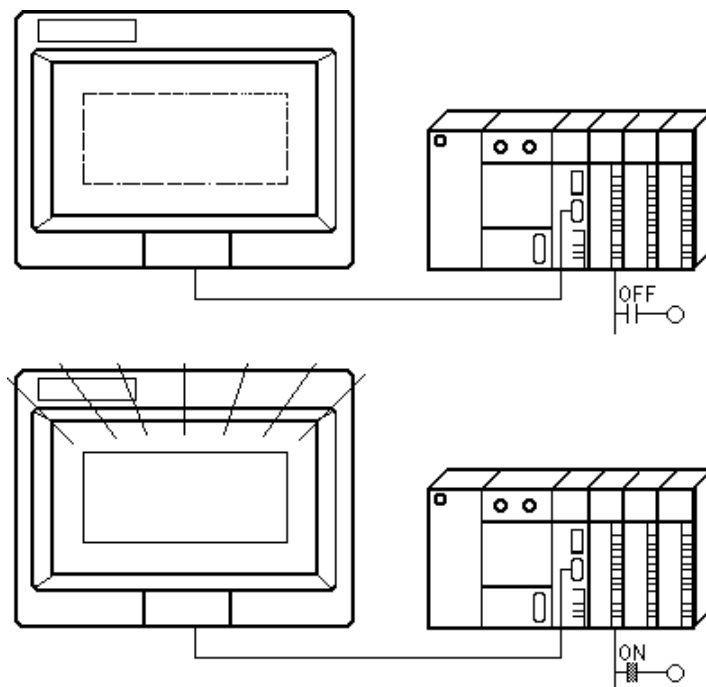

2.14.2 About L-tags

- Graphics and text in a Base screen or Image Library screen, registered as a library, appears on the GP screen according to changes in the corresponding host (PLC) data.
- A library can be made to display when the designated trigger bit changes.

- The display and non-display of libraries can be setup using trigger bits. In such cases, the Base screen library display becomes an XOR display ^{*1}. When the Image Library screen library is displayed, it appears on top of the current screen. When cancelled, the Library screen is written over by a black rectangle to the perimeter of the library screen image.

▼Reference▲ “2.14.8 Notes on XOR Display”, L-tag

- Displayed Library screens can be designated in three different ways: “Direct,” “Indirect,” and “State.”
- If Screen Access is set to Direct, the tag is fixed to a single screen.
- If Screen Access is set to Indirect, different library screens can be set to the same tag by simply changing the screen file number in the designated word address. An offset value can be set up for the screen file number.
- If Screen Access is set to State, library screens can change according to the state of data in the designated bit length. Register library screens you would like to display with these consecutive screen numbers. By designating the Offset Screen No. the library changes automatically corresponding to changes in data.

*1 When display figures overlap, the display pixel turns OFF. (XOR display function)

2.14.3 Using L-tags

■ General Info.

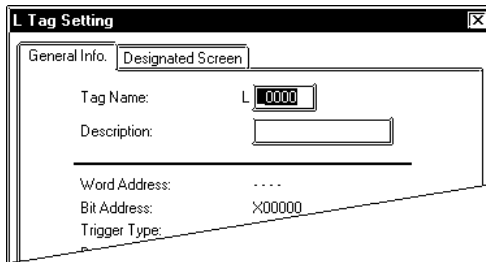

The General Info. page provides information about the current settings for the L-tag.

Tag Name

Must be no more than five Single-byte or two Double-byte characters long and composed of letters and/or symbols.

Description

Up to 20 Single-byte or 10 Double-byte characters can be entered as a description of the tag.

■ Designated Screen/Direct

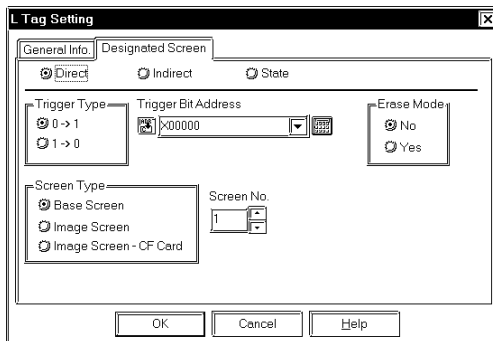

Direct

Select this option to directly designate a library screen file number to fix it.

Trigger Type

0→1

The library appears when the trigger bit changes from OFF to ON. Only a single library can be displayed.

1→0

The library appears when the trigger bit changes from ON to OFF. Only a single library can be displayed.

Trigger Bit Address

Defines the address of the trigger bit.

Erase Mode

No

Yes

When the Yes option is selected, the image designated by the screen file number displays according to the value of the trigger bit. When the No option is selected, the displayed library is not erased.

Screen Type

Base Screen

Image Screen

Select the screen type from Base and Image Library screens.

Image Screen-CF Card

Select this when you want to designate the Image screen saved to the CF Card.

Screen No.

Specify the desired library screen file number (Base screen/Image Library screen) to display.



Note: Presuming the Image Library screen's Erase Mode has been set to Yes. When the Image Library screen is displayed, it appears on top of the current screen. When cancelled, the Library screen is written over by a black rectangle.

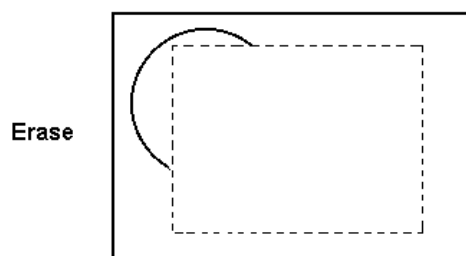
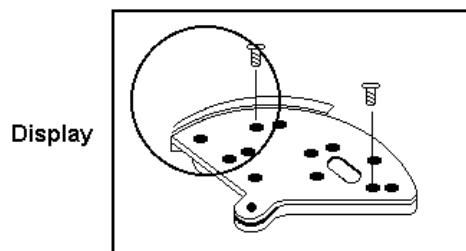
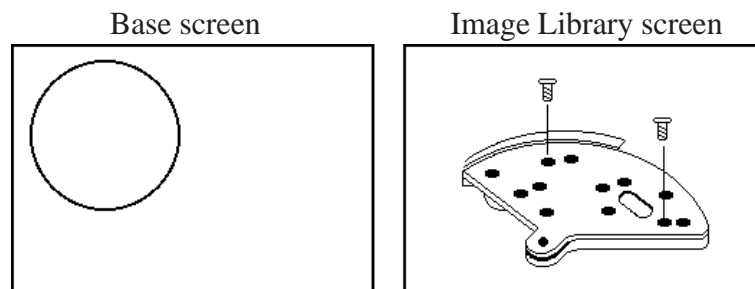

The Image Library screen is erased by a black rectangle painting (overlying) over it. In the example to the left, the dotted rectangle represents the black filled area.



- When Erase Mode is set to Yes, the called library will not display images that use 3 or 5 pixel lines, 2 pixel arrow lines, and relief characters.
- When an image font is laid over another object, the XOR display will not appear.

■ Designated Screen/Indirect

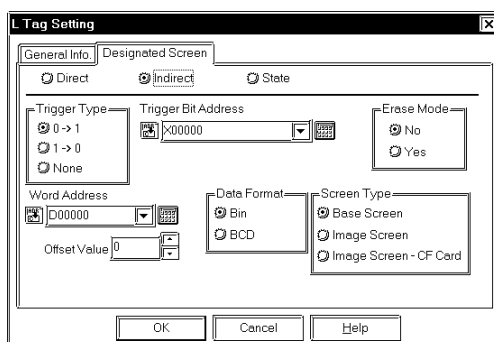

Indirect

Select this option to display the library whose screen file number matches the screen file number stored in the word address. The screen type, however, must be either a Base screen or Image Library screen.

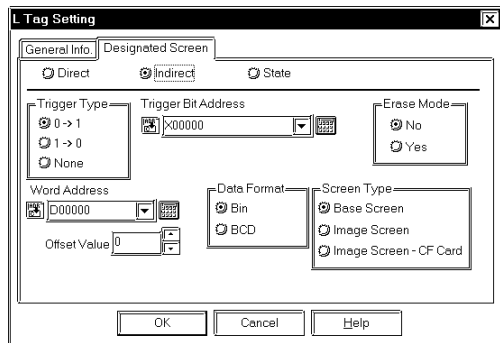

Trigger Type

0→1

The library appears when the trigger bit changes from OFF to ON. Only a single library can be displayed.

1→0

The library appears when the trigger bit changes from ON to OFF. Only a single library can be displayed.

None

The screen file number of the display image changes according to the data in the designated Word Address.

Trigger Bit Address

Defines the address of the trigger bit.

Erase Mode

No

Yes

When the Yes option is selected, the image designated by the screen file number displays according to the value of the trigger bit. When the No option is selected, the displayed library is not erased.

Word Address

Defines the word address containing the display screen file number.

Offset Value

Defines the offset value added to the word address data. Enter 0(zero) if offset will not be used.

Screen Type

Base Screen

Image Screen

Select the screen type from Base and Image Library screens.

Image Screen-CF Card

Select this when you want to designate the Image screen saved to the CF Card.

Data Format

Bin

BCD

Defines the data format used for the data in the word address.

Reference “2.14.7 Offset Settings”,
L-tag

■ Designated Screen/State

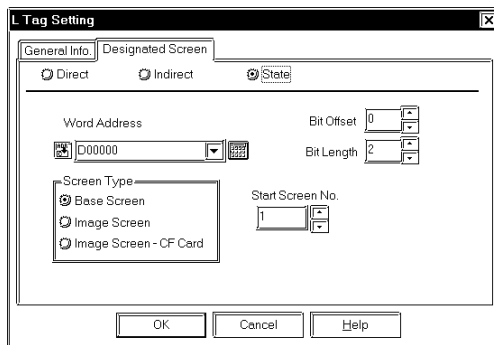

State

Responding to changes in multiple bits, the library display changes.

Word Address

Library screen to display depends on the state of bit in the designated bit length of this word address.

Bit Offset

Defines the bits, from which position in the Word Address, are used as the state trigger bits.

Bit Length

Defines how many bits in the Word Address are used as the state trigger bits.

Screen Type

Base Screen

Image Screen

Select the screen type from Base and Image Library screens.

Image Screen-CF Card

Select this when you want to designate the Image screen saved to the CF Card.

Start Screen No.

Defines the start screen file number (Base or Image Library screen) of the library screen display.

The plotting point of a library is the center point of the loaded Base screen.

2.14.4 Library Display Coordinates

Therefore, using the GP-470 model in this example, the library is displayed as its (320,200) point overlaps the point set up on the Base screen.

E.g. The screen to load

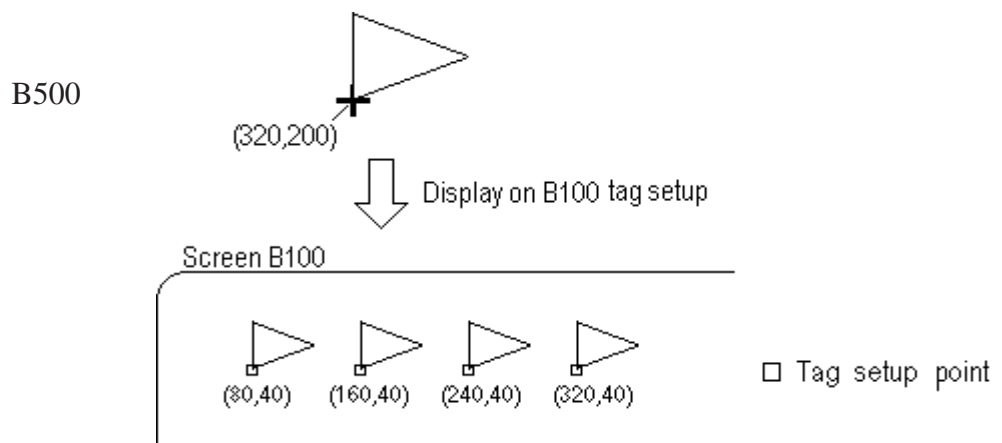



- Any parts of the library image that do not fit in the GP display are discarded.
- Libraries loaded onto a Base screen using an L-tag can only display graphics and text. Any tag settings set on these library screens are not loaded. If you wish to use a Base screen including its tag settings on top of another Base screen, use the Window display function.

Reference 2.26 U-tag (Window Display) and Operation Manual, “3.7 Window Display: Window (U) Screen and Base (B) Screen”



- Image Library screens can also be displayed as libraries, using the same plotting method as Base screens.

Reference GP-PRO/PB III for Windows Operation Manual, “3.5 Creating an Image : the Image Screen”

- The center coordinates of each model of GP panel are as shown in the table below:

GP Type	GP-470 GP-477R	GP-570	GP-270 GP-370	GP-675 GP-2600 GP-2601
		(GP-870VM)		
		GP-577R	GP-H70	
		GP-2400	GP-377R	
		GP-2401	GP-2300	
		GP-2500	GP-2301	
		GP-2501	GP-2301H	
		GP-2401H		
Screen Center Coordinates	320,200	320,240	160,120	400,300

2.14.5 Display Timing

The timing chart below shows the relationship between the image on the screen, the value of the trigger bit, and the L-tag Trigger Type after a screen change.

<Example>

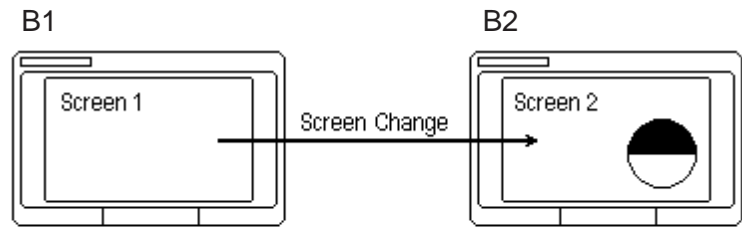

•L-tag setting
Trigger Type 0->1



■ Timing Chart

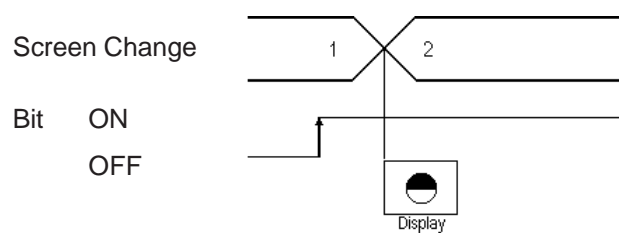

Because the bit was set ON before the screen change, the L-tag is displayed.

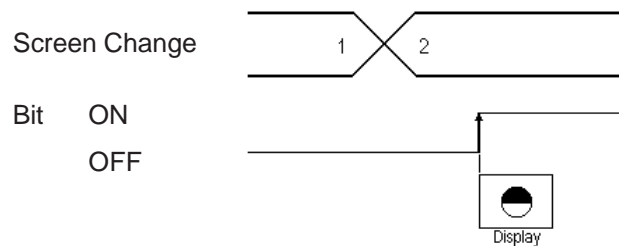

Because the bit was set OFF before the screen change, the library does not display. After the screen change, the library will display when the bit is set ON.

2.14.6 Erase Mode Settings

The library display changes with the Erase Mode setting.



Note: When the Display Mode is set to Indirect Data and the Screen Access is set to State, the Erase Mode is fixed to No.

- E.g. • L-tag setting
 - Trigger Type: 0 -> 1
 - Screen Access: Indirect
- Libraries registered:

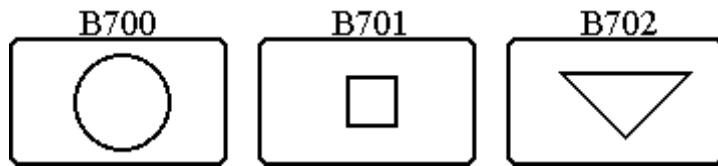

■ Timing Chart

- Erase Mode = (Enabled)

The image appears when the bit is ON. When the bit is OFF, the image is removed.

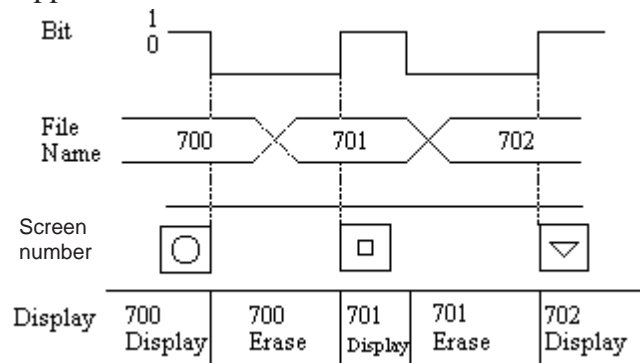

- Erase Mode = (Disabled)

The library image remains displayed if the bit turns OFF. The next library image overlaps on the current image.

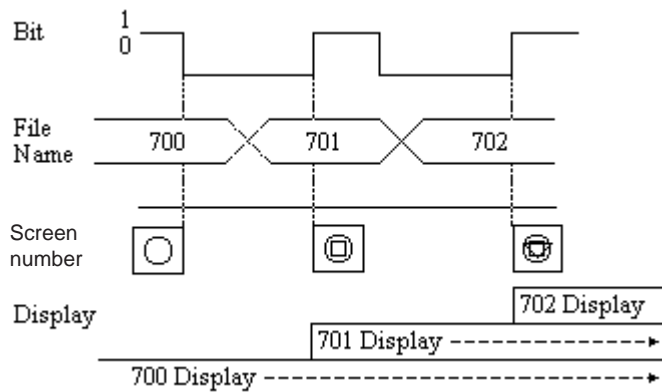

2.14.7 Offset Settings

This section explains an example of how to use an offset.

E.g.)

In the example below, the data from a single address is used to trigger the simultaneous display of both an L-tag and an M-tag.

Setup these tags

Tag Name	Word Address	Data Format	Offset Value
L1	DM50	BCD	200
M1	DM50	BCD	0

When the data value in address DM0050 is 100, both L-tag's library B300 and M-tag's Mark M100 display at the same time.

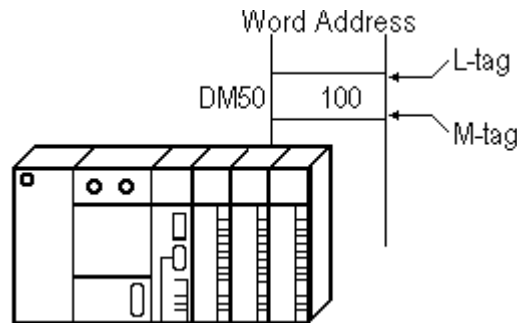

$$\begin{array}{l}
 \left\{ \begin{array}{l}
 \text{L-tag} \\
 \text{M-tag}
 \end{array} \right.
 \end{array}$$

100	+	200	=	300
↑		↑		↑
Data in the word address		Offset value		Screen No. to display
100	+	0	=	100
↑		↑		↑
Data in the word address		Offset value		Screen No. to display

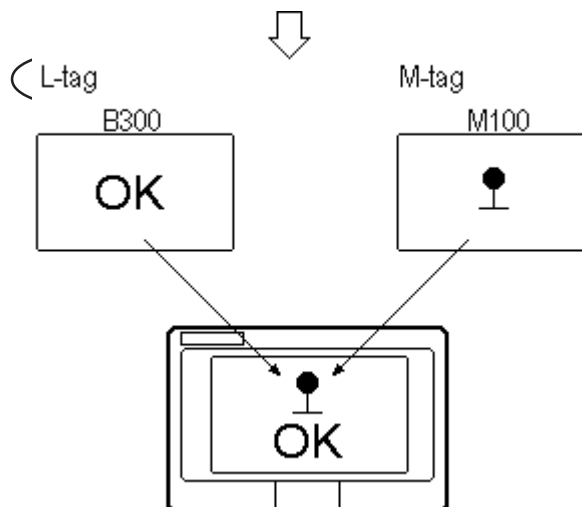

2.14.8 Notes on XOR Display

When Erase Mode is set Yes, library images created on Base screens display using XOR overwrite. For example, when two ON-status pixels are laid on top of each other, they become an OFF-status pixel.

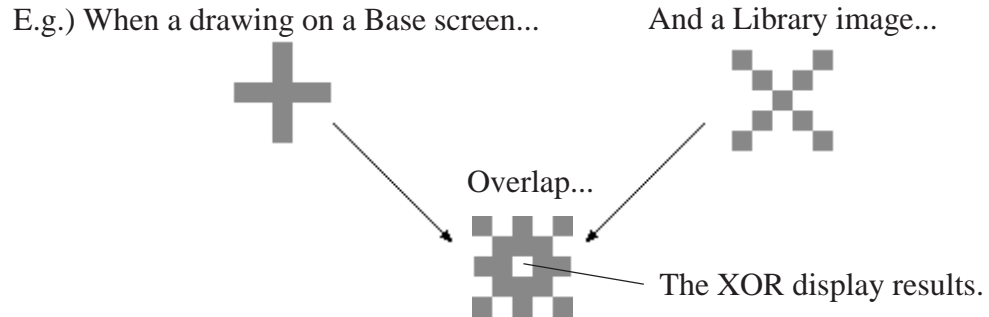

The XOR display can result in the following problems.

When loading a library using fills, and its drawings are laid on top of other drawings or text in the Base screen, filling may leak from the section showing OFF-status pixels designated in the XOR display.

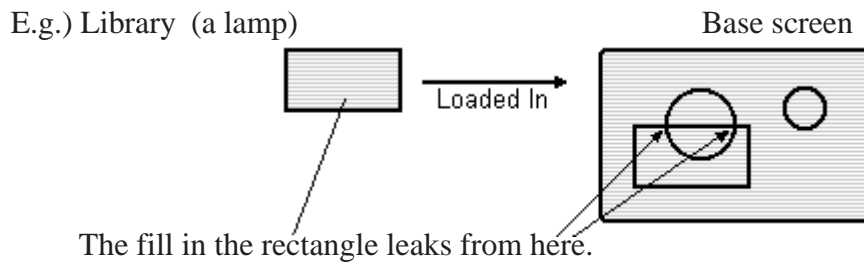

Note: When drawing a rectangular lamp, use the Pattern attribute to make a filled rectangle.

When using multiple shapes or polygons, dots at intersection points are lost because of the XOR drawing mode.

E.g.) Drawings on a library file ... When loaded into a Base screen

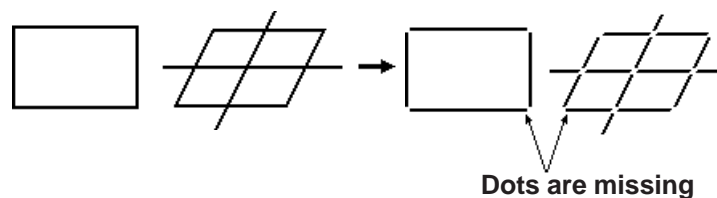



Note: To avoid losing dots at intersections, draw lines without overlapping the end points.

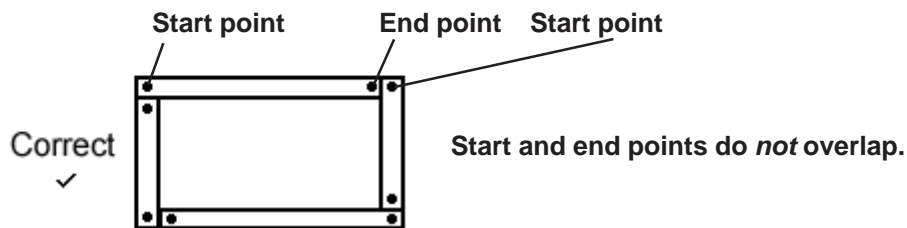
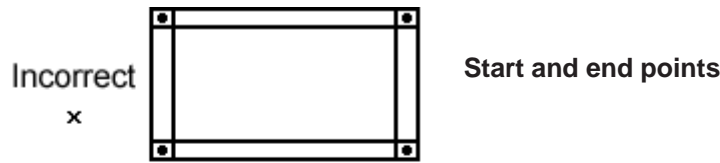

2.14.9 How to Avoid Overlapping Erase Images

When libraries are called with the Screen Access set to Indirect and the Erase Mode set to No, and the library image changes, the new image is drawn on top of previous images. To avoid overlapping Library Item erase images, create erase library screens as follows.

• **Libraries to load**

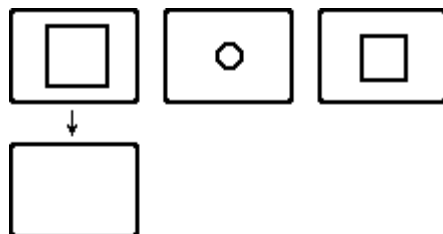

1. Draw a black filled rectangle that covers the largest figure among all the libraries that will be loaded in.

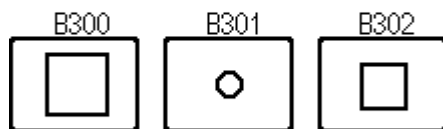

2. In each library, draw your figures on top of this black filled rectangle.

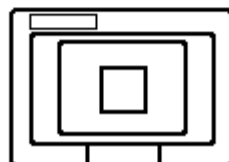

When images are called up using an L-tag, it will appear as if only the objects in the current loaded library are displaying.

Actually, the images from screens B300 and B301 are also in the display, but only B302 appears.

2.14.10 Overlapping Colors on a Color GP

In a color GP, when figures or text with the Erase Mode set to Yes are loaded into a Base screen in RUN mode, overlapping any of the screen's previous images will make the colors blend. So, you must consider color combinations when overlapping colors. See the following table to determine the display colors.

◆ When using 8 color display:

<Overlapping Colors List >

	Blue	Green	Cyan	Red	Magenta	Yellow	White
Blue	Black	Cyan	Green	Magenta	Red	White	Yellow
Green	Cyan	Black	Blue	Yellow	White	Red	Magenta
Cyan	Green	Blue	Black	White	Yellow	Magenta	Red
Red	Magenta	Yellow	White	Black	Blue	Green	Cyan
Magenta	Red	White	Yellow	Blue	Black	Cyan	Green
Yellow	White	Red	Magenta	Green	Cyan	Black	Blue
White	Yellow	Magenta	Red	Cyan	Green	Blue	Black

* Overlapping the same colors causes it to turn black.

E.g.) A library is loaded into a Base screen below.

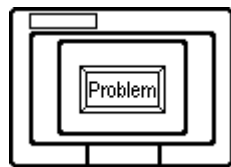

- L-tag setting:
 - Trigger Type: 0 -> 1
 - Screen Access: ... Direct, Screen No. 300
- B300  **Display color set to RED.**

When the bit is ON, B300 displays to make it look like a lamp has turned ON.

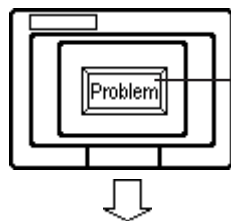

To display the word "Problem" in YELLOW...

...then the word "Problem" originally must be set in GREEN.

■ When using 64 color display:

Since, there are so many colors with 64 color display, colors are indicated by color codes.

<Color code>

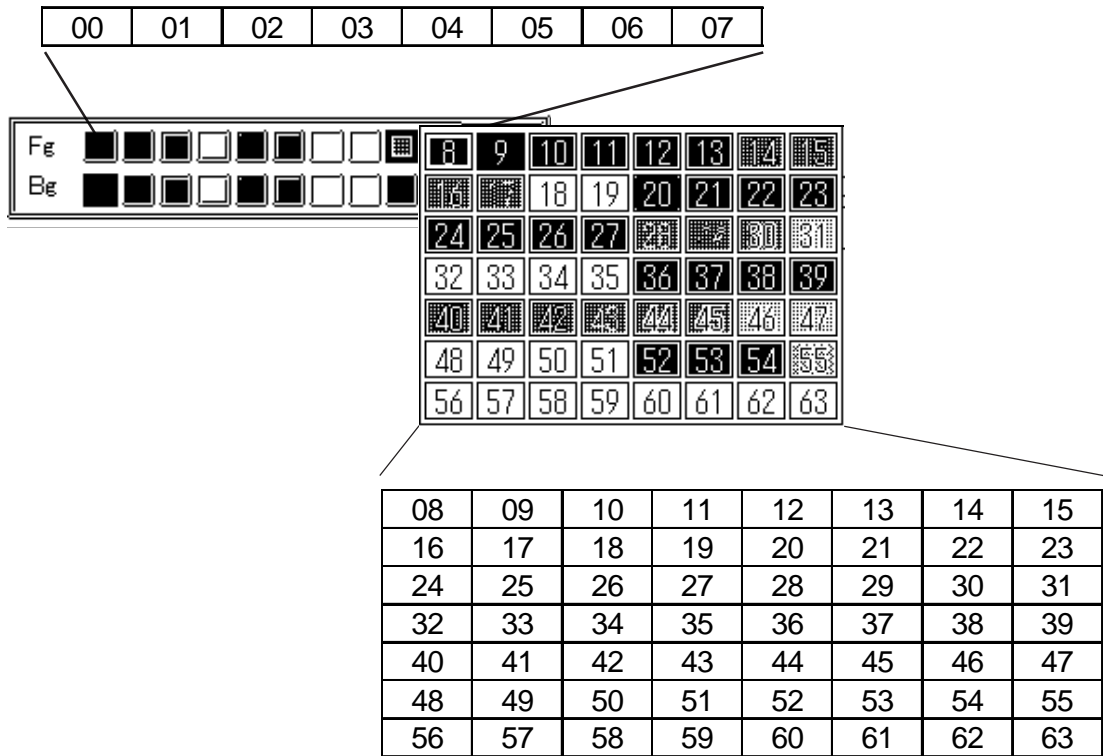

< 64 color RGB Code Table >

Color Code	RGB Code	Color Code	RGB Code	Color Code	RGB Code	Color Code	RGB Code
00	00h	20	20h	40	34h	60	1Fh
01	01h	21	28h	41	3Ch	61	17h
02	02h	22	29h	42	3Dh	62	0Eh
03	03h	23	21h	43	35h	63	0Fh
04	04h	24	30h	44	36h		
05	05h	25	38h	45	3Eh		
06	06h	26	39h	46	3Fh		
07	07h	27	31h	47	37h		
08	08h	28	32h	48	26h		
09	09h	29	3Ah	49	2Eh		
10	10h	30	3Bh	50	2Fh		
11	18h	31	33h	51	27h		
12	19h	32	22h	52	0Ch		
13	11h	33	2Ah	53	0Dh		
14	12h	34	2Bh	54	14h		
15	1Ah	35	23h	55	1Ch		
16	1Bh	36	24h	56	1Dh		
17	13h	37	2Ch	57	15h		
18	0Ah	38	2Dh	58	16h		
19	0Bh	39	25h	59	1Eh		

E.g.

When overlapping color codes “10” and “40”:

Check each color code’s RGB code referring the “RGB Code Table”.

Color code “10”: RGB code “10h”

Color code “40”: RGB code “34h”

These codes will become as follows for the GP data.

Color code	[10]	: RGB code	[10h]
Blk	1	0	

Color code	[40]	: RGB code	[34h]
Blk	3	4	

For the XOR display, an XOR operation will be performed.

Color code	[10]	: RGB code	[10h]
Blk	0	1	0 0 0 0

Color code	[40]	: RGB code	[34h]
Blk	1	1	0 1 0 0

Operation result	: RGB code	[24h]	
Blk	1	0	0 1 0 0

As a result of an XOR operation, when overlapping color codes “10” and “40”, this overlapped color will be displayed as the following color code:

Color code “36”: RGB code “24h”

■ When using 256 Color display:

< 256 color RGB Code Table >

Color code	RGB code	Color code	RGB code	Color code	RGB code	Color code	RGB code	Color code	RGB code
0	00h	52	14h	104	0Ah	156	2Ch	208	EEh
1	01h	53	15h	105	1Ah	157	3Ch	209	FEh
2	02h	54	24h	106	1Bh	158	3Dh	210	FFh
3	03h	55	34h	107	0Bh	159	2Dh	211	EFh
4	04h	56	35h	108	4Ah	160	A0h	212	E6h
5	05h	57	25h	109	5Ah	161	B0h	213	F6h
6	06h	58	26h	110	5Bh	162	B1h	214	F7h
7	07h	59	36h	111	4Bh	163	A1h	215	E7h
8	10h	60	37h	112	4Eh	164	A8h	216	A Eh
9	11h	61	27h	113	5Eh	165	B8h	217	B Eh
10	20h	62	16h	114	5Fh	166	B9h	218	B Fh
11	30h	63	17h	115	4Fh	167	A9h	219	A Fh
12	31h	64	6Eh	116	0Eh	168	E0h	220	A6h
13	21h	65	7Eh	117	1Eh	169	F0h	221	B6h
14	22h	66	7Fh	118	1Fh	170	F1h	222	B7h
15	32h	67	6Fh	119	0Fh	171	E1h	223	A7h
16	33h	68	2Eh	120	C0h	172	E8h	224	2Ah
17	23h	69	3Eh	121	D0h	173	F8h	225	3Ah
18	12h	70	3Fh	122	D1h	174	F9h	226	3Bh
19	13h	71	2Fh	123	C1h	175	E9h	227	2Bh
20	40h	72	82h	124	C8h	176	ECh	228	6Ah
21	50h	73	92h	125	D8h	177	FCh	229	7Ah
22	51h	74	93h	126	D9h	178	FDh	230	7Bh
23	41h	75	83h	127	C9h	179	EDh	231	6Bh
24	60h	76	8Ah	128	CCCh	180	E4h	232	08h
25	70h	77	9Ah	129	DCCh	181	F4h	233	18h
26	71h	78	9Bh	130	DDCh	182	F5h	234	19h
27	61h	79	8Bh	131	CDCh	183	E5h	235	09h
28	62h	80	C2h	132	C4h	184	ACCh	236	48h
29	72h	81	D2h	133	D4h	185	BCCh	237	58h
30	73h	82	D3h	134	D5h	186	BDCh	238	59h
31	63h	83	C3h	135	C5h	187	ADCh	239	49h
32	42h	84	CAh	136	8Ch	188	A4h	240	4Ch
33	52h	85	DAh	137	9Ch	189	B4h	241	5Ch
34	53h	86	DBh	138	9Dh	190	B5h	242	5Dh
35	43h	87	CBh	139	8Dh	191	A5h	243	4Dh
36	44h	88	CEh	140	84h	192	A2h	244	0Ch
37	54h	89	DEh	141	94h	193	B2h	245	1Ch
38	55h	90	DFh	142	95h	194	B3h	246	1Dh
39	45h	91	CFh	143	85h	195	A3h	247	0Dh
40	64h	92	C6h	144	28h	196	AAh	248	90h
41	74h	93	D6h	145	38h	197	BAh	249	91h
42	75h	94	D7h	146	39h	198	BBh	250	81h
43	65h	95	C7h	147	29h	199	ABh	251	88h
44	66h	96	8Eh	148	68h	200	E2h	252	98h
45	76h	97	9Eh	149	78h	201	F2h	253	99h
46	77h	98	9Fh	150	79h	202	F3h	254	89h
47	67h	99	8Fh	151	69h	203	E3h	255	80h
48	46h	100	86h	152	6Ch	204	EAh		
49	56h	101	96h	153	7Ch	205	FAh		
50	57h	102	97h	154	7Dh	206	FBh		
51	47h	103	87h	155	6Dh	207	EBh		

E.g.

Overlapping color codes are “20” and “120”:

Check each color code’s RGB code, referring to the “RGB Code Table”.

Color code “20”: RGB code “40h”

Color code “120”: RGB code “C0h”

These codes will become as follows for the GP data.

Color code [20]	RGB code [40h]
4	0

Color code [120]	RGB code [C0h]
C	0

For the XOR display, an XOR operation will be performed.

Color code [20]	RGB code [40h]
0 1 0 0	0 0 0 0

Color code [120]	RGB code [C0h]
1 1 0 0	0 0 0 0

Operation result	RGB code [80h]
1 0 0 0	0 0 0 0

As a result of an XOR operation, overlapping color codes are “20” and “120”, this overlapped color will be displayed as the following color code:

Color code “255”: RGB code “80h”



2.15 l-tag <small L> (Library Status Display)

2.15.1 Overview

In the RUN mode screen, this tag loads other library screens to create overlapping displays. This tag is a special Library function. The screen display changes according to the data in the designated word address.

Reference 2.14 L-tag (Library Display)

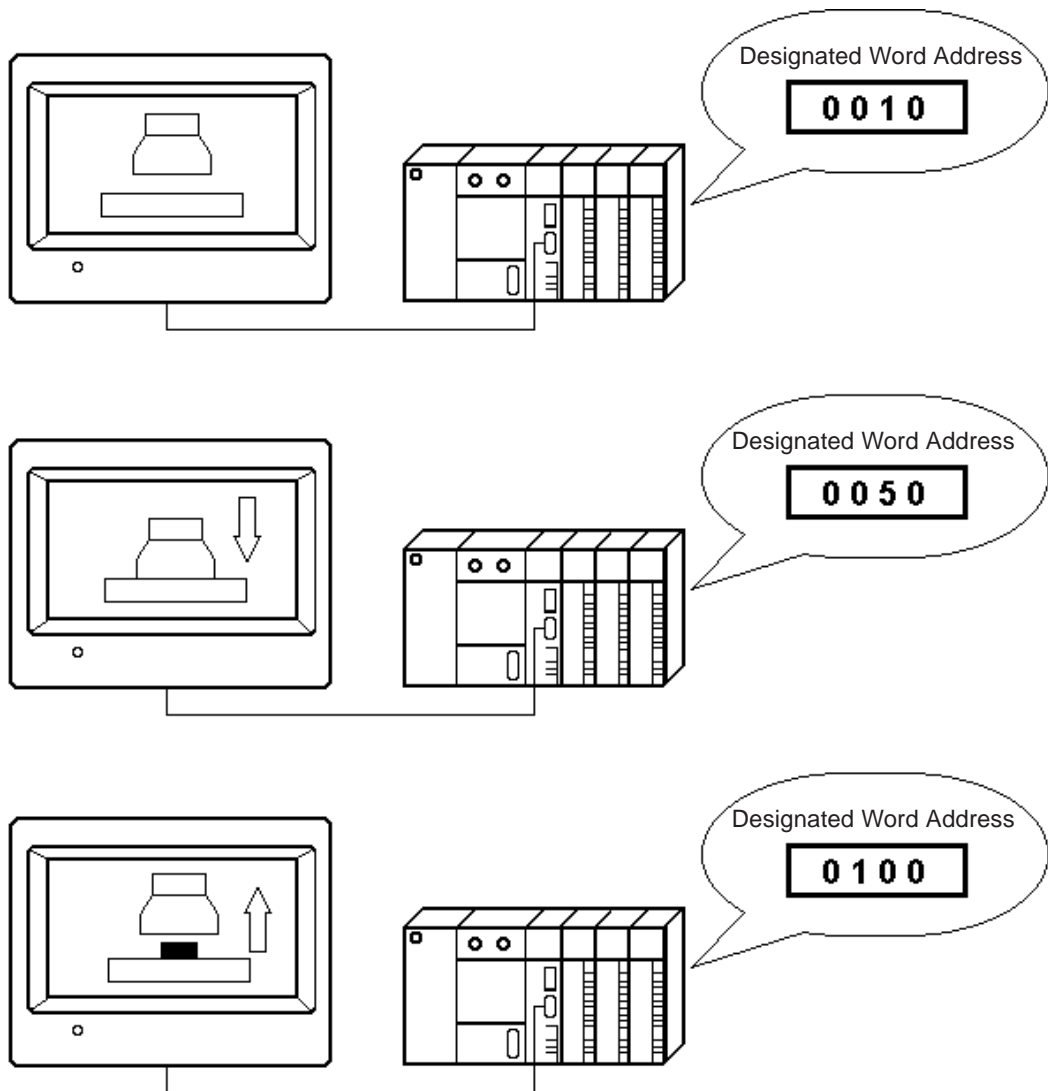

2.15.2 About l-tags

- The libraries registered on Base screens or Image Library screens display according to changes in the designated word address.
- Changes in the designated Monitor Word Address data switches the library display.
- Data changes can switch up to 32 libraries
- Set up the data limits for when library switches take place in the Number of Ranges and Ranges fields. The possible maximum value in the Number of Ranges field is “32” which is the same as that of the maximum number of libraries. Set up the upper and lower limits for each range with a fixed value.
- As many libraries as the designated Number of Ranges are allocated to the consecutive screen file numbers starting from the designated Start Screen No.
- Register library screens you would like to display with these consecutive screen numbers.
- Bit Offset and Bit Length setups are available for the Word Address. Skip the bit 0(zero) as set in the Bit Offset, then use the number of bits listed in the Bit Length field as the data.
- The library display writes over the top of any existing image. Be aware of this when creating libraries.

▼Reference▲ “2.14.9 How to Avoid Overlapping Erase Images”, L-tag

2.15.3 Using I-tags

■ General Info.

I Tag Setting

General Info. | Designated Screen(s) | Range Settings

Tag Name: I 0000

Description:

Word Address: D00000

Start Screen No.: B 1

Bit Offset: 0

Bit Length: 16

The General Info. page provides information about the current settings for the I-tag.

Tag Name

Must be no more than five Single-byte or two Double-byte characters long and composed of letters and/or symbols.

Description

Up to 20 Single-byte or 10 Double-byte characters can be entered as a description of the tag.

■ Designated Screen

I Tag Setting

General Info. | Designated Screen(s) | Range Settings

Word Address: D00000

Screen Type:

- Base Screen
- Image Screen
- Image Screen - CF Card

Start Screen No.: 1

Word Address

The word address set here becomes the monitor word.

Screen Type

Base Screen

Image Screen

Select the screen type from Base and Image Library screens.

Image Screen-CF Card

Select this when you want to designate the Image screen saved to the CF Card.

Start Screen No.

Determines the first screen file number (Base or Image Library screen) of the library to be displayed.

■ Range Settings

I Tag Setting

General Info. | Designated Screen(s) | Range Settings

No. of Ranges: 1

Bit Offset: 0

Bit Length: 16

Range Settings:

Current Value: 1: 0 <> 65535

Range 1 Lower Limit: 0

Range 1 Upper Limit: 65535

Input Data Format:

- Decimal
- Hex
- BCD

OK Cancel Help

No. of Ranges

Set up the total number of switching library screens, which can be a value from 1 to 32. However, a value cannot be designated which exceeds the amount of data which can be displayed in a bit length designated by Bit Length.

E.g. When the Bit Length= 4, the possible Number of Ranges is 1 - 15.

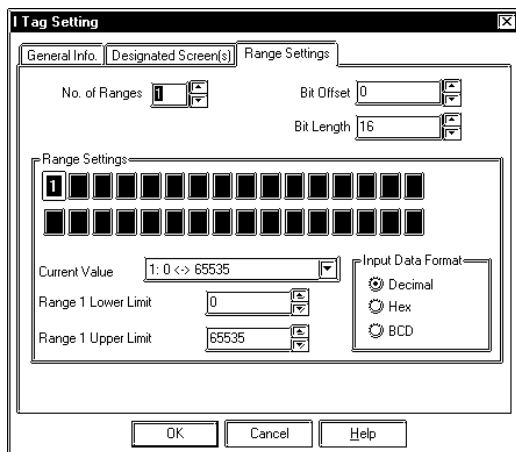

Bit Offset

Set up the offset value, from 0 to 15. When you can use the entire Word Address or when the offset is unnecessary, enter a value of 0(zero).

Bit Length

Determines the number of bits in the Word Address to use for the display. Set up a Bit Length of 1 to 16. When the Bit Offset is other than 0, set up a range whereby the “Bit Offset + Bit Length ≤ 16.” The Bit Offset and the Bit Length values determine the display data. When the Bit Offset is 0, and the entire Word Address is available, set up a value of 16.

Reference “2.15.4 Bit Offset and Bit Length Settings”

E.g. When the Bit Offset is 3 and the Bit Length is 4:

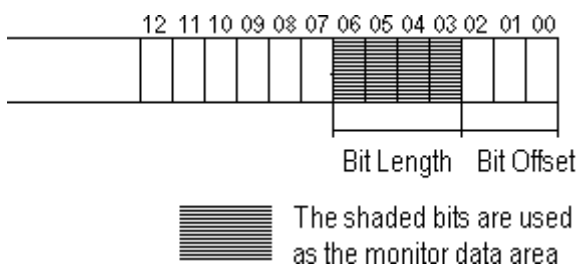

Range Setting

To designate the upper and lower limits for each range, select a range number and set the Range n Lower/Upper Limit fields.

Range n Lower Limit

Range n Upper Limit

Enter the lower and upper limits of the designated range number.

Input Data Format

Decimal

Hex

BCD

Specify the data format when setting the lower limit and upper limit values.

E.g. When the Bit Length is 4, the Number of Ranges is 3, and the Start Screen No. is B1: Range 1 : 0 < 5

Range 5 : 5 < 10

Range 10 : 10 < 65535

<Start Screen No. and Ranges>

Data	Screen No.
0 - 4	B1
5 - 9	B2
10 - 65535	B3

2.15.4 Bit Offset and Bit Length Settings

The l-tag's Bit Offset sets up bits not used as data in the Word Address. Bits not used are the consecutive bits that come before the Bit Length setup. More than one Bit Offset block cannot be set up. Set up an offset value of 0 - 15. When you can use the entire Word Address or the offset is unnecessary, set up a value of 0(zero).

Disregarding the bits set up as the offset, the Bit Length sets up the valid bit numbers used for the data. Set up a Bit Length 1 - 16. Other than when the Bit Offset is 0, set up the values whereby "Bit Offset + Bit Length ≤ 16." The Bit Offset and Bit Length values determine the display data.

E.g. When the Bit Offset is 3, and the Bit Length is 4:

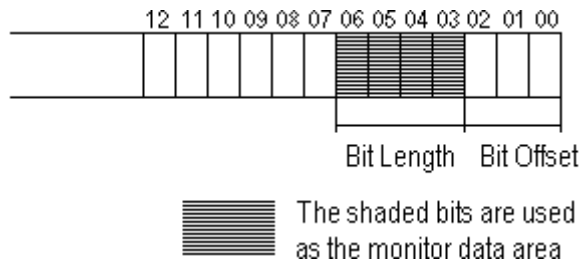

Set up the Bit Offset and Bit Length when portions of the Word Address are controlled elsewhere. It is necessary to set the monitor bits consecutively, as 00 - XX and YY - 15.

E.g. When consecutive four bits from the highest and lowest bits are controlled elsewhere.

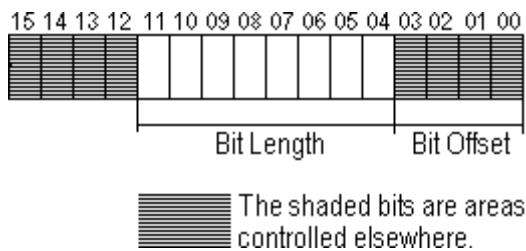

In the example above, the Bit Offset is 4 and the Bit Length is 8.



2.16 M-tag (Mark Display)

2.16.1 Overview

M-tags, used to display Marks (bit mapped icon images) created in a Mark screen, appear on the GP screen when the corresponding data in the PLC changes.

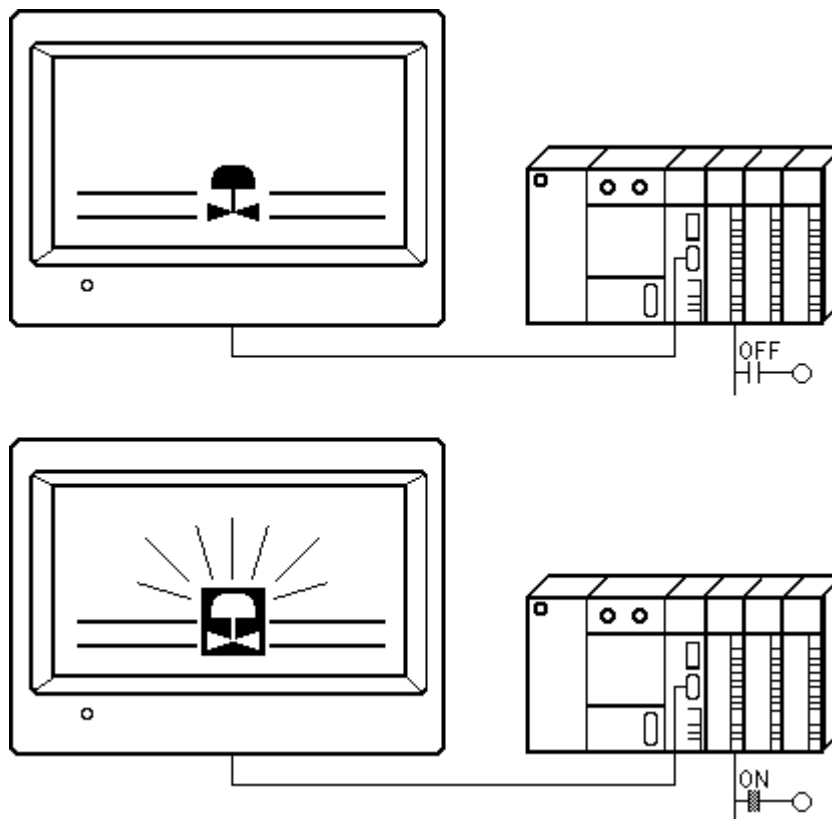

2.16.2 About M-tags

- The display of a Mark is controlled by the ON/OFF value of a bit in the host (PLC).
- Displays the Mark of the designated screen number, set up either directly or indirectly.
- When Mark Access is set to Direct, the mark screen file number is fixed.
- When Mark Access is set to Indirect, the mark screen file number is variable, provided in the given word address.
- The Mark's display attributes, such as color (foreground/background colors and blink ON/OFF) and display size can be set up.
- An offset value for the screen file number can be set up.



The plotting point of a mark image is based on the origin point (0,0) of Mark screens.

Reference *Operation Manual, “3.1 Creating a Mark: the Mark Screen”*

E.g.) Mark image registered in a Mark screen

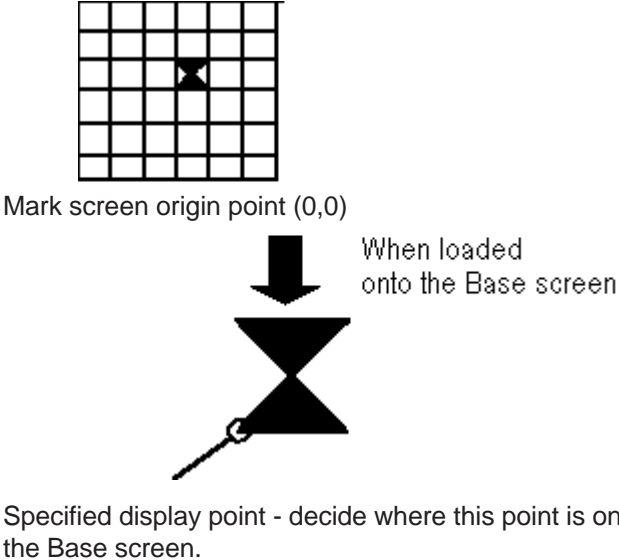

2.16.3 Using M-tags

■ General Info.

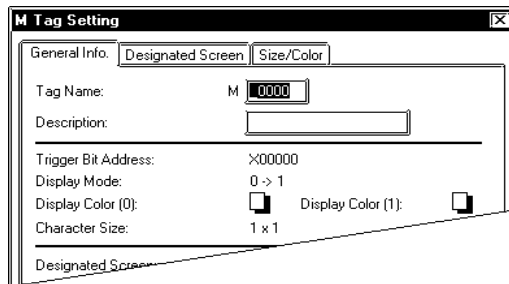

The General Info. page provides information about the current settings for the M-tag.

Tag Name

Must be no more than five Single-byte or two Double-byte characters long and composed of letters and/or symbols.

Description

Up to 20 Single-byte or 10 Double-byte characters can be entered as a description of the tag.

■ Designated Screen/Direct

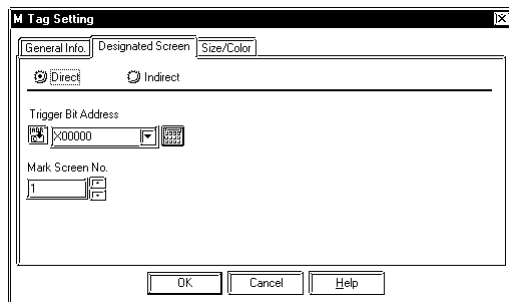

Direct

Select this option to directly designate the Mark screen file number to fix it.

Trigger Bit Address

Defines the address of the bit controlling the display of the Mark.

Mark Screen No.

Set up the Mark screen file number you wish to display.

■ Designated Screen/Indirect

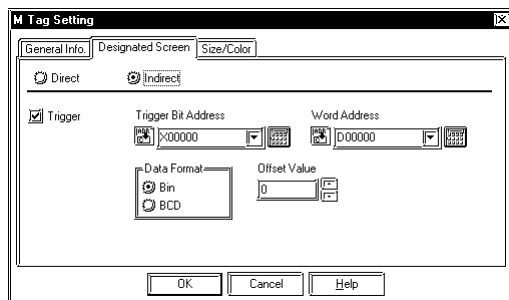

Indirect

Select this option to use variable Mark screen file number. The display Mark changes according to the data change of the designated Word Address.

Trigger Bit Address

Defines the address of the bit controlling the display of the Mark.

Word Address

Defines the word address from which to obtain the Mark screen file number.

Offset Value

Defines an offset value to be added to the data in the Word Address. The resulting value is the screen file number. When the offset is not in use, set up a value of 0.

▼ **Reference** ▲ “2.14.7 Offset Settings”, L-tag

Data Format

Bin

BCD

Defines the format of the data in the Word Address.

■ **Size/Color**

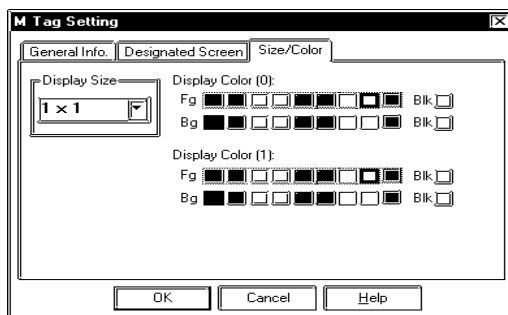

Display Size

The Display Size of Marks can be specified here. With the GP2000 series, the scale ratio can be selected as any integer 1 through 8. With other models, the scale ratio for the display can be selected as either 1, 2, 4 or 8 times. The minimum size for the Mark is 8 × 8 pixels; the maximum size for a Mark is 48 × 48 pixels.

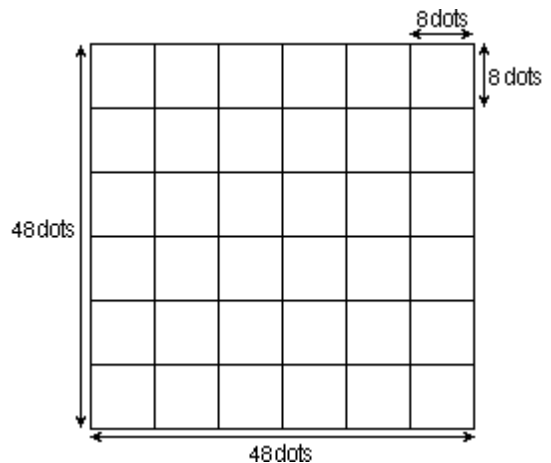

Display Color (0)

Defines the display attributes including foreground color (Fg), background color (Bg), and blink ON/OFF setting (Blk) when the monitor bit value is 0 (OFF), or when using Indirect Data.

Display Color (1)

Defines the display attributes including foreground color (Fg), background color (Bg), and blink ON/OFF setting (Blk) when the monitor bit value is 1 (ON).

▼ **Reference** ▲ “2.1.5 Color Settings”, A-tag

2.16.4 Mark Display Using Indirect Mode

(1) When Indirect Data's selected for the Display Mode

The display of Marks in the same position changes according to changes in the host (PLC) word address screen file number.

Conditions

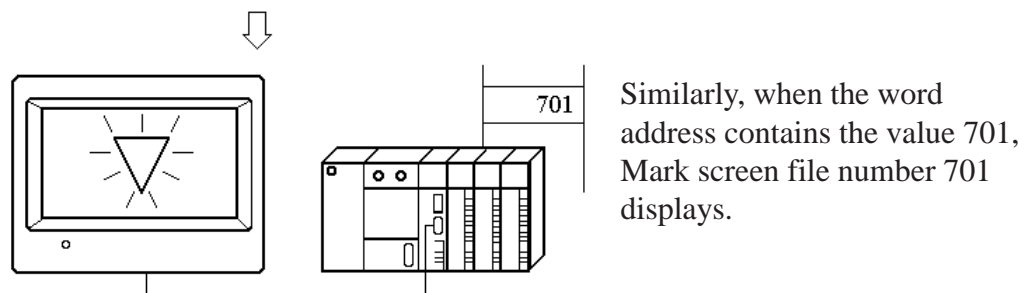
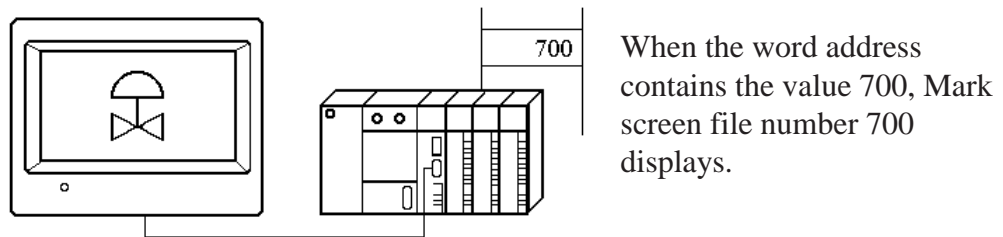
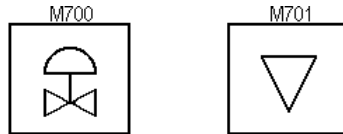

Timing Chart

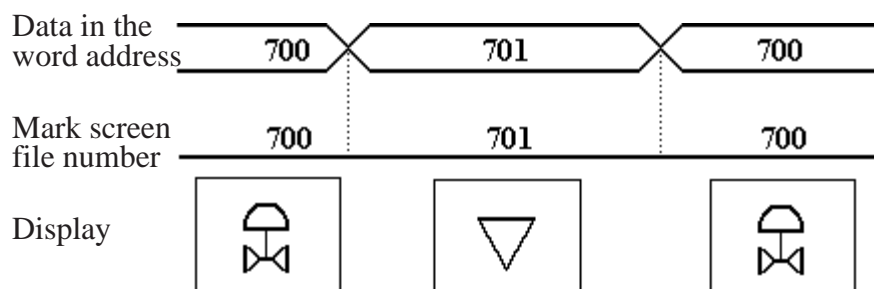

When displaying different size of Mark images with the Mark Access set to Indirect, and if the displaying Mark image is smaller than the previously displayed Mark image, the part where it does not overlap may remain displayed on the screen.

(2) When Indirect is selected for the Mark Access

The display of Marks in the same position, or the display of Marks with different attributes changes according to changes in the host's (PLC's) word address screen file number and bit address.

Conditions

M700

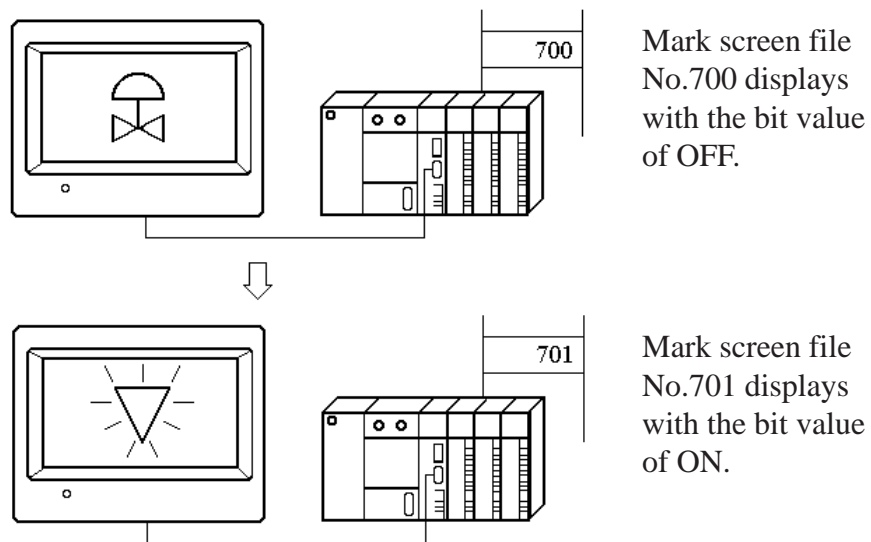
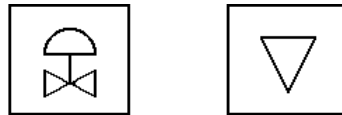

Timing Chart

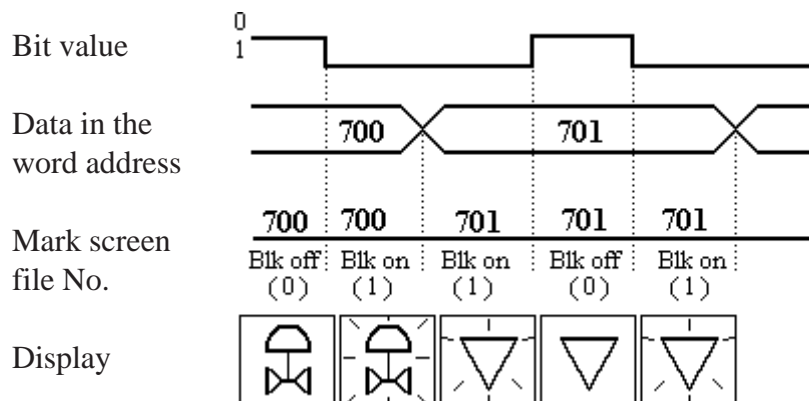

2.17 N-tag (Numeric Display)

2.17.1 Overview

Displays the numeric data in a designated address.

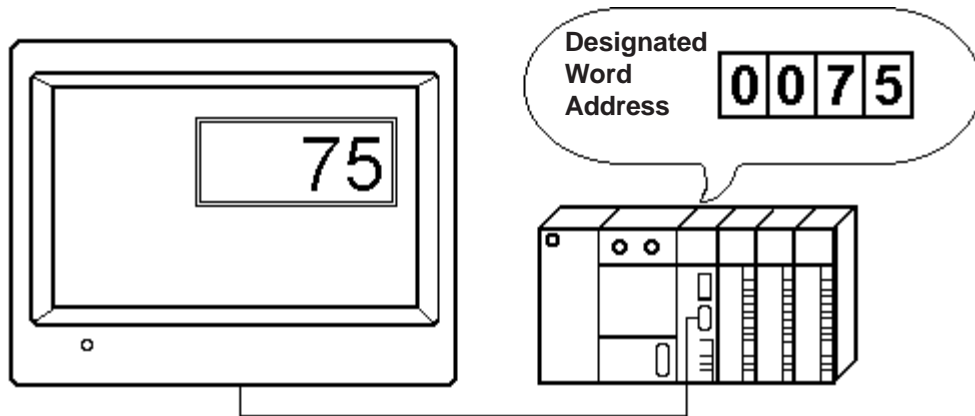

2.17.2 About N-tags

- At a pre-designated position on the screen, N-tags display, in real time, the numeric data of a designated host (PLC) word address.
- The Data Format can be set up as an Absolute or Relative display. When Absolute is selected, the stored host (PLC) data can use either Binary or BCD formats. If Relative is selected, the data must be Binary.
- When using the Relative value display, data read by the host (PLC) responds to the set up input range (valid range) and output range, and automatically converts the display.

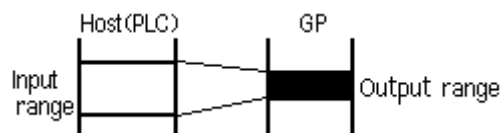

It is possible to remove programs for the compensatory computing of data taken in by the host, when displaying such things as temperature and revolution frequencies.

- With Absolute data, negative values compute using 2's complement. Relative data computes using either 2's complement or MSB Code.
- The decimal point is not included in the Display Digit value.

- An alarm function is available by designating the upper and lower limits of display data.
- For Relative data, an alarm can be activated whenever the data is outside the valid range setup.
- The alarm can use variable values in an Indirect setup. In these cases, the upper and lower limits are stored in the consecutive word addresses immediately following the display data storage word address.

E.g. •32 bit data
 •Designated word address
 for display data = n

n	Display data
n+1	
n+2	Data Max. Value
n+3	
n+4	Data Min. Value
n+5	



Note:

For more about the relationship of high order and lower order Word Address data when using 32 bit data

Reference *Device/PLC Connection Manual, "Supported Devices"*

- The results of an arithmetic operation performed on the storage data can be displayed with the N-tag.
- Character size and display color attributes are adjustable.
- The display styles (Shift Left/Right, Zero Suppress) can be easily set up.
- When the host (PLC) data is 0, the display can be set so that 0 (zero) values will not appear.



N699 is a reserved tag name. Do not use this name.

2.17.3 Using N-tags

■ General Info.

The screenshot shows the 'N Tag Setting' dialog box with the 'General Info.' tab selected. The fields are as follows:

Tag Name:	N 0000
Description:	
Word Address:	D00000
Data Format:	Absolute:Decimal16
Alarm Settings:	Off
Arithmetic Operator:	Off

The General Info. page provides information about the current settings for the N-tag.

Tag Name

Must be no more than five Single-byte or two Double-byte characters long and composed of letters and/or symbols.

Description

Up to 20 Single-byte or 10 Double-byte characters can be entered as a description of the tag.

■ Data Format/Absolute

The screenshot shows the 'N Tag Setting' dialog box with the 'Data Format/Absolute' tab selected. The 'Absolute' radio button is checked. The 'Word Address' is D00000. The 'Data Display Format' section has the following options:

<input type="checkbox"/> Code +/-	<input checked="" type="radio"/> 16 Bit	<input type="radio"/> 32 Bit
	<input checked="" type="radio"/> Decimal	<input type="radio"/> Decimal
	<input type="radio"/> Hex	<input type="radio"/> Hex
	<input type="radio"/> BCD	<input type="radio"/> BCD
	<input type="radio"/> Octal	

Absolute

Select this option to display the data in the Word Address, using the designated Data Format.

Word Address

Defines the word address whose data is used in the display.

Code +/-

Set this up to display negative values. Only available in the Decimal format.

Data Display Format

16- or 32-bit data is available when the Absolute option is selected. Select the data format from Decimal, Hex (hexadecimal), BCD, and Octal. The octal format uses only 16-bit data.



Note: When using 32 bit data, the higher and lower orders of the Word Address change according to the host (PLC) in use.

Reference *Device/PLC Connection Manual, "Supported Devices"*

■ Data Format/Relative

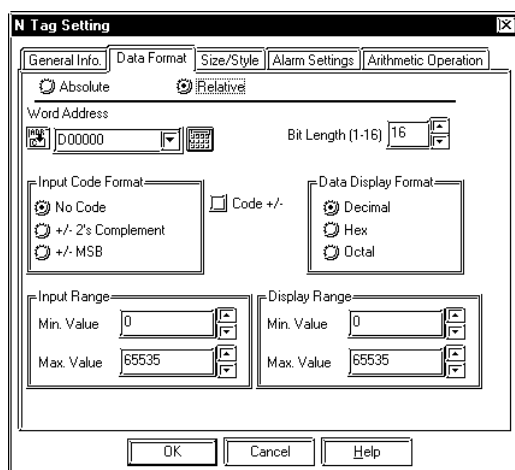

Relative

Select this option to display the numeric value converted from the data in the Word Address in response to the designated Input Range.

Word Address

Defines the address whose data is used in the display.

Bit Length (1-16)

Set up the valid bit length for data stored in the Word Address.

Input Code Format

No Code

Displays positive values only.

+/- 2's Complement

Uses 2's complement to express negative values.

+/- MSB

Uses MSB code system to express negative values.

Code +/-

Select the Code +/- option when handling negative values.

Data Display Format

Decimal

Hex

Octal

The relative data display can use only 16-bit data. Select the data format from Decimal, Hex, and Octal.

Input Range

Min. Value

Max. Value

Defines the range of values stored in the Word Address. The possible ranges depend on the Code Input setting.

Display Range

Min. Value

Max. Value

Defines the range of values displayed in the N-tag. The possible ranges depend on the Display Format and Code +/- settings.

▼Reference▲ “2.17.4 Relative Data Display Settings”, N-tag

< Minimum and Maximum Range Values >

Data Format			Input Range	Display Range
	Code Input	Code +/-		
Dec	No Code	+/-	0 - 65535	-32768 - 32767
		+		0 - 65535
	2's complement	+/-	-32768 - 32767	-32768 - 32767
		+		0 - 65535
	MSB	+/-	-32767 - 32767	-32768 - 32767
		+		0 - 65535
Hex	No Code	/	0 - 65535	0 - FFFF (h)
	2's complement	/		0 - FFFF (h)
	MSB	/	-32767 - 32767	0 - FFFF (h)
Oct	No Code	/	0 - 65535	0 - 177777 (o)
	2's complement	/	-32768 - 32767	0 - 177777 (o)
	MSB	/	-32767 - 32767	0 - 177777 (o)

■ Size/Style

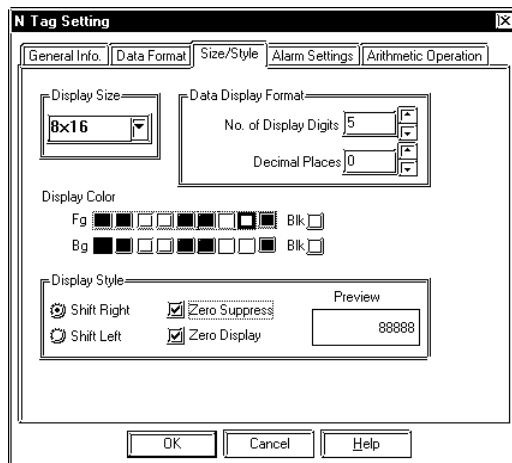
**Display Size**

The Display Size of characters can be specified here. With the GP2000 series, the scale ratio can be selected from integers 1 through 8. With other models, the scale ratio for the display can be selected as either 1, 2, 4 or 8 times. When "Half (h)" mode is selected, only 1, 2, 4 and 8 times are enabled. The basic unit of measurement, "1 x 1" times, is 8 dots by 8 dots in Half mode, and 8 dots by 16 dots in Full mode. "Half" mode is available with GP77R, GP377 and GP2000 series units.

When using Single-byte numerals or symbols, [6 X 10 dot], [8 X 13 dot] and [13 X 23 dot] extended fonts can be used.

**Note:**

Since extended font sizes are fixed, objects containing these characters cannot be enlarged or reduced while pressing down the [Ctrl] key.

Data Display Format**No. of Display Digits**

Defines the number of digits for the display, usually 1 - 11. The length set here includes digits after the decimal point, but not the decimal point.

Decimal Places

Defines the number of digits displayed after the decimal point. This setting is valid only for decimal and BCD formats. You can designate the value from 0 to 10. Set 0 (zero) if not displaying decimals.

Display Color

Defines the display color (Fg), background color (Bg), and blink attributes (Blk). When the Alarm option is selected, think of the color attributes set here as the normal display. When displaying a numeric value using a N-tag on a filled object, set up the background colors the same for both the object and N-tag.

Reference  “2.1.5 Color Settings”, A-tag

Display Style**Shift Left****Shift Right**

Select the display style from the Shift Left and Shift Right. The data will appear, starting from the side designated here. The Shift Right is selected by default.

Zero Suppress

Select this option to omit the leading zeros of display data. E.g. When the Display Length is 4 and the Zero Suppress is NOT selected, 25 appears as 0025.

Zero Display

When this option is clicked, and the host (PLC) data is 0, the value 0 will not display.

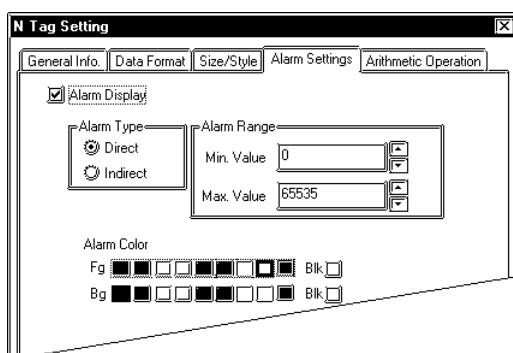
Alarm Settings**Alarm Display**

Select this option to use the Alarm display setting.

Alarm Type**Direct**

Select this option to directly designate the upper and lower limits of alarm values.

Indirect

Select this option to indirectly designate the upper and lower limits of alarm values. The data in the address immediately following the designated Word Address will be the upper limit, and the data in the next address will be the lower limit.

Alarm Range

Min. Value

Max. Value

When the Direct option is selected for Alarm Type, designate the minimum and maximum values here. The possible values depend on the Data Format settings.

Alarm Color

Defines the alarm colors. The display data exceeding the maximum or minimum value appears in the colors designated here.

< Alarm Range >

Data Format			Alarm Range
		Code +/-	
16 Bit	Dec	+/-	-32768 - 32767
		+	0 - 65535
	Hex		0 - FFFF (h)
	Oct		0 - 177777 (o)
	Bin		0 - FFFF (h)
	BCD		0 - 9999
32 Bit	Dec	+/-	-2147483648 - 2147483647
		+	0 - 4894967295
	Hex		0 - FFFFFFFF (h)
	BCD		0 - 99999999

■ Arithmetic Operation

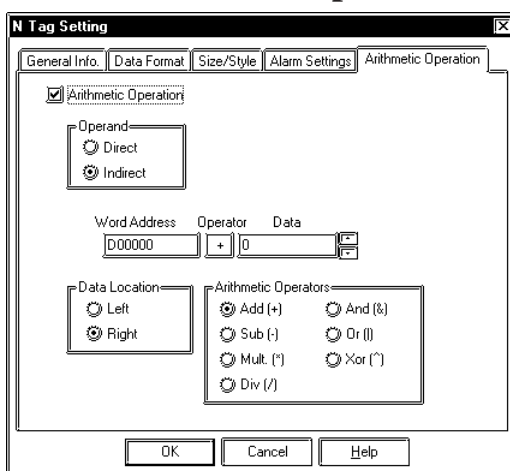

Arithmetic Operation

If this item is selected, an arithmetic operation will be performed to the data retained from the word address, and the resulting data is displayed.

Operand

Direct

Select this option to directly designate a fixed operand.

Indirect

Select this option to indirectly designate the operand. The word address immediately following the designated Word Address is automatically used as the data storage address.

Data

If the Operand has been set to Direct, designate the operand here.

Data Location

Left

Right

Select the data location from Left and Right.

Arithmetic Operators

Select the operator.



- The arithmetic Operator is enabled when the Data Format is set to Absolute, and the Alarm option is not selected.
- Any overflowing digits resulting from arithmetic operations are ignored.
When the data format is set to Hex and 16 bits:
The result of arithmetic operation "FFFF(h) + 1" is displayed as "0000(h)".
- If a division operation results in a remainder, a slight error may occur in the measurement as a result of the rounding-up operation.

2.17.4 Relative Data Display Settings

■ Procedure

- The range for data stored in the host (PLC) [A]: 0 - 65535

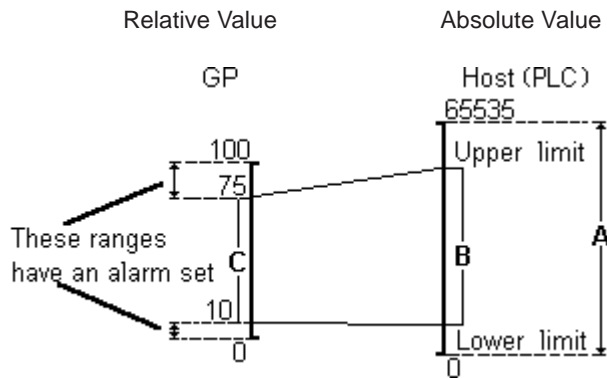

(1) Displays the range [A] as a percentage. Data in the 10 - 75% [B] range is displayed as normal data, and data outside this range is displayed in alarm mode.

< The setup on GP-PRO/PBIII >

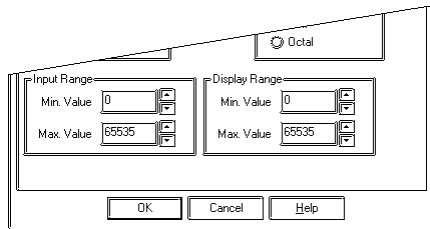

- Input Range Set the minimum and maximum values for the range [B].
- Display Range .. Set the minimum and maximum values for the range [C].

(2) The Calculation of [B] value
The [A] range 0 - 65535 is converted into a percentage, 0-100%.

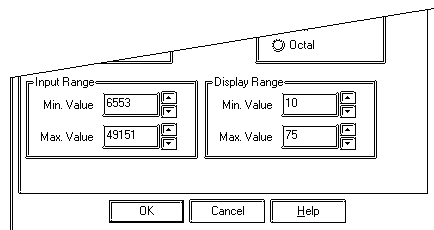

$$[B] \text{ Upper limit } (X_1) 100:75=65535:X_1$$

$$X_1=49151.25$$

$$=49151$$

$$[B] \text{ Lower limit } (X_2) 100:10=65535:X_2$$

$$X_2=6553.5$$

$$=6553$$

Therefore, the setting will be...

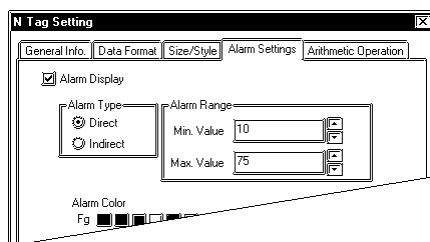

(3) Also, if the Alarm option is selected, the value for range [C] is automatically set.



2.18 n-tag (Alarm Range Display)

2.18.1 Overview

Displays the upper and lower limits of an alarm range set by K-tags.

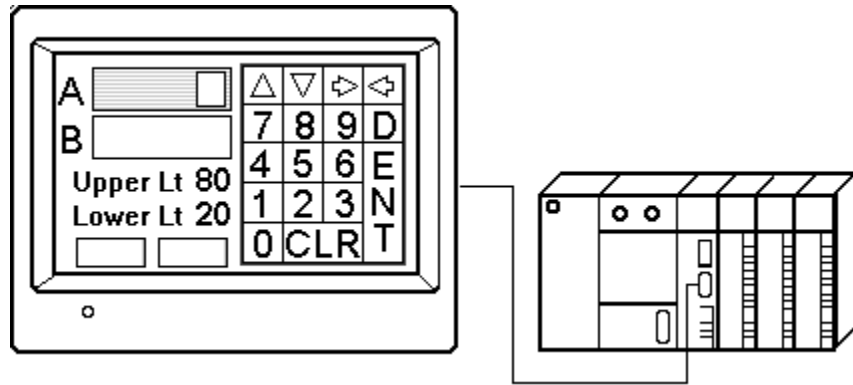

Set up the Touch Keyboard with k-tags.

2.18.2 About n-tags

- With trigger bit activated, if the K-tag awaiting input has had alarm set, the n-tag displays the alarm's upper and lower limits on the screen using the data formats set for the K-tag. Display style also follows K-tag settings.

Reference “2.12 K-tag (Key Input)”

- When “K-tag awaiting input” does not have alarm set, or there is no “K-tag awaiting input,” the n-tag will display a space.

Reference “2.12 K-tag (Key Input)”

- Different color attributes can be set for the alarm range's maximum and minimum value displays.
- The character size for the upper and lower limit displays is adjustable, however the same size must be used for both.



Note: When the maximum and minimum values of the alarm range designated for the K-tag exceed the number of display digits, the values are displayed within the n-tag display's digit limits.

E.g.

	K-tag Setting		n-tag Setting
Alarm Range	Min. -30000	→	Min. -999
	Max. 30000	→	Max. 999

No. of display digits 3

2.18.3 Using n-tags

■ General Info.

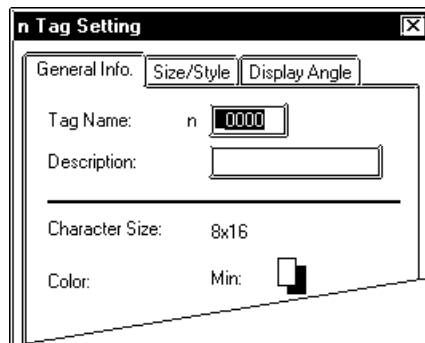

■ Size/Style

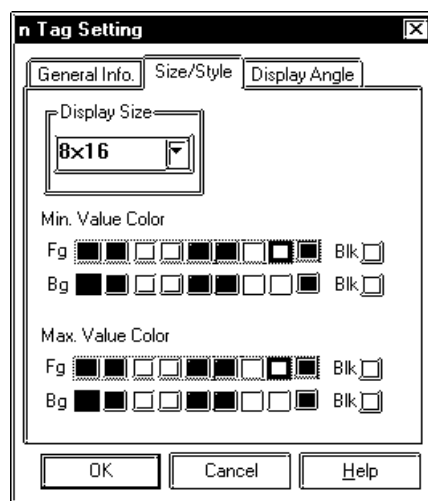

The General Info. page provides information about the current settings for the n-tag.

Tag Name

Must be no more than five Single-byte or two Double-byte characters long and composed of letters and/or symbols.

Description

Up to 20 Single-byte or 10 Double-byte characters can be entered as a description of the tag.

Display Size

The Display Size of characters can be specified here. With the GP2000 series, the scale ratio can be selected from integers 1 through 8. With other models, the scale ratio for the display can be selected from 1, 2, 4, and 8 times. The basic unit of measurement, "1 x 1" times, is a character measuring 16 dots by 16 dots.

16 dots



16 dots

<Double-byte Character>

When using Single-byte numerals or symbols, [6 X 10 dot], [8 X 13 dot] and [13 X 23 dot] extended fonts can be used.



Note:

Since extended font sizes are fixed, objects containing these characters cannot be enlarged or reduced while pressing down the [Ctrl] key.

Min. Value Color

Defines the foreground and background colors and blink attributes for the alarm's lower limit display. When displaying numeric values using the n-tag on a filled object, set the background color (Bg) of the n-tag display the same as the fill color.

Max. Value Color

Defines the foreground and background colors and blink attributes for the alarm's upper limit display.

▶ **Reference** ◀ "2.1.5 Color Settings", A-tag

■ Display Angle

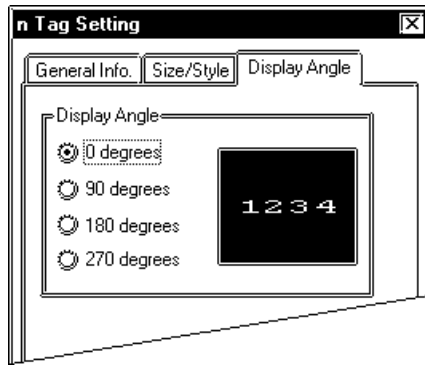

Display Angle

Set up the rotation for the display. Select 0 (zero), 90, 180, or 270 degrees.



2.19 P-tag (Numeric Display in Pre-designated Format)

2.19.1 Overview

Displays numeric data in a pre-designated format.

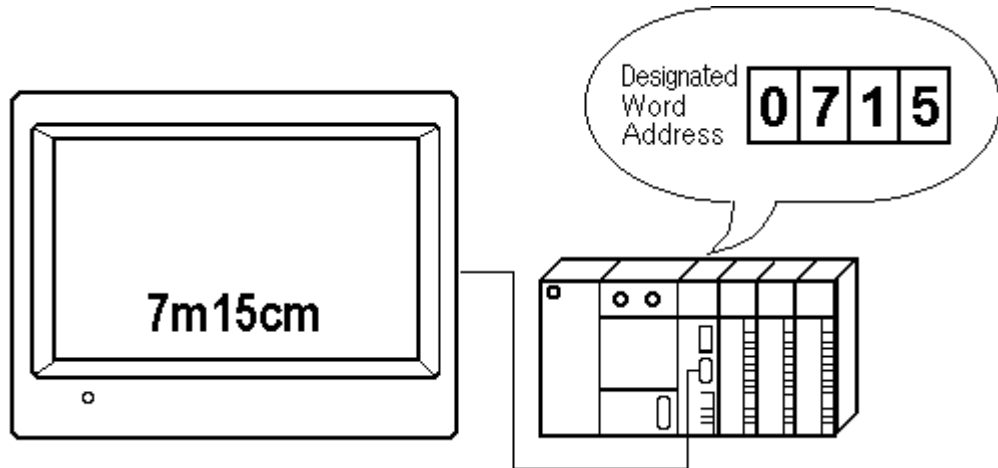

* You can set the format whereby unit symbols are inserted between the data.

2.19.2 About P-tags

- Displays the designated word address data as an absolute value, in real-time, using a pre-designated format.
- The host (PLC) word address data can be either the Binary or BCD format.
- Negative data uses the 2's complement format.
- You may display only necessary data units by truncating nonessential data fractions. For example, with data using decimal places, you can truncate the decimal values and display only integers.
- An alarm function is available by defining the upper and lower numerical limits of the data. Both numbers and characters (pre-designated format) will display using the attributes set for the alarm.

- The alarm range can also be designated as variable, where the upper and lower limits are obtained indirectly. For this setting, the maximum and minimum values are stored in consecutive addresses following the designated Word Address.

E.g.

- 32 bit data
- Display data Word Address = n

n	Display data
n+1	
n+2	Upper limit
n+3	
n+4	Lower limit
n+5	



Note: For more about the relationship of high and low order word address data when the 32-bit data is used

Reference *Device/PLC Connection Manual, "Supported Devices"*

- The display size and color attributes are adjustable.
- For display style, Shift Left/Right and Zero Suppress can be set up.

2.19.3 Using P-tags

■ General Info.

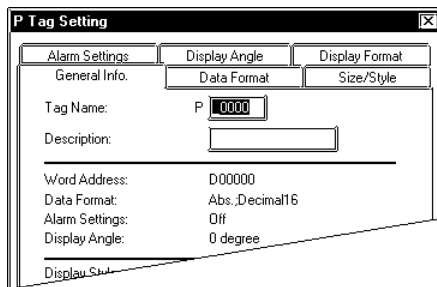

The General Info. page provides information about the current settings for the P-tag.

Tag Name

Must be no more than five Single-byte or two Double-byte characters long and composed of letters and/or symbols.

Description

Up to 20 Single-byte or 10 Double-byte characters can be entered as a description of the tag.

■ Data Format

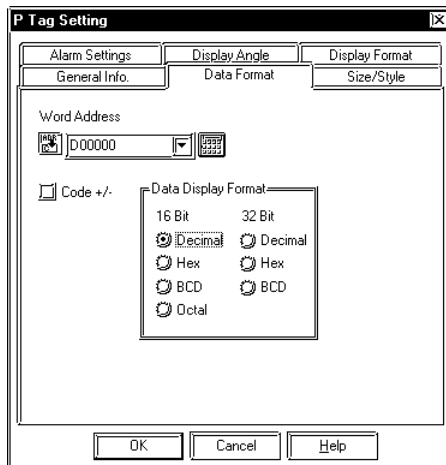

Word Address

Defines the address whose data appears in the P-tag display.

Code +/-

Code +/-, only available for Decimal data, is used when handling negative values.

Data Display Format

Defines the format of the data stored in the host (PLC). Data is displayed in absolute values and 16 or 32 bit data can be used for this purpose. Select the base number: Decimal, Hex (hexadecimal), BCD, or Octal. Only 16-bit data is available for the Octal format.



Note: When using 32 bit data, the high and low order of word data depends on the host (PLC) in use.

Reference *Device/PLC Connection Manual, "Supported Devices"*

■ Size/Style

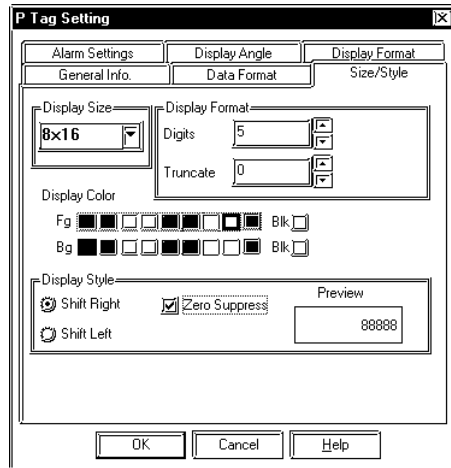

Display Size

The Display Size of characters can be specified here. With the GP2000 series, the scale ratio can be selected from integers 1 through 8. With other models, the scale ratio for the display can be selected from 1, 2, 4, and 8 times. The basic unit of measurement, "1 x 1" times, is a character measuring 16 dots by 16 dots.



<Double-byte Character>

When using Single-byte numerals or symbols, [6 X 10 dot], [8 X 13 dot] and [13 X 23 dot] extended fonts can be used.



Note:

Since extended font sizes are fixed, objects containing these characters cannot be enlarged or reduced while pressing the [Ctrl] key.

Display Format

Digits

Defines the number of digits for the display, 1 - 11, including decimal fractions (except the decimal point).

Truncate

Sets the Truncate when only necessary parts of the data is to be displayed by truncating unnecessary data fractions. This field can only be set when the data format is Decimal or BCD. Designate how many digits to truncate (zero - 10). When there are no digits to truncate, set a value of zero.

Display Color

Defines the foreground color (Fg), background color (Bg), and blink attributes (Blk). These color attribute settings are for normal display when the Alarm function is selected. When displaying numbers and text on a filled image using the P-tag, set the Bg color the same as the fill.

Reference "2.1.5 Color Settings", A-tag

Display Style

Shift Left

Shift Right

Displays the data in the selected alignment.

Zero Suppress

When this check box is not checked, zeros are added to the front of numbers to match the Display Length. (E.g., When the “Display Length” is 4 and “Zero Suppress” is OFF, value 25 will appear as 0025.)

■ **Alarm Setting**

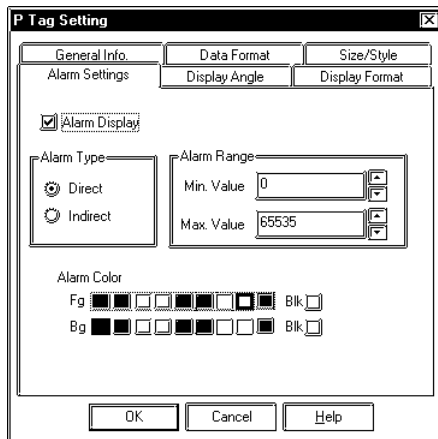

Alarm Display

Turn this option ON to display the alarm display.

Alarm Type

Direct

Defines the upper and lower limits for the alarm range.

Indirect

When this option is selected, the upper and lower limits are stored in the consecutive word addresses following the set Word Address.

Alarm Range

Min. Value

Max. Value

When the Indirect is not set for the Alarm Type, set the alarm minimum and maximum values here. The possible setup range changes according to the Data Format.

Alarm Color

If the data exceeds the alarm range, the Alarm display appears in the designated colors.

<Alarm Range>

Data Format			Alarm Range
		Code +/-	
16 Bit	Dec	+/-	- 32768 - 32767
		+	0 - 65535
	Hex		0 - FFFF (h)
	Oct		0 - 177777 (o)
	Bin		0 - FFFF (h)
	BCD		0 - 9999
32 Bit	Dec	+/-	- 2147483648 - 2147483647
		+	0 - 4894967295
	Hex		0 - FFFFFFFF (h)
	BCD		0 - 99999999

■ Display Angle

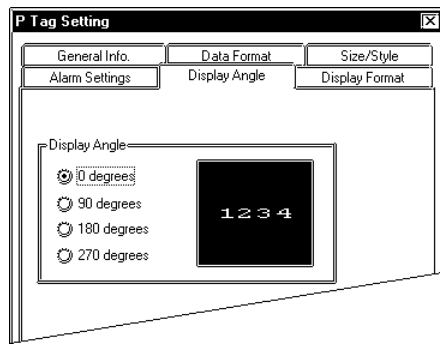

Display Angle

Set up the rotation for the display. Select one from 0 (zero), 90, 180, and 270 degrees.

■ Display Format

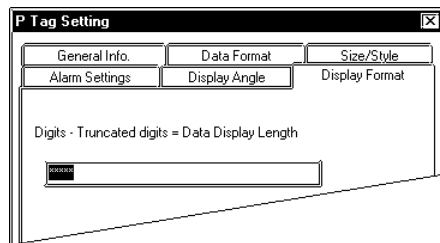

Digits - Truncated digits = Data Display Length

Set up the pre-designated display format. Set up the data display portions with the asterisk “*,” and the text as desired, which together must not exceed 80 characters. The numeric value displays in the asterisks from the lowest position.

2.19.4 P-tag Example Settings

<Example 1>

Display Length = 4

Truncate = 0

Display Style = Shift Right, Zero Suppress ON

Display Format = ** Hour(s) ** Minute(s)

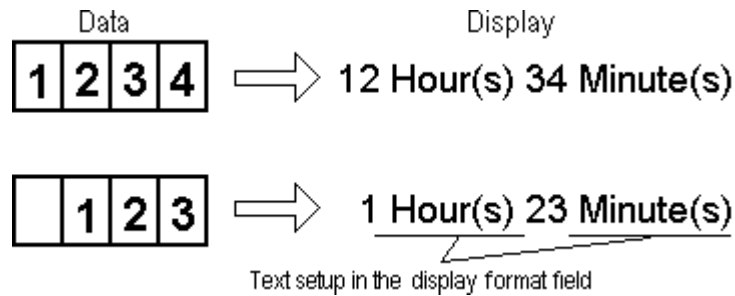

<Example 2>

Display Length = 6

Truncate = 2

Display Style = Shift Right, Zero Suppress OFF

Display Format = ***Kg*00g

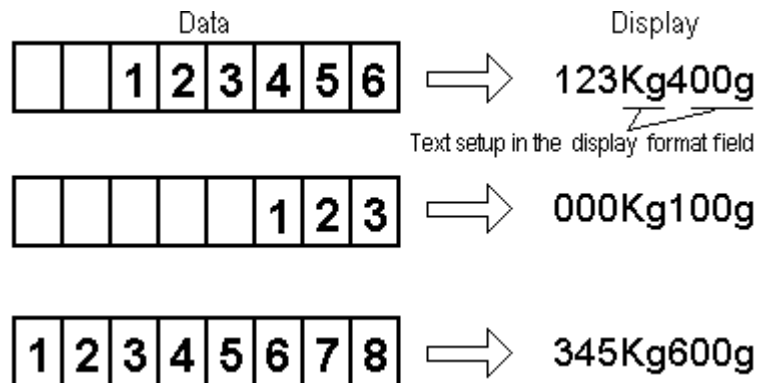

Data is entered from the lowest asterisk (*) field position.

However, “Truncate” is set to 2, so data, starting from the 3rd left-side digit will be entered.



2.20 Q-tag (Alarm Summary Display)

2.20.1 Overview

Displays Alarm messages registered in the Alarm Editor in historical order, and in response to host (PLC) bit changes. The message display uses three processes listed:

- Displays only currently triggered alarms. (Active)
- Displays messages in the order they were triggered and displays the time they were triggered, acknowledged, and recovered. (History)
- Displays the time and message whenever the alarm message is triggered, acknowledged, and recovered. (Log)

When used together with a T-tag, cursor movement, acknowledgment, and clearing (delete all) are possible.

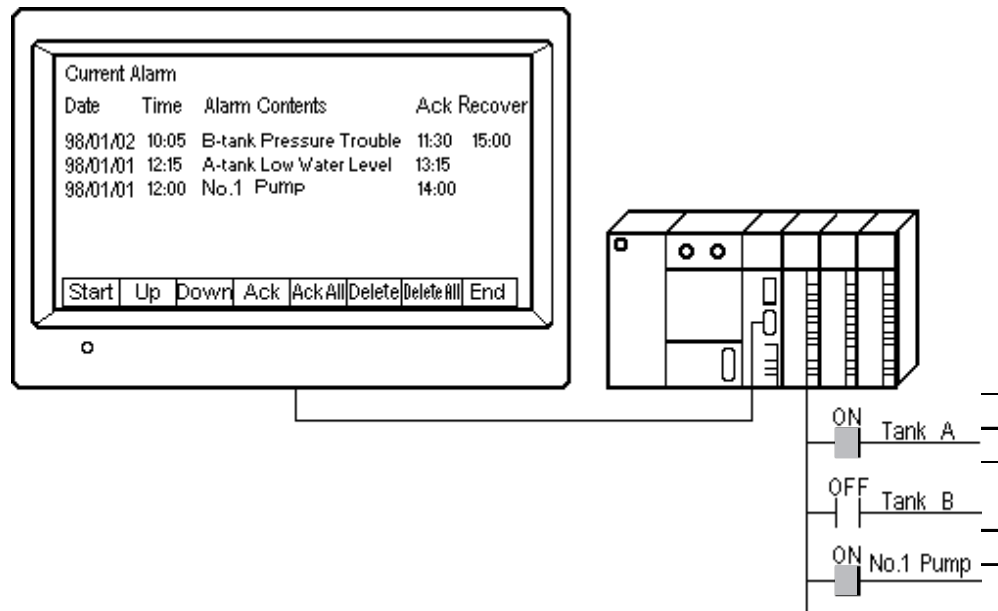

2.20.2 About Q-tags

- To create an Alarm Summary display using the Q-tag, use the following procedures.
 1. Registering an Alarm message using the Alarm Editor
 2. Q-tag setting using the GP system settings
 3. Creating the Q-tag on a Base screen
- Register all the messages with the Alarm Editor.

▼ **Reference** ▲ *Operation Manual, "5.1 Alarm Creation and Editing"*

- The distance from the left margin to the left side of each data field (Date, Message, etc.) can be set in the GP system settings. In that case, that display format can be set as a common format for all screens where Q-tags have been set up. Also, a format can be set up for each Q-tag.
- Control of the alarm is possible using bit (bit log) or word (word log) data.
- Alarm messages can be controlled for each block. For example, a group of alarm messages for serious problems and a group of alarm messages for minor problems can be displayed as blocks. Up to 3 blocks can be set up. To designate a block to be displayed, use the Alarm Editor. This setting is valid only for the GP77R, GP377 and GP2000 series.

▼Reference▲ *Operation Manual, “5.1 Alarm Creation and Editing”*

- Setup whether the message is activated when the monitor bit changes 1→0, or 0→1. The alarm that has been triggered is recovered when the bit changes back to its original state.
- An alarm triggers when the data in the monitor word address equals the alarm value set up in the Alarm Editor. The alarm recovers when the word address data does not equal the alarm value.
- The total number of registered messages in ACTIVE, HISTORY and LOG in the Extended Function Settings/Q-tag Settings in the GP System Settings is limited to 768. The number of alarms stored in the backup SRAM depends on the settings. When the number of alarms exceeds the settings, overflowing alarms are deleted, beginning with the oldest.
- The maximum number of bit log alarm and word log alarm messages that can be registered depends on the GP model.

GP Type	Max. No. of Messages
GP-270, GP-H70, GP-370	512
All other GP70 Series, GP77R Series	768
GP2000 Series	2048

When all monitor devices are registered to word addresses, make sure that these word addresses are within 256 words.

- The group number can be set up with the alarm editor. The maximum group number is the maximum number of registered messages. For the GP2000 series, 6096 is the maximum group number (this is the maximum value of the continuous LS area available to the user). Be sure to use an LS area that is the same as that used by the group number.
- The maximum number of characters and rows per screen depends on the GP type and Display Size (character size).

▼Reference▲ *“About A-tags / Max. No. of Characters and Lines”, A-tag*

- Both Display Size and color attributes for the Trigger, Acknowledge, Error Clear, and Erase are available.

- Date and Time display formats can be selected.
- When used with T-tags, Start, Up, Down, Ack, Ack All, Delete, Delete All, End, and Sub-screen Display operations are possible.

▼Reference▲ *T-tag (Touch Panel Input)*

■ Display Format “Active,” Scroll Direction “Down”

<Display Example>

Alarm Order : Level 1 Point closed → A-Tank Low Water Level
→ B-Tank Pressure Trouble

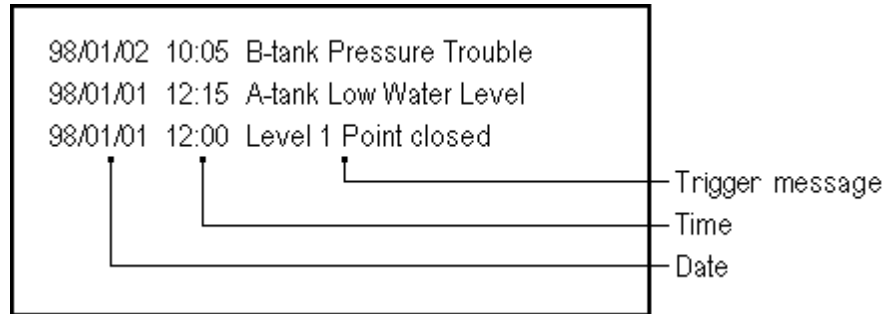

■ Display Format “History,” Scroll Direction “Down”

<Display Example>

Alarm Order : Level 1 Point closed → A-Tank Low Water Level
→ B-Tank Pressure Trouble

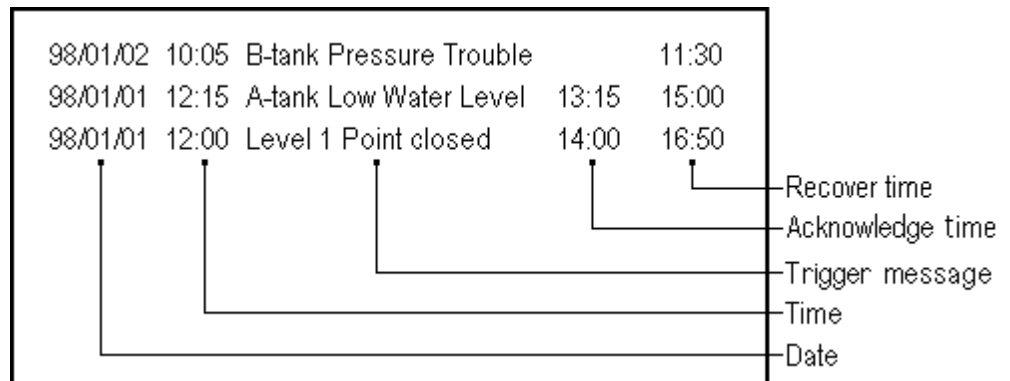

■ Display Format “Log,” Scroll Direction “Down”

<Display Example>

Alarm Order : Level 1 Point closed → A-Tank Low Water Level
→B-Tank Pressure Trouble

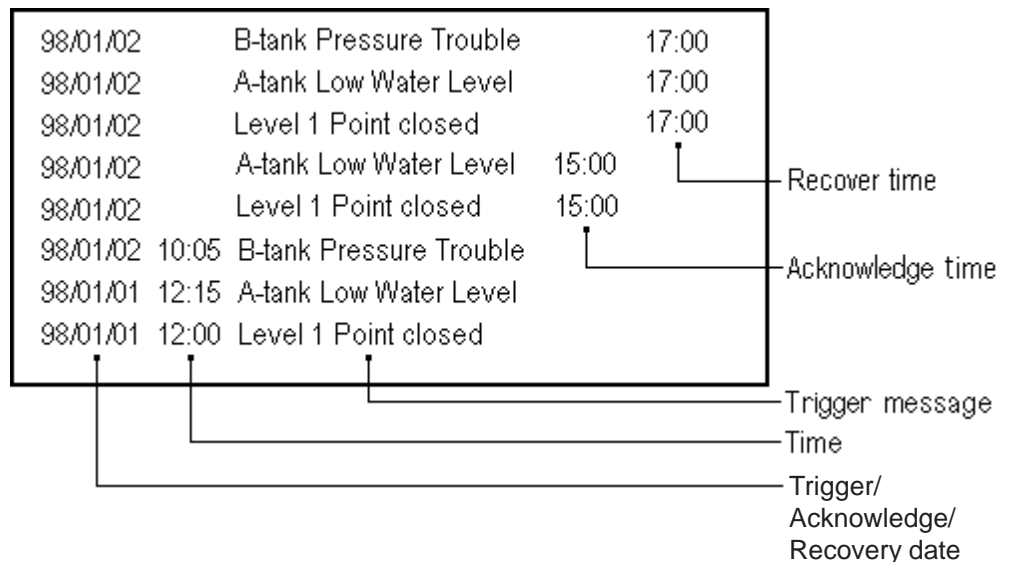



Note: The date and time of the Trigger/Acknowledge/Recovery of the alarm can be displayed only when the "Log" option is selected on a GP2000 Series unit.

Reference "2.20.9 GP System Area Q-tag settings."

■ When Not Selecting a Block via Alarm Creation and Editing

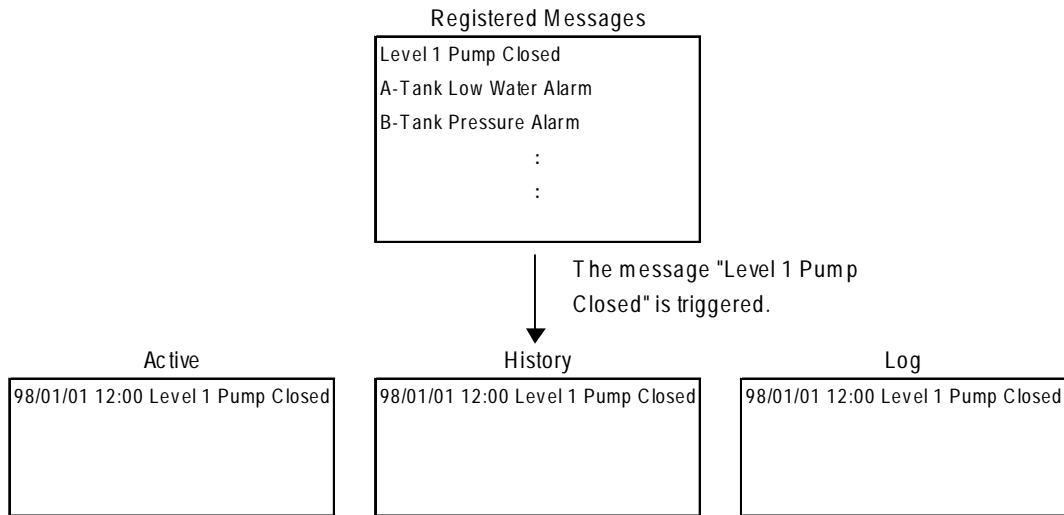

When the alarm message “Level 1 Point closed” is triggered, it is displayed according to Display Mode’s settings (active, history, log) of each Q-tag.

■ When Selecting a Block via Alarm Creation and Editing

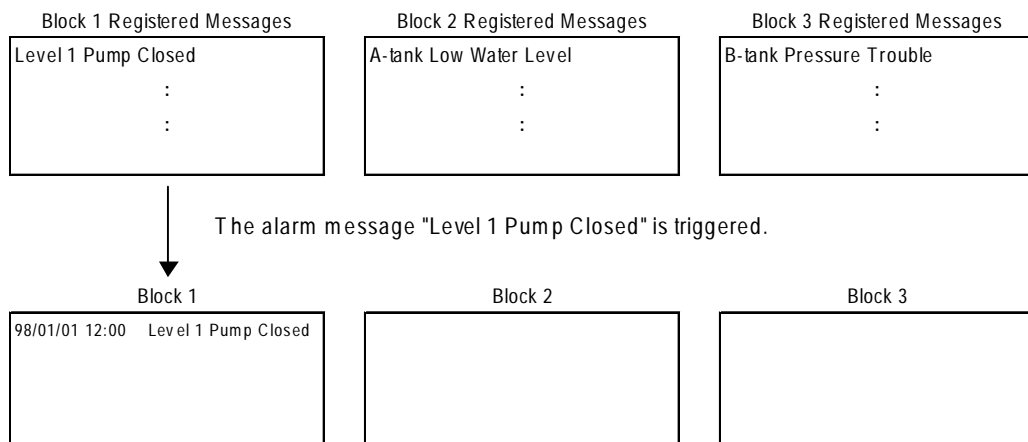

When the alarm message “Level 1 Point closed” is triggered, according to Display Mode settings (Block 1, Block 2, Block 3) of the Q-tag, the alarm message is displayed for the applicable tag. When the alarm message is triggered, it is stored in Block 1.

- The Q Tag Display Format such as the message position, trigger time position, and so on can also be set up in the GP-PRO/PBIII GP system settings .

Reference “2.20.4 “Using Q-tags ■ Display Format

Reference “ 2.20.9 GP System Area Q-tag settings ”, Q-tag

- Detailed information such as how to recover from an error can be displayed as sub-screens by selecting an Alarm message.
- The sub-screen display can be used for screen changes, library display (L-tag), text display (X-tag) or window display.

2.20.3 Q-tag Restrictions

- ◆ If the message does not fit into the setup display area, the text that does not fit will not display.
- ◆ In order to use the Q-tag select key (special T-tag key), only 1 Q-tag should be used per screen.

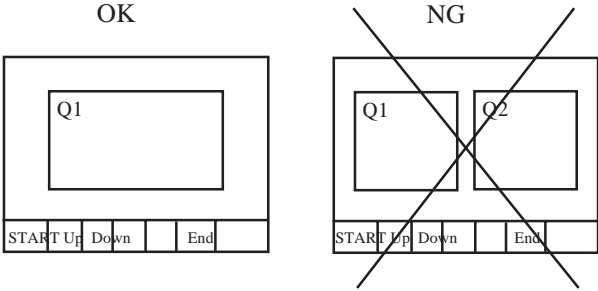

- ◆ Set the Q-tag select keys to the same screen that the Q-tag is set to. They cannot be used if they are set to a screen that the Q-tag is not set to.

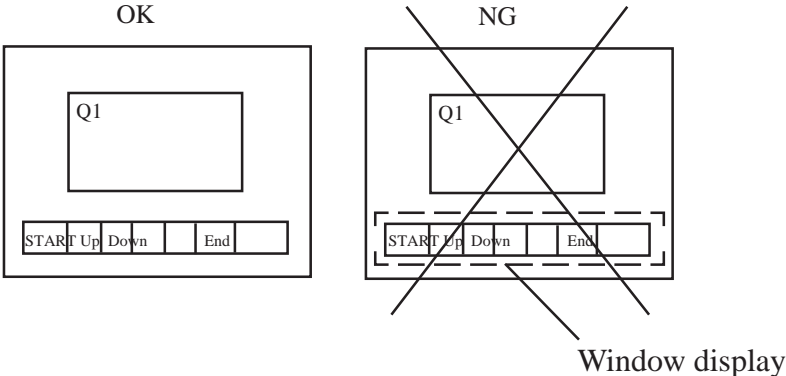

2.20.4 Using Q-tags

General Info.

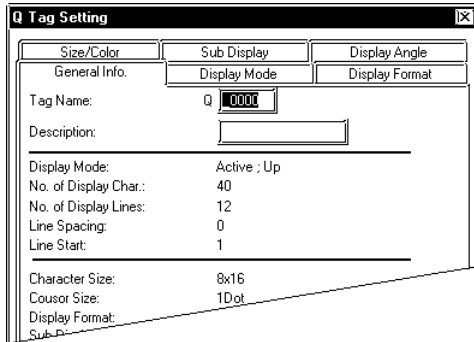

The General Info. page provides information about the current settings for the Q-tag.

Tag Name

Must be no more than five Single-byte or two Double-byte characters long and composed of letters and/or symbols.

Description

Up to 20 Single-byte or 10 Double-byte characters can be entered as a description of the tag.

Display Mode

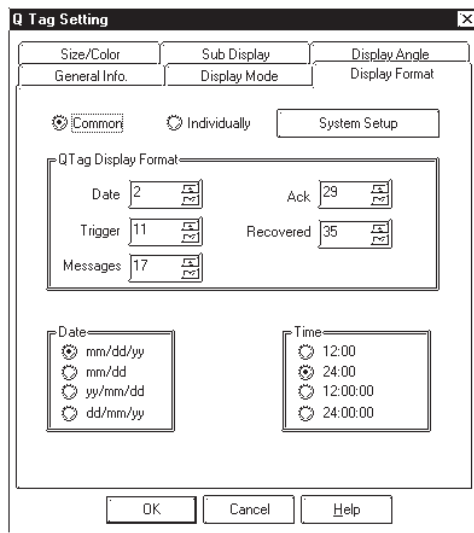

Display Mode

Select the display format: Active, History, or Log. When a block is selected via the Alarm Editor, select Blocks 1, 2, and 3. Alarm messages' block registration is supported only by GP77R, GP377 and GP2000 series units.

Scroll Direction

Up

Down

Select the scroll direction: Up or Down. E.g.) Alarm Order: AAA→BBB→CCC

- When Scroll = Up

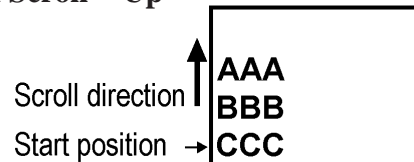

- When Scroll = Down

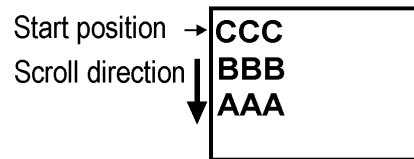

Displayed when a block is selected via Alarm Creation and Editing.

Display Mode

No. of Display Char.

Designates the maximum half character display length available for each Alarm message.

Display Start Line

Designates the display start line. With this setting, when a number of Alarm messages are issued, they can be viewed for each Q-tag without scrolling the screens.

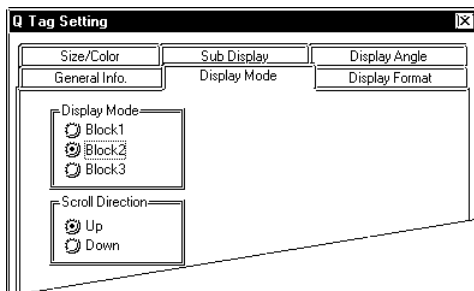



Note:

The numbers of characters and lines that can be displayed per screen will vary depending on the GP panel size, installation orientation, and character size.

Reference “2.1.2 About A-tags / Max. No. of Characters and Lines”, A-tag

■ Display Format

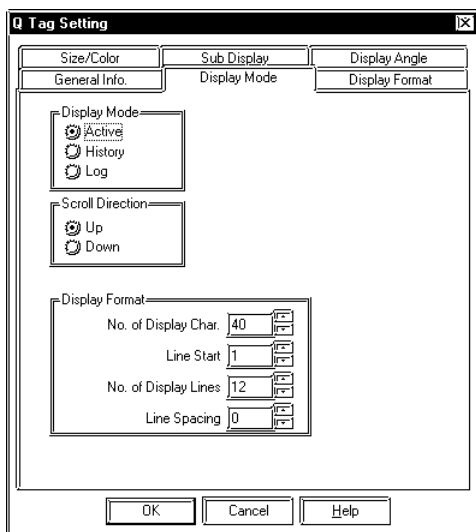

No. of Display Lines

Designates the number of rows for the Alarm Summary display on one screen.

Line Spacing

Set up the spacing (0 - 7) between each alarm message, in dot units.

A_I Up to 7 dots
A

Common

Select this option to display a message in a display format common for the all tags in the single project. In this case, the Q-tag display format is specified in “GP System Settings”.

Reference “2.20.9 GP System Area Q-tag settings”

Individually

Select this option to designate a display format for each Q-tag. However, GP-270 does not have this setting.

System Settings

Pressing the button displays the "Extended Feature Settings/Q-tag Settings" dialog box in "GP System Settings."

Reference “2.20.9 GP System Area Q-tag settings”

Q-Tag Display Format

Date

Trigger

Messages

Ack

Recovered

The distance from the Alarm Summary display area’s left end is specified in the half-character (8-dot) unit. When “0” is specified, that item will not be displayed. GP-270 does not have this setting.

Reference “2.20.9 GP System Area Q-tag settings”

Date

Specifies the date display format.

Time

Specifies the time display format.
 “12:00” and “24:00” designate the display format of hour and minute.
 “12:00:00” and “24:00:00” designate the display format of hour, minute, and second.

■ **Size / Color**

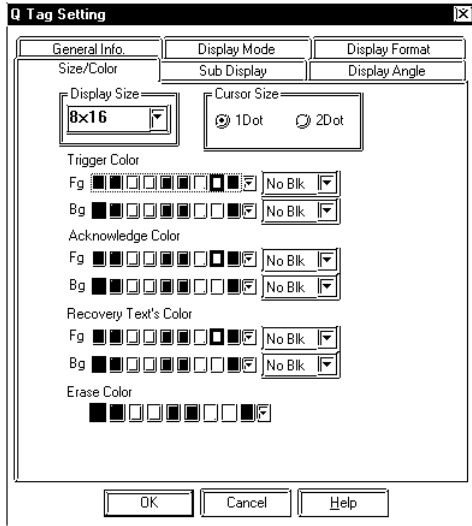

Display Size

The Display Size of characters can be specified here. With the GP2000 series, the scale ratio can be selected from integers 1 through 8. With other models, the scale ratio for the display can be selected from 1, 2, 4, and 8 times. The basic unit of measurement, "1 x 1" times, is a character measuring 16 dots by 16 dots.



<Double-byte Character>

When using Single-byte numerals or symbols, [6 X 10 dot], [8 X 13 dot] and [13 X 23 dot] extended fonts can be used.



Note: Since extended font sizes are fixed, objects containing these characters cannot be enlarged or reduced while pressing down the [Ctrl] key.

Cursor Size

Designates the cursor line thickness.

Trigger Color

Defines the foreground color (Fg), background color (Bg), and blink attributes (Blk) for when the alarm is triggered.

Acknowledge Color

Defines the foreground color (Fg), background color (Bg), and blink attributes (Blk) for when the alarm is acknowledged.

Recovery Text's Color

Defines the foreground color (Fg), background color (Bg), and blink attributes (Blk) for when the alarm is recovered.

Erase Color

Defines the color attributes for areas where messages are not displayed. If the GP screen is monochrome, this should be set black.

Reference “2.1.5 Color Settings”, A-tag



Note: The recovered message remains Error Clear Color even if the Ack key is pressed.

■ Sub Display

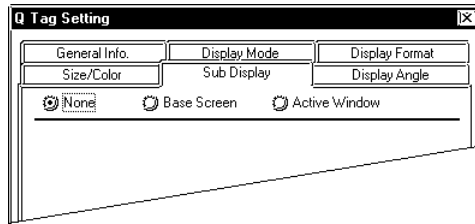

None

This setting turns the Sub Display feature OFF.

Base Screen

This setting turns the display of a Base screen Sub Display ON. Also, it can be used to change the screen's display.

* The GP-270 does not support this function.

Active Window

This setting turns the Window-Display feature ON and turns the Window Sub Display feature ON.

* The GP-270 does not support this function.



- **The GP-270 does not support the Sub Display feature.**
- **When you enter the Word Address of an X-tag to use in a Sub Display, the Word Address of L-tags or the Word Address of Window control, you can use only an LS area address.**

■ Sub Display / Base Screen

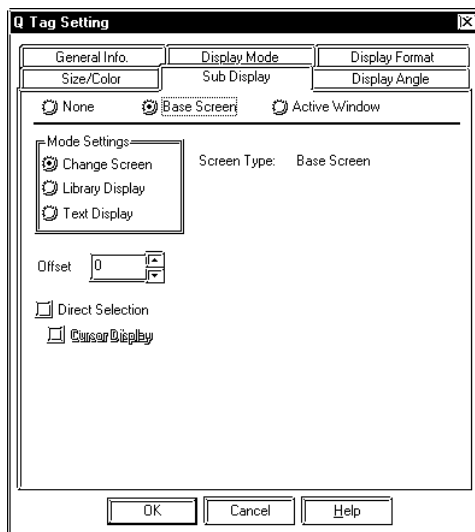

Base Screen

Mode Settings

Change Screen

Changes the display screen to another screen. (Same as the normal screen change operation.)

Changes the display screen to the Sub Display screen No. set in the Alarm Creation and Editing area.

Library Display

Displays a library screen (Base screen) as a Sub Screen at the location set by the L-tag.

Text Display

A Sub Screen of text data (Text screen) will display at the location set by the X-tag.

Offset

Defines an offset value to be added to a Mark's Word Address data. When Offset is not used, enter a value of zero. For further information, **Reference** "2.14.7 Offset Settings", L-tag

Direct Selection

Select this option when you will touch and select a message on the display, and use the Sub Display feature.

Cursor Display

Select this option when displaying a cursor in the selected message, using Direct Selection. After the display cursor appears in the selected message you can check the message’s contents.



- **To use the Library Display feature, you must place an L-tag on the same screen as the Q-tag. The L-tag Designated Screen area’s settings should be set to “Indirect” and the “Data Format” to “Bin”.**
- **To use the Text Display feature, you must place an X-tag on the same screen as the Q-tag. The X-tag Designated Screen area’s settings should be set to “Indirect” and the “Data Format” to “Bin”.**

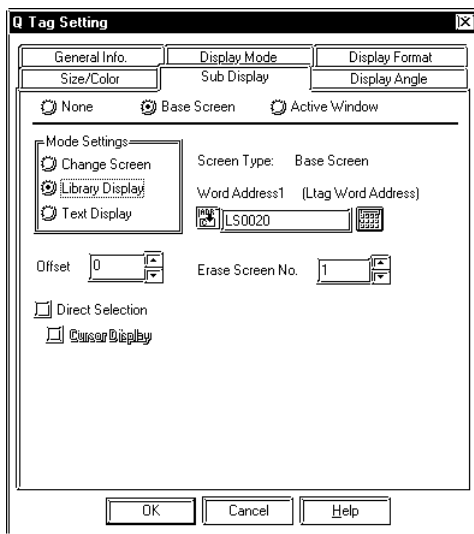

Base Screen

Mode Settings

Library Display

Word Address 1 (L-tag Word Address)

Defines the Word Address used as the L-tag’s Base screen No. address. The Sub Display screen No. used in the Alarm Creation and Editing area is treated as the Library screen No.

Erase Screen No.

When a message in the Alarm Creation and Editing area is selected whose Sub Screen No. setting is “0”, the base screen called by this feature will delete the previous display screen. Create a Base screen for erasing by making a black, filled rectangle.

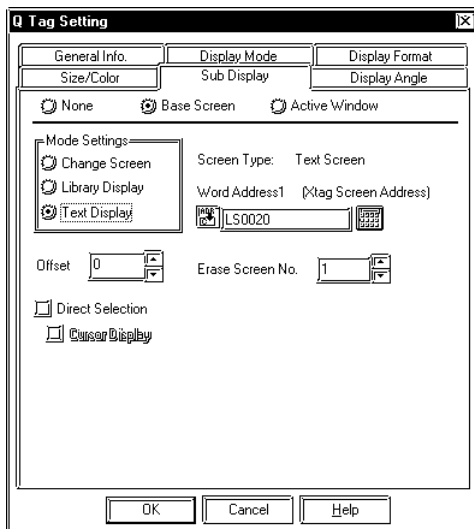

Base Screen

Mode Settings

Text Display

Word Address 1 (X-tag Screen Address)

Defines the Word Address to be used as the X-tag’s Text screen No. address. The Sub Display screen No. used in the Alarm Creation and Editing area is treated as the Text Screen No.

Erase Screen No.

When a message in the Alarm Creation and Editing area is selected whose Sub Screen No. setting is “0”, the base screen called by this feature will delete the previous display screen. Create a Base screen for erasing by making a black, filled rectangle.

■ Sub Display / Active Window

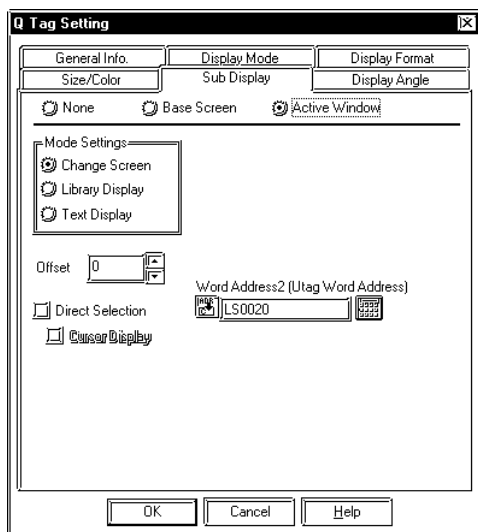

Active Window Mode Settings

Change Screen

This settings turns the Window-Display feature ON. The Sub Display screen No. used in the Alarm Creation and Editing area is treated as the Window screen No.

Library Display

Displays a library screen (Base screen) as a Sub Screen at the location set by the L-tag.

Text Display

A Sub Screen of text data (Text screen) will display at the location set by the X-tag.

Word Address2 (Utag Word Address)

Defines the Word Address used to control the Window screen. When Local Window is used, this data defines the U-tag Word Addresses. When Global Window is used, this data is controlled by LS0016.



Note:

- When using Active Window, you must place a U-tag on the same screen as the Q-tag. The U-tag’s Designated Screen area settings should be set to “Indirect” and the “Data Format” to “Bin”.
- To use the Library Display feature, you must place an L-tag on the Window Registration screen. The L-tag’s Designated Screen area settings should be set to “Indirect” and the “Data Format” to “Bin” To use the Text Display feature, you must place an X-tag on the Window Registration screen.
- The X-tag’s Designated Mode area settings should be set to “Word” and the “Data Format” to “Bin”.

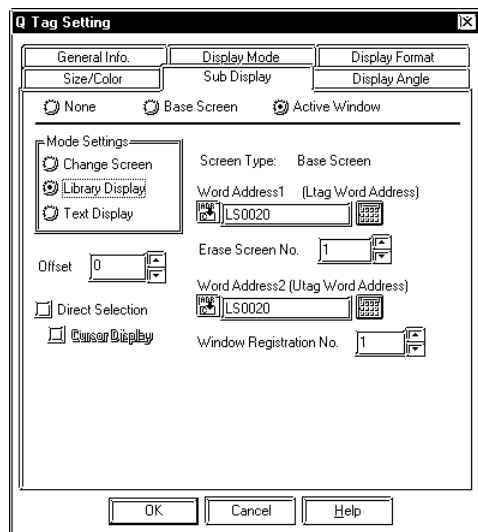

Active Window Mode Settings

Library Display

Word Address1 (Ltag Word Address)

Defines the Word Address used to designate an L-tag’s Base screen No. address. The Sub Display screen No. used in the Alarm Creation and Editing area is treated as the Library screen No.

Erase Screen No.

When a message in the Alarm Creation and Editing area is selected whose Sub Screen No. setting is “0”, the base screen called by this feature will delete the previous display screen. Create a Base screen for erasing by making a black, filled rectangle.

Window Registration No.

Enter a Window Registration No. here for the window you wish to display on the screen.

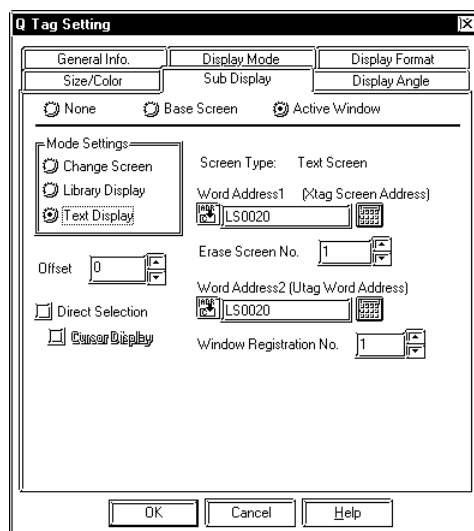

Note: When a message in the Alarm Creation and Editing area is selected whose Sub Screen No. setting is “0”, the Window Registration No. is set to “0” and the Erase Screen No. is written to the L-tag’s Word Address, which prevents the Sub Screen from displaying.

**Text Display****Word Address1 (X-tag Screen Address)**

Defines the Word Address used to designate an X-tag’s Text screen. The Sub Display screen No. used in the Alarm Creation and Editing area is treated as the Text screen No.

Erase Screen No.

When a message in the Alarm Creation and Editing area is selected whose Sub Screen No. is not registered, the Text screen called by this feature will delete the previous display screen.

Window Registration No.

Enter a Registration No. here for the window you wish to display on the screen.



Note: When the Sub Screen area is set to Active Window, changing the current Base screen to display another screen will set the Window Registration No. to “0” and prevent the Sub Screen from displaying.

■ Display Angle

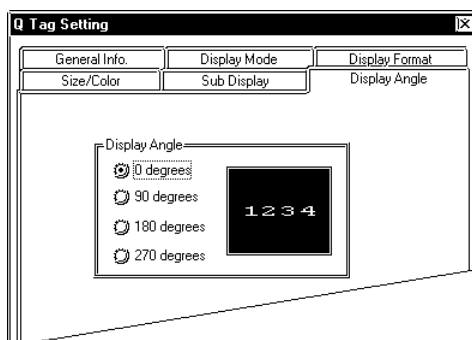
**Display Angle**

Set up the rotation for the display. Select 0 (zero), 90, 180, or 270 degrees.

2.20.5 Q-tag Examples

Suppose a T-tag (special Q-tag select key) has been set up on the screen below. Example operations are provided for each key.

Sample screen (History)

98/01/02	10:05	B-tank Pressure Trouble		11:30
98/01/01	12:15	A-tank Low Water Level	13:15	15:00
98/01/01	12:00	Level 1 Point closed	14:00	16:50

Recovery time
Acknowledgment time

Start	Up	Down	Ack	Ack All	Delete	Delete All	End
-------	----	------	-----	---------	--------	------------	-----

- Pressing the Start key causes the cursor to appear. The cursor displays as a solid line over and under the current message. **Other Q-tag select keys will not be enabled until the Start key is touched.**

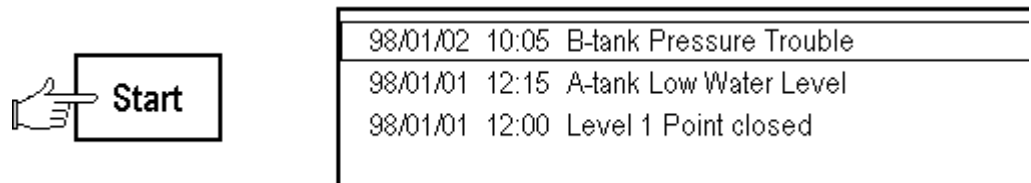

- Press the Up or Down keys to move the cursor up and down.

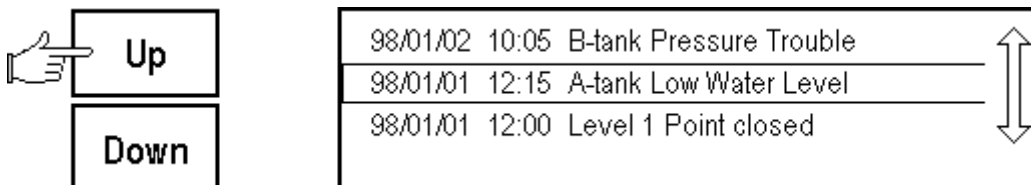

- Press the Ack key when the message is checked or acknowledged. That message's line appears with the Acknowledge Color settings (only for that message's line).

If Ack All is pressed, then all the lines appear with the color settings for all the messages (ACK ALL). Message times previously displayed are not updated by the new acknowledge time display. However, if error cleared messages are acknowledged, they remain with the Error Clear Color settings.

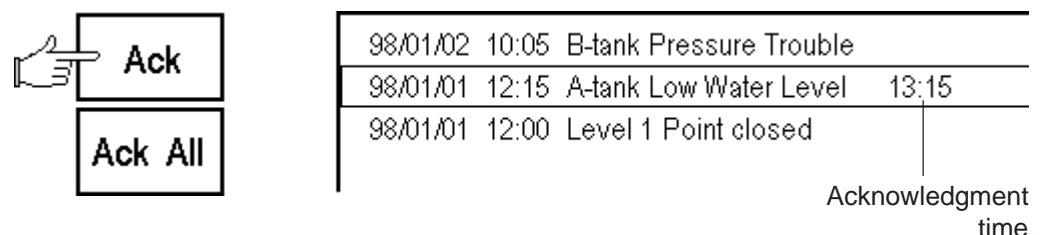

- When the alarm is recovered, the error cleared time appears in designated Error Clear Color. The recovered alarm message's line is displayed according to the Recover Color settings.

When the alarm is recovered

98/01/02	10:05	B-tank Pressure Trouble	11:30	
98/01/01	12:15	A-tank Low Water Level	13:15	15:00
98/01/01	12:00	Level 1 Point closed	14:00	16:50

Recovery time

- Pressing the Delete key erases the message in the current cursor position. As a result, all the other messages move up one row.

Pressing Delete All causes all the alarm messages to disappear. However, the control device is not deleted.

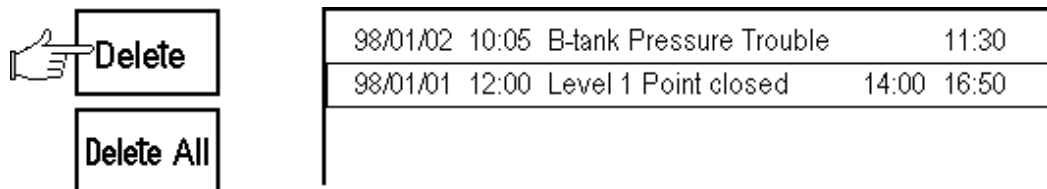

- The cursor key disappears when the End key is pressed.

If you press the Start key twice, the alarm display stops. This is known as freeze mode.

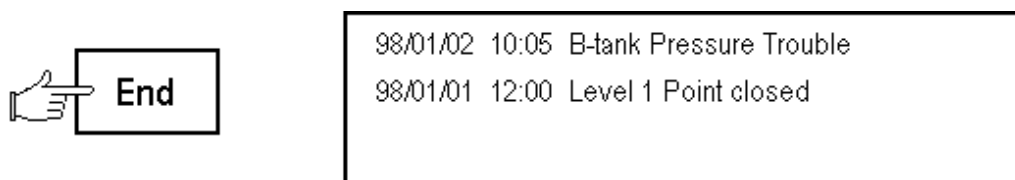

2.20.6 Sub Display Example

This section explains how to use a Sub Display from an Active Window/Library Display.

■ Sub Display Example

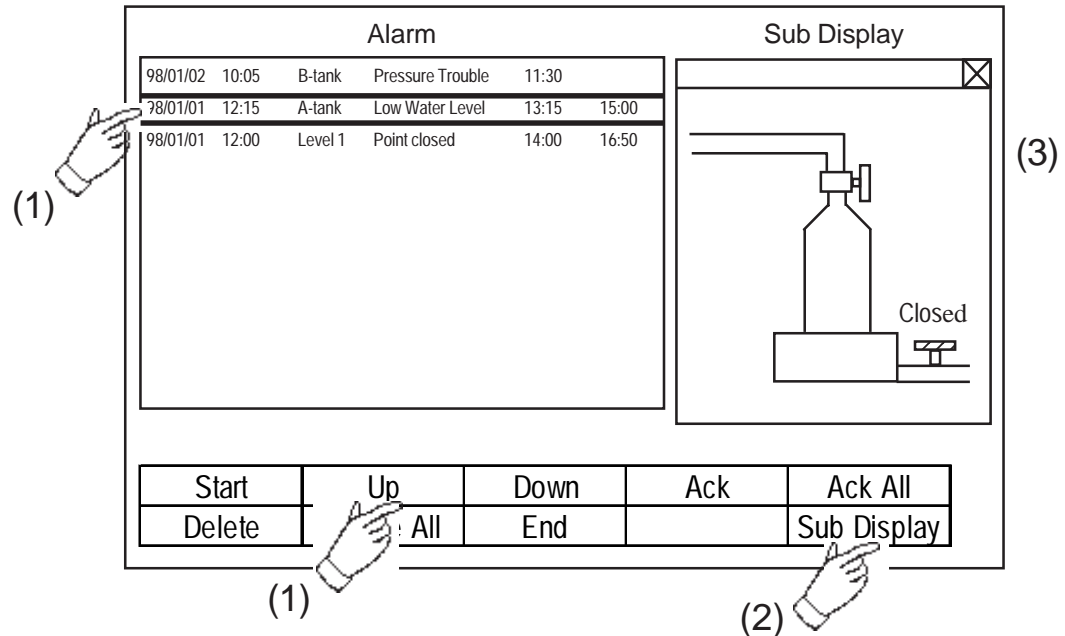

- (1) Select any of the Alarm Summary's messages by touching the screen or using the Up/Down key.
When a message is selected by touching, its screen Active Window appears on the screen and the Library screen is displayed in it (3).
- (2) When a message is selected using the Up/Down keys, touch the Sub Display selection.
- (3) The Active Window appears on the screen and the Library screen is displayed in it.

In this example, the "A-tank Low Water Level" message is selected, and its Sub Display is called up. The sub-screen is displayed as an Active Window. Displays the Sub Display screen No. set in the Alarm Creation and Editing area. When you select another message in the same way, the screen displayed is set by the Sub Display screen No.



- **Cursor movement is not connected with the Sub Display feature. If you move a cursor touching a message, the previous Sub Screen continues to display.**
- **If you touch an area outside of the messages, even though the touch buzzer sounds, the Sub Screen will not display.**

■ **Base Screen**

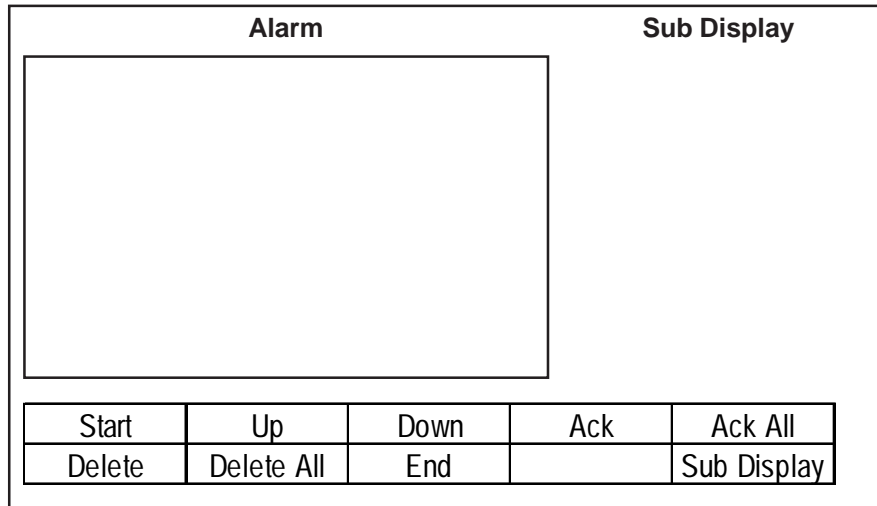

◆ **Tag Settings**

• **Q-tag**

Sub Display: “Active Window”, Mode Settings: “Library Display”, Screen No. Storage Address: “LS0020”, Word Address2: “LS0021”, Direct Selection: “Selection” (others are omitted).

• **U-tag**

Word Address1: “LS0021”, Designated Window: “Indirect”, Data Format: “Bin” (others are omitted).

• **T-tag**

Mode: “Q-Tag Selection Key”, Action: “Sub Display”(others are omitted).

■ **Active Window Display Screen**

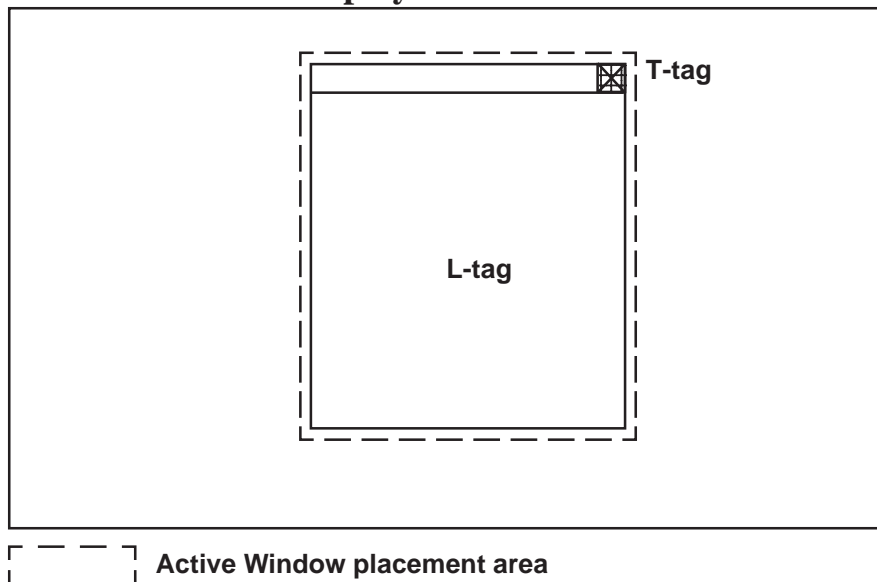

◆ **Tag Settings**

• **L-tag**

Screen Designation: “Indirect”, Trigger Type: “Indirect”, Word Address: “LS0020”, Data Format: “Bin”

• **T-tag**

Word Address: “LS0021”, Constant: “0” (others are omitted).

■ Alarm Creation and Editing area

Settings Example “A-tank Low Water Level” message
 Sub Display screen No. “302”

	Word Addresses	Group No.	Sub Display screen No.	Alarm Value	No. of Monitor Bits	Messages
1	D02000	0	300	200	16	A-tank Pressure Trouble
2	D02001	0	301	200	16	B-tank Pressure Trouble
3	D02002	0	302	20	16	A-tank Low Water Level
4	D02003	0	303	10	16	B-tank Low Water Level
5	D02004	0	304	1	16	Level 1 Point closed
6	D02005	0	305	1	16	Level 2 Point closed

■ Library Screen (B302)

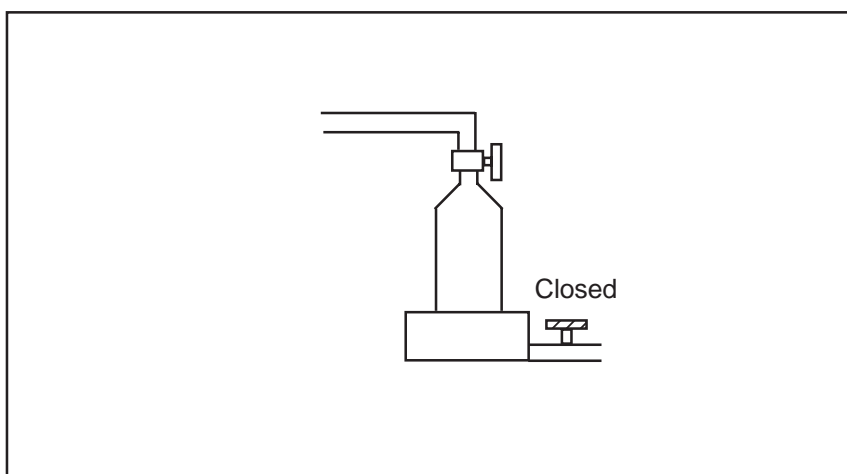

- **Cursor movement is not connected with the Sub Display feature. Even if you move the cursor to another message, the previous Sub Screen continues to display.**
- **The Sub Display screen is not cleared automatically. Also, when the current message displayed on the screen is cleared, the Sub Display screen is not cleared. However, when the current screen is changed to another screen, “0” will be written to the L-tag, X-tag, and U-tag’s designated Word Addresses used to display Sub Displays.**
- **When the Sub Screen feature is set to Change Screen, any message whose Sub Screen No. setting is “0” will not cause the screen to change.**
- **When using the Sub Display feature, you can place only one Q-tag per Base screen. When multiple Q-tags are placed on a screen, the Sub Screen will not display.**
- **When ”Direct” is selected, due to the effect of the touch panel grid, the Q-tag’s display position or the number of dots used for spacing between each message row may cause Touch Keys to lose their effectiveness.**
- **If you touch an area on a message display where there is no message text, even though the buzzer will sound, the Sub Screen area will not display.**
- **Placing “Sub Display” keys on top of the “Start” and “Move” keys is possible, however, be sure to place the “Sub Display” keys on top, after placing the “Start” keys and “Move” keys.**

2.20.7 About Freeze Mode

In freeze mode, Alarm Trigger/Error Clear, plus the Ack, Ack All, Delete, and Delete All touch key inputs remain valid, however the screen display simply does not refresh until freeze mode is released.

Use freeze mode when many alarms are activated at the same time, e.g., test runs. Stopping the display allows you to see the displayed messages.

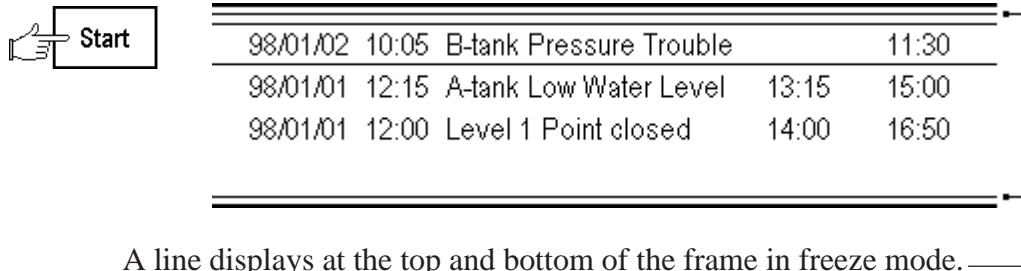

98/01/02	10:05	B-tank Pressure Trouble		11:30
98/01/01	12:15	A-tank Low Water Level	13:15	15:00
98/01/01	12:00	Level 1 Point closed	14:00	16:50

A line displays at the top and bottom of the frame in freeze mode.

To end freeze mode, press the End key.



- **Be careful not to touch the Delete or Delete All key in the freeze mode, or the message stored in the GP will be cleared even if the displayed message remains.**
- **When the message stored in the GP has been cleared as mentioned above, that message's sub-display is not displayed in the freeze mode.**

2.20.8 Roll Up and Roll Down Keys

Pressing the “Roll up” or “Roll Down” key allows you to scroll up or down the currently displayed alarm display page.

These keys are useful when many alarms are issued simultaneously. You can scroll display pages to see all the alarm data.

The following is the display example when the Roll Up key is pressed with the conditions below.

Number of alarms issued: 15

Number of display lines: 3

Number of roll up key presses: 3

Each cursor position is displayed below when the Roll Up key is pressed five times from the current cursor position.

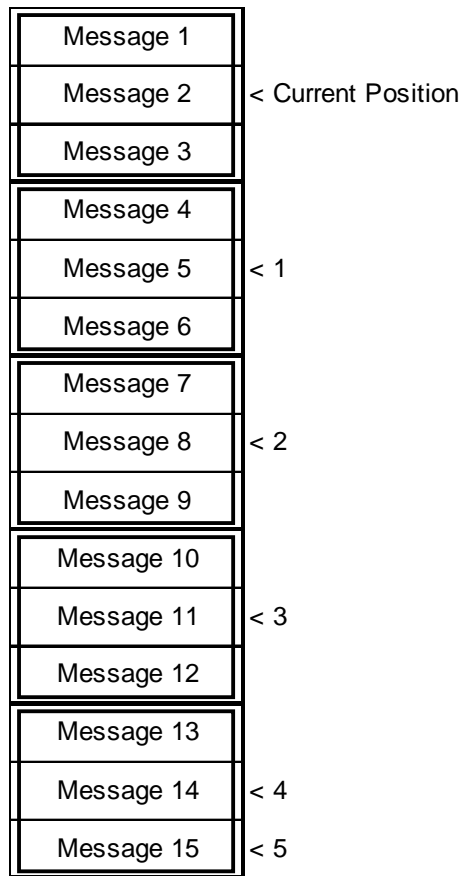

< : Cursor position

 Number of alarms displayed at one time on the screen.

2.20.9 GP System Area Q-tag settings



To set the Q-tag, open the "Display Format/System Settings" from the "Q-tag Settings" tab, or open the "GP System Settings" dialog box and select the "Extended Function Settings/Q-tag Settings" dialog box.

◆ **Q-Tag Setting**

Set up maximum trigger frequency of alarms possible in each Alarm display mode. Set up maximum trigger frequencies so that the sum of all the values is not greater than 768. When the number of alarms exceeds this fixed value, the oldest alarms are dropped to make room for the new alarms. Also, when alarms are controlled for each block, if the number of alarms exceeds the fixed value, the oldest alarms are deleted.

◆ **Q-tag Display Mode**

• **Time**

The times are displayed for Trigger, Acknowledge, and Recovery of the alarm states. Dates will be displayed for the Trigger states of the alarm.

Date	Trig	Message	Ack	Rec
01/12/17	09:30	B Tank Pressure		
01/12/17	12:15	A Tank Water Level		
		B Tank Pressure		11:15
		A Tank Water Level		13:15
		A Tank Water Level		14:20
01/12/17	22:46	No. 1 Pump Close		
		No. 1 Pump Close	09:07	
		No. 1 Pump Close		09:21

<When "Log" is selected in the "Q-Tag Setting">

• **Date and Time**

The date and time of an alarm are displayed with "Trigger", "Acknowledge" and "Recovery" only when the "Q-tag Settings" are designated as "Log".

This function is supported only by GP2000 series units.

Date	Trng	Message	Ack	Rec
01/12/17	09:30	B Tank Pressure		
01/12/17	12:15	A Tank Water Level		
		B Tank Pressure		11:15
		A Tank Water Level		13:15
		A Tank Water Level		14:20
01/12/17	22:46	No. 1 Pump Close		
		No. 1 Pump Close	09:07	
		No. 1 Pump Close		09:21



<When "Log" is selected in the "Q-Tag Setting">



Note: • The backup SRAM space used by "Time" and "Date and Time" settings is the same. The dates of "Acknowledge" and "Recovery" can be stored on the CF Card in the following process.

- When saving the alarm log data stored in backup SRAM onto the CF Card in CSV format files while operating the GP.

Reference "4.7.8 Transferring Data from Backup SRAM to the CF Card."

- When using Pro-Server (2-Way) to save the data that the GP has backed up in the SRAM to CSV files by uploading the alarm log.

Reference *Pro-Server with Pro-Studio for Windows Operation Manual*

◆ **Q-Tag Display Format**

Set up the Alarm Summary display format of the Q-tag. Set up the distance, in half character units (8 dots), from the left margin, for each Q-tag alarm summary display area. If the setup value is zero, there is no display. Be careful not to overlap some items such as the Date and Trigger. Also, be sure that the length of the message position is within the length of the longest message designated. If the items overlap, they could be displayed incorrectly.

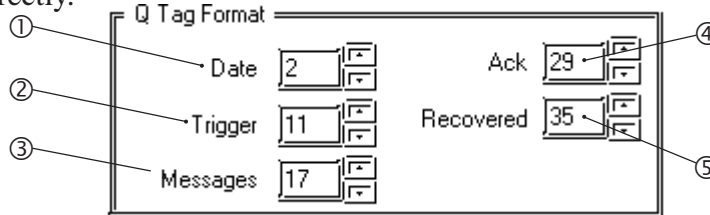

Sample

Date	Trigger	Messages	Ack	Recovery
mm/dd/yy	24:00	Message	24:00	24:00

• **Alarm Summary Display area**

(One single-byte character uses an 8-dot space.)

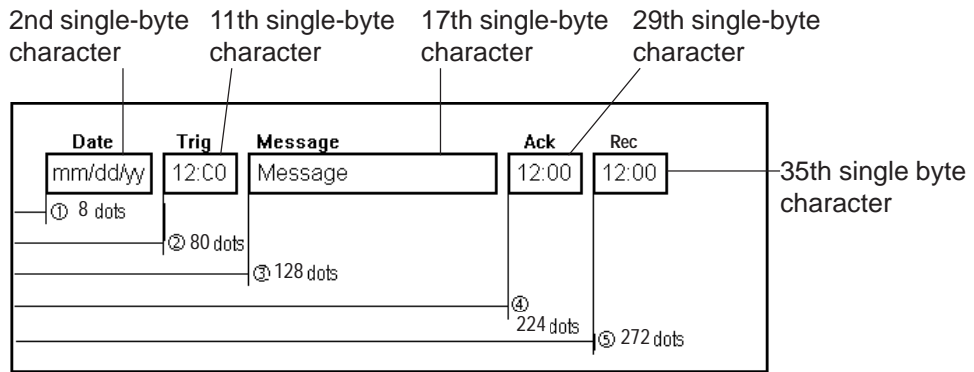

◆ **Q-Tag Print Settings**

Used for entering the Q-Tag Alarm Summary print settings. To enter these settings, click on the Print Settings tab, and select either Real Time or Grouping. Be aware that grouping can only be selected for GP77R and GP2000 (except GP-2301) series units. The Trigger Color, Ack (Acknowledge) Color and Recovered Color settings are available with either selection.

● **When Real Time is Selected:**

The Print format is the same as Log area display format. Messages are printed whenever a Trigger, Acknowledge, or Error Recovery occurs. Even when messages are controlled in block units, individual messages are printed out every time they are issued.

● **When Grouping is Selected:**

If you select Grouping, you need to enter the Control Word and Completion Bit. Control Word Addresses are for setting the Alarm types and Trigger bits used when controlling the system via a host computer. Printing will start when the Trigger bit changes from OFF to ON. The Completion Bit designates the bit address that will be turned ON when printing is completed. The host computer will start printing the next data after it confirms that the Completion Bit has been turned ON. Be sure to use the Host computer to turn the Completion Bit OFF after the bit's ON State is detected.

<Control Word Address >

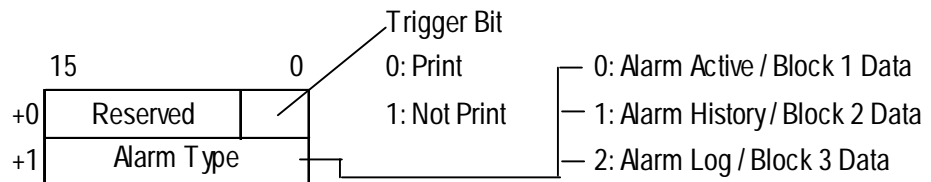

The format of the printout is set in the Q-Tag Format and Q-Tag Print Settings.

**<When Using the Grouping Selection - Q-Tag Print Settings Area>**

- **If Grouping is selected, the screen automatically displays the next (new) page when the current page's printing is completed.**
- **If the GP(except GP-2301S) is equipped with a color display, you can designate the printout color using the GP's standard color settings.**
 1. **Printout color can be set for the Trigger, Acknowledge and Recovery colors.**
 2. **When using the Grouping selection, the Trigger, Acknowledge and Recovery printing colors will be the same as the colors selected in the Q-Tag Alarm Display screen.**
 3. **If you touch the Alarm History's "Ack" key after the Alarm Message is recovered, the message's Recovery color will remain the same.**
 4. **There are eight (8) color selections available.**
 5. **The printing color settings are only for characters and not for backgrounds.**
- **When the Grouping feature is used, any Alarm that is Triggered or Recovered during printing will not be printed. Only the Alarm status data created before printing started will be printed.**
- **If the GP is turned OFF during printing, printing will also stop. However, when the GP is turned ON again, printing will not continue automatically from where it stopped. If the Print setting's Trigger bit is still ON when the GP is turned ON, printing will repeat again, from the beginning of the messages.**
- **Be sure to hold the Print Trigger Bit's ON/OFF state longer than the communication cycle time and the Tag Scan time.**
- **If no Q-Tag settings are input, or if no Alarms have occurred prior to Alarm status printout, the message "Number of Message(s) 0" will be printed.**
- **When the number of specified alarm type settings (the number of alarm types stored in the GP system settings) is 0, the operation completion bit from the GP does not turn ON.**

<Printing Format Example>

Date	Trigger	Message	Acknowledge	Recovered
yy/mm/dd	24:00		24:00	24:00

<Message Printing Example>

• Alarm Log

When "Q-Tag Display Mode" is designated as "Time"

Number of Message(s)		8		
Date	Trigger	Message	Acknowledge	Recovery
00/06/14	12:00	1st Pump Closed		
00/06/14	12:15	Tank A Low Water Level		
		Tank A Low Water Level	13:15	
		1st Pump Closed	14:00	
		Tank A Low Water Level		15:00
		1st Pump Closed		16:50
00/06/15	10:05	Tank B Pressure Alarm		
		Tank B Pressure Alarm		11:30

When "Q-Tag Display Mode" is designated as "Date and Time"

Number of Message(s)		8		
Date	Trigger	Message	Acknowledge	Recovery
00/06/14	12:00	1st Pump Closed		
00/06/14	12:15	Tank A Low Water Level		
00/06/14		Tank A Low Water Level	13:15	
00/06/14		1st Pump Closed	14:00	
00/06/14		Tank A Low Water Level		15:00
00/06/14		1st Pump Closed		16:50
00/06/15	10:05	Tank B Pressure Alarm		
00/06/15		Tank B Pressure Alarm		11:30

• Alarm History

Number of Message(s)		3		
Date	Trigger	Message	Acknowledge	Recovery
00/06/14	12:00	1st Pump Closed	14:00	16:50
00/06/14	12:15	Tank A Low Water Level	13:15	15:00
00/06/15	10:05	Tank B Pressure Alarm		11:30



- *The item titles “Number of Message(s)”, “Date”, “Trigger”, “Message” “Ack” and “Rec” are only printed on the first page’s top 2 lines, even if the printout is more than 1 page.*
- *If your GP font setting is set to other than “JAPANESE” (i.e. “I-ASCII”, “KOREAN”, “TAIWANESE” or “CHINESE”), all item titles are printed in English.*

◆ Triggered Alarm Count

The LS Area's start address is specified to write the number of triggered alarm summaries whose group numbers have been specified. Starting from this address specified here, the LS Area for the maximum group numbers will be used for the area to write the number of triggered alarm summaries. When an alarm is triggered, the LS Area data equivalent to the group number will be incremented.



- Be sure to keep the LS Area equivalent to the group number.
- The number of triggered alarm summaries will not be backed up. To back it up, use it together with the LS Area back up function.
- Up to 65535 of trigger alarm summaries can be counted (0 to 65535). When the number of the triggered alarm summaries exceeds 65535, triggered alarm summaries after this number will not be counted anymore.
- The number of triggered alarm summaries increments the LS Area data. Therefore, if the data is overwritten or cleared due to the GP or PLC's being shut down, the count will not be made correctly.
- This data is fixed to the "Bin" format.

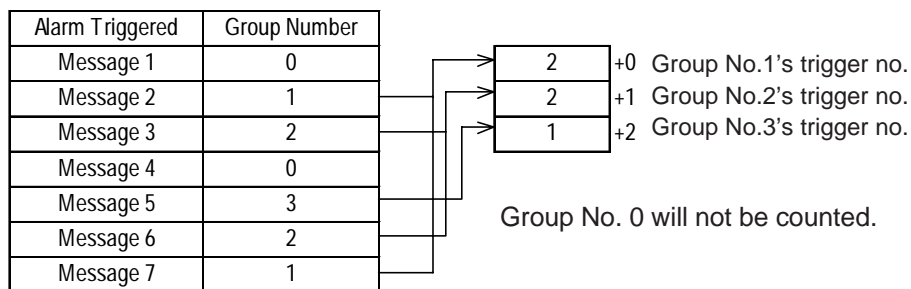

- The maximum group number is the maximum number of registered messages. For the GP-70/77R series, the maximum group number is 2012. For the GP-2000 series, it is 6096.

◆ Q-Tag External Operation

This feature enables you to check and, if desired, clear all Q-Tag Alarm Messages in all network GPs at one time via the host computer. To use this feature, you will need to designate the Q-Tag setting's Control Word Address and Completion Bit. The Control Word Address designates the alarm type and operation code used for controlling the system via the host computer. The Completion Bit is used for designating the bit address that turns ON when the action is completed. This feature can be used only with GP77R, GP377 and GP2000 series units.

<Control Word Address >

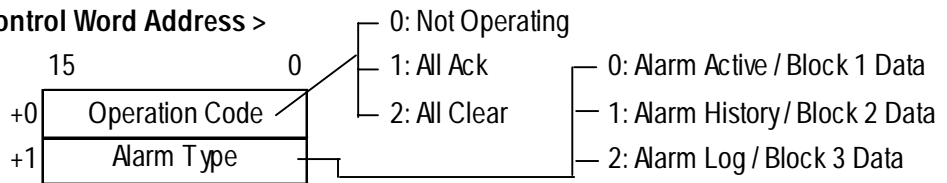

<Example>

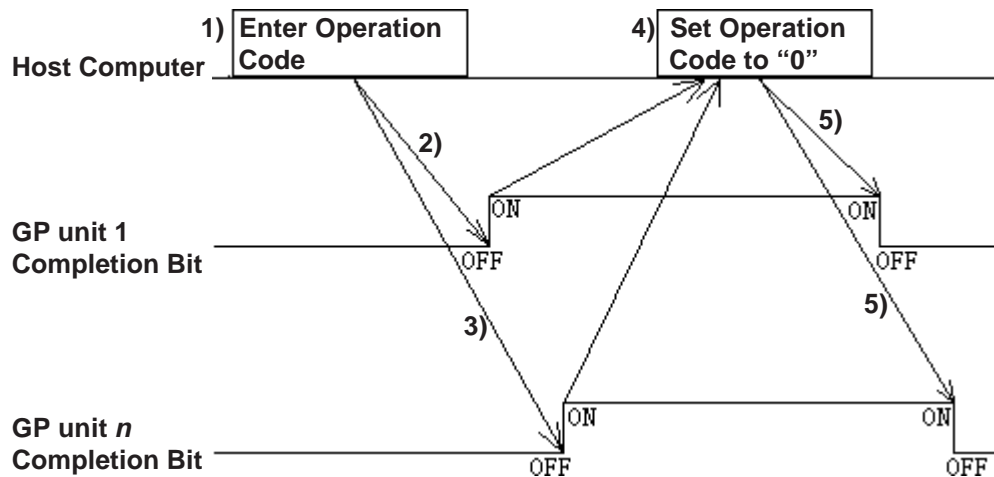

- 1) Designate the Control Word Address (alarm type and operation code) in the host computer.
- 2) The host computer then commands GP unit 1 to turn its Completion Bit ON when the GP unit's operation is completed.
- 3) The host computer commands GP unit *n* to turn its Completion Bit ON when the GP unit's operation is completed.
- 4) The host computer confirms that all GP Completion Bits have been turned ON.
- 5) The host computer sets its Control Word Address to "0".
- 6) Each GP turns its Completion Bit OFF after confirming that the Control Word Address' Operation Code has been changed to "0".
- 7) The host computer confirms that all network GP Completion Bits have been turned OFF.



Prior to performing step 1), be sure that all network GP Completion Bits are turned OFF. Also, since this procedure may be interrupted, such as by a power supply cutoff etc., be sure to set the Control Word Address to "0" and turn all Completion Bits OFF before beginning.



- Depending on each network GP's tag data reading order etc., the length of time each GP unit takes for each process and for turning the Completion Bit ON may differ.
- When operating 2 or more GPs at the same time, depending on each GP's Read timing etc., there will be a processing time lag.
- If an Alarm Trigger or an Alarm Recovery occurs just before or after the host computer's processing begins, there may be slight differences between each GP's Alarm History.

◆ Alarm Message Control*¹

Select whether the Q-tag's alarm message presently being displayed is retained or not when the GP's power is turned OFF. If the "Clear when powering up" is selected, all alarm message data is cleared.

◆ PLC Data Monitor *¹

Select whether data stored in the PLC and monitored with the Q-tag is retained or cleared when the GP's power cord is disconnected. If the "Clear when powering up" is selected, it is not maintained.

*1 These features are enabled when the unit has the internal backup SRAM. If the nameplate at the rear of the GP70 series unit is copper color, it is equipped with SRAM. Also, all GP77R, GP377 and GP2000 series units have this internal backup SRAM.

Copper-colored sticker

Pro-face GRAPHIC PANEL
GP571-TC11
S / N 8800150000
DIGITAL ELECTRONICS CORP. MADE IN JAPAN



- To back up a Q-tag alarm summary, select "Not clear when powering up" for both "Alarm Message Displayed in Q-Tag" and "PLC Data Monitored by Q-Tag".
- Data stored in the backup SRAM will be erased when:
 - The memory is initialized
 - The screen data is transferred
 - The GP is set to the offline mode
 - The GP is powered off if the "Clear when powering up" is selected for the "Alarm Message Displayed in Q-Tag" and "PLC Data Monitored by Q-Tag" in the GP system setting's "Q-Tag Setting" window
 - The GP system protocol is set up
 - The GP's SELF-DIAGNOSIS System's INTERNAL FEPROM(SCREEN AREA) is running.
 - The GP's OFFLINE settings are being set up - Note that when using the GP system version 1.30 or higher (included in the GP-PRO/PBIII for Windows95 Ver1.1 software or higher), data stored in the backup SRAM will not be erased.

◆ **Q-tag time format**

In the Q tag time format settings, the following are selectable when the displayed time range is between 0 and 9 o'clock.

The GP77 series, GP377 series and GP2000 series support this function.

- _0:00 (_0:00 _9:00) _ represents the space character.
- 00:00 (00:00 09:00) Add "0" for double-digit display.

Example: Display using the 00:00 setting format

Date	Alarm	Message	Check	Recovery
00/06/06	02:00	No. 1 pump closed	04:00	06:50

The above settings apply to the following:

- displaying the alarm message on the screen
- printing out the alarm message
- saving the alarm message in a CSV file

2.20.10 Example of CSV Storage of Q-tag Alarm Summary

This section shows a sample of a CSV alarm data file, as well as a sample of the display that will appear when the file is opened in Excel.

Reference For details of saving a file in CSV format, see "4.7 Using the CF Card."



Note: This function is supported only by GP77R and GP2000 series units. In addition, the optional Multi Unit (sold separately) is required to use the CF Card with the GP77R series unit.

- **CSV File Content: History**

```

"Number of Messages", "3", "", "", ""
"", "", "", "", ""
"Trigger Date", "Trigger Time", "Messages", "Acknowledge Time", "Recovery Time"
"98/06/15", "10:05:35", "B-tank Pressure Trouble", "", "11:30:40"
"98/06/14", "12:15:10", "A-tank Low Water Level", "13:15:15", "15:00:25"
"98/06/14", "12:00:05", "No. 1 Pump Closed", "14:00:20", "16:50:30"
  
```



When opening the file with Excel

Number of Messages	3			
Trigger Date	Trigger Time	Message	Acknowledge Time	Recovery Time
1998/6/15	10:05:35	B-tank Pressure Trouble		11:30:40
1998/6/14	12:15:10	A-tank Low Water Level	13:15:15	15:00:25
1998/6/14	12:00:05	No. 1 Pump Closed	14:00:20	16:50:30



- **Note:** The data are output so that the most recent information is displayed on the top line. (This applies to Active, History, and Log data.)
- When the alarm data are "Active" or "History", the item names including "Trigger Date", "Trigger Time", "Message(s), Acknowledge Time", and "Recovery Time" on the third line of the output data are fixed as shown above. When the alarm data are "Log", the item names are output in the fixed format depending on the selection ("Time" or "Date and Time") made in the "Display Mode (Log)" on the "Q-Tag Setting" tab.

• When “Time” is selected with the Log setting

Number of Messages	8			
Trigger Date	Trigger Time	Message	Acknowledge Time	Recovery Time
		No. 1 Pump Closed		9:21:50
		No. 1 Pump Closed	9:07:40	
2001/12/17	22:46:50	No. 1 Pump Closed		
		A-tank Low Water Level		14:20:40
		A-tank Low Water Level	13:15:20	
		B-tank Pressure Trouble		11:15:30
2001/12/17	12:15:20	A-tank Low Water Level		
2001/12/17	9:30:10	B-tank Pressure Trouble		

• When “Date and Time” are selected with the Log setting

Number of Messages	8			
Trigger Date	Trigger Time	Message	Acknowledge Time	Recovery Time
2001/12/18		No. 1 Pump Closed		9:21:50
2001/12/18		No. 1 Pump Closed	9:07:40	
2001/12/17	22:46:50	No. 1 Pump Closed		
2001/12/17		A-tank Low Water Level		14:20:40
2001/12/17		A-tank Low Water Level	13:15:20	
2001/12/17		B-tank Pressure Trouble		11:15:30
2001/12/17	12:15:20	A-tank Low Water Level		
2001/12/17	9:30:10	B-tank Pressure Trouble		



The time display format for "Trigger Time", "Acknowledge Time", and "Recovery Time" is fixed to "24:00:00".

2.21 R-tag (Rail Settings)

2.21.1 Overview

Defines the rail (track) along which a Mark (bit mapped icon) moves. Use R-tags together with J-tags. The J-tag designates the Mark file, and the R-tag designates movement along the points.

Can be used for displaying production lines or gradation markers for PV graphs.

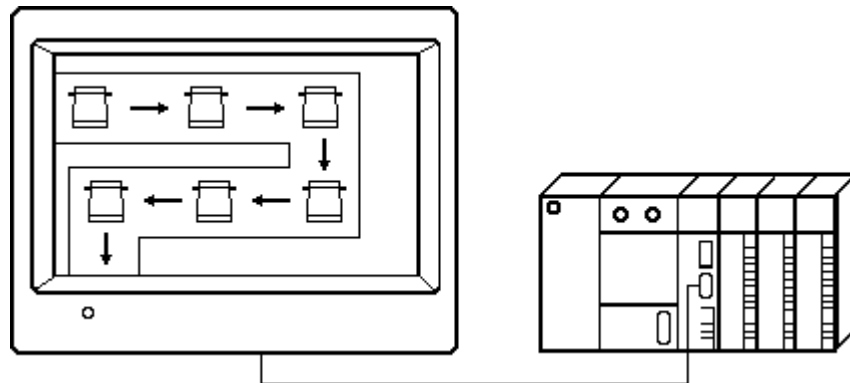

* J-tags set which Mark image to display.

2.21.2 About R-tags

- A single display screen can set up a maximum of 30 rails worth of R-tags.
- The maximum number of Mark display positions for all the rails can total 406. However, by loading other Base screens with R-tag settings (from libraries), the total number of display positions can increase to 512. (256 for GP-270, GP-H70 and GP-370)



important

If the display positions are set too close to each other and a Mark overlays another Mark, then the Marks may not display properly. When setting display positions, keep in mind the size of the displayed Mark, and leave enough space between each position.



2.21.3 Using R-tags

■ General Info.

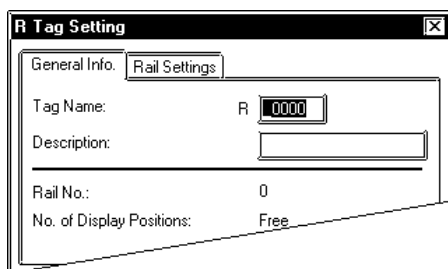

The General Info. page provides information about the current settings for the R-tag.

Tag Name

Must be no more than five Single-byte or two Double-byte characters long and composed of letters and/or symbols.

Description

Up to 20 Single-byte or 10 Double-byte characters can be entered as a description of the tag.

■ Rail Settings

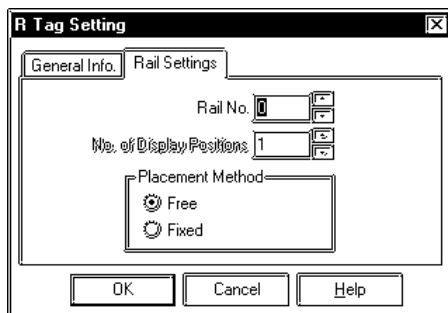

Rail No.

Assign an ID number to the R-tag (0 - 29).

No. of Display Positions

Define the total number of display positions set for the Mark (1 - 99). This setting is valid when Fixed is selected for the Placement.

Placement Method

Free

Select this option to designate the number of Marks placed on the R-tag, and their positions manually. Enter the settings for the R-tag, then click "OK." Left-click on each desired position to designate positions. To end defining positions, right-click on the end point.

Fixed

Select this option to designate a fixed number of Marks positions on the R-tag in the "No. of Positions" setting. Enter the R-tag settings, then click "OK." To enter the no. of positions, left-click on the up or down triangle the desired number of times.

Also when using Fixed, and No. of Positions is more than 1, you can choose to use the Line option, where R-tag positions are designated evenly between 2 points.



- Note:**
- Up to 30 rails worth of R-tags are valid for each display screen.
 - Multiple setups of the same rail number cannot be done on a screen.
 - When displaying two or more screens simultaneously, be sure not to set the same rail number for each tag.
 - Place the Mark so that it does not lie outside the display area.
 - Keep the total number of display positions on one screen at less than 512. (256 for GP-270, GP-370 and GP-H70)



2.22 S-tag (String Display)

2.22.1 Overview

Displays character string data stored in the host's (PLC) word address.

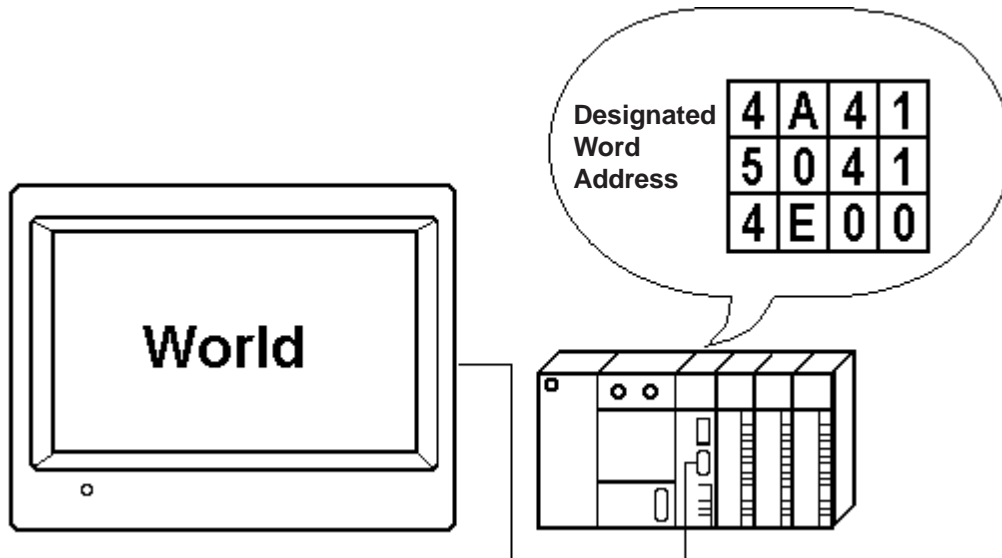

2.22.2 About S-tags

- The character string data is stored in the host (PLC) as ASCII codes or character codes.
- There are three types of Trigger Types: 0→1, 0↔1, and Indirect. Define the trigger bit when using the “0→1” and “0↔1” options.
 - 0→1 When the trigger bit changes from OFF to ON, the character-string data stored in the word address is displayed.
 - 0↔1 When the monitor bit changes (OFF→ON, or ON→OFF), the character-string data stored in the word address is displayed.
 - Indirect The character-string display changes when data in the word address changes.
- The character string can display a maximum of 100 Single-byte characters.
- Display Size (character size) and color attributes can be designated.



- *Please set the trigger bit ON after all the data has been changed in the word addresses; otherwise, the character string may not display properly.*
- *If the trigger bit changes immediately after character-string data changes in the host (PLC), there may be instances when the character-string does not display correctly. In that case, program the host (PLC) to use the send wait to slightly delay the trigger bit change. The send wait period depends on the amount of tags set, scan time, baud rate, and the number of characters used.*



- **Note:** Because S-tag handles character-string data, it must process more data compared to other tags, which leads to longer communication times. To display character data quicker, use the following steps.
 1. If there are only a few character strings to display, register each string onto individual Base screens as libraries, and then use L-tags to display them.
 2. If there are not many characters used in the character-string, set the Trigger Type to Indirect, which does not use a trigger bit. If the character-string is longer, use of the trigger bit will enable the displays to switch more quickly.

2.22.3 Using S-tags

■ General Info.

The screenshot shows the 'S Tag Setting' dialog box with the 'General Info' tab selected. The fields are as follows:

Tag Name:	S00000
Description:	
Word Address:	D00000
Trigger Bit Address:	X00000
Display Mode:	0 > 1
Read Out After Trigger:	Off
Display Angle:	0 degrees
Display Style:	
No. of Dis...	

The General Info. page provides information about the current settings for the S-tag.

Tag Name

Must be no more than five Single-byte or two Double-byte characters long and composed of letters and/or symbols.

Description

Up to 20 Single-byte or 10 Double-byte characters can be entered as a description of the tag.

■ Display Mode

The screenshot shows the 'S Tag Setting' dialog box with the 'Display Mode' tab selected. The fields are as follows:

Trigger Type:	0->1
Trigger Bit Address:	X00000
Read Out After Trigger:	<input type="checkbox"/>
Word Address:	D00000

Trigger Type

0→1

When the bit address changes from OFF to ON, the character-string is displayed.

1←0

When the bit address changes from OFF→ON or ON→OFF, the character-string is displayed.

Indirect

The character-string display switches when data in the word address changes.

Trigger Bit Address

Defines the ON/OFF trigger bit address of the character display. When Indirect is selected for the Trigger Type, then this setting is unnecessary.

Read Out After Trigger ^{*1}

When this check box is checked, after the trigger bit changes, the text data will be read out. When the text data is a large volume or many S-tags are set on the single screen, check this check box for each S-tag to increase other tag display speeds. When this check box is checked, other tags' display speeds will be increased, S-tags' speeds, however, will be decreased. When the trigger method is specified to Indirect, this setting is not valid.

^{*1} This feature cannot be used with some PLCs. For a complete list of these PLC's refer to **Reference** 1.3 Tag List's note section - *4.

Word Address

Defines the starting word address for storing the character string.



Note: Enter a NULL code of 00(h) at the end of the string. This NULL code determines the display length (the number of bytes) of the characters.

■ **Size/Style**

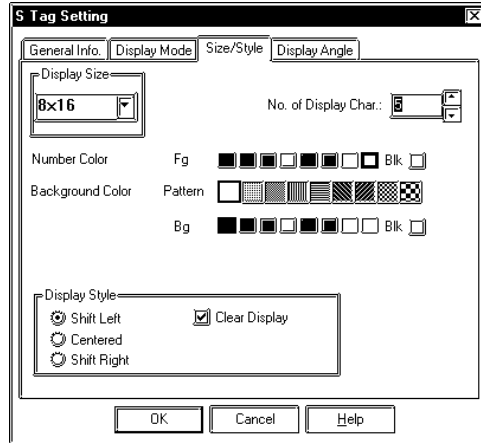

Display Size

The Display Size of characters can be specified here. With the GP2000 series, the scale ratio can be selected from integers 1 through 8. With other models, the scale ratio for the display can be selected as either 1, 2, 4 or 8 times. When "Half (h)" mode is selected, only 1, 2, 4 and 8 times are enabled. The basic unit of measurement, "1 x 1" times, is 8 dots by 8 dots in Half mode, and 8 dots by 16 dots in Full mode. "Half" mode is available with GP77R, GP377 and GP2000 series units.

When using Single-byte numerals or symbols, [6 X 10 dot], [8 X 13 dot] and [13 X 23 dot] extended fonts can be used.



Note: Since extended font sizes are fixed, objects containing these characters cannot be enlarged or reduced while pressing down the [Ctrl] key.

No. of Display Char.

Defines the character string length for the display.

Number Color

Defines the foreground color (Fg), background color (Bg), and blink attributes (Blk).

Background Color

Pattern and Background colors (Bg), and Blink status (Blk) are specified. The Pattern's Background color (Pc) is designated by the Pattern color. The Pattern's Background color will be a combination of Bg and Pc. However, Pattern "0" can only be specified for GP-270.

Reference "2.1.5 Color Settings", A-tag



Note: The maximum number of characters available for the S-tag display depends on the GP screen size, position, and the Display Size settings.

Reference "2.1.5 Color Settings", A-tag.

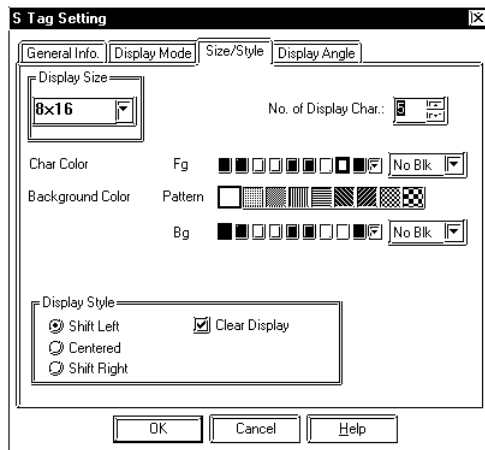

Display Style

Shift Left

Centered

Shift Right

Select one of the above options. Displays the data in the selected alignment.

Clear Display

When this option is set, before displaying the next set of characters, the previous display is erased. When this option is not set, the next set of characters writes over the previous display.

■ Display Angle

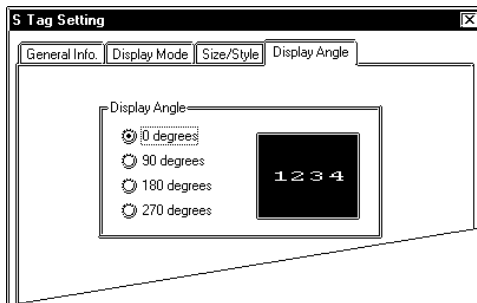

Display Angle

Set up the rotation for the display. Select one from 0 (zero), 90, 180, and 270 degrees.



2.23 T-tag (Touch Panel Input)

2.23.1 Overview

T-tags interpret touch areas on the Graphic Panel for the host (PLC). When the user presses one of these touch areas, the action designated by the associated T-tag is performed.

When the Operation Mode is set to Word

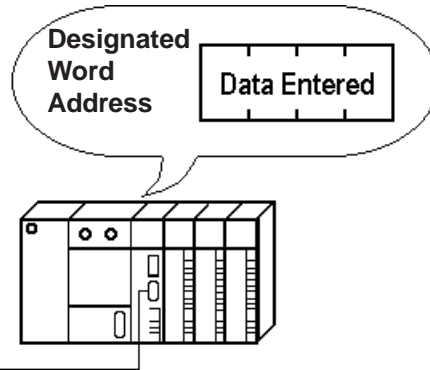
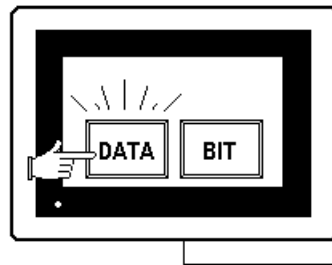

When the Operation Mode is set to Bit

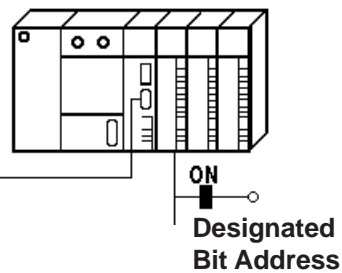
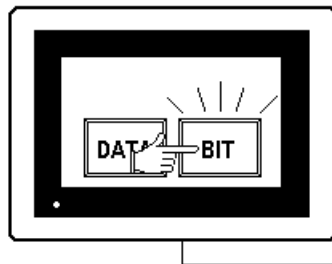

2.23.2 About T-tags

■ The switches listed below can be set up using T-tags.

- Bit Set
- Bit Reset
- Bit Momentary
- Bit Invert (toggle)
- Bit Compare
- Group
- Auto Off (Group)
- Change Screen
- Data Set (16 bit, 32 bit)
- Word Add Binary 16 Bit

(Entering a negative value in the Constant field makes subtractions possible)

- Word Add BCD 16 Bit
(Entering a negative value in the Constant field makes subtractions possible)
 - AND Binary 16 Bit
 - OR Binary 16 Bit
 - XOR Binary 16 Bit
 - GP exclusive special function switches
(GP Reset, cursor movement in Alarm Summary sub-display (Q-tag), etc.)
- The minimum touch panel key size is 20 × 20 dots.
 - When GP Initialize's Touch Operation Mode is set to "2 points", then two different touch panel keys can be used simultaneously.
 - In GP-470/570, pressing the touch panel key can cause a buzzer output through the AUX interface (hereafter referred to as "AUX I/F") provided at the rear of the unit. Neither the GP-270, GP-370, GP-H70, GP-377R, GP-377, GP-2300 or GP-2301 supports this function, since they do not have an AUX I/F.
 - When setting the touch panel switch, the radio switch can be set using the same group number's touch panel switch, if the group number was registered.



Note: The touch panel switch, however, cannot be operated according to the T tag (using the group setting) placed on the base screen, or the T tag called up by the U(Window) tag (using the group setting).

GP-270 series units do not support this function.



Warning

To prevent severe bodily injury, death or major machine damage, do not use a touch panel key for extremely important switches, such as an Emergency Stop switch. Instead, provide a separate hardware switch.



Important

- ***Bit Invert, Compare, Add, AND, OR, XOR extract data from the host (PLC) after a screen change. When a touch key is pressed, its data is used as the base and the selected operation takes place. When pressing one of these touch keys immediately after the screen change, because the data may not have been extracted yet, a failed value may be set. When there is the possibility touch keys may be pressed immediately after the screen change, set these touch keys addresses as Read-Only areas.***
- ***Immediately after changing screens, the touch panel keys may be temporarily ineffective because the processor is busy drawing the screen.***

- **When executing Bit Invert, Compare, Add, AND, OR, XOR of T-tags, data are written as the values retrieved from the PLC. Therefore, pressing T-tag repeatedly at very close intervals will trigger multiple write operations of the value that is currently being read out (in other words, the next write operation is triggered before the value written to the PLC is read out). As a result, the value may not reflect the numbers represented each time the T-tag is pressed. Similarly, pressing the T-tag repeatedly at very close intervals when operating two or more bits in one word address for Bit Invert will not change the bit value as expected.**

<Example 1>

When the T-tag for "+1" (add) word address data is pressed twice at very close intervals, the value may not necessarily increment by 2 (+2).

<Example 2>

When inverting Bit 0 and Bit 1 in one word address with two T-tags, pressing the two T-tags at very close intervals may not result in inversion of Bit 0 and Bit 1.



- Do not use the T-tag name T699. It is reserved for internal use.



Note: If multiple T-tags are set on the same screen position, all the switches are pressed when the multiple T-tags designated area is pressed. Extra communication time may be required to process each touch input.



- DO NOT set T-tags on the same screen position as the Screen change key or ENT key (K-tag).

2.23.3 Using T-tags

■ General Info.

The screenshot shows the 'T Tag Setting' dialog box with the 'General Info.' tab selected. The fields are as follows:

Tag Name:	T 0000
Description:	
Mode:	Bit
Addresses:	>00000
Action:	Bit Set
Screen Level Change Direction:	...
Reverse Video:	Off
Buzzer:	On
ALX Output:	On

The General Info. page provides information about the current settings for the T-tag.

Tag Name

Must be no more than five Single-byte or two Double-byte characters long and composed of letters and/or symbols.

Description

Up to 20 Single-byte or 10 Double-byte characters can be entered as a description of the tag.

■ Mode/Bit

The screenshot shows the 'T Tag Setting' dialog box with the 'Mode' tab selected. The 'Bit' radio button is selected. The fields are as follows:

Bit Address:	000000
Bit Access:	Set
Interlock:	Interlock Address: 000000
Touch available condition:	Bit On

Bit

Sets or resets the bit address.

Bit Address

Defines the bit address for the touch panel key input operation.

Bit Access

Set

Sets the bit in the bit address high (ON) when the touch panel key is pressed. The bit will remain high.

Reset

Sets the bit in the bit address low (OFF) when the touch panel key is pressed. The bit will remain low.

Momentary

Sets the bit in the bit address high (ON) only while a touch panel key is pressed.

Invert

The bit in the bit address is reversed (ON ↔ OFF) each time the touch panel key is pressed. The bit remains with the set value.

Compare

Defines a comparison of the contents of the Word Address with a predetermined constant. If the condition is correct, the bit address is set high (1).

Group

A radio switch (state switch) can be created by setting the same group T-tag. This feature can not be used with GP-270 Series.

Auto OFF [Group]

After the set time elapses, the Bit will automatically be turned OFF. The time can be designated from 1 to 60 seconds in 1 second intervals. The Group No. can be designated from 0 to 63.

(See next page)

Group Nos. designated via Group and Auto OFF (Group) are controlled separately.

As a result, even if the same Group No. is used in both modes, they are processed as different numbers.

This feature is supported by only the GP77R Series, GP377 Series and GP2000 Series units.

Interlock

The Interlock Address can be entered only when the Interlock is used to control the Touch screen's operation. The Touch available condition designates which Interlock (Bit) Address setting (i.e. ON or OFF) effects the Touch function. The Touch available condition's Bit Off setting is supported by only GP77R Series, GP377 Series and GP2000 Series units.

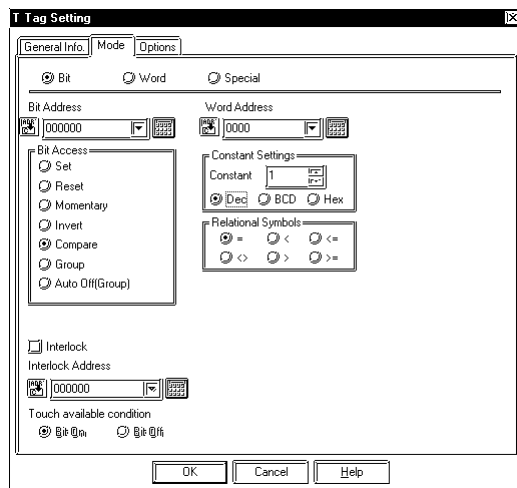

Compare Word Address

Defines the word address containing the data compared with the set constant (16 bit data).

Constant Settings

Constant

Set up a fixed value of -32768 to 32767.

Dec

BCD

Hex

Also set up the data format for the constant.

Relational Symbols

=
<
<=
<>
>
>=

Select a symbol used in the comparison. The way of comparison is as follows:

S1 (Symbol) S2

S1: Word address data

S2: Constant

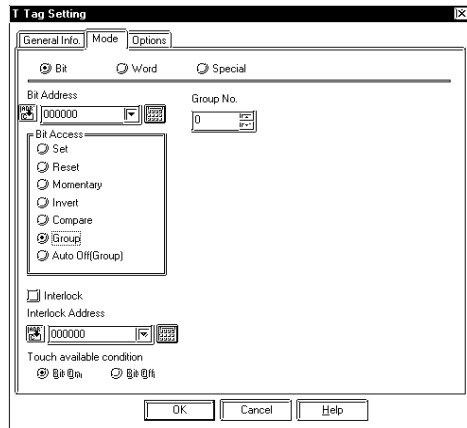

**Group
Group No.**

T-tag with the same number as the Group No. specified here will function as a radio switch (state switch).

*GP-270 Series units do not support this feature.



Note:
The T-tag on a base screen is not regarded as the same group as the T-tag which is called up by U-tag from the different screen.

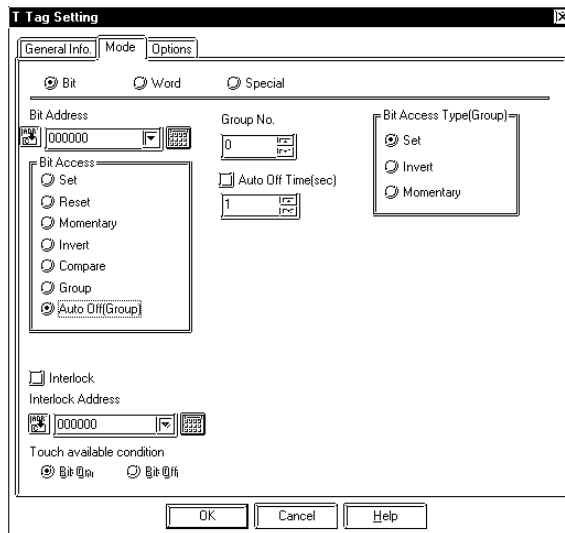

Auto Off (Group)

The Auto Off (Group) setting is supported by only GP77R Series, GP377 Series and GP2000 Series units.

Group No.

The group number can be from 0 to 63.

Auto Off Time (Sec)

The value can be from 1 to 60 seconds.

Bit Access Type (Group)

The following explains each touch panel screen square.

Set

Touching this square turns this T-tag's bit ON, and all other T-tag bits OFF.

Invert

Touching this square inverts only the touched T-tag's bit, and turns all other T-tag bits OFF.

Momentary

Touching this square causes a momentary change for only the touched T-tag's bit, and all other T-tag bits will turn OFF.



- **The time period monitor will be enabled only when the GP's display changes to a screen where a T-tag's Auto OFF (Group) setting is used. Also, the time period monitor operates independently for each group, so that if a group's T-tag is touched, only that group's time period monitor will restart.**
- **If the display is changed, or if the window is closed, this bit will automatically turn OFF.**

■ Mode/Word

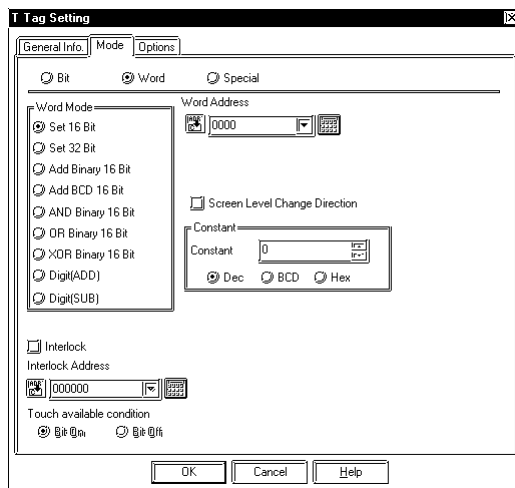

Word

Sets the designated data to the word address.

Word Access

Set 16 Bit

Writes the designated constant value (16-bit data) to the word address when the touch panel key is inputted. The data range for the constant is -32768 to 32767.

Set 32 Bit

Writes the designated constant value (32-bit data) to the word address when the touch panel key is inputted. The data range for the constant is -2147483648 to 2147483647.

Add Binary 16 Bit

When the touch panel key is pressed, it adds the data stored in Word Address 1 with the designated constant (binary 16 bit data) and writes the result to the designated word address. The data range for the constant is -32768 to 32767. (If desired, the constant's value can be viewed in BCD or Hex format.)

Add BCD 16 Bit

When the touch panel key is pressed, it adds the data stored in Word Address 1 with the designated constant (BCD 16 bit data) and writes the result to the designated word address. The data range for the constant is 0 to 9999.

AND Binary 16 Bit

When the touch panel key is pressed, it performs an AND operation between the data stored in Word Address 1 and the designated constant (binary 16 bit data) and writes the result to the designated word address. The data range for the constant is 0 to 65535.

OR Binary 16 Bit

When the touch panel key is pressed, it performs an OR operation between the data stored in Word Address 1 and the designated constant (binary 16 bit data) and writes the result to the designated word address. The data range for the constant is 0 to 65535.

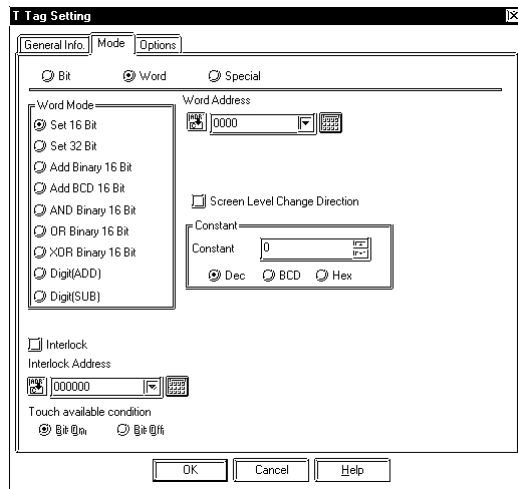

XOR Binary 16 Bit

When the touch panel key is pressed, it performs an XOR operation between the data stored in Word Address 1 and the designated constant (binary 16 bit data) and writes the result to the designated word address. The data range for the constant is 0 to 65535.

Digit(ADD)/Digit(SUB)

Every time the switch is pressed, the data value increases or decreases by 1 at the designated “digit position”. Rounding up or rounding down is not performed (e.g. 0 → 9 → 0). When a digit is increased or decreased, there is no effect on any other surrounding digit. For example, when “19”’s “9” digit is increased by one to “0”, the left-side “1” digit does not change.

Interlock

The Interlock Address can be entered only when the Interlock is used to control the Touch screen’s operation. The Touch available condition designates which Interlock (Bit) Address setting (i.e. ON or OFF) effects the Touch function. The Touch available condition’s Bit Off setting is supported by only GP77R Series and GP377 Series units.

Word Address

Defines the word address for the write operation performed when the touch panel key is pressed.

Stores data used in the operation.

Screen Level Change Direction

When setting the screen change T-tag, check this check box to select Screen Level Change.

Reference “2.23.7 Screen Level Change Direction”

Constant Settings

Constant

Set up a fixed value in this field.

Dec

BCD

Hex

Set up the data format for the constant. Refer to the table on the next page for the valid setup ranges for the different operations.



Note: When using a T-tag to create a Change Screen switch, select the Set 16 Bit operation.

<Constant Data Setting Range>

Word Access	Constant
Set 16 Bit	-32768 - 32767
Set 32 Bit	-2147483648 - 2147483647
Add Binary 16 Bit	-32768 - 32767
Add BCD 16 Bit	0 - 9999
AND Binary 16 Bit	0 - 65535
OR Binary 16 Bit	0 - 65535
XOR Binary 16 Bit	0 - 65535

■ Mode/Special

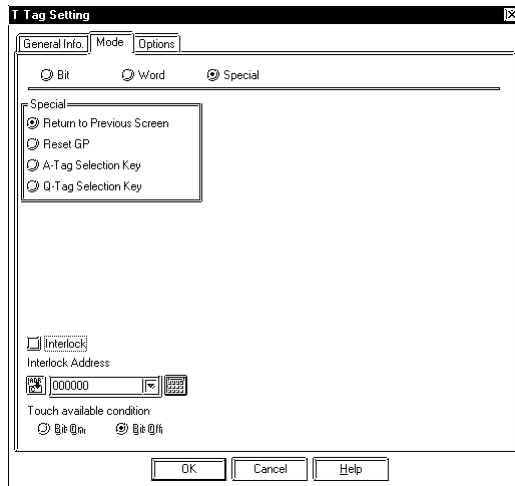

Special

Sets the touch panel key to be a special function switch used exclusively with the GP.

Return to Previous Screen

Pressing this touch panel key causes the previous screen image to return. It is possible to return to as many as 32 previous screens.

Reset GP

When the touch panel key is pressed, the GP unit restarts itself to return to the same condition as when powering up. At that time, the data in the LS area will be erased.

Interlock

The Interlock Address can be entered only when the Interlock is used to control the Touch screen's operation. The Touch available condition designates which Interlock (Bit) Address setting (i.e. ON or OFF) effects the Touch function. The Touch available condition's Bit Off setting is supported by only GP77R Series, GP377 Series and GP2000 Series units.



Note: Here, "Previous screen" means the screen displayed prior to the current screen, not the screen whose screen number is prior to the current screen.

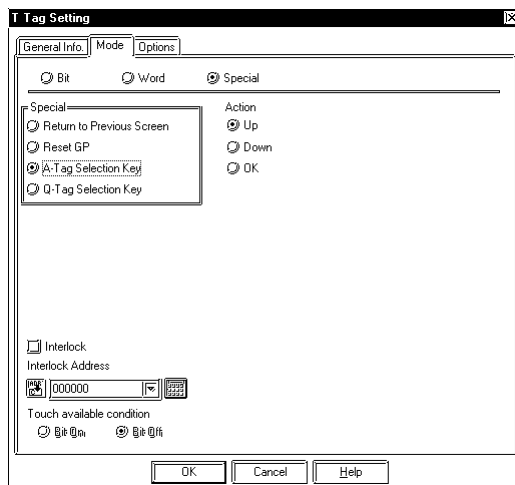

A-Tag Selection Key

When using the A-tag Sub Screen function, use these keys in the A-tag display area. There are three types: Up, Down, and OK.

Action

Up

Moves the highlighted cursor up a row in the A-tag display area.

Down

Moves the highlighted cursor down a row in the A-tag display area.

OK

Runs the Sub Screen (sub-display) display for the highlighted row.



Note: If the calling up of a window causes the current screen to contain more than a single (1) A-tag, the A-tag's item selection Key will operate on the A-tag that is front most on the screen.

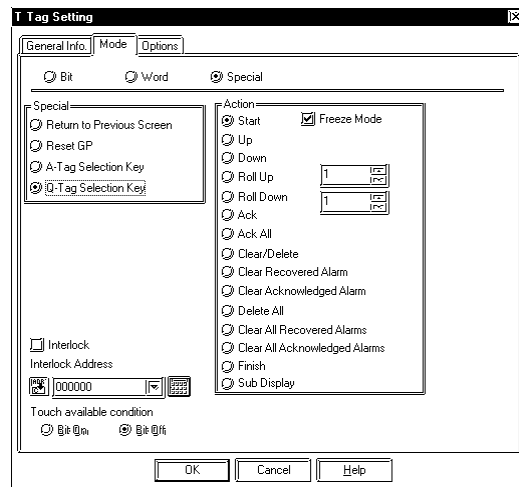

Interlock

The Interlock Address can be entered only when the Interlock is used to control the Touch screen's operation. The Touch available condition designates which Interlock (Bit) Address setting (i.e. ON or OFF) effects the Touch function. The Touch available condition's Bit Off setting is supported by only GP77R Series, GP377 Series and GP2000 Series units.

Q-Tag Selection Key

This feature allows you to use the features listed on the screen here.

Action

Start

This key begins operations in the Q-tag display area. Pressing this key causes a cursor to appear in the display area.

Freeze Mode

Check this check box to select the freeze mode.

Reference "2.20.5 Q-tag Examples", Q-tag

Up

Moves the highlighted cursor up in the Q-tag display area.

Down

Moves the highlighted cursor down in the Q-tag display area.

Roll Up

With this key, the specified number of lines' display data will be rolled up.

Roll Down

With this key, the specified number of lines' display data will be rolled down.

Ack

Pressing the Ack key will display the Ack time in the row the cursor is currently displaying.

Ack All

Pressing the Ack All key will attach (and display) the Ack time on all the messages displayed that do not yet have an Ack time.

Clear / Delete

Erases the message in the current row.

Clear Recovered Alarm

When "All Recovered Alarms" is selected, recovered messages will be deleted from the currently selected alarms.

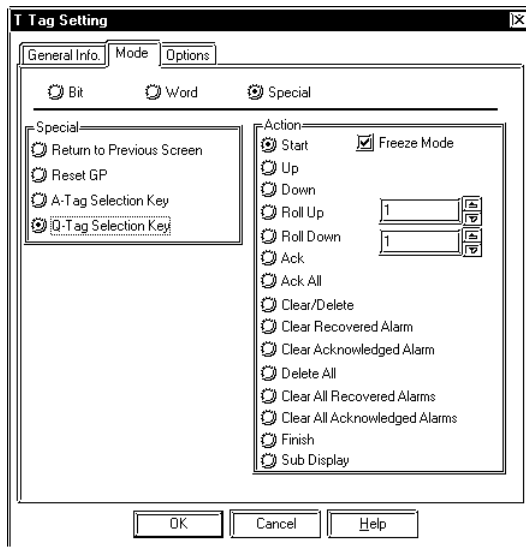

Clear Acknowledged Alarm

When the “All Ack Alarms” is selected, acknowledged messages will be deleted from the currently selected alarms. However, the control devices will not be deleted.

Delete All

Erases all the Q-tag messages displayed. However, the control device is not deleted.

Clear All Recovered Alarms

Erases all the recovered alarms.

Clear All Acknowledged Alarms

Erases all the acknowledged alarms. However, the registered control devices are not deleted.

Finish

This key ends key entry operations as the cursor disappears.

Sub-display

Pressing the Sub-display Key with Q-tag’s sub-display selected calls up the designated sub-display screen.

* GP-270 does not support this function.



Be sure to create the Q-tag select keys for the Q-tag’s display screen that the Q-tag is designated. They cannot be used if they are set on the screen that the Q-tag is not set. Also, they cannot be used when two or more Q-tags are created in a single screen.

■ Options

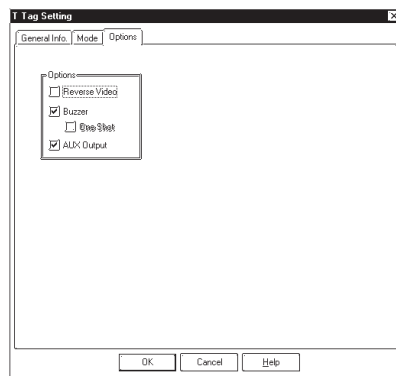

Options

Reverse Video

Defines whether touch areas highlight while the touch panel key is pressed.



Note: When copying a screen data created by a screen creation software older than GP-PRO/PBIII, if a touch panel key uses fills, the filling may blink in Reverse mode. To avoid this reaction, do not use Reverse Video with a fill pattern.

Buzzer

Defines whether or not a beep sounds when a touch panel key is pressed.

One Shot

Reference “2.23.4 One-Shot buzzer for T-tag momentary”

AUX Output

Defines whether or not a buzzer signal is sent from GP’s AUX I/F. This function is invalid for the GP-270, GP-H70, GP-370, GP-377R, GP-377, GP-2300 and GP-2301 because they do not have an AUX I/F.

2.23.4 One-Shot Buzzer for T-tag momentary

This section describes how to set up the one-shot buzzer during the T tag momentary operation. Only the GP77 series, GP377 series and GP2000 series support this function.

- **When both the buzzer sound and the one-shot buzzer sound are ON, the buzzer sounds only once when the touch panel switch is depressed.**

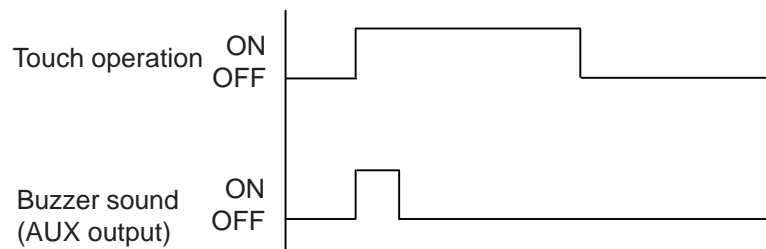

- **When the buzzer sound is ON, and the one-shot buzzer sound is OFF, the buzzer continues to sound while the touch panel switch is depressed.**

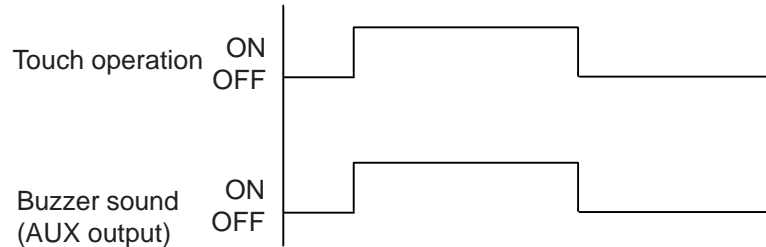

- **When the buzzer is OFF, the buzzer does not sound.**

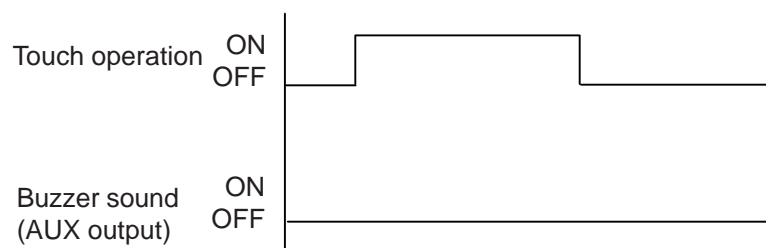

■ **The one-shot buzzer settings are valid under the following conditions.**

- 1 Momentary of the bit action
- 2 Momentary of the group with the bit action automatic OFF function
- 3 Inching output (Tih tag, Tiw tag)

The inching output can be activated only in the large model of the GP77R Series. The GP377RT, GP377L/S and GP2000 series do not offer the inching output function.

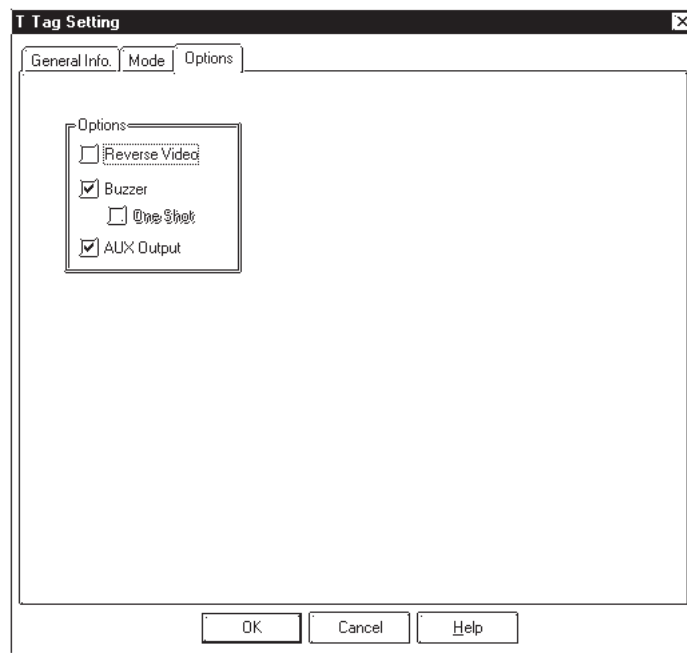

2.23.5 Setting Up T-tags

■ Touch Panel Grid

Grids are made up of dots which are uniformly spaced on the area for creating screen.

Touch panel grids on the GP panel are grids that have been designated in 20×20 dots. Turn ON the touch panel grid when drawing T-tags, or setting the coordinates of a touch area's start and end points. If, however, a grid's point is located in the middle of a key, touch input may be hindered. The touch to the point on the touch panel grid may not be effective. Therefore do not place the grid near the center of the touch panel keys.

If a grid point is in the center of the touch panel key it may be difficult to register touch input. Also, if a touch panel key is not designated as a square area, it will not operate as a touch panel key.

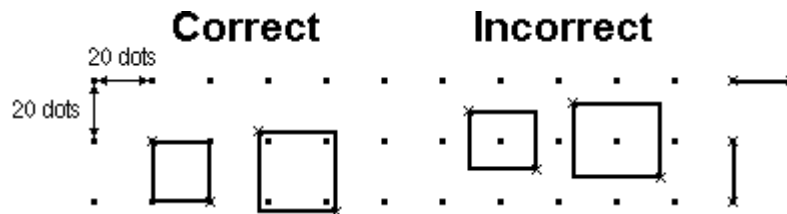

For more information on the touch grid settings,

Reference *Operation Manual, "2.8.1 Grid/Snap"*

2.23.6 Changing Screens

There are two methods to change the screen:

- Send data from the host (PLC)
- Use a touch panel key on the GP unit.

If the above two methods are used jointly, the screen change made from the touch panel key has higher priority. Additionally, the GP has a forced screen change function.

Listed below are the priority levels for screen image display changes.

- | | | | |
|----|------------------------------------|------|---|
| 1. | Forced screen change | high | |
| 2. | GP touch panel based screen change | | ↓ |
| 3. | PLC-based screen change | low | |

■(1) PLC-Based Screen Changes

This section’s explanation is for when Direct Access format is used.

In this case, it is assumed the System Data Area will be allocated all 20 words. Section (2), (3), and (4) use the same setups.



Note: When using the Memory Link format, and depending on the System Data Area settings, the System Data Area addresses may be different than those provided below.

Reference *Device/PLC Connection Manual, 1.1.4 Contents and Range of System Data Area*

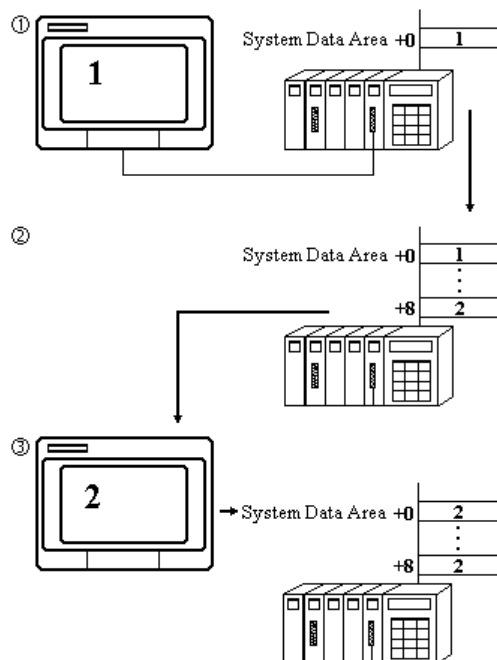

Screen Number 1 is the current display on the GP.

System Data Area +0 on the host (PLC) contains number 1, which represents the screen number currently displayed.

To change the display to the screen whose number is 2, the host (PLC) writes 2 to System Data Area +8, which stores the change screen number to be displayed.

The screen displays the screen whose number is 2.

As the display changes from image 1 to image 2, the contents of area +0 in the host (PLC) also changes to 2.

■ (2) GP Touch Panel Based Screen Change

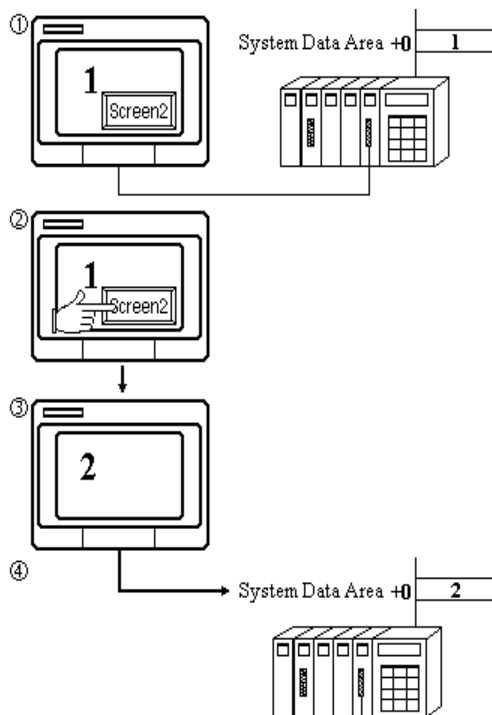

Screen Number 1 is the current display on the GP.

System Data Area +0 on the host (PLC) contains the number 1, which represents the screen number currently displayed.

Touch panel input causes the display to change to screen number 2.

The screen displays screen number 2.

At the same time, 2 is written to System Data Area +0 on the host (PLC).



Note: When a screen change is caused by touch panel input, the contents of PLC System Data Area +8 do not change.

■ (3) When the Touch Panel Key Has Higher Priority

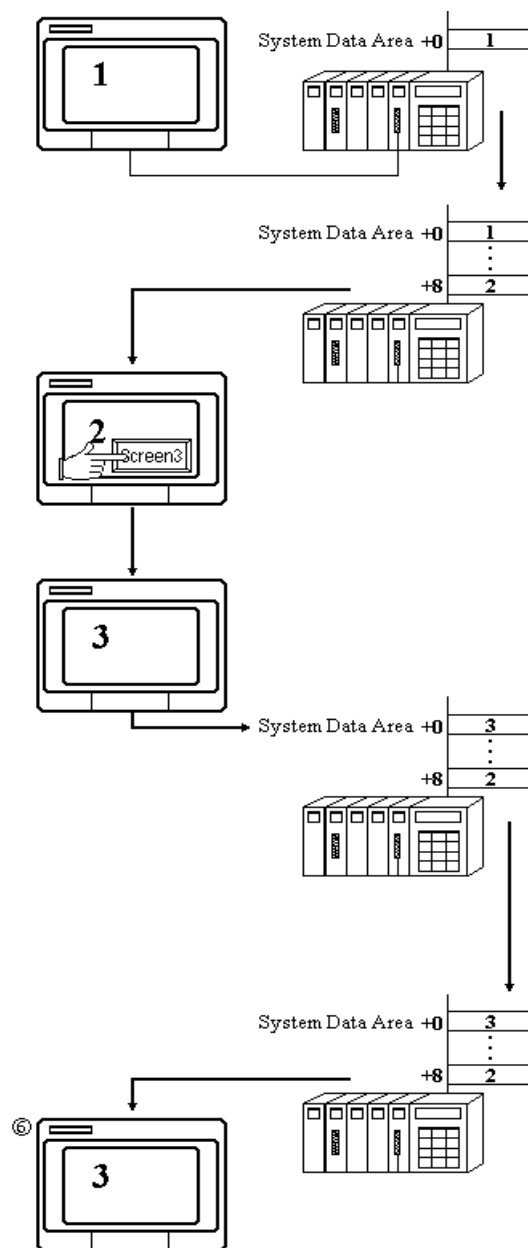

1) Screen Number 1 is the current display on the GP.

System Data Area +0 on the host (PLC) contains the number 1, which represents the screen number currently displayed.

2) To change the display to screen number 2, the host (PLC) writes the number 2 to System Data Area +8.

3) The screen changes to display screen number 2.

4) After this, the touch panel input causes the screen to change to screen number 3.

(The display changes to screen number 3.)

5) System Data Area +0 on the host (PLC) now contains the number 3.

When screen changes are made by touch panel, the contents of PLC System Data Area +8 do not change. PLC System Data Area +8 still contains the number 2.

6) The host (PLC) generates another request to change the display to screen number 2.

However, since the data written to address +8 is still the same, the GP does not register any changes in data, so it does not perform the screen change. **Screen number 3 continues to display.**

In step 6, even if you press a touch panel key to change to screen number 2, the screen change will not take place. To prevent this, an extra level must be added to the ladder program that compares +0 and +8, and if equal, erases the contents of +8.

E.g. When using Mitsubishi PLC

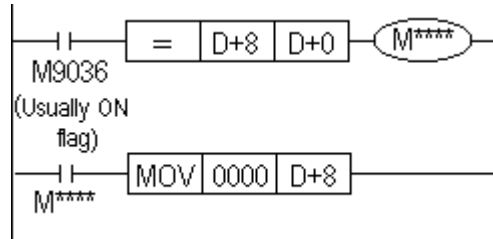

■ (4) Forced Screen Change

A forced screen change operation takes place when the host (PLC) System Data Area +8's (Change Screen Number storage address) top bit is set to 1.

Add 8000h to the desired screen number before writing this data to the System Data Area. Only valid from the host (PLC) side.

The forced screen change has priority over other screen change operations.

E.g. To change to screen number 2

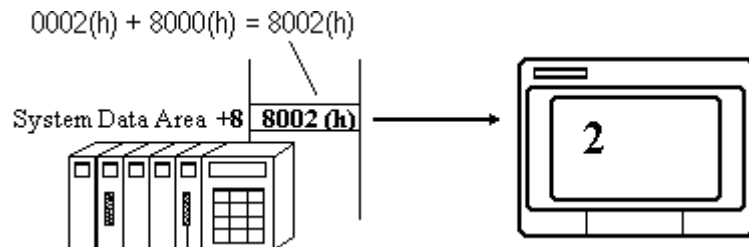

When the touch panel input has the highest priority for screen change, the screen change does not take place even if the same data is written to host (PLC) System Area +8 (as in step 6 of the previous page).

However, when using the forced screen change, the actions explained previously can bring about a screen change.



When forcing a screen change when screen number data is in BCD form, set up the system so as it is controlled in the screen number range 1 to 1999.

◆ Releasing Forced Screen Change

Forcing a screen change causes an inability to make any touch panel screen changes until the enforcing bit is released.

That is, the top bit in the data in the +8 address must be set OFF. Only valid from the host (PLC) side.

2.23.7 Screen Level Change Direction

The screen change pattern (path) can be controlled by GP-PRO's tags. To create this path select the Project Manager's GP System Settings Area's "Screen Level Change Direction" option. Then, when you place T-tags on a screen that has been registered as using this function, the screens will change according to the Path shown below. If you then turn this function OFF (i.e. deselect it), all T-tag screen changes will simply return (jump) to the previous screen, regardless of level.

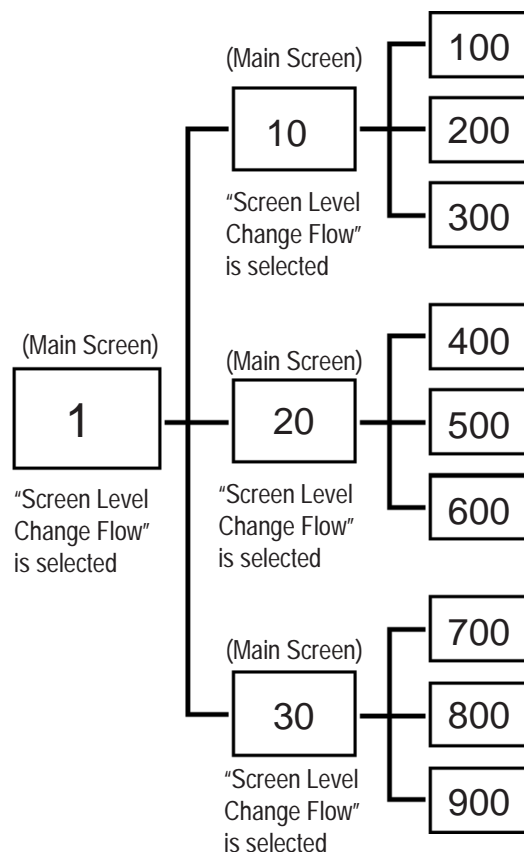

<E.g.>

For a project with the screen hierarchical structure shown above, any screen can return to the main screen using T-tag's "Return to Previous Screen" option, by the Screen Level Change function.

To do this, select the "Screen Level Change Flow" option for T-tag on each main screen, i.e. Base screens "1", "10", "20", and "30". Also select the "Screen Level Change Flow" option in the "GP System Settings" field of the Project Manager.

Thus, the user can jump directly from screen 200 to (main screen) 10, instead of to screen 100.

To use this feature:

- 1: Change from Base screen "1" to "10" using the T-tag "Word" selection.
- 2: Change from Base screen "10" to "100".
- 3: Change from Base screen "100" to "200".
- 4: Change(jump) to Base screen "10", by touching a T-tag with the "Return to Previous Screen" option selected.



- **Note:** Screens jumped to using commands other than the T-tag or W-tag's "Screen Level Change" option will be handled as being on the same level.
- To select the "Screen Level Change Direction" option for a project, be sure to first select the "Screen Level Change Direction" option for the GP System Settings.



2.24 t-tag (Selector Switch Input)

2.24.1 Overview

Using this tag you can create a touch panel object that can setup multiple bit addresses. Each time the object “switch” is pressed, one switch address bit turns OFF and another address bit turns ON.

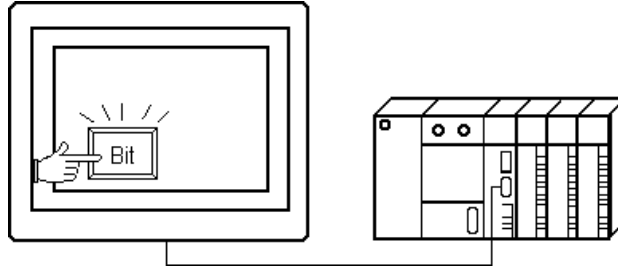

Set Address	1: M0005	2: M003	3: Y0002	
		• Press the touch key.	1: M0005	ON
			2: M0035	OFF
			3: Y0002	OFF
		• Press the touch key again.	1: M0005	OFF
			2: M0035	ON
			3: Y0002	OFF
		• Press the touch key again.	1: M0005	OFF
			2: M0035	OFF
			3: Y0002	ON
		• Press the touch key again.	1: M0005	ON
			2: M0035	OFF
			3: Y0002	OFF



Each time the touch panel key is pressed, a bit on an address turns ON as follows:

M0005→M0035→Y0002→M0005→M0035 ... and so on.

2.24.2 About t-tags

- Pressing a single touch panel key causes the bit addresses to turn ON in the order set up. Determine the order of the bit addresses and set them up. The initial press turns the first bit address ON; the second press turns the next bit address ON and the first bit address OFF.
- 2 - 4 bits can be set in each t-tag.
- Even on different screens, the same bit operation is possible.

- The minimum unit for the touch panel key is 20×20 dots.
- Pressing T-tag's touch panel key can cause a buzzer output through the AUX(I/O) interface (hereafter referred to as "AUX I/F) provided at the rear of the unit. The GP-270, GP-370, GP-H70, GP-377R, GP-377, GP-2300 and GP-2301 do not support this function because they do not have this AUX I/F.



Do not use a touch panel key for extremely important switches, such as an emergency stop switch. Instead, provide a separate hardware switch.



Immediately after changing screens, touch panel keys may be temporarily disabled because the processor is busy drawing the screen.



- If multiple T-tags or t-tags are set on the same screen position, all the "switches" are pressed when the multiple T-tags or t-tags defined area is pressed. Extra communication time may be required to process each touch input.
- After powering up the GP, and one of the bits set for the t-tag is ON in the host (PLC), the initial press of the switch causes the bit next to the currently ON bit to turn ON. Plus, when more than one bit is ON, then pressing the switch causes the first bit of defined addresses to turn ON.

2.24.3 Using t-tags

■ General Info.

The General Info. page provides information about the current settings for the t-tag.

Tag Name

Must be no more than five Single-byte or two Double-byte characters long and composed of letters and/or symbols.

Description

Up to 20 Single-byte or 10 Double-byte characters can be entered as a description of the tag .

■ Address Setting

Selection Number

Set up the Select Number within the range of 0 - 2047, which is used as valid control number for the entire system (all the screen data to be sent to GP). It recognizes and remembers the touch operation number performed, and if other t-tags have the same Select Number, then they too will use the same administrative data whenever pressed.

However, to use the same t-tag Select Number effectively, set the same bit addresses along with the same Select Number, so the same bit operations can be performed between different screens without any adverse effects.

No. of Set Addr.

Defines the number of bits operated by this touch panel key (t-tag). Setup a value of 2 - 4.

Bit Address

Enter the bit addresses operated by the t-tag. The input fields are ordered, from 1 onwards. Thus, touch inputs will follow this order.

■ Options

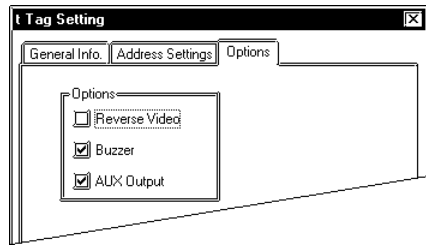

Reverse Video

Defines whether touch areas highlight while the touch panel key is pressed.



Note: When a touch panel key uses fills, the filling will blink in Reverse mode. To avoid this reaction, do not use Reverse with a fill pattern.

Buzzer

Defines whether or not a beep sounds when a touch panel key is pressed.

AUX Output

Defines whether or not a buzzer signal is sent from GP's AUX I/F. This function is invalid for the GP-270, GP-370, GP-H70, GP-377R, GP-377, GP-2300 and GP-2301 because they do not have an AUX I/F.

2.25 Tih / Tiw-tags (Inching Function) *

2.25.1 Overview

This feature creates a touch panel object that sends “inching output” directly to the host’s (PLC’s) digital input (DIN) relay. Tih / Tiw-Tags send momentary inching information via the AUX (I/O) interface (hereafter referred to as “AUX I/F”) on the GP, from the touch panel to a digital input (DIN) relay on the host (PLC). This allows instantaneous fine adjustment, using just the touch panel key. Use this function to make fine adjustments in the interrupted position of objects on an assortment of lines.

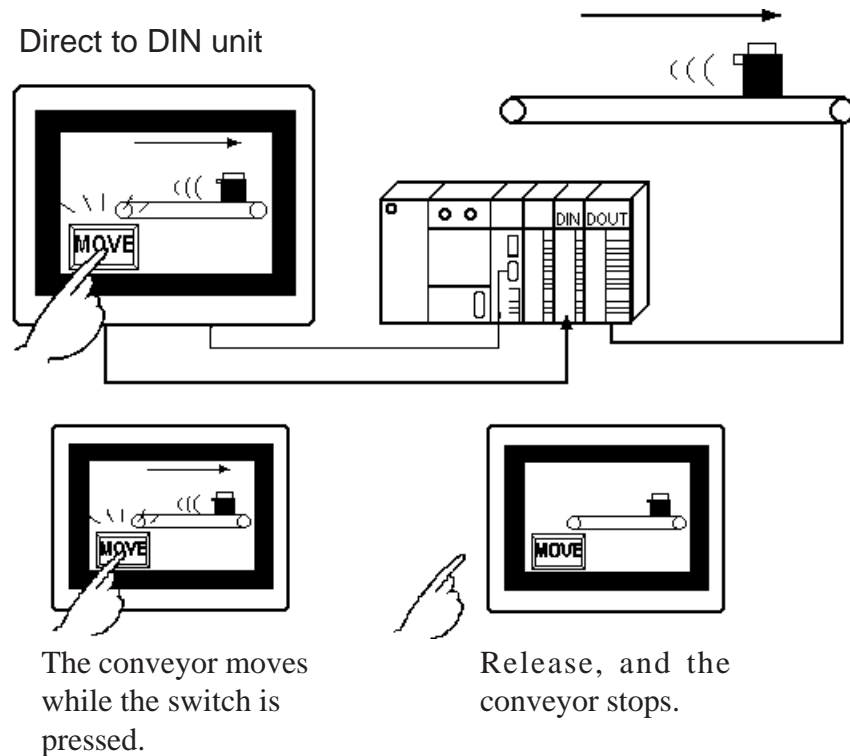

* GP-270, GP-370, GP-H70, GP-377R, GP-377 and GP-2000 cannot send the “inching output” information.

2.25.2 About Tih / Tiw-tags

- Since outputs are sent directly to the host’s (PLC’s) DIN relay via GP’s AUX I/F, the time required for data communication is shortened.
- There are two types of inching outputs: bit output and data output (byte output).
 - Bit output . . . Tih-tag
 - Data output . . . Tiw-tag

Both operation modes are fixed, and they send outputs only while the touch key is pressed. Even normal address settings are unnecessary.

* This function is available on the GP-470, GP-570, GP-571, GP-675, GP-870, GP-477R and GP-577R.

<Tih-tag>

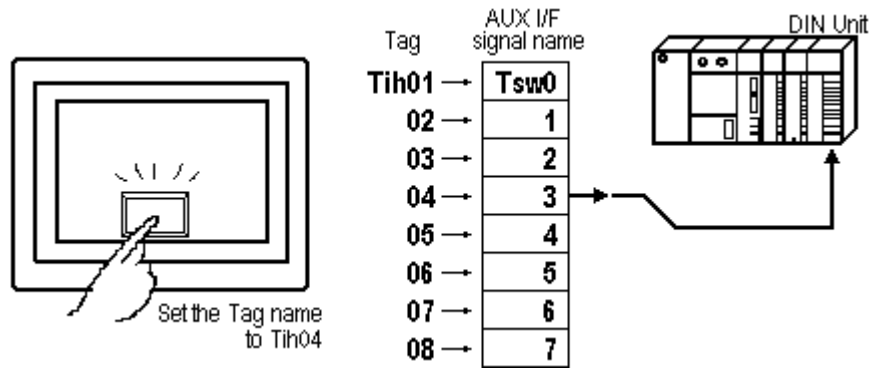

<Tiw-tag>

While pressing the touch panel key, the AUX signals corresponding to the Tiw settings turn ON.

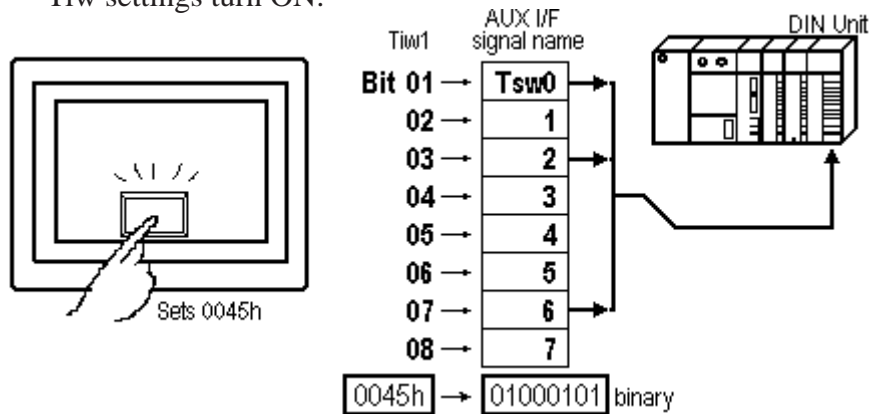

- In the same way as an inching output, a buzzer signal can be sent to the AUX I/F.
- The maximum number of Tih-tag settings on each screen is 8, and 256 for the Tiw-tag setting.



Note:

- While data is being sent to DOUT, it is possible the host's (PLC's) DIN unit is simultaneously sampling data. In such cases, your ladder program should be created so that the data is read again.
- For more on AUX I/F
 - ▼ **Reference** ▲ *Each GP Series' User's Manual, "AUX Input/Output"*
- For more on the touch panel switch position
 - ▼ **Reference** ▲ *"2.23.5 Setting Up T-tags", T-tag*

* This function is available on the GP-470, GP-570, GP-571, GP-675, GP-870, GP-477R and GP-577R.

2.25.3 Using Tih-tags *

■ General Info.

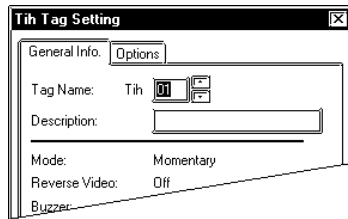

The General Info. page provides information about the current settings for the Tih-tag.

Tag Name

Must be one of the following names: Tih 01, 02, 03, 04, 05, 06, 07 and 08.

Description

Up to 20 Single-byte or 10 Double-byte characters can be entered as a description of the tag.

■ Options

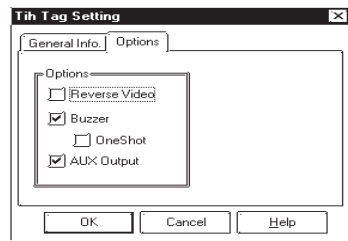

Options

Reverse Video

Defines whether touch areas highlight while the touch panel key is pressed.



Note:

When copying a screen data created by a screen creation software older than GP-PRO/PBIII, if a touch panel key uses fills, the filling may blink in Reverse mode. To avoid this reaction, do not use Reverse Video with a fill pattern.

Buzzer

Defines whether or not a beep sounds while a touch panel key is pressed.

AUX Output

Defines whether or not a buzzer signal is sent from GP's AUX I/F.

* This function is available on the GP-470, GP-570, GP-571, GP-675, GP-870, GP-477R and GP-577R.

2.25.4 Using Tih-tags

■ General Info.

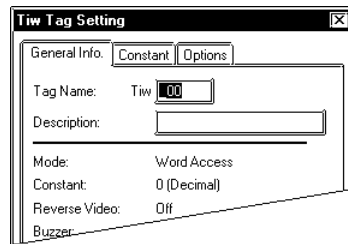

The General Info. page provides information about the current settings for the Tih-tag.

Tag Name

Must be no more than three Single-byte or one Double-byte characters long and composed of letters and/or symbols.

Description

Up to 20 Single-byte or 10 Double-byte characters can be entered as a description of the tag.

■ Constant

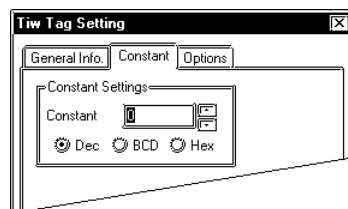

Constant Settings

Constant

Turns the AUX signal ON, according to designated constant's value, and the data format.

Dec

BCD

Hex

Also set up the data format of the constant.

▼Reference▼ “2.24.4 Setting Up T-tags - Decimal, BCD, and Hexadecimal values can be set up in the Constant field.”, T-tag

■ Options

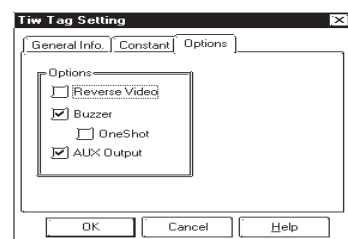

Options

Reverse Video

Defines whether touch areas highlight while the touch panel key is pressed.



Note: When coping a screen data created by a screen creation software older than GP-PRO/PBIII, if a touch panel key uses fills, the filling may blink in Reverse mode. To avoid this reaction, do not use Reverse Video with a fill pattern.

Buzzer

Defines whether or not a beep sounds while a touch panel key is pressed.

AUX Output

Defines whether or not a buzzer signal is sent from GP's AUX I/F.

* This function is available on the GP-470, GP-570, GP-571, GP-675, GP-870, GP-477R and GP-577R.

2.26 U-tag (Window Display)

2.26.1 Overview

This tag places a screen, registered as a window, over the currently displayed Base screen. The standard Base screen remains displayed and other screens (windows) created using the U-tag, such as a numeric keypad, can be placed over the Base screen when desired.

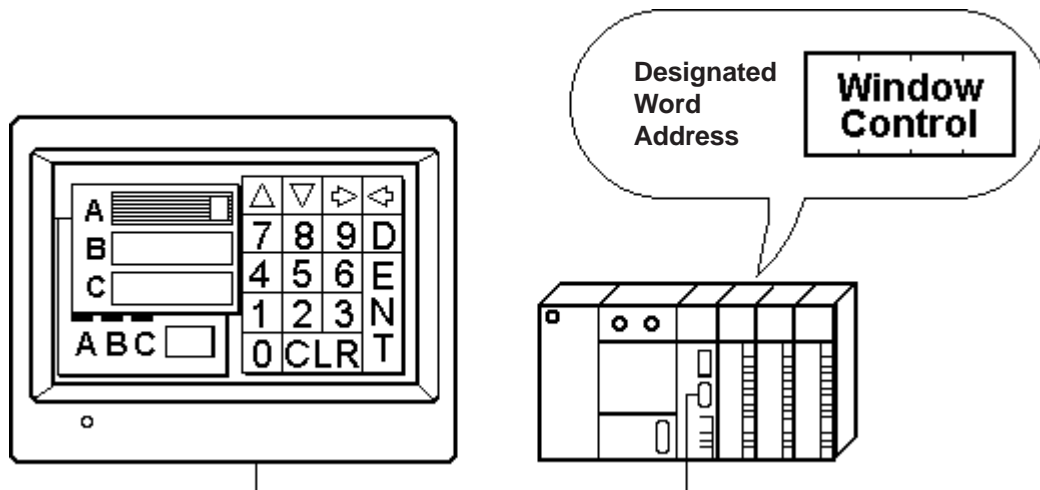

2.26.2 About U-tags

- Direct or indirect methods may be used to designate which window to display or the position to display a window.
 - Direct The window and its display position are fixed. Only one word address is necessary for the operation.
 - Indirect The windows displayed and their display positions can change dynamically. Four consecutive word addresses are necessary for the operation.

▼ **Reference** Operation Manual, “3.7 Window Display: Window (U) Screen and Base (B) Screen”

- There are two types of window display methods: Global Window Display and Local Window Display.
 - Global Window Display Displays a window common to all screens.
 - Local Window Display Displays a window setup exclusively for the particular Base screen.

Up to four windows (one Global Window and 2 Local Windows and one Video Window) can be displayed simultaneously on a single screen.

* The video window is displayed via a v-tag (on a GP2000 series unit equipped with an optional VM unit.).

- Touch panel keys hidden under windows will not operate.
- When displaying multiple windows that overlap on a screen, the window called up last displays at the very front. The window displayed in the background can be brought to the front simply by touching it. However, if you press a touch panel key on the background window, the T-tag operation will process first before moving the window to the front.

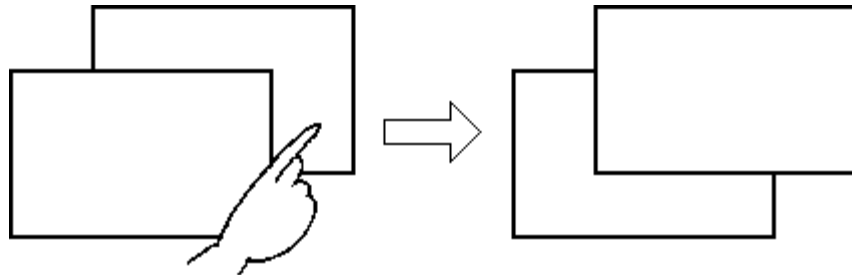

When you press the area
of the window below...

It moves up to the front.

- To display window data quickly, select high speed display setting.



- **If the total number of tags on the current Base screen and windows exceeds 256 (128 for the GP-270, GP-370, and GP-H70) (excluding the R-tag display positions and k-tags,), the 257th tag and later tags do not operate. The tags become invalid in the order of the last displayed window.**
- **If the total number of display positions for all R-tags combined, on the current Base screen and any windows, exceeds 512 (256 for the GP-270, GP-370, and GP-H70), the 513th position and later positions do not display or operate.**
- **When U-tag's "High Speed" is selected, even though a window is not currently displayed, its device data write tags (W-tag, D-Script, etc.) will be activated when a trigger occurs. If, however, you wish to have the window appear before device data writing is activated, you need to deselect this "High Speed" setting.**
- **K-tags, U-tags, V-tags, v-tags, Line Graphs (T screen and parts), Setting Value Display Device and Logging Display Device will not operate when called up to another screen.**



- **When a undefined registration number is designated on the Base screen currently displayed, or if the Base screen on which the window is created is missing, the window will not display.**

- For information on window screen registration

Reference *Operation Manual, "3.7 Window Display: Window (U) Screen and Base (B) Screen"*

- **Activating ON/OFF or switching a window with another resumes the tag operation from the first tag on the Base screen.**
- **Activating ON/OFF, switching, and moving a window is performed between tag operations.**

2.26.3 Global Window Display

You can set up the Global Window Display directly on the GP, by selecting the USE option in the INITIALIZE/SYSTEM ENVIRONMENT SETUP/ GLOBAL WINDOW SETUP. Or open the GP [Setup] window, view the [Expansion] area's data, click on the Global Window button, and set the Global Window ON. The window set up here is then common to all the screens.

When using GP system settings: **Reference** "2.26.7 GP System Area Global Window Display Settings", U-tag

When using GP: **Reference** GP 70 Series User's Manual, "GLOBAL WINDOW SETUP"

Use a special area reserved in the System Data Area for the window display operation.

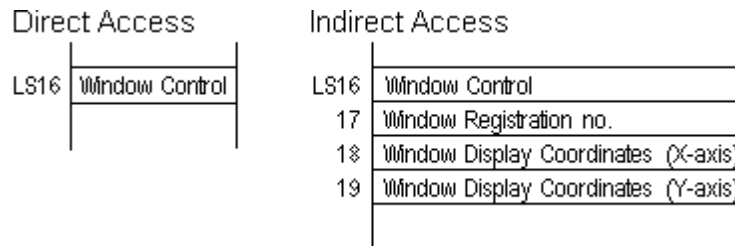

◆ **Window Control**

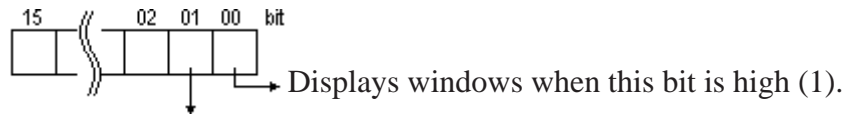

Changes the display order

When the bit is 0 (zero), the display order for multiple overlapping windows can be adjusted. If the bit is 1 (one), the order cannot change as a result of pressing on the window.

◆ **Window Display Position**

When a window is accessed indirectly and the normal type is selected for the GP Display Type, the coordinates of the window's upper-left corner is set up using absolute value. At this time the upper-left corner of the Base screen becomes the origin (0,0). The X position can only be set at 8 dot intervals.

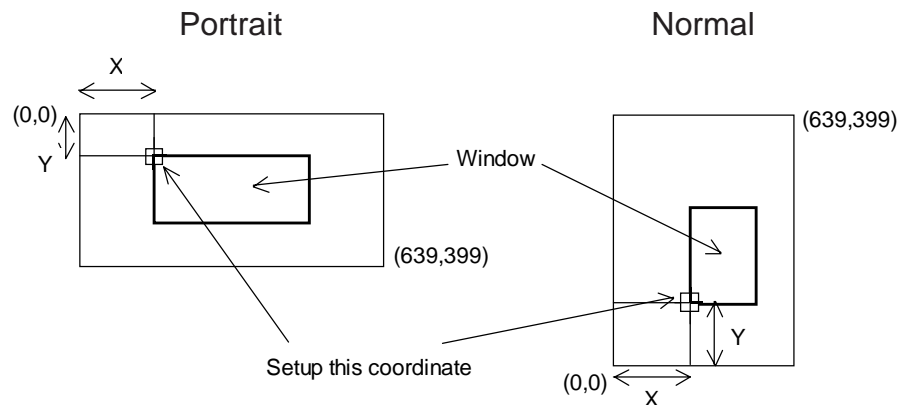



- **Note:** If the window is accessed directly, settings other than the Window Control are performed in GP-PRO/PBIII, so areas LS17 - 19 become unnecessary. Set the window registration number in a dialogue box, and set the display position directly on the screen.
- To operate the Global Window Display from the host (PLC), setup and use GP's exclusive Global Window Display area in the GP Setup or the GP's INITIALIZE OFF-line menu.
- To operate the Global Window Display, use the Global Window Setup in GP's INITIALIZE OFF-line menu or Program Manager's [Setup] area.
- If the Device Monitor is loaded during the Global Window Display, the Global Window Display will end temporarily. It will appear again after the Device Monitor ends.
- To use the Device Monitor, "Indirect" and "Bin" should be selected for the Window Setting.

2.26.4 Local Window Display

Local Window Displays are set up on individual Base screens using U-tags. These windows are exclusive to the corresponding screen.



Note: Local Window Display can also be set up with Window Parts.

Multiple numbers of U-tags can be set on each Base screen; however, the number of windows that can be displayed simultaneously is up to two. If multiple U-tags have been set up, operate so that only necessary windows display on the screen.

Window display controls are performed at the designated word address.

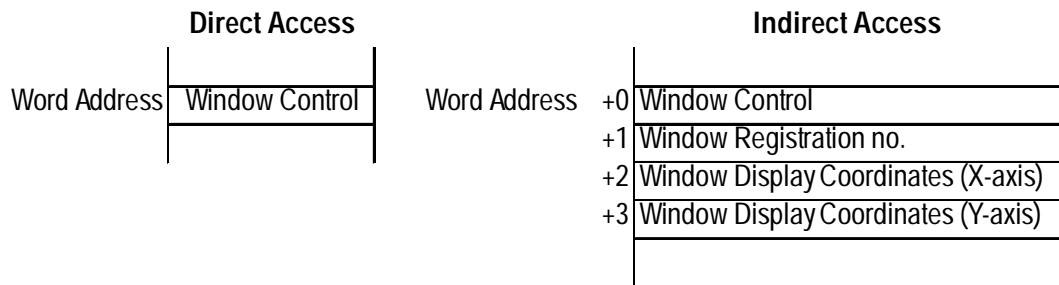

Each bit function for the Window Control is the same as in the Global Window. Set the Window Display Position's X-coordinate data in 8-dot intervals.

2.26.5 Using U-tags

■ General Info.

U Tag Setting

General Info. Designated Window

Tag Name: U 0000

Description: [Empty]

Word Address: D00000

Bit Address:

Designated Window: Direct; 1

Data Format: [Empty]

Touched Screen To Front: [Unchecked]

The General Info. page provides information about the current settings for the U-tag.

Tag Name

Must be no more than five Single-byte or two Double-byte characters long and composed of letters and/or symbols.

Description

Up to 20 Single-byte or 10 Double-byte characters can be entered as a description of the tag.

■ Designated Window

U Tag Setting

General Info. Designated Window

High Speed

Word Address: D00000

Touched Screen To Front

Designated Window: Direct

Window Registration No.: 1

OK Cancel Help

High Speed

When this check box is checked, display speed used when a window is called up is increased. However, since even when the window is not displayed, tag data specified on the window is read (excluding touch input tag data), the other tag display speeds will be decreased. The “High Speed” option and a deselected U-tag cannot be specified on the same screen. Never use Keypad Input Display with the pop-up keypad when Window Access is set to the “High Speed” option.

Word Address

This setting only refers to the Local Window Display. The word address designated here is the start address of the area used for window display operations. If the Window Access is set to Direct, only this word address (1 word) is used; if Window Access is set to Indirect, four consecutive word addresses are used, beginning from this word address. When the “High Speed” check box is checked, set a Bit Address.

Touched Screen To Front

When this check box is checked, and when multiple windows are displayed on the screen, the current window display will be moved behind all other screen windows, simply by touching it. This option is enabled only when the “High Speed” option is selected. When the “High Speed” option is not selected, select this option via the system area’s “Window Control”.

Reference “2.26.3 Global Window Display”



- For Global Window display, addresses used for the window display operation are set in the System Data Area. Be sure to set the addresses used for the window display via the GP [Setup] or [INITIALIZE] settings.
- Up to 2 U-tags can be set with the “High Speed” option selected on the same screen.
- If the U-tag with the “High Speed” option selected has a W-tag or D-script data write settings (to a device), data write is performed as if the required conditions are satisfied even when the window has been designated as being not displayed. When “High Speed” is not selected, however, this data write is not performed.
- The “High Speed” function is the same as the “High Speed” function of this software’s version 2.0 or earlier.

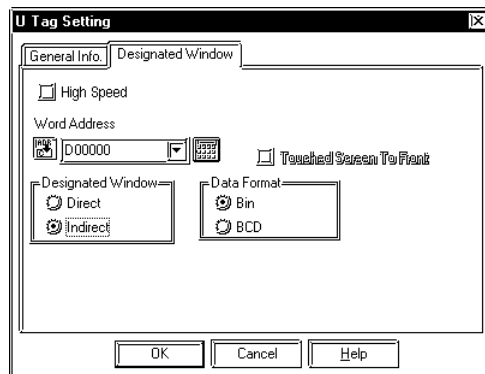

Designated Window

Direct

The window display screen and display position are fixed. The window display screen is designated by the window number entered in the Registration No. field. After completing the U-tag settings, set the window display position is also set directly on the screen.

Window Registration No.

This setup is only available when Window Access is set to Direct. Set up the screen number that will be used for the pop up window.

Indirect

The window display screen and display position are variable. Alterations are made by storing data to the set word addresses. The Indirect option is effective only when the “High Speed” option is selected.

Data Format

Bin

BCD

Defines the format for the display position and window registration data in the word addresses. Only available when Window Access is set to Indirect.

2.26.6 U-tag Examples

- Base screen

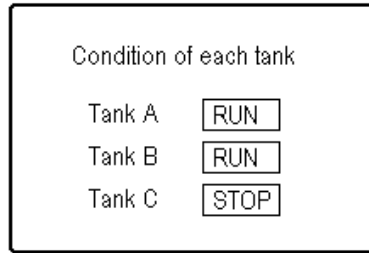

Setup a U-tag to display a Local Window on the Base screen

- Window Access: Indirect
- Word Address: D0100

- Window no. 1

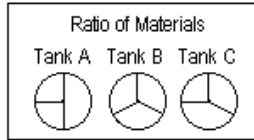

- Window no. 2

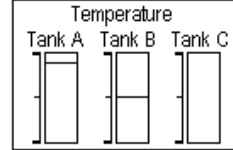

⋮

When the U-tag display window is set up as Indirect, the four consecutive word addresses beginning from the set word address will automatically be used for controlling the window display.

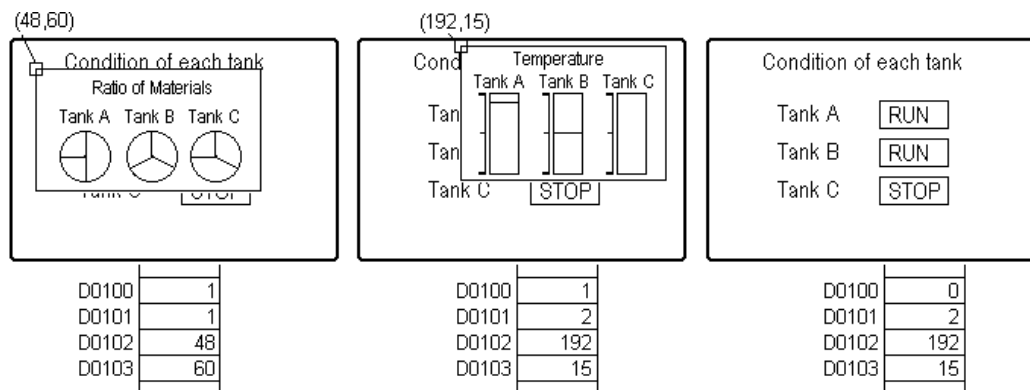
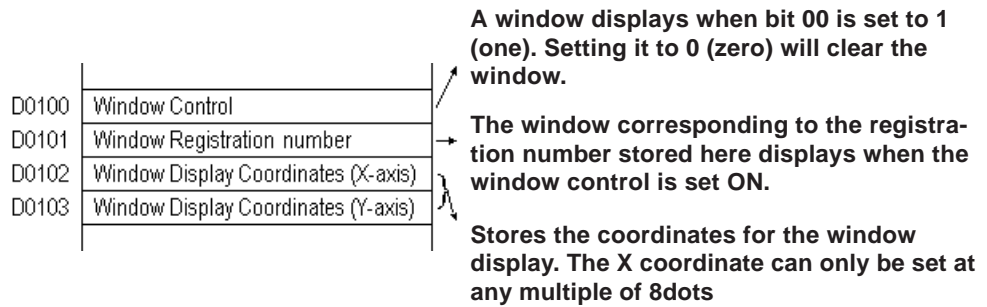

Window no.1 displays at point (48, 60). **Window no.2** displays at point (192, 15)

No window display, despite the data in addresses D0101 - D0103.

2.26.7 GP System Area Global Window Display Settings

■ Displaying Global Window Using GP System Settings

In the GP's [Setup] area turn on the Global Window setup by selecting the Global Window item from the Expansion menu.

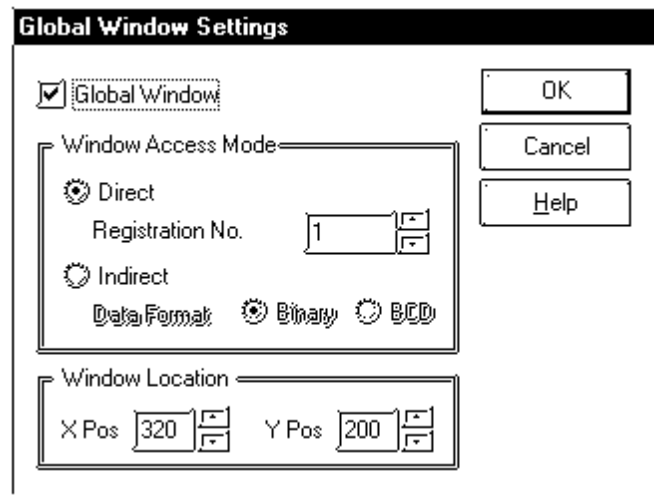

◆ Global Window

Set up the Global Window ON or OFF (checked or not checked). If you wish to use the Global Window, check this box.

◆ Window Access Mode

When using the Global Window, set up how to activate the window here.

Direct : Window Registration No. and Window Location settings are fixed values. Enter the registration no. on the Registration No. field.

Indirect : By using the area reserved for entering the Window Registration number in the System Area, multiple windows can be used as the Global Window. As well, the Global Window Location can also be adjusted using the same method. Also, be sure to set the Data Format used for these address's values.



Note: To use the Device Monitor, “Indirect” and “Binary” must be selected for the Window Access.

◆ Window Location

Valid only when the Global Window Access is set to Direct, set up the window display coordinates here. These coordinates assume the top-left corner is the origin point when the normal type is selected for the GP Display Type. When the portrait type is selected, these coordinates assume the lower-left corner is the origin point.

2.27 V-tag (Video Window Display)

2.27.1 Overview

This tag is supported only by the GP-570VM/(870VM)/2500T/2600T VM unit models. This tag, using a video signal, is used to display a video window. Depending on the control attributes and video ID setup, it is possible to display up to three video signals. While viewing the display, touch key and other operations are possible.

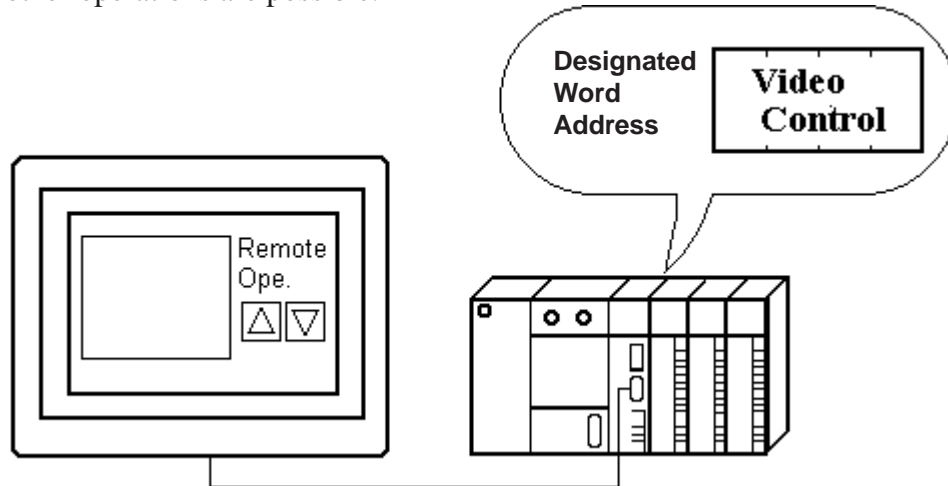

2.27.2 About V-tags

- According to the video ID number entered, the ID number and corresponding various control information can be combined together and called up.

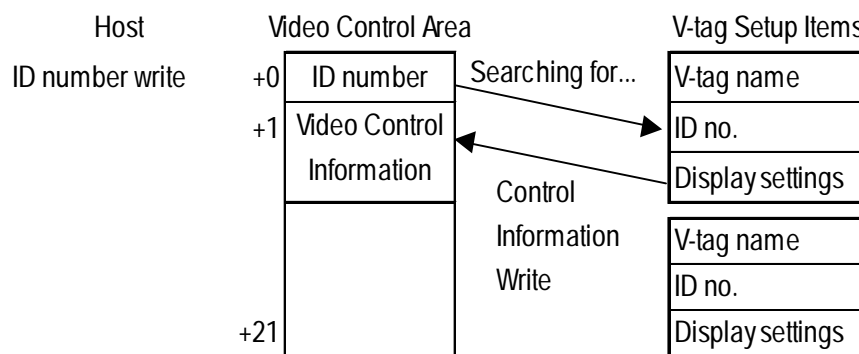

It is unnecessary for the host (PLC) to receive a large amount of video control data at the start, since the video display begins with just the setup ID number. Each ID number's control information (setting items) can be collected in the GP, thereby reducing the load on the host (PLC).

* This function is only available with the GP-570VM/(870VM), and GP-2500T/2600T units that are equipped with the optional VM unit.

- Select the video window Display Size: Standard or Zoom.
- A transparent video window display is also possible.
- Touch panel input on the video window can be either ON or OFF.
- Other than writing the ID number from the host (PLC), the video window can be controlled dynamically from the host (PLC) directly by changing the data in the Video Control Area data.
- V-tags can be used only on Base screens. Up to 32 can be used on each screen, however, only 1 video window at a time can be displayed.
- Even if the Portrait type is selected for the GP Display Type, the video display and VGA display cannot be displayed in portrait orientation. It is also necessary to set up the VCR so that the display will appear in portrait orientation.
- The Portrait display coordinates for the Video Window are as follows:

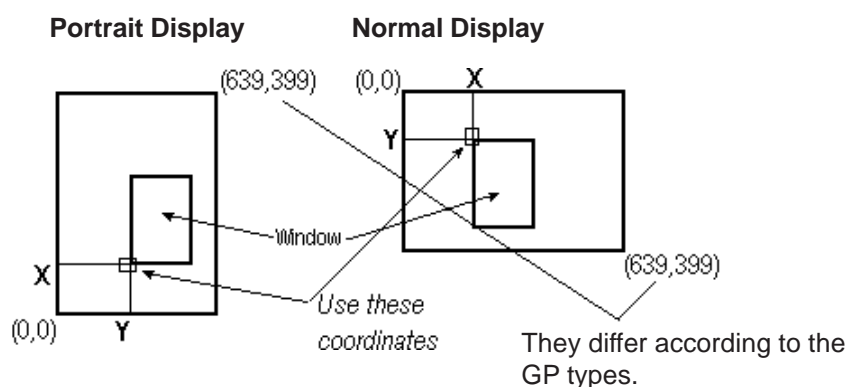

- **When using a V-tag, you must select "Standard Mode" in "Video Setting" in the "GP System Settings."**

Reference *Operation Manual, 3.6 Video Data Display (V Screen)*

- **The video area of the GP-2500T/2600T that mounts the VM unit is different from that of the GP570VM. When the V tag in the 70 series VM is replaced with that of the 2000 series VM, the rightmost 40 pixels will not be displayed. Therefore, the location of the camera and the display size of the V tag should be changed.**

* This function is only available with the GP-570VM/(870VM), and GP-2500T/2600T units that are equipped with the optional VM unit.

2.27.3 Using V-tags *

■ General Info.

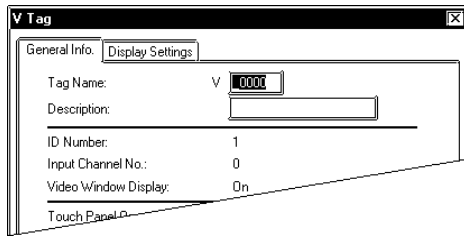

The General Info. page provides information about the V-tag's current settings.

Tag Name

Must be no more than five Single-byte or two Double-byte characters long and composed of letters and/or symbols.

Description

Up to 20 Single-byte or 10 Double-byte characters can be entered.

■ Display Settings

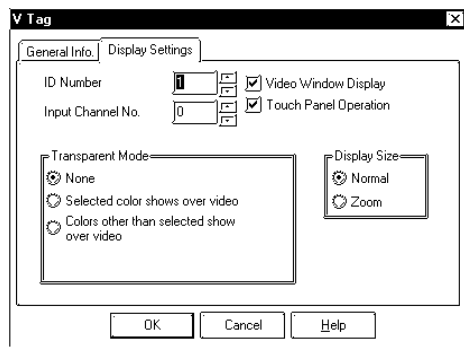

ID Number

Set up the ID number specific for the video window. Be sure this number is not repeated on the same screen.

Input Channel No.

Set up the video input channel number.(0, 1, 2)

Video Window Display

Set up whether the video window display is used or not used.

Touch Panel Operation

When Touch Operation is set to ON, touch panel input on the video window is enabled.



Note: Even though Touch Operation is turned OFF, when the video window's display is also turned OFF, touch panel input turns ON again.

Transparent Mode

None

Does not run the video window's transparent display.

Selected color shows over video

When the color set here is behind the video window, it appears through the video window.

Colors other than selected show over video

All the colors behind the video window except the ones set here, appear through the video window.

* This function is only available with the GP-570VM/(870VM), and GP-2500T/2600T units that are equipped with the optional VM unit.

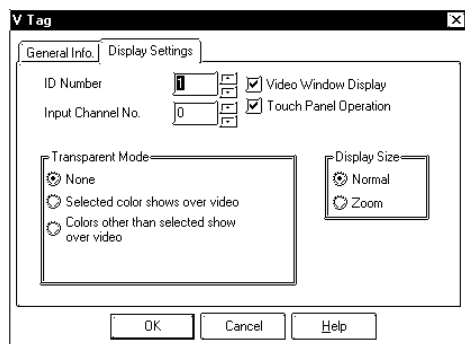

Display Size

Normal

Zoom

Changes the video screen size between Normal and Zoom.

■ **Video Window Display Size**

When the V-tag is set up, the video window is automatically displayed as shown below.

The tag-mark illustrated below is displayed with the V-tag.

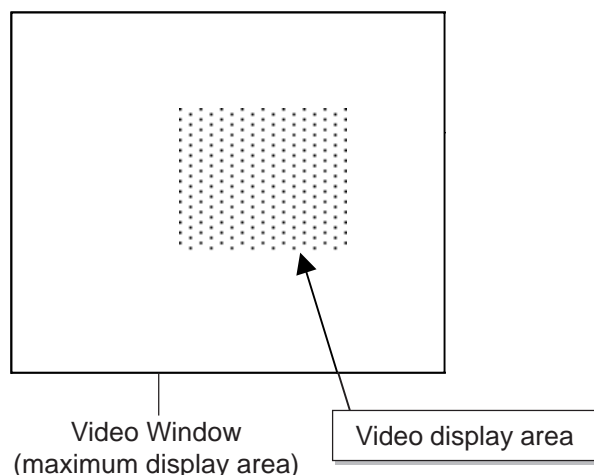

The Video window automatically displays the maximum Video display area. The display size varies depending on the combination of your GP model, "Video Input Signal" type (NTSC /PAL), and "Display Size" (Normal/Zoom). (See the table below for details.)

For the procedure for configuring the "Video Input Signal" type (NTSC/PAL) and "Display Size" (Standard/Zoom), **Reference** *"4.12.6 Video Control Area Settings"*

		Display Size	GP Model	
			GP-570VM GP-870VM	GP-2500T GP-2600T
Video Input Signal type	NTSC	Standard	300 x 240	320 x 240
		Zoom	600 x 480	640 x 480
	PAL	Standard		384 x 288
		Zoom		768 x 576

* This function is only available with the GP-570VM/(870VM), and GP-2500T/2600T units that are equipped with the optional VM unit.

■ Setting Up a V-tag

The following describes the procedure for setting up a V-tag.

Step 1. After configuring all parameters on the "V Tag" setting window, click [OK].

The Video window is displayed in the screen creation area.

Step 2. Left-click the mouse button to confirm the position of the Video window in the screen creation area. The mouse pointer changes to a cross-hair cursor.

Step 3. Left-click the mouse pointer to set the starting point of the Video display area. This fixes the start point of the Video display area and displays the Video display area.



Note: When the mouse pointer is in the Video display area, the start point can be set at any point. When the mouse button is clicked with the cursor in the screen creation area outside the Video display area, the start point is automatically fixed at the top-left corner of the Video display area.

Step 4. Left-click the mouse button again to confirm the end point of the Video display area and set the size of the Video display area.



- When the mouse pointer is in the Video display area, the start point can be set at any point. When the mouse button is clicked on the screen creation area outside the Video display area, the start point is automatically fixed at the top-left corner of the Video display area.
- When the video display area for the GP2000 series and other GP series is set up to use NTSC, which exceeds the video area, the NTSC will not work correctly. (The display area is rounded within the video area.)
- When using NTSC with a GP unit, if the Video display area is set so as to exceed the normal display area in the following cases you will not be able to switch from Expanded display to Standard display. To prevent this problem, be sure to set the Video display area's position so that it does not exceed this area.

Case 1: When a V-tag's display size is set to standard and the video display control area's Video display size is switched from Standard to Expanded, and then from Expanded to Standard.

Case 2: When a Base screen that has a V-tag that is set to a display size of Standard is switched with a Base screen that has a V-tag that is set to a display size of Expanded, changing back from the Expanded setting screen to the Standard setting screen.

* This function is only available with the GP-570VM/(870VM), and GP-2500T/2600T units that are equipped with the optional VM unit.

2.27.4 V-tag Examples *

Video inputs from Channel 0 and Channel 1 are used to show examples of screen monitoring, and Video Control Area ID number changes.

Base screen 1

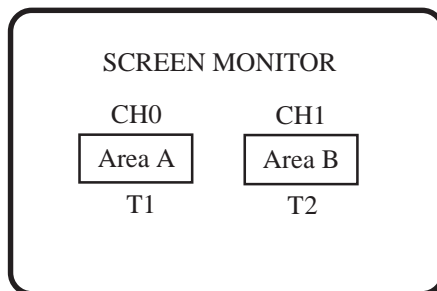

Channel 0

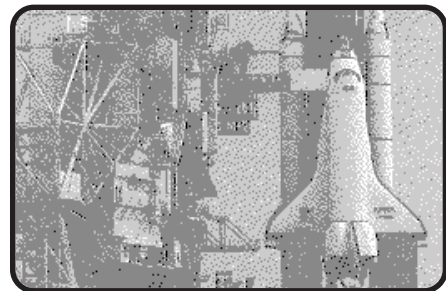

Base screen 1 Tag Settings

T1	Address	LS8
	Data	0002
T2	Address	LS20
	Data	0001

Channel 1

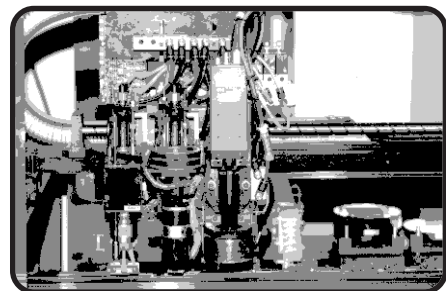

Base screen 2

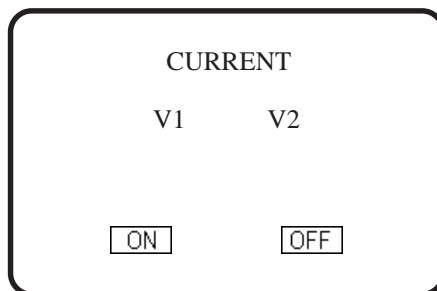

Base screen 2 Tag Settings

V1	ID No.....	1
	Channel No.	0
	Video Window Display ...	ON
	Display Size	Standard
	Transparency Mode	None
	Touch Operation	OFF
V2	ID No.....	2
	Channel No.	1
	Video Window Display ...	ON
	Display Size	Standard
	Transparency Mode	None
	Touch Operation	ON

* This function is only available with the GP-570VM/(870VM), and GP-2500T/2600T units that are equipped with the optional VM unit.

1. Pressing Area A...

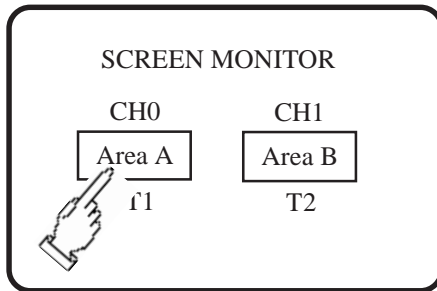

2. ...displays the video from Channel 0.

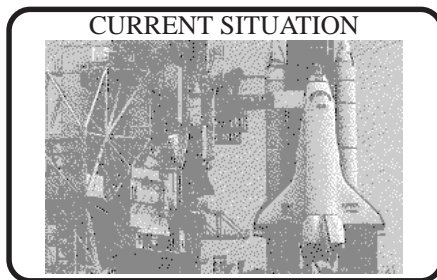

LS Area	
LS0020	0001
LS0021	
LS0022	0000

T1 changes the display to screen 2, T2 runs ID number 1 display.

3. Host (PLC) writes 0002 to LS20.

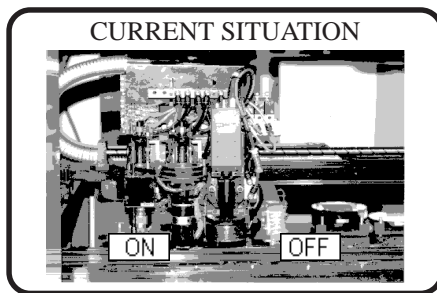

LS Area	
LS0020	0002
LS0021	
LS0022	0000

The video setup with ID No. 2 displays.

4. Host (PLC) writes 0001 to LS22.

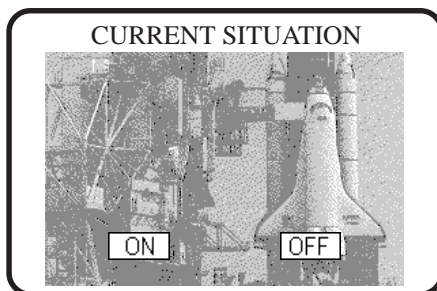

LS Area	
LS0020	0002
LS0021	
LS0022	0001

Displays the ID No. 1 video.



Note: If you are using the application screens made for GP-530VM in the GP-570VM or GP-2000VM, please be aware that the Video Control Area start address will be different.

* This function is only available with the GP-570VM/(870VM), and GP-2500T/2600T units that are equipped with the optional VM unit.

2.28 v-tag (Extended Video Window Display)

2.28.1 Overview

This special-purpose tag is supported by GP-2500T/2600T units with an optional VM unit attached. This tag is used to register a video window on a “video screen”, which is then overlaid on a standard “base screen” to provide up to four video displays. This allows a standard “operating” screen to operate as is and only call up and display multiple video screens when required.

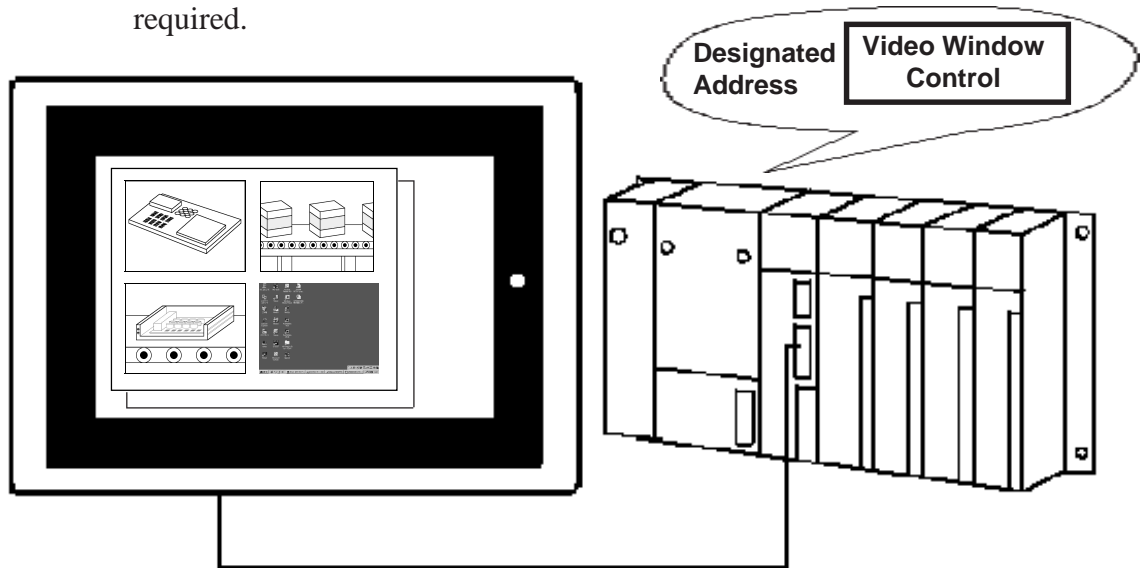

2.28.2 About v-tags

For information about setting up an image window*¹ on a “video screen”, and then displaying that image on a base screen,

▼ **Reference** ▲ *Operation Manual, 3.6 Video Data Display (V Screen)*

▼ **Reference** ▲ *4.9 Extended Function of VM Unit*

For information about the image window’s display using a v-tag to display data on a designated base screen, or to display an image window on all your windows (“global display”), refer to the following manual sections.

▼ **Reference** ▲ *Operation Manual 3.6, Video Data Display (V Screen)*

▼ **Reference** ▲ *4.9 Extended Function of VM Unit*

*¹ Image window settings are performed via the Video Screen’s Video Settings area.

* This function is only available with GP-2500T/2600T units that are equipped with the optional VM unit.

Up to four image windows can be used in a single video window. One of these can be a Global Window, 2 can be Local Windows, and one can be an Image Window. These windows can all be displayed at the same time. Also, up to four different image windows (video channels) can be shown in the video window.

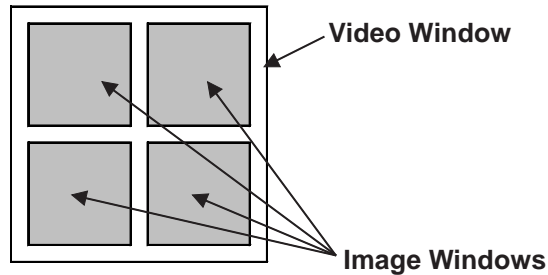

◆ **Video Window Types**

There are three types of video windows that can be used for display.

- Always on fixed. The display screen and its display position are fixed.
- Window On/Off fixed. ON/OFF The display screen and its display position are fixed. A single address is used for the display's control.
- Indirect are used for the control The display screen and its display position are variable. Up to four words can be address of this display.

◆ **Video Window Switching**

There are three types of window switching/positioning available. They are video window switching enabled, video window switching disabled, or normally in front. This setting can be used to display another window or a video window on top of a single screen.

◆ **Video Window Display Position**

When the window's display position is designated as indirect, the upper left corner of the video window screen's coordinate value is entered as an absolute value. This base screen upper left corner's value is regarded as the origin (0,0) point of that window. When designating the video window's x-axis coordinate data, be sure to designate it using 8-dot (pixel) units.

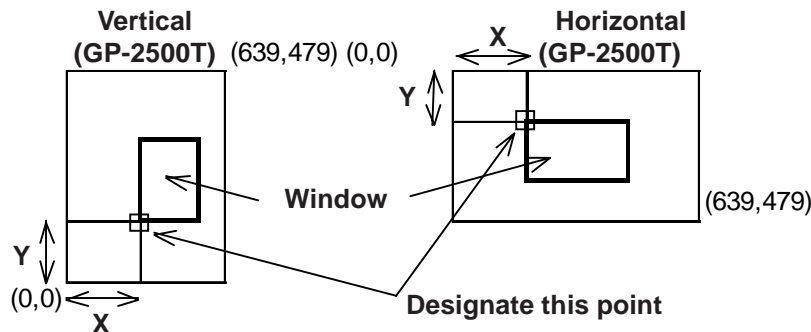

* This function is only available with GP-2500T/2600T units that are equipped with the optional VM unit.



- **When using the v-tag, be sure to select “Extended Mode” in the GP Setup screen’s Video Settings area.**

Operation Manual 3.6 Video (V) Screen

- **When calculating the number of Tags used on a single base screen, add the base screen’s tags to those used on any windows and video windows used on the base screen. If the number exceeds 384, all tags after the 384th tag cannot be used. Tags will be disabled starting from the last window, or video window displayed, in the order that the tags were placed.**
- **v-tags and V-tags cannot be used at the same time.**
- **Even though multiple v-tags (video window) can be placed on a base screen, only one of the video windows can be active at one time. The maximum number of image windows that can be displayed in a single video window is four (4). However, only T-tags can be used.**

Tag Settings Possible Move

Bit Move	Set, Reset, Momentary
Word Move Mode	Set 16 bits, Set 32 bits

- **When multiple v-tag trigger bits turn ON at the same time, it is impossible to guarantee which window will appear. As a result, be sure to set each v-tag’s trigger bit to turn exclusively ON.**
- **When the designated display screen number does not exist, the video window will not be displayed.**
- **Be sure to set the video window coordinates so they do not exceed the video window’s display range. If this range is exceeded, that image will be automatically trimmed (cut) to fit the range.**
- **The v-tag has setting methods for display on a base screen and for display as a global window.**
- **The setting for use of a window on a base screen or as a global window is exclusive to one or the other. If the global setting is used, all the v-tags used on base screens are disabled.**
- **v-tags used with the global window cannot use the “Normal” setting. The ON/OFF Control and Relative designation features operate the same as when using a base screen.**

This function is only available with GP-2500T/2600T units that are equipped with the optional VM unit.

2.28.3 Using v-tags

■ General Info.

v Tag Setting

General Info. Designated Window

Tag Name: v 0001

Description:

Bit Address: ----

Word Address: ----

Designated Window: Always on; 1

Data Format: --

Window touch action: available

OK Cancel Help

Current settings can be reviewed in the dialog box.

Tag Name

Must be no more than five Single-byte or two Double-byte characters long and composed of letters and/or symbols.

Description

Up to 20 Single-byte or 10 Double-byte characters can be entered.

v Tag Setting

General Info. Designated Window

Designated Window

Always on

Window On/Off

Indirect

Window touch action

available

invalid

always top

Video Screen No. 1

V1 Untitled1

OK Cancel Help

Window Touch Action

This feature is available only when the [Designated Window] is set to either [Always on] or [Window On/Off].

available

If the video window is behind another window, touching a portion of the video window will cause the window to be displayed in the top-most position.

invalid

If the video window is behind another window, touching a portion of the video window will not cause any change in the window's position.

always top

The video window will always be placed in the front-most position.

Designated Window

Always on

Designates that the video window is normally displayed on top of the base screen.

Window On/Off

When the designated bit address' bit turns ON, the video window will be displayed.

Indirect

The desired video screen number and the screen's display location can be variables.

This function is only available with GP-2500T/2600T units that are equipped with the optional VM unit.

2.28.4 v-tag Examples

- ◆ Up to four image windows can be displayed at the same time in a video window.
- ◆ Any image displayed in an image window can be captured and saved to a CF Card as a JPEG file. Also, any JPEG image stored on a CF Card can be called up and displayed on an image screen.
- ◆ Any image read from the CF Card can be compressed and displayed at either 1/4th or 1/16th its original size.
- ◆ A single section or portion of an image read from the CF Card can be displayed.
- ◆ Video settings can be performed using a setup “Wizard” feature, which explains the setting details.
- ◆ Image Window Display Positioning

When the [Video Capture] setting is set to [Indirect], and the window's display position is designated as relative, the upper left corner of the video window screen's coordinate value is entered as an absolute value. This base screen upper left corner's value is regarded as the origin (0,0) point of that window. When designating the video window's x-axis coordinate data, be sure to designate it using 8-dot (pixel) units. (0, 8, 16, 24, etc.)

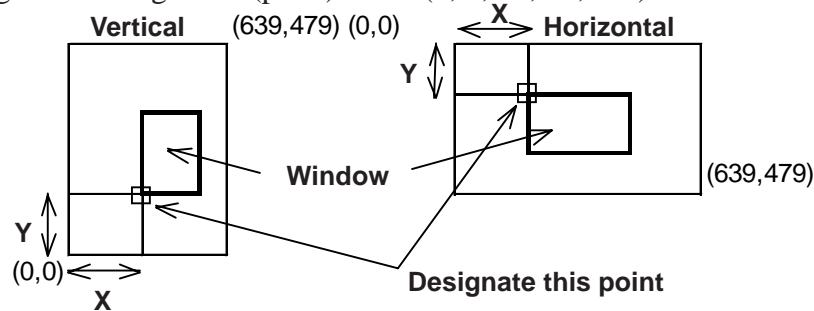

When the [Video Capture] setting is [Indirect], the GP Setup area's Video Control Address must be enabled.

Reference Operation Manual, 3.6 Video Data Display - Video (V) Screen

This function is only available with GP-2500T/2600T units that are equipped with the optional VM unit.



The Image Window cannot be made smaller than 20 dots by 20 dots. The Video Window's maximum size, which is designated in the GP Setup area's [Video Input] and [Display Mode] settings will be as shown below

Reference Operation Manual, 3.6 Video Data Display - Video (V) Screen

	NTSC		PAL	
	GP-2500	GP-2600	GP-2500	GP-2600
Standard	640 x 480	640 x 480	640 x 480 ^{*1}	768 x 576
1/4 Size	320 x 240	320 x 240	384 x 288	384 x 288
1/16 Size	160 x 120	160 x 120	192 x 144	192 x 144

*1 When the GP-2500T unit's signal type is set to PAL, and "Standard" is selected, a portion of the screen will not be displayed.

	VGA		SVGA	
	GP-2500	GP-2600	GP-2500	GP-2600
Standard	640 x 480	640 x 480	680 x 480 ^{*2}	800 x 600
1/4 Size	320 x 240	320 x 240	400 x 300	400 x 300
1/16 Size	160 x 120	160 x 120	200 x 150	200 x 150

*2 When the GP-2500T unit's signal input is SVGA, a portion of the screen will not be displayed.

Information

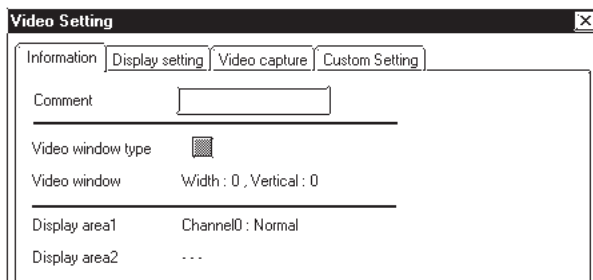

Comment

Up to 20 Single-byte or 10 Double-byte characters can be entered.

Display Setting

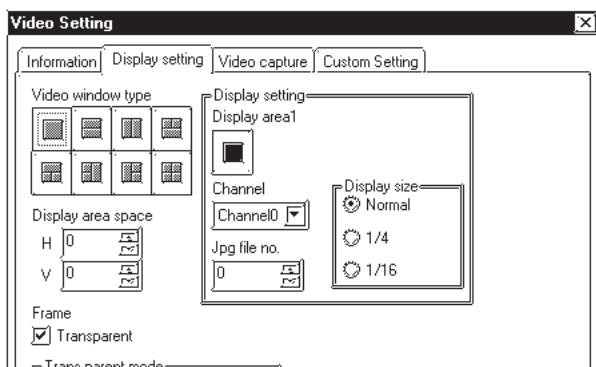

Video Window Type

Designates the type of display used for the image window(s) displayed in the video window, as well as the display's position.

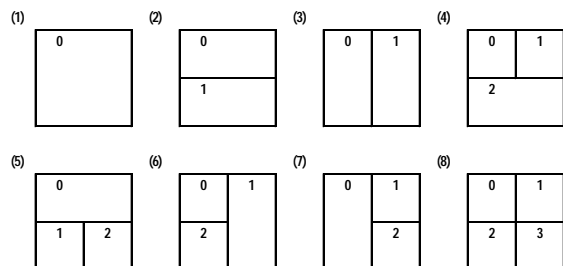

This function is only available with GP-2500T/2600T units that are equipped with the optional VM unit.

■ Display Setting

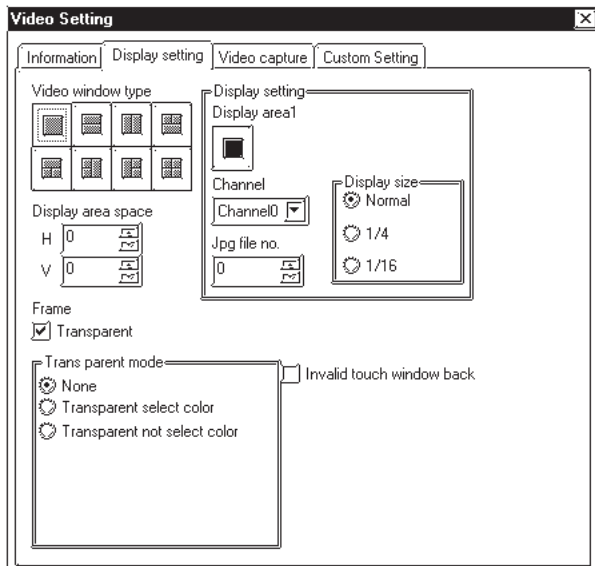

Display setting
Display area 1

Used to enter the image area settings.

Channel

Used to select the designated image area's setting items.

- Channel (0 to 3)
- JPG
- PC
- Unused



Note: When the [Display setting] area's [Channel] setting is [Unused], a video window other than the type shown above can be created.

Ex. In a four-window display, the upper left and bottom-right image windows are set as [unused].

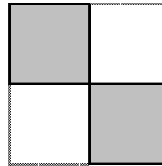

JPG File No.

When "JPG" has been set for the [Channel] setting, enter the number of the JPEG file to be displayed.

Display size

Designate the size of currently designated image window.



The image window will be displayed using the top left corner's origin point. The following diagrams show how the actual display size can be smaller than the designated image window.

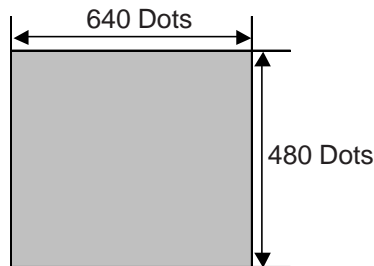

When an NTSC screen is displayed at 100% (1X magnification), it is displayed as a full screen.

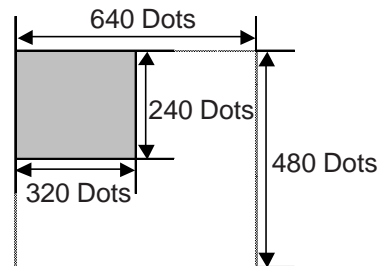

When an NTSC screen is displayed at 25% (1/4X magnification), it is displayed in the upper left corner of the screen. The remaining screen area will be displayed using the "Frame" color

This function is only available with GP-2500T/2600T units that are equipped with the optional VM unit.

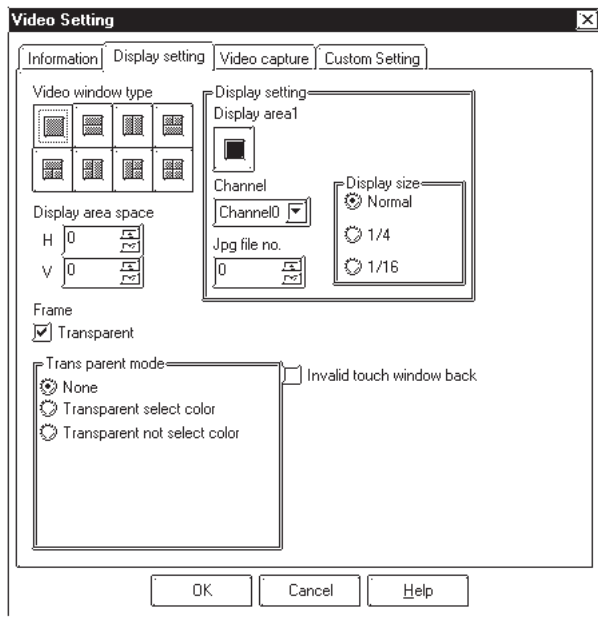

Display Area Space

Sets the space used between image windows. This setting can be used for any window type other than (1).

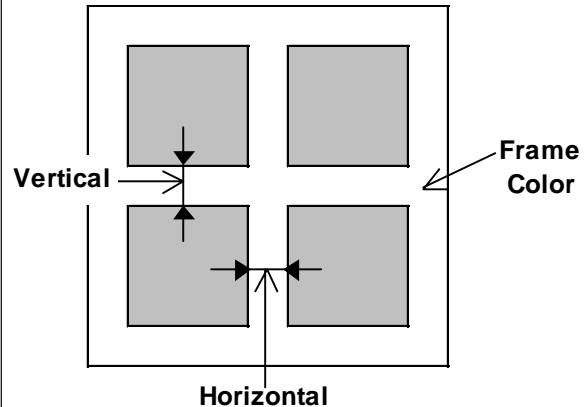

Frame

Sets the color used for the space between image windows. If “Transparent” is checked, the space becomes clear and the Video Window’s background can be displayed.

Transparent Mode

Designates the color used for the GP screen’s transparent display color, shown under the image window.

- None
- Transparent select color
- Transparent not select color

Invalid touch window back

This feature disables the touch features behind the video window. (Initial setting is [Allowed].)

Video Capture

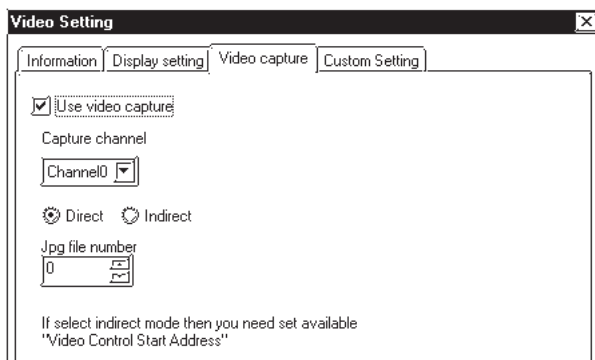

Use Video Capture

Designates if capture of screen images to a CF Card is possible.

Capture Channel

Video capture can be performed one image window at a time.

Direct

Indirect

Selecting "Indirect" mode captures the image window and makes the file number of the JPG file variable.

Jpg file number

This setting can be used when the Capture Channel setting is Direct. This number is the number given to the JPEG file saved to the CF Card.

Reference 4.12.5 Video Control Area Example



Note: The format of the filename used will be \CAPTURE\CPXXXXX.JPG, where “XXXXX” is a number from 0 to 65535.

This function is only available with GP-2500T/2600T units that are equipped with the optional VM unit.



- Using “Indirect” requires the enabling of the GP Setup area’s Video Control Area.

Reference Operation Manual, 3.6.2 Video Display (V Screen)

- Images from a PC (monitor) display cannot be captured.
- Capturing of images typically takes from 2 to 3 seconds and produces a file of approximately 200KB (80% quality setting).
- When using PAL input, images are captured only at a ratio of 1:1 (normal size).

■ Custom Setting

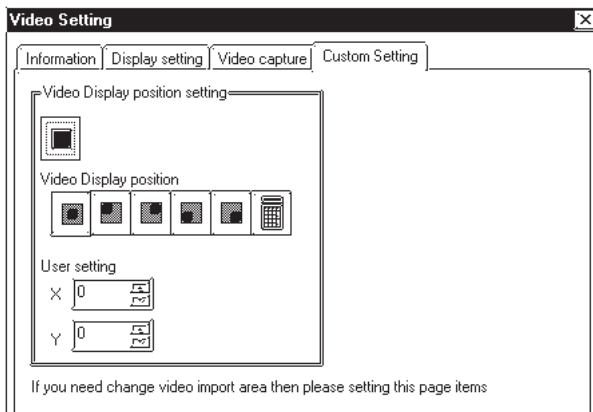

Video Display position setting

Video Display position

Designates the positioning used for the display of read-in image data.

User setting

Enabled when the Video Display position setting is used.



Note: The video image’s display position (origin point [VX, VY]) is designated via the video image quality setting. This setting can be changed while online, via the [Video Control area]. This control is used only for images from external input devices.

Reference 4.12.2 Video Control Area

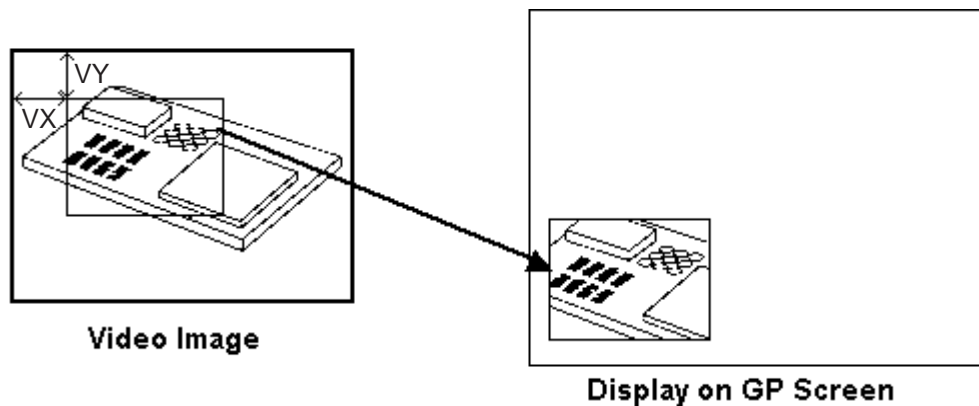

- The [User Setting] area is used to designate the upper left corner’s coordinate value. This is not for the GP screen’s coordinate position. (It has no connection to the type or orientation of the GP unit.)
- If the [User Setting] area’s “Image Window” setting is “JPG”, the video display origin point cannot be changed. (VX and VY are fixed at 0,0.)

This function is only available with GP-2500T/2600T units that are equipped with the optional VM unit.

2.29 W-tag (Write to Device)

2.29.1 Overview

Writes data to a word address, or either sets/resets a bit, in response to host (PLC) word address changes.

When Mode = Word

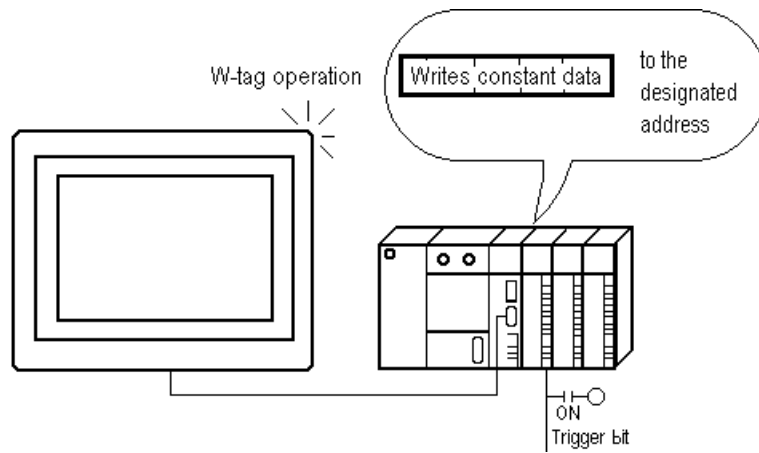

When Mode = Bit

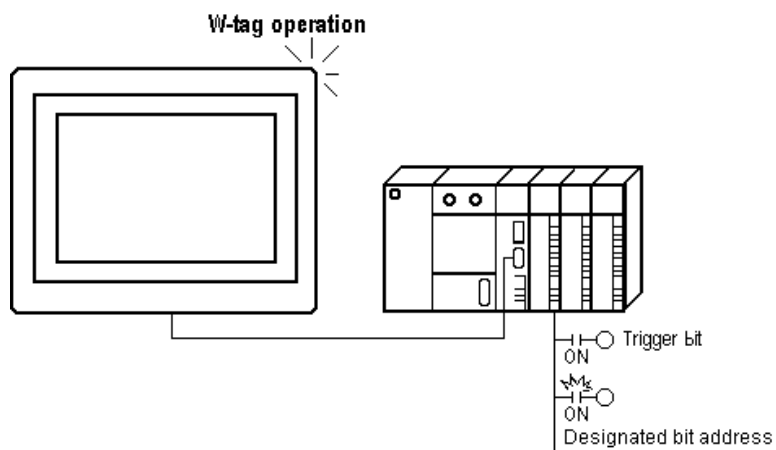

2.29.2 About W-tags**■ The timing mode that triggers the operation can be selected.**

- 0→1 When the trigger bit turns ON, the W-tag operation takes place.
- 1→0 When the trigger bit turns OFF, the W-tag operation takes place.
- 0↔1 When the trigger bit changes, turning ON or OFF, the W-tag operation takes place.

■ The following operations are available.

- Bit Set
- Bit Reset
- Bit Invert
- Compare (=, <, <=, <>, >, >=)
- Change Screen
- Data Set (16-bit, 32-bit)
- Word Add Binary 16 Bit (Use the negative sign for subtraction)
- Word Add BCD 16 Bit (Use the negative sign for subtraction)
- GP exclusive special function switches (Return to previous screen)

2.29.3 Using W-tags

■ General Info.

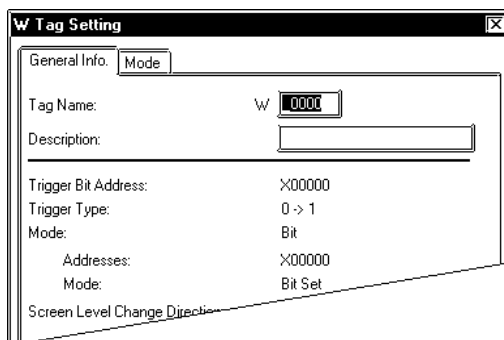

The General Info. screen provides information about the current W-tag settings.

Tag Name

Must be no more than five Single-byte or two Double-byte characters long and composed of letters and/or symbols.

Description

Up to 20 Roman characters or 10 Double-byte characters can be entered as a description.

■ Mode/Bit

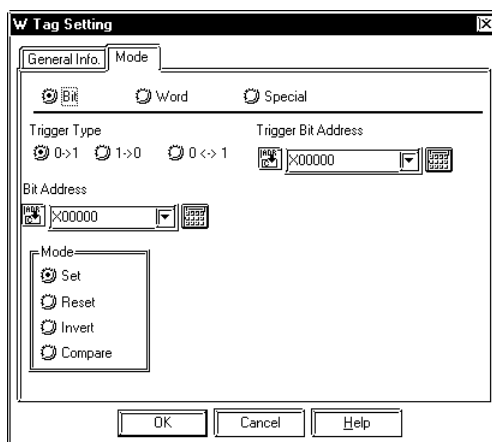

Bit

Sets or resets the designated bit address when the trigger bit changes.

Trigger Type

0→1

The tag operates when the trigger bit changes: 0 to 1

1→0

The tag operates when the trigger bit changes: 1 to 0

0↔1

The tag operates when the trigger bit condition changes: 0 to 1, or 1 to 0.

Trigger Bit Address

Designates the location of the bit used to trigger the operation.

Bit Address

Set up the bit address which is set or reset when the trigger bit changes.

Mode

Set

Sets the designated bit high (ON) when the trigger bit is activated according to the designated trigger mode. The “Set” operation is performed only when the trigger bit changes. The bit remains ON.

Reset

Sets the designated bit low (OFF) when the trigger bit is activated according to the designated trigger mode. The “Reset” operation is performed only when the trigger bit changes. The bit remains OFF.

Invert

The designated bit condition is reversed (ON ↔ OFF) when the trigger bit is activated according to the designated trigger mode.

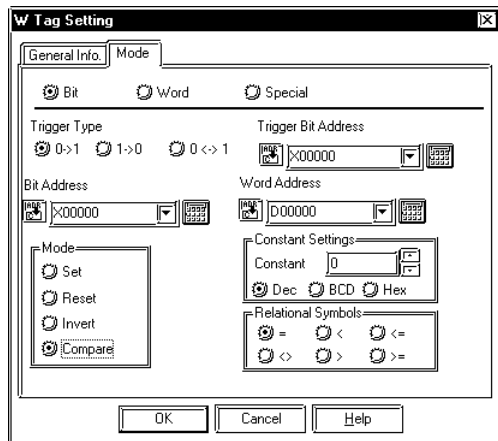

Compare

Designates a comparison of the data in Word Address with a predetermined constant value when the trigger bit is activated. If the condition is met, the Bit Address is set to high (1).

Word Address

Designates the word address data that is compared with the constant (16-bit data).

Constant Setting

Constant

Designates the fixed value to be used in the comparison.

Dec

BCD

Hex

Designates the data format for the constant.

Relational Symbols

=

<

<=

<>

>

>=

Designates the symbol used in the comparison. The comparison method is as follows:

S1 (Symbol) S2, where

S1= Word Address Data

S2= Constant

■ Mode/Word

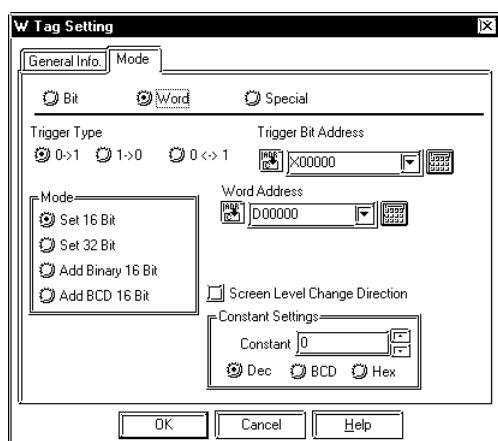

Word

Writes data to the designated word address when the trigger bit changes.

Trigger Type

0→1

The tag operates when the trigger bit changes: 0 to 1.

1→0

The tag operates when the trigger bit changes: 1 to 0.

0↔1

The tag operates when the trigger bit condition changes: 0 to 1, or 1 to 0.

Trigger Bit Address

Designates the location of the bit used to trigger the operation.

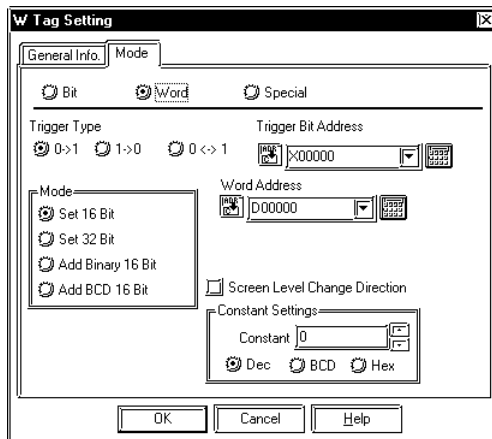

Word Address

Designates the word address for write operations when the trigger bit is activated.

Screen Level Change Direction

When using a W-tag to change screens, check this check box to select the Screen Level Change function.

Reference 2.23.7 Screen Level Change Direction, T-tag

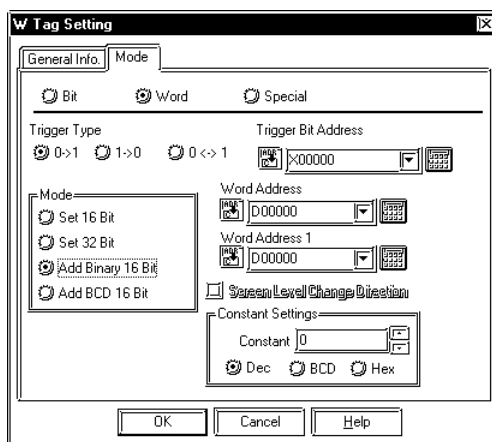

Mode

Set 16 Bit

When the trigger bit is activated according to the designated trigger mode, a constant (-32768 to 32767) is written to the setup word address.

Set 32 Bit

When the trigger bit is activated according to the designated trigger mode, a constant (-2147483648 to 2147483647) is written to the setup word address.

Add Binary 16 Bit

When the trigger bit is activated according to the designated trigger mode, the binary constant value (-32768 to 32767) and the data in Word Address 1 are added, and the results are written to the designated word address.

Add BCD 16 Bit

When the trigger bit is activated, the BCD constant value (0 to 9999) and the data in Word Address 1 are added, and the results are written to the designated word address.

Word Address 1

Valid only for “Add Binary 16 Bit” or “Add BCD 16 Bit” operations, the data in the word address set here is added to the constant value (16 bit data).

Constant Settings

Constant

Designates the fixed value used in the addition operation above.

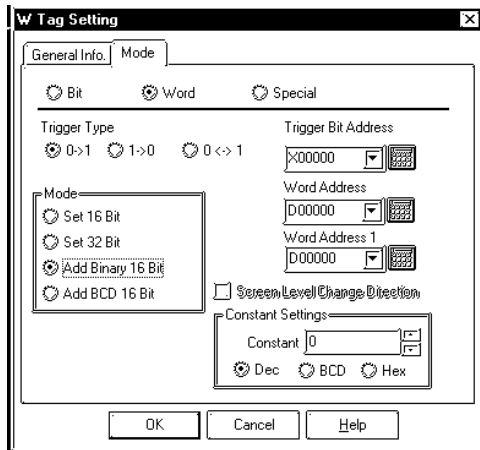

Dec
BCD
Hex

Designates the data format for the constant. Refer to the table below for the possible setup ranges.

<Constant Settings Range>

Mode	Constant
Set 16 Bit	-32768 - 32767
Set 32 Bit	-2147483648 - 2147483647
Add Binary 16 Bit	-32768 - 32767
Add BCD 16 Bit	0 - 9999

■ Mode/Special

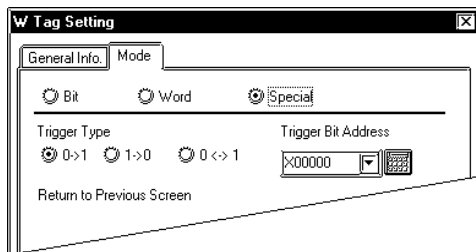

Special

Designates a special function to be performed when the trigger bit changes.

Trigger Type

0→1

The tag operates when the trigger bit changes: 0 to 1

1→0

The tag operates when the trigger bit changes: 1 to 0

0↔1

The tag operates when the trigger bit condition changes: 0 to 1, or 1 to 0.

Trigger Bit Address

Designates the location of the bit used to trigger the operation.

Return to Previous Screen

When the trigger bit is activated, the GP returns to the previously displayed screen image. It is possible to go as far back as 32 previous screens.



Important

- **Be sure to include sufficient time intervals (the set communication cycle time or longer) to write data to the PLC device. If the GP internal special relay's tag scan counter is used as a data write trigger and data write is performed frequently, a communication error can occur.**
- **The communication cycle time is stored in GP internal special relay LS2037. [Reference](#) Device/PLC Connection Manual**



Note:

Previous screen means the screen which is displayed prior to the current screen. Previous screen does not mean the screen whose screen number is prior to the current screen.

2.29.4 W-tag Examples

Screen Change Trigger Bit Explanation

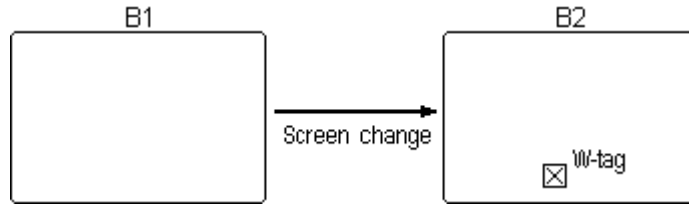

In the Base screen “B2,” a W-tag (Trigger Type: 0→1) is set up. The following timing charts describe the connection between a screen change, a trigger bit, and a W-tag.

<Example 1>

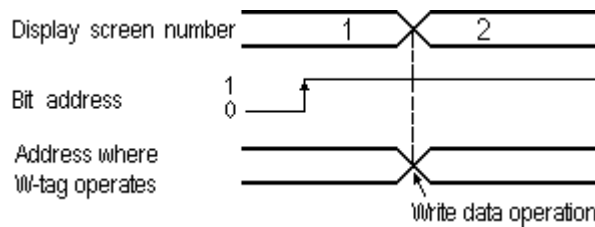

When the screen changes, the trigger bit value is 1, so the W-tag is activated and the data write operation is performed.

<Example 2>

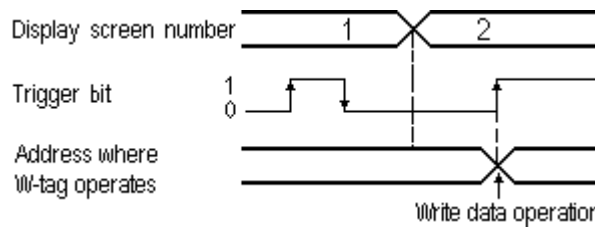

When the screen changes, the trigger bit value is 0, thus, the W-tag is not activated and data write is not performed.

After the screen changes, when the trigger bit value changes (0 → 1), the W-tag is activated and the data write operation is performed.



- Example 1 applies only with Direct Access format. When using the Memory Link format, only Example 2 applies.
- With the “Trigger Type: 1 → 0”, the same operation is performed.

Trigger Type = 0 ↔ 1

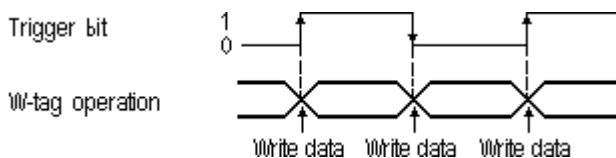

Whenever the trigger bit reverses, 1 ↔ 0, the W-tag is activated and the write data operation is performed.

2.30 X-tag (Display Text Data)

2.30.1 Overview

The Text screen can be displayed from any text row, not just the first.

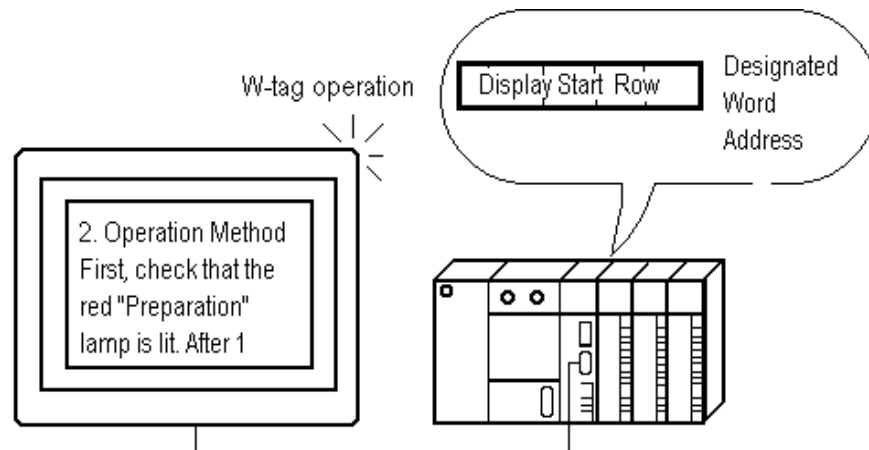

2.30.2 About X-tags

- Displays the contents of the Text screen beginning from the row designated in the Start Line Access.
Reference *Operation Manual, 3.4 Text Input: the Text Screen*
- The Text screen start line can be set indirectly using a word address, which makes the scroll display of long text possible.
- The Text display is cleared when the start line number is set to 0 (zero).
- When the row designated as the start line does not exist, then the operation is ignored. The text already displayed remains.
- There are two Trigger types: Bit and Word.

- When the Trigger type is Bit, the start line is set up indirectly. The data for the start line is obtained from consecutive bit addresses. Simply designate the necessary bit length (consecutively from the given bit address). The Text screen is displayed.
- When the Trigger type is set to Word, the start line can be accessed directly or indirectly. The Text screen to display is set indirectly in a word address, whereby different Text screens can be displayed. If a designated Text screen does not exist, then the text display is cleared.
- A maximum 512 rows of text data can be registered in a Text screen.
- The maximum number of characters per row and the maximum number of rows that can be displayed on the GP will depend on your GP screen resolution and the current X-tag character size setting.

Reference *“2.1.2 About A-tags, Max. No. of Characters and Lines”, A-tag*

- The character size and display color can be selected.



Note: If your text data is wider than the setup display area, the portions that exceed the area are truncated and do not display.

2.30.3 Using X-tags

■ General Info.

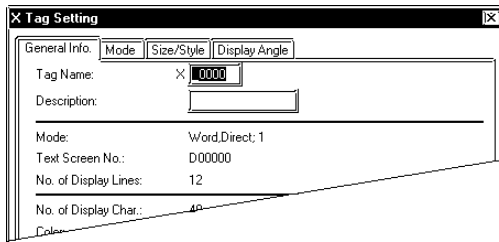

The General Info. page provides information about the current X-tag settings.

Tag Name

Must be no more than five Single-byte or two Double-byte characters long.

Description

Up to 20 Single-byte or 10 Double-byte characters can be entered.

■ Mode/Bit

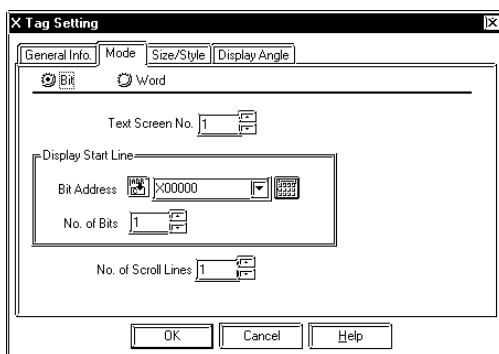

Bit

Designates the start line address in bit units.

Text Screen No.

Designates the Text screen number directly.

Display Start Line

Bit Address

Designates which row of Text screen data to begin the display from.

Designates the starting bit address where the X-screen start line (in binary) data is stored.

No. of Bits

Designates how many bits, from the Bit Address, are used for storing the Text screen start line data.

No. of Scroll Lines

Sets up the number of lines the display will scroll when the start line changes. Use a number from 1 to 256.



Note:

- The device address set for the Bit Address field can use only word data.

Reference *Device/PLC Connection Manual, "Supported Devices"*

- The Bit No. setting must not use two consecutive words.

■ Mode/Word

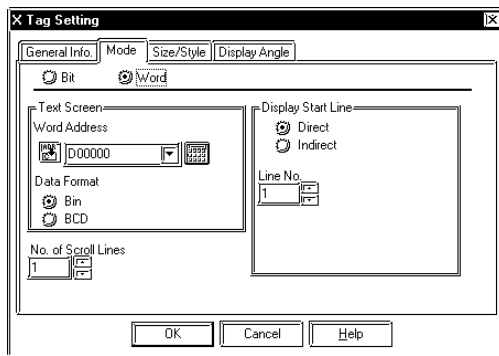

Word

Designates the start line address in word units.

Text Screen

Word Address

Designates the address storing the Text screen number to display.

Data Format

Bin

BCD

These two selections designate the data format of the above mentioned word address.

Display Start Line

Direct

Sets the start line directly.

Line No.

Designates the X-screen start line number. Even when the Text screen has switched, the start line number remains the same.

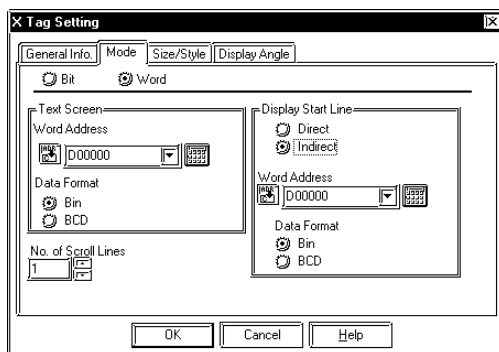

Indirect

Sets the start line indirectly using data in the designated word address.

Word Address

Designates the address where the start line data is stored.

Data Format

Bin

BCD

These settings designate the data format for data stored in the above mentioned Word Address field.

No. of Scroll Lines

Sets up the number of lines the display will scroll when the start line changes. Enter a number from 1 to 256.

■ Size/Style

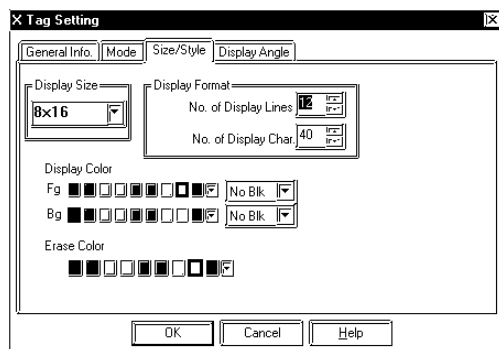

Display Size

The Display Size of characters can be specified here. With the GP2000 series, the scale ratio can be selected from integers 1 through 8. With other models, the scale ratio for the display can be selected from 1, 2, 4, and 8 times. The basic unit of measurement, "1 x 1" times, is a character measuring 16 dots by 16 dots.

16 dots



16 dots

<Double-byte Character>

When using Single-byte numerals or symbols, [6 X 10 dot], [8 X 13 dot] and [13 X 23 dot] extended fonts can be used.



Note: Since extended font sizes are fixed, objects containing these characters cannot be enlarged or reduced while pressing down the [Ctrl] key.

Display Format

No. of Display Lines

Designates the number of rows of text data displayed on one screen. The maximum number of rows is 40.

No. of Display Char.

Designates the number of characters (Single-byte) displayed for each row.



Note: The number of display lines and character length depends on the GP screen size, GP direction, and Display Size.

Reference “2.1.5 Color Settings”, A-tag

Display Color

Designates the color attributes: Foreground (Fg), Background (Bg), and Blink (Blk) used in the Text display.

Erase Color

Designates the color attributes for areas where messages are not displayed. If the GP screen is monochrome, this should be set to black.

■ Display Angle

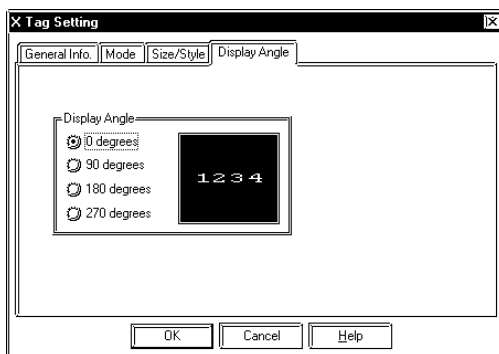

Display Angle

Designates the degree of display rotation. Select from 0 (zero), 90, 180, or 270 degrees.

2.30.4 X-tag Examples

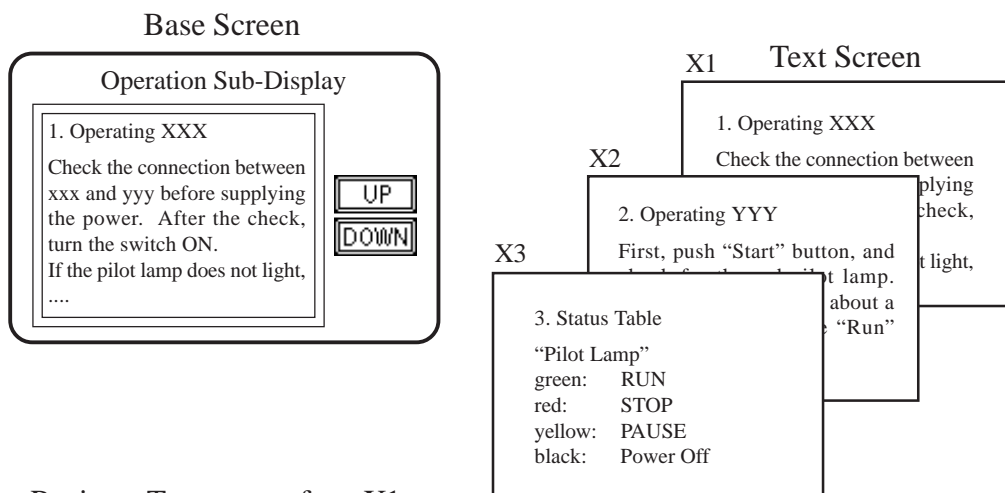

- Registers Text screens from X1.
- Switches text screens.
- Text can be displayed by scrolling. Set up two(2) touch panel keys for scrolling.

*** Be sure to enter a carriage return at the end of each row.**

How an X-tag is set up is based on the following conditions:

- 1) The number of Text screens displayed (one or multiple), or if it is necessary to switch multiple screens.
- 2) If it is necessary to change the start line to create a scroll display.

No. of Screens	Mode Setting	Start Line Designation
Using multiple Text screens	Word	Start line is changed -- Direct
		Start line is not changed -- Indirect
Using only one Text screen	Bit	Start Line can be changed (Regardless of Start Line Access setting)

In the above example, the mode is "Word" and the start line number is accessed indirectly.

Use the Text Screen box to designate which Text screen number to display in the Mode box's Word Address field, and use the Start Line Access box to designate from which row number to start the text display.

Here, D0200 is entered in the Text Screen box to designate the Word Address, and D0201 is entered in the Start Line Access box for the Word Address.

Set the T-tags' mode to Word and Add Binary 16 Bit. Be sure Word Address and Word Address 1 have the same address to create an operation that will increment.

Next, be sure the T-tag's Start Line Access box's address is the same as the X-tag's Word Address. Therefore, enter D0201 in both the T-tag's Word Address and Word Address 1.

The constant value for the UP key is 1, and -1 for the DOWN key.

Reference "2.23 T-tag (Touch Panel Input)"

The Actual Settings in GP-PRO/PBIII

When the data in Word changes by 1, the display scrolls up/down by 5 lines when No. of Scroll Line is set to 5.

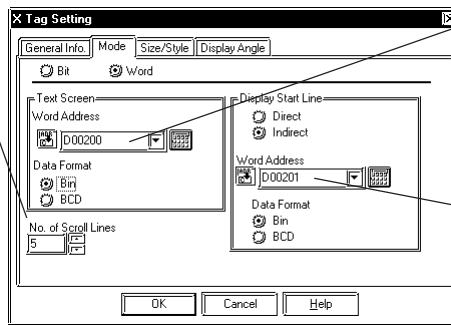

Address that stores the Text screen number.

Address that stores the start line number. (Same as the T-tag address.)

T-tag (UP)

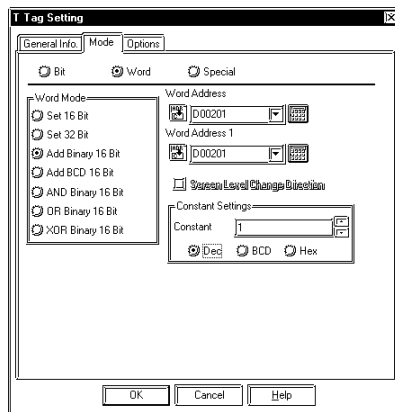

T-tag (DOWN)

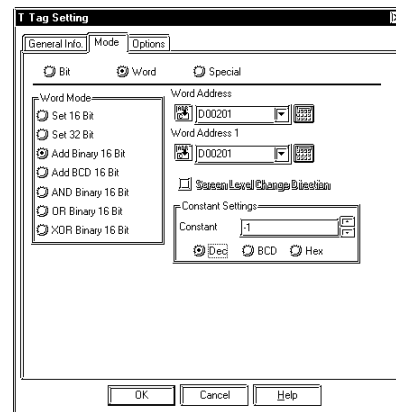

Operation Example

X1 1. Operating XXX

Check the connection between xxx and yyy before supplying the power. After the check, turn the switch ON.

If the pilot lamp does not turn on, turn the power switch off, wait 3 minutes, then turn it back on.

X3 "Create Lamp"

green: processing
yellow: prepare
red: abnormal

"Pilot Lamp"

green: RUN
red: STOP
yellow: PAUSE
black: Power Off

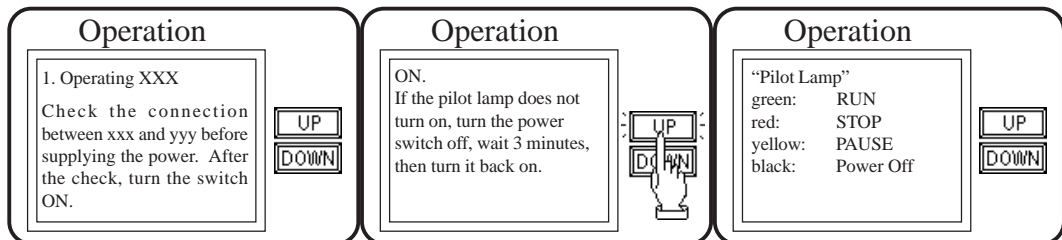

D0200	1
D0201	1

D0200	1
D0201	2

D0200	3
D0201	2

Displays the text in the Text screen, beginning from the first row.

By pressing the UP key, the data in D0201 increases by 1, and because the scroll line is set to 5, it scrolls 5 lines. The text display now starts from row "6."

When the data in D0200 changes to 3, the X3 Text screen will display, and because the value in D0201 has not changed, it will begin on row 6.



2.31 Trend Graph Display

2.31.1 Overview

This feature is used to display a trend graph, showing the change of a value over time in the host (PLC) word address data.

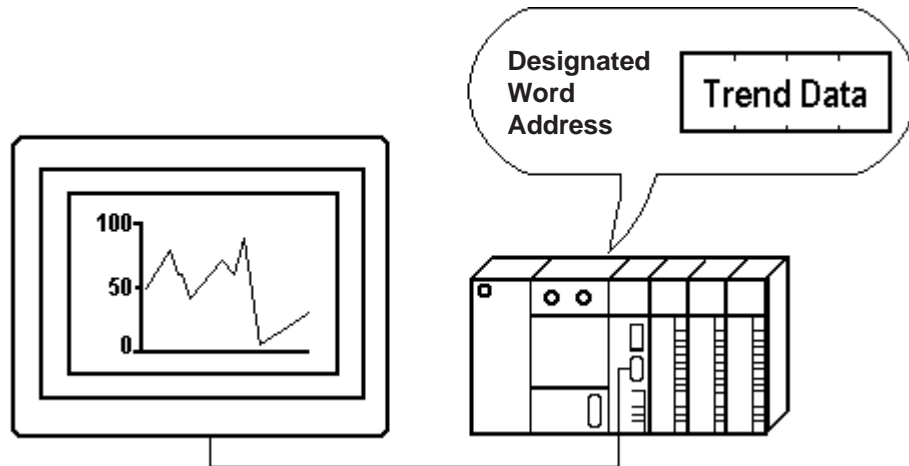

2.31.2 About Trend Graphs

- Trend graphs display data samples at the designated time, or sampling timing options, from the designated word address.
- Set up trend graphs in Trend Graph screens. Once a Trend Graph screen has been created, save it, load it into a Base screen and use that area for the Trend Graph Display.
- Up to 8 Trend Graph Displays can be used on a single Base screen.
- Two or more trend graph lines can be displayed in a single Trend Graph Display. The maximum number of channels that can be set up for the entire Project file (PRW file) is 40 with the GP2000 series units, and 20 with the other models. (When Data Sampling is designated, the number of data samples is included.) When more than 40 trend graph lines are set up, the 41st and subsequent lines (with the GP2000 series) and the 21st and subsequent lines (with other models) will not function, according to the following patterns.
 - Channels of data sampling are counted prior to those of the trend graphs.
 - Channels are counted from the lowest Trend Graph screen file number.
 - Channels are counted from those set up first, when in the same Trend Graph screen.
- Up to 20 channels can be set up on a single Trend Graph Display.
- Each Channel name begins with the capital letter O, followed by up to 5 Single-byte characters. The number of channels will equal the number of trend graph lines.

- There are three Trend Graph Display formats: Normal, Pen Recorder and Block.

■ **Normal (Display Mode)**

Data changes in the word address setup (1 word) are displayed at the designated time. The data display begins at 0 (zero). At the designated sampling time, the latest data is drawn in the Direction setup.

When you reach the end of the Trend graph display area, the data scrolls over by the value set in the Scroll field, and the display continues.

- **When Direction = Right Scroll = 4**

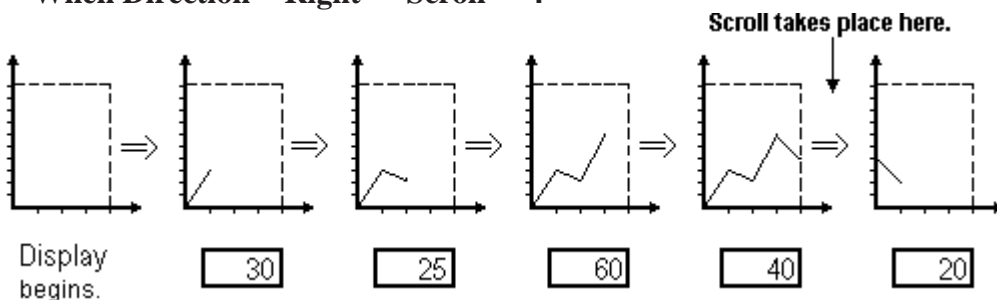

■ **Pen Recorder (Display Mode)**

Data changes in the word address setup (1 word) are displayed at the designated time. The data display begins at 0 (zero). At the designated sampling time, the graph display scrolls over one by one from the selected direction.

The latest data displays on the edge of the selected Direction, the origin axis.

- **When Direction = Right**

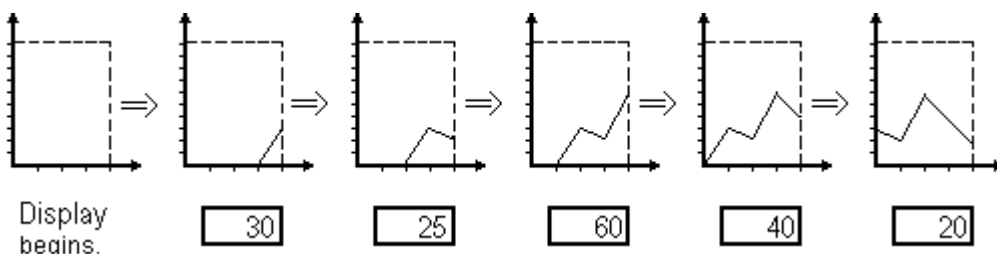

Note: When the sampling period is designated as 1 second, depending on the size of the graph area used, graph scroll processing can take almost one second, and communication and tag processing can be affected. In this case, setting the sampling period to 2 seconds should correct the problem.

■ **Block (Display Mode)**

All the data in consecutive word addresses are sampled at the designated time, then graphed as a single trend line. Data changes in multiple word addresses can be monitored as a single block by the graph. Enter address numbers to control the ON/OFF display of the graph.

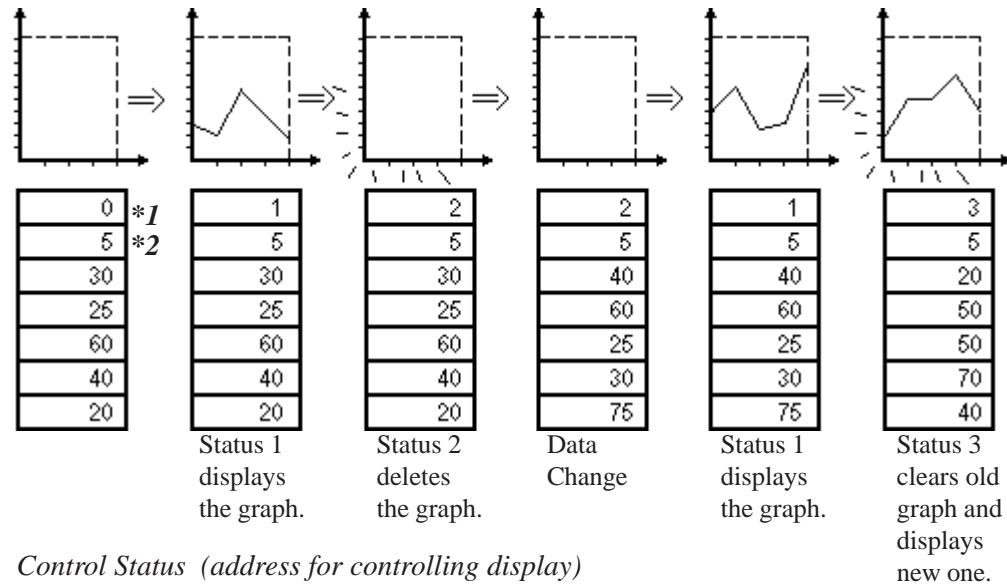

*1 Control Status (address for controlling display)

*2 Number of address data to display

■ The “Display Data Amount” that can be set up for one trend graph depends on the number of dots for screen display. The following are the maximum values for the Display Data Amount.

	GP-270, GPH-70, GP-370, GP-377R, GP-377, GP-2300, GP-2301, GP-2301H	GP-470, GP-570, GP-477R, GP-577R, GP-2400, GP-2401, GP-2401H, GP-2500, GP-2501	GP-675, GP-2600, GP-2601
Display Data Amount	319	639	799

* Note that the maximum Display Data Amount (Scale) value is 97 when the “Fill Below Line” option is selected.

- The Scale (the number of data points) range that can be set up for a single trend graph is 1 - 639 for GP-470/477R/570/577R/2400/2500/2501 and 1 - 319 for GP-270/H70/370/377R/377/2300/2301 and 1 - 799 for GP-675/2600.
- Absolute and relative data formats are available. Binary or BCD formats can be designated for absolute data, however only binary is acceptable for relative data.
- When using relative data, the data written to the host (PLC) is converted automatically according to the Input Range settings. A data computing program in the host (PLC) can be eliminated as a result.
- With absolute data, negative values are computed using 2’s complement. With relative data, both 2’s complement and MSB code are available.

- By setting maximum and minimum values for valid data, an Alarm display function can be created.
- Set the display to face Up, Down, Right, or Left.
- The graph's color attributes, line types and dot types can all be adjusted.



Note: This “Block (Display Mode)” feature cannot be used with some PLCs. For a complete list of these PLC’s, refer to **Reference** 1.3 “Tag List’s note section -*4.”

2.31.3 Using Trend Graphs

■ General Info.

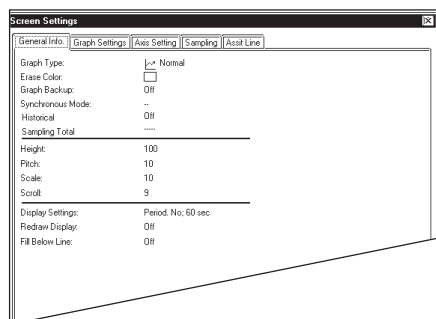

To check the current settings, display the trend graph screen and select the “Tag” selection’s “Setup Screen”.

■ Graph Settings

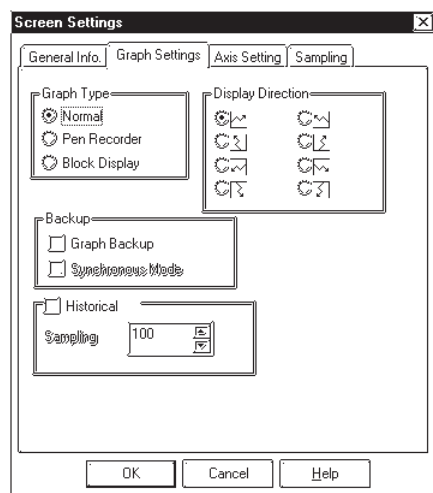

Graph Type

Normal

Pen Recorder

Block Display

Select a graph type from the three types of graphs.

Display Direction

Select the direction of the graph.

Graph Backup ^{*1}

Trend graph data displayed for each trend graph screen is backed up in the GP. The graph types that can be backed up are “Normal” and “Pen Recorder”. When backing up trend graphs in a GP unit with 32K bytes of backup SRAM, approximately 12 trend graphs comprising a total of 639 items of display data can be saved.

**1 The graph data back up function is valid only for the GP models with back up SRAM. GP models with back up SRAM can be recognized by the label attached to the GP’s rear face. When the GP70 series unit’s label color is copper brown, the unit has back up SRAM. GP77R, GP377 and GP2000 series units all have backup SRAM.*

SRAM Seal

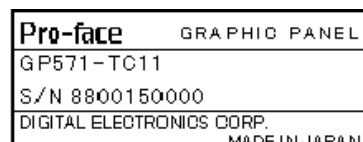

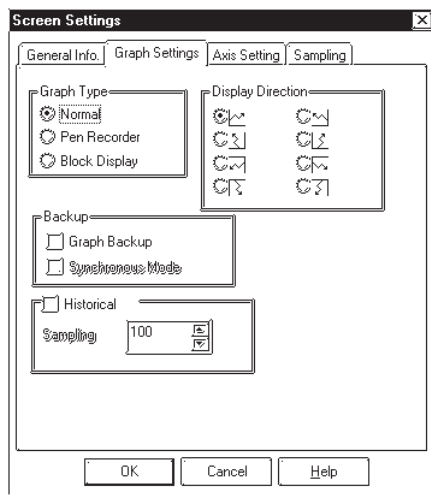

Historical

When this option is selected, the past record of trend graph data is displayed. This function is supported by GP2000 series units only. Also, this function is enabled only when the Graph Type is designated as "Normal" or "Pen Recorder". Enabling "Historical" automatically enables the "Graph Backup" feature. The data record is stored in the GP's backup SRAM. **Reference** "2.31. 6 Principles of Historical Function."

Sampling

When "Historical" is enabled, specify the number of data samples to be stored in a single channel. Enter the total of the quantity of sample data (current) being displayed with the trend graph and the quantity of cumulative sample data (past). Make sure that the value for "Sampling" is greater than the value designated for the "Display Data Amount" on the "Graph Settings" tab. Past data older than the trend graph data currently being displayed on the GP can be displayed. Set the Display Format of a graph to "Bin" and enter the value within the range of 1 to 65238. **Reference** "2.31. 6 ■Graph Display."



Note: • The number of pieces of data that can be backed up will vary depending on the number of Q-tags and the LS Area's back up capacity.

- Although the trend graph backup settings are performed for each screen, backup memory is allocated for each channel set up on a Trend Graph screen until all the backup memory capacity is used.



Important

- **Data stored in the backup SRAM will be erased when:**
 - The memory is initialized
 - The screen data is transferred
 - The GP system protocol is set up
 - The GP's SELF-DIAGNOSIS System's INTERNAL FEPRAM (SCREEN AREA) is running.



- **The GP's OFFLINE setting version 1.30 or higher (included in the GP-PRO/PBIII for Window 95 Ver.1.1 software or higher), data stored in the backup SRAM will not be erased.**
- **The amount of data that can be stored as a historical graph varies with the capacity of backup SRAM and number of trend graph lines. The capacity of backup SRAM varies depending on the GP model and the uses of the backup SRAM. (See "4.12 Backup SRAM Capacity.") The table below shows the maximum number of samples when the backup SRAM is used only for backing up the trend graphs.**

Backup SRAM Capacity	1 line	10 lines	20 lines	30 lines	40 lines
256 KB (GP2000 Series)	65238	6514	3252	2163	1620
128 KB (GP-2401/GP-2501/GP-2601 Series)	32470	3238	1614	1071	801

- **The following is the formula for calculating the capacity of backup SRAM.**

<Backup SRAM capacity with "Graph Backup" enabled and "Historical" disabled>

$$\begin{aligned} &\text{Header size}^* + \{(32 + 4 \times (\text{Display Data of T1} + 2)) \times (\text{No. of Channels of T1})\} \\ &\quad + \{(32 + 4 \times (\text{Display Data of T2} + 2)) \times (\text{No. of Channels of T2})\} \\ &\quad + \dots \text{ bytes} \end{aligned}$$

<Backup SRAM capacity with "Historical" enabled>

$$\begin{aligned} &\text{Header size}^* + \{(32 + 4 \times (\text{No. of Samples of T1} + 1)) \times (\text{No. of Channels of T1})\} \\ &\quad + \{(32 + 4 \times (\text{No. of Samples of T2} + 1)) \times (\text{No. of Channels of T2})\} \\ &\quad + \dots \text{ bytes} \end{aligned}$$

* The header size varies according to the settings as shown in the table below.

Total number of trend graph lines in one Project file	Header size
1 to 20	128 bytes
21 to 40	256 bytes

<Example>

Trend Graph Display	T1 Screen
No. of Channels	3
No. of Samples	30
Display Data	10
Historical Mode	Enabled

When the settings are designated as above, the header size can be calculated with the following formula.

Calculation: $128 + \{(32 + 4 \times (30 + 1)) \times 3\} = 596$ bytes

■ Axis Settings

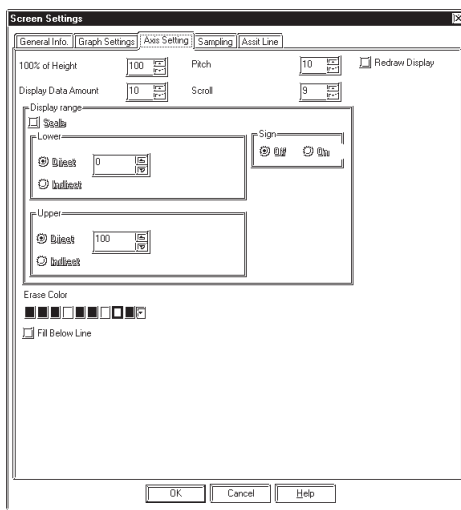

100% of Height

Define the maximum data position of the Y-axis here, and set it directly on the screen.

Pitch

Defines the space, in dots, between each data displayed. The pitch designated here is the first point of the trend line. The next data also displays with the same space between it and the previous data.

Display Data Amount (in one screen)

Defines how many data samplings are displayed on one trend graph line in one screen.

<Screen Setup Range>

	GP-270, GP-H70 GP-370, GP-377R GP-377, GP-2300 GP-2301 (320X240 dot)	GP-470 GP-477R (640X400 dot)	GP-570, GP-577R GP-2400, GP-2401 GP-2500, GP-2501 (640X480 dot)	GP-675 GP-2600 GP-2601 (800X600 dot)
Origin Point	X: 0 to 319	X: 0 to 639	X: 0 to 639	X: 0 to 799
	Y: 0 to 239	Y: 0 to 399	Y: 0 to 479	Y: 0 to 599
Height (100%)	0 to 239	0 to 399	0 to 479	0 to 599
Pitch	1 to 319	1 to 639	1 to 639	1 to 799



Note: • The Origin Point, Height and Pitch vary depending on the GP's screen size and orientation (Landscape or Portrait).

- Set the Axis Setting so that trend graph lines do not exceed the graph display area.



- The table below describes possible values that can be set for the Scale if only one Trend graph channel is used.

<List of Maximum Display Data Amount>

	GP-270, GPH-70, GP-370, GP-377R, GP-377, GP-2300, GP-2301, GP-2301H	GP-470, GP-570, GP-477R, GP-577R, GP-2400, GP-2401, GP-2401H, GP-2500, GP-2501	GP-675, GP-2600, GP-2601
Display Data Amount	319	639	799

* Note that the maximum Display Data Amount (Scale) value is 97 when the "Fill Below Line" option is selected.

Scroll

Specifies the amount of data to scroll when the graph occupies the display area completely. This feature can be used only when the graph type is "Normal".

Redraw Display

When tick marks have been drawn to equally divide the graph display area, and this setting is OFF, the tick marks disappear when the data scrolls over. When this setting is ON, every time it scrolls over or when the graph is erased, the graph display area is drawn again and the tick marks do not disappear. When "Fill Below Line" is selected, this feature is not available.

Display range

Available only with GP2000 series units. This range can be specified only when the graph type is "Block Display".

Scale

When this option is selected, the Assist Line setting is enabled.

Lower/Upper

Defines the lower/upper limit of the display range. Also, when the lower/upper limit values are specified indirectly, the display range can be changed during operation.

Erase Color

Defines the color of the graph display area where the graph does not appear. For a monochrome GP, select Black.

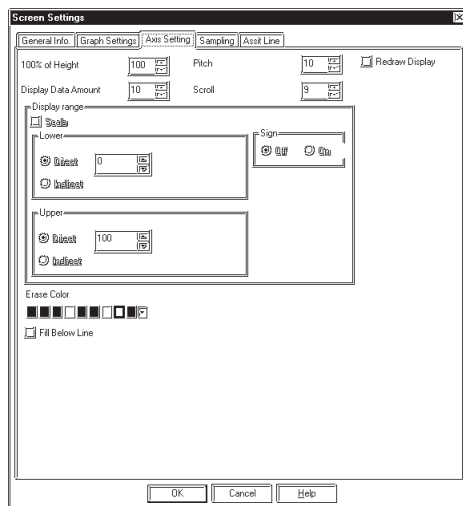

Fill Below Line

When this option is selected, a trend graph's lower area from the channel will be filled. In the graph display area with the "Paint Lower Section" option selected, only one channel's trend graph can be displayed. Also, an alarm cannot be displayed. GP-270 does not have this function.



- The redraw display will fill the graph display area with the clear color, and then draws the graph in the Trend Graph Display. Since it erases graph display with the clear color, the screen may flicker sometimes.

**When setting the Display Range**

- ***The applicable graph type is Block Display only. Display Range cannot be used for Normal or Pen Recorder.***
- ***The range that can be specified is between 0 and 65535 (when a sign is used, between -32768 and -32767).***
- ***Data that exceeds the graph display range will not be displayed.***
- ***The Display Range's update timing (the timing of value reading) is the instant when the graph display is cleared or the screen is switched.***
- ***Changing the Display Range causes the Y-axis horizontal assist line's display to shift.***
- ***When specifying the Display Range, the data format will be treated as fixed 16-Bit Binary format. Although it is possible to select the Channel Settings' Data Format (Absolute, Relative), the selection will be annulled. The sign depends on the display range settings.***
- ***When specifying the Display Range, this option cannot be used with the "Alarm Settings" feature of "Channel Settings".***
- ***When specifying the Display Range, this option cannot be used with the "Fill Below Line" option.***

■ Sampling

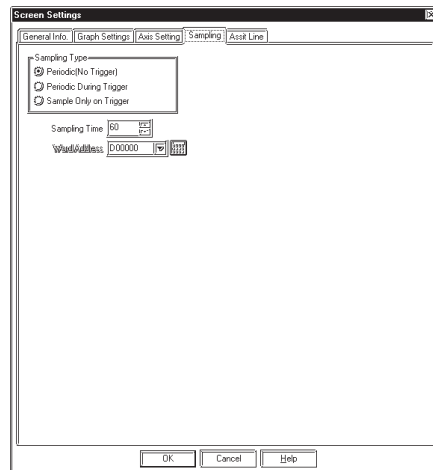

Sampling Type

Defines the data extraction method from the host (PLC) as one of three types: Periodic, Trigger Start, and Trigger Sampling.

Periodic After Trigger

The host (PLC) data is read at the setup intervals starting from when the GP is powered up.

Continuous After Trigger

The host (PLC) data is read at the setup intervals. Data read start, pause, and clear commands can be executed according to changes to the corresponding bit in the word address setup.

Sampling Time

The data is sampled at the optional timing setup. Data read and data clear according to changes to the corresponding bit in the setup word address.

Sampling Time

Defines the sampling time, in 1 second units, for reading data from the host (PLC).

Word Address

(When the Trigger Start is selected)

The 00 and 01 bits of the word address setup here control the data read start, pause, and clear operations.

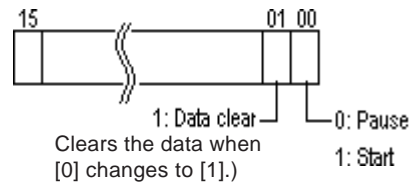

Word Address

(When the Trigger Sampling is selected)

The 00 and 01 bits of the word address setup here control the data read start and clear operations.

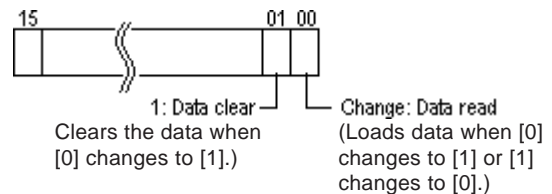



- Please wait until the GP confirms whether the control bits are “0” or “1” (With Direct Access communication, the period will be either the communication cycle time or 50 ms, whichever is longer). With “Memory Link Communication”, the period will be 50 ms or more.
- The communication cycle time is stored in GP internal special relay LS2037. **Reference** *Device/PLC Connection Manual*



- Up to a 1 second delay may occur from the data read to actual data sampling.
- If the data sampling time is shorter than the communication cycle time, sampling may not be performed normally.
- If the Sampling Time is designated as several seconds, data sampling is performed before the PLC reads the data when the communication cycle time exceeds the sampling time. Therefore, previously acquired data may be displayed on a graph. Also, even if the sampling time is set up within the communication cycle time, the communication cycle time can become longer due to screen switching and scrolling operations. As a result, the communication cycle time exceeds the sampling time, which also results in the displaying of the previously acquired data on a graph.

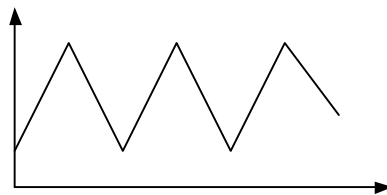

Normal graph display

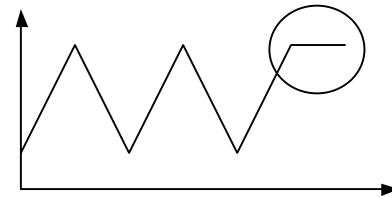

When data is not read

■ Assist Line

This feature is available only with GP2000 series units.

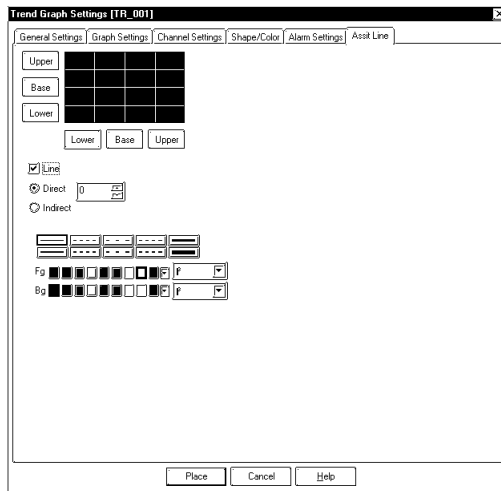

Upper, Reference, Lower

Specify the upper, lower and reference lines.

An image of the specified lines is displayed.

Draw a line

Specify the setting of lines.

Direct

Indirect

Designate the word address.

Line Type

Select a line type from the eight line types available.

Color

Defines the Foreground (Fg) and Background (Bg) colors.



Important

- ***This setting is effective only when the parameters for the "Display range" setting are specified.***
- ***The applicable graph type is Block Display only. Assist lines cannot be used for Normal or Pen Recorder.***
- ***When assist lines are indirectly designated, the update timing (the timing of value reading) is the instant when the graph display is cleared or the screen is switched.***
- ***If the specified value of an assist line exceeds the graph display range, the assist line is not displayed.***
- ***The drawing sequence is as follows: upper line, lower line, reference line and graph data.***
- ***The assist line option cannot be used with the "Fill Below Line" option.***
- ***The horizontal assist line for the Y-axis is specified with a value between 0 and 65535 (when a sign is used, between -32768 and -32767).***
- ***The vertical assist line for the X-axis is specified with a value between 0 and 1000 (rate per thousand). The center position is 500 and the maximum position is 1000.***

2.31.4 Channel Settings

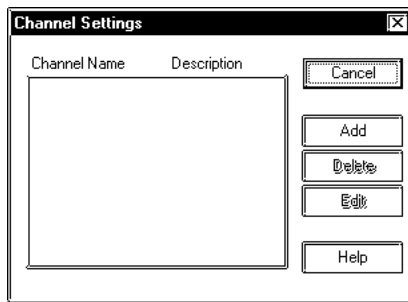

To check the current settings, display the trend graph screen and select the “Tag” selection’s “Setup Channel”.

Add

Use this button to set a new channel.

Delete

Use this button to delete a channel which has been set. Select the channel name then press the “Delete” button.

Edit

Use this button to edit a channel which has been set. Select the channel name then press the “Edit” button.

■ General Info.

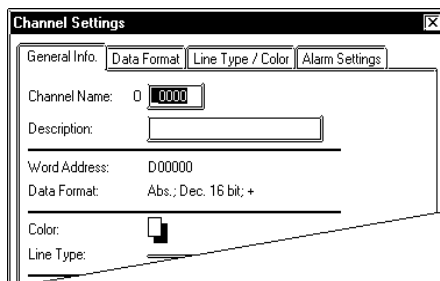

The General Info. page provides information about the current channel settings for the Trend Graph Display.

Channel Name

Up to five Single-byte or two Double-byte characters can be entered. Can be letters and/or symbols.

Description

Up to 20 Single-byte or 10 Double-byte characters can be entered.

■ Data Format/Absolute

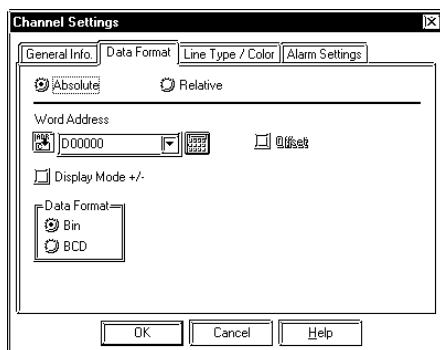

Absolute

Data displays as an absolute value. When using absolute values, select either Binary or BCD data.

Word Address ^{*1}

Displays the data stored in the word address setup here, which uses 16 bit data.

Offset ^{*2}

This option is valid when Block Display has been selected for the trend graph screen settings. The graph data storage address can be specified via the offset setting. The offset setting is valid when the Word Address is set to other than the LS Area.

Display Mode +/-

When using negative data, check this option. This function is available only when the Bin option is selected.

*1 The PLC's designated in the 1.3 Tag List's note section - *4 can only set the LS Device.

*2 This feature cannot be used with some PLCs. For a complete list of these PLC's refer to **Reference** 1.3 Tag List's note section -*4.

Data Format

Bin

BCD

Define the format of the numeric value in the set word address.



Note: • When the Block Display setting is used with a Trend graph, the PLC Word Address and LS Area can be designated as a specific Word Address. To perform Block Display via the host using the direct access method after designating the LS area, the [GP System Setting/Mode Setting/Read Area Size] settings must be configured. The GP-270 only supports the LS Area.

• Trend graph display examples for each mode:

Displays negative data.

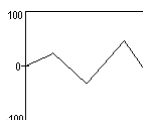

Does not display negative data.

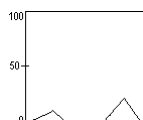

■ Data Format/Relative

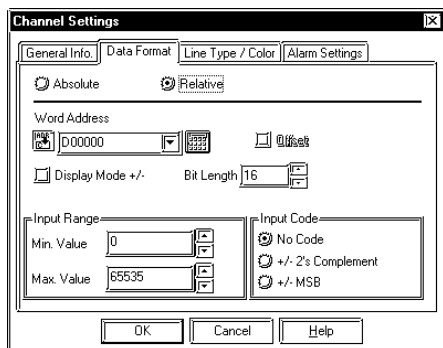

Relative

Input data is converted to the set up display range.

Word Address

Displays the data stored in the word address setup here, which uses 16 bit data.

Display Mode +/-

Set this up when negative numbers are desired.

Bit Length

Defines the valid bit length for the data stored in the set word address.



• When specifying the “Display range” within the “Screen Settings | Axis Setting”, the data format will be treated as fixed 16-bit binary format. Although it is possible to select the Channel Settings Data Format (Absolute, Relative), the selection will be disabled (not effective) on the GP. However, the “Offset” value will be enabled.

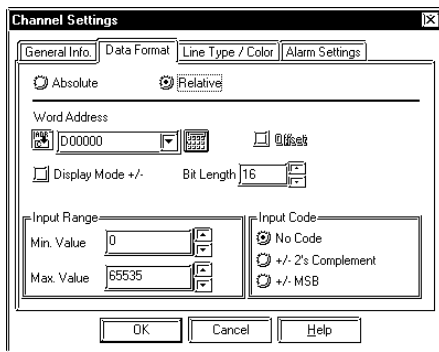

Input Range

Min. Value
Max. Value

Defines a range for data stored in the Word Address. The possible setup ranges differ with the set Code Input.

Input Code

No Code

When set to None, only positive values become available.

+/- 2's Complement

2's complement format is used for negative values.

+/- MSB

MSB format is used for negative values.

■ **Line Type / Color**

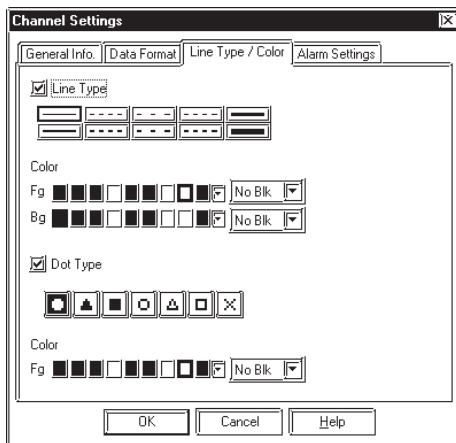

Line Type

Select a line type from the 8 different line types.

Color

Defines the Foreground (Fg) and Background (Bg) colors and Blink (Blk) attributes. When the alarm is ON, the colors set here are referred to as the normal display colors.

Reference “2.1.5 Color Settings”, A-tag

Dot Type

Select one of the seven different dot types. Available only when Graph type is “Block Display”.

Color

Defines the Foreground (Fg) color. Available only when the graph type is “Block Display”.



Note:

When using a dotted line, please be sure to set the pitch to a value greater than 16 dots. If the pitch is set to a smaller value, the line may not be drawn properly.

■ **Alarm Settings**

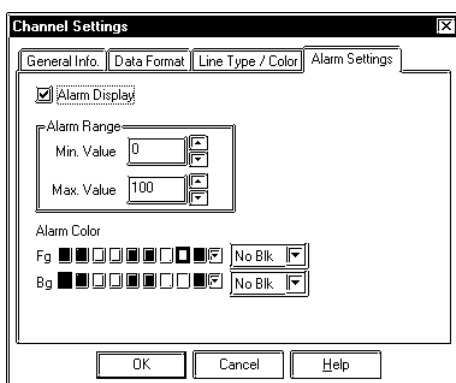

Alarm Display

When data read from the host (PLC) is outside the set up Alarm Range, the alarm displays with the set colors and attributes.

Alarm Range

Min. Value
Max. Value

Set a maximum and minimum value from 0 to 100.

Alarm Color

Defines the foreground and background colors, and blink attributes of the alarm.

2.31.5 Block Display Mode (for PLC Direct Access)

When using the Block Display feature, reserve the areas for the number of addresses specified below, beginning from the specified Word Address.

■ **Block Display Word Address**

The LS Area (from LS0020) or the PLC Word Address is specified. There is speed difference between when the LS Area is used and when the PLC Word Address is used. Refer to the following:

◆ **When using the LS Area**

When specifying the LS Area, designate “Read Area Size”. The Read Area constantly reads out data from the PLC to the GP, regardless of screen display status. For Block Display, “Control”, “Data Count”, and “Data” are required to be specified for the Read Area. Since this area always reads out data, the time from Control bit turning On to graph display will be shorter than when using the PLC Word Address. However, when the Read Area size is large, the entire screen display time will be slower than when using the PLC Word Address. Also, the Read Area size is limited up to 256 words.

◆ **When using the PLC Word Address**

When the PLC Word Address is used, “Control”, “Data Count” and “Data” are constantly read out from the PLC to the GP, regardless of screen display. The time from the “Control” display bit turning ON to graph display to read out “Data” will be longer than the time when the LS Area is used. However, when graph display is not performed, time required to display data of the entire screen will be shorter than when using the LS Area. This function is also useful when data for more than 256 words is required to display multiple graphs via the Block Display function.



When the PLC Word Address is used, to increase the entire screen data display speed to display multiple graphs via Block Display function, the following method is useful.

Specify the Offset of all graphs displayed via the Block Display function, and then designate each graph’s “Control”, “Data Count”, and “Offset” with consecutive address.

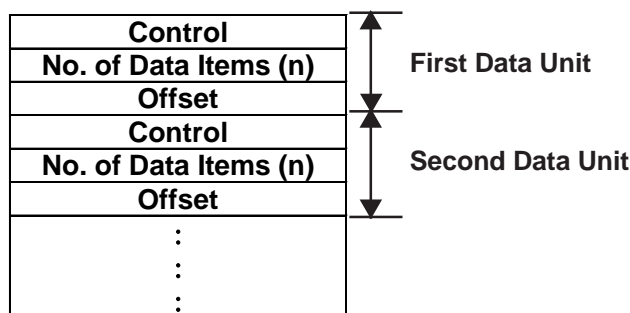

◆ **Word Address's setting items**

The Word Address setting items for Block Display is as follows:

The Offset setting is valid only when the PLC Word Address is used. However, GP-270 does not have the PLC Word Address setting.

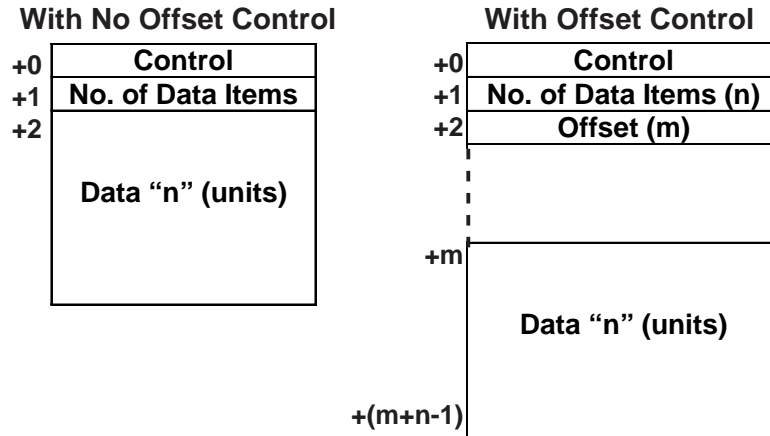

◆ **Control**

The role of each bit in the Control Status word is described in the following passages.

- To begin the graph display, turn bit 00 ON.

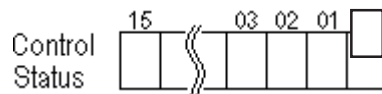

- To clear the entire graph, turn bit 01 ON.



- To clear the graph, then re-draw it, turn both bit 00 and bit 01 ON.



◆ **Data Count**

Defines the number of data values to display on the graph. To display a graph like the one shown below, set the Data Count to 7.

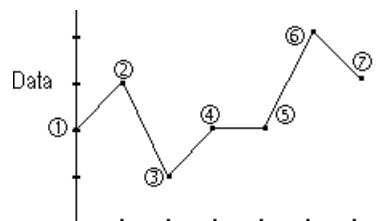



- To display the graph, delay Control Status setting by a time longer than the communication cycle time or 50ms (whichever is larger), after storing the data count and data values.
- After displaying the graph, the Control Status resets to 0. To display the graph again, store the data in the same Control Status word. However, be sure to delay by a time longer than the communication cycle time or 50 ms (whichever is larger) after the Control Status changes from 1 to 0.
- The Scale value setup in the Axis Setting dialogue box refers to the number of trend line segments (“6” in the above diagram), and the Data Count for the block display trend graph refers to the number of data points.
- To display the graph with the LS area setting, delay Control Status setting by a time longer than the communication cycle time or 50ms (whichever is larger), after storing the data count and data values.
- To display the graph with the PLC Word Address setting, delay Control Status setting by a time longer than the communication cycle time or 50ms (whichever is larger), after storing the data count and data values.

◆ Offset

The area where the data for a trend graph is stored is indicated. When the PLC Word Address is used, this setting is valid.

◆ Data

This area stores the data for a trend graph.

■ Setting Example (when the offset setting is not used:)

◆ When using only the display

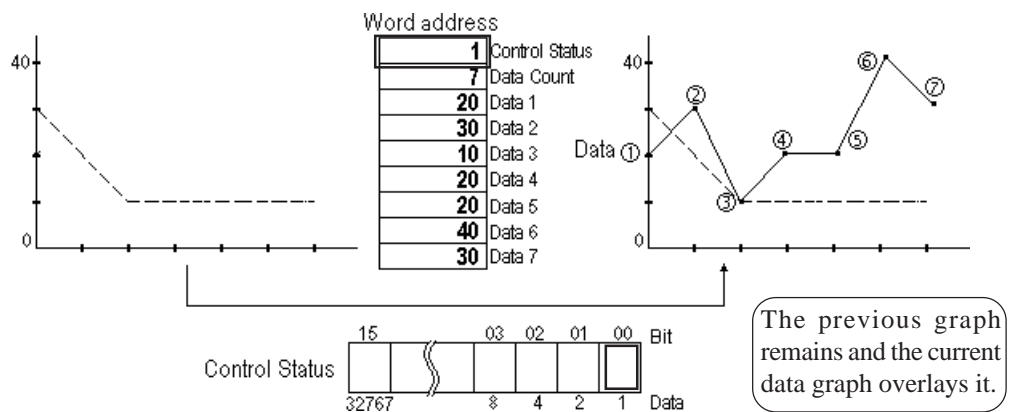

When “1” is entered to the Control Status word, bit 00 turns ON and the new graph overlays the previous display.

◆ When clearing the display

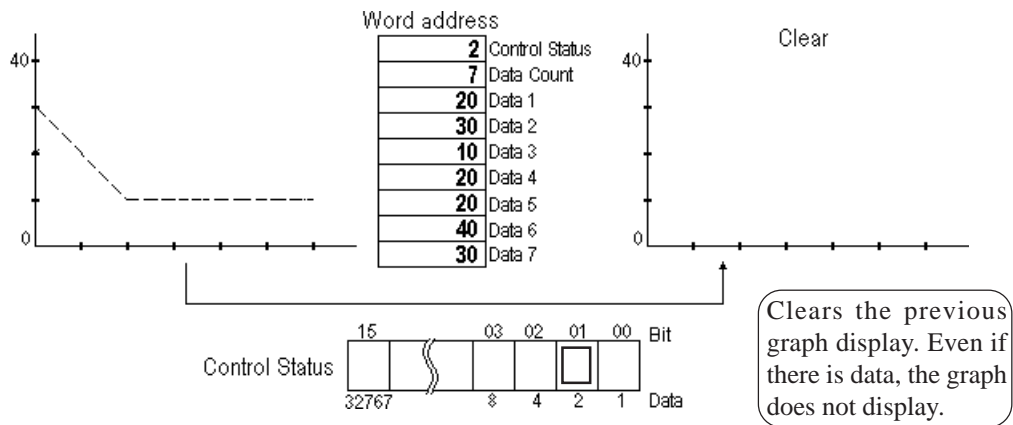

When “2” is entered to the Control Status word, bit 01 turns ON and the new graph display is cleared.

◆ When clearing then displaying the graph again

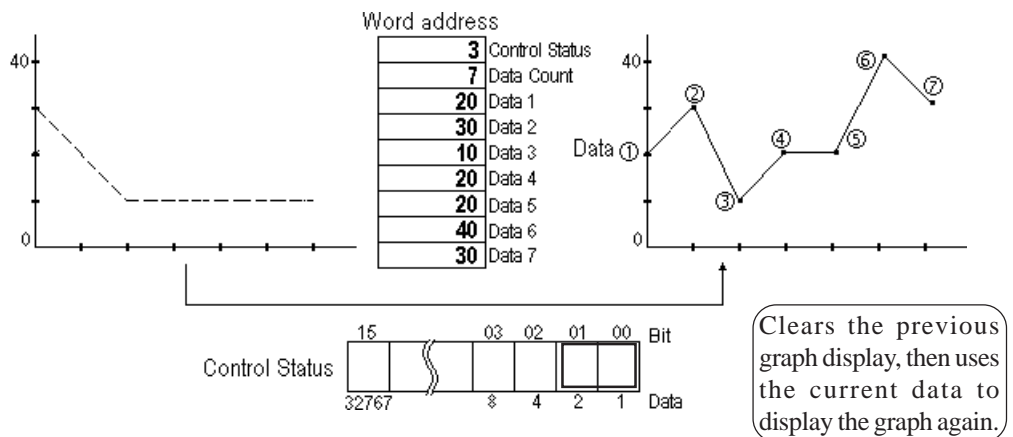

When “3” is entered to the Control Status word, both bits 00 and 01 turn ON, and after the graph display is cleared, the current data is used to display the graph again.

2.31.6 Principles of Historical Function

The Trend Graph (T) Screen allows the trend graph screen (No. of Samples and Backup settings, etc.) to be configured for displaying the past data and channel settings (detailed settings for each trend line). The Historical function is supported only by GP2000 series units.

Reference *For the graph setting procedures, refer to "2.31.3 Using Trend Graphs-Graph Settings" and "2.31.4 Using Trend Graphs-Channel Settings."*

This section describes how the trend graphs operate on the GP screen when the Historical function is enabled.

Function Switches are required to operate a trend graph featuring the Historical function on the GP's screen. They are used to display the trend graph ("Record Display" switch), move the trend graph currently being displayed back ("Prev" switch) and forth ("Fwd" switch) between "current" and "past" data. The Function Switches are set up automatically with a Trend graph part. For details of the Trend graph part, **Reference** *Operation Manual, "2.1.12 Trend Graph."*

Setting up Function Switches individually, **Reference** *Operation Manual, "2.1.3 Function Switch."*



- **The display shows the condition after switching to "Historical" mode. Therefore, the display will not be updated even when sampling is performed while data are being displayed. The display will be updated when the "Historical" mode is canceled.**
- **Only one Trend Graph Display with the "Historical" function enabled can be set up on the Base screen.**
- **Up to 20 channels can be set up for the trend graph (T) screen. The data in backup SRAM is also cleared.**
- **When "Sampling Type" in the "Sampling" tab in the "Graph Settings" dialog box is designated as either "Continuous After Trigger" or "Sampling Time", clearing the data will erase all data records. The data record will not be stored in the backup SRAM.**
- **Switching the screen from a trend graph screen under the Historical mode to another screen cancels the Historical mode.**



- The "Historical" function can be enabled under all Sampling Type settings (Periodic After Trigger, Continuous After Trigger, and Sampling Time) of a trend graph.
- Data sampling is executed continuously while the past data record is being displayed.
- A trend graph with "Historical" can be used together with a trend graph without "Historical" in the Project file (PRW file).
- Only one "Disp" switch (Function Part) can be set up on a single Base screen of a trend graph using the Historical function. Set up various scroll amounts by setting up multiple "Prev" and "Fwd" switches.

■ Graph Display

When displaying a trend graph featuring the Historical function, the GP's screen will not display the area marked with the dots in the illustration below. The illustration below shows the trend graph with the following settings: No. of Samples: 14, Display Data Amount (Scale): 6

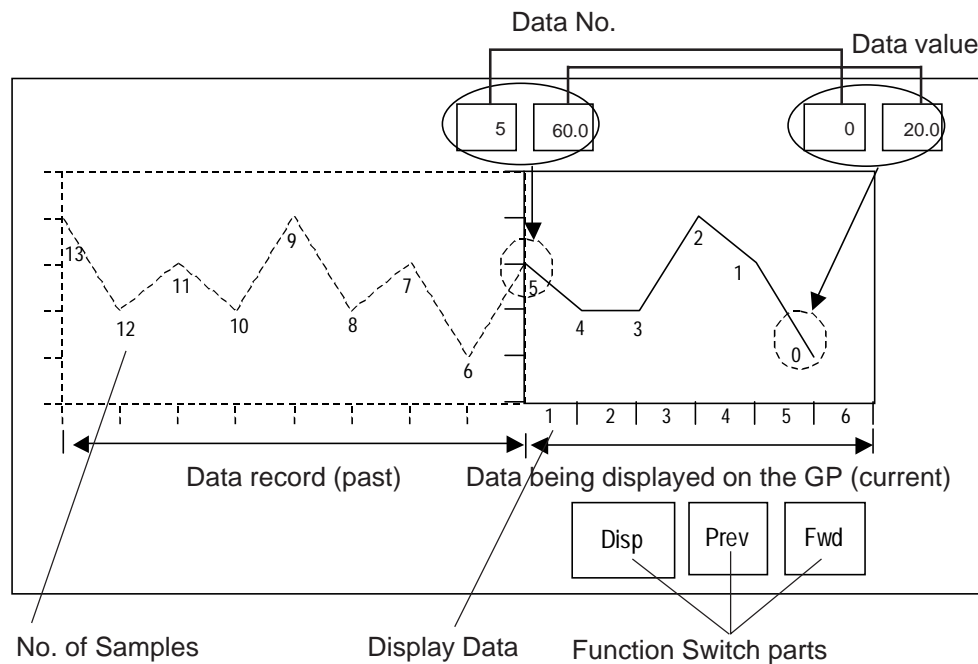

■ Data No./Data value

Data Numbers are assigned to data values, with the most recent data value (sampling data) designated as Data No. 0. The data values are stored after being automatically numbered in reverse chronological order, starting with the most recent numbered as "0," followed by "1", "2", "3", etc. The Data Numbers are stored in the LS area as binary numbers in the range of 0 to 65237.

The Data Numbers and Data values of the samples enclosed within the dotted circles of the graph on the previous page are displayed with the Numeric Display.

The Data Numbers and Data values are stored in the LS area as illustrated below, but only when a trend graph with the Historical Function is displayed on the GP. The data will be stored regardless of the ON/OFF states of the Historical mode. The stored data is cleared to 0 when the screen is switched. However, when another trend graph featuring the Historical Function is set up on the next screen, The data samples of the trend graph are stored in the LS area. Each piece of data stores the entered value in thousandths. When +/- display mode is selected, the range is -1000 to 1000.(Values are converted into display data.) For example, to display the data value ".200" as the numerical value "20.0" on the Numeric Display, E-tag, or N-tag, designate the "Decimal Places" setting as "1".

LS Area	
LS9000	Data No.
LS9001	Data of Line 1
LS9002	Data of Line 2
LS9003	Data of Line 3
:	:
LS9020	Data of Line 19
LS9021	Data of Line 20
LS9022	Reserved
:	
LS9029	
LS9030	Data No.
LS9031	Data of Line 1
LS9032	Data of Line 2
LS9033	Data of Line 3
:	:
LS9050	Data of Line 19
LS9051	Data of Line 20
LS9052	Reserved
:	
LS9059	
LS9060	Reserved
:	

Storage area for the oldest data that can be displayed on the GP screen (In the previous page's graph, the Data No. is "5" and the Data Value is "60".)

Storage area for the most recent data that can be displayed on the GP screen (Data No is "0" and Data Value is "20" in the previous page's graph.)

■ **Historical**

The past data record can be displayed with the following procedure.

The illustration below shows the trend graph with the following settings:
 No. of Samples: 14, Display Data Amount (Scale): 6

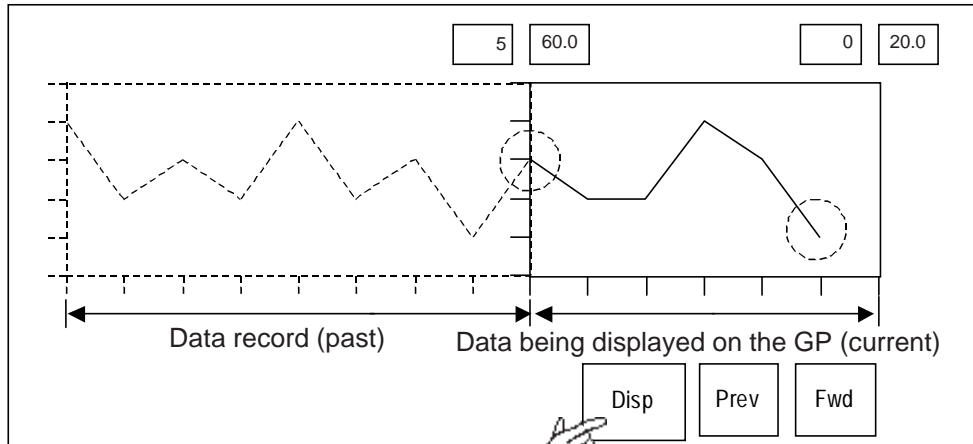

Press the "Disp" switch to enable Historical mode. The switch is displayed in reverse video. It remains in reverse video while the Historical function is ON.

Touching the "Prev" switch scrolls the data backward by the predetermined number of data and displays previous data records.

Touching the "Prev" switch while the oldest data is being displayed causes the buzzer to sound three times. The data cannot be scrolled further.

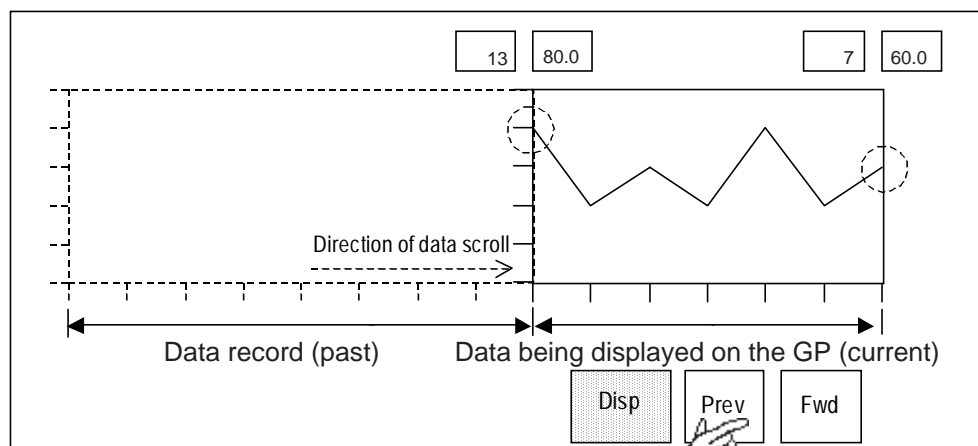

Next, touch the "Fwd" switch.

Touching the "Fwd" switch scrolls and displays the data toward the data that was the most recent at the moment the mode was switched to Historical mode.

When the data is scrolled to the most recent data, the display is blank. If the "Fwd" switch is touched again while the display is blank, a buzzer sounds three times. The data cannot be scrolled further.

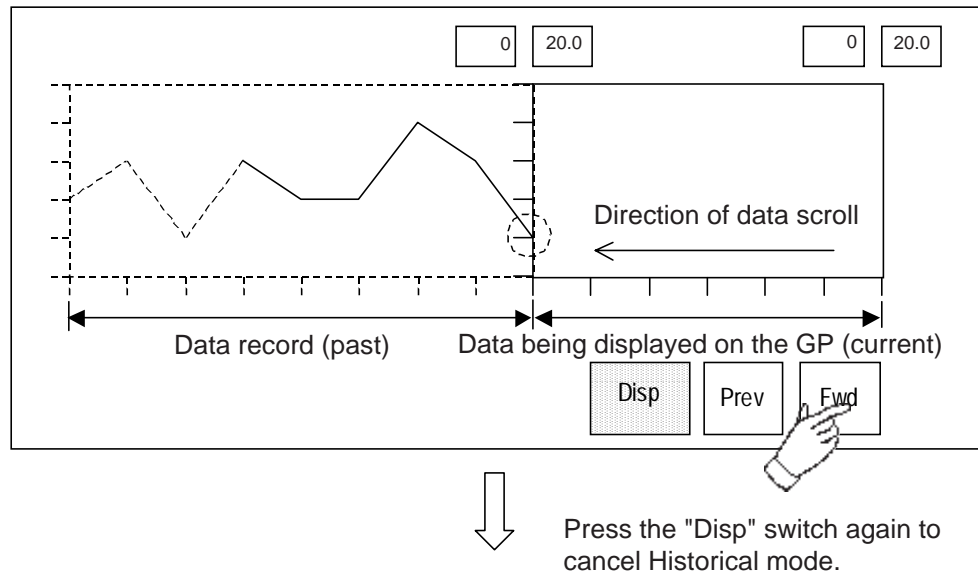

The display shows the data updated while the Historical mode is ON.

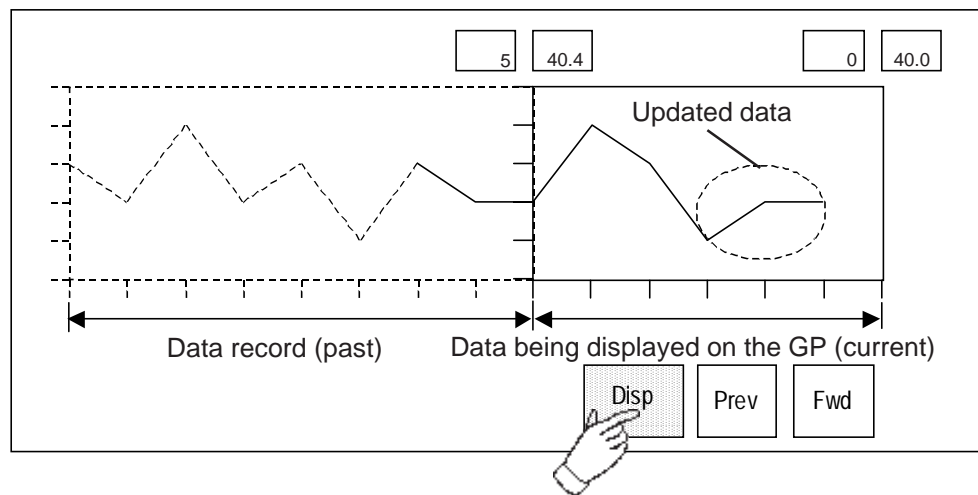



The following are the restrictions on the number of Trend graph (T) screens featuring the Historical function that can be loaded onto a single Base (B) screen.

- Number of trend graph screens that can be displayed with the Historical function: Only one screen can be loaded to the screen.
- Number of trend graph screens that can be displayed without the Historical function: Up to seven screens can be loaded to the screen.

2.31.7 Trend Graph Data's CSV File Storage Example

This section shows sample content of a CSV file of trend graph data stored in the CF Card and a sample display shown when the file is opened with Microsoft Excel. The following two patterns are available

For details on saving in CSV format, [Reference](#) "4.7 Using the CF Card."



Note: This function is supported only by GP77R and GP2000 series units. In addition, an optional Multi Unit (sold separately) is required to use the CF Card with the GP77R series unit.

◆ **When no trend graph with "Historical" enabled is set up in the Project file**

• **Example of trend graph screen settings:**

T10 screen: Historical: Disabled, Graph Backup: Enabled, Display Data Amount (Scale): 15

T20 screen: Historical: Disabled, Graph Backup: Disabled, Display Data Amount (Scale): 15

• **Sample content of CSV file**

```

"Screen No.", "T10", "T10", "T20"
"Channel Name", "012345", "0abcd", "01a2b3"
"Display Data", "15", "15", "15"
"Current No. of Samples", "8", "8", "5"
"Data", "50.0", "80.0", "90.5"
"", "90.0", "70.0", "80.0"
"", "40.0", "20.0", "-40.0"
"", "50.0", "10.0", "50.8"
"", "50.0", "90.0", "-90.5"
"", "10.0", "70.0", ""
"", "80.0", "60.0", ""
"", "70.0", "50.0", ""

```

• **When opening the file with Excel**

Screen No.	T10	T10	T20
Channel Name	012345	0abcd	01a2b3
Display Data	15	15	15
Current No. of Samples	8	8	5
Data	50	80	90.5
	90	70	80
	40	20	-40
	50	10	50.8
	50	90	-90.5
	10	70	
	80	60	
	70	50	

↑ Old data

↓ New data



- **Note:** Only data is output as CSV files.
- When performing the relative value settings, values after the decimal point are also displayed.
- When the values after the decimal point is “0”, “0” is not displayed on the Excel.

◆ **When one or more trend graphs with "Historical" enabled is set up in the Project file**

• **Example of trend graph screen settings:**

T1 screen: Historical: Disabled, Graph Backup: Enabled, Display Data Amount (Scale): 15

T8999 screen: Historical: Enabled, Graph Backup: Enabled, No. of Samples: 1,000

T50 screen: Historical: Disabled, Graph Backup: Disabled, Display Data Amount (Scale): 15

• **Sample content of CSV file**

```

"Screen No.", "T1", "T1", "T8999"
"Channel Name", "012345", "0abcd", "01a2b3"
"Maximum Data Count*", "16", "16", "1000"
"Current No. of Samples", "8", "8", "5"
"Data", "50.0", "80.0", "90.5"
"", "90.0", "70.0", "80.0"
"", "40.0", "20.0", "-40.0"
"", "50.0", "10.0", "50.8"
"", "50.0", "90.0", "-90.5"
"", "10.0", "70.0", ""
"", "80.0", "60.0", ""
"", "70.0", "50.0", ""
    
```

* The maximum number of samples. When Historical mode is enabled for a trend graph, the value designated as the "Sampling" is the equivalent of the Maximum Data Count. When the "Historical" setting is disabled and the "Graph Backup" setting is enabled for a trend graph, the Maximum Data Count is determined by adding "1" to the value of the "Display Data Amount".



Note: The data of trend graphs with the "Graph Backup" setting enabled are saved to a CSV file. In this case, the T50 screen shown in "Setting example of trend graph screen" above is not saved to a CSV file.

• When opening the file with Excel

Screen No.	T1	T1	T8999
Channel Name	012345	0abcd	01a2b3
Maximum Data Count	16	16	1000
Current No. of Samples	8	8	5
Data	50	80	90.5
	90	70	80
	40	20	-40
	50	10	50.8
	50	90	-90.5
	10	70	
	80	60	
	70	50	

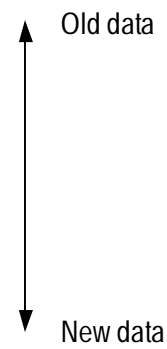

- Only data is output as CSV files.
- When performing the relative value settings, values after the decimal point are also displayed.
- When the values after the decimal point is "0", "0" is not displayed on the Excel.



3 Special Features

The following chapter outlines the special “D-Script” function, and describes all D-Script parameters and settings.

3.1 D-Script / Global D-Script

3.1.1 Overview

Use the D-Script function to design your own program and execute it on the GP to provide additional display functions. D-Script programs also help to reduce the host’s (PLC’s) data display load.

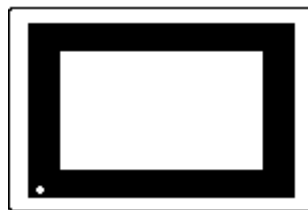

Trigger: Bit Rising
 Bit address: M0050
 Action: [W:D00100]=100

← Parts of a host’s (PLC’s) ladder program can be replaced by D-Script commands.

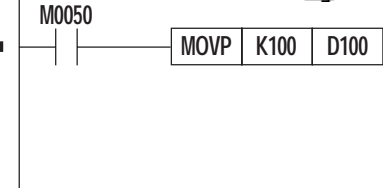
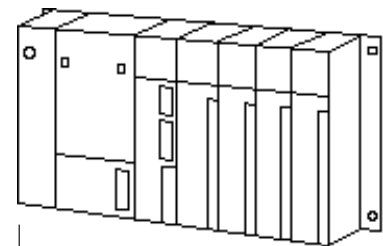

3.1.2 About D-Script

- The following two types of D-Scripts are available: D-Script is enabled only in the currently active screen, whereas Global D-Script is enabled in the entire project regardless of the currently active screen being displayed. Global D-Script is supported only by GP77R/GP377/GP2000 series units.
- Thanks to the Global D-Script feature, Bin→ BCD display format changes, text data changes, or other functions, all previously performed by the PLC, can now be performed by the GP.
- Since D-Script is a language-based program, programming can be performed with relative ease.
- D-Script can be programmed as a trigger to sense the leading or falling edge of a bit, to activate a timer, or to detect true or false of a given condition.
- There are three elements in a D-Script, Operators, Statements, and Operands, which can be used to program conditions in the host (PLC).
- There are four types of commands: Drawing, Mathematical calculations, Boolean operations, and Bit operations.

- The syntax check function of the Screen Creation Software enables a syntax check while the program is being written.
- Syntax auxiliary function provides a pop-up keyboard for address settings to enhance programming efficiency.
- Programming commands can be entered via icons.



NEVER use the D-Script/Global D-Script function for the control of machines or actions which have the possibility of resulting in either operator injury or damage to equipment.

◆ Differences between the Commands of D-Scripts and Extended SIO Scripts

Item	Command/Function	D-Script/Global D-Script	Extended SIO Script
Data Format	Bin/BCD	○ (Selectable)	Bin only
Bit Length	16 bits/32 bits	○	○
Code	Code/No Code	○	○
Trigger	Timer setting	○	x (Not selectable)
	Leading edge of bit	○	x
	Falling edge of bit	○	x
	Bit dual operation	○	x
	True condition of bit	○	x
	False condition of bit	○	x
Draw	Load Screen	○	x
	Point	○	○
	Line	○	○
	Circle	○	○
	Square	○	○
Operator	Addition (+)	○	○
	Subtraction (-)	○	○
	Remainder (%)	○	○
	Multiplication (x)	○	○
	Division (/)	○	○
	Substitution (=)	○	○

Item	Command/Function	D-Script/Global D-Script	Extended SIO Script
Comparison	Bit-wise AND	○	○
	Bit-wise OR	○	○
	Negation (NOT)	○	○
	Less than (<)	○	○
	Less than or Equal (<=)	○	○
	Not equal (<>)	○	○
	Greater than (>)	○	○
	Greater than or Equal (>=)	○	○
	Equal (=)	○	○
Memory Control	Memory Copy: memcpy ()	○	○
	Memory Reset: memset ()	○	○
	Memory Copy (variable-designated) _memcpy_EX ()	○	○
	Memory Reset (variable-designated) _memset_EX ()	○	○
	Offset Address	○	○
Bit Control	Shift Left (<<)	○	○
	Shift Right (>>)	○	○
	Bit-wise AND (&)	○	○
	Bit-wise OR ()	○	○
	Bit-wise XOR (^)	○	○
	1's complement (-)	○	○
	Set Bit: set ()	○	○
	Clear Bit: clear ()	○	○
	Toggle Bit: toggle ()	○	○
Statement	if ()	○	○
	if () else	○	○
	loop (), break	○	○
	loop () infinite loop	x	○
Address	Bit address	○	LS Area only
	Word address	○	LS Area only
	Temporary work address	○	○ ^{*1}
Constant	Dec, Hex, Oct	○	○

*1 The temporary address exists independently of the conventional D-Scripts and Global D-Scripts.

Item	Command/Function	D-Script/Global D-Script	Extended SIO Script
SIO Function	Receive: IO_READ ([p:SIO])	○	○
	Send: IO_WRITE ([p:SIO])	○	○
	Extended receive: _IO_READ_EX ()	x	○
	Extended send: _IO_WRITE_EX ()	x	○
	Wait-receive function: _IO_READ_WAIT ()	x	○
	Control: [c:EXT_SIO_CTRL]	○	○
	Status: [s:EXT_SIO_STAT]	○	○
	Received Data Size: [r:EXT_SIO_RECV]	○	○
String Control	String	x	○
	Data Buffer: databuf0, databuf1, databuf2, databuf3	x	○
	Set string: _strset ()	x	○
	Copy from Data Buffer to LS Area: _dlcopy ()	x	○
	Copy from LS Area to Data Buffer: _ldcopy ()	x	○
	Hexadecimal to binary number conversion: _hexasc2bin ()	x	○
	Decimal string to binary number conversion: _decasc2bin ()	x	○
	Binary number to hexadecimal string conversion: _bin2hexasc ()	x	○
	Binary number to decimal string conversion: _bin2decasc ()	x	○
	Function for retrieving string length: _strlen ()	x	○
	Function for concatenating strings: _strcat ()	x	○
	Function for partial string: _strmid ()	x	○
	Status: [e:STR_ERR_STAT]	x	○
Wait Function	Wait function: _wait ()	x	○
Function	Call	○	○
	return	x	○
CF File Control	File list output _CF_dir()	○	○
	File read _CF_read()	○	○
	File write _CF_write()	○	○
	File delete _CF_delete()	○	○
	File rename _CF_rename()	○	○
Printer Control	Printer port output IO_WRITE([p:PRN])	○	○

3.1.3 Using D-Script

D-Script Editor

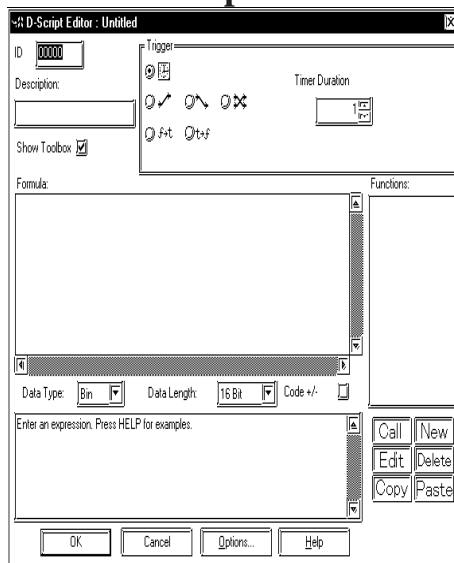

ID

Each D-Script program is uniquely identified by an ID number. Enter an ID number in the range of 00000 to 99999.

Description

Up to 20 Single-byte or 10 Double-byte characters can be entered here as a description about the D-Script you are to create.

Show Toolbox

When checked, the tool box appears that contains the Operators, Statements, and Operands used to create the D-Script program.

Data Type

Designates the D-Script data format as either Bin or BCD.

Bit Length

Designates the D-Script data bit length as either 16 bits or 32 bits.

+/- Code

Please refer to this table when entering negative numeric data.

<Constant Data Entry Ranges>

Data Format	Constant Entry	
	Min. Value	Max. Value
Bin16	0	65535
Bin32	0	4294967295
Bin16+/-	-32768	32767
Bin32+/-	-2147483648	2147483647
BCD16	0	9999
BCD32	0	99999999



• When a D-Script's command follows another D-Script's command, enter a space between these commands.

For example, if the "not" command follows the "and" command, spacing is needed between the commands.

"andnot": Incorrect (The operation will not be performed and an error message will display on the software screen.)

"and not" : Correct

An error message will be displayed on the Screen Creation Editor if the statement includes errors.

■ Trigger



Trigger

These selections designate the type of trigger used to activate your program. The possible options are “Timer”, “Bit Rising”, “Bit Falling”, “Expression becomes Non-Zero”, and “Expression becomes Zero.”

Timer Settings

When the designated time elapses, the statements described in the Action area of your program are performed. The timer duration can be set from 1 to 32767 seconds. The timer restarts its counting when the designated time elapses.

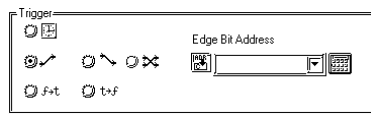

Bit Rising

When the GP detects the designated bit change from 0 to 1, the statements described in the Action area are performed.

Bit Falling

When the GP detects the falling edge of the designated bit, the statements described in the Action area are performed.

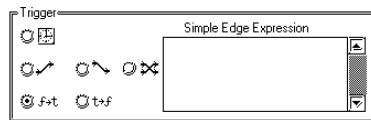

Bit Dual Operation Trigger

When the GP detects the designated bit change from 0 to 1, or the falling edge of the designated bit, the statements described in the Action area are performed. **Only GP77R, GP377 and GP2000 series units support this function.**

• **f → t (Expression becomes Non-Zero)**



When the GP detects true of a given condition in a triggering program, the statement described in the Action area of your program is performed only one time at the detection.

• **t → f (Expression becomes Zero)**

When the GP detects false of a given condition in a triggering program, the statement described in the Action area of your program is performed only one time at the detection.



Important

- **Depending on the time taken to draw a screen item or to print-out data, the timer function may be slowed.**
- **Switching the screen will cause the timer function to restart counting from 0. When using D-Script, the Global D-Script’s timer function works continuously.**
- **When setting the timer function’s time, the time value will include the set time + tag scan error.  Reference  Device Connection Manual / Special Relay (Tag Scan Counter).**



- Be sure that the time taken to write to the PLC Device is longer than the communication cycle time. An error or system error may occur if the GP internal special relay's tag scan counter or other counter is used as a write trigger to frequently write data to the PLC device.
- The bit designated for the "Bit Rising / Falling" option must be held ON or OFF for longer than the tag scanning time (stored in LS2036).
- Be sure to set the "Detect True Condition of Bit/ Detect False Condition of Bit" selection to more than the Tag Scan Time (stored in LS2036).
- When the bit used for the D-Script Trigger Condition is set for "touch" and that bit turns OFF during D-Script processing, the timing used when pressing the touch area repeatedly can prevent the detection of the bit's rise.
- The D-Script trigger will compare the previously read out value to the currently read out value to determine if the trigger is now "True". However, during a single scan, the value that is stored in the bit address used during the Trigger operation is kept the same, even if the value is changed during execution. The new value is read out only after the next scan begins.

Ex. When Touch is used to turn trigger bit (LS010000) ON, and D-Script turns the value OFF:

Trigger: Leading Edge of Bit ([b:LS010000])

Execute: clear([b:LS010000])

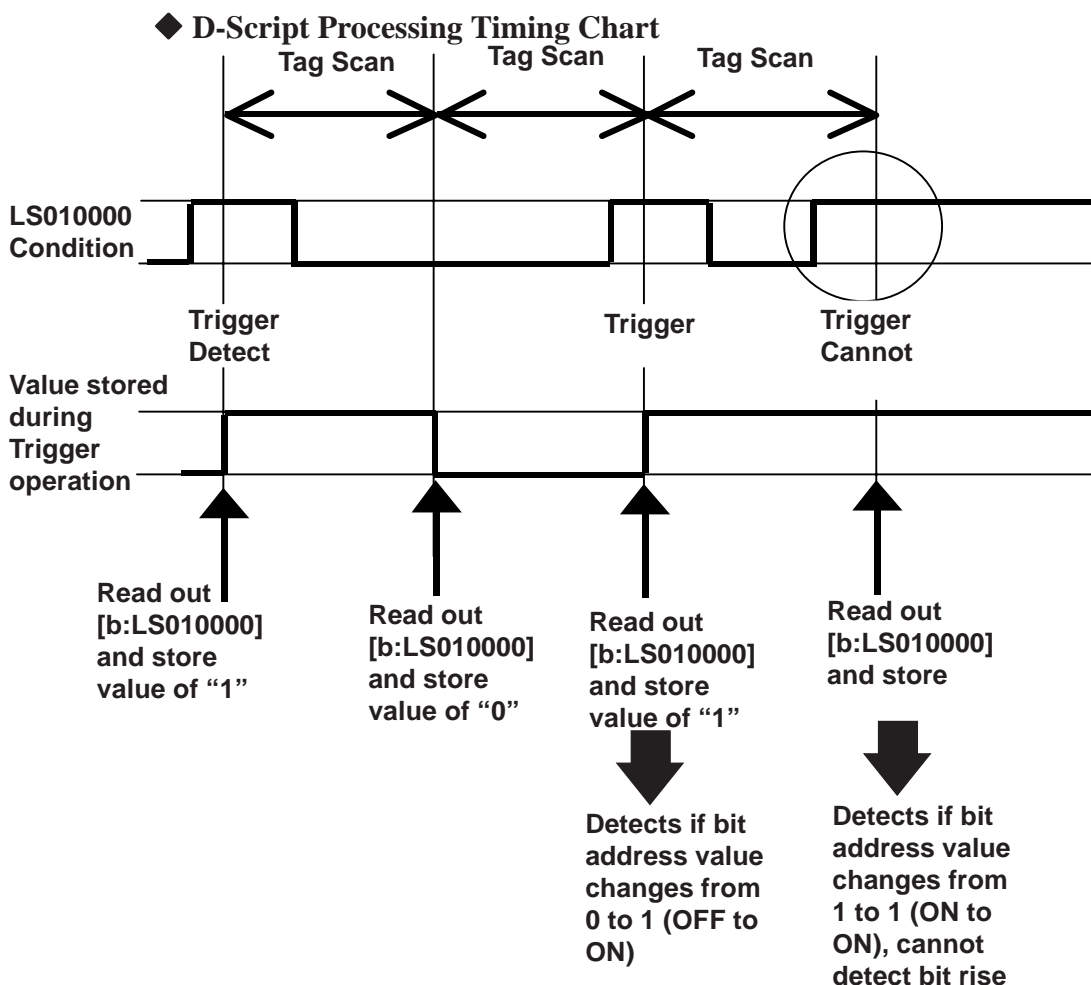

As an example, if the D-Script touch timing is not used, and only detection is performed, the processing will be as follows.

Using an if() statement to detect a trigger

The if statement is used to detect when the bit is set using a touch. Prior to performing the processing, the value is read out and compared.

```

Trigger: Bit rising ([b:LS203800])
Execute: if([b:LS010000]==1).
        {
            clear(b:LS010000)
            ::
            ::
    
```

When this type of D-Script is created, even if touch input is done repeatedly, the tag scan is performed as shown in the following timing chart. Here, each tag scan value is read out, the condition is compared and, regardless of the previous value, if it agrees with the condition, the processing is performed.

◆ D-Script Processing Timing Chart

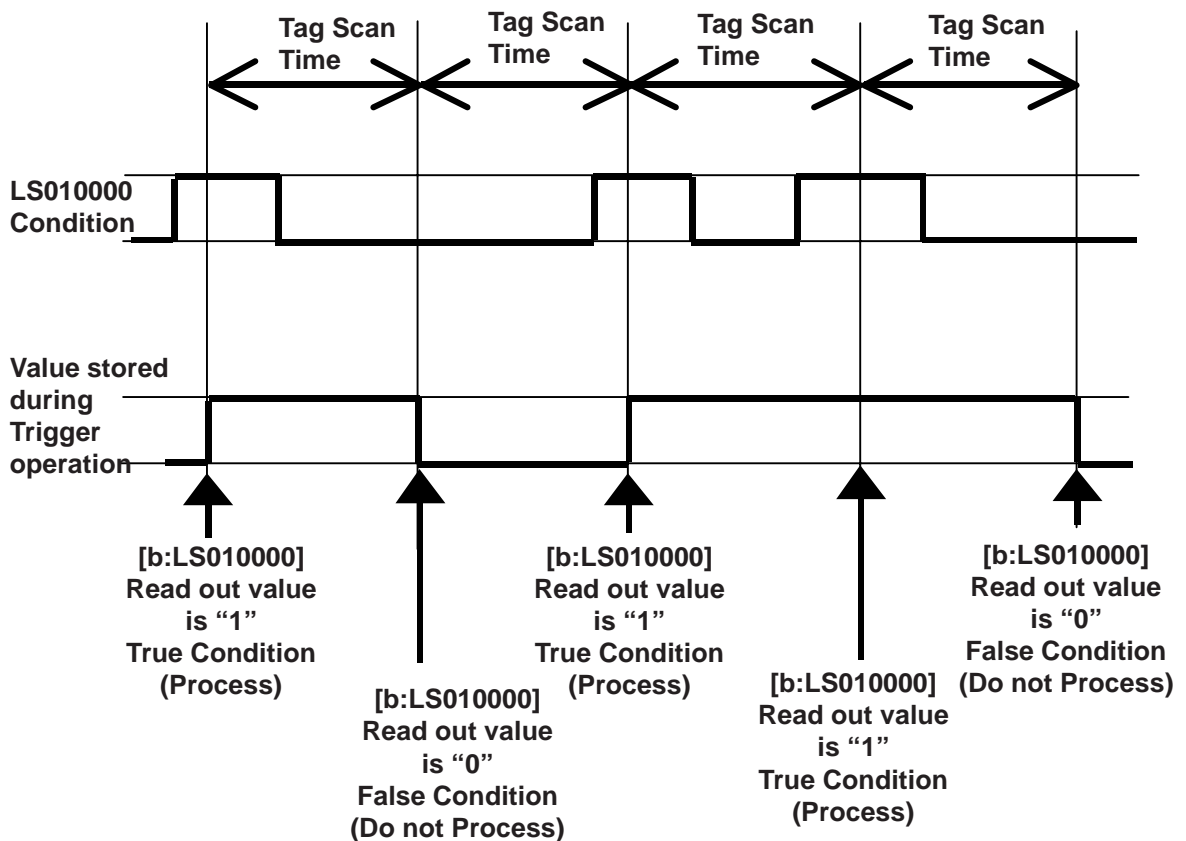

■ **D-Script Toolbox**

◆ **Statements**

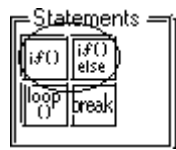

if() if-endif

When a condition enclosed with brackets “()” becomes true, the process following the “if ()” statement is executed. The Assign “=” character cannot be used in a conditional expression.

if()else if-endif

When a condition enclosed with brackets “()” becomes true, the process following the if “()” statement is executed. When the condition is false, the statement after “else” is executed. The Assign “=” cannot be used in a conditional expression.



Note: For details about the execution path:

Reference “3.1.8 Conditional Branches”

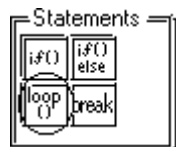

loop() loop-endlloop

Loop (repetitive) processing is repeated according to the number stored in the temporary Addresses designated in the brackets “()”. This feature is supported by only GP77R Series, GP377 Series and GP2000 Series units.



- The loop() format is as follows:

E.g. loop (number of loops)<= Designates the temporary Address where the loop repetition number is designated.

```
{
  Mode equation
  break    <=   Stated when escaping from the loop halfway (can be omitted)
} endloop  <=   Stated at the end of the loop
```

- **Only a temporary Word Address can be entered (in the parentheses).** (e.g.: loop ([t:000]))
- **“loop()” cannot be used for a trigger equation.**
- **The temporary Word Address value used to designate the “infinite loop” will decrease every time loop operation is performed. When the value changes to 0, the loop’s operation is finished. If the temporary Word Address value designated for the “infinite loop” is modified, the loop will become endless. Also, the temporary Word Address used is designated as Global. Therefore, simultaneously using this temporary Word Address for another item means the loop’s operation may be performed forever.**
- **Until loop operation finishes, screen displays of tags, etc. will not be updated/refreshed.**
- **loop() can also be nested. When it is nested, the inner-most loop() will be skipped via the “break” command.**

```
loop ([t:0000])//loop 1
```

```
{
    loop ([t:0001])//loop 2
    {
```

```
        break// Escape from loop 2
    } endloop
```

```
        break// Escape from loop 1
    } endloop
```

- **If loop operation is finished without using the escape command, the temporary Word Address value becomes 0.**
- **The range available for the temporary Word Address value will differ depending on the data format (Bin, BCD), bit length, and code +/- used. If code +/- has been designated and the temporary Word Address becomes a negative value, the condition is judged at the beginning of the loop and the loop processing stops.**

**Note:**

- **DO NOT use a PLC device in the loop formula. Instead, use an address from the GP's internal LS area's user area device, or a temporary Word Address. For example, the following description performs data write to the PLC many times in a short period (100 times in the following example). This can cause a system error since communication processing (the time required to write to the PLC) cannot be performed at this speed.**

E.g.

```
[t:0000] = 100 //Loop100 times
loop ([t:0000])
{
    [w:D0200] = [w:LS0100] //Write data to D0200
    [w:LS0100] = [w:LS0100] + 1 //Increment LS0100
} endloop
```

Change as follows:

```
[t:0000] = 100 //Loop100 times
loop ([t:0000])
{
    [w:LS200] = [w:LS0100] //Writes data to D0200
    [w:LS0100] = [w:LS0100] + 1 //Increment LS0100
} endloop
[w:D0200] = [w:LS0200] //Writes LS0200 data to D0200
```

- **Using “loop” or “break” a variable name for a D-Script variable will cause an error.**

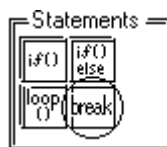
**break**

Halts loop operation while the loop() equation is being executed. This feature is supported only by GP77R Series, GP377 Series and GP2000 Series units.

**Important**

The “break” command can be used only in the { } section of loop().

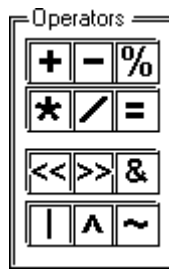
◆ **Math (Operators)****+ (Addition)**

Adds the data in two word addresses, or the data in a word address and a constant. Any overflowing digits resulting from the operation are rounded.

- (Subtraction)

Performs subtraction on the data in two word addresses, or the data in a word address and a constant. Any overflowing digits resulting from the operation are rounded.

% (Remainder)

Detects a remainder of a division performed on the data in two word addresses, or the data in a word address and a constant. The operation result may depend on the sign of the left and right sides.

*** (Multiplication)**

Multiplies the data in two word addresses, or the data in a word address and a constant. Any overflowing digits resulting from the operation are rounded.

/ (Division)

Performs division on the data in two word addresses, or the data in a word address and a constant. Decimal places and overflowing digits resulting from the operation are rounded.

= (Assign)

Assigns the right side value in the left side. The left side can state a device address only, while the right side can describe both a device address and a constant. Any overflowing digits resulting from the operation are rounded.

<< (Shift Left)

Shifts the data on the left side to the left by the number on the right side. This feature supports logical shifts only.

>> (Shift Right)

Shifts the data on the left side to the right by the number on the right side. This feature supports logical shifts only.

Example: Shift Left operation (Shifts to the left by one bit.)

Before the shift

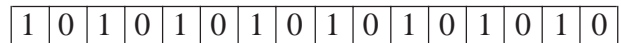

After the shift

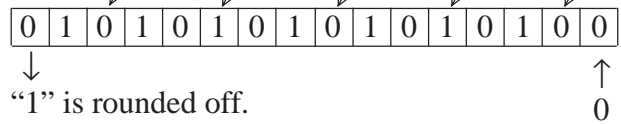

Bit-wise AND (&)

Performs logical AND of data between word devices, or between word device data and constant. Used to extract a specific bit or to mask a specific string of bits.

Bit-wise OR (|)

Performs logical OR of data between word devices, or between word device data and constant. Used to turn ON a specific bit.

Bit-wise XOR (^)

Performs exclusive OR of data between word devices, or between word device data and constant.

1's complement (~)

Inverts the bits.



Note: For details about overflowing digits, and errors and rounded decimal places resulting from a remainder operation:

Reference *“3.1.5 Notes on Operation Results”*

Priority and Associativity

The following table shows the trigger priorities. If two or more operators have the same priority, follow the direction shown by the associativity.

Priority	Operators	Associativity
High	()	→
	not, ~	←
	*, /, %	→
	+, -	→
	<<, >>	→
	<, <=, >, >=	→
	==, <>	→
	&, ^,	→
	and, or	→
Low	=	←

◆ Comparisons

Compare		
and	or	not
<	<=	<>
>	>=	==

Boolean and (AND: Conjunction)

ANDs the right and left sides. Value 0 (zero) is regarded as OFF, and other values, as ON. “N1 and N2” is true if both N1 and N2 are ON, and false if otherwise.

or (OR: Disjunction)

ORs the right and left sides. Value 0 (zero) is regarded as OFF, and other values, as ON. “N1 or N2” is true if either N1 or N2 is ON, and false if otherwise.

not (NOT: Negation)

NOTs the right side. Value 0 (zero) is regarded as 1, and other values, as 0. “not N1” is 0 if N1 is 1, and 1 if N1 is 0.

< (Smaller than)

Compares the data in two word addresses, or the data in a word address and a constant. The result is true if N1 is smaller than N2 ($N1 < N2$).

<= (Equal to or smaller than)

Compares the data in two word addresses, or the data in a word address and a constant. The result is true if N1 is equal to or smaller than N2 ($N1 \leq N2$).

<> (≠) (Not equal)

Compares the data in two word addresses, or the data in a word address and a constant. The result is true if N1 is not equal to N2 ($N1 \langle \rangle (\neq) N2$).

> (Greater than)

Compares the data in two word addresses, or the data in a word address and a constant. The result is true if N1 is greater than N2 ($N1 > N2$).

>= (Equal to or greater than)

Compares the data in two word addresses, or the data in a word address and a constant. The result is true if N1 is equal to or greater than N2 ($N1 \geq N2$).

== (Equal)

Compares the data in two word addresses, or the data in a word address and a constant. The result is true if N1 is equal to N2 ($N1 = N2$).

Command		Example
Conjunction	and	if [(Arithmetic expression) and (Arithmetic expression)]
Disjunction	or	if [(Arithmetic expression) or (Arithmetic expression)]
Negation	not	if [not (Arithmetic expression)]
Smaller than	<	<Term1><<Term2>
Equal to or smaller than	<=	<Term1><=<Term2>
Not equal	<>	<Term1><><Term2>
Greater than	>	<Term1>><Term2>
Equal to or greater than	>=	<Term1>>=<Term2>
Equal	==	<Term1>==<Term2>



Note: For details about logical operations:

Reference “3.1.6 Logical Operation Examples”

◆ **Constant/Address**

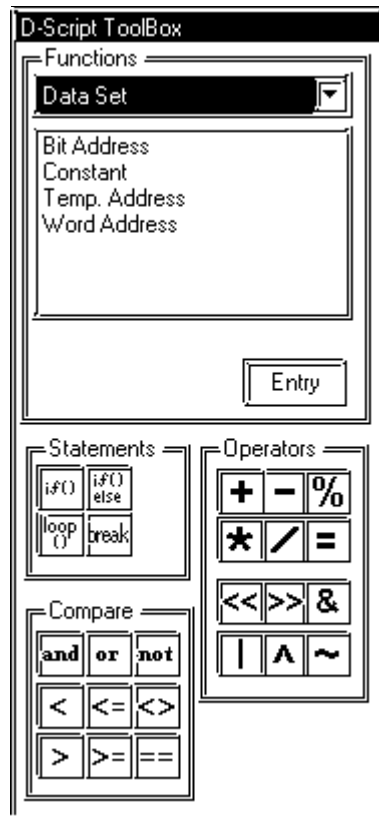

temp (temporary work address)

Here, a GP internal Address is specified that can be used with the program. With GP77R, GP377 and GP2000 series units, there are 90 words (from 0000 to 0089) available for Temporary Work Address. With all units other than GP77R and GP377 series units, there are 4 words (from 0000 to 0003) available for Temporary Work Addresses. The Temporary Work Address's initial value is not fixed.

bit (address)

Enter a bit address.

word (address)

Enter a word address.

Constant

Select a constant.



Note: To identify data via the input data's format:

E.g.

Decimal: A numeric value without leading zeros →100

Hexadecimal: A numeric value preceding by 0x →0x100

Octal: A numeric value preceding by a zero →0100

• **Calculation examples in hexadecimal and BCD formats**

Hexadecimal format only

0x270F & 0xFF00 The result is 0x2700

BCD and hexadecimal formats

9999 & 0xFF00 The result is 0x9900

◆ Draw

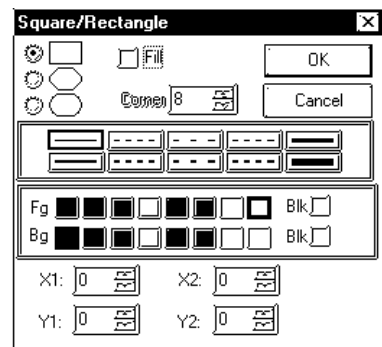
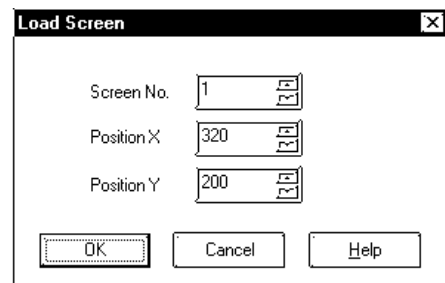
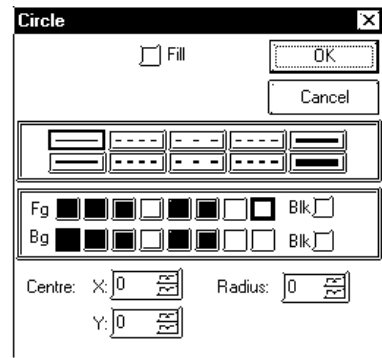
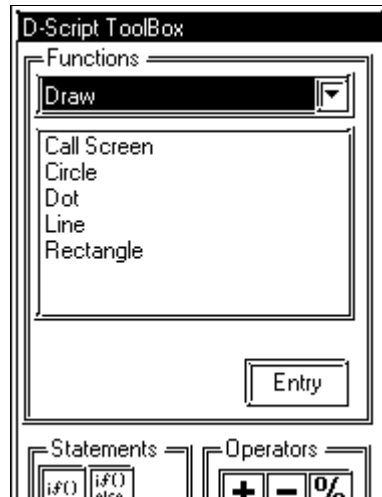

Circle

Draws a circle at the designated point. When the Pattern check box is checked, a filled circle will be drawn.

Select and enter the line type (or fill pattern when selecting a pattern), color attributes, center coordinates, and radius value.

Scrn (Load Screen) (The GP-270 does not support this function)

This function is used to call up a previously registered Library Item. The designated screen (Base screen) will be called up at the designated X,Y coordinates.

Landscape type display

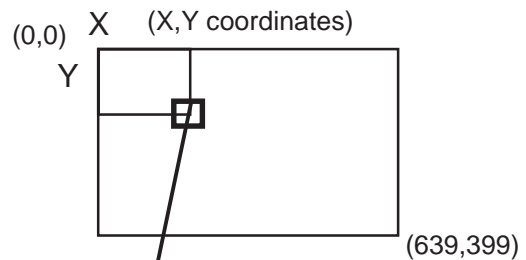

Portrait type display

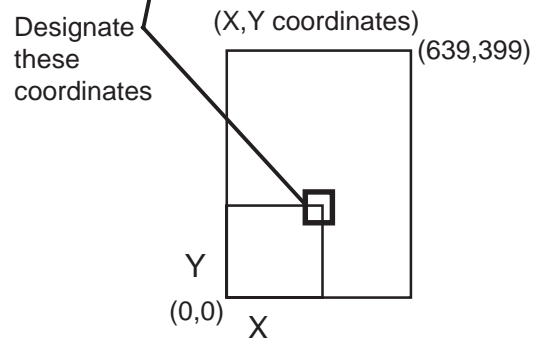

Square/Rectangle

Draws a square at the designated position. When the Pattern check box is checked, a filled square will be drawn. When selecting a beveled square, a beveling dot can be entered. Select and enter the line type (or fill pattern when selecting a pattern), color attributes, and start and end coordinates.

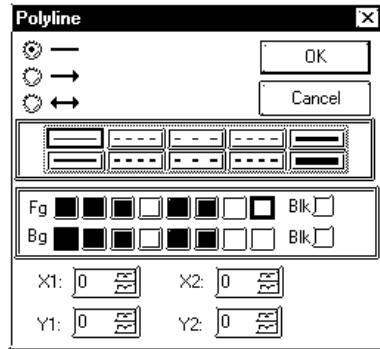

Polyline

Draws a line at the designated position. Designate the line's type, color attributes, and start and end coordinates.

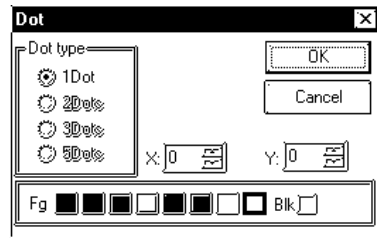

Dot

Draws a dot at the designated point. Designate a dot type, its X,Y coordinates, and its display color. 2, 3, and 5 dot groups cannot be selected.

◆ **Memory Control**
<Offset Address>

This feature is supported by only GP77R Series, GP377 Series and GP2000 Series units.

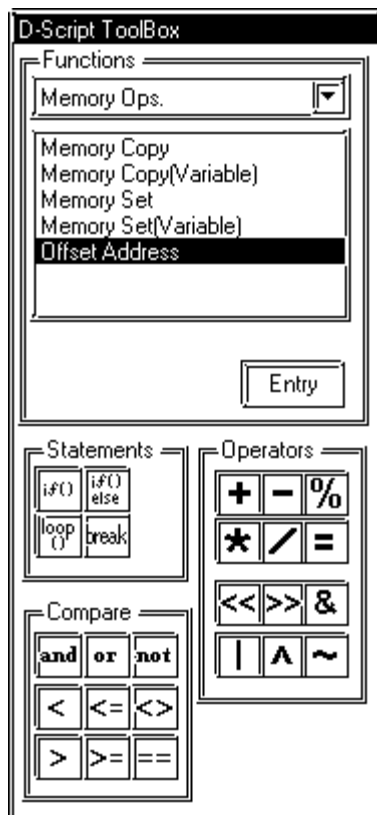

Offset Addresses

Offset Addresses can be designated. Only temporary Word Addresses can be designated for offset value storage Addresses. The offset Address format is as follows: (Word Address # Offset Value Storage Address)

Format:

[Word Address] # [Offset Value Storage Address]

<Constant Data Entry Ranges>

Data Format	Constant Entry	
	Min. Value	Max. Value
Bin16	0	65535
Bin32	0	4294967295
Bin16+/-	-32768	32767
Bin32+/-	-2147483648	2147483647
BCD16	0	9999
BCD32	0	99999999

E.g. Read [w:D0200] = [w:D0100] # [t:0000]
(Offset Word Address Read)

Write [w:D0100] # [t:0000] = 100
(Offset Word Address Write)

This Address becomes the Word Address + Temporary Word Address value. For the above example, when the value “2” is used for [t:000], the Address becomes [w:0102].



Word Addresses used in the offset address format are not counted as D-Script Addresses.

<Memory Copy>

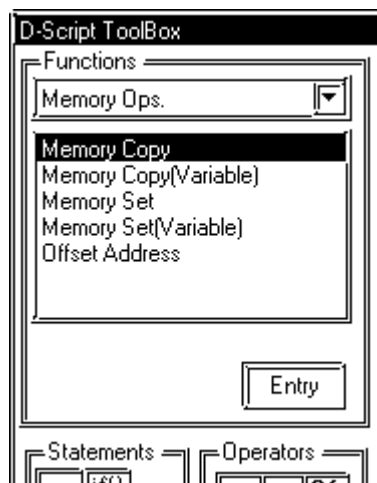

This feature is supported by only GP77R Series, GP377 Series and GP2000 Series units.

Memory Copy “memcpy”

Copies device memory all at once. Data for the number of Addresses will be copied to the copy destination Word Addresses beginning from the copy original Word Address. The number of Addresses effective is 1 to 640.

Format:

memcpy ([Copy destination Word Address], [Copy original Word Address], the number of Addresses)

Example statement:

When copying data of D0100 to D0109 to D0200 to D0209

memcpy ([w:D0200], [w:0100], 10)



< Memory Copy (memcpy) >

Original copy data will be read from the PLC only once, when required. If a communication error occurs during data read, the GP’s internal special relay LS2032’s Bit 12 will be turned ON. When data read is completed normally, Bit 12 will be turned OFF.



- Reading from the original copy data and writing the data to the destination is performed in one operation, or it is accomplished by dividing the data into several pieces equivalent to the number of Addresses used for the original copy data.

If a communication error occurs during data read, the result of the data copy varies as follows, depending on whether the data was processed in one operation or in several pieces:

(Result of data copy: ○: Properly copied, X: No data copied)

<Copy in one operation>



<Copy by dividing data>

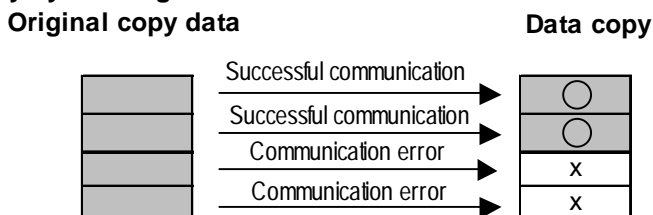

- As the number of Addresses increases, the more time is required for writing data to the PLC. Depending on the number of Addresses, it may take from 20 seconds to several minutes.
- Unless data write is completed for the designated number of Addresses, screen displays such as tags will not be updated or refreshed. Also, screen changes, Q-tag alarm processing and other processing will not be performed.
- If data to be written exceeds the designated device range, a communication error occurs. In this case, you must turn the GP's power OFF and then ON again to reset the GP from the error.
- When the data are written to the LS Area with the Memory Copy (memcpy) function, the data can be written only in the User area. Data cannot be written into the System Data area (LS0000 to LS0019), Special area (LS2032 to S2047), or Reserved area (LS2048 to LS2095). However, data can be read out from these areas.
- When the 32 bit device data is copied to a 16 bit device using D-Script, and the bit length is designated as 16 bits, only the data for lower 16 bits will be copied.

E.g.: memcpy ([w:w30.0100], [w:BD00100], 3)

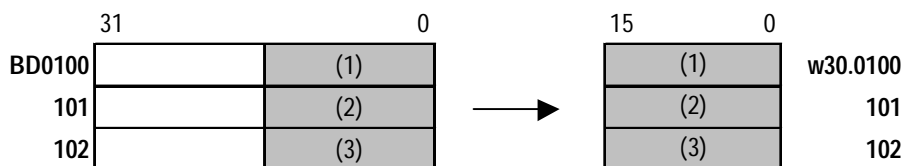

Also, when 16 bit device data is copied to a 32 bit device, the data for the lower 16 bits will be copied and “0” will be designated for the upper 16 bits.



- When 32 bit device data is copied to a 16 bit device, or when 16 bit device data is copied to a 32 bit device, if the D-Script bit length designated in D-Script is 32, the copying will be as follows. When one of the devices is a 32 bit device and the other is a 16 bit device, use the 16 bit device’s no. of addresses to designate the memcopy () function’s no. of address.

E.g.: memcopy (W30.0100, BD0100,4)

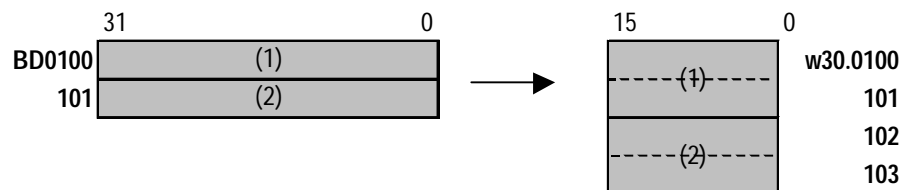

E.g.: memcopy (BD0100, W30.0100, 4)

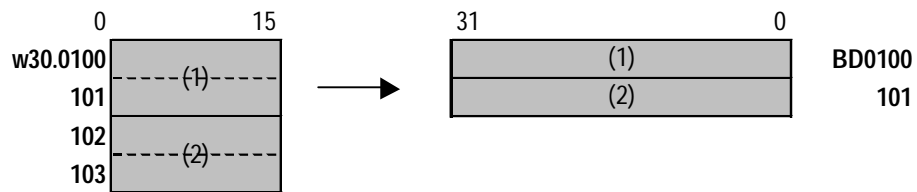

- If the original and destination data ranges overlap, all overlapping data will be rewritten as follows:

E.g.: When copying “D101 to D104” to “D100 to D103”
(Data is copied to a smaller number Address)

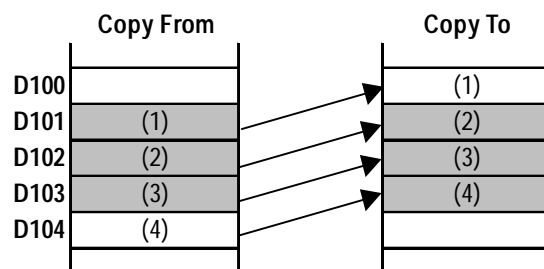

E.g.: When copying “D100 to D103” to “D101 to D104”
(Data is copied to a larger number Address)

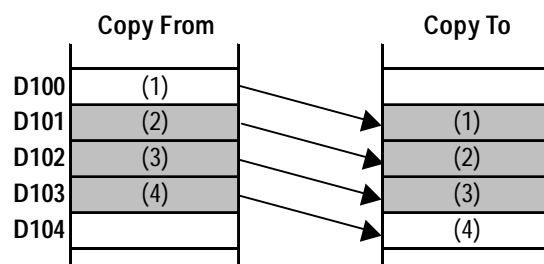

- **Although this example's function designates 2 Addresses, these Addresses will not be counted as D-Script Addresses.**
- **When using device addresses for the Assign operation, the write values will not be assigned immediately, due to the GP to PLC transmission time.**

E.g.: memcpy ([w:D200], [w:D100], 10) //Copies "D100 to D109"
 to "D200 to D209"
 [w:D300] = [D200] //Assigns D200 data to D300.

In this case, D100's value to be written to D200 as the operation result has not yet been assigned to D300.

<Memory Copy>

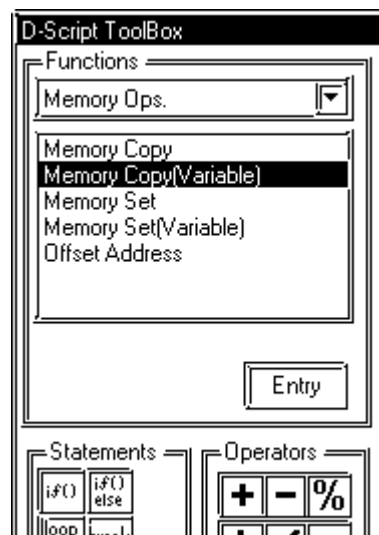

This function is available only with GP2000 Series units (except for the GP2301 and GP2501).

Extended Memory Copy (_memcpy_EX)

Copies the memory in the device in one operation.

The data of addresses specified with Parameter 3 are copied from the source (copy from) word address specified with Parameter 2 to the destination (copy to) word address specified with Parameter 1.

The valid range of the number of addresses is between 1 and 640.

With the "_memcpy_EX" function, the source address, destination address, and number of addresses can be designated indirectly.

Format:

_memcpy_EX ([destination word address], [source word address], number of addresses)

Parameter 1: Device address + Temporary address

Parameter 2: Device address + Temporary address

Parameter 3: Numerical value, LS Area, Temporary address (The valid range for Parameter 3 is between 1 and 640.)

Example statement:

```
[t: 0000] =10
[t: 0001] =20
_memcpy_EX([w:LS0100]#[t:0000],
[w:D0100]#[t: 0001], 5)
```

In the example above, five words of data will be read out from D0120 and written into LS0110 to LS0114.



When the range of the source address and destination address overlaps, the overlapping data will be rewritten as follows.

E.g.: When copying “LS101 to LS104” to “LS100 to LS103”
(Data is copied to a smaller number Address)

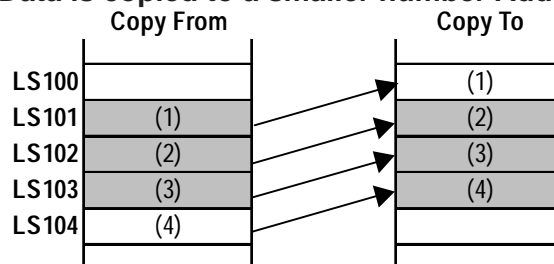

E.g.: When copying “LS100 to LS103” to “LS101 to LS104”
(Data is copied to a larger number Address)

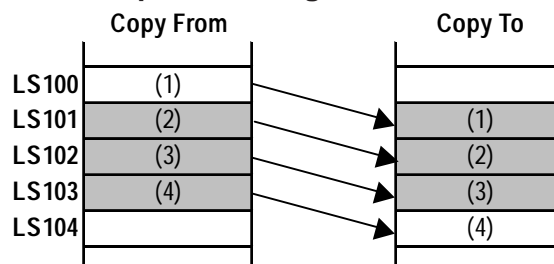

<Memory Set>

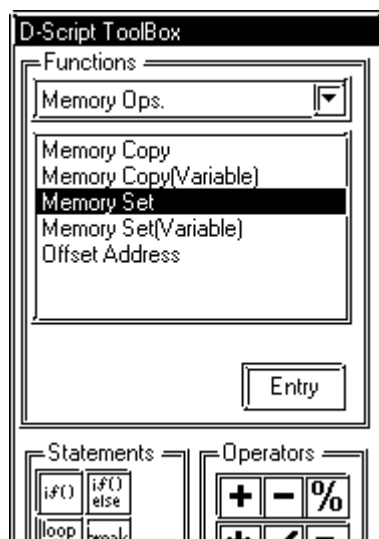

This feature is supported by only GP77R Series, GP377 Series and GP2000 Series units.

Memory Set (memset)

This feature initializes all devices at once. Setting data for the number of Addresses is taken from the Set Word Address. The allowable range of Addresses is from 1 to 640.

Format:

memset ([Set Word Address], set data, number of Addresses)

Example statement:

When “0” is set to addresses D0100 to D0109 - memset ([w:D0100], 0, 10)



< Memory Set (memset) >

- **As the number of Addresses increases, the more the time is required for writing data to the PLC. Depending on the number of Addresses, it may take from 20 seconds to several minutes.**
- **If data to be written exceeds the designated device range, a communication error occurs. In this case, you must turn the GP's power OFF and then ON again to reset the GP from the error.**
- **Although it will depend on the number of Addresses to be copied, data will be read from the original copy data, then divided into pieces and copied to the copy destination. Therefore, even if a communication error occurs during data read, data may be partially written.**
- **Unless data write is completed for the designated number of Addresses, screen displays such as tags will not be updated or refreshed. Also, screen changes, Q-tag alarm processing and other processing will not be performed. Although this function designates Address(es), they are not counted as D-Script Address(es).**
- **When writing data to the LS Area with the Memory Reset (memset) function, the data can be written only into the User area. Data cannot be written into the System Data area (LS0000 to LS0019), Special area (LS2032 to S2047), or Reserved area (LS2048 to LS2095).**
- **When using device addresses for the Assign operation, the write values will not be assigned immediately, due to the GP to PLC transmission time.**

E.g.: memset ([w:D0100], 0, 10) //Initializes "D100 to D109" as 0
 [w:D200] = [w:D100] //Assigns D100 data to D200.

In this case, value 0 written to D100 as the operation result has not been assigned to D200 yet

<Memory Set (Variable)>

This function is available only with GP2000 Series units (except for the GP2301 and GP2501).

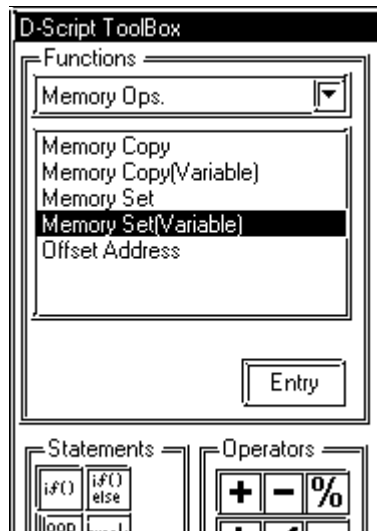
**Memory Set (_memset_EX)**

Initializes the device in one operation. The Set data specified with Parameter 2 are set from the Set Word Address specified with Parameter 1 into the addresses specified with Parameter 3. The valid range for the number of addresses is between 1 and 640. The Set Word Address, Set data, and number of addresses can each be designated indirectly.

Format:

`_memset_EX` ([Set Word address], Set Data, number of addresses)

Parameter 1: Device address + Temporary address

Parameter 2: Device address + Temporary address

Parameter 3: Numerical value, LS Area, Temporary address (The valid range for Parameter 3 is between 1 and 640.)

Example statement:

```
[t: 0000] =10,
```

```
[w: LS0050] =0
```

```
[w:LS0051]=5
```

```
_memset_EX([w:LS0100]#[t:0000],  
[w:LS0050] [w:LS0051])
```

In the example above, "0" will be written into the five words from LS0100 to LS0114.

◆ SIO Port Control

The extended SIO (extended serial interface) can be used for D-Script. Consequently, D-Script can be used for simplified communication (RS-232C). However, for more complex communication programs, using the Extend SIO's Extend SIO Protocol is recommended.

▼ **Reference** ▲ *3.1.11 D-Script Extended SIO Functions.*

• Control

Bit Specification	[c:EXT_SIO_CTRL**]	(write-only)
Word Specification	[c:EXT_SIO_CTRL]	(write-only)

• Status

Bit Specification	[s:EXT_SIO_STAT**]	(read-only)
Word Specification	[s:EXT_SIO_STAT]	(read-only)

• Receive Data Count [r:EXT_SIO_RCV] (read-only)

• Receive Function IO_READ([p:EXT_SIO], LS storage address, Number of bytes sent)

• Send Function IO_WRITE([p:EXT_SIO], LS storage address, Number of bytes sent)

When using Extended SIO via D-Script or Global D-Script, be sure to download the general SIO protocol.

<Label Setting>

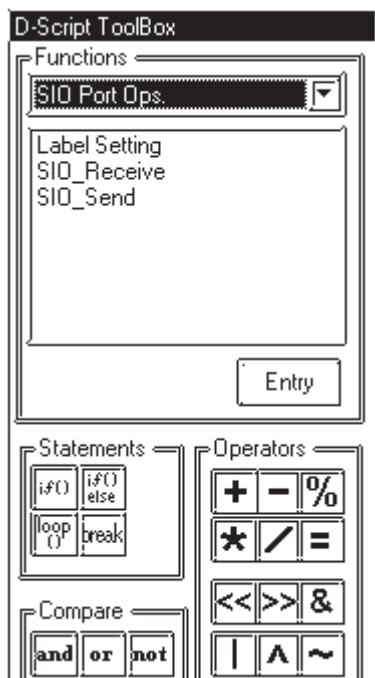

This function is available only with GP2000 Series units (except for the GP-2301, GP-2401, GP-2501, GP-2601, GP-2301H and GP-2401H).

Label Setting

• **Control**

This control variable is used to clear the Send buffer, Receive buffer, and error status. This control variable is write-only.

Format:

When designating the bit:

[c:EXT_SIO_CTRL**]

** : 00 to 15

When designating the word:

[c:EXT_SIO_CTRL]

Example statement:

When designating the bit:

[c:EXT_SIO_CTRL00] = 1

When designating the word:

[c:EXT_SIO_CTRL] = 0x0007

• Contents of EXT_SIO_CTRL

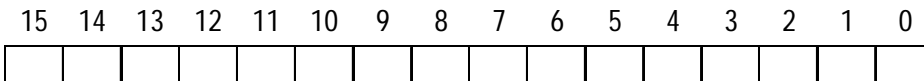

Bit	Content
15	Reserved
14	
13	
12	
11	
10	
9	
8	
7	
6	
5	
4	
3	
2	1: Clear error
1	1: Clear Send buffer
0	1: Clear Receive buffer



Note: When a word is designated (when two or more bits are set simultaneously), the processing will be executed in the following order:

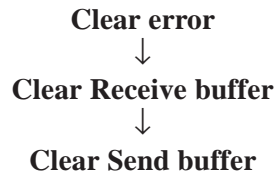

◆ **Status**

Status includes the following information.
This status is a write-only variable.

Format:

When designating the bit: [s:EXT_SIO_STAT**] **: 00 to 15

When designating the word: [s:EXT_SIO_STAT]

Example statements:

When designating the bit: if ([s:EXT_SIO_STAT00] == 1)

When designating the word: if (([s:EXT_SIO_STAT] & 0x0001) <>0)

- Contents of EXT_SIO_STAT

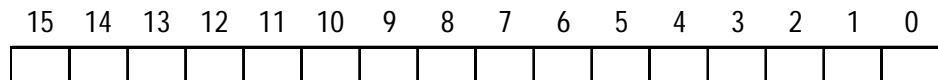

Bit	Content
15	0: No protocol for general SIO 1: Protocol for general SIO exists
14	Reserved
13	
12	
11	
10	
9	
8	
7	Reserved
6	
5	
4	0: Normal 1: Receive Timeout
3	0: Normal 1: Receive error
2	0: No receive data 1: Receive data exists
1	0: Normal 1: Transmission error
0	0: Data exists in Send buffer 1: Send buffer is empty



Note: • The reserved bits may be assigned in the future. Therefore, be sure to check only the necessary bits.

- Two types of transmission errors exist: the transmission timeout error and the transmission buffer-full error. When either of the two errors occurs, the transmission error bit turns ON. The transmission timeout period is five seconds.
- There are four types of receive errors: parity error, overrun error, framing error, and overflow. When one of these four errors occurs, the bit for the receive error turns ON.
- **Received Data Size (number of bytes)**

Shows the quantity of data (number of bytes) that has been received at that time.

The received data size is a read-only feature.

Format:

[r:EXT_SIO_RECV]

Example statement:

if ([r:EXT_SIO_RECV]>=10)

Label name of the Received Data Size (number of bytes)



Important

With GP-PRO/PB III V. 6.0 and earlier versions, the Label name designated for the received data size is [r: EXT_SIO_RCV]. However, you are not required to revise the description because the function will be the same whether [r: EXT_SIO_RCV] or [r: EXT_SIO_RECV] expression is selected.

<SIO Receive>

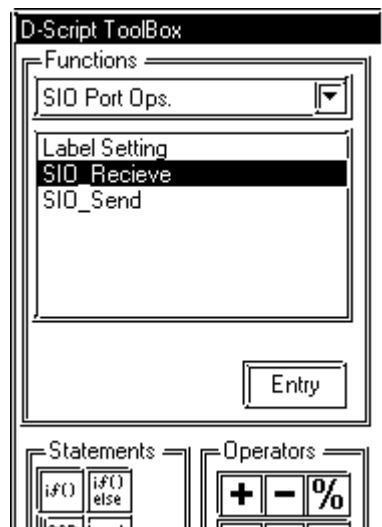

Write the statement as follows when reading out the received data from the Extended SIO.

Format:

IO_READ ([p:EXT_SIO], LS storage address, Number of bytes)

Parameter 1: EXT_SIO

Parameter 2: LS Area

Parameter 3: Number of bytes

Example statement of the function:

IO_READ([p:EXT_SIO], [w:LS0100], 10)

In the above example, the number of bytes received is stored in LS0100. 10 bytes of data is stored starting from LS0101.

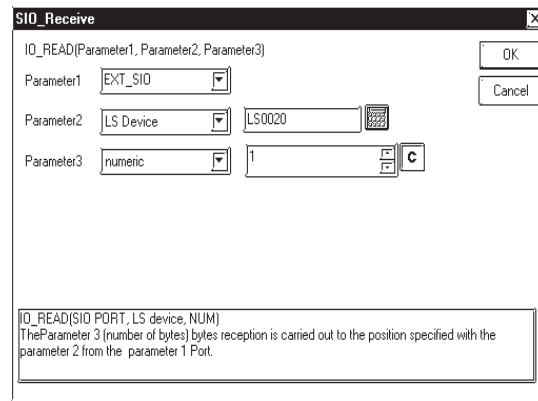

Note:

The maximum number of transfer bytes during data reception is 2011.
The data are written to each word address in units of 1 byte.

LS0100	Received Data Size		...	10 bytes
LS0101	00	Byte 1		
LS0102	00	Byte 2		
LS0103	00	Byte 3		
LS0104	00	Byte 4		
LS0105	00	Byte 5		
LS0106	00	Byte 6		
LS0107	00	Byte 7		
LS0108	00	Byte 8		
LS0109	00	Byte 9		
LS0110	00	Byte 10		

Received Data Storage Method

<SIO Send>

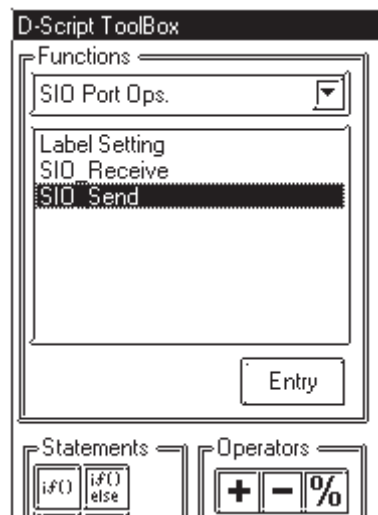

Write the statement as follows when writing data to the Extended SIO.

Format:

IO_WRITE ([p:EXT_SIO], LS storage address, Number of bytes)

Parameter 1: EXT_SIO

Parameter 2: LS Area

Parameter 3: Number of bytes

Example statement of the function:

IO_WRITE([p:EXT_SIO], [w:LS0100], 10)

In the above example, 10 bytes of data starting from LS0100 are sent.

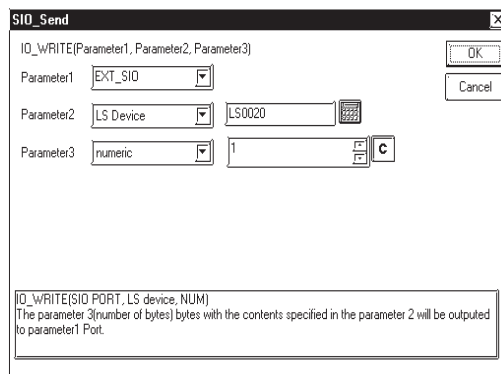

- **The maximum number of transfer bytes when receiving data is 2012.**
- **As the LS device for the Send buffer, write the data in single bytes to each word address.**

LS0100	00	Byte 1
LS0101	00	Byte 2
LS0102	00	Byte 3
LS0103	00	Byte 4
LS0104	00	Byte 5
LS0105	00	Byte 6
LS0106	00	Byte 7
LS0107	00	Byte 8
LS0108	00	Byte 9
LS0109	00	Byte 10

Sent Data Storage Method



- Addresses designated in the Send/Receive functions will not be added to the count of D-Script addresses.
- The Control is a write-only variable, while Status and Received Data are read-only variables. Do not try reading out the Control variable or writing data into the Status variable, as doing so will cause the operation to fail.
- Create independent D-Scripts (or functions) for Send and Receive operations. For details, see pages 3-48 to 3-54 for the flow charts of data transfers.
- When no general SIO protocol exists, the processing of D-Scripts is suspended when the readout of the Send function, Receive function, Control variable, Status variable, and Received Data Size is executed. However, when [EXT_SIO_STAT15] (Readout of status for checking the presence/absence of the Extended SIO protocol) is executed, processing of D-Scripts is not suspended.
- The valid range of the LS device that can store data for Send/Receive functions is the User area (LS20 to LS2031 and LS2096 to LS8191). Therefore, up to 6096 bytes of data can be transmitted, and up to 6095 bytes of data can be received.
- When no general SIO protocol exists, the 13th bit of LS2032 turns ON when the readout of the Send function, Receive function, Control, Status variable, and Received Data Size is executed.
- When using the Send/Receive functions, set the bit length of the D-Script to 16 bits. Note that the operation will fail if the bit length is set to 32 bits.



- The size of the Send buffer is 2048 bytes, while the Receive buffer is 8192 bytes. The CTS line is turned OFF after at least 80% of the Receive buffer is full of received data.

◆ Bit Control

<Clear Bit>

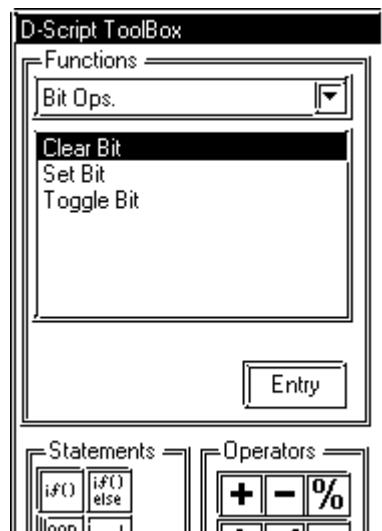

Clear Bit: clear ()

Changes the specified bit address from 1 to 0.

Example statement:

clear ([b: LS010000])

In the above example, the 00th bit of LS0100 is changed from 1 to 0.

<Toggle Bit>

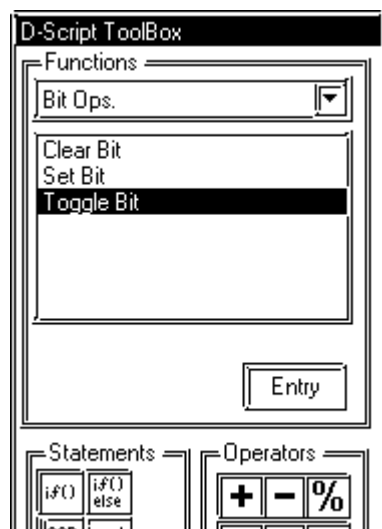

Bit toggle (invert): toggle ()

Changes the specified bit address from 1 to 0 or from 0 to 1.

Example statement:

toggle ([b: LS010000])

In the above example, the 00th bit of LS0100 is changed from 1 to 0 or from 0 to 1.

<Set Bit>

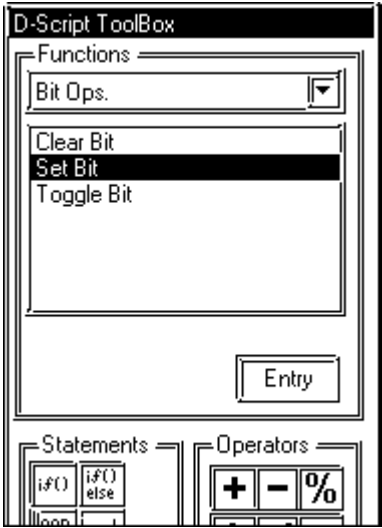

Bit set: set ()
Changes the specified bit address from 0 to 1.

Example statement:
set ([b: LS010000])

In the above example, the 00th bit of LS0100 is changed from 0 to 1.

◆ CF File Ops.

CF Card File Data Read/Write is supported. Furthermore, CF file deletion, listing of files within a folder, Creation of multiple levels of folders and Indirect specification of destination address are supported. **This function is supported only by GP2000 Series units.**

<File Write>

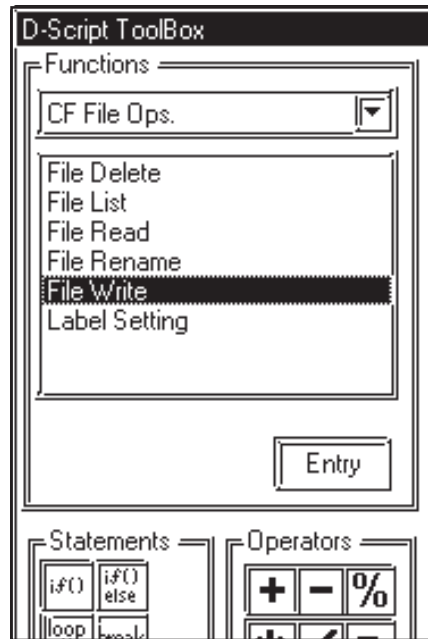

File Write

Writes the specified number of bytes of data from the source address to the specified file. Any one of three modes can be selected: "New", "Add", and "Overwrite".

Parameter 1

Folder name : Fixed string
(Maximum length: 32 single-byte characters)

Parameter 2

File name : Fixed string, LS Area
(Maximum length: 32 single-byte characters)

Parameter 3

Source Address : LS Area

Parameter 4

Offset : Numerical value, PLC device, LS Area, Temporary address
(Maximum number that can be specified: 65535 for 16-bit length, 4294967295 for 32-bit length)

Parameter 5

Number of bytes : Numerical value, PLC device, LS Area, Temporary address
(Maximum number that can be specified: 1280)

Parameter 6

Mode: Numerical value, PLC device, LS Area, Temporary address
(Available values: 0, 1, 2)

Format:

`_CF_write(Folder name, File name, Source address, Offset, Number of bytes, Mode)`

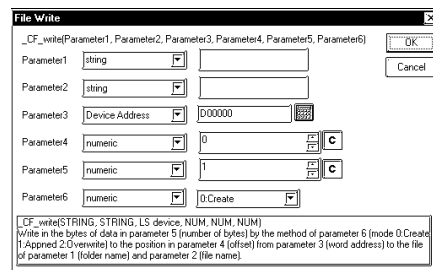

Mode	Name	Description
0	New	Creates a new file. If a file with the same name exists, it is deleted.
1	Add	Adds the data to a specified file. If the specified file does not exist, a new file is created.
2	Overwrite	Overwrites part of the file. If the specified offset is larger than the file size, the surplus area is filled with 0s and the data is written after the area. If the offset is specified at the end of the file data, the operation is equivalent to adding the data to the file.

Example function statement

```
[w:LS0200] = 0 // Offset ("0" when the mode is "New")
[w:LS0202] = 100 // Number of bytes (100 bytes)
[w:LS0204] = 0 // Mode ("New")
_CF_write("\DATA", "DATA0001.BIN", [w:LS0100], [w:0200],
[w:LS0202], [w:LS0204])
```

The above example creates a new file, DATA0001.BIN, in the \DATA folder and stores 100 bytes of data read from LS0100. When the LS Area is specified for the offset, the number of bytes or the mode, they can be designated indirectly.



- **The offset setting is effective only in "Overwrite" mode. The offset setting is disabled in "New" and "Add" modes. Set the offset value to "0" in modes other than "Overwrite" mode.**
- **When "New" mode is specified and a file with the same name already exists, it is overwritten.**
- **When the LS Area is specified for "File name", "Source Address" is not counted as a D-Script address.**
- **When a PLC device is specified for "Source Address", data is read from the PLC only once when the function is executed. If an error occurs during data read, the error is set in the CF Card Error Status [s:CF_ERR_STAT]. The error is cleared when the data read is successfully completed.**
- **The data is divided into pieces and read from the source, although this depends on the number of bytes to be read. Therefore, even if a communication error occurs during data read, the data may have been partially written to the specified file.**
- **To specify a full path for a file name, specify "*" (asterisk) as the folder name.
Example: `_CF_read("*", "\DATA\DATA0001.BIN", [w:LS0100], 0, 10)`**

Example statement

- When "New" mode is specified

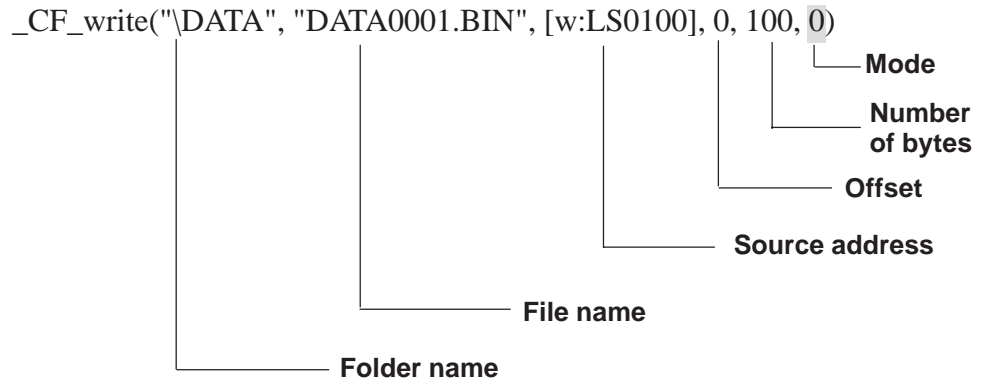

When the above example is executed, 100 bytes of data are read from LS0100 and following areas and written into the DATA0001.BIN file, which is a new file created in the \DATA folder.

- When "Add" mode is specified

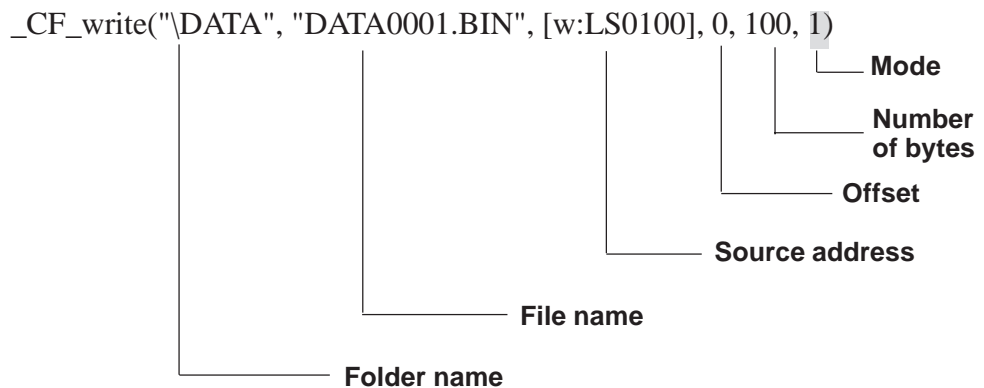

If the specified file (DATA0001.BIN in the example) already exists and the statement above is executed, 100 bytes of data are read from LS0100 and following areas and added to the DATA0001.BIN file in the \DATA folder.

- When "Overwrite" mode is specified (1)

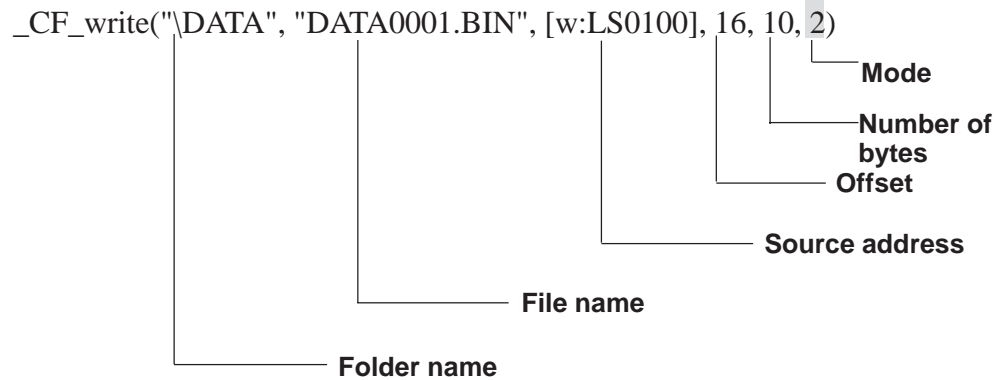

If the specified file (DATA0001.BIN in the example) already exists and the above statement is executed, 10 bytes of data stored in LS0100 and following areas are read and overwrite 10 bytes of data stored in the 17th and following bytes after the offset in the DATA0001.BIN file in the \DATA folder.

- When "Overwrite" mode is specified (2)

(the file to be overwritten is less than the sum of the offset value and number of bytes)

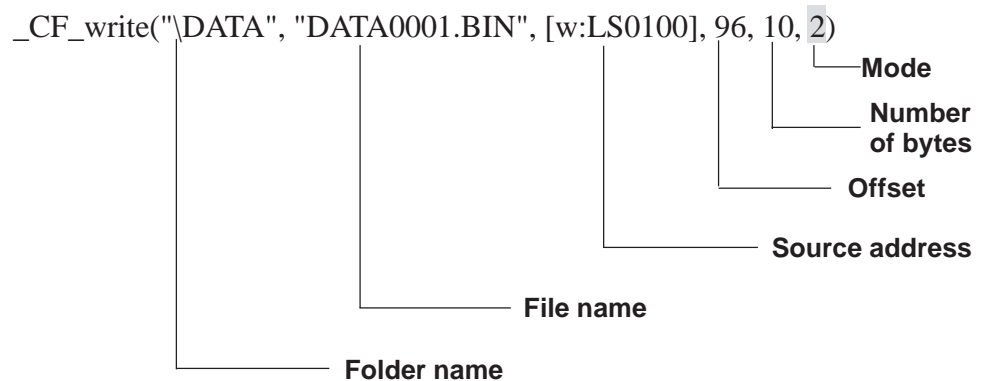

The specified file (DATA0001.BIN in the example) already exists and the file size is 100 bytes. When the offset is set to 96 bytes and the number of bytes is set to 10 bytes for the overwrite operation, 10 bytes of data stored in LS0100 and following areas are read. Then, the first 4 bytes of readout data overwrite the 4 bytes of data stored in the 97th and following bytes in the file, and the remaining 6 bytes of data are added to the end of the file data.

The resulting file contains 106 bytes of data.

- When "Overwrite" mode is specified (3)
(The file to be overwritten is smaller than the offset value)

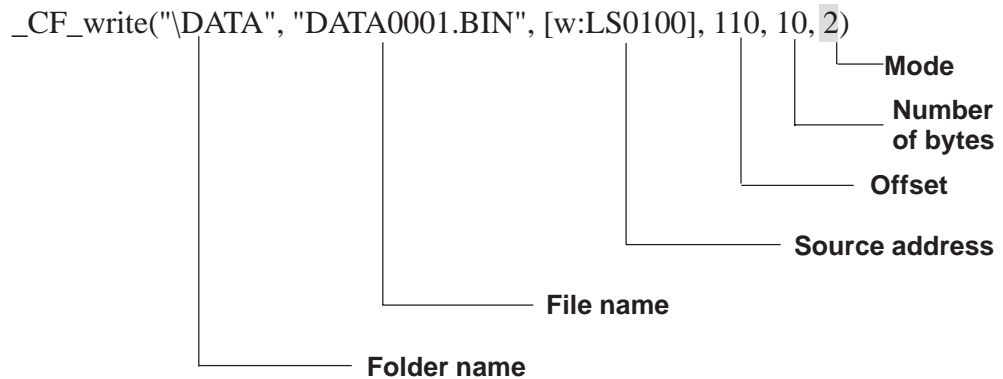

The specified file (DATA0001.BIN in the example) already exists and the file size is 100 bytes. When the offset is set to 110 bytes and the number of bytes is set to 10 bytes for the overwrite operation, the area between the 101st byte and 110th bytes is filled with 0s and the 10 bytes of data read from LS0100 and following areas are written in the 111th and following bytes.

Consequently, the resulting file contains 120 bytes of data.



- **The maximum allowable number of characters for the first parameter "Folder name" and the second parameter "File name" is 32 single-byte characters.**
- **The LS Area can be specified for the second parameter "File name". Specifying the LS Area allows the indirect addressing of a file name. Up to 32 single-byte characters can be used to specify a file name.**

Example: `_CF_write("\DATA", [w:LS0100], [w:LS0200], 0, 100, 0)`

Storing a file name in LS0100 allows indirect addressing of a file name.

In this example, a file name is stored in LS0100 through LS0106 as follows.

16 bit	
LS0100	'D' 'A'
LS0101	'T' 'A'
LS0102	'0' '0'
LS0103	'0' '1'
LS0104	'.' 'B'
LS0105	'I' 'N'
LS0106	'\0' '\0'
	⋮

The end of the file name must be a NULL character. The display device recognizes the data before the NULL character as the file name.

In the example above, 100 bytes of data are read from LS0200 and following areas and a new file, "\DATA\DATA0001.BIN", is created for storing the data.



- *As for the file name, only the "8.3 format" (a maximum of 12 characters, with 8 characters for the file name and 3 characters for the extension) may be used. Long file names cannot be used.*

<File Read>

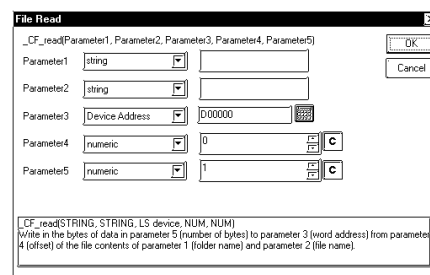
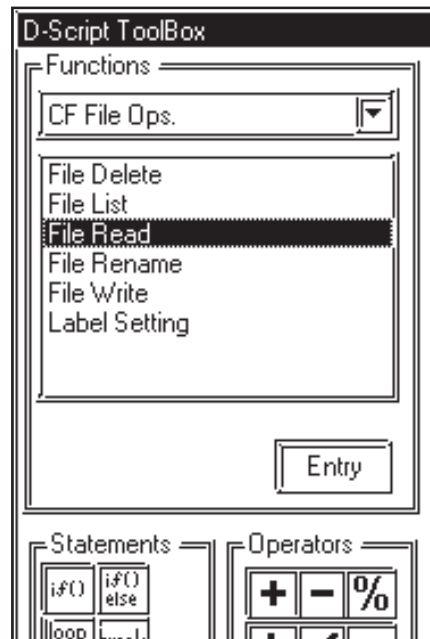
**File Read**

Reads the specified number of bytes of data in the file after the specified offset and writes it in the destination address.

Format

`_CF_read(Folder Name, File Name, Destination Address, Offset, Number of bytes)`

Parameters**Parameter 1**

Folder name: Fixed string (Maximum length: 32 single-byte characters)

Parameter 2

File name: Fixed string, LS Area (Maximum Length: 32 single-byte characters)

Parameter 3

Destination Address: LS Area

Parameter 4

Offset: Numerical value, PLC device, LS Area, Temporary address (Maximum number to be specified: 65535 for 16-bit lengths, 4294967295 for 32-bit length)

Parameter 5

Number of bytes: Numerical value, PLC device, LS Area, Temporary address (Maximum number to be specified: 1280)

Format

`_CF_read(Folder name, File name, Destination address, Offset, Number of bytes)`

Example statement

To read 16 bytes of data in the specified file when the offset is 16:

```
_CF_read("\DATA", "DATA0001.BIN", [w:LS0100], 16, 16)
```

In the example above, the 16 bytes of data from the 17th and later bytes in the "\DATA\DATA0001.BIN" file are written to LS0100 and later areas.



- **As for the file name, only the "8.3 format" (a maximum of 12 characters, with 8 characters for the file name and 3 characters for the extension) may be used. Long file names cannot be used.**



- **The maximum allowable number of characters for the first parameter "Folder name" and the second parameter "File name" is 32 single-byte characters.**
- **The LS Area can be specified for the second parameter "File name". Specifying the LS Area allows the indirect addressing of a file name. Up to 32 single-byte characters can be used to specify a file name.**

Example:

To read 10 bytes of data stored in a file when the file is specified in LS0100 and later and the offset is 0:

```
_CF_read("\DATA", [w:LS0100], [w:LS0200], 0, 10)
```

Storing a file name in LS0100 enables the indirect addressing of a file name.

In this example, a file name is stored in LS0100 through LS0106 as follows:

	16bit	
LS0100	'D'	'A'
LS0101	'T'	'A'
LS0102	'0'	'0'
LS0103	'0'	'1'
LS0104	'.'	'B'
LS0105	'I'	'N'
LS0106	'\0'	'\0'
	:	

The end of the file name must be a NULL character. The display device recognizes the data before the NULL character as a file name.

In the example above, 10 bytes of data at the beginning of the "\DATA\DATA0001.BIN" file are read and written into LS0200 and later areas.



- **The number of bytes that are successfully read is written in CF Card Readout Bytes [s:CF_READ_NUM].**

Reference For details of CF Card Readout Bytes, refer to "CF card status."

- **Screen displays such as tags are not updated or refreshed until data write has been completed for the designated number of bytes. Also, screen changes, Q-tag alarm processing and other processes will not be performed.**
- **When the LS Area is specified for "File name", "Destination Address" is not counted as a D-Script Address.**
- **When a PLC device is specified for the Destination Address, more time is required for writing data to the PLC as the number of words (bytes) increases. Several seconds may be required, depending on the number of words.**
- **If the data read out from the file exceeds the designated device range of the PLC, a communication error occurs. In this case, you must turn the power to the PLC OFF and ON once to reset the PLC from the error.**
- **When a PLC device is specified as a destination, the values are not written immediately due to the GP to PLC transmission time.**

Example:

In the script below, statement (1) reads 10 bytes of data from the file and writes the data into [w:D0100]. The data, however, has not yet been written into [w:D0100] at the execution of statement (2) due to the transmission time.

```
_CF_read("\DATA", "DATA0001.BIN", [w:D0100], 0, 10) .....(1)
```

```
[w:D0200] = [w:D0100] + 1 .....(2)
```

In such a case, store the data once in the LS Area and then execute the second statement, as follows.

```
_CF_read("\DATA", "DATA0001.BIN", [w:D0100], 0, 10)
```

```
memcpy([w:LS0100], [w:D0100], 10)
```

```
[w:D0200] = [w:LS0100] + 1
```

<File List>

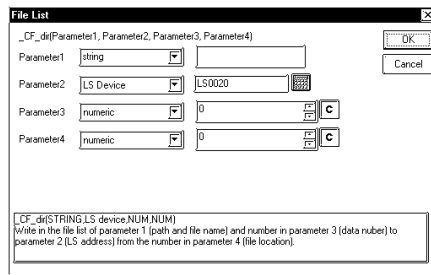
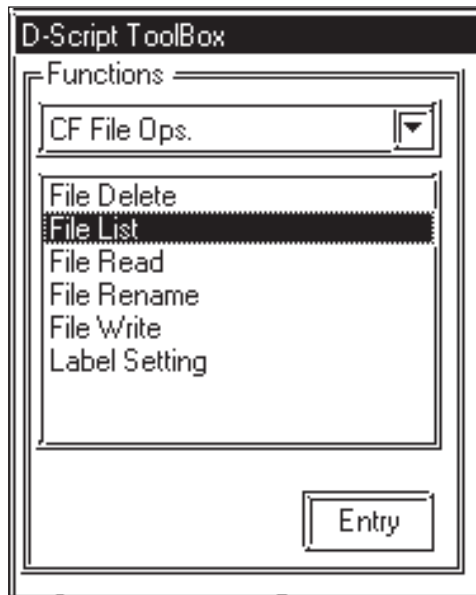

File List

The list of files that exist in the specified folder is written in the LS Area.

Parameter 1 designates the CF Card data folder. Parameter 4 designates the offset used to select a file/files within that folder. Parameter 3 designates the number of files selected within that folder. Parameter 4 specifies the LS Area into which the files will be written.

When the offset is specified as "0", the list starts from the first (starting) file.

Parameters

Parameter 1 Folder name: Fixed string (Maximum length: 32 single-byte characters)

Parameter 2 Destination LS Address: LS Area

Parameter 3 Number of file names: Numerical value, PLC device, LS Area, Temporary address (Maximum number to be specified: 32)

Parameter 4 Offset: Numerical value, PLC device, LS Area, Temporary address

Format

_CF_dir(Folder name, destination LS Address, number of file names, offset)

Example statement

To output a file list containing two files when the offset is 1 (second file):
 _CF_dir("\DATA*.*", [w:LS0100], 2, 1)

When the statement above is executed while the following files exist in the DATA folder, file names "DATA0001.BIN" and "DATA02.BIN" are written to LS0100 and later areas.

Contents of folder

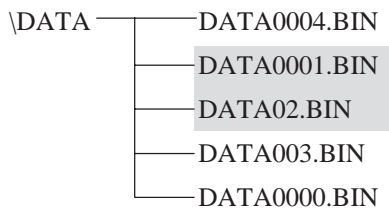

Contents of LS Area

	16 bit		
LS0100	'D'	'A'	} 7 words are used.
LS0101	'T'	'A'	
LS0102	'0'	'0'	
LS0103	'0'	'1'	
LS0104	'.'	'B'	
LS0105	'I'	'N'	
LS0106	'\0'	'\0'	
LS0107	'D'	'A'	} 7 words are used.
LS0108	'T'	'A'	
LS0109	'0'	'2'	
LS0110	'.'	'B'	
LS0111	'I'	'N'	
LS0112	'\0'	'\0'	
LS0113	'\0'	'\0'	



- **Specifying the offset as 0 means the listing begins from the first file (starting file).**
- **As for the file name, only the "8.3 format" (a maximum of 12 characters, with 8 characters for the file name and 3 characters for the extension) may be used. Long file names cannot be used.**
- **If the specified folder does not have enough files as specified, the remaining LS Area is filled with NULL characters ('\0').**
- **If a file name has fewer than 12 characters, the empty positions are filled with NULL characters ('\0').**
- **To specify a folder name, be sure to add "*. *" (e.g. "\DATA*. *"). "*. *" means to list all files.**
- **The number of files actually listed is written in CF Card Listed Files [s:CF_FILELIST_NUM]. For details on CF Card Listed Files, [Reference](#) CF card status.**
- **Destination LS Addresses are not counted as D-Script Addresses.**
- **The file names are not sorted when they are written into the LS Area. They are written in the order of creation (the order of FAT entry).**
- **You can create the list by specifying a file extension. To list the files with a certain extension, use a format such as "\DATA*.BIN". You cannot use "*" within a file name.**

<File Delete>

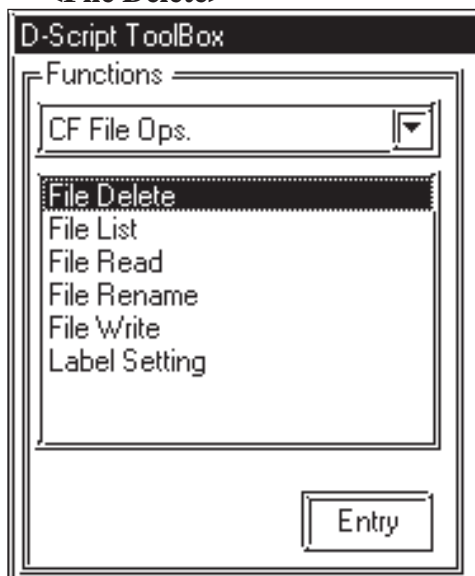

File Delete

Deletes the specified file from the CF card. Parameter 1 designates the CF Card data folder. Parameter 2 designates the name of the file to be deleted.

Parameters

Parameter 1 Folder name: Fixed string

Parameter 2 File name: Fixed string, LS Area, LS Device + Temporary address

Format

`_CF_delete(Folder name, File name)`

The file name can also be designated indirectly via the LS Address.

Example statement

`_CF_delete("\DATA", "DATA0001.BIN")`

The above example deletes the "\DATA \DATA0001.BIN" file.

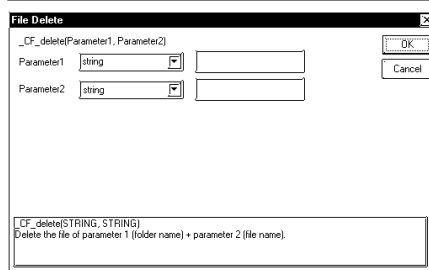



- As for the file name, only the "8.3 format" (a maximum of 12 characters, with 8 characters for the file name and 3 characters for the extension) may be used. Long file names cannot be used.
- The maximum allowable number of characters for the first parameter "Folder name" and the second parameter "File name" is 32 single-byte characters.
- The LS Area can be specified for the second parameter "File name". Specifying the LS Area allows the indirect addressing of a file name. Up to 32 single-byte characters can be used to specify a file name.

In this example, a file name is stored in LS0100 through LS0106 as follows:

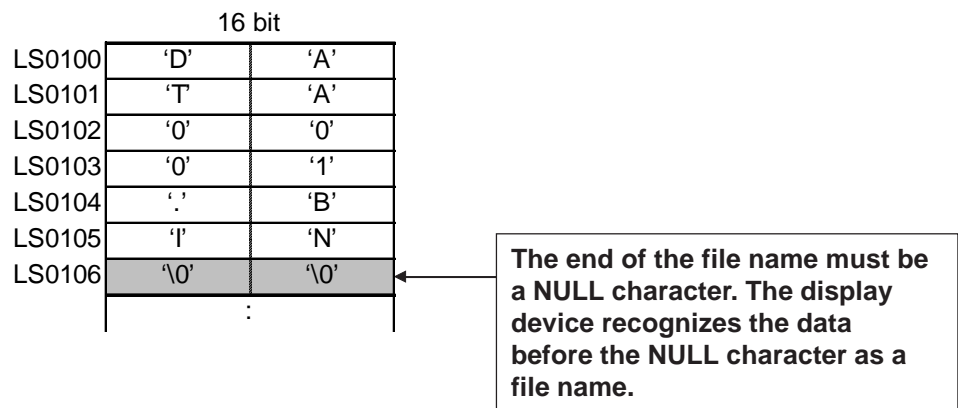

In the example above, the "\DATA\DATA0001.BIN" file is deleted.

- To specify a root folder (directory), enter " " (empty string) as the folder name.
- When the LS Area is specified for "File name", "Destination Addresses" are not counted as D-Script Addresses.
- To specify a full path for a file name, enter "*" (asterisk) as the folder name.

<File Rename>

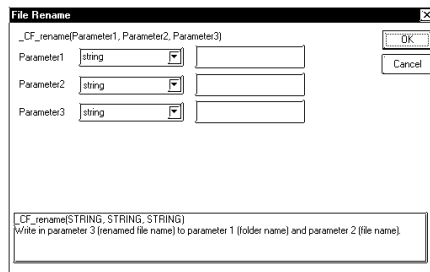
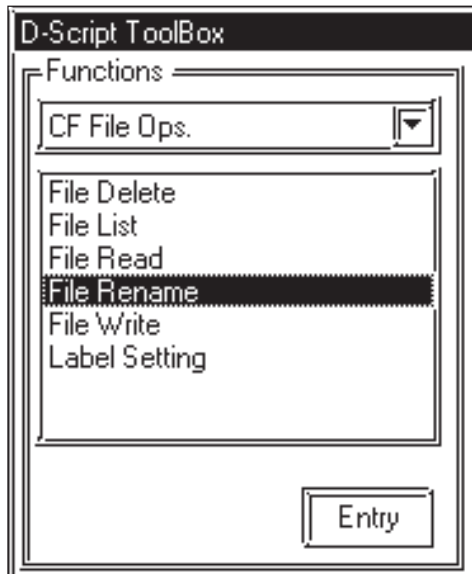

File Rename

Changes the name of a file. Parameter 1 designates the CF Card data folder. Parameter 2 designates the original file name. Parameter 3 designates the new name.

Parameters

Parameter 1 Folder name: Fixed string

Parameter 2 File name: Fixed string, LS Area

Parameter 3 New name: Fixed string, LS Area

Format

`_CF_rename(Folder name, File name, New file name)`

The file name can also be designated indirectly with the LS Address.

Example statement

`_CF_rename("\DATA", "DATA0001.BIN", "DATA1234.BIN")`

The example above changes the file name from `"\DATA\DATA0001.BIN"` to `"\DATA\DATA1234.BIN"`.



- As for the file name, only the "8.3 format" (a maximum of 12 characters, with 8 characters for the file name and 3 characters for the extension) may be used. Long file names cannot be used.
- The maximum allowable number of characters for the first parameter "Folder name" and the second parameter "File name" is 32 single-byte characters.
- The LS Area can be specified for the second and third parameter's "File names". Specifying the LS Area allows the indirect addressing of file names. Up to 32 single-byte characters can be used to specify a file name.

Example:

```
_CF_rename ("\\DATA", [w:LS0100], [w:LS0200])
```

Storing the file name in LS0100 and LS0200 enables indirect addressing of the file name.

Store the file names in LS0100 through LS0106 and LS0200 through LS0206 as follows:

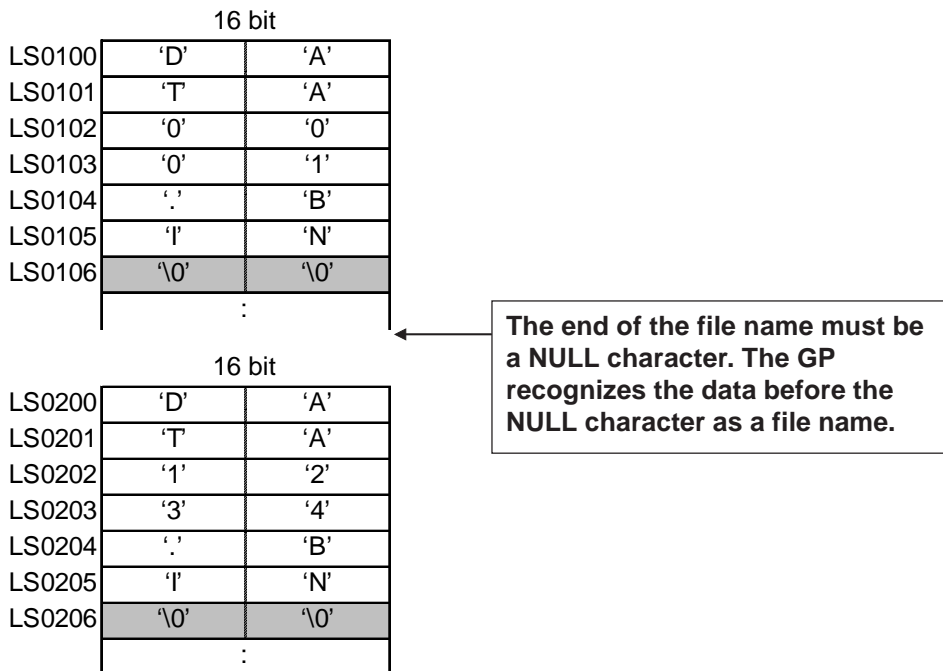

In the example above, the name of the "\\DATA\\DATA0001.BIN" file is changed to "\\DATA\\DATA1234.BIN".

- When the LS Area is specified for "File name", it is not counted as a D-Script Address.
- To specify a root folder (directory), specify " " (empty string) as the folder name.
- To specify a full path for a file name, specify "*" (asterisk) as the folder name.

<Label Settings>

■ CF card status

The following statuses are used for CF card status:

Status name	Label name	Description
Listed Files	[s:CF_FILELIST_NUM]	Stores the number of files actually listed when the File List Output function "_CF_dir()" is executed.
Readout Bytes	[s:CF_READ_NUM]	Stores the number of bytes that can be read out when the File Read function "_CF_read()" is executed.
CF Card Error Status	[s:CF_ERR_STAT]	Stores the error status generated when the CF card is accessed.

Listed Files

When the File List Output function "_CF_dir()" is executed, the number of file lists that are actually written in the LS Area is stored in "Listed Files [s:CF_FILELIST_NUM]"

Usage example

```
_CF_dir("\DATA\*.*", [w:LS0100], 10, 0)
```

```
[w:LS0200] = [s:CF_FILELIST_NUM]
```



When an attempt is made to obtain a file list of 10 files but the specified folder contains only five files, "5" is stored in [s:CF_FILELIST_NUM].



- **When no files are written, the total number of files contained in the specified folder is written in [s:CF_FILELIST_NUM].**

■ Readout Bytes

When the File Read function "_CF_read()" is executed, the number of bytes actually read out is stored in "Readout Bytes [s:CF_READ_NUM]".

Usage example

```
_CF_read("\DATA", "DATA0001.BIN", [w:LS0100], 16, 16)
```

```
[w:LS0200] = [s:CF_READ_NUM]
```

When an attempt is made to read 16 bytes but only 12 bytes are read successfully, "12" is stored in [s:CF_READ_NUM].

■ **CF Card Error Status**

Stores error statuses generated when the CF card is accessed.

Bit position	Error name	Description
15	Reserved	Reserved
14		
13		
12		
11		
10		
9		
8		
7		
6	File rename error	CF card was removed during operation. Specified file does not exist. An attempt was made to rename a file with a read-only attribute.
5	File delete error	CF card was removed during operation. Specified file does not exist. An attempt was made to delete a file with a read-only attribute.
4	File write error	CF card was removed during operation. No available space remains on CF card. An attempt was made to write data to a file with a read-only attribute.
3	File read error	CF card was removed during operation. Specified file does not exist.
2	File list error	CF card was removed during operation. Specified folder did not exist.
1	CF card error	CF card is invalid. The media inserted is not a CF card.
0	No CF card	No CF card is inserted. Cover is open.

- Even when a CF card error occurs, operation continues. Be sure to write a script to check the error whenever you use the CF card file operation function.

Example:

```
_CF_dir("\DATA\*.*", [w:LS0100], 2, 1) // Outputs a file list.
if([s:CF_ERR_STAT02] <> 0)           // Checks the error status.
{
    set([b:LS005000])                 // Sets the bit address for error
                                        display.
}
endif
```

[Storage area of detailed status of CF card error]

If an error occurs, the appropriate bits are set. You can check the cause of the error by referring to the detailed status. The detailed status for each function is stored in LS9132 through LS9136 of the extended system area. These areas are read-only.

LS Area	
LS0000	
:	
LS9132	Status of CF card list operation
LS9133	Status of CF card read operation
LS9134	Status of CF card write operation
LS9135	Status of CF card delete operation
LS9136	Status of CF card rename operation
:	
LS9999	

[Error list for each function]

Name of editor function		Error status	Cause
_CF_dir()	LS9132	0x0010	Invalid D-script data (Error in retrieving folder name specified with fixed string)
		0x0012	File name (path name) error
		0x0018	LS Area writing range error
		0x0020	No CF card
		0x0021	Invalid CF card
		0x0100	Directory open error

_CF_read()	LS9133	0x0010	Invalid D-script data (Error in retrieving folder name/file name specified with fixed string)
		0x0011	LS Area reading range error
		0x0012	File name (path name) error
		0x0018	LS Area writing range error
		0x0020	No CF card
		0x0021	Invalid CF card
		0x0101	File seek error (Offset error)
		0x0102	Number of readout bytes error
	0x0110	File creation (open) error	

_CF_write()	LS9134	0x0010	Invalid D-script data (Error in retrieving folder name/file name specified with fixed string)
		0x0011	LS Area reading range error
		0x0012	File name (path name) error
		0x0020	No CF card
		0x0021	Invalid CF card
		0x0101	File seek error (Offset error)
		0x0104	Folder creation error
		0x0108	Write mode error
		0x0110	File creation (open) error
	0x0111	File write error (e.g. Insufficient space on CF card)	

_CF_delete()	LS9135	0x0010	Invalid D-script data (Error in retrieving folder name/file name specified with fixed string)
		0x0011	LS Area reading range error
		0x0012	File name (path name) error
		0x0020	No CF card
		0x0021	Invalid CF card
		0x0112	File delete error (e.g. Specified file does not exist. Specified file is read-only.)

_CF_rename()	LS9136	0x0010	Invalid D-script data (Error in retrieving folder name/file name specified with fixed string)
		0x0011	LS Area reading range error
		0x0012	File name (path name) error
		0x0020	No CF card
		0x0021	Invalid CF card
		0x0114	File rename error (e.g. Specified file does not exist. Specified file is read-only. File name already exists.)

■ **Data storage mode**

When data is read/written from/to device addresses at the execution of the File Read/File Write function, the storage order of the written (readout) data can be specified.

Setting the data storage mode in LS9130 can change the storage order.

The mode can be selected from four options: 0, 1, 2 and 3.

◆ **Mode 0**

Example: When the File Read function is used to write a string "ABCDEFGH" in a device address

[w:LS9130] = 0

_CF_read("\DATA", "DATA0001.BIN", [w:LS0100], 0, 7)

- When the device address length is 16 bits

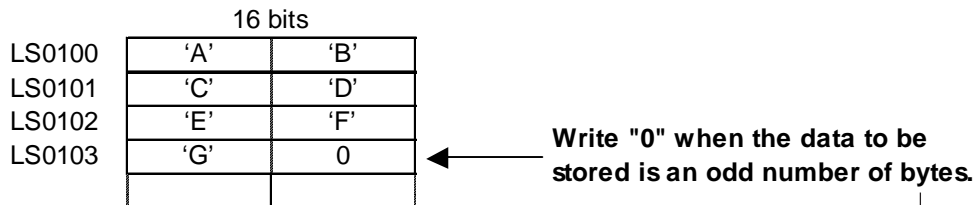

- When the device address length is 32 bits

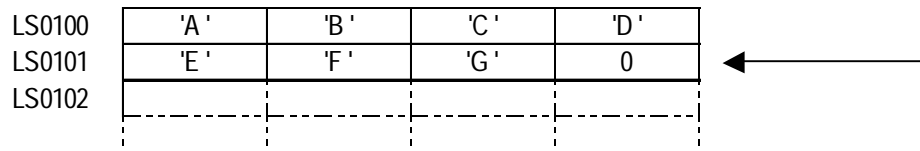

◆ **Mode 1**

Example: When the File Read function is used to write a string "ABCDEFGH" in a device address

[w:LS9130] = 1

_CF_read("\DATA", "DATA0001.BIN", [w:LS0100], 0, 7)

- When the device address length is 16 bits

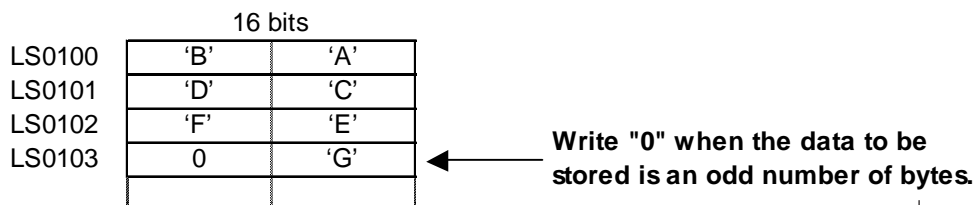

- When the device address length is 32 bits

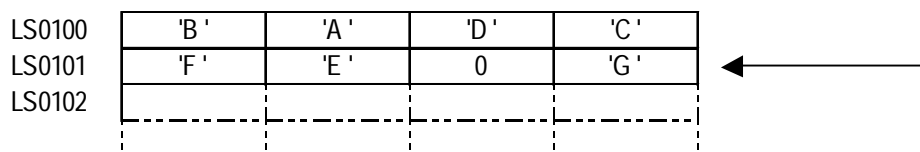

◆ Mode 2

Example: When the File Read function is used to write a string "ABCDEFGG" in a device address

[w:LS9130] = 2

_CF_read("\DATA", "DATA0001.BIN", [w:LS0100], 0, 7)

- When the device address length is 16 bits

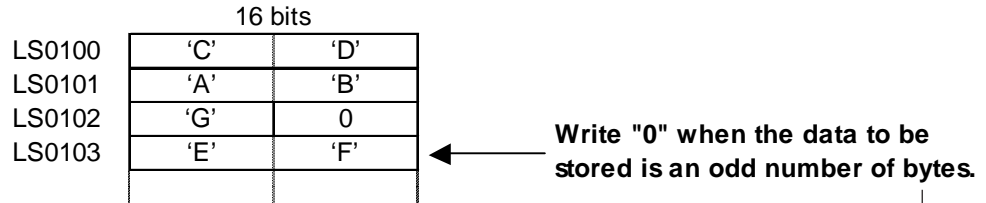

- When the device address length is 32 bits

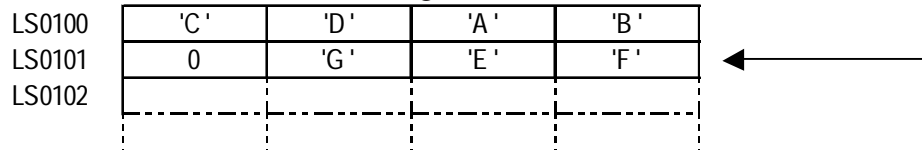

◆ Mode 3

Example: When the File Read function is used to write a string "ABCDEFGG" in a device address

[w:LS9130] = 3

_CF_read("\DATA", "DATA0001.BIN", [w:LS0100], 0, 7)

- When the device address length is 16 bits

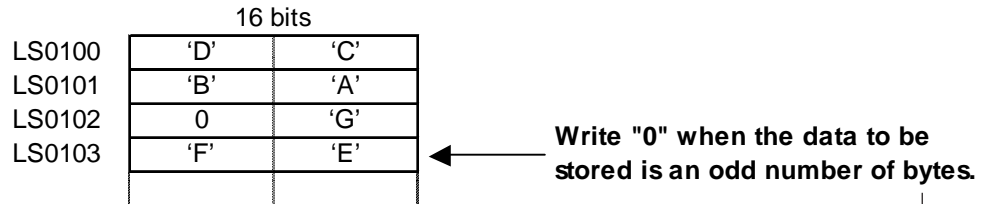

- When the device address length is 32 bits

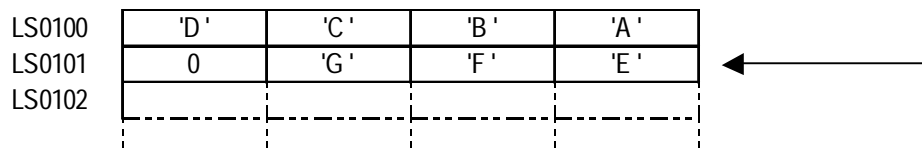

• **The data storage mode is not the same as the string data mode in the system setting. The relationship with the string data mode is shown in the following table.**

Order of data stored in device	Order of bytes stored in word (LH/HL)	Order of bytes stored in double word (LH/HL)	D-Script data storage mode	String Data Mode
Stored from the first data	HL	HL	0	1
	LH		1	2
	HL	LH	2	5
	LH		3	4
Stored from the last data	HL	HL	---	3
	LH		---	7
	HL	LH	---	8
	LH		---	6



- **The CF Card has a data overwrite limit of approximately 100,000 times. Therefore, be sure to backup all CF Card data regularly to another storage media. (assuming that 500KB of DOS format data is overwritten, the limit is 100,000 times)**
- **If an error occurs during CF card processing, the error is written to the CF Card Error Status [s:CF_ERR_STAT]. For details of the CF Card Error Status, [Reference](#) CF card status**
- **The following symbols and characters cannot be used in folder names or file names. Use of these symbols and characters in a folder name or file name will generate an error.
';', ',', '=', '+', '/', '\', '"', '[', ']', '|', '<', '>', ' ' (space), '?'**
- **To specify a root folder (directory), specify " " (empty string) as the folder name.**

■ Printer Port Ops.

<Printer Port Output>

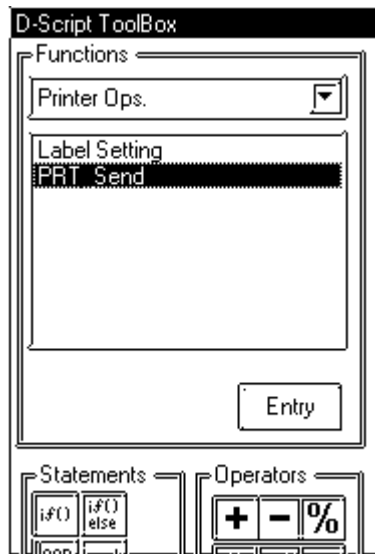

Only GP2000 Series units (except the GP-2301, GP-2301H and GP-2401H units) support this feature.

Printer Port Output

The specified number of bytes of data is output from the printer port. The data is output regardless of the printer type specified.

Parameters

Parameter 1: [p:PRN]

Parameter 2: LS Area

Parameter 3: Integral value, Device address, Temporary address

Format

IO_Write([P:PRN], Start device address where output data will be stored, Number of output bytes)



- ***The maximum numerical value that can be specified for Parameter 3 is 1024. Even when values larger than 1024 are specified, Only 1024 bytes of data are output from the printer port.***

Example statement 1

```
IO_WRITE([p:PRN], [w:LS1000], 10)
```

In the example above, 10 bytes of data stored in LS1000 and later areas are output from the printer port.

Example statement 2

```
IO_WRITE([p:PRN], [w:LS1000], [w:LS0800])
```

In the example above, the data stored in LS1000 and later areas are output from the printer port. The number of bytes is that same as that written in LS0800.

Example statement 3

```
IO_WRITE([p:PRN], [w:LS1000], [t:0010])
```

In the example above, the data stored in LS1000 and later areas are output from the printer port. The number of bytes is that same as that written in the Temporary address [t:0010].

Data storage mode

When data is read from device addresses upon execution of the Printer Port Operation function, you can specify the storage order of the readout data.

Setting the data storage mode in LS9130 may change the storage order.

Select a mode from the four options available: 0, 1, 2 or 3.

◆ **Mode 0**

Example: When the Printer Port Operation function is used to read the string “ABCDEFG” from a device address

```
[w:LS9130] = 0
```

```
IO_WRITE([p:PRN], [w:LS1000], 7)
```

- When the device address length is 16 bits

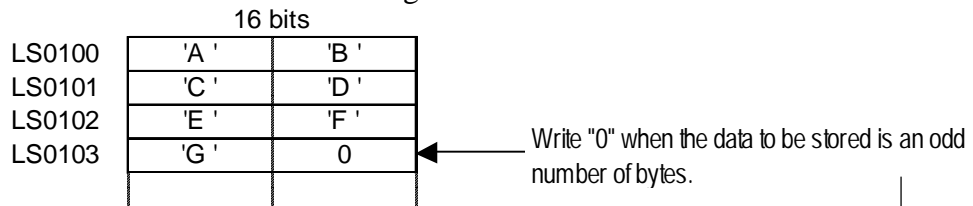

- When the device address length is 32 bits

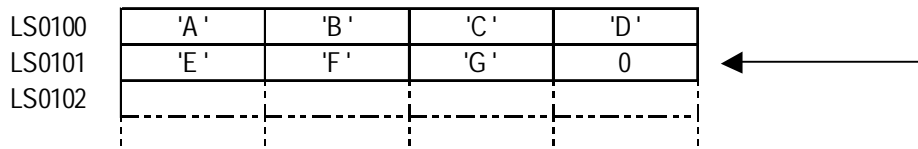

◆ **Mode 1**

Example: When the Printer Port Operation function is used to read a string “ABCDEFG” from a device address

```
[w:LS9130] = 1
```

```
IO_WRITE([p:PRN], [w:LS1000], 7)
```

- When the device address length is 16 bits

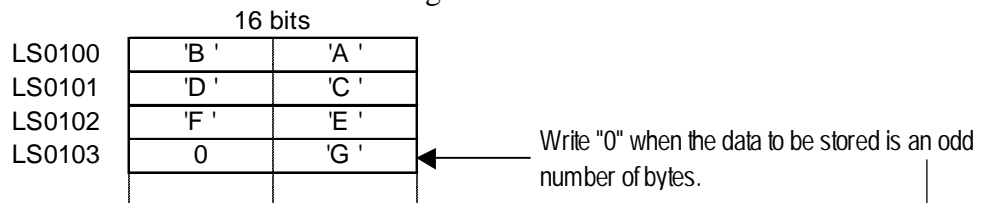

- When the device address length is 32 bits

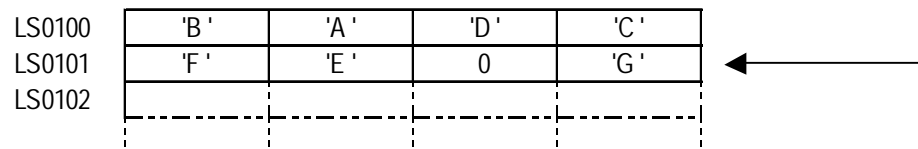

◆ Mode 2

Example: When the Printer Port Operation function is used to read a string “ABCDEFGG” from a device address

[w:LS9130] = 2

IO_WRITE([p:PRN], [w:LS1000], 7)

- When the device address length is 16 bits

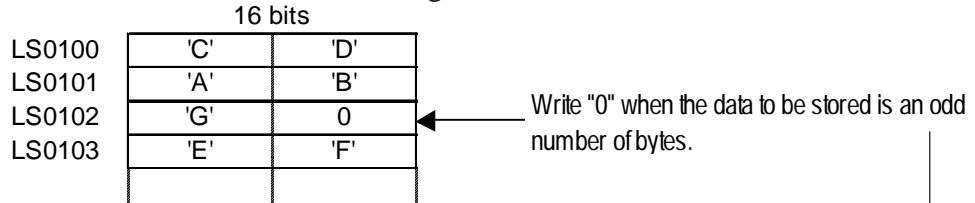

- When the device address length is 32 bits

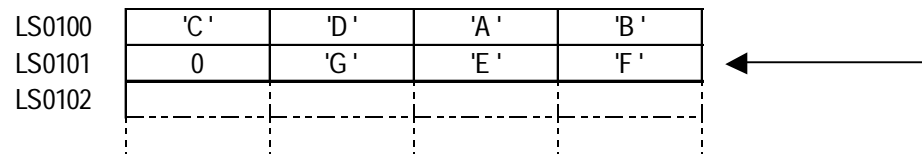

◆ Mode 3

Example: When the Printer Port Operation function is used to read a string “ABCDEFGG” from a device address

[w:LS9130] = 3

IO_WRITE([p:PRN], [w:LS1000], 7)

- When the device address length is 16 bits

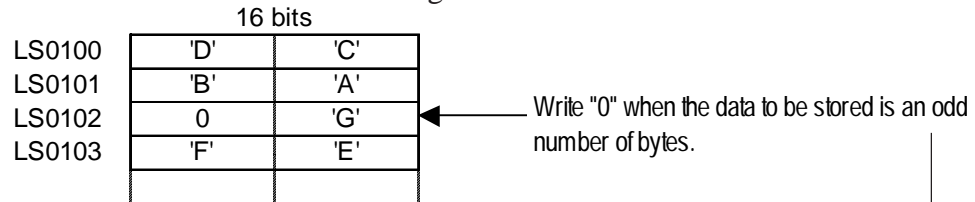

- When the device address length is 32 bits

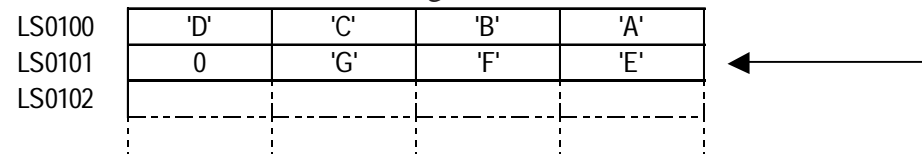

• **Data storage mode is not the same as string data mode in the system settings. The following table shows the relationship with string data mode.**

Order of data stored in device	Order of bytes stored in word (LH/HL)	Order of bytes stored in double word (LH/HL)	D-Script data storage mode	String Data Mode
Stored from the first data	HL	HL	0	1
	LH		1	2
	HL	LH	2	5
	LH		3	4
Stored from the last data	HL	HL	—	3
	LH		—	7
	HL	LH	—	8
	LH		—	6

<Label Settings>

■ Control

For the Printer Port Operation function, the new control variable PRN_CNTRL is added in order to clear the send buffer or error status. The Control variable is write-only.

- Contents of Control variable (PRN_CNTRL)

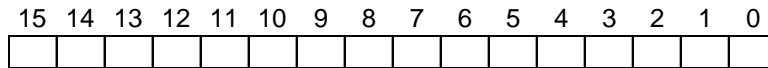

Bit	Content
15	Reserved
14	
13	
12	
11	
10	
9	
8	
7	
6	
5	
4	
3	
2	1: Clear error
1	Reserved
0	1: Clear send buffer



- *When a word is designated (when two or more bits are set simultaneously), the processing is executed in the following order:*

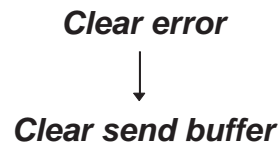

- *The reserved bits may be used in the future; therefore, designate only the bits that are required.*

■ **Status**

For the Printer Port Operation function, the new control variable PRN_STAT is added in order to check for the presence/absence of data in the send buffer or the error status. The Status variable is read-only.

- Contents of Status variable (PRN_STAT)

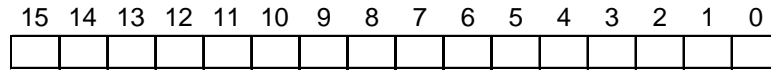

Content	Reserved
15	Reserved
14	
13	
12	
11	
10	
9	
8	
7	
6	
5	
4	
3	
2	
1	0: Normal 1: Transmission error
0	0: Data present in Send buffer 1: Send buffer is empty.



- **One of the transmission errors is the Send buffer overflow error. Should this error occur, the transmission error bit turns on.**
- **The Send buffer is 8192 bytes.**
- **The reserved bits may be used in the future; therefore, designate only the bits that are required.**

■ Functions

A D-Script program can be created using Functions. A program created as a Function can be used on the same screen or on other screens. The Functions can be used commonly for D-Script and Global D-Script.

The GP-270 does not support this feature.

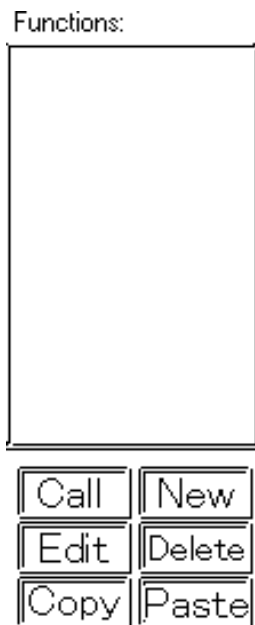

Call

Select a Function name to be loaded and then click on this button. After clicking on the Load button, the called-up Function name will be displayed in the formula area.

Edit

Select a Function name to be edited and then click on this button. Use the D-Script Function dialog box to perform editing.

▼ Reference ▲ For how to edit program, refer to the D-Script Editor.

Delete

Click on this button to delete the created Function. First, select a Function name to be deleted and then click on the Delete button.

Copy

Any selected function can be copied.

Paste

Use this command to paste a copied function. Click on this button and the following dialog box will appear. Then, enter the name for the function to be pasted.

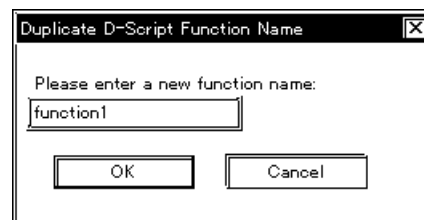

◆ New

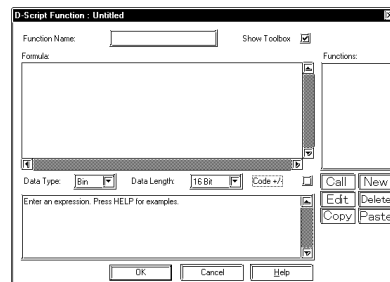

Select this button to create a new program (Function). A program can then be created via the D-Script Functions that appear.

▼ **Reference** ▲ For how to create a new program, refer to the D-Script Editor.

Function Name

Enter the name of your Function here. Once a Function is created, that Function name is displayed in the Function area. Up to 20 characters can be used for a Function name. (Alphabet characters, numbers, and “_”)



The following function names are reserved. DO NOT use these names.

“rise”, “fall”, “rise_expr”, “timer”, “set”, “clear”, “toggle”, “if”, “else”, “endif”, “b_call”, “Bcall”, “dsp_rectangle”, “dsp_line”, “dsp_dot”, “dsp_circle”, “dsp_arc”, “Call”, “and”, “or”, “not”, “memcpy”, “memset”, “loop”, “break”, “IO_READ”, “IO_WRITE”, “_memcpy_EX”, “_memset_EX”, “IO_READ_EX”, “IO_WRITE_EX”, “IO_READ_WAIT”, “databuf0”, “databuf1”, “databuf2”, “databuf3”, “_strset”, “_dlcopy”, “_hexasc2bin”, “_decasc2bin”, “_bin2hexasc”, “_strlen”, “_strcat”, “_strmid”, “_wait”, “return”

3.1.4 D-Script / Global D-Script Limitations

◆ Limitations on BCD format operations

If a value which cannot be converted into BCD format is found during operation, the program stops running. These values include A to F in hexadecimal format. Do not use such values. If the program stops due to non-BCD values, bit 7 in common relay information (LS2032) in the GP turns ON. This bit does not turn OFF until the GP is turned OFF or goes offline.

E.g. $[w:D200] = ([w:D300]) \ll 2 + 80$

If D300 is 3, shifting two bits to the left results in 0x000C, which cannot be converted into BCD format interrupts program execution.

$[w:D200] = [w:D300] \ll 2$

If D300 is 3, shifting two bits to the left results in 0x000C. Unlike the above example, 0x000C is the result of the operation to be stored in the memory, and does not cause the program to stop.

◆ Limitations of zero operations

Do not divide by zero in division (/) and remainder (*) operations. If you do, the program stops and bit 8 in common relay information (LS2032) turns ON. This bit does not turn OFF until the GP is turned OFF or goes offline.

◆ Notes on delay during assign operation

Using a device address in an assign operation may cause write delay because the GP has to read the address data from the host (PLC). Consider the following:

E.g. $[w:D200] = [w:D300] + 1 \dots (1)$

$[w:D201] = [w:D200] + 1 \dots (2)$

Statement (1) assigns (D300+1) into D200. However, in statement (2), the result of statement (1) has not been assigned in D200 because of time-consuming communication with the host (PLC). In such case, program so that the result of statement (1) is stored in the LS area before it is executed, as shown below.

$[w:LS100] = [w:D300] + 1$

$[w:D200] = [w:LS100]$

$[w:D201] = [w:LS100] + 1$

- As a guide for D-Script programming, three addresses occupy the same amount of memory as one tag. The maximum number of addresses available for a script is 255. However, try to use the fewest possible addresses, since the more devices that are used, the slower the response.
- The Convert Address command in the Utility menu of the Project Manager cannot convert addresses used in D-Script. Open the D-Script Editor to change these addresses.

- If you have changed the Device/PLC Type setting in the Save As window from that used in the Project menu, the addresses used by D-Script will not be converted. Please use the D-Script Editor to change these addresses.
- The size of a D-Script affects the tag scanning time. Note that using a large number of addresses may significantly degrade the performance of the program.
- Up to 9 levels of Functions can be called by a program. Do NOT create more than that.
- Up to 9 levels of nested Functions can be recalled.
- Up to 254 Functions can be created.
- D-Script operations activated by a trigger after the screen changes are as follows:

Trigger Conditions	Direct Access Method				Memory Link Method			
	Current Value or Condition	Bit "0"	Bit "1"	FALSE	TRUE	Bit "0"	Bit "1"	FALSE
Bit rise	X	○	-	-	X	X	-	-
Bit fall	○	X	-	-	X	X	-	-
Bit Dual Operation	○	○	-	-	X	X	-	-
Timer settings	X	X	X	X	X	X	X	X
Detecting true	-	-	X	○	-	-	X	○
Detecting false	-	-	○	X	-	-	○	X

○ : Operation is performed right after the screen is changed, or the power is turned ON.

X : Operation is not performed right after the screen is changed, or the power is turned ON.

- When the timer is operating, the timer starts counting right after the screen changes.
- When using Global D-Script, the operations mentioned above are performed only when the GP's power is turned ON. When the GP screen changes, however, the operation mentioned above will not be performed and the monitor operates using the trigger conditions that have been set.
- When a Global D-Script includes a timer, the timer starts counting right after the GP's power cord is connected.



Do not use the touch panel key to set the trigger bit or to operate the start bit in a program because the timing of the touch input may not be correct, resulting in the bit being improperly entered.

- When a value is assigned to an address for switching screens while a D-Script command is being executed, the screen switching operation is processed after all D-Scripts have been processed.

Example:

ID: 00000

Data Format: Bin, Data Length: 16 bits, Code +/-: No Code

Trigger: Leading bit ([b:M0000])

Processing [w: D00100]=0 //(1)

[w: LS0008]=30 //(2) Switches to Base screen No. 30

[w: D00101]=1 //(3)

[w: D00102]=2 //(4)

When the above D-Script is executed, processing of the screen switching is performed after (3) and (4) have been processed.

◆ Limitations Specific to Global D-Script

- When the GP's power is turned ON, the actions shown in the table on the previous page are performed. At the screen change, the above table is not applied, and the trigger conditions are continuously monitored.
- Global D-Script operation is suspended during screen changes or other GP operations.
- After the GP's power is turned ON, Global D-Script actions are not performed until all data reads are completed for the initial screen. However, after the initial screen changes, Global-D-Script actions may be performed before the data reads are completed.
- The maximum number of devices in Global D-Script is 255. When this number exceeds 256, the D-Script does not function. Since these devices always read data regardless of the screens, be sure to use only the minimum number of device settings in your D-Script. Otherwise, operation performance can be degraded.
- The maximum number of Global D-Scripts available is 32. The currently used function also counts as one Global D-Script. When the number of the Global D-Scripts reaches 32, any new Global D-Scripts are ignored.

◆ **Error message display of D-Script and Global D-Script**

The following error messages are displayed when D-Scripts and Global D-Scripts are not configured properly. The GP2000 Series unit displays the error message on the bottom at the GP screen.

	Error Message
D-Script	D-Script Error (***)
Global D-Script	Global D-Script Error (***)

The following table lists the numbers assigned to (***) in the above error messages. Error Nos. "001" and "002" are displayed at power-on, and Error Nos. "003" and "004" are displayed when an error occurs during the function processing.

No.	Description	Applicable Script
001	The total number of Global D-Scripts exceeds the limit. The maximum number of Global D-Scripts is 32. Note that functions are included in the counts.	Global D-Script
002	The total of all devices in the Global D-Script exceeds the limit of 255 devices.	Global D-Script
003	The called function does not exist. (Displayed when there is an error in the function)	D-Script Global D-Script
004	Function cannot be nested more than 10 levels.	D-Script Global D-Script

3.1.5 Notes on Operation Results

■ Overflowing Digits

Overflowing digits resulting from operations are rounded.

E.g. When performing an operation on unsigned 16-bit data:

- $65535 + 1 = 0$ (Produces overflowing digits)
- $(65534 * 2) / 2 = 32766$ (Produces overflowing digits)
- $(65534 / 2) * 2 = 65534$ (Does not produce overflowing digits)

■ Difference of Residual Processing

The result of a residual processing depends on whether the left and right sides are signed or unsigned. When a remainder is produced by a division operation, an error may be created due to round up operation.

- E.g.
- $-9 \% 5 = -4$
 - $9 \% -5 = 4$

■ Rounded Decimal Places

Decimal places resulting from a division are rounded.

- E.g.
- $10 / 3 * 3 = 9$
 - $10 * 3 / 3 = 10$

■ Notes on Operating BCD data

A BCD-data operation which produces overflowing digits does not give the correct result.

3.1.6 Logical Operation Examples**■ Bit Operation Examples**

- ◆ **((100 > 99) and (200 <> 100))**

Result : ON

- ◆ **((100 > 99) and (200 <> 200))**

Result : OFF

- ◆ **((100 > 99) or (200 <> 200))**

Result : ON

- ◆ **((100 < 99) and (200 <> 200))**

Result : OFF

- ◆ **not (100 > 99)**

Result : OFF

- ◆ **not (100 < 99)**

Result : ON

- ◆ **[w:D200] < 10**

Result : True if D200 is smaller than 10.(ON)

- ◆ **not [w:D200]**

Result : True if D200 is 0.(ON)

- ◆ **([w:D200] == 2) or ([w:D200] == 5)**

Result : True if D200 is 2 or 5.(ON)

- ◆ **([w:D200] < 5) and ([w:D300] < 8)**

Result : True if D200 is smaller than 5, and D300 is smaller than 8.(ON)

False = (OFF)

3.1.7 Bit Operation Examples

■ This section gives examples of bit operations.

◆ [w:D200] << 4

Result: The data in D200 is shifted 4 bits to the left.

◆ [w:D200] >> 4

Result: The data in D200 is shifted 4 bits to the right.

◆ 0012h is stored in D301, using the BCD format.

[w:D200] = [w:D300] >> [w:D301]

Result : The data in D300 is shifted 12 bits to the right and assigned to D200.

◆ Bit AND

0 & 0	Result : 0
0 & 1	Result : 0
1 & 1	Result : 1
0x1234 & 0xF0F0	Result : 0x1030

◆ Bit OR

0 0	Result : 0
0 1	Result : 1
1 1	Result : 1
0x1234 0x9999	Result : 0x9BBD

◆ Bit XOR

0 ^ 0	Result : 0
0 ^ 1	Result : 1
1 ^ 1	Result : 0

◆ Bit One's complement (NOT) (When the data format is Bin16 +.)

~ 0	Result : 0xFFFF
~ 1	Result : 0xFFFE

3.1.8 Conditional Branches

■ Control Branches Using “if-endif” and “if-else-endif”

◆ if-endif

```
if (condition)
{Process 1}
endif
```

If the condition is true, process 1 is executed. If false, process 1 is ignored.

E.g.

```
if ( [w:D200] < 5)
{
    [w:D100] = 1
}
endif
```

If the data in D200 is smaller than 5, 1 is assigned in D100.

◆ if-else-endif

```
if (condition)
{Process 1}
else
{Process 2}
endif
```

If the condition is true, process 1 is executed. If false, process 2 is executed.

E.g.

```
if ( [w:D200] < 5)
{
    [w:D100] = 1
}
else
{
    [w:D100] = 0
}
endif
```

If the data in D200 is smaller than 5, 1 is substituted in D100. Otherwise, 0 is substituted in D100.

3.1.9 Application Example (1)

In this example, we create a program for a temperature management system, which checks an error bit in the host (PLC) to detect the temperature 70° or above and 30° or below. If an error is found, the GP displays alarm messages accordingly. This system also counts the detected errors.

Error bit : M0001

Temperature information : D200

Error counter (70C° or above) : LS300

Error counter (30C° or below) : LS301

Alarm message screen number storage address : LS302

1. From the Special menu, select the D-Script option.

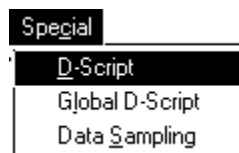

2. When the D-Script List appears, click on the Add button. The D-Script Editor opens.

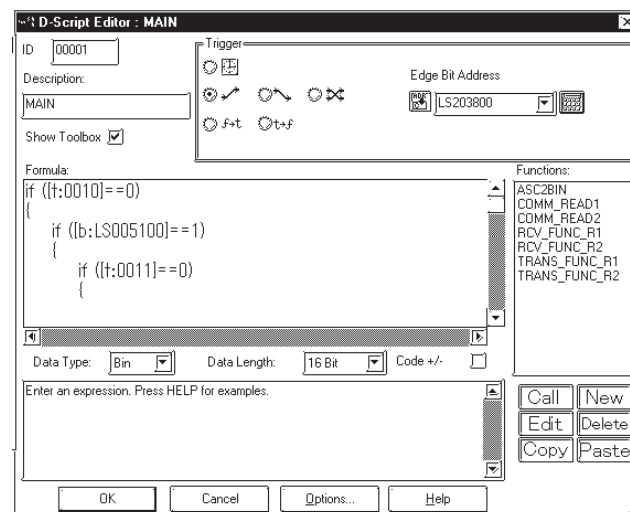
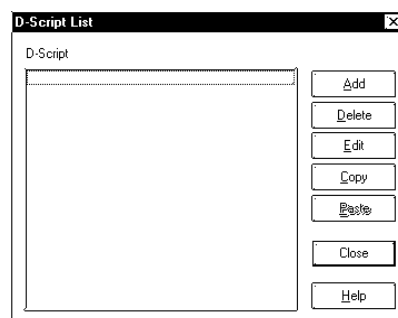

6. Click on the OK button.

The ID number and description you have entered will appear in the D-Script List window.

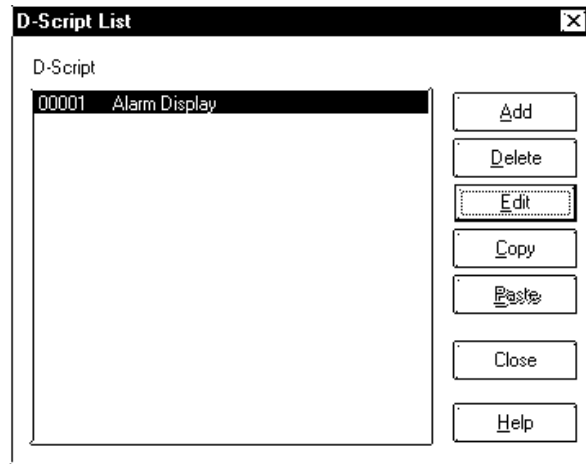

3.1.10 Application Example (2)

In this example, we create three interlocked switches as shown below:

◆ **Screen**

SETUP	Bit switch	Address : M0001,	Bit operation : Set
OK	Bit switch	Address : M0002,	Bit operation : Set
RUNNING	Lamp	Address : M0003	

◆ **Operation Example**

Pressing the SETUP and OK keys in that order turns the RUNNING lamp ON. The host (PLC) uses M0003 as the trigger bit.

◆ **Program Example**

```

Trigger
    [ b:M0002 ] == 1
Execution
    if ( [ b:M0001 ] & [ b:M0002 ] )
        // bit set
        {
            set ( [ b:M0003 ] )
        }
    else
        // bit clear
        {
            clear ( [ b:M0003 ] )
            clear ( [ b:M0002 ] )
        }
    endif

```

3.1.11 Extended SIO Data Transfer Settings

A communication example that uses D-Script Extended SIO is shown below.

Reference 3.1.3 Using D-Script ♦ SIO Port Control

Extended SIO Data Transfer Settings are done using the Screen Editor GP System Settings or the GP Unit Offline Settings.

Setting	Setting Range	Initial Value
Data Transfer Speed (Transfer Baud Rate)	2400, 4800, 9600, 19200, 38400 (bps)	9600 bps
Data Length	7, 8 (bit)	8 bit
Stop Bit	1, 2 (bit)	1 bit
Parity Bit	None, Odd, Even	None

The command to read from the variable area, a communication command for Omron's thermoregulator, is described below in a simple example.

In the variable area to be read, the current value indicated by the thermostat and the target value are illustrated. The current value and the target value are read out every 10 seconds through communication between the GP and the thermostat. The following is an illustration of the communication.

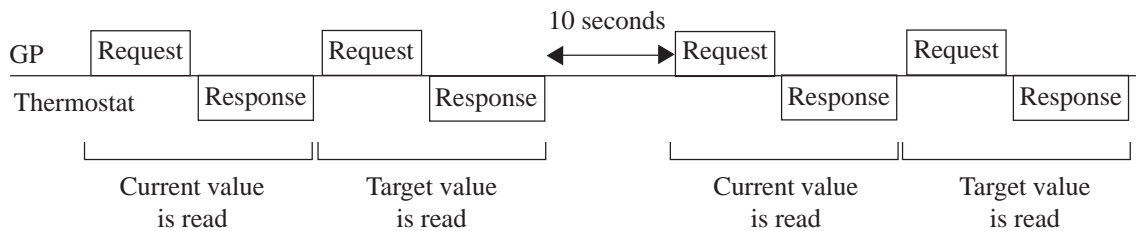

■ Data Format

The following data format is used to communicate with the thermoregulator.

Read out of the current value

- Command Frame (24 bytes)

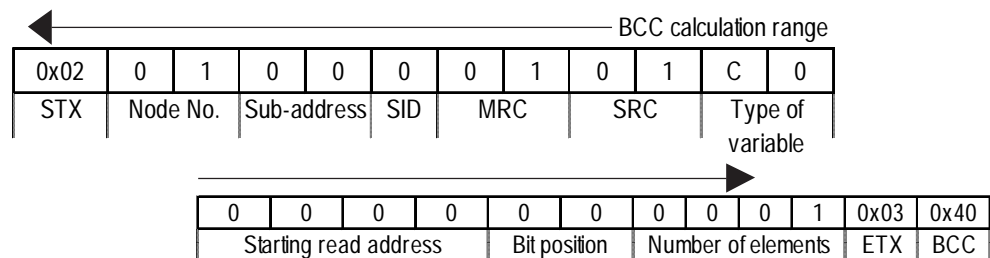

- Response Frame (25 bytes)

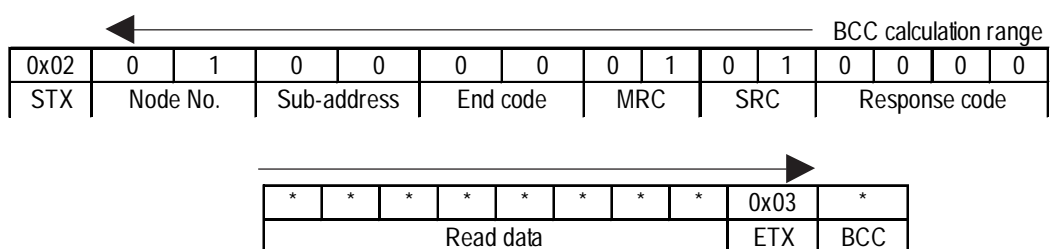

Reading the target value

- Command Frame (24 bytes)

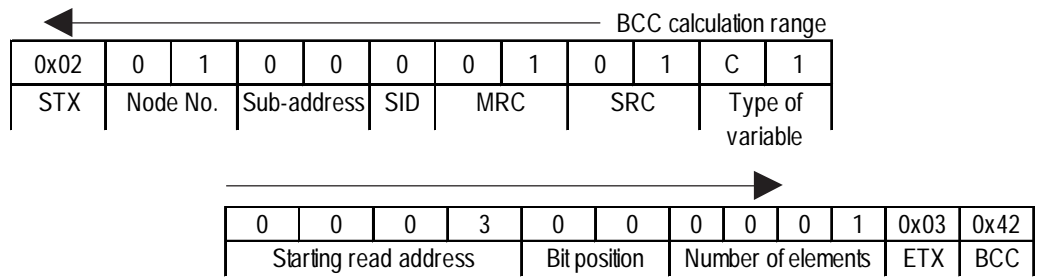

- Response Frame (25 bytes)

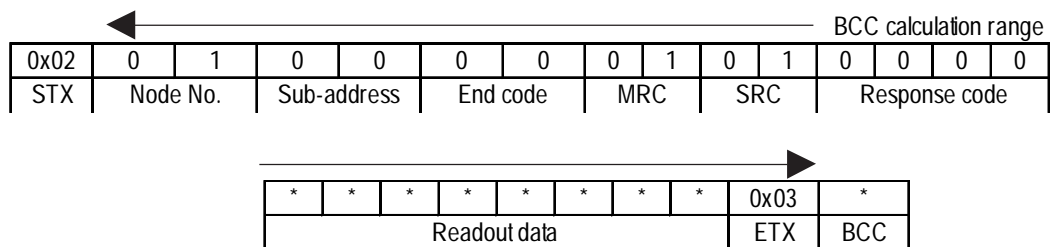

For more information on the above, refer to the communication specifications for Omron’s thermoregulator.

This section explains the D-Script Function.

The D-Script editor in the main routine is as follows.

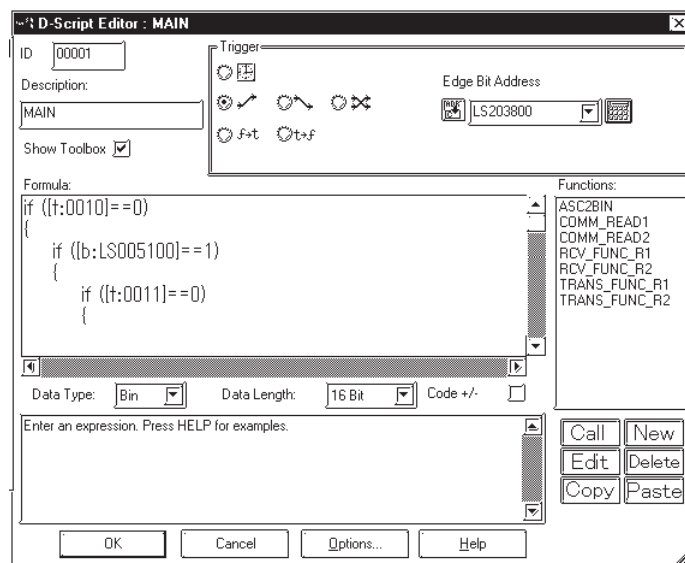

The D-Script Function

D-Script and the D-Script function are described as follows. Please read the descriptions on the following pages before creating your own D-Script.

■ D-Script

1	Initialization routine	Initialization for communication. Run only once before starting communications.
2	Main routine	Main routine for communication. Reads the current value of the thermostat and the target value every 10 seconds.
3	10-second timer routine	Routine for 10-second timer. Decrements the value of the temporary work every second.

■ D-Script function

4	Transmitting / Receiving Function 1 (COMM_READ1)	Reads the current value of the thermostat. Transmits a command to the thermostat and receives the response.
5	Transmitting / Receiving Function 2 (COMM_READ2)	Reads the target value of the thermostat. Transmits a command to the thermostat and receives the response.
6	Transmitting Function 1 (TRANS_FUNC_R1)	Transmits the command to read the current value of the thermostat. Sets up the command
7	Receiving Function 1 (RCV_FUNC_R1)	Receives the response to the command (to read the current value). The received data is stored in the LS area.
8	Transmitting Function 2 (TRANS_FUNC_R2)	Transmits the command to read the target value of the thermostat. Sets up the command values in values in the LS area and transmits them.
9	Receiving Function 2 (RCV_FUNC_R2)	Receives the response to the command (to read the target value). The received data is stored in the LS area.
10	Value Conversion Function (ASC2BIN)	Converts ASCII code into a binary value. The received data is stored in the LS area as ASCII code. This function converts the code into a binary value.

An initialization flow chart and an actual D-Script are given below.

(1) Flow chart of initialization

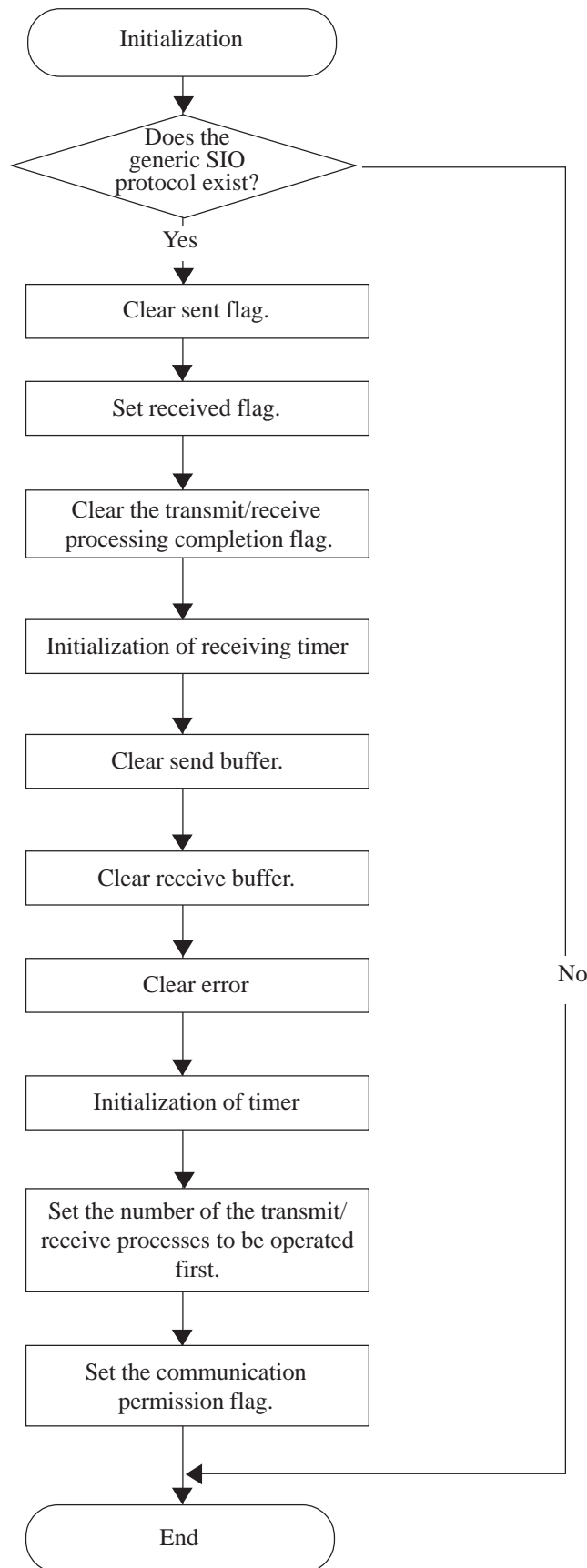

(2) Flow chart of main routine

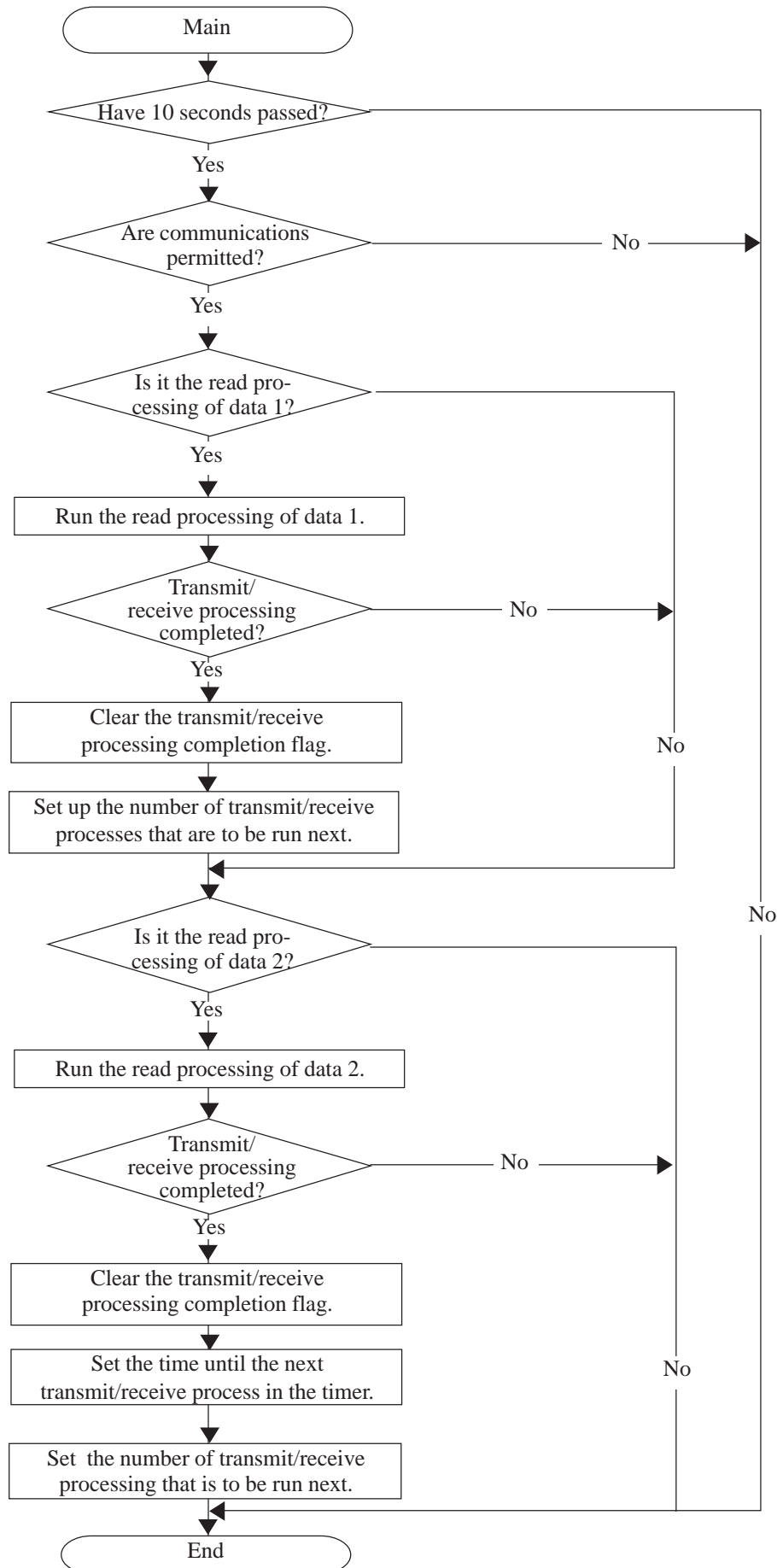

(3) Flow chart of a 10-second timer routine

Run this routine every second.

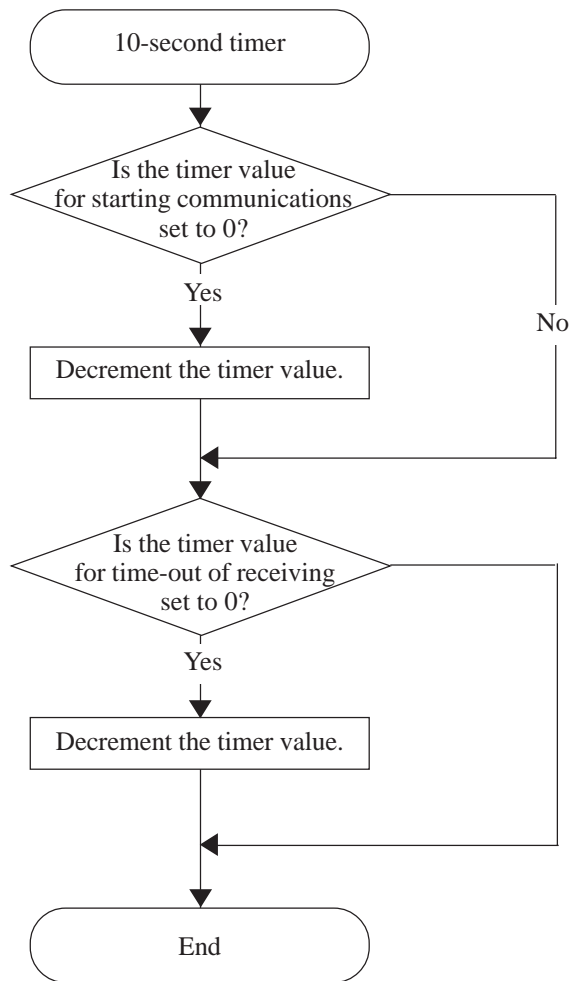

(4) Flow chart of Transmit/Receive Function 1

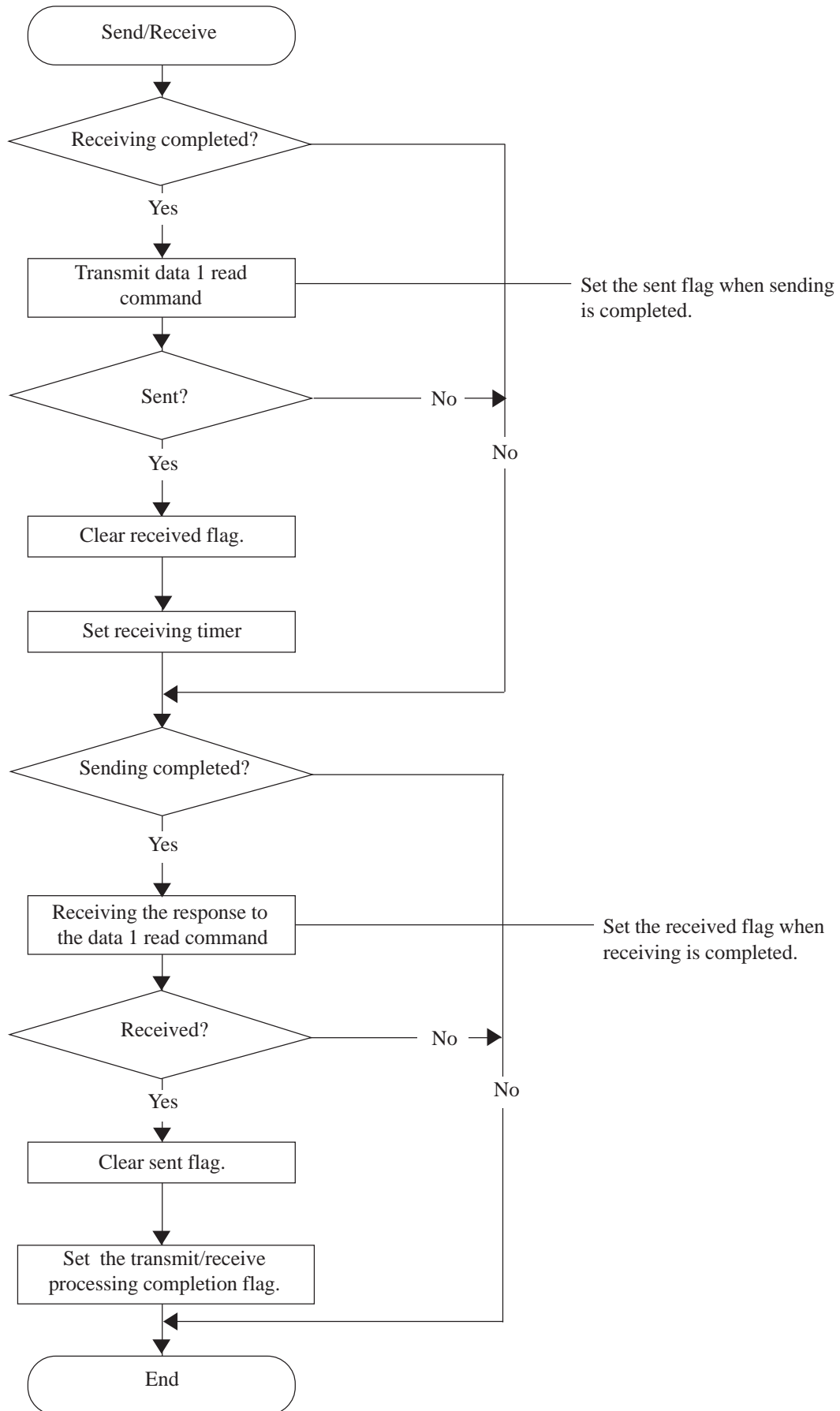

(5) Flow chart of Transmit/Receive Function 2

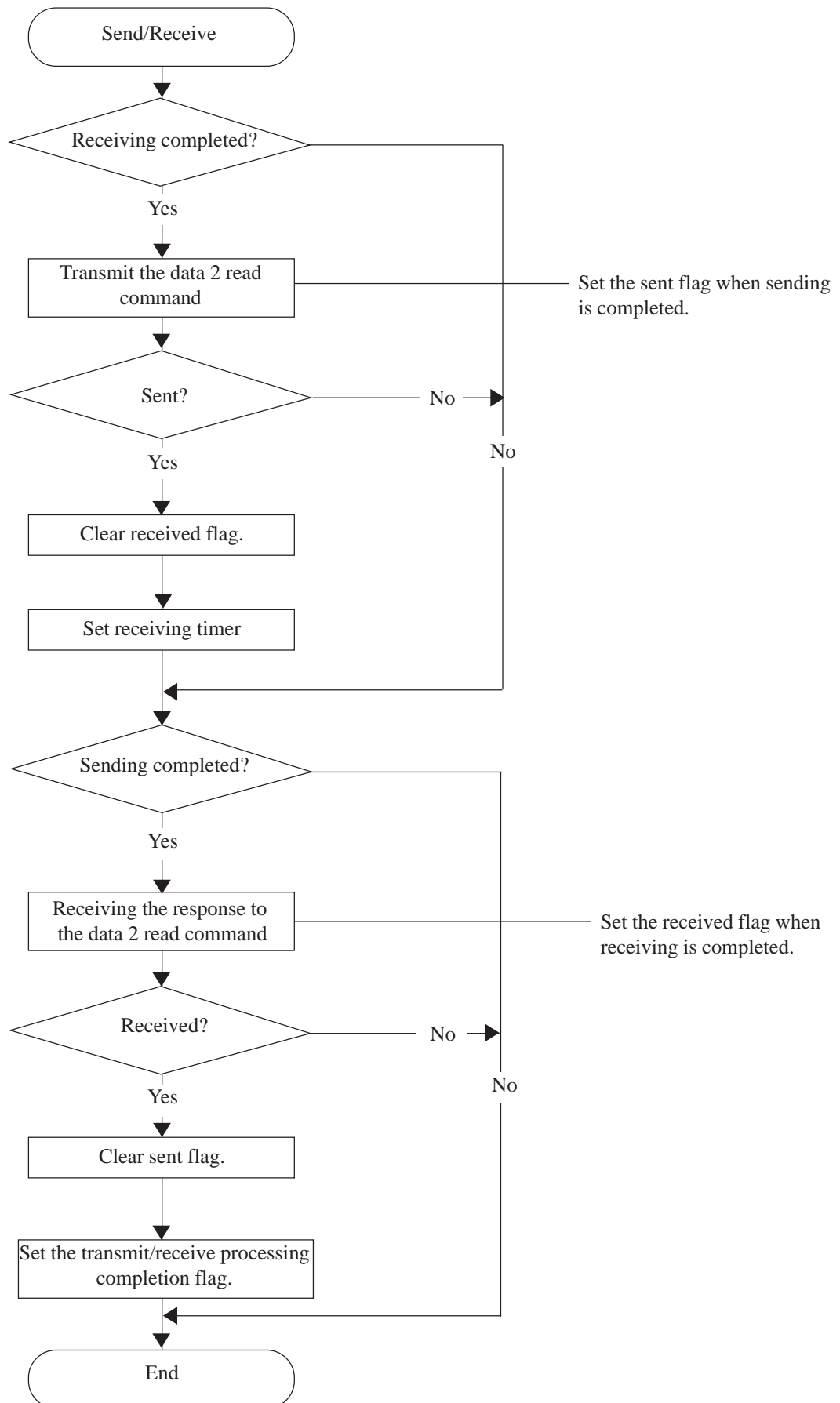

(6), (8) Flow chart of Transmit Function

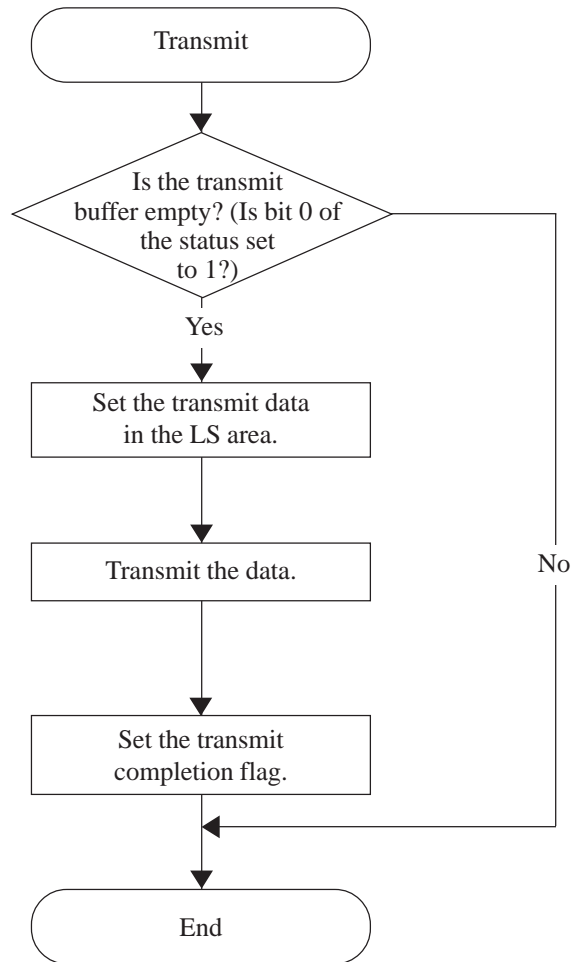

(7), (9) Flow chart of Receive Function

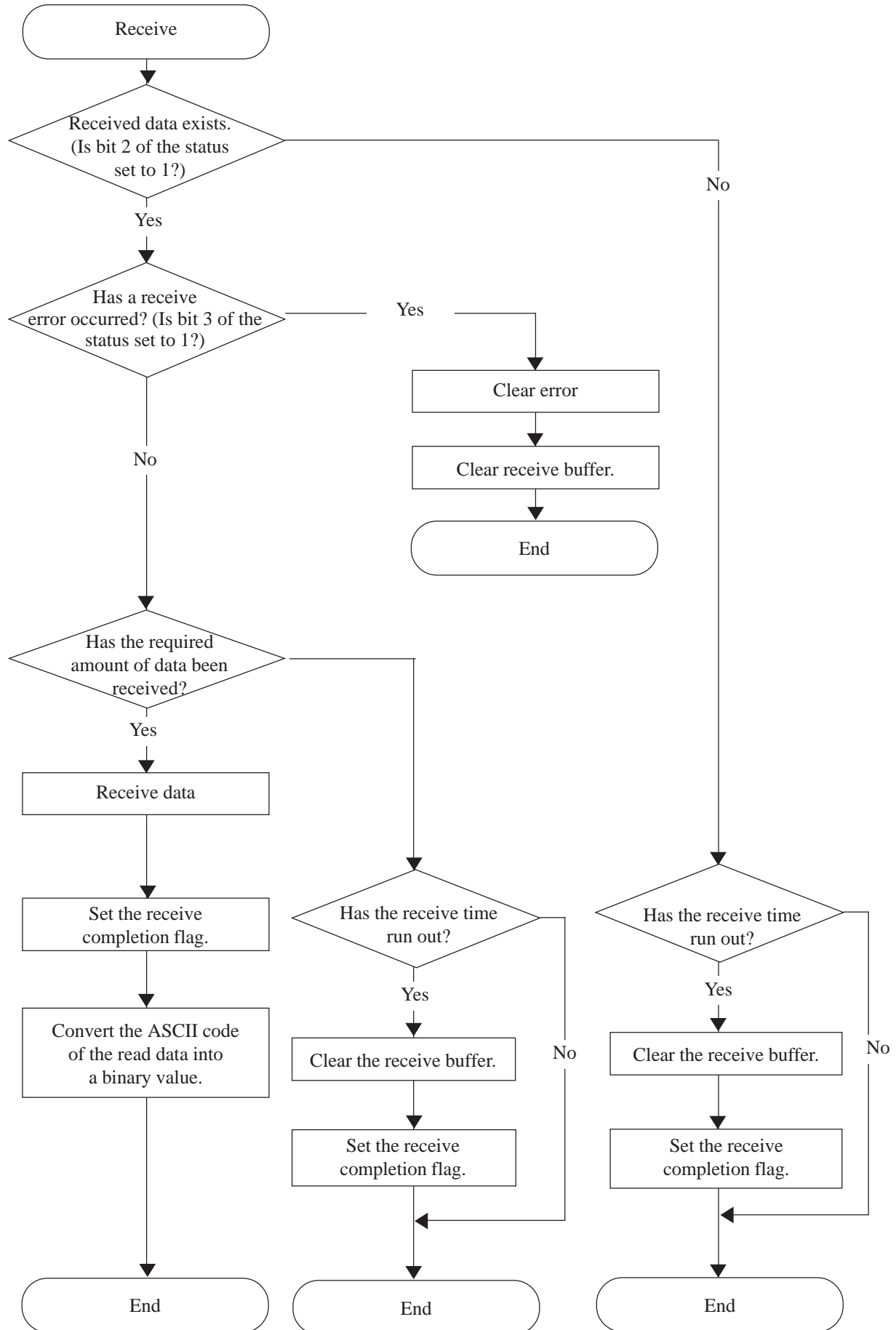

(1) Initialization of Extended SIO (D-Script executed only once)

```

[Trigger Formula]
  Detect bit start-up      Bit address    LS005000    //Trigger bit ON with T-tag

[Execution Formula]

  Determine whether extended SIO protocol is present.
  if([s:EXT_SIO_STAT15] == 1)
  {
    // Initialize the transmit/receive process
    [t:0000] = 0                // Clear sent flag.
    [t:0001] = 1                // Clear sent flag.
    [t:0002] = 0                // Clear the transmit/receive processing
                                completion flag.
    [t:0003] = 0                // Initialize receive timer
    [c:EXT_SIO_CTRL00] = 1      // Clear send buffer.
    [c:EXT_SIO_CTRL01] = 1      // Clear receive buffer.
    [c:EXT_SIO_CTRL02] = 1      // Clear error.

    [t:0010] = 0                // Initialize timer.
    [t:0011] = 0                // Which transmit/receive process
                                should be run first?

    [b:LS005100]= 1            // Set up the communication permission flag.
  }
  endif

```

(2) Main routine

```

[Trigger Formula]

Detect bit start-up      Bit address      LS203800      // Detect trigger with scan counter of tag.

[Execution Formula]
if([t:0010] == 0)          // Have 10 seconds passed?
{
    if([b:LS005100] == 1)          // Is communication permitted?
                                    (Has initialization completed?)
    {
        if([t:0011] == 0)          // In case of the data 1 read processing
        {
            Call COMM_READ1          // Run the data 1 read out processing
                                    (transmitting/receiving processing)

            if([t:0002] == 1)        // When the transmit/receive processing has been completed
            {
                [t:0002] = 0        // Clear the transmit/receive processing completion flag
                [t:0011] = 1        // Set the number of the transmit/receive process
                                    that is to be run next.
            }
        }
    }
}
endif

if([t:0011] == 1)          // In case of the data 1 read processing
{
    Call COMM_READ2          // Run data 2 read process
                                    (transmit/receive processing)

    if([t:0002] == 1)        // When the transmit/receive processing has been completed
    {
        [t:0002] = 0            // Clear the transmit/receive processing completion flag
        [t:0010] = 10          // Set the transmit/receive timer
        [t:0011] = 0            // Set the number of the transmit/receive process
                                    that is to be run next.
    }
}
endif
}
endif
}
endif
endif

```

(3) D-Script for Creating 10-second Timer

```

[Trigger Formula]

Timer function      1 second      // Execute every second.

[Execution Formula]

if([t:0010] > 0)
{
    [t:0010] = [t:0010] - 1      // Decrement every second.
}
endif

```

(4) Transmit/Receive Function 1 (COMM_READ1)

[Execution Formula]

```

if([t:0001] ==1)    // Has reception completed?
{
    Call TRANS_FUNC_R1    // Transmission of data 1 read command
    if([t:0000] ==1) // Has data 1 read command been transmitted?
        (Is the transmit completion flag set?)
        {
            [t:0001] =0    // Clear the receive completion flag.
            [t:0003] =10    // Set the receive timer.
        }
    endif
}
endif

if([t:0001] ==1)    // Has transmission completed?
{
    Call RCV_FUNC_R1    // Receiving the response to the data 1 read command
    if([t:0000] ==1) // Has data 1 read command been received?
        (Is the receive completion flag set?)
        {
            [t:0000] =0    // Clear the transmit completion flag.
            [t:0002] =1    // Set the transmit/receive processing completion flag.
        }
    endif
}
endif
endif

```

(5) Transmit/Receive Function 2 (COMM_READ2)

[Execution Formula]

```

if([t:0001] ==1)    // Has reception completed?
{
    Call TRANS_FUNC_R1    // Transmission of data 1 read command
    if([t:0000] ==1) // Has data 2 read command been transmitted?
        (Is the transmit completion flag set?)
        {
            [t:0001] =0    // Clear the receive completion flag.
            [t:0003] =10    // Set the receive timer.
        }
    endif
}
endif

if([t:0001] ==1)    // Has transmission completed?
{
    Call RCV_FUNC_R1    // Receiving the response to the data 1 read command
    if([t:0000] ==1) // Has data 2 read command been received?
        (Is the receive completion flag set?)
        {
            [t:0000] =0    // Clear the transmit completion flag.
            [t:0002] =1    // Set the transmit/receive processing completion flag.
        }
    endif
}
endif
endif

```

(6) Example of Service Request Command (Sending processing function: TRANS_FUNC_R1)

```
[Execution Formula]

if( [s:EXT_SIO_STAT00] == 1)                // Is send buffer empty?
{
// Set command output to extended SIO in LS area.
[w:LS0100]=0x02                            // STX
[w:LS0101]=0x30                            // Node No.
[w:LS0102]=0x31
[w:LS0103]=0x30                            // Sub-address
[w:LS0104]=0x30
[w:LS0105]=0x30                            // SID
[w:LS0106]=0x30                            // MRC
[w:LS0107]=0x31
[w:LS0108]=0x30                            // SRC
[w:LS0109]=0x31
[w:LS0110]=0x43                            // Variable type: C0
[w:LS0111]=0x31
[w:LS0112]=0x30
[w:LS0113]=0x30
[w:LS0114]=0x30
[w:LS0115]=0x33
[w:LS0116]=0x30                            // Bit position
[w:LS0117]=0x30
[w:LS0118]=0x30                            // Number of elements
[w:LS0119]=0x30
[w:LS0120]=0x30
[w:LS0121]=0x31
[w:LS0122]=0x03                            // ETX
[w:LS0123]=0x40                            // BCC

// Output to extended SIO.
IO_WRITE([p:EXT_SIO], [w:LS0100], 24)
[t0000]=1                                  // Set sent flag.
}
endif
```

(7) Example of Service Response Command (Receive Function: RCV_FUNC_R1)

```

[Execution Formula]

if([s:EXT_SIO_STAT02] == 1) // Received data is present.
{
    if([s:EXT_SIO_STAT03] == 1) // Receiving error occurred
    {
        [c:EXT_SIO_CNTRL02] = 1 // Clear error.
        [c:EXT_SIO_CNTRL01] = 1 // Clear receive buffer.
    }
    else
    {
        if( [r:EXT_SIO_RCV] >= 25) // Has necessary number of bytes of
            data been received?
        {
            IO_READ([p:EXT_SIO], [w:LS0200], 25) // Obtain received data.
            [t:0001] = 1 // Set received flag.

            Call ASC2BIN
            [w:LS2001]=[t=0024]
        }
        else
        {
            if([t:0003] == 0) // Has the receive time run out?
            {
                [c:EXT_SIO_CTRL01] = 1 // Clear receive buffer.
                [t:0001] = 1 // Set received flag.
            }
        }
    }
}
endif
}
endif
}
else
{
    if([t:0003] == 0) // Is the time for receiving run out?
    {
        [c:EXT_SIO_CTRL01] = 1 // Clear receiving buffer.
        [t:0001] = 1 // Set received flag.
    }
}
endif
}
endif

```

In this example, the value of the read data 1 is stored in the LS2001 address as a binary value.

(8) Example of Service Request Command (Send processing Function: TRANS_FUNC_R2)

```
[Execution Formula]

if( [s:EXT_SIO_STAT00] == 1)                // Is send buffer empty?
{
  // Set command output to extended SIO in LS area.
  [w:LS0100]=0x02                          // STX
  [w:LS0101]=0x30                          // Node No.
  [w:LS0102]=0x31                          // Sub-address
  [w:LS0103]=0x30                          // SID
  [w:LS0104]=0x30                          // MRC
  [w:LS0105]=0x30                          // SRC
  [w:LS0106]=0x30                          // Variable type: C1
  [w:LS0107]=0x31
  [w:LS0108]=0x30
  [w:LS0109]=0x31
  [w:LS0110]=0x43
  [w:LS0111]=0x31
  [w:LS0112]=0x30
  [w:LS0113]=0x30
  [w:LS0114]=0x30
  [w:LS0115]=0x33
  [w:LS0116]=0x30                          // Bit position
  [w:LS0117]=0x30                          // Number of elements
  [w:LS0118]=0x30
  [w:LS0119]=0x30
  [w:LS0120]=0x30
  [w:LS0121]=0x31
  [w:LS0122]=0x03                          // ETX
  [w:LS0123]=0x42                          // BCC

  // Output to extended SIO.
  IO_WRITE([p:EXT_SIO], [w:LS0100], 24)
  [t0000]=1                                // Set sent flag.
}
endif
```

(9) Example of Service Response Command (Receive Function: RCV_FUNC_R1)

```
[Execution Formula]

if([s:EXT_SIO_STAT02]== 1) // Received data is present.
{
    if([s:EXT_SIO_STAT03]== 1) // Receiving error occurred
    {
        [c:EXT_SIO_CNTRL02]= 1 // Clear error.
        [c:EXT_SIO_CNTRL01]= 1 // Clear receive buffer.
    }
    else
    {
        if( [r:EXT_SIO_RCV] >= 25) // Has necessary number of bytes of
            data been received?
        {
            IO_READ([p:EXT_SIO], [w:LS0200], 25) // Obtain received data.
            [t:0001]= 1 // Set received flag.

            Call ASC2BIN
            [w:LS2002]=[t=0024]
        }
        else
        {
            if([t:0003]== 0) // Has the receive time run out?
            {
                [c:EXT_SIO_CTRL01]= 1 // Clear receive buffer.
                [t:0001]= 1 // Set received flag.
            }
            endif
        }
    }
}
endif

}
endif

else
{
    if([t:0003]== 0) // Is the time for receiving run out?
    {
        [c:EXT_SIO_CTRL01]= 1 // Clear receiving buffer.
        [t:0001]= 1 // Set received flag.
    }
    endif
}
endif
```

In this example, the value of the read data 2 is stored in the LS2002 address as a binary value.

(10) Value Conversion Function (ASC2BIN)

```

[Execution Formula]

[t:0024]=0 // Converted binary value
[t:0025]=0 // Offset of read data
[t:0026]=0 // Work area for converting 1-digit

[t:0027]=4
loop([t:0027])
{
  [t:0026]=[w:LS0220]#[t:0025]

  if ([t:0026]>=0x30 and [t:0026]<=0x39)<=0x39)
    [t:0026]=[t:0026]-0x30
  }
  endif

  if ([t:0026]>=0x41 and [t:0026]<=0x46)<=0x46)
    [t:0026]=[t:0026]-0x41+0xA
  }
  endif

  [t:0024]=[t:0024]<<4
  [t:0024]=[t:0024] | [t:0026]

  [t:0025]=[t:0025]+1
}endloop

```

This Processing Function converts the low-order 4 bytes of the 8-byte data. This function cannot convert a negative value. Therefore, create a negative value conversion function, if required.

- Results of D-Script execution

The following response commands will be set in the LS area when the D-Script is executed.

LS area address	Response command	Contents
LS0200	0x19	Number of bytes of received data
LS0201	0x02	STX
LS0202	0x30	Node No.
LS0203	0x31	
LS0204	0x30	Sub-address
LS0205	0x30	
LS0206	0x30	End code
LS0207	0x30	
LS0208	0x30	MRC
LS0209	0x31	
LS0210	0x30	SRC
LS0211	0x31	
LS0212	0x30	Response code
LS0213	0x30	
LS0214	0x30	
LS0215	0x30	
LS0216	0x30	
LS0217	0x30	
LS0218	0x30	When readout data is 5,
LS0219	0x30	
LS0220	0x30	
LS0221	0x30	
LS0222	0x30	
LS0223	0x35	
LS0224	0x03	ETX
LS0225	0x07	BCC

3.2 Extended SIO Script

3.2.1 Overview

- The Extended SIO Script described in this section is a D-Script dedicated to communication between the Extended SIO (extended serial interface) built into the GP and the I/O device connected to the GP.
- This function is supported only by GP2000 Series units.
- Extended SIO Script functions as a program effective in all screens in the project, regardless of the current screen.
- Extended SIO Script differs from D-Script/Global D-Script and works as a program independent of the tag processing on the screen. As a result, Extended SIO Script has no effect on the tag processing taking place on the screen.
- Since Extended SIO Script works independently of the tag processing, tag processing will not stop even if there is an infinite loop within the script.
- Only an LS Area can be specified for an Extended SIO Script's Device address . Therefore, there is no limit to the number of devices that can be specified.
- Data transmission and reception is done via an Extended SIO Script BYTE type (8-bit) data buffer. Therefore, the ASCII communication protocol can be easily created.
- String control allows the following operations to be easily performed:
 - Directly entering a string (`_strset` function)
 - Concatenation of data to be sent (`_strcat` function)
 - Length of the data to be sent (in bytes) (`_strlen` function)
 - Retrieving the necessary part from the data (`_strmid` function)
 - Converting a string to an integer (`_decasc2bin` function, `_hexasc2bin` function)
 - Converting an integer to a string (`_bin2decasc` function, `_bin2hexasc` function)
 - Copying the data buffer contents into the LS Area (`_dlcopy` function)
 - Copying the LS Area contents into the data buffer (`_ldcopy` function)
- Directly sending and receiving the contents of the data buffer (`_IO_WRITE_EX` function, `_IO_READ_EX` function).
- Supports the wait function. When waiting to receive data, it is necessary to perform successive operations after waiting for a fixed period of time.

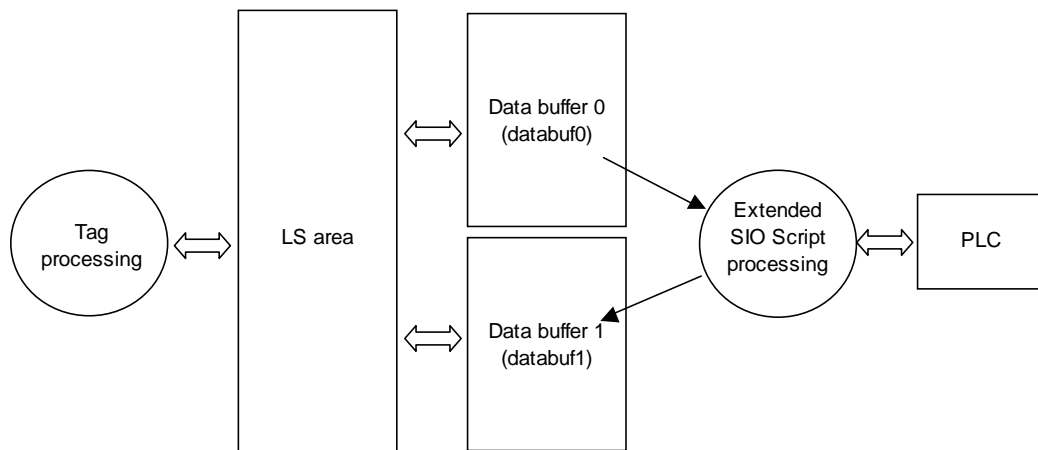

When the Extended SIO Script is combined with the Serial I/F Switch function, the following operations become possible:

- In order to use the RS-422 via the Serial I/F (COM1), a multidrop connection with the PLC is possible depending on the Extended SIO Script protocol.
- For a GP2000 series unit that is not equipped with Extended Serial I/F (COM2), similar communication is possible depending on the Extended SIO Script protocol.

Reference *GP-PRO/PBIII Operation Manual 4.2.8 Changing Extended SIO Type*



When using Extended SIO Script, be sure to select “Extend SIO Script” within the “Project Manager | Extend SIO Settings” menu.

3.2.2 Details

- Execution statements include Constant/Address, Draw, Memory Operation, SIO Port Operation, Bit Operation and String Operation.
- The temporary addresses of D-Scripts and Global D-Scripts are managed independently from the temporary address of Extended SIO Scripts. Therefore, changes made to the temporary addresses of D-Scripts and Global D-Scripts will not be reflected in the temporary address of Extended SIO Scripts.
- Custom functions created with D-Script or Global D-Script can be called up; however, the device address will not function even when it is accessed in the function.
In addition, when transferred (during the creation of data for the GP), the custom functions will be created independently for D-Scripts, Global D-Scripts, and Extended SIO Scripts.
- Since Extended SIO Script is a language-based program, programming can be performed with relative ease.
- The syntax check function enables a syntax check while writing the program.
- To enhance programming efficiency, the syntax auxiliary function enables the display of a pop-up keyboard on the screen for address entries.
- Program commands can be entered by clicking on icons.
- Extended SIO Script executes the process via dedicated data buffers. To display the contents of the data buffers with the Numeric Display parts, store the data in the LS device
- When calling a function from a function, the maximum number of levels (nesting) is 9.
- Up to 254 functions can be called. (The number of functions available with "Call" is 254.)
- Extended SIO Script does not affect the count of tags.
- Functions supported only by Extended SIO Script, for example string operations, will not function if called with D-Script or Global D-Script.
- The available data format is Bin. BCD data format is disabled.
- The sizes of the Send buffer and Receive buffer are 2048 and 8192 bytes, respectively. If the amount of data received is 80% or more of the Receive buffer size, the ER Signal (Output) and the RS Signal (Output) will be turned off.
- General SIO protocol and Extended SIO Script cannot be selected simultaneously. The following table shows more information about combinations.

Extended SIO Setting	Extended SIO function for D-Script/ Global D-Script	Extended SIO function for extended SIO Script
General SIO Protocol	○ (Operation enabled)	x (Operation disabled)
Extended SIO Script	x (Operation disabled)	○ (Operation enabled)

- Notational conventions for the character string setting
When using character strings with "_strset ()" and other functions, enclose the character string in double quotation marks (""). To display double quotation marks in the character strings, append the "\" symbol and express as [\""]. There is no way to represent a single "\" symbol. When necessary, use the character code format setting (_strset (databuf0, 92)).

Example:

```
"ABC\DEF"    →   ABC"DEF
"ABC\DEF"    →   ABC\DEF
"ABC\\"DEF"   →   ABC"DEF
"ABC\\"DEF"   →   ABC\\DEF
```

◆ Extended SIO Script Errors

The following error message is displayed when an Extended SIO Script is configured incorrectly.

	Error Message
Extended SIO Script	Extended SIO Script Error (***)

The following table lists the numbers assigned to (***) in the above error messages. Error No. 001 is displayed at power-on, and Error Nos. 003 and 004 are displayed when an error occurs during the function processing.

No.	Description
001	The total number of the Functions of Extended SIO Scripts exceeds the limit. The maximum number of Extended SIO Scripts is 254.
003	The function that is being called does not exist.
004	Functions cannot be nested more than 10 levels.
005	An old Extended SIO Script protocol is being used for the GP system. Extended SIO Script cannot be run when this error occurs. Be sure to run a new Extended SIO protocol (Version 1.12 or later).
006	An incompatible function was found in the screen data's Extended SIO Script. Be sure to run a new GP system.

- ◆ The following table shows the sizes of the dedicated buffers for Extended SIO, databuf0, databuf1, databuf2, and databuf3.

Buffer	Buffer Name	Size
Data buffer 0	databuf0	1 KB
Data buffer 1	databuf1	1 KB
Data buffer 2	databuf2	1 KB
Data buffer 3	databuf3	1 KB



Never use Extended SIO Script functions to control machines and operations that may result in either human injury or serious product damage.

3.2.3 Setting Parameters

Extended SIO Script Editor

In the Screen Editor's "Special" menu, select "Extended SIO Script".

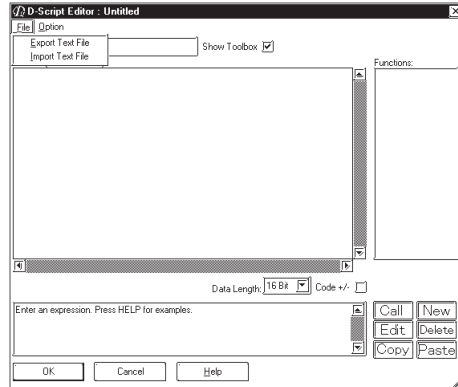

Import Text File

Imports an Extended SIO Script that has been output as a text file.

Export Text File

Exports an Extended SIO Script as a text file.

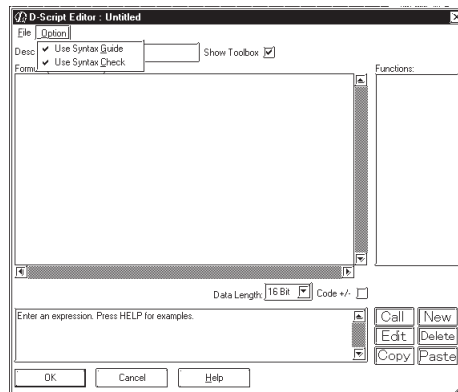

Use Syntax Guide

When writing a program, use this function to input an address in the proper format for the execution program. To display the "Input Address" dialog box on the screen, enter the left bracket "[" of the address with the keyboard. Select the desired address type, and enter the address.

Use Syntax Check

The syntax check is performed simultaneously as the program is being written. The result of the check is displayed in the display window.

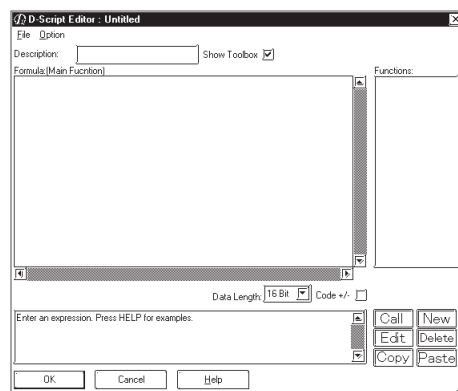

Description

Up to 20 single-byte characters (or 10 double-byte characters) can be entered here as a description of the Extended SIO Script.

Toolbox

When this option is selected, a toolbox appears containing Commands, Statements, and Constants for use in creating Extended SIO Script programs.



Important

When an Extended SIO Script's command follows another Extended SIO Script's command, enter a space between these commands.

For example, if the "not" command follows the "and" command, spacing is needed between the commands.

"andnot": Incorrect (The operation will not be performed and an error message will display on the message window.)

"and not": Correct

An error message will be displayed on the message window if the statement includes errors.

◆ **Functions**

With the Extended SIO Script Editor, you can create "Functions", which can be used on the same screen or on after screens.

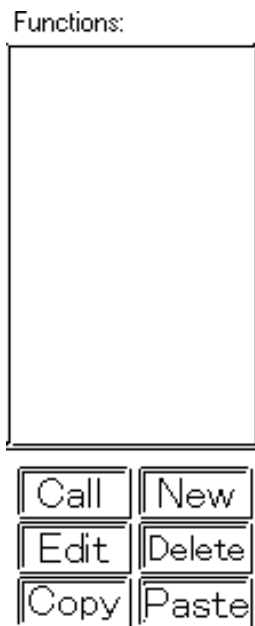

Call

Select a Function name to be loaded and then click on this button. The Function name will be displayed in the formula area.

Edit

Select a Function name to be edited and then click on this button.

▼ **Reference** ▲ For how to edit program, refer to the D-Script Editor.

Delete

Click on this button to delete the created Function. First, select a Function name to be deleted and then click on the Delete button.

Copy

Any selected function can be copied.

Paste

Use this command to paste a copied function. Click on this button and the following dialog box will appear. Then, enter the name for the function to be pasted.

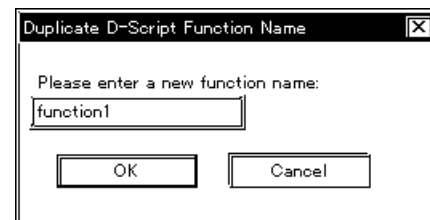

New

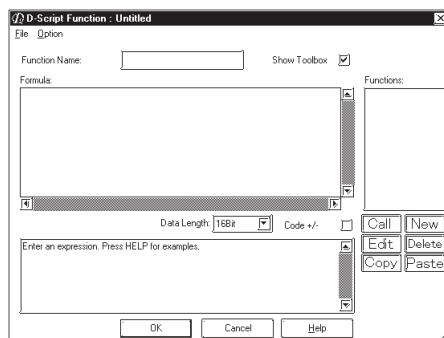

Select this button to create a new program (Function). A program can then be created via the Extended SIO Script Functions that appear. (See below.)

▼ **Reference** ▲ For how to create a new program, refer to the D-Script Editor.

Function Name

Enter the name of your Function here. Once a Function is created, that Function name is displayed in the Function area. Up to 20 characters can be used for a Function name. (Alphabet characters, numbers, and “_”)



The following function names are reserved. **DO NOT** use these names.

“rise”, “fall”, “rise_expr”, “timer”, “set”, “clear”, “toggle”, “if”, “else”, “endif”, “b_call”, “Bcall”, “dsp_rectangle”, “dsp_line”, “dsp_dot”, “dsp_circle”, “dsp_arc”, “Call”, “and”, “or”, “not”, “memcpy”, “memset”, “loop”, “break”, “IO_READ”, “IO_WRITE”, “_memcpy_EX”, “_memset_EX”, “IO_READ_EX”, “IO_WRITE_EX”, “IO_READ_WAIT”, “databuf0”, “databuf1”, “databuf2”, “databuf3”, “_strset”, “_dlcopy”, “_hexasc2bin”, “_decasc2bin”, “_bin2hexasc”, “_strlen”, “_strcat”, “_strmid”, “_wait”, “return”

■ D-Script Toolbox

◆ Statements

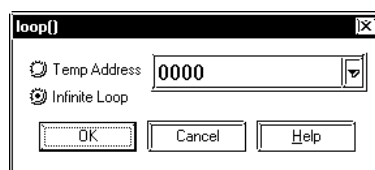
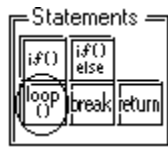
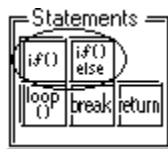

if() if-endif

When a condition enclosed with brackets “()” becomes true, the process following the “if ()” statement is executed. The Assign “=” character cannot be used in a conditional expression.

if()else if-else-endif

When a condition enclosed with brackets “()” becomes true, the process following the if “()” statement is executed. When the condition is false, the statement after “else” is executed. The Assign “=” cannot be used in a conditional expression.

loop() loop-endloop

Loop (repetitive) processing is repeated according to the number stored in the temporary Addresses designated in the brackets “()”.

Infinite Loop

The loop operation is set to infinite loop when the “Infinite Loop” option is selected, or when no statement is entered in the bracket () for the “loop ()” statement.

Example statement

```
loop ()
{
  [w:LS0100]=[w:LS0100] + 1
  if ([w:LS0100] > 10)
  {
    break
  }
end if
}
end loop
```



- The loop() format is as follows:

E.g. loop (number of loops)<= Designates the temporary Address where the loop repetition number is designated.

```
{
  Mode equation
  break      <=   Stated when escaping from the loop halfway (can be omitted)
} endloop   <=   Stated at the end of the loop
```

- Only a temporary Word Address can be entered (in the parentheses). (e.g.: loop ([t:0000]))



- **“loop()” cannot be used in a trigger equation.**
- **The temporary Word Address value used to designate the “Infinite Loop” will decrease every time loop operation is performed. When the value changes to 0, the loop’s operation is finished. If the temporary Word Address value designated for the “Infinite Loop” is modified, the loop will become endless. Also, the temporary Word Address used is designated as Global. Therefore, simultaneously using this temporary Word Address for another item means the loop’s operation may be performed forever.**
- **When statement “loop ()” is used, the loop operation is infinite.**
- **loop() can also be nested. When it is nested, the inner-most loop() will be skipped via the “break” command.**

```
loop ([t:0000])//loop 1
{
  loop ([t:0001])//loop 2
  {
    break// Escape from loop 2
  } endloop
} endloop
```

break// Escape from loop 1

- **If loop operation is finished without using the escape command, the temporary Word Address value becomes 0.**
- **The range available for the temporary Word Address value will differ depending on the data format (Bin, BCD), bit length, and code +/- used. If code +/- has been designated and the temporary Word Address becomes a negative value, the condition is judged at the beginning of the loop and the loop processing stops.**
- **Using “loop” or “break” a variable name for a D-Script variable will cause an error.**

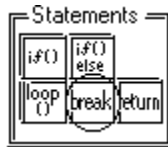
**break**

Halts loop operation while the loop() equation is being executed.

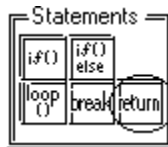

The "break" command can be used only in the { } section of loop().

**return**

- ◆ When the Function includes "return"
The processing of the Function is terminated and the control returns to the caller of the Function.

- ◆ When Execution (main Function) includes "return"

The processing of the main Function is aborted for the moment, and is restarted from the start of the main Function.

Example statement

```
[w:LS0100]=([w:LS0200]>>8) & 0xFF
```

```
if ([w:LS0100]==0) // When LS0100
                    // is "0", process-
                    // ing is no longer
                    // executed.
```

```
{
set ([b:LS005000]) // Turn on the L-
                    // tag trigger bit
                    // for error mes-
                    // sage display.
```

```
return // End
```

```
}
end if
```

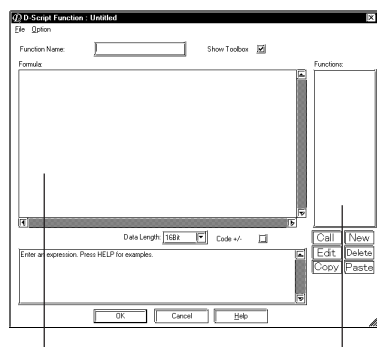

main Function

Function

◆ Math (Operators)

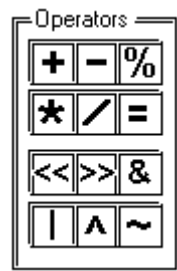
**+ (Addition)**

Adds the data in two word addresses, or the data in a word address and a constant. Any overflowing digits resulting from the operation are rounded.

- (Subtraction)

Performs subtraction on the data in two word addresses, or the data in a word address and a constant. Any overflowing digits resulting from the operation are rounded.

% (Remainder)

Detects a remainder of a division performed on the data in two word addresses, or the data in a word address and a constant. The operation result may depend on the sign of the left and right sides.

*** (Multiplication)**

Multiplies the data in two word addresses, or the data in a word address and a constant. Any overflowing digits resulting from the operation are rounded.

/ (Division)

Performs division on the data in two word addresses, or the data in a word address and a constant. Decimal places and overflowing digits resulting from the operation are rounded.

= (Assign)

Assigns the right side value in the left side. The left side can state a device address only, while the right side can describe both a device address and a constant. Any overflowing digits resulting from the operation are rounded.

<< (Shift Left)

Shifts the data on the left side to the left by the number on the right side. This feature supports logical shifts only.

>> (Shift Right)

Shifts the data on the left side to the right by the number on the right side. This feature supports logical shifts only.

◆ Comparisons

**Boolean and (AND: Conjunction)**

ANDs the right and left sides. Value 0 (zero) is regarded as OFF, and other values, as ON. “N1 and N2” is true if both N1 and N2 are ON, and false if otherwise.

or (OR: Disjunction)

ORs the right and left sides. Value 0 (zero) is regarded as OFF, and other values, as ON. “N1 or N2” is true if either N1 or N2 is ON, and false if otherwise.

not (NOT: Negation)

NOTs the right side. Value 0 (zero) is regarded as 1, and other values, as 0. “not N1” is 0 if N1 is 1, and 1 if N1 is 0.

< (Smaller than)

Compares the data in two word addresses, or the data in a word address and a constant. The result is true if N1 is smaller than N2 ($N1 < N2$).

<= (Equal to or smaller than)

Compares the data in two word addresses, or the data in a word address and a constant. The result is true if N1 is equal to or smaller than N2 ($N1 \leq N2$).

<> (≠) (Not equal)

Compares the data in two word addresses, or the data in a word address and a constant. The result is true if N1 is not equal to N2 ($N1 \neq N2$).

> (Greater than)

Compares the data in two word addresses, or the data in a word address and a constant. The result is true if N1 is greater than N2 ($N1 > N2$).

>= (Equal to or greater than)

Compares the data in two word addresses, or the data in a word address and a constant. The result is true if N1 is equal to or greater than N2 ($N1 \geq N2$).

== (Equal)

Compares the data in two word addresses, or the data in a word address and a constant. The result is true if N1 is equal to N2 ($N1 = N2$).

Command		Example
Conjunction	and	if [(Arithmetic expression) and (Arithmetic expression)]
Disjunction	or	if [(Arithmetic expression) or (Arithmetic expression)]
Negation	not	if [not (Arithmetic expression)]
Smaller than	<	<Term1><<Term2>
Equal to or smaller than	<=	<Term1><=<Term2>
Not equal	<>	<Term1><><Term2>
Greater than	>	<Term1>><Term2>
Equal to or greater than	>=	<Term1>>=<Term2>
Equal	==	<Term1>==<Term2>

◆ Constant/Address

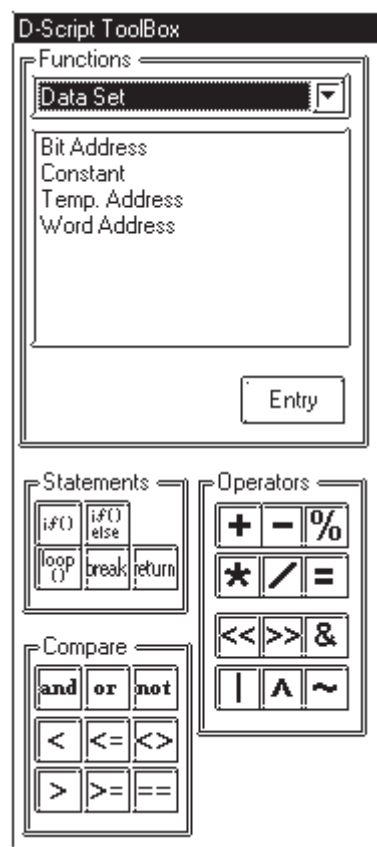

temp (temporary work address)

Here, a GP internal Address is specified that can be used with the program. With GP2000 series units, there are 90 words (from 0000 to 0089) available for Temporary Work Address. The Temporary Work Address's initial value is not fixed.

bit (address)

Enter a bit address.

word (address)

Enter a word address.

Constant

Select a constant.



Note: To identify data via the input data's format:

E.g.

Decimal: A numeric value without leading zeros →100

Hexadecimal: A numeric value preceding by 0x →0x100

Octal: A numeric value preceding by a zero →0100

• Calculation examples in hexadecimal and BCD formats

Hexadecimal format only

0x270F & 0xFF00 The result is 0x2700

◆ Draw

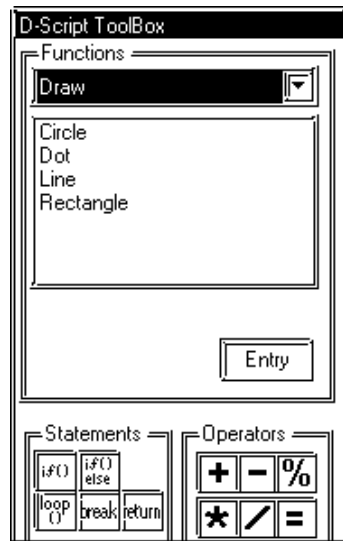

Circle

Draws a circle at the designated point. When the Pattern check box is checked, a filled circle will be drawn.

Select and enter the line type (or fill pattern when selecting a pattern), color attributes, center coordinates, and radius value.

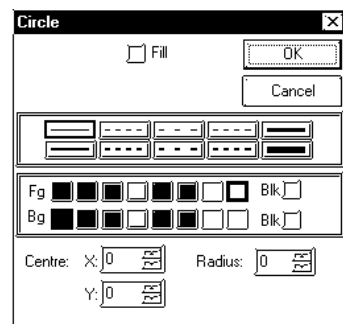

Square/Rectangle

Draws a square at the designated position. When the Pattern check box is checked, a filled square will be drawn. When selecting a beveled square, a beveling dot can be entered. Select and enter the line type (or fill pattern when selecting a pattern), color attributes, and start and end coordinates.

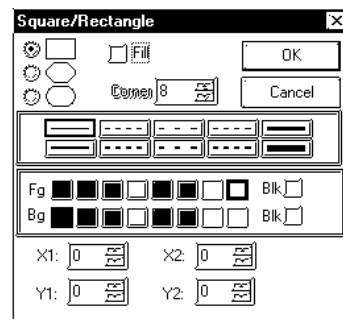

Polyline

Draws a line at the designated position. Designate the line's type, color attributes, and start and end coordinates.

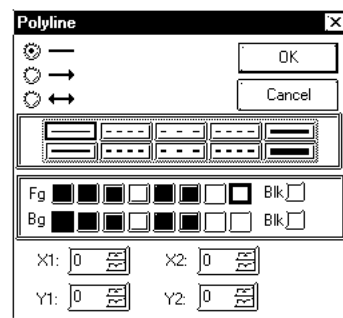

Dot

Draws a dot at the designated point. Designate a dot type, its X,Y coordinates, and its display color. 2, 3, and 5 dot groups cannot be selected.

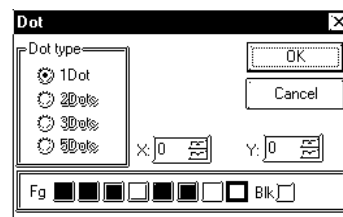

◆ Memory Control

<Offset Address>

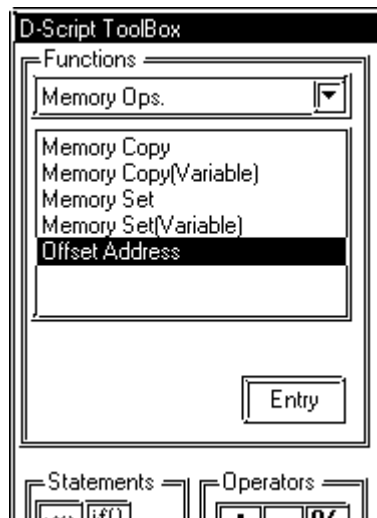

Offset Addresses

Offset Addresses can be designated. Only temporary Word Addresses can be designated for offset value storage Addresses.

Format:

[Word Address] # [Offset Value Storage Address]

<Constant Data Entry Ranges>

Data Format	Constant Entry	
	Min. Value	Max. Value
Bin16	0	65535
Bin32	0	4294967295
Bin16+/-	-32768	32767
Bin32+/-	-2147483648	2147483647

E.g. Read [w:LS0200] = [w:LS0100] # [t:0000]
(Offset Word Address Read)

Write [w:LS0100] # [t:0000] = 100
(Offset Word Address Write)

This Address becomes the Word Address + Temporary Word Address value. For the above example, when the value “2” is used for [t:000], the Address becomes [w:LS0102].

<Memory Copy>

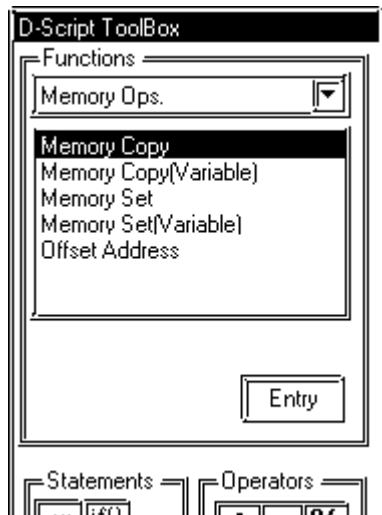

Memory Copy “memcopy”

Copies device memory all at once. Data for the number of Addresses will be copied to the copy destination Word Addresses beginning from the copy original Word Address. The number of Addresses effective is 1 to 640.

Format:

memcopy ([Copy destination Word Address], [Copy original Word Address], the number of Addresses)

Example statement:

When copying data of LS0100 to LS0109 to LS0200 to LS0209
 memcopy ([w:LS0200], [w:LS0100], 10)

< Memory Copy (memcopy) >



- **When the data are written to the LS Area with the Memory Copy (memcopy) function, the data can be written only in the User area. Data cannot be written into the System Data area (LS0000 to LS0019), Special area (LS2032 to S2047), or Reserved area (LS2048 to LS2095). However, data can be read out from these areas.**
- **If the original and destination data ranges overlap, all overlapping data will be rewritten as follows:**

**E.g.: When copying “LS101 to LS104” to “LS100 to LS103”
 (Data is copied to a smaller number Address)**

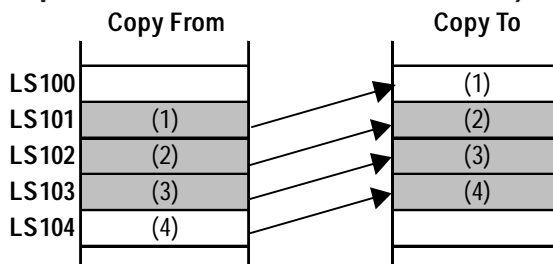

**E.g.: When copying “LS100 to LS103” to “LS101 to LS104”
 (Data is copied to a larger number Address)**

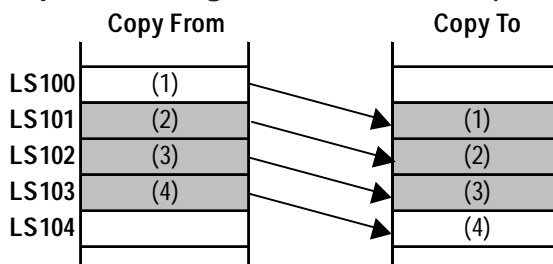

<Memory Copy (Variable)>

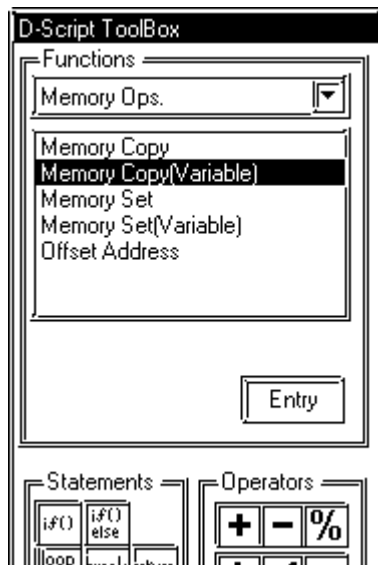

Extended Memory Copy (_memcpy_EX)

Copies the memory in the device in one operation.

The data of addresses specified with Parameter 3 are copied from the source (copy from) word address specified with Parameter 2 to the destination (copy to) word address specified with Parameter 1.

The valid range of the number of addresses is between 1 and 640.

With the "_memcpy_EX" function, the source address, destination address, and number of addresses can be designated indirectly.

Format:

_memcpy_EX ([destination word address], [source word address], number of addresses)

Parameter 1: Device address + Temporary address

Parameter 2: Device address + Temporary address

Parameter 3: Numerical value, LS Area, Temporary address (The valid range for Parameter 3 is between 1 and 640.)

Example statement:

```
[t:0000] =10
[t:0001] =20
[w:LS0050] =5
_memcpy_EX([w:LS0100]#[t:0000],
[w:LS0100]#[t:0001], [w:LS0050])
```

In the example above, five words of data will be read out from LS0120 and written into LS0110 to LS0114.



When the range of the source address and destination address overlaps, the overlapping data will be rewritten as follows.

E.g.: When copying "LS101 to LS104" to "LS100 to LS103"
(Data is copied to a smaller number Address)

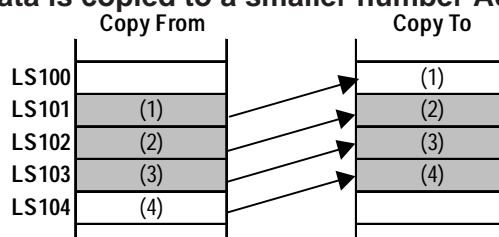

E.g.: When copying “LS100 to LS103” to “LS101 to LS104”
(Data is copied to a larger number Address)

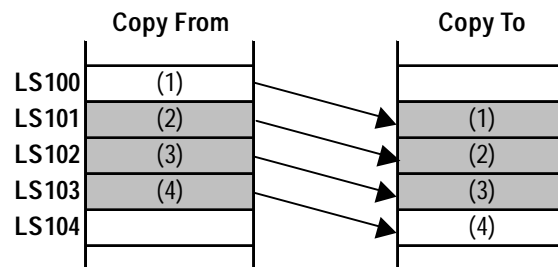

<Memory Set>

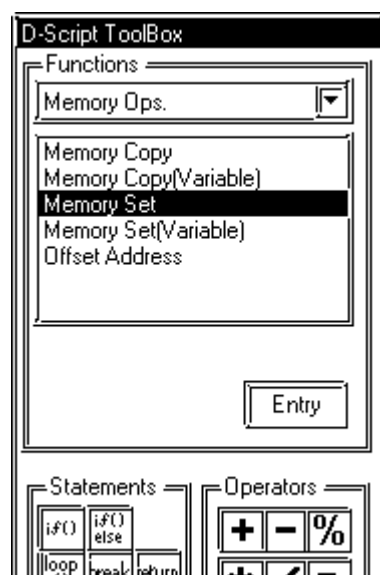

Memory Set (memset)

This feature initializes all devices at once. Setting data for the number of Addresses is taken from the Set Word Address. The allowable range of Addresses is from 1 to 640.

Format:

memset ([Set Word Address], set data, number of Addresses)

Example statement:

When “0” is set to addresses LS0100 to LS0109 - memset ([w:LS0100], 0, 10)



Important

< Memory Set (memset) >

When writing data to the LS Area with the Memory Reset (memset) function, the data can be written only into the User area. Data cannot be written into the System Data area (LS0000 to LS0019), Special area (LS2032 to S2047), or Reserved area (LS2048 to LS2095).

<Memory Set (Variable)>

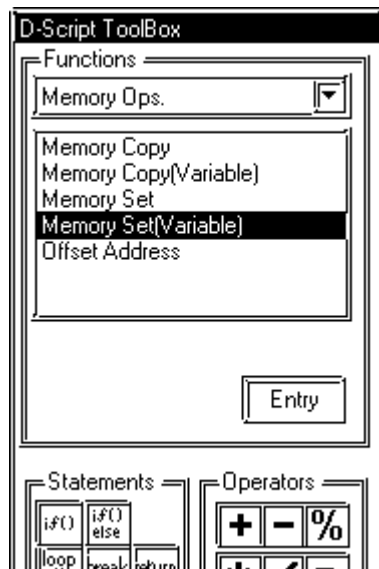
**Memory Set (_memset_EX)**

Initializes the device in one operation.

The Set data specified with Parameter 2 are set from the Set Word Address specified with Parameter 1 into the addresses specified with Parameter 3.

The valid range for the number of addresses is between 1 and 640.

The Set Word Address, Set data, and number of addresses can each be designated indirectly.

Format:

`_memset_EX ([Set Word address], Set Data, number of addresses)`

Parameter 1: Device address + Temporary address

Parameter 2: Device address + Temporary address

Parameter 3: Numerical value, LS Area, Temporary address (The valid range for Parameter 3 is between 1 and 640.)

Example statement:

```
[t:0000] =10,
```

```
[w:LS0050] =0
```

```
[w:LS0051] =5
```

```
_memset_EX([w:LS0100]#[t:0000],  
[w:LS0050], [w:LS0051])
```

In the example above, "0" will be written into the five words from LS0100 to LS0114.



- Note:**
- The reserved bits may be assigned in the future. Therefore, be sure to check only the necessary bits.
 - Two types of transmission errors exist: the transmission timeout error and the transmission buffer-full error. When either of the two errors occurs, the transmission error bit turns ON. The transmission timeout period is five seconds.
 - There are four types of receive errors: parity error, overrun error, framing error, and overflow. When one of these four errors occurs, the bit for the receive error turns ON. The period of the transmission timeout is five seconds.

◆ Label Setting EXT_SIO_RECV

Received Data Size (number of bytes)

Shows the quantity of data (number of bytes) that has been received at that time.

The received data size is a read-only feature.

Format:

[r:EXT_SIO_RECV]

Example statement:

if ([r:EXT_SIO_RECV]>=10)



- **Label name of the Received Data Size (number of bytes)**
With the GP-PRO/PB III V. 6.0 and earlier models, the Label name designated for the received data size is [r: EXT_SIO_RCV]. However, you are not required to revise the description because the function will be the same whether [r: EXT_SIO_RCV] or [r: EXT_SIO_RECV] expression is selected.

<SIO_Receive>

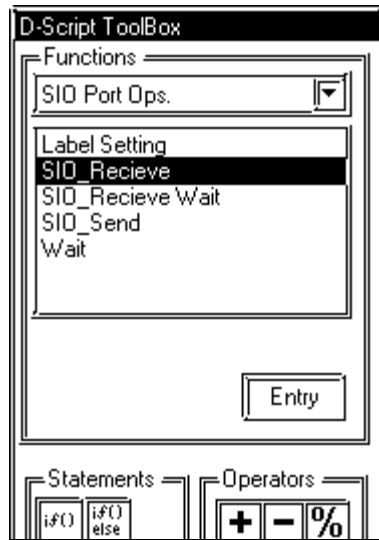

Receives data of the size indicated in Received Data Size (bytes) from the Extended SIO and stores it in the data buffer.

- Parameter 1: [p: EXT_SIO]
- Parameter 2: Data buffer
- Parameter 3: Numerical value, LS area, Temporary address (The valid range for Parameter 3 is between 1 and 1024.)

The number of bytes specified with Parameter 3 is received from the Extended SIO and stored in the data buffer specified with Parameter 2.

Example statement:

```
IO_READ_EX([p: EXT_SIO], databuf1, 10)
```

In the above example, 10 bytes of data in the data received by the Extended SIO are received and stored in "databuf1".

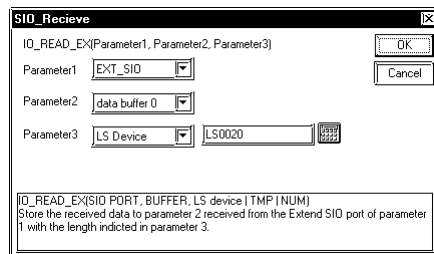

<SIO_Send>

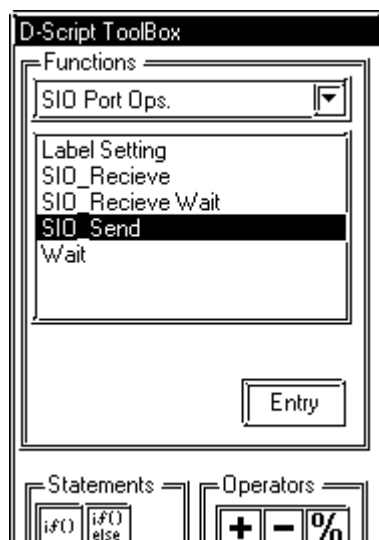

Sends the data in the data buffer with Extended SIO according to the size of Send Data Size (bytes).

- Parameter 1: [p: EXT_SIO]
- Parameter 2: Data buffer
- Parameter 3: Numerical value, LS area, Temporary address (The valid range for Parameter 3 is between 1 and 1024.)

The contents of the data buffer specified with Parameter 2 are sent from Extended SIO by the length specified with Parameter 3.

Example statement:

```
IO_WRITE_EX([p: EXT_SIO], databuf0, 10)
```

In the example above, 10 bytes of data in "databuf0" are sent from Extended SIO.

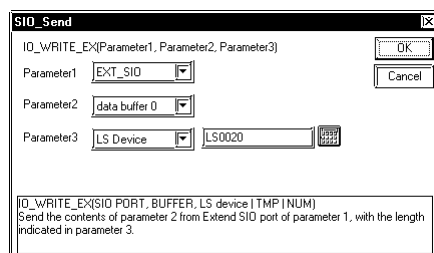

<SIO-Receive Wait>

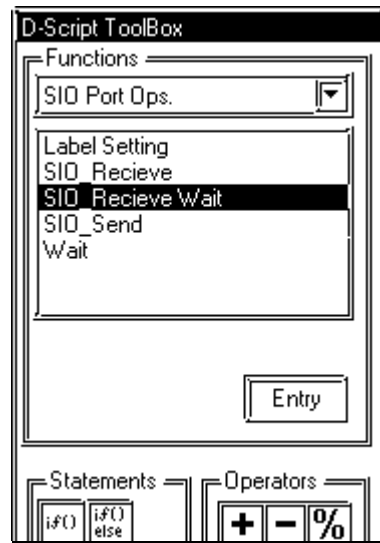

The system is in standby receive mode until it receives specified strings. After the timeout period has expired, Bit 4 (Receive time-out error) of Status [s: EXT_SIO_STAT] is set. The timeout duration can be set in 100-msec increments.

The system is in standby receive mode until it receives the character string or character code specified with Parameter 2. Configure the timeout duration with Parameter 3.

- Parameter 1: [p: EXT_IO]
- Parameter 2: Numerical and text string, Data buffer
- Parameter 3: Numerical values, LS area, Temporary address
(The valid range for Parameter 3 is between 1 and 600.)

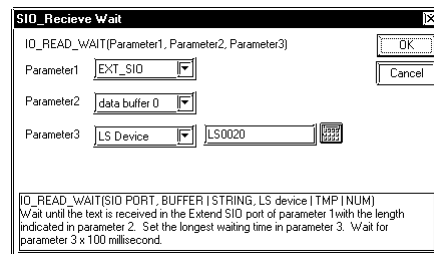

- **The received data cannot be used until the specified string is received. (Otherwise, the data are abandoned.)**
- **Up to 128 characters (bytes) can be specified. Note that the standby receive operation cannot be performed successfully when strings exceeding the limit are specified.**

<SIO-Receive Wait>

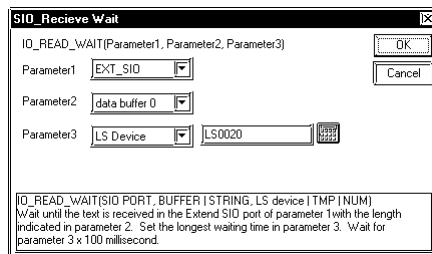
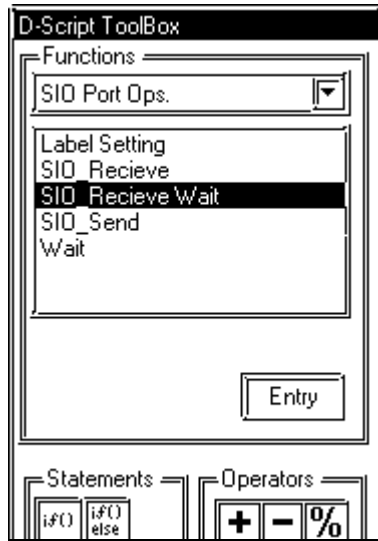

The system is in standby receive mode until it receives specified strings. After the timeout period has expired, Bit 4 (Receive time-out error) of Status [s: EXT_SIO_STAT] is set. The timeout duration can be set in 100-msec increments.

The system is in standby receive mode until it receives the character string or character code specified with Parameter 2. Configure the timeout duration with Parameter 3.

Parameter 1: [p: EXT_IO]

Parameter 2: Numerical and text string, Data buffer

Parameter 3: Numerical values, LS area, Temporary address (The valid range for Parameter 3 is between 1 and 600.)



- **The received data cannot be used until the specified string is received. (Otherwise, the data is destroyed.)**
- **Up to 128 characters (bytes) can be specified. Note that the standby receive operation cannot be performed successfully when strings exceeding the limit are specified.**

<Wait>

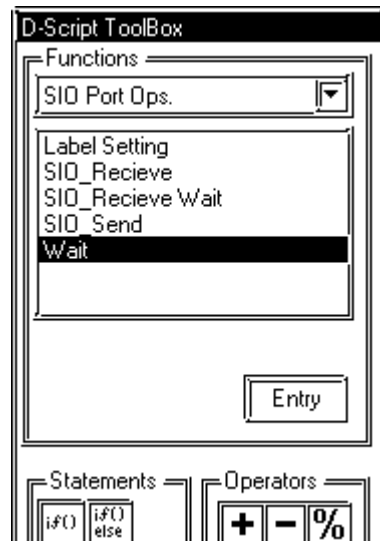

The system waits (suspends operation) for the specified period of time until it executes the process. The time can be configured in 100-msec increments.

Parameter 1: LS area, Temporary address, integer value
(The valid range for Parameter 3 is between 1 and 600.)

Example statement:

`_wait (10)`

In the example above, the system waits one second before executing the process.

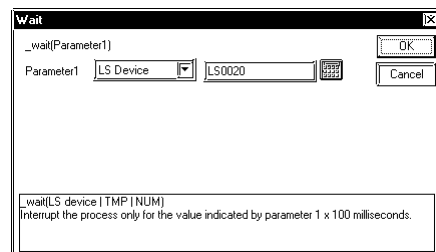

◆ **Bit Control**

<Clear Bit>

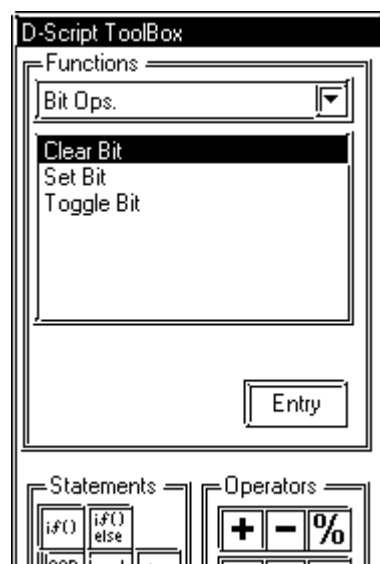

Clear Bit: clear ()

Changes the specified bit address from 1 to 0.

Example statement:

`clear ([b: LS010000])`

In the above example, the 00th bit of LS0100 is changed from 1 to 0.

<Toggle Bit>

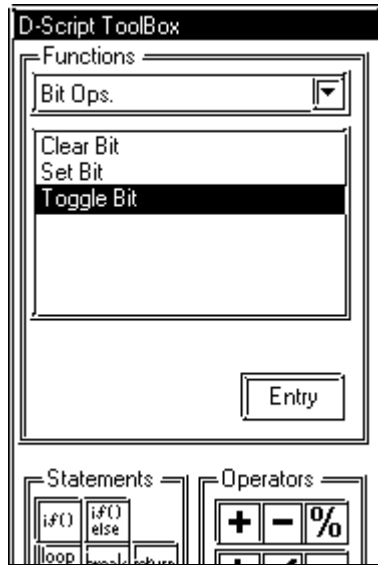

Bit toggle (invert): toggle ()

Changes the specified bit address from 1 to 0 or from 0 to 1.

Example statement:

toggle ([b: LS010000])

In the above example, the 00th bit of LS0100 is changed from 1 to 0 or from 0 to 1.

<Set Bit>

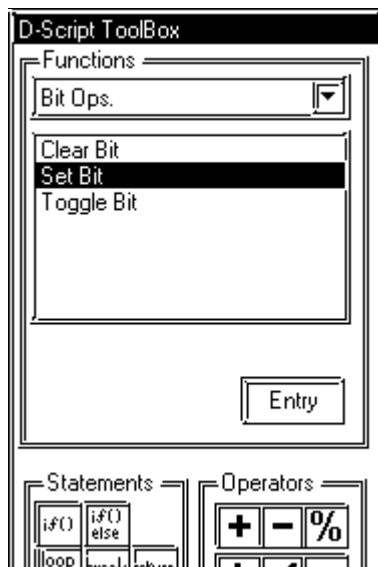

Bit set: set ()

Changes the specified bit address from 0 to 1.

Example statement:

set ([b: LS010000])

In the above example, the 00th bit of LS0100 is changed from 0 to 1.

◆String Control

<Decimal string to Binary>

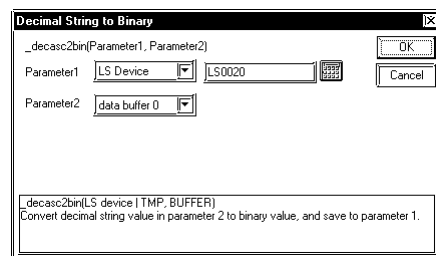
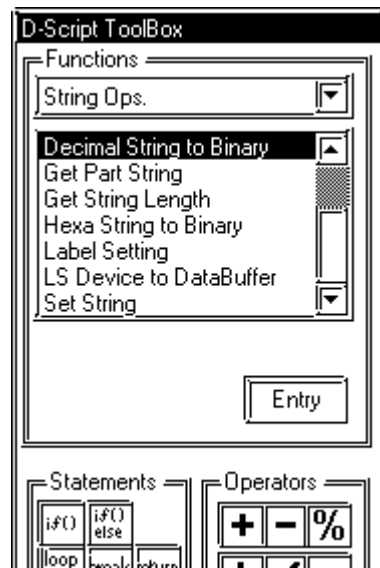

Decimal string-to-numeral conversion: _decasc2bin

This function is used to convert a decimal string to integers.

The decimal string in Parameter 2 is converted into an integer value and stored in Parameter 1.

Parameter 1: LS device, Temporary address

Parameter 2: Data buffer

Format:

_decasc2bin ([destination word address], [source data buffer])

■ **When the data length is 16 bits**

Example statement 1

_decasc2bin ([w: LS0100], databuf0)

The content of "databuf0" is as follows:

	8 bits	
databuf0 [0]	0x31	'1'
databuf0 [1]	0x32	'2'
databuf0 [2]	0x33	'3'
databuf0 [3]	0x34	'4'
databuf0 [4]	0x00	NULL

The above data are converted as follows:

	16 bit
LS0100	1234

■ **When the data length is 32 bits**

Example statement 2

```
_decasc2bin ([w: LS0100], databuf0)
```

The content of "databuf0" is as follows:

	8 bits	
databuf0 [0]	0x31	'1'
databuf0 [1]	0x32	'2'
databuf0 [2]	0x33	'3'
databuf0 [3]	0x34	'4'
databuf0 [4]	0x35	'5'
databuf0 [5]	0x36	'6'
databuf0 [6]	0x37	'7'
databuf0 [7]	0x38	'8'
databuf0 [8]	0x00	NULL

The above data are converted as follows:

	32 bit
LS0100	12345678
LS0102	



- **An error occurs when the converted bit length is greater than the bit length of the D-Script Editor.**

Example: When the bit length of the script is 16 bits:

```
_strset (databuf0, "123456")//When a 6-digit decimal string is set accidentally
```

```
_decasc2bin ([w: LS0100], databuf0)
```

When the above expression is executed, Error No. 2 (string conversion error) of the String error status [e: STR_ERR_STAT] is triggered. However, the bit returns to the beginning of the Main function when an error occurs. Therefore, it cannot be referred immediately after "_decasc2bin ()" is executed.

- **An error occurs during conversion of a string of data containing characters other than "0" to "9".**



Example: When the bit length of the script is 16 bits:

```
_strset (databuf0, "12AB")//When a non-decimal string is set accidentally
```

```
_decasc2bin ([w: LS0100], databuf0)
```

When the above expression is executed, Error No. 2 (string conversion error) of the String error status [e: STR_ERR_STAT] is triggered. However, the bit returns to the beginning of the Main function when an error occurs. Therefore, it cannot be referred immediately after "_decasc2bin ()" is executed.

- **The processing is terminated when an error occurs and returns to the beginning of the Main function.**

<Hexa String to Binary>

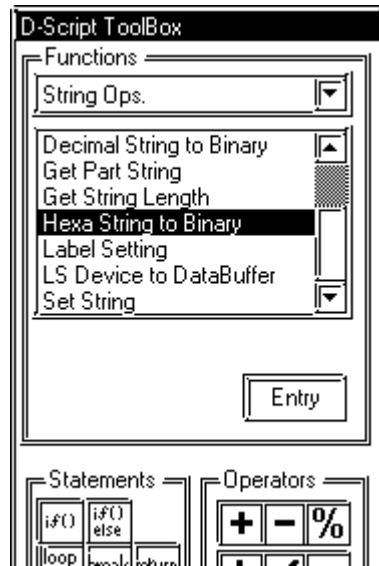

Hexadecimal string-to-numeral conversion: _hexasc2bin

This function converts a hexadecimal string to binary data.

The hexadecimal string in Parameter 2 is converted into an integer value and stored in Parameter 1.

Parameter 1: LS device, Temporary address

Parameter 2: Data buffer

Format:

_hexasc2bin ([destination word address], [source data buffer])

■ **When the data length is 16 bits**

Example statement 1

```
_hexasc2bin ([w: LS0100], databuf0)
```

The content of "databuf0" is as follows:

	8 bits	
databuf0 [0]	0x31	'1'
databuf0 [1]	0x32	'2'
databuf0 [2]	0x33	'3'
databuf0 [3]	0x34	'4'
databuf0 [4]	0x00	NULL

The above data are converted as follows:

	16 bit
LS0100	1234

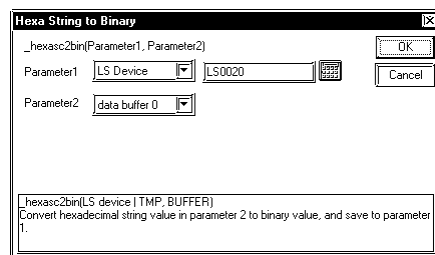

■ When the data length is 32 bits

Example statement 2

`_hexasc2bin ([w: LS0100], databuf0)`

The content of "databuf0" is as follows:

	8 bits	
databuf0 [0]	0x31	'1'
databuf0 [1]	0x32	'2'
databuf0 [2]	0x33	'3'
databuf0 [3]	0x34	'4'
databuf0 [4]	0x35	'5'
databuf0 [5]	0x36	'6'
databuf0 [6]	0x37	'7'
databuf0 [7]	0x38	'8'
databuf0 [8]	0x00	NULL

The above data are converted as follows:

	32 bit
LS0100	12345678
LS0102	



- **An error occurs when the converted string is greater than 16 bits or 32 bits.**

Example: When the bit length of the script is 16 bits:

```
_strset (databuf0, "123456")
_decasc2bin ([w: LS0100], databuf0)
```

When the above expression is executed, Error No. 2 (string conversion error) of the string error status [e: STR_ERR_STAT] is triggered.

- **An error occurs during conversion of a string of data containing characters other than "0" to "9", "A" to "F", or "a" to "f".**

Example: When the bit length of the script is 16 bits:

```
_strset (databuf0, "123G")
_decasc2bin ([w: LS0100], databuf0)
```

When the above expression is executed, Error No. 2 (string conversion error) of String error status [e: STR_ERR_STAT] is triggered.

- **The processing is terminated when an error occurs and returns to the beginning of the Main function.**

<LS Device to DataBuffer>

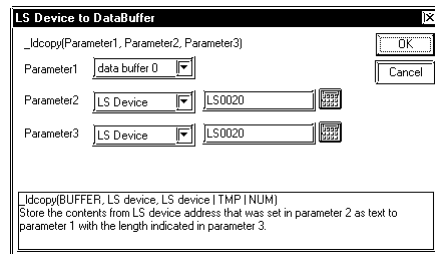
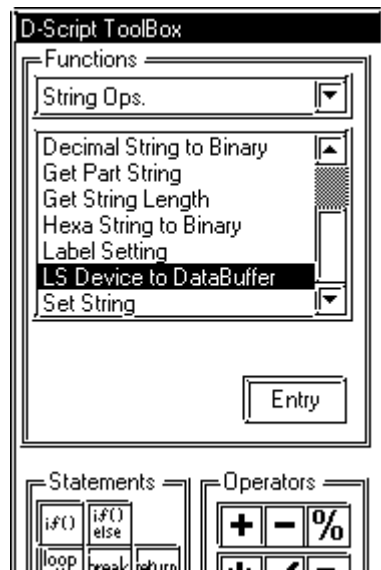

The data of the string stored in the LS area is copied to the data buffer according to the number of strings in a byte-by-byte transfer.

The string specified with Parameter 2 is copied to the data buffer of Parameter 1 according to the length specified with Parameter 3.

- Parameter 1: Data buffer
- Parameter 2: LS area
- Parameter 3: Integer value, LS area, Temporary address
(The valid range for Parameter 3 is between 1 and 1024.)

Format:

`_ldcopy` (destination data buffer, [source word address], number of addresses)

Example statement 1:

`_ldcopy` (databuf0, [w: LS0100], 4)

	16 bit
LS0100	0x31
LS0101	0x32
LS0102	0x33
LS0103	0x34

The data in LS0100 to LS0103 is written into the 4 characters of the data buffer starting from "databuf0". The LS area is read in each byte (the lowest bits).

	8 bits	
databuf0 [0]	0x31	'1'
databuf0 [1]	0x32	'2'
databuf0 [2]	0x33	'3'
databuf0 [3]	0x34	'4'
databuf0 [4]	0x00	NULL



- **The low 1 byte of the LS area is read out and the specified quantity of data is written into the data buffer.**
- **The maximum value that can be assigned for Parameter 3 is 1024. When a value exceeding the limit is set, Error No. 1 (string overflow) of the String error status [e: STR_ERR_STAT] is triggered.**
- **Even when data are stored in the significant byte in the LS area, only the data in the low 1 byte is read out.**
- **The processing is terminated when an error occurs and returns to the beginning of the Main function.**

`_ldcopy (detabuf0, [w: LS0100], 4)`

	16 bit
LS0100	0x3132
LS0101	0x3334
LS0102	0x3536
LS0103	0x3738

When data are stored as illustrated above, the data of the low 1 byte is read out and written into the data buffer.

	8 bits	
detabuf0 [0]	0x32	'2'
detabuf0 [1]	0x34	'4'
detabuf0 [2]	0x36	'6'
detabuf0 [3]	0x38	'8'
detabuf0 [4]	0x00	NULL

<DataBuffer to LS Device>

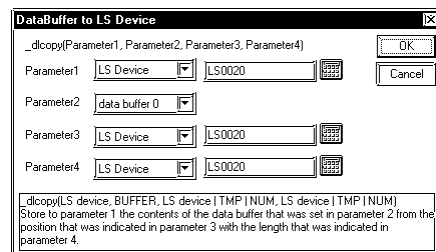
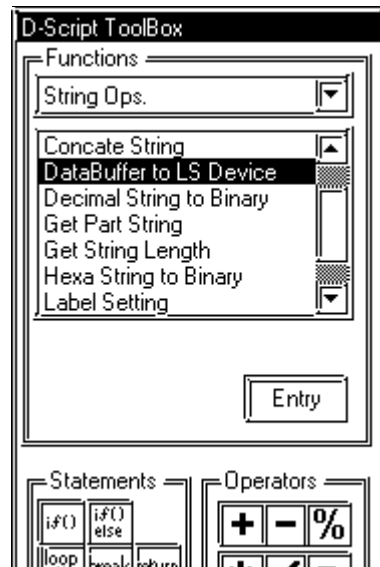

Each byte of string data stored in the offset of the data buffer is copied to the LS area according to the number of strings.

A string length specified with Parameter 4 is retrieved from the offset value (specified with Parameter 3) of the strings specified with Parameter 2 into the LS area specified with Parameter 1.

Parameter 1: LS area

Parameter 2: Data buffer

Parameter 3: Numerical value, LS area, Temporary address (The valid range for Parameter 3 is between 1 and 1024.)

Parameter 4: Numerical value, LS area, Temporary address (The valid range for Parameter 4 is between 1 and 1024.)

Format:

`_dlcopy` ([destination word address], source data buffer, source offset value, number of characters to be copied)

Example statement 1

`_dlcopy` ([w: LS0100], databuf0, 2, 4)
8 bits

databuf0 [0]	0x31	'1'
databuf0 [1]	0x32	'2'
databuf0 [2]	0x33	'3'
databuf0 [3]	0x34	'4'
databuf0 [4]	0x35	'5'
databuf0 [5]	0x36	'6'
databuf0 [6]	0x37	'7'
databuf0 [7]	0x38	'8'

4 characters of data retrieved from "offset 2" of "databuf0" are written into LS0100 to LS0103. The data are written into the LS area in units of 1 byte.

	16 bit	
LS0100	0x33	
LS0101	0x34	
LS0102	0x35	
LS0103	0x36	



- **1 byte of data is read out from the data buffer and written into the LS area. That means only the lowest 8 bits (1 byte) of the LS area will be used. The significant 8 bits (1 byte) will be cleared with "0".**
- **When the specified value [source offset value + number of characters to be copied] is greater than the data buffer size, error No. 3 (string extraction error) of the string error status [e: STR_ERR_STAT] is issued.**
- **The processing is terminated when an error occurs and returns to the beginning of the Main function.**

<Binary to Decimal String>

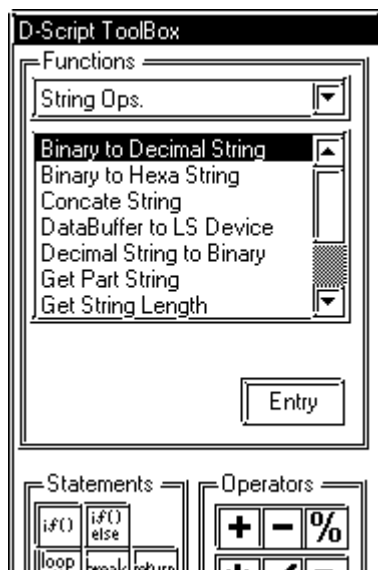

This function is used to convert an integer to a decimal string.

The integer value in Parameter 2 is converted into a decimal string and stored in Parameter 1.

Parameter 1: Data buffer

Parameter 2: LS device, Temporary address

Format:

`_bin2decasc` (destination data buffer, [source word address])

■ **When the data length is 16 bits**

Example statement 1

`_bin2decasc (databuf0, [w:LS0100])`

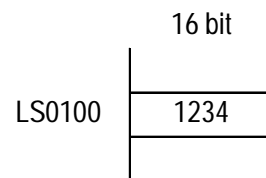

The above data are converted as follows:

Note that "NULL (0x00)" is added.

	8 bits	
databuf0 [0]	0x31	'1'
databuf0 [1]	0x32	'2'
databuf0 [2]	0x33	'3'
databuf0 [3]	0x34	'4'
databuf0 [4]	0x00	NULL

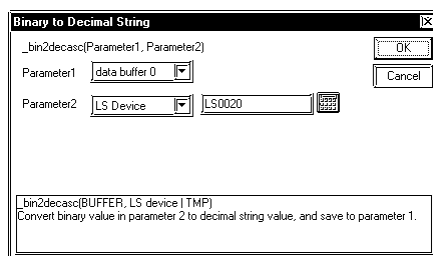

■ When the data length is 32 bits

Example statement 2

`_bin2decasc (databuf0, [w:LS0100])`

	32 bit	
LS0100	12345678	
LS0102		

The above data are converted as follows:

	8 bits	
databuf0 [0]	0x31	'1'
databuf0 [1]	0x32	'2'
databuf0 [2]	0x33	'3'
databuf0 [3]	0x34	'4'
databuf0 [4]	0x35	'5'
databuf0 [5]	0x36	'6'
databuf0 [6]	0x37	'7'
databuf0 [7]	0x38	'8'
databuf0 [8]	0x00	NULL

<Binary to Decimal String>

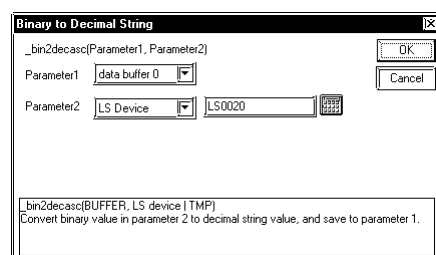
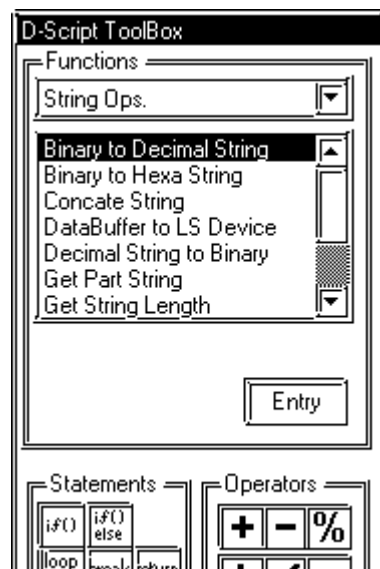

This function is used to convert binary data into a hexadecimal string.

The integer value in Parameter 2 is converted into a hexadecimal string and stored in Parameter 1.

- Parameter 1: Data buffer
- Parameter 2: LS device, Temporary address

Format:

`_bin2dexasc (destination data buffer, [source word address])`

■ When the data length is 16 bits

Example statement 1

`_bin2hexasc (databuf0, [w:LS0100])`

	16 bit	
LS0100	0x1234	

The above data is converted as follows:

Note that "NULL (0x00)" is added.

	8 bits	
detabuf0 [0]	0x31	'1'
detabuf0 [1]	0x32	'2'
detabuf0 [2]	0x33	'3'
detabuf0 [3]	0x34	'4'
detabuf0 [4]	0x00	NULL

■ When the data length is 32 bits

Example statement 2

`_bin2hexasc (detabuf0, [w: LS0100])`

	32 bit
LS0100	0x12345678
LS0102	

The above data are converted as follows:

	8 bits	
detabuf0 [0]	0x31	'1'
detabuf0 [1]	0x32	'2'
detabuf0 [2]	0x33	'3'
detabuf0 [3]	0x34	'4'
detabuf0 [4]	0x35	'5'
detabuf0 [5]	0x36	'6'
detabuf0 [6]	0x37	'7'
detabuf0 [7]	0x38	'8'
detabuf0 [8]	0x00	NULL

<Get Part String>

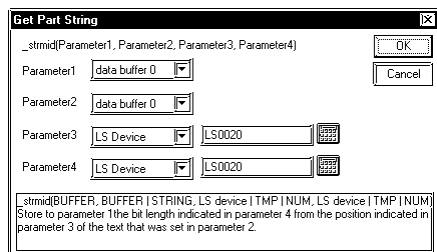
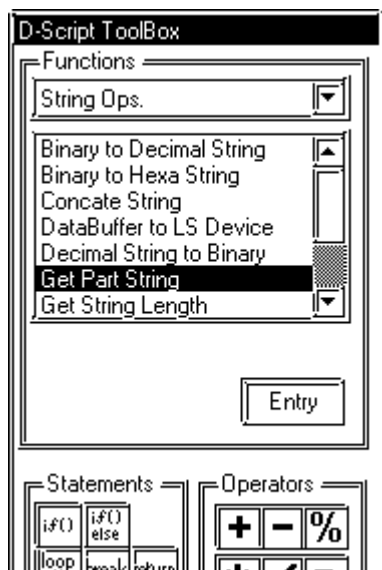

Data are retrieved from the specified offset of the string according to the length of the string and stored in another data buffer. A string of the length specified with Parameter 4 is retrieved from the offset value (specified with Parameter 3) of the string specified with Parameter 2 and stored in the data buffer specified with Parameter 1.

- Parameter 1: Data buffer
- Parameter 2: String, Data buffer
- Parameter 3: Numerical value, LS area, Temporary address (The valid range of numbers for Parameter 3 is between 1 and 1024.)
- Parameter 4: Numerical value, LS area, Temporary address (The valid range of numbers for Parameter 4 is between 1 and 1024.)

Format:

`_strmid (data-storing data buffer, "string", Offset value, number of characters)`

Example statement:

`_strmid (databuf0, "12345678", 2, 4)`
 4 characters of data retrieved from offset 2 of string "12345678" are stored in "databuf0".

	8 bits	
databuf0 [0]	0x33	'3'
databuf0 [1]	0x34	'4'
databuf0 [2]	0x35	'5'
databuf0 [3]	0x36	'6'
databuf0 [4]	0x00	NULL



- **When attempting to retrieve a string longer than the string specified with the "strmid ()" function, or when specifying an offset value greater than the specified string, error No. 3 (string extraction error) of the string error status [e: STR_ERR_STAT] is issued.**
- **The processing is terminated when an error occurs and returns to the beginning of the Main function.**

<Set String>

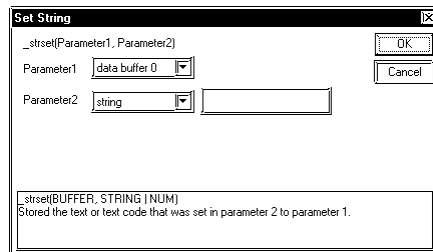
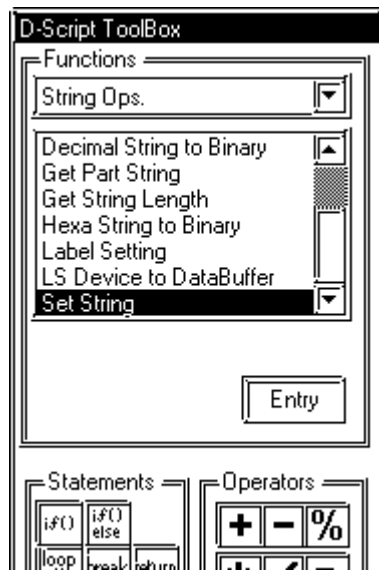

A fixed string is stored in the data buffer. A string specified with Parameter 2 is stored in Parameter 1.

Parameter 1: Data buffer

Parameter 2: String

Format:

`_strset (data-storing data buffer, "string")`

Example statement

`_strset (databuf0, "ABCD")`

The string is stored in the data buffer as illustrated below:

	8 bits	
databuf0 [0]	0x41	A'
databuf0 [1]	0x42	B'
databuf0 [2]	0x43	C'
databuf0 [3]	0x44	D'
databuf0 [4]	0x00	NULL



Important

- **A string of up to 255 characters can be specified. To create strings longer than this limit, store the string in another buffer and concatenate the strings with the string-concatenating function (`_strcat`).**

- **To clear the data buffer, create an empty string "".**

Example: `_strset (databuf0, "")`

<Get String Length>

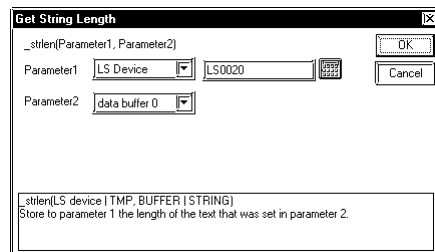
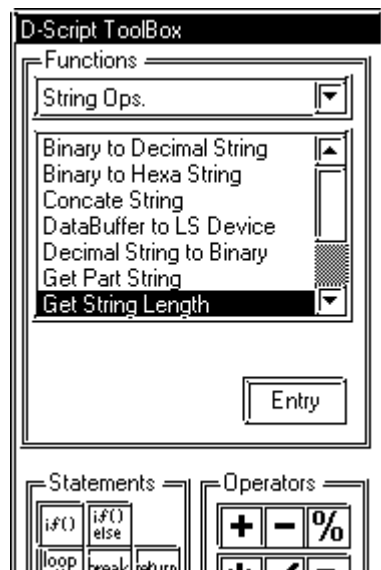

Obtains the length of the stored string. When a data buffer is assigned to Parameter 2, the number of characters up to the "NULL" character are stored in Parameter 1. (The NULL character is not included.)

Parameter 1: LS device, Temporary address

Parameter 2: String, Data buffer

Format:

`_strlen (data buffer storing the string length, "string")`

Example statement 1:

`_strlen ([w: LS0100], "ABCD")`

When the above statement is executed, the length of the string is written into LS0100 as illustrated below.

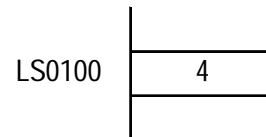

Example statement 2

`_strlen ([t: 0000], databuf0)`

When the content of "databuf0" is as follows:

	8 bits	
databuf0 [0]	0x31	'1'
databuf0 [1]	0x32	'2'
databuf0 [2]	0x33	'3'
databuf0 [3]	0x34	'4'
databuf0 [4]	0x00	NULL

When the above statement is executed, the length of the string is written into [t: 0000] as illustrated below.

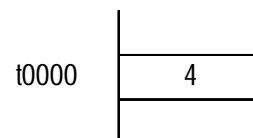

<Concat String>

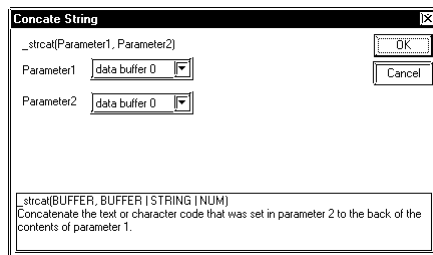
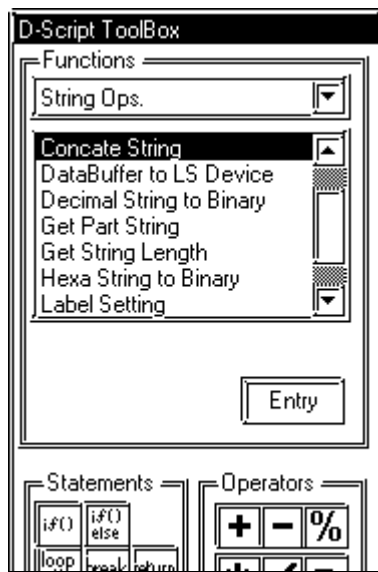

A character string or character code is concatenated with the string buffer.

A character string or character code specified with Parameter 2 is concatenated according to Parameter 1.

Parameter 1: Data buffer

Parameter 2: String, Numerical value (character code), Data buffer

Format:

`_strcat` (concatenating data buffer, "string")

Example statement:

`_strcat (databuf0, "ABCD")`

	8 bits	
databuf0 [0]	0x31	'1'
databuf0 [1]	0x32	'2'
databuf0 [2]	0x33	'3'
databuf0 [3]	0x34	'4'
databuf0 [4]	0x00	NULL

When "ABCD" is concatenated according to the above, the result is as follows. Note that "NULL (0x00)" is added.

	8 bits	
databuf0 [0]	0x31	'1'
databuf0 [1]	0x32	'2'
databuf0 [2]	0x33	'3'
databuf0 [3]	0x34	'4'
databuf0 [4]	0x41	'A'
databuf0 [5]	0x42	'B'
databuf0 [6]	0x43	'C'
databuf0 [7]	0x44	'D'
databuf0 [8]	0x00	NULL

◆ String Control Error Status

When an error occurs during execution of string control, an error is set to the String Control Error Status [e: STR_ERR_STAT].

"0" in [e: STR_ERR_STAT] indicates a normal condition, and values other than "0" stored in [e: STR_ERR_STAT] indicate error states.

The most recent error is stored in the String Control Error Status [e: STR_ERR_STAT].

The String Control Error Status can be set up with [SIO Port Control/Label Setting] under the D-Script Toolbox menu.

The following table lists the string control errors.

Error No.	Error Name	Description
0	Normal	No error
1	String overflow	A string of at least 256 bytes is directly included in the argument for the following Functions: <code>_strset()</code> , <code>_strlen()</code> , <code>_strcat()</code> , <code>_strmid()</code> , and <code>IO_READ_WAIT()</code> . Or, a string exceeding the data buffer size is created during execution of the <code>_strcat()</code> or <code>_ldcopy()</code> function. Example: <code>_strcat(databuf0, databuf1)</code> The above function is executed when a string of 1020 bytes is stored in <code>databuf0</code> , and a string of 60 bytes is stored in <code>databuf1</code> . (A string exceeding 1024 bytes, the size of the data buffer, results in an error status.)
2	String conversion error	Invalid character code is given to the <code>_hexasc2bin()</code> or <code>_decasc2bin()</code> Function. Example: A character code other than "0" to "9", "A" to "F", or "a" to "f" is included in the second argument of <code>_hexasc2bin()</code> .
3	String-retrieval error	Retrieval of a character string longer than the character string specified with the <code>_strmid()</code> Function is attempted. Or, an offset value greater than the specified string is designated. Example: <code>_strmid(databuf0, "12345678", 2, 8)</code> Retrieval of an 8-character string from offset 2 is attempted.

The String Control Error Status cannot be used with D-Scripts and Global D-Scripts. If it is read out accidentally, "0" will be loaded.

It is stored in the Error Status during execution of each function.

To check the error [e: STR_ERR_STAT], write statements as follows.

Example statement

```
if ([e: STR_ERR_STAT] <>0) // Checks the error status.
{
set ([b: 0100000]) // Sets the bit for the error indicator lamp.
}
endif
```



The processing is terminated when an error occurs and returns to the beginning of the Main function.

◆ CF File Ops.

CF Card File Data Read/Write is supported. Furthermore, CF file deletion, listing of files within a folder, Creation of multiple levels of folders and Indirect specification of destination address are supported.

<File Write>

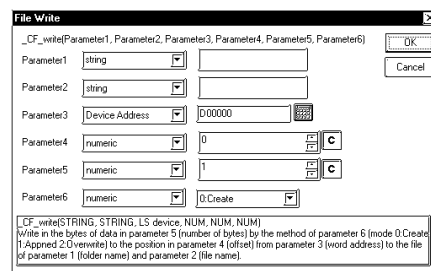
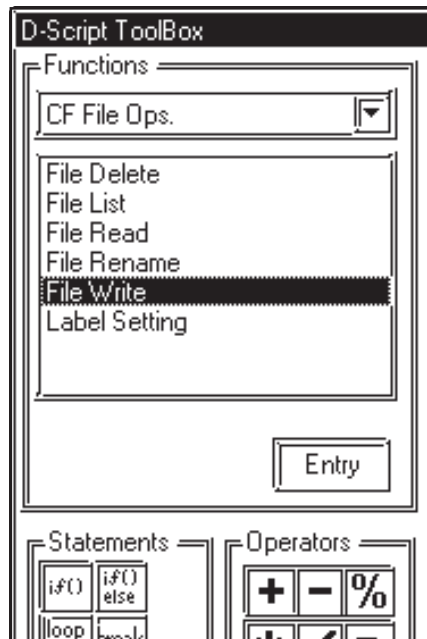

File Write

Writes the specified number of bytes of data from the source address to the specified file. Any one of three modes can be selected: "New", "Add", and "Overwrite".

Parameter 1

Folder name : Fixed string
(Maximum length: 32 single-byte characters)

Parameter 2

File name : Fixed string, LS Area
(Maximum length: 32 single-byte characters)

Parameter 3

Source Address : LS Area

Parameter 4

Offset : Numerical value, PLC device, LS Area, Temporary address
(Maximum number that can be specified: 65535 for 16-bit length, 4294967295 for 32-bit length)

Parameter 5

Number of bytes : Numerical value, PLC device, LS Area, Temporary address
(Maximum number that can be specified: 1280)

Parameter 6

Mode: Numerical value, PLC device, LS Area, Temporary address
(Available values: 0, 1, 2)

Format:

`_CF_write(Folder name, File name, Source address, Offset, Number of bytes, Mode)`

Mode	Name	Description
0	New	Creates a new file. If a file with the same name exists, it is deleted.
1	Add	Adds the data to a specified file. If the specified file does not exist, a new file is created.
2	Overwrite	Overwrites part of the file. If the specified offset is larger than the file size, the surplus area is filled with 0s and the data is written after the area. If the offset is specified at the end of the file data, the operation is equivalent to adding the data to the file.

Example statement of the function

```
[w:LS0200] = 0 // Offset ("0" when the mode is "New")
[w:LS0202] = 100 // Number of bytes (100 bytes)
[w:LS0204] = 0 // Mode ("New")
_CF_write("\DATA", "DATA0001.BIN", [w:LS0100], [w:0200],
[w:LS0202], [w:LS0204])
```

The above example creates a new file, DATA0001.BIN, in the \DATA folder and stores 100 bytes of data read from LS0100. When the LS Area is specified for the offset, the number of bytes or the mode, they can be designated indirectly.



- ***The offset setting is effective only in "Overwrite" mode. The offset setting is disabled in "New" and "Add" modes. Set the offset value to "0" in modes other than "Overwrite" mode.***
- ***When "New" mode is specified and a file with the same name already exists, it is overwritten.***
- ***The data is divided into pieces and read from the source, although this depends on the number of bytes to be read. Therefore, even if a communication error occurs during data read, the data may have been partially written to the specified file.***

Example statement

- When "New" mode is specified

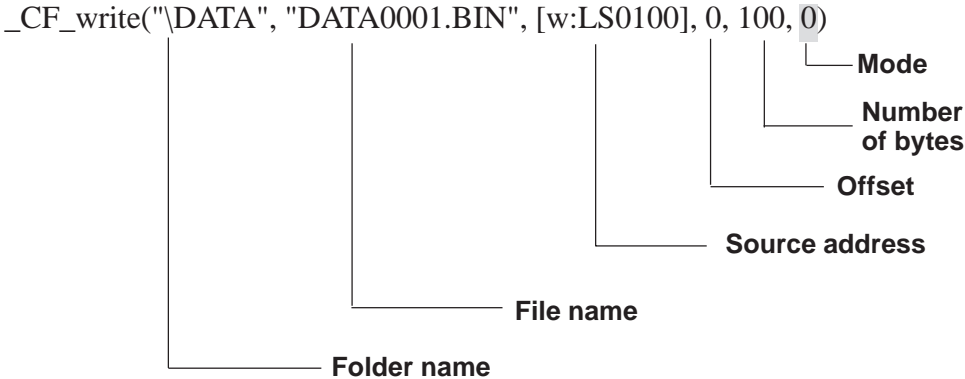

When the above example is executed, 100 bytes of data are read from LS0100 and later areas and written into the DATA0001.BIN file, which is a new file created in the \DATA folder.

- When "Add" mode is specified

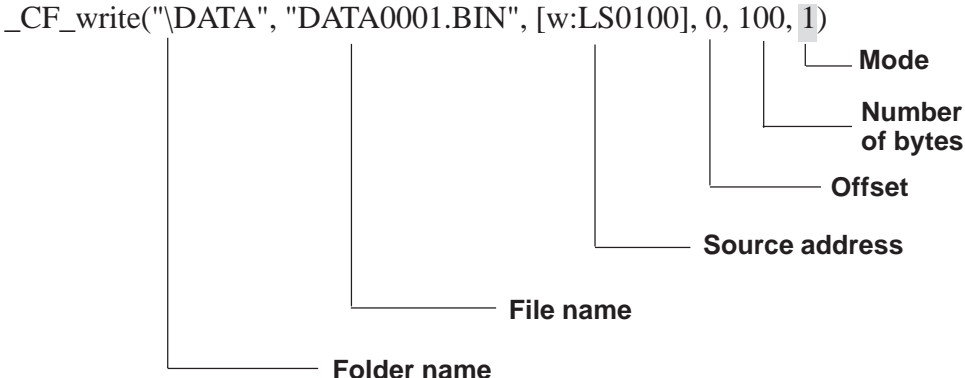

If the specified file (DATA0001.BIN in the example) already exists and the statement above is executed, 100 bytes of data are read from LS0100 and later areas and added to the DATA0001.BIN file in the \DATA folder.

- When "Overwrite" mode is specified (1)

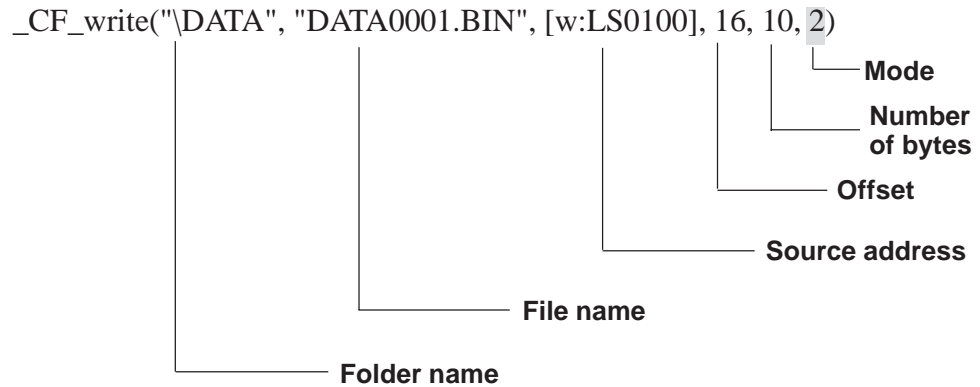

If the specified file (DATA0001.BIN in the example) already exists and the above statement is executed, 10 bytes of data stored in LS0100 and later areas are read and overwrite 10 bytes of data stored in the 17th and later bytes after the offset in the DATA0001.BIN file in the \DATA folder.

- When "Overwrite" mode is specified (2)

(the file to be overwritten is less than the sum of the offset value and number of bytes)

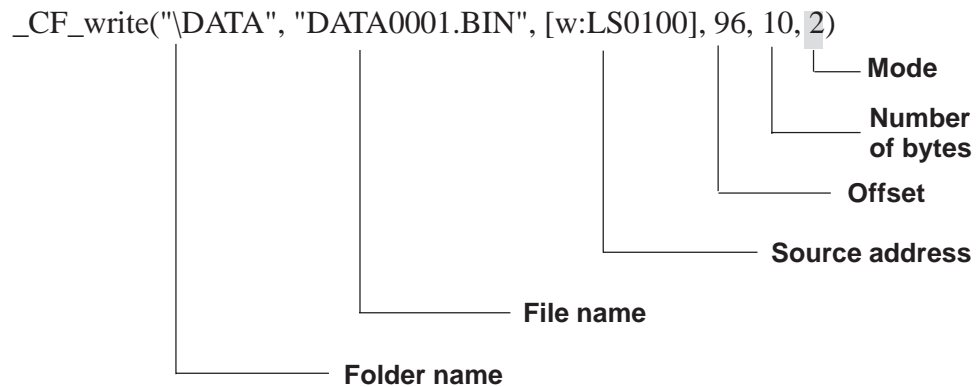

The specified file (DATA0001.BIN in the example) already exists and the file size is 100 bytes. When the offset is set to 96 bytes and the number of bytes is set to 10 bytes for the overwrite operation, 10 bytes of data stored in LS0100 and later areas are read. Then, the first 4 bytes of readout data overwrite the 4 bytes of data stored in the 97th and later bytes in the file, and the remaining 6 bytes of data are added to the end of the file data.

The resulting file contains 106 bytes of data.

- When "Overwrite" mode is specified (3)

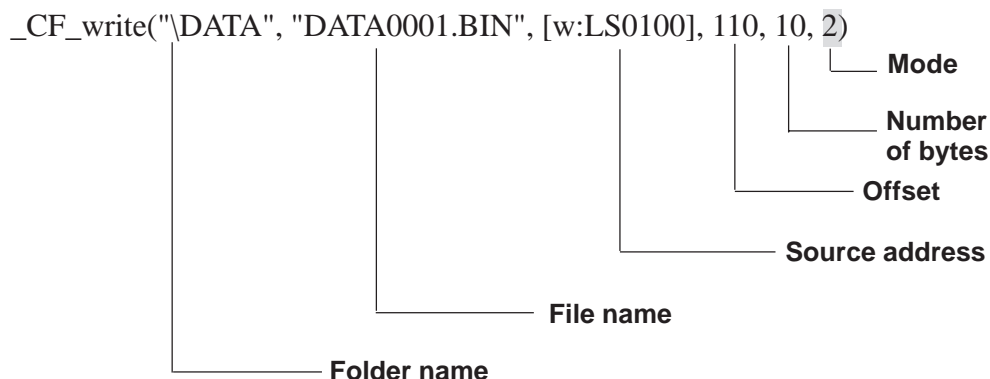

The specified file (DATA0001.BIN in the example) already exists and the file size is 100 bytes. When the offset is set to 110 bytes and the number of bytes is set to 10 bytes for the overwrite operation, the area between the 101st byte and 110th bytes is filled with 0s and the 10 bytes of data read from LS0100 and later areas are written in the 111th and later bytes.

Consequently, the resulting file contains 120 bytes of data.



- **The maximum allowable number of characters for the first parameter "Folder name" and the second parameter "File name" is 32 single-byte characters.**
- **The LS Area can be specified for the second parameter "File name". Specifying the LS Area allows the indirect addressing of a file name. Up to 32 single-byte characters can be used to specify a file name.**

Example: `_CF_write("\DATA", [w:LS0100], [w:LS0200], 0, 100, 0)`

Storing a file name in LS0100 allows indirect addressing of a file name.

In this example, a file name is stored in LS0100 through LS0106 as follows.

	16 bit	
LS0100	'D'	'A'
LS0101	'T'	'A'
LS0102	'0'	'0'
LS0103	'0'	'1'
LS0104	'.'	'B'
LS0105	'I'	'N'
LS0106	'\0'	'\0'
	:	

The end of the file name must be a NULL character. The display device recognizes the data before the NULL character as the file name.

In the example above, 100 bytes of data are read from LS0200 and following areas and a new file, “\DATA\DATA0001.BIN”, is created for storing the data.



- **As for the file name, only the “8.3 format” (a maximum of 12 characters, with 8 characters for the file name and 3 characters for the extension) may be used. Long file names cannot be used.**

<File Read>

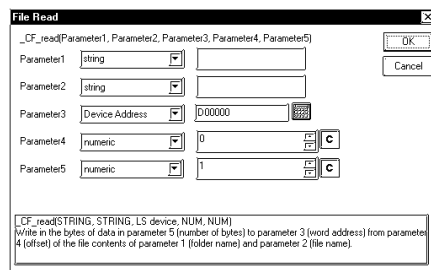
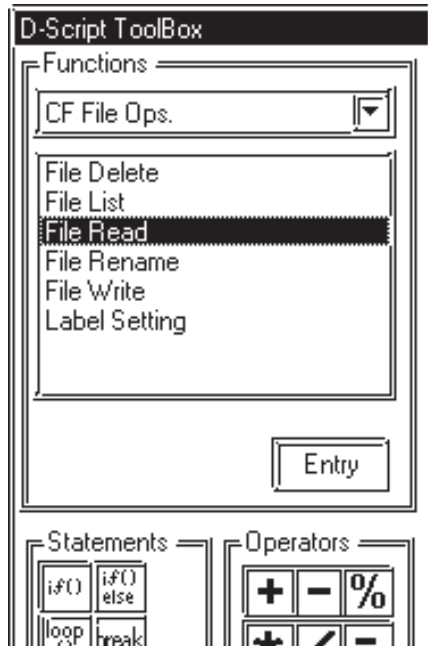

File Read

Reads the specified number of bytes of data in the file after the specified offset and writes it in the destination address.

Format

`_CF_read(Folder Name, File Name, Destination Address, Offset, Number of bytes)`

Parameters

Parameter 1

Folder name: Fixed string (Maximum length: 32 single-byte characters)

Parameter 2

File name: Fixed string, LS Area (Maximum Length: 32 single-byte characters)

Parameter 3

Destination Address: LS Area

Parameter 4

Offset: Numerical value, PLC device, LS Area, Temporary address (Maximum number to be specified: 65535 for 16-bit lengths, 4294967295 for 32-bit length)

Parameter 5

Number of bytes: Numerical value, PLC device, LS Area, Temporary address (Maximum number to be specified: 1280)

Format

`_CF_read(Folder name, File name, Destination address, Offset, Number of bytes)`

Example statement

To read 16 bytes of data in the specified file when the offset is 16:

```
_CF_read("\DATA", "DATA0001.BIN", [w:LS0100], 16, 16)
```

In the example above, the 16 bytes of data from the 17th and later bytes in the "\DATA\DATA0001.BIN" file are written to LS0100 and later areas.



- As for the file name, only the "8.3 format" (a maximum of 12 characters, with 8 characters for the file name and 3 characters for the extension) may be used. Long file names cannot be used.
- The maximum allowable number of characters for the first parameter "Folder name" and the second parameter "File name" is 32 single-byte characters.
- The LS Area can be specified for the second parameter "File name". Specifying the LS Area allows the indirect addressing of a file name. Up to 32 single-byte characters can be used to specify a file name.

Example:

To read 10 bytes of data stored in a file when the file is specified in LS0100 and later and the offset is 0:

```
_CF_read("\DATA", [w:LS0100], [w:LS0200], 0, 10)
```

Storing a file name in LS0100 enables the indirect addressing of a file name.

In this example, a file name is stored in LS0100 through LS0106 as follows:

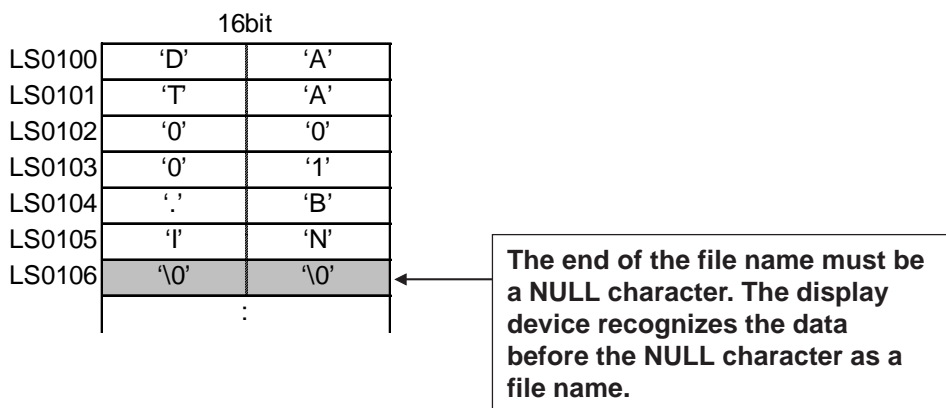

In the example above, 10 bytes of data at the beginning of the "\DATA\DATA0001.BIN" file are read and written into LS0200 and later areas.

- The number of bytes that are successfully read is written in CF Card Readout Bytes [s:CF_READ_NUM].

Reference For details of CF Card Readout Bytes, refer to "CF card status."

- Screen displays such as tags are not updated or refreshed until data write has been completed for the designated number of bytes. Also, screen changes, Q-tag alarm processing and other processes will not be performed.
- When the LS Area is specified for "File name" or "Destination Address", it is not counted as an Extended SIO Script Address.

<File List>

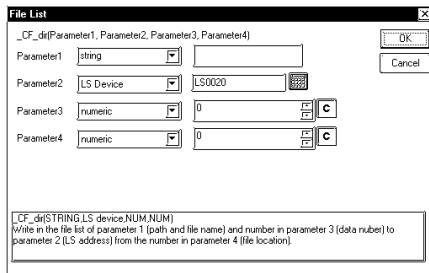
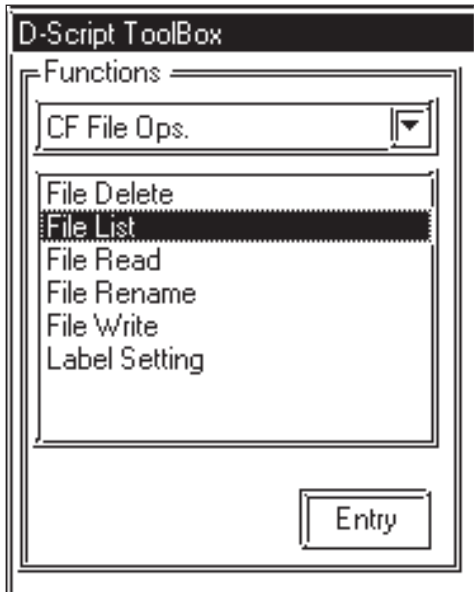

File List

The list of files that exist in the specified folder is written in the LS Area.

Parameter 1 designates the CF Card data folder. Parameter 4 designates the offset used to select a file/files within that folder. Parameter 3 designates the number of files selected within that folder. Parameter 4 specifies the LS Area into which the files will be written.

When the offset is specified as "0", the list starts from the first (starting) file.

Parameters

Parameter 1 Folder name: Fixed string (Maximum length: 32 single-byte characters)

Parameter 2 Destination LS Address: LS Area

Parameter 3 Number of file names: Numerical value, PLC device, LS Area, Temporary address (Maximum number to be specified: 32)

Parameter 4 Offset: Numerical value, PLC device, LS Area, Temporary address

Format

_CF_dir(Folder name, destination LS Address, number of file names, offset)

Example statement

To output a file list containing two files when the offset is 1 (second file):

```
_CF_dir("\\DATA\*.*", [w:LS0100], 2, 1)
```

When the statement above is executed while the following files exist in the DATA folder, file names "DATA0001.BIN" and "DATA02.BIN" are written to LS0100 and later areas.

Contents of folder



Contents of LS Area

	16 bit		
LS0100	'D'	'A'	7 words are used.
LS0101	'T'	'A'	
LS0102	'0'	'0'	
LS0103	'0'	'1'	
LS0104	'.'	'B'	
LS0105	'I'	'N'	
LS0106	'\0'	'\0'	
LS0107	'D'	'A'	7 words are used.
LS0108	'T'	'A'	
LS0109	'0'	'2'	
LS0110	'.'	'B'	
LS0111	'I'	'N'	
LS0112	'\0'	'\0'	
LS0113	'\0'	'\0'	



- Specifying the offset as 0 means the listing begins from the first file (starting file).
- As for the file name, only the "8.3 format" (a maximum of 12 characters, with 8 characters for the file name and 3 characters for the extension) may be used. Long file names cannot be used.
- If the specified folder does not have enough files as specified, the remaining LS Area is filled with NULL characters ('\0').
- If a file name has fewer than 12 characters, the empty positions are filled with NULL characters ('\0').
- To specify a folder name, be sure to add " *.* " (e.g. "\DATA\ *.* "). " *.* " means to list all files.
- The number of files actually listed is written in CF Card Listed Files [s:CF_FILELIST_NUM]. For details on CF Card Listed Files, [Reference](#) CF card status.
- The file names are not sorted when they are written into the LS Area. They are written in the order of creation (the order of FAT entry).
- You can create the list by specifying a file extension. To list the files with a certain extension, use a format such as "\DATA\ *.*.BIN". You cannot use "*" within a file name.

<File Delete>

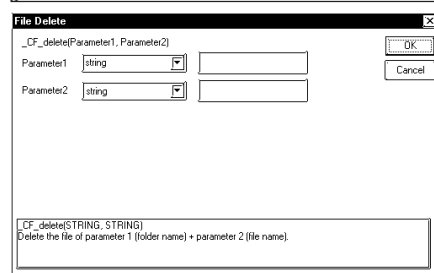
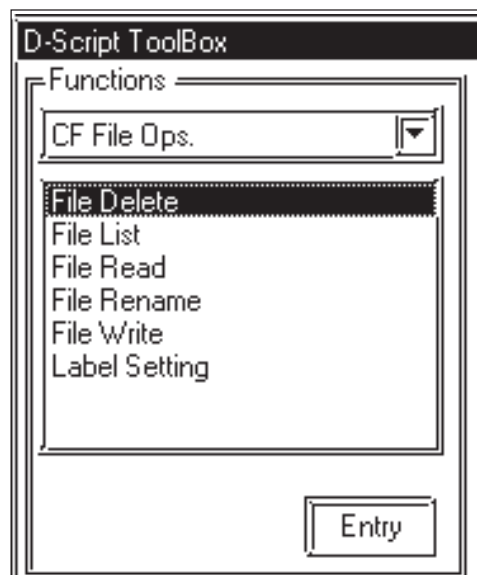

File Delete

Deletes the specified file from the CF card. Parameter 1 designates the CF Card data folder. Parameter 2 designates the name of the file to be deleted.

Parameters

Parameter 1 Folder name: Fixed string
Parameter 2 File name: Fixed string, LS Area, LS Device + Temporary address

Format

`_CF_delete(Folder name, File name)`
 The file name can also be designated indirectly via the LS Address.

Example statement

`_CF_delete("\DATA", "DATA0001.BIN")`
 The above example deletes the "\DATA \DATA0001.BIN" file.



- As for the file name, only the "8.3 format" (a maximum of 12 characters, with 8 characters for the file name and 3 characters for the extension) may be used. Long file names cannot be used.
- The maximum allowable number of characters for the first parameter "Folder name" and the second parameter "File name" is 32 single-byte characters.
- The LS Area can be specified for the second parameter "File name". Specifying the LS Area allows the indirect addressing of a file name. Up to 32 single-byte characters can be used to specify a file name.

In this example, a file name is stored in LS0100 through LS0106 as follows:

	16 bit	
LS0100	'D'	'A'
LS0101	'T'	'A'
LS0102	'0'	'0'
LS0103	'0'	'1'
LS0104	'.'	'B'
LS0105	'I'	'N'
LS0106	'\0'	'\0'
	:	

The end of the file name must be a NULL character. The display device recognizes the data before the NULL character as a file name.

In the example above, the "\DATA\DATA0001.BIN" file is deleted.

- To specify a root folder (directory), specify " " (empty string) as the folder name.
- When the LS Area is specified for "File name", "Destination Addresses" are not counted as D-Script Addresses.
- To specify a full path for a file name, specify "*" (asterisk) as the folder name.

<File Rename>

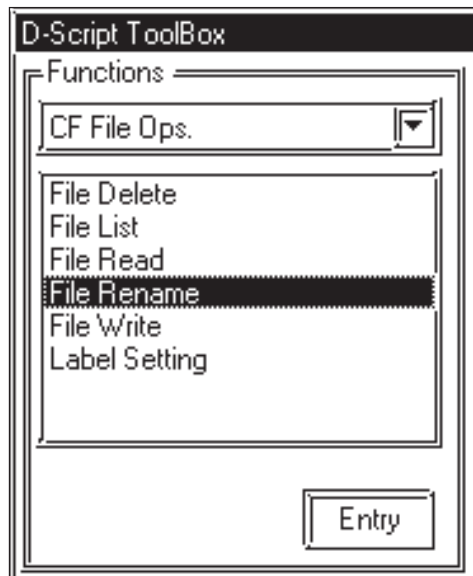

File Rename

Changes the name of a file. Parameter 1 designates the CF Card data folder. Parameter 2 designates the original file name. Parameter 3 designates the new name.

Parameters

Parameter 1 Folder name: Fixed string

Parameter 2 File name: Fixed string, LS Area

Parameter 3 New name: Fixed string, LS Area

Format

`_CF_rename(Folder name, File name, New file name)`

The file name can also be designated indirectly with the LS Address.

Example statement

`_CF_rename("\DATA", "DATA0001.BIN", "DATA1234.BIN")`

The example above changes the file name from "\DATA\DATA0001.BIN" to "\DATA\DATA1234.BIN".

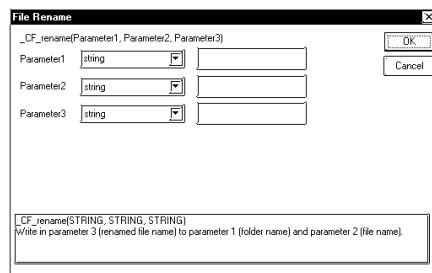

- **As for the file name, only the "8.3 format" (a maximum of 12 characters, with 8 characters for the file name and 3 characters for the extension) may be used. Long file names cannot be used.**
- **The maximum allowable number of characters for the first parameter "Folder name" and the second parameter "File name" is 32 single-byte characters.**
- **The LS Area can be specified for the second and third parameter's "File names". Specifying the LS Area allows the indirect addressing of file names. Up to 32 single-byte characters can be used to specify a file name.**

Example:

`_CF_rename ("\DATA", [w:LS0100], [w:LS0200])`

Storing the file name in LS0100 and LS0200 enables in direct addressing of the file name.

Store the file names in LS0100 through LS0106 and LS0200 through LS0206 as follows.

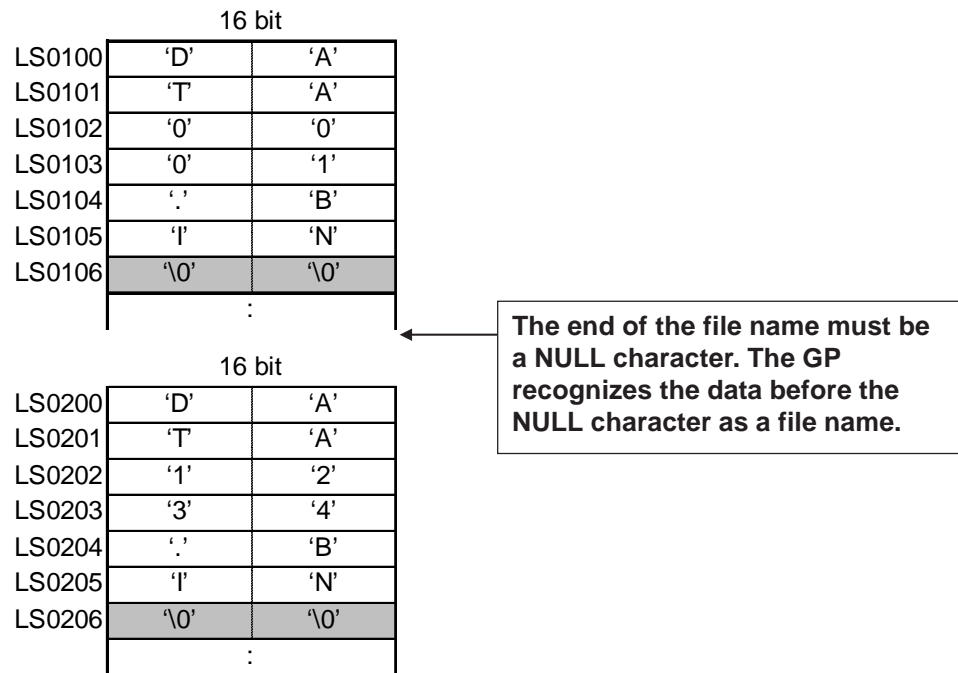

In the example above, the name of the "DATA\DATA0001.BIN" file is changed to "DATA\DATA1234.BIN".

- When the LS Area is specified for "File name", it is not counted as a D-Script Address.
- To specify a root folder (directory), specify " " (empty string) as the folder name.
- To specify a full path for a file name, specify "*" (asterisk) as the folder name.

■ CF card status

The following statuses are used for CF card status:

Status name	Label name	Description
Listed Files	[s:CF_FILELIST_NUM]	Stores the number of files actually listed when the File List Output function "_CF_dir()" is executed.
Readout Bytes	[s:CF_READ_NUM]	Stores the number of bytes that can be read out when the File Read function "_CF_read()" is executed.
CF Card Error Status	[s:CF_ERR_STAT]	Stores the error status generated when the CF card is accessed.

Listed Files

When the File List Output function "_CF_dir()" is executed, the number of file lists that are actually written in the LS Area is stored in "Listed Files [s:CF_FILELIST_NUM]"

Usage example

```
_CF_dir("\DATA\*.*", [w:LS0100], 10, 0)
```

```
[w:LS0200] = [s:CF_FILELIST_NUM]
```



When an attempt is made to obtain a file list of 10 files but the specified folder contains only five files, "5" is stored in [s:CF_FILELIST_NUM].



- **When no files are written, the total number of files contained in the specified folder is written in [s:CF_FILELIST_NUM].**

■ Readout Bytes

When the File Read function "_CF_read()" is executed, the number of bytes actually read out is stored in "Readout Bytes [s:CF_READ_NUM]".

Usage example

```
_CF_read("\DATA", "DATA0001.BIN", [w:LS0100], 16, 16)
```

```
[w:LS0200] = [s:CF_READ_NUM]
```

When an attempt is made to read 16 bytes but only 12 bytes are read successfully, "12" is stored in [s:CF_READ_NUM].

■ CF Card Error Status

Stores error statuses generated when the CF card is accessed.

Bit position	Error name	Description
15	Reserved	Reserved
14		
13		
12		
11		
10		
9		
8		
7		
6	File rename error	CF card was removed during operation. Specified file does not exist. An attempt was made to rename a file with a read-only attribute.
5	File delete error	CF card was removed during operation. Specified file does not exist. An attempt was made to delete a file with a read-only attribute.
4	File write error	CF card was removed during operation. No available space remains on CF card. An attempt was made to write data to a file with a read-only attribute.
3	File read error	CF card was removed during operation. Specified file does not exist.
2	File list error	CF card was removed during operation. Specified folder did not exist.
1	CF card error	CF card is invalid. The media inserted is not a CF card.
0	No CF card	No CF card is inserted. Cover is open.

- Even when a CF card error occurs, operation continues. Be sure to write a script to check the error whenever you use the CF card file operation function.

Example:

```
_CF_dir("\DATA\*.*", [w:LS0100], 2, 1) // Outputs a file list.
if([s:CF_ERR_STAT02] <> 0)           // Checks the error status.
{
    set([b:LS005000])                 // Sets the bit address for error
                                     display.
}
endif
```

[Storage area of detailed status of CF card error]

If an error occurs, the appropriate bits are set. You can check the cause of the error by referring to the detailed status. The detailed status for each function is stored in LS9132 through LS9136 of the extended system area. These areas are read-only.

LS Area	
LS0000	
:	
LS9132	Status of CF card list operation
LS9133	Status of CF card read operation
LS9134	Status of CF card write operation
LS9135	Status of CF card delete operation
LS9136	Status of CF card rename operation
:	
LS9999	

Name of editor function		Error status	Cause
_CF_dir()	LS9132	0x0010	Invalid D-script data (Error in retrieving folder name specified with fixed string)
		0x0012	File name (path name) error
		0x0018	LS Area writing range error
		0x0020	No CF card
		0x0021	Invalid CF card
		0x0100	Directory open error

_CF_read()	LS9133	0x0010	Invalid D-script data (Error in retrieving folder name/file name specified with fixed string)
		0x0011	LS Area reading range error
		0x0012	File name (path name) error
		0x0018	LS Area writing range error
		0x0020	No CF card
		0x0021	Invalid CF card
		0x0101	File seek error (Offset error)
		0x0102	Number of readout bytes error
0x0110	File creation (open) error		

_CF_write()	LS9134	0x0010	Invalid D-script data (Error in retrieving folder name/file name specified with fixed string)
		0x0011	LS Area reading range error
		0x0012	File name (path name) error
		0x0020	No CF card
		0x0021	Invalid CF card
		0x0101	File seek error (Offset error)
		0x0104	Folder creation error
		0x0108	Write mode error
		0x0110	File creation (open) error
0x0111	File write error (e.g. Insufficient space on CF card)		

_CF_delete()	LS9135	0x0010	Invalid D-script data (Error in retrieving folder name/file name specified with fixed string)
		0x0011	LS Area reading range error
		0x0012	File name (path name) error
		0x0020	No CF card
		0x0021	Invalid CF card
		0x0112	File delete error (e.g. Specified file does not exist. Specified file is read-only.)

_CF_rename()	LS9136	0x0010	Invalid D-script data (Error in retrieving folder name/file name specified with fixed string)
		0x0011	LS Area reading range error
		0x0012	File name (path name) error
		0x0020	No CF card
		0x0021	Invalid CF card
		0x0114	File rename error (e.g. Specified file does not exist. Specified file is read-only. File name already exists.)

■ **Data storage mode**

When data is read/written from/to device addresses at the execution of the File Read/File Write function, the storage order of the written (readout) data can be specified.

Setting the data storage mode in LS9130 can change the storage order.

The mode can be selected from four options: 0, 1, 2 and 3.

◆ **Mode 0**

Example: When the File Read function is used to write a string "ABCDEFGH" in a device address

[w:LS9130] = 0

_CF_read("\DATA", "DATA0001.BIN", [w:LS0100], 0, 7)

- When the device address length is 16 bits

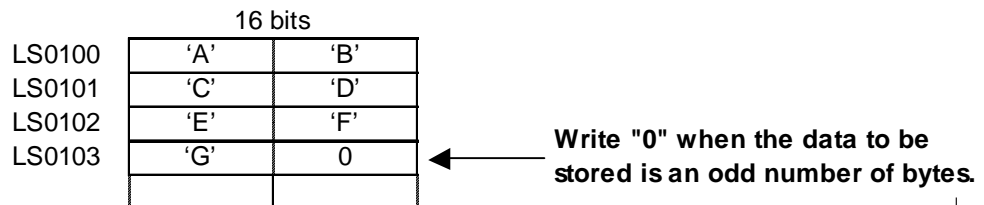

- When the device address length is 32 bits

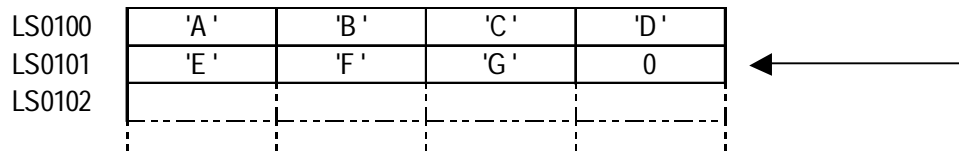

◆ **Mode 1**

Example: When the File Read function is used to write a string "ABCDEFGH" in a device address

[w:LS9130] = 1

_CF_read("\DATA", "DATA0001.BIN", [w:LS0100], 0, 7)

- When the device address length is 16 bits

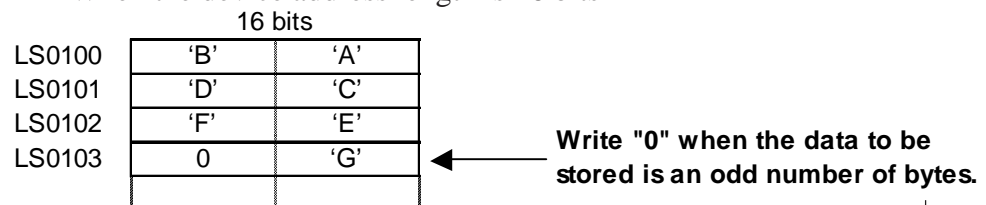

- When the device address length is 32 bits

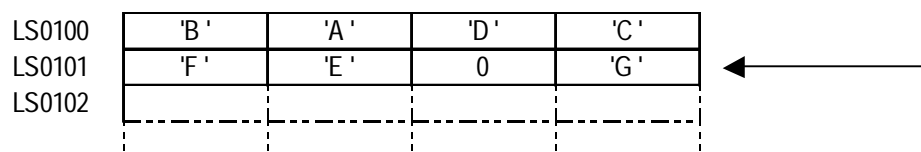

◆Mode 2

Example: When the File Read function is used to write a string "ABCDEFGH" in a device address

[w:LS9130] = 2

_CF_read("\DATA", "DATA0001.BIN", [w:LS0100], 0, 7)

- When the device address length is 16 bits

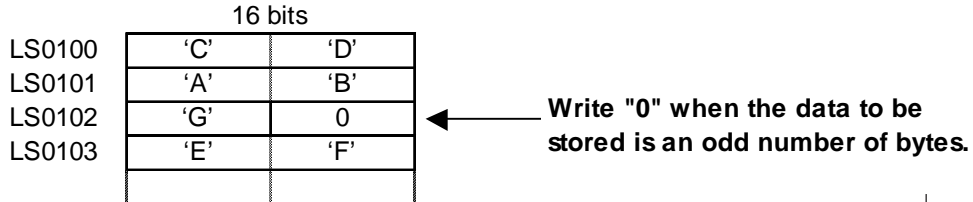

- When the device address length is 32 bits

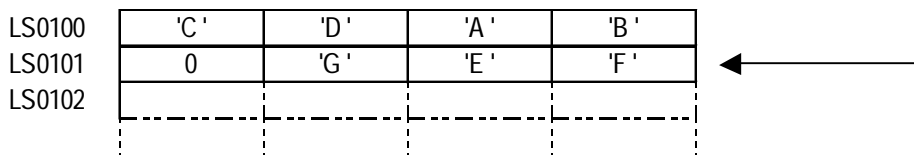

◆Mode 3

Example: When the File Read function is used to write a string "ABCDEFGH" in a device address

[w:LS9130] = 3

_CF_read("\DATA", "DATA0001.BIN", [w:LS0100], 0, 7)

- When the device address length is 16 bits

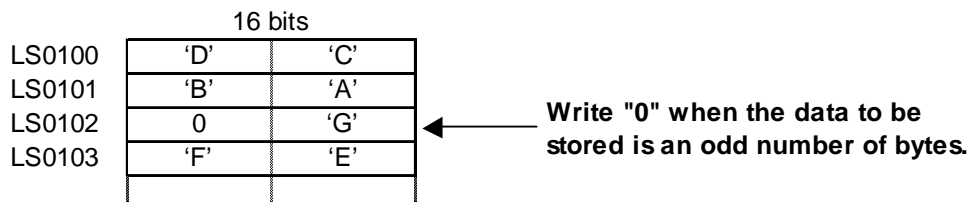

- When the device address length is 32 bits

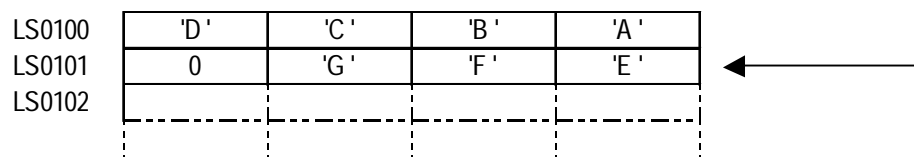

- **The data storage mode is not the same as the string data mode in the system setting. The relationship with the string data mode is shown in the following table.**

Order of data stored in device	Order of bytes stored in word (LH/HL)	Order of bytes stored in double word (LH/HL)	D-Script data storage mode	String Data Mode
Stored from the first data	HL	HL	0	1
	LH		1	2
	HL	LH	2	5
	LH		3	4
Stored from the last data	HL	HL	—	3
	LH		—	7
	HL	LH	—	8
	LH		—	6



- **The CF Card has a data overwrite limit of approximately 100,000 times. Therefore, be sure to backup all CF Card data regularly to another storage media. (assuming that 500KB of DOS format data is overwritten, the limit is 100,000 times)**
- **If an error occurs during CF card processing, the error is written to the CF Card Error Status [s:CF_ERR_STAT]. For details of the CF Card Error Status, [Reference](#) CF card status**
- **The following symbols and characters cannot be used in folder names or file names. Use of these symbols and characters in a folder name or file name will generate an error.
';', ';;', '=', '+', '/', '""', '[', ']', '|', '<', '>', ' ' (space), '?'**
- **To specify a root folder (directory), specify " " (empty string) as the folder name.**
- **To specify a full path for a file name, specify "*" (asterisk) as the folder name.
Example: `_CF_read("*", "\DATA"DATA0001.BIN", [w:LS0100], 0, 10)`**

■ Printer Port Ops.

<Printer Port Output>

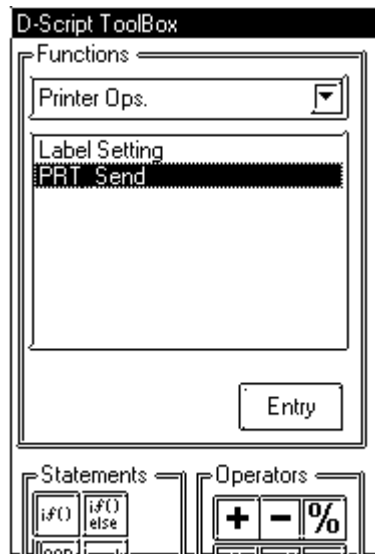

Only GP2000 Series units (except the GP-2301, GP-2301H and GP-2401H units) support this feature.

Printer Port Output

The specified number of bytes of data is output from the printer port. The data is output regardless of the printer type specified.

Parameters

Parameter 1: [p:PRN]

Parameter 2: LS Area

Parameter 3: Integral value, Device address, Temporary address

Format

IO_Write([P:PRN], Start device address where output data will be stored, Number of output bytes)



- ***The maximum numerical value that can be specified for Parameter 3 is 1024. Even when values larger than 1024 are specified, Only 1024 bytes of data are output from the printer port.***

Example statement 1

```
IO_WRITE([p:PRN], [w:LS1000], 10)
```

In the example above, 10 bytes of data stored in LS1000 and later areas are output from the printer port.

Example statement 2

```
IO_WRITE([p:PRN], [w:LS1000], [w:LS0800])
```

In the example above, the data stored in LS1000 and later areas are output from the printer port. The number of bytes is that same as that written in LS0800.

Example statement 3

```
IO_WRITE([p:PRN], [w:LS1000], [t:0010])
```

In the example above, the data stored in LS1000 and later areas are output from the printer port. The number of bytes is that same as that written in the Temporary address [t:0010].

Data storage mode

When data is read from device addresses upon execution of the Printer Port Operation function, you can specify the storage order of the readout data.

Setting the data storage mode in LS9130 may change the storage order.

Select a mode from the four options available: 0, 1, 2 or 3.

◆ **Mode 0**

Example: When the Printer Port Operation function is used to read the string “ABCDEFGG” from a device address

[w:LS9130] = 0

IO_WRITE([p:PRN], [w:LS1000], 7)

- When the device address length is 16 bits

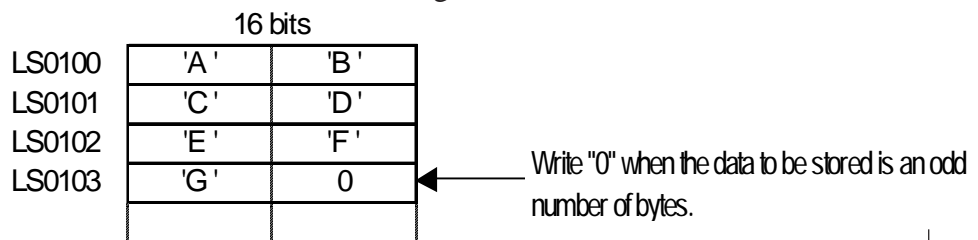

- When the device address length is 32 bits

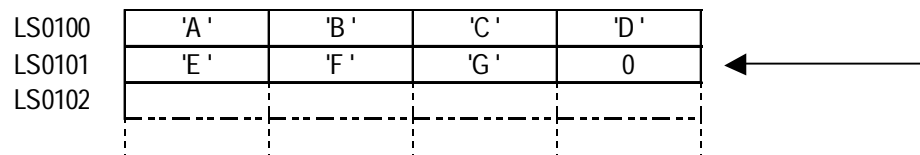

◆ **Mode 1**

Example: When the Printer Port Operation function is used to read a string “ABCDEFGG” from a device address

[w:LS9130] = 1

IO_WRITE([p:PRN], [w:LS1000], 7)

- When the device address length is 16 bits

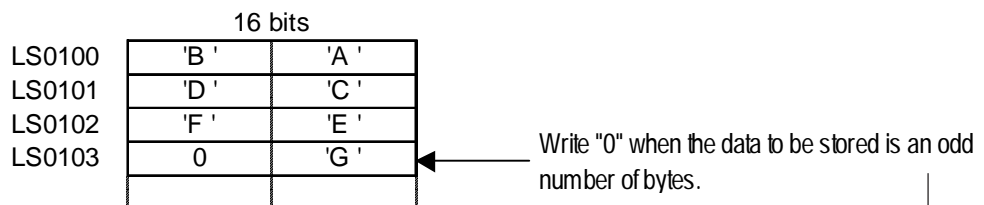

- When the device address length is 32 bits

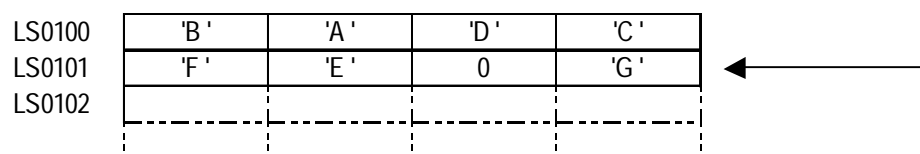

◆ **Mode 2**

Example: When the Printer Port Operation function is used to read a string “ABCDEFGG” from a device address

[w:LS9130] = 2

IO_WRITE([p:PRN], [w:LS1000], 7)

- When the device address length is 16 bits

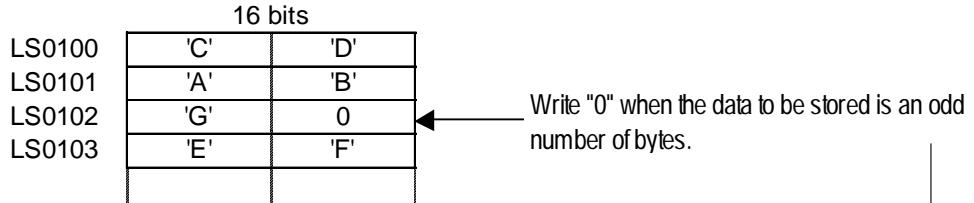

- When the device address length is 32 bits

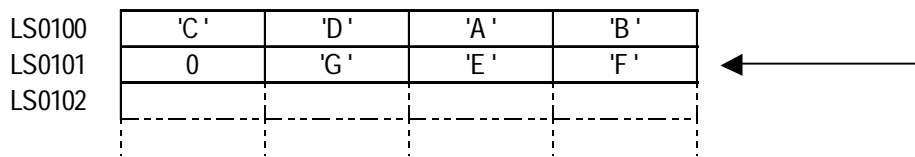

◆ **Mode 3**

Example: When the Printer Port Operation function is used to read a string “ABCDEFGG” from a device address

[w:LS9130] = 3

IO_WRITE([p:PRN], [w:LS1000], 7)

- When the device address length is 16 bits

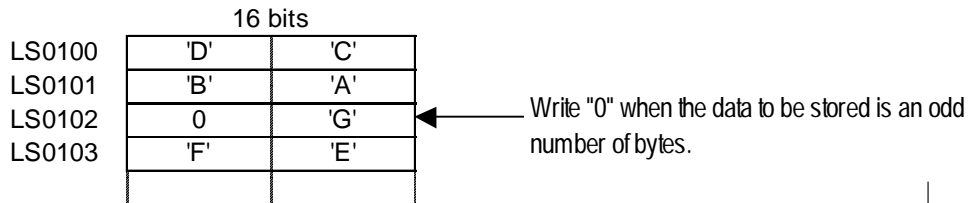

- When the device address length is 32 bits

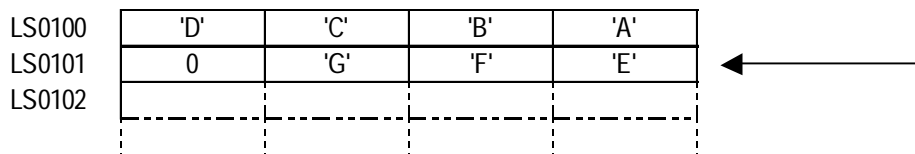

- **Data storage mode is not the same as string data mode in the system settings. The following table shows the relationship with string data mode.**

Order of data stored in device	Order of bytes stored in word (LH/HL)	Order of bytes stored in double word (LH/HL)	D-Script data storage mode	String Data Mode
Stored from the first data	HL	HL	0	1
	LH		1	2
	HL	LH	2	5
	LH		3	4
Stored from the last data	HL	HL	—	3
	LH		—	7
	HL	LH	—	8
	LH		—	6

<Label Settings>

■ Control

For the Printer Port Operation function, the new control variable PRN_CNTRL is added in order to clear the send buffer or error status. The Control variable is write-only.

- Contents of Control variable (PRN_CNTRL)

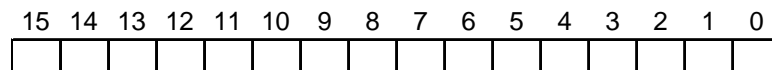

Bit	Content
15	Reserved
14	
13	
12	
11	
10	
9	
8	
7	
6	
5	
4	
3	
2	1: Clear error
1	Reserved
0	1: Clear send buffer



- **When a word is designated (when two or more bits are set simultaneously), processing is executed in the following order:**

Clear error



Clear send buffer

- **Since reserved bits may be used in the future, be sure to designate only the bits that are required.**

■ **Status**

For the Printer Port Operation function, the new control variable PRN_STAT is added in order to check for the presence/absence of data in the send buffer or the error status. The Status variable is read-only.

- Contents of Status variable (PRN_STAT)

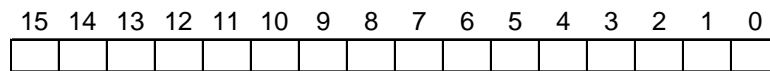

Bit	Content
15	Reserved
14	
13	
12	
11	
10	
9	
8	
7	
6	
5	
4	
3	
2	
1	0: Normal 1: Transmission error
0	0: Data present in Send buffer 1: Send buffer is empty.



- **One of the transmission errors is the Send buffer overflow error. Should this error occur, the transmission error bit turns on.**
- **The Send buffer is 8192 bytes.**
- **The reserved bits may be used in the future; therefore, designate only the bits that are required.**

3.2.4 Example Communication Using Extended SIO

The command to read from of the variable area, a communication command for Omron’s thermoregulator, is described below in a simple example.

In the variable area to be read, the current value indicated by the thermostat and the target value are illustrated. The current value and the target value are read out every 10 seconds through communication between the GP and the thermostat. The following is an illustration of the communication.

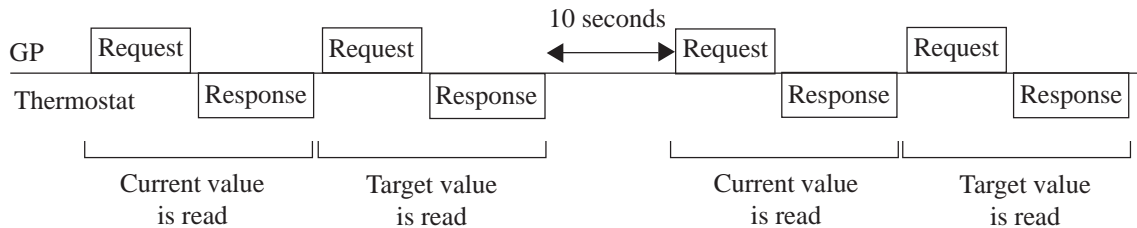

■ Data Format

The following data format is used to communicate with the thermoregulator.

Read out of the current value

- Command Frame (24 bytes)

← BCC calculation range											
0x02	0	1	0	0	0	0	1	0	1	C	0
STX	Node No.		Sub-address			SID	MRC	SRC		Type of variable	

→													
0	0	0	0	0	0	0	0	0	0	0	1	0x03	0x40
Starting read address				Bit position			Number of elements				ETX	BCC	

- Response Frame (25bytes)

← BCC calculation range														
0x02	0	1	0	0	0	0	0	1	0	1	0	0	0	0
STX	Node No.		Sub-address			End code		MRC	SRC		Response code			
→														
*	*	*	*	*	*	*	*	*	0x03	*				
Read data										ETX	BCC			

Reading the target value

- Command Frame (24 bytes)

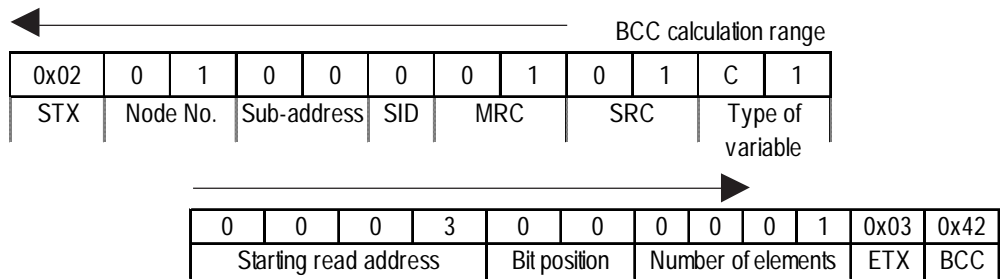

- Response Frame (25 bytes)

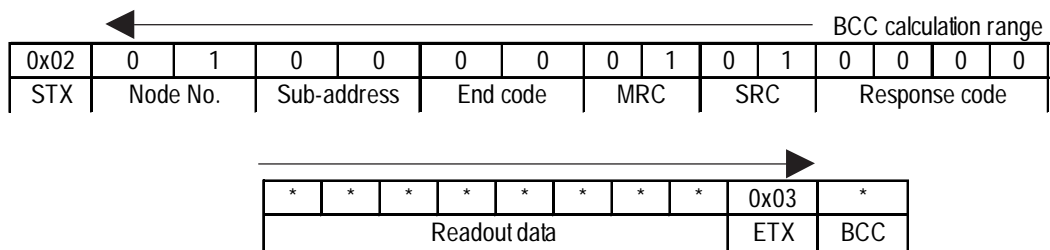

For more information on the above, refer to the communication specifications for Omron’s thermoregulator.

◆ **The tables below list the Extended SIO Script and Extended SIO Script Functions utilized with this system.**

Refer to this manual to create an Extended SIO Script and Extended SIO Script Functions

• **Extended SIO Script**

(1) Main Routine Processing	This is the main processing of the communication. Reads out the current and target values of the temperature controller at 10-second intervals.
-----------------------------	-------------------------------------------------------------------------------------------------------------------------------------------------

• **Extended SIO Script Function**

(2) Initialization Function (INIT)	Initialization required for the communication. This function is executed only once before communication is started.
(3) Transmit/Receive Function 1 (COMM_READ1)	This function reads out the current value of the temperature controller. Sends commands for the temperature controller and receives the responses.
(4) Transmit/Receive Function 2 (COMM_READ2)	This function reads out the target value of the temperature controller. Sends commands to the temperature controller and receives the responses.
(5) Transmit Function 1 (TRANS_FUNC_R1)	This function sends commands for reading out the current value of the temperature controller. Sets the values used as commands in the data buffer and transfers the command.
(6) Receive Function 1 (RCV_FUNC_R1)	This function receives the response to the command (readout of the current value). The received data are stored in the LS area.
(7) Transmit Function 2 (TRANS_FUNC_R2)	This function sends commands for reading out the target value of the temperature controller. Sets the values used as the commands in the data buffer and transfers the command.
(8) Receive Function 2 (RCV_FUNC_R2)	This function receives the response to the command (readout of the target value). The received data are stored in the LS area.

◆ Flow Charts

(1) Main Routine Processing

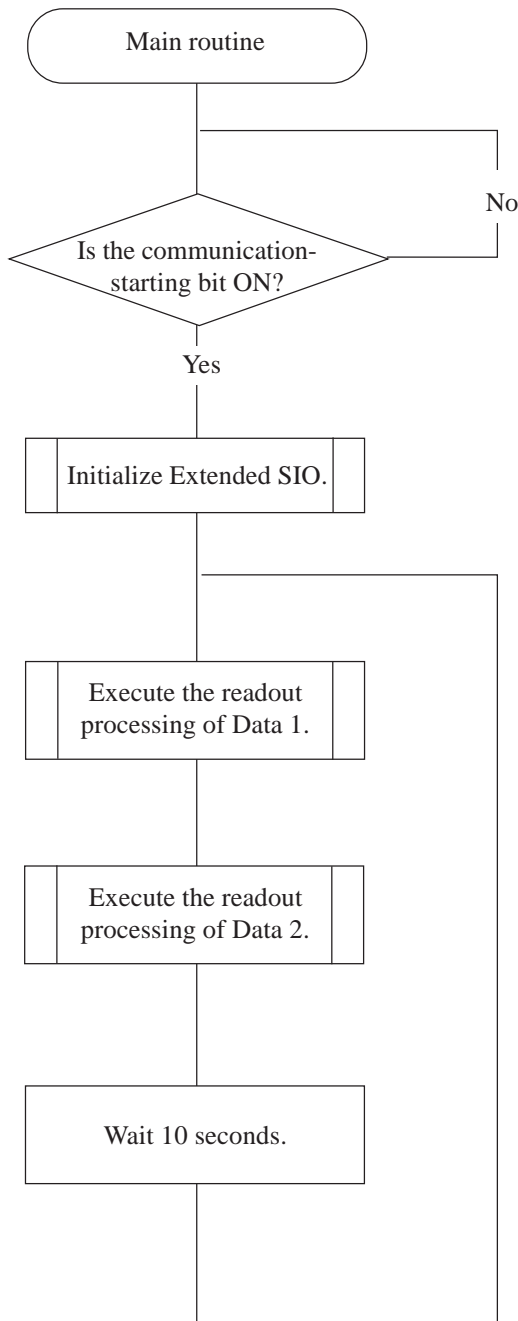

(2) Initialization Function (INIT)

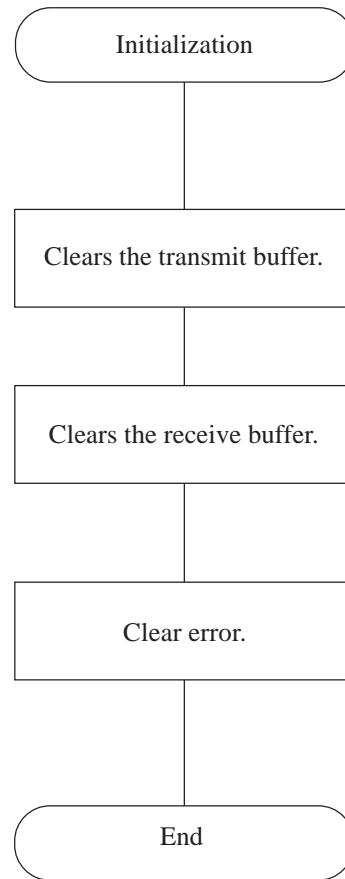

(3) Transmit/Receive Function 1
(COMM_READ1)

(4) Transmit/Receive Function 2
(COMM_READ2)

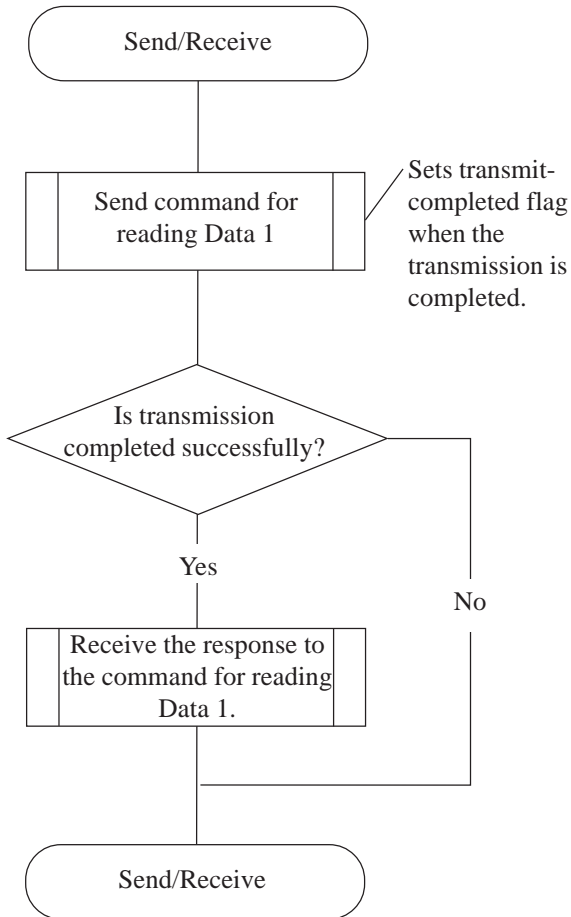

(5) Transmit Function 1
(TRANS_FUNC_R1)

(7) Transmit Function 2
(TRANS_FUNC_R2)

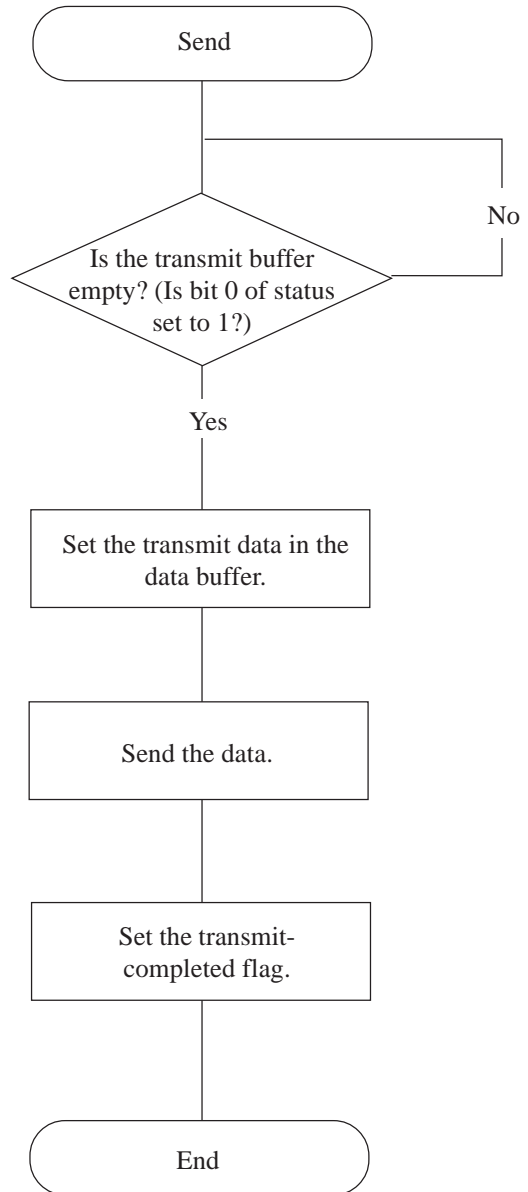

(6) Receive Function 1 (RCV_FUNC_R1)

(8) Receive Function 2 (RCV_FUNC_R2)

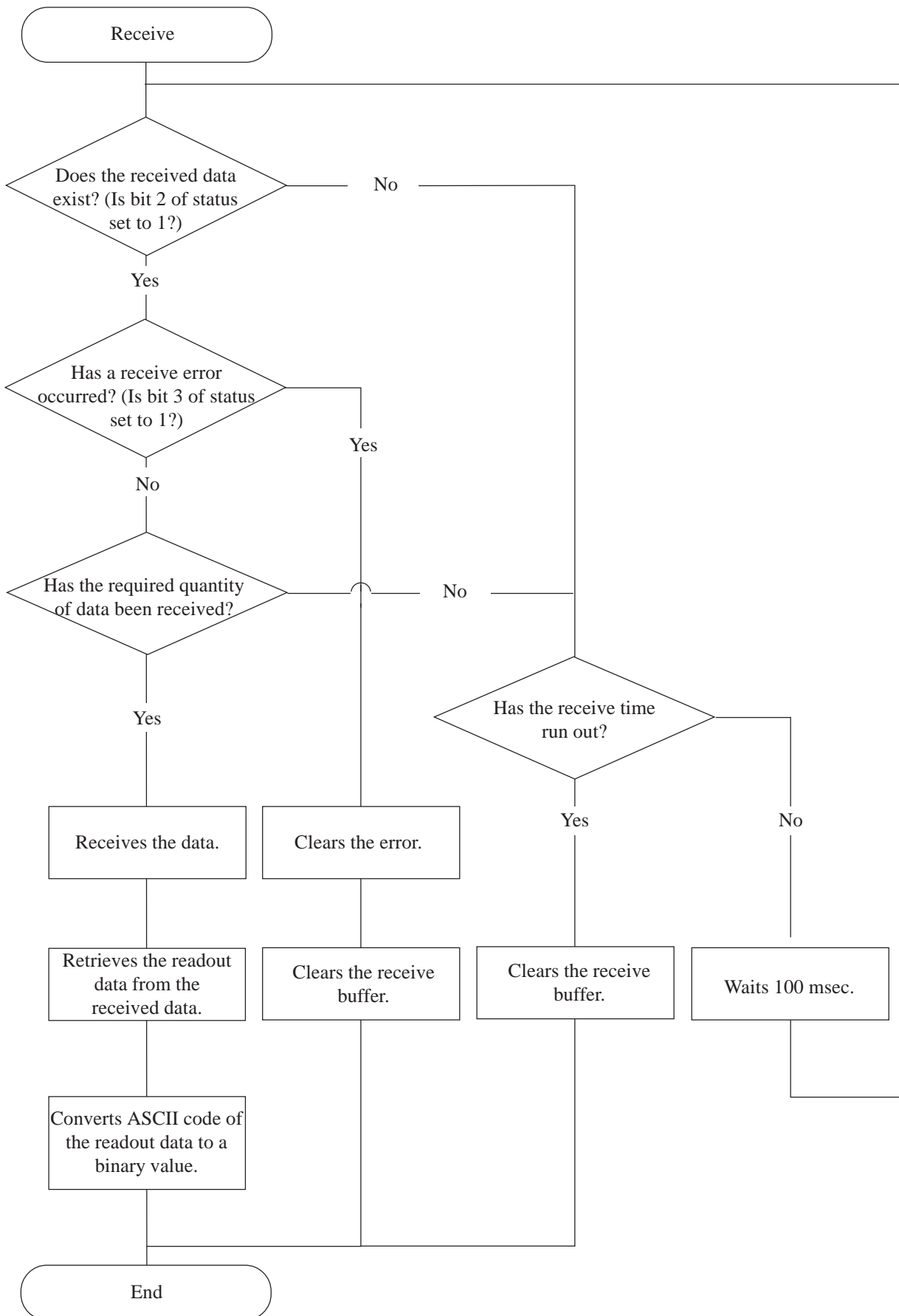

(1) Main Routine Processing

```

if ([b: LS005000]==1)      // Trigger bit is turned ON with touch switch.
{
  Call INIT                // Initialization of Extended SIO.
  loop
  {
    Call COMM_READ1        // Current value of temperature management system is read out.
    Call COMM_READ2        // Target value of temperature management system is read out.
    _wait (100)            // Waits for expiration of timer before starting transmission. (10 seconds)
  }
  endloop
}
endif

```

(2) Initialization Function (INIT)

```

[c: EXT_SIO_CTRL00]=1     // Clears the transmit buffer.
[c: EXT_SIO_CTRL01]=1     // Clears the receive buffer.
[c: EXT_SIO_CTRL02]=1     // Clears the error.

```

(3) Transmit/Receive Function 1 (COMM_READ1)

```

[t: 0000]=0               // Clears the transmission processing completion flag.
Call TRANS_FUNC_R1        // Sends the data 1 read command.
if ([t: 0000]==1)         // Has transmission been completed successfully?
                          // (Is the transmit processing completion flag set?)
{
  Call RCV_FUNC_R1        // Receives a response to the data 1 read command.
}
endif

```

(4) Transmit/Receive Function 2 (COMM_READ2)

```

[t: 0000]=0               // Clears the sent flag.
Call TRANS_FUNC_R2        // Sends the read data 2 command.
if ([t: 0000]==1)         // Has transmission been completed successfully?
                          // (Is the transmit completion flag set?)
{
  Call RCV_FUNC_R2        // Receives a response to the data 2 read command.
}
endif

```

(5) Transmit Function 1 (TRANS_FUNC_R1)

```

loop ()
{
  if ([s: EXT_SIO_STAT00]==1)           // Is the transmit buffer empty?
  {
    break
  }
  endif
}
endloop
_strset (databuf0, "")                 // Initializes the data buffer for data transmission.
_strset (databuf0, 0x02)                // Sets STX.
_strset (databuf0, "010000101C00000000001" // Concatenates the read command.
// (Creates the command for reading out the current value.)
_strcat (databuf0, 0x03)                // Concatenates ETX.
_strcat (databuf0, 0x40)                // Concatenates BCC.

_strlen ([t: 0001], databuf0)          // Obtains the transfer data size (number of bytes)
IO_WRITE_EX ([p: EXT_SIO], databuf0, [t: 0001]) // Outputs to Extended SIO.
[t: 0000]=1

```

(6) Receive Function 1 (RCV_FUNC_R1)

```

[t: 0002]=10000 // Sets the receive timer.

loop ()
{
  if ([s: EXT_SIO_STAT02]==1) // Received data is present.
  {
    if ([s: EXT_SIO_STAT03]==1) // Receiving error has occurred.
    {
      [c: EXT_SIO_CTRL02]=1 // Clears error.
      [c: EXT_SIO_CTRL01]=1 // Clears receive buffer.
      return // Processing completed.
              (Error is completed.)
    }
  }
  else
  {
    if ([r: EXT_SIO_RECV]>=25) // Has required quantity of data been
                                received?
    {
      _strset (databuf2, "") // Initializes data-receiving buffer.
      _strset (databuf3, "") // Initializes temporary data buffer.

      IO_READ_EX ([p: EXT_SIO], databuf2, 25) // Obtains the receive data.
      _strmid (databuf3, databuf2, 19, 4) // Retrieves the readout data from the
                                           data-receiving buffer.

      _hexasc2bin ([w: LS2001], databuf3) // Converts the character string into
                                           numerical data.

      return // Data-receiving operation is completed.
    }
  }
  endif
}
endif

if ([t: 0002]==0) // Has the receive time run out?
{
  [c: EXT_SIO_CTRL01]=1 // Clears receive buffer.
  [t: 0000]=1 // Sets the receive processing completion
              flag.

  return // Processing completed.
          (Error is completed.)
}
endif

[t: 0002]=[t:0002]-100 // Decrements the timer.
_wait (1) // Waits 100 msec.
}
endloop

```

(7) Transmit Function 2 (TRANS_FUNC_R2)

```

loop ()
{
  if ([s: EXT_SIO_STAT00]==1)           // Is send buffer empty?
  {
    break
  }
  endif
}
endloop

_strset (databuf0, "")                  // Initializes the data buffer for data transmission.
_strset (databuf0, 0x02)                // Sets STX.
_strset (databuf0, "010000101C10003000001" // Concatenates the read command.
                                                // (Creates the command for reading out the target
                                                // value.)
_strcat (databuf0, 0x03)                // Concatenates ETX.
_strcat (databuf0, 0x42)                // Concatenates BCC.

_strlen ([t: 0001], databuf0)           // Obtains the transfer data size (number of bytes).
IO_WRITE_EX ([p: EXT_SIO], databuf0, [t: 0001]) // Outputs to the Extended SIO.
[t: 0000]=1

```

(8) Receive Function 2 (RCV_FUNC_R2)

```

[t: 0002]=10000 // Sets the receive timer.
loop ()
{
  if ([s: EXT_SIO_STAT02]==1) // Received data is present.
  {
    if ([s: EXT_SIO_STAT03]==1) // Receiving error has occurred.
    {
      [c: EXT_SIO_CTRL02]=1 // Clears error.
      [c: EXT_SIO_CTRL01]=1 // Clears receive buffer.
      return // Processing completed.
              (Error is completed.)
    }
  }
  else
  {
    if ([r: EXT_SIO_RECV]>=25) // Has the required quantity of data been
                                received?
    {
      _strset (databuf2, "") // Initializes the data-receiving buffer.
      _strset (databuf3, "") // Initializes the temporary data buffer.

      IO_READ_EX ([p: EXT_SIO], databuf2, 25) // Obtains the receive data.

      _strmid (databuf3, databuf2, 19, 4) // Retrieves the readout data from the
                                           data-receiving buffer.

      _hexasc2bin ([w: LS2002], databuf3) // Converts the character string into
                                           numerical data.
      return // Data-receiving operation is completed.
    }
  }
  endif
}
endif

if ([t: 0002]==0) // Has the receive time run out?
{
  [c: EXT_SIO_CTRL01]=1 // Clears receiving buffer.
  return // Processing is completed.
          (Error is completed.)
}
endif

[t: 0002]=[t:0002]-100 // Decrements the timer.
_wait (1) // Waits 100 msec.
}
endloop

```

3.3 Data Sampling Settings

3.3.1 Overview

Data of arbitrary word addresses can be stored in the LS area in chronological order. To back up the trend graph data, use the stored data in conjunction with the channels of the trend graph (tags and parts).

3.3.2 About Data Sampling Settings

- ◆ The specified Word Address data is sampled each specified time or with a desired time cycle and stored it into the LS Area via the trigger bit.
- ◆ Data can be sampled per word, and data for up to 640 words can be stored in series.
- ◆ Sampled data can now be backed up. As shown in the following page, check the Backup's Data Backup check box in the Data Format tab. The backed up data can be stored in the LS Area via the Trigger Bit.
- ◆ Decide a channel name for each piece of sampling data.
- ◆ The GP2000 series accommodates a maximum of 40 channels for the entire system, including Trend Graph channels; other models can accommodate up to 20 channels, including Trend Graph channels. When the number of channels exceeds the limit, the 41st and subsequent channels on the GP2000 series and the 21st and subsequent channels on other models are disabled according to the following rules.
 - Data sampling will be given priority over trend graphs.
 - Data sampling channel numbering will begin from those set previously.

3.3.3 Using Channel Settings

Select the [Special/Data Sampling] from the Screen Editor.

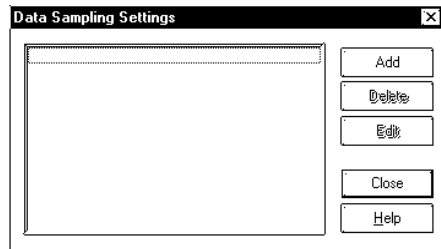

Add

Use this button to set a new channel.

Delete

Use this button to delete a channel which has been set. Select the channel name then press the “Delete” key.

Edit

Use this button to edit a channel which has been set. Select the channel name then press the “Edit” key.

General Info.

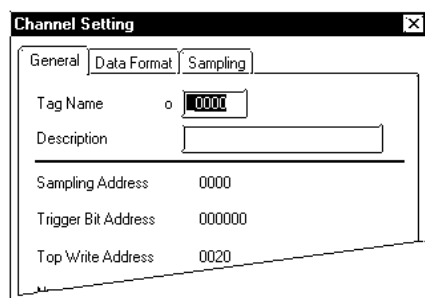

The General Info. page provides information about the current channel settings for the Trend Graph Display.

Tag Name

Must be no more than five Single-byte or two Double-byte characters long and composed of letters and/or symbols.

Description

Up to 20 Single-byte or 10 Double-byte characters can be entered as a description.

Data Format

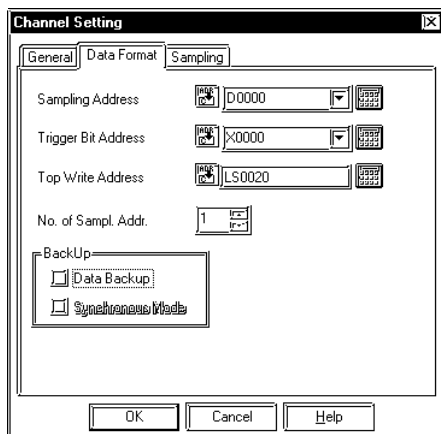

Sampling Address

Designates the Word Address to be sampled.

Trigger Bit Address

When the bit address stored here turns ON, the sampled data will be stored into the LS Area.

Top Write Address

Specifies the LS Area’s data storage start address. The “Start address + Sampling data count +1” must not be in the user area.

	GP2000 Series	Other models
User Area	LS20 to LS2031 and LS2096 to LS8191	LS20 to LS2031 and LS2096 to LS4095

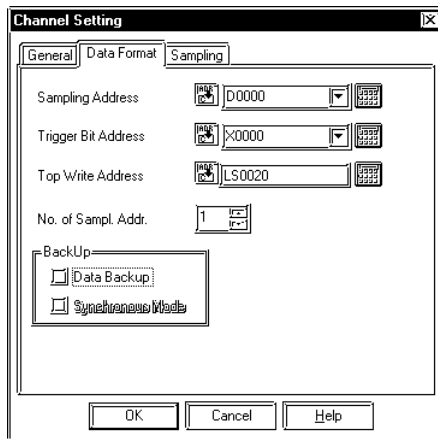
**No. of Sampl. Addr.**

Designates the number of sampled data (items) to be stored.

BackUp *1**Data Backup**

The sampled data will be backed up in the GP's backup memory.

Synchronous Mode

With this mode selected, when the GP's power is turned ON, data will be sampled following that data stored before the GP's power was turned OFF. With this mode unselected, when the GP's power is turned ON, data sampling will start from the value "0". For normal operation, select this mode.

**Important**

- **This feature is effective only for the unit with the backup SRAM built in.**
- **The GP70 series unit in which the backup SRAM is built has a copper colored label on the rear of the unit. Also, the GP77R, GP377, and GP2000 series units all have the backup SRAM built in.**

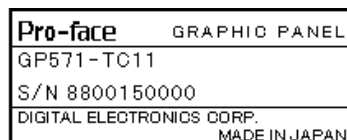

Data stored in the backup SRAM is erased when:

- **The memory is initialized.**
- **Screen data is transmitted.**
- **The GP system and protocol are set up.**
- **The GP self-diagnosis "Internal FEPRAM (screen area)" is performed.**
- **The GP offline is set up. However, if the GP system's version is 1.30 or higher (the GP-PRO/PBIII for Windows95 Ver. 2.0 or higher), backup SRAM data is not erased.**

*1 The PLCs listed in section 1.3 Tag List's note section - *5, cannot use the "Backup" feature.

◆ **Data Storage Example**

The following is an example of data stored from the storage start address. The sampling data is stored to Data “n” while the sampling data count is “m”. When the trigger bit is turned ON, the data is stored into the LS Area.

- The stored data count is stored in the storage start address.
- The stored data count number “n” is in the Bin format.
- When the stored data count is less than the sampling data count, the Word Addresses up to that number will be cleared to “0”.

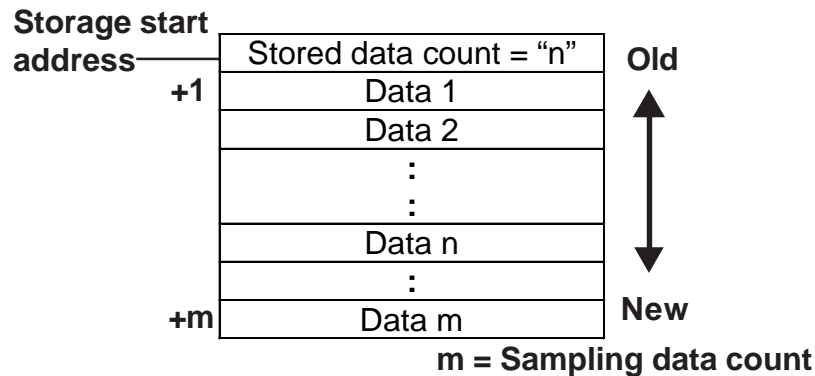

■ **Sampling**

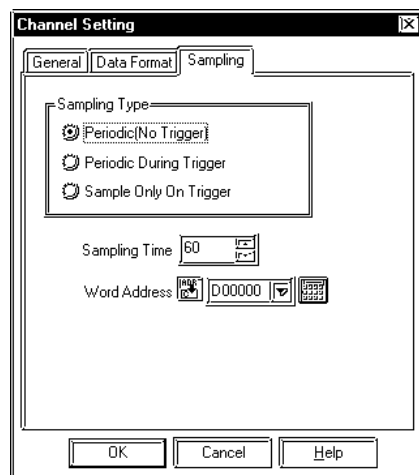

Sampling Type

The method to import data from the host (PLC) is specified from the following: Periodic, Trigger Control, and Trigger Sampling.

Periodic (No Trigger)

The host (PLC) data is imported at the setup intervals starting from when the GP is powered up.

Periodic During Trigger

The host (PLC) data is imported at the setup intervals. The data import start, pause, and clear commands will be performed according to changes to the corresponding bit in the specified Word Address.

Sample Only On Trigger

The data is sampled at the desired timing setup. Data import and data clear will be performed according to changes to the corresponding bit in the setup Word Address.

Sampling Time

Specifies the sampling time, in 1 second units, for the import of host (PLC) data.

Word Address (When Periodic During Trigger option is selected)

The 00 and 01 bits of the Word Address specified here will control the data import start, pause, and clear operations.

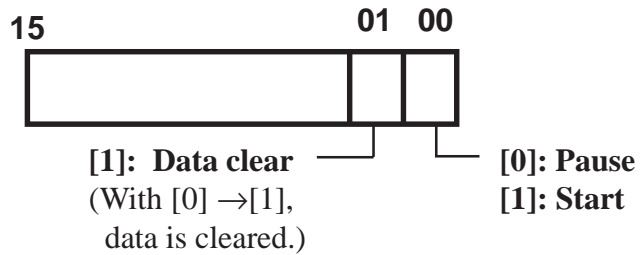
**Word Address** (When Sample Only On Trigger option is selected)

The 00 and 01 bits of the Word Address settings control the Data Read Start and Clear operations.

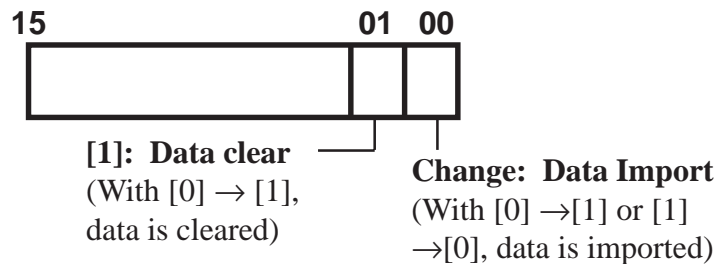

Please wait until the GP confirms the status of the control bits - i.e. whether they are "0" or "1" (For Direct Access communication, either the communication cycle time or 50ms, whichever is longer).



A delay of up to 1 second may occur from the time of data import start to actual data sampling.

3.3.4 Data Sampling CSV File Storage Example

This example opens a data sampling CSV file in Excel, that was stored in a CF card.

For CSV file storage procedures, **Reference** 4.7.2 CF Card Features

This feature is effective only on GP77R and GP2000 series units.

• **CSV File**

```

"Channel Name", "012345", "01a2b3"
"No. of Samples", "15", "8"
"Current No. of Samples", "8", "5"
"Data", "32768", "23456"
"", "90.0", "70.0", "80.0"
"", "65535", "64553"
"", "24682", "32768"
"", "32767", "56666"
"", "9999", "11111"
"", "65535", ""
"", "32768", ""
"", "45564", ""
    
```

• **Opened in Excel**

Channel Name	012345	01a2b3
No. of Samples	15	8
Current No. of Samples	8	5
Data	32768	23456
	65535	64553
	24682	32768
	32767	56666
	9999	11111
	65535	
	32768	
	45564	

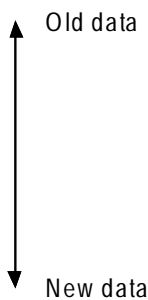

- Only the sampled data is output as CSV files.
- Data sampling data's range is 0 to 65535, whether it is 16 bit device or 32 bit device.



4 Advanced Features

The advanced features explained in this chapter have been newly added in order to enhance GP's operation performance. Prior to using these advanced features, however, please thoroughly understand the features described in Chapters 2 and 3.

4.1 Sound Output

4.1.1 Overview

Turning a Monitor Bit ON triggers sound data output from the GP unit. For sound output, connect an external speaker system. Optional Multi Units are required for the GP-477R, GP-577R, GP-2401, GP-2501 and GP-2601 series.

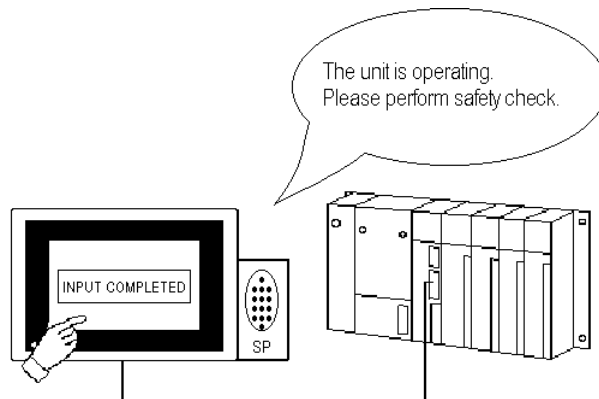

* This feature is supported only by the GP77R (except GP-377R), GP-2400T, GP-2500T and GP-2600T series units.

4.1.2 About Sound Output

- The GP's sound data is PCM, 16 Bit, 11kHz WAV data. This type of WAV file is used for all creation and storing of the GP's sound data.
- To convert WAV data to GP sound data, select the Project Manager's [Sound Settings]'s [Create Sound Data selection].
- Store sound data in either GP's internal memory or on a CF card. Please note that the CF card can hold more sound data than the GP.
- The following three modes of sound output are available:
 - Repeat Play Mode
While the Bit is ON, sound data is output. When multiple start Bits are ON, all sound data is repeatedly output.
 - Play Mode
When the Trigger Bit is turned ON, sound data is output only once.
 - Play (Bit OFF) Mode
When a Trigger Bit is turned ON, sound data is output only once, and then the Trigger Bit is turned OFF. This mode is Enabled only with the LS Area.
- When a Trigger Bit is turned OFF, sound data output can also be canceled.

* This feature is supported only by the GP77R (except GP-377R), GP-2400T, GP-2500T and GP-2600T series units.



Note: When more than 1 Start Bit turns ON at the same time, the sound items are normally output according to the sound setting's order. However, the order may differ depending on the timing of the read out of the transmitted data.

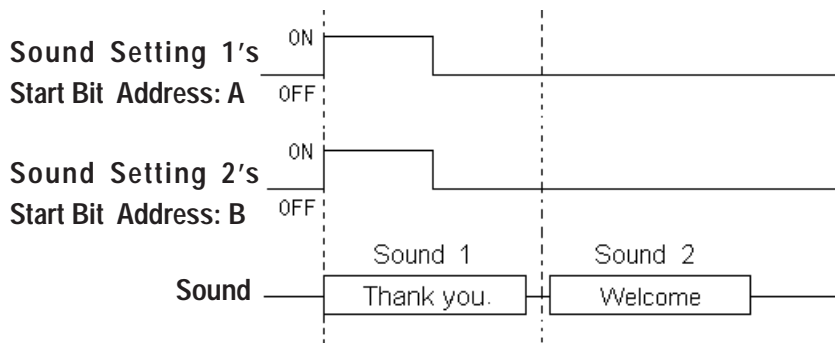

Note: If Repeat Play is being used with one sound item and another Repeat Play sound item's Start Bit turns ON, in the following Repeat Play operation these sound items will be output according to the sound setting's order.

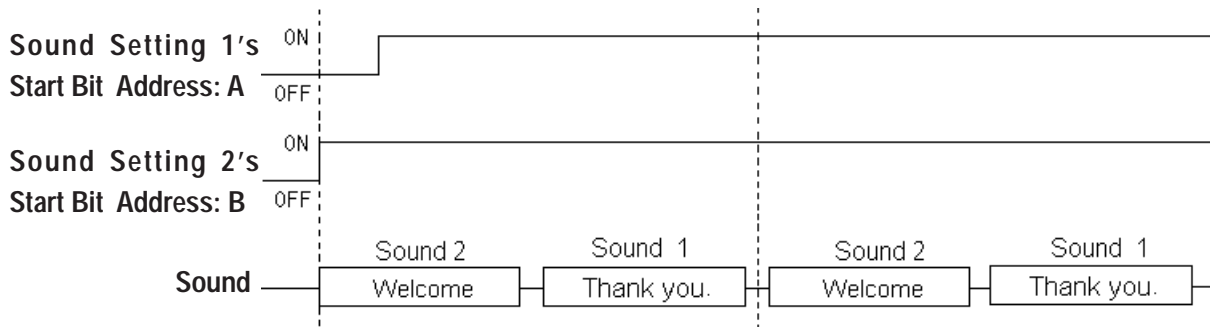

When 2 or more Start Bits turn ON at the same time, the sound items are normally output according to the sound setting's order. However, the output orders shown in the examples below may differ since the order of sound output can change due to the timing of the read out of the transmitted data.

E.g. 1)

When the Repeat Play mode sound setting (1, 2 and 3) Start Bits turn ON at the same time, the sound output order is:

1 → 2 → 3 → 1 → 2 → 3 • • •

E.g. 2)

When the Repeat Play mode sound setting (1, 2 and 3) Start Bits turn ON in "3→2→1" order following each sound setting's output (i.e, while sound setting 3 is being output, sound setting 2's Bit is turned ON, and while sound setting 2 is being output, sound setting 1's Bit is turned ON), the sound output order is:

3 → 2 → 1 → 1 → 2 → 3 • • •

* This feature is supported only by the GP77R (except GP-377R), GP-2400T, GP-2500T and GP-2600T series units.

4.1.3 Sound Output Settings

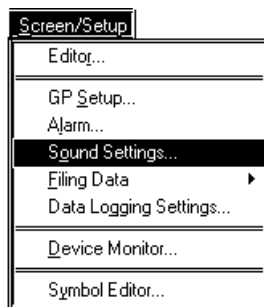

Sound Settings

After selecting the Project Manager's [Sound Settings] selection, the following menu will appear.

■ Sound Settings

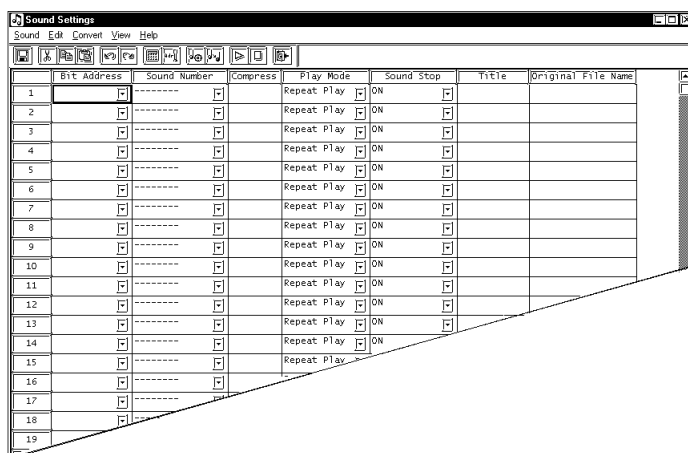

◆ Bit Address

Sets up the Trigger Bit Addresses to output sound data.

◆ Sound No.

Selects the desired sound data file number to be converted from WAV data.

◆ Compress

Displays sound data's compression status, i.e. compressed or not compressed.

◆ Play Mode

- Repeat play
- Play
- Play (Bit Off)

◆ Sound Stop

Selects the sound data's output cancel conditions, i.e. if cancellation is Enabled or not.

◆ Title

Displays the selected sound data's title.

◆ Original Wav File Names

Displays the file names that were converted to a WAV data file.



Note:

Up to 128 types of sounds can be set up.

* This feature is supported only by the GP77R (except GP-377R), GP-2400T, GP-2500T and GP-2600T series units.

4.1.4 Sound Output Setting Examples

■ Creating Sound Data

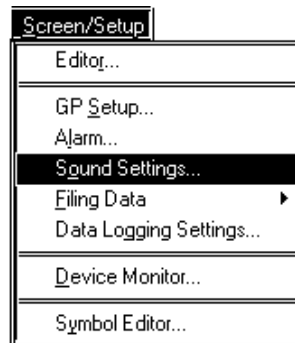

Select the Project Manager's [Screen/Setup] menu – [Sound Settings...] command.

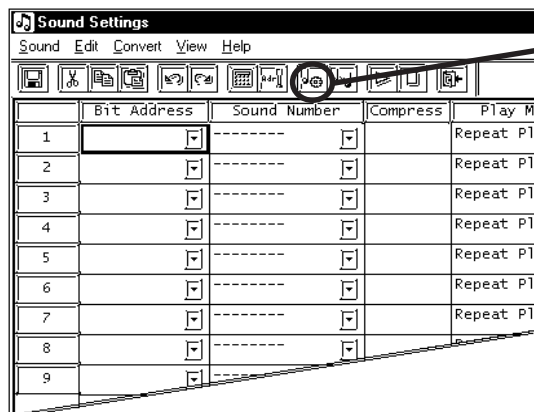

Click on the icon, or select [Convert] menu – [Create Sound Data] command.

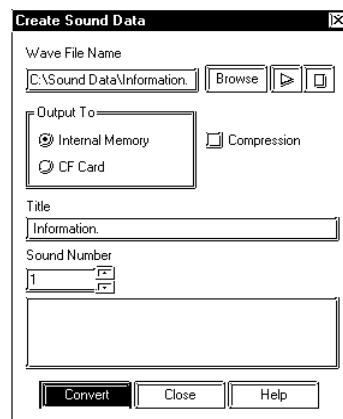

Click on the [Browse] button. Select a file to be converted or enter the file name. Then, select the data write destination and enter Title and Sound Number. To compress data after conversion via the [Convert] button, check the [Compression] check box.



Note: • **Reference** 4.7.4 External Storage of GP-PRO/PB III data

The Wav file size that can be converted will differ depending on the data write destination.

For internal memory: **Approximately 50KB when compressed (approximately 8 seconds)**

For CF card: **Depends on CF card's amount of free space**

- A Title can be entered using up to 30 Single-byte characters (or 15 Double-byte characters). If the existing sound number is designated, a prompt appears asking if the new data should overwrite the old.
- To import sound data from the optional library CD, select a file with an extension of "daf".

* This feature is supported only by the GP77R (except GP-377R), GP-2400T, GP-2500T and GP-2600T series units.

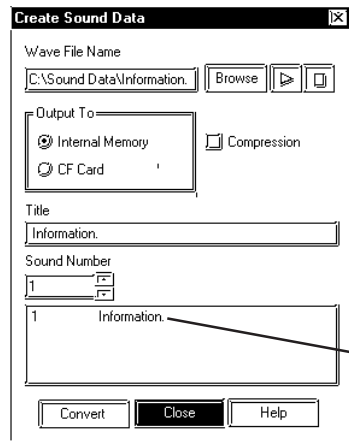

Click on the [Close] button to return to the sound data window.

Displays the converted data

■ Changing Sound Data

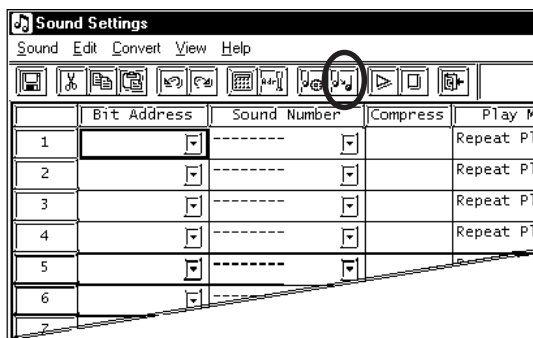

Click on the icon, or select the [Convert] menu – [Change Attribute Sound Data] command.

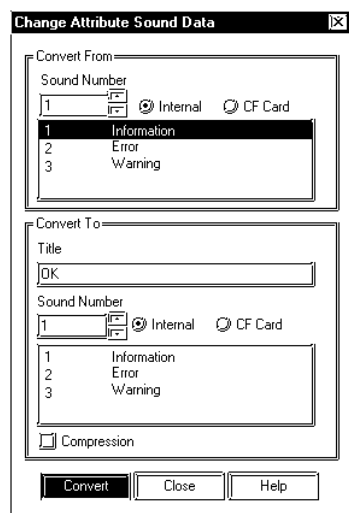

Select the data to be changed. Change the Title and Sound Number, then click on the [Convert] button.

* This feature is supported only by the GP77R (except GP-377R), GP-2400T, GP-2500T and GP-2600T series units.

■ Deleting Sound Data

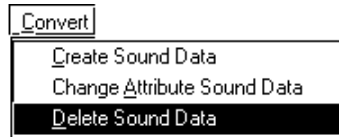

Select the [Convert] menu – [Delete Sound Data] command.

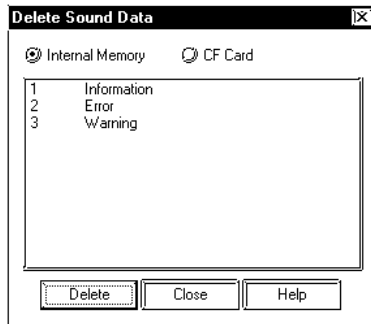

A list of previously created sound data files will appear.

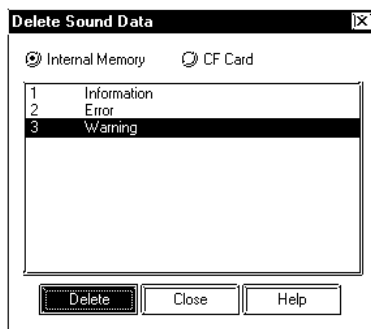

Select sound data to be deleted from the list, and click on the [Delete] button.

* This feature is supported only by the GP77R (except GP-377R), GP-2400T, GP-2500T and GP-2600T series units.

■ Automatic Address Allocation

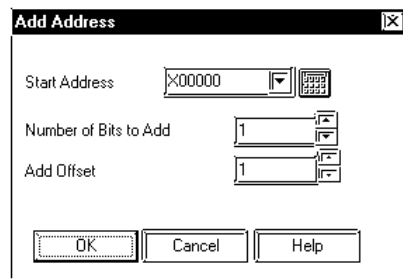

The Trigger Bit Address used to output sound data is automatically allocated and the Start Address is entered.

Enter the number of Addresses to be allocated in the [Number of Bits to Add] field. Addresses will be allocated in series for the entered number beginning from the Start Address.

[Add Offset] is a feature to allocate Addresses in Bit or Word by the designated increment.

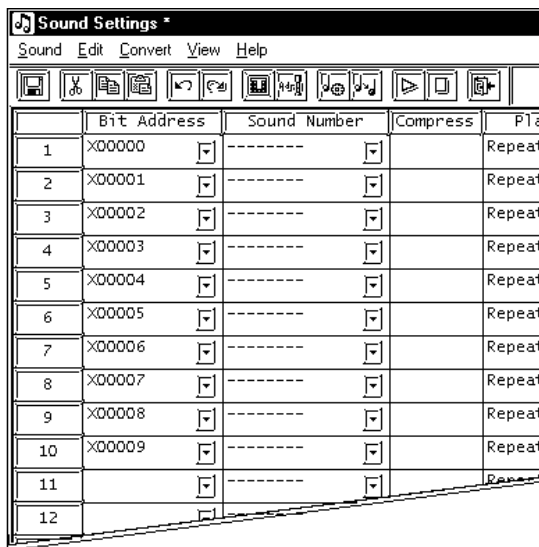

Automatic Address Allocation can also be performed via selecting the [Edit] menu – [Automatic Address Allocation] command. When a Symbol is designated as the Start Address, the added Address will be displayed as follows:

e.g.) When the Start Address:

TEST ← Symbol,

and

Number of Bits to be added: 4,

Addresses will be added in series, as follows:

TEST

TEST + 1

TEST + 2

TEST + 3



When selecting a desired sound data file from the sound data list that has already been created via [Sound Number], the details of data will be displayed. (See the picture below.)

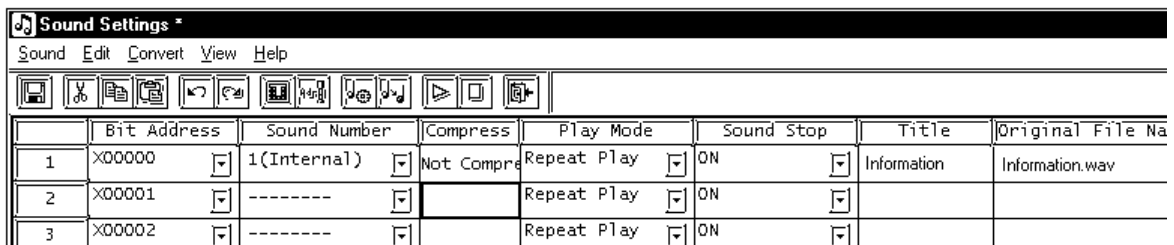

* This feature is supported only by the GP77R (except GP-377R), GP-2400T, GP-2500T and GP-2600T series units.

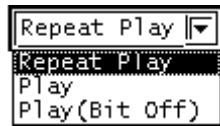

Select a desired repeat play method from [Repeat play], [Play], and [Play (Bit Off)].



Designate the Sound Stop status, i.e. ON or OFF.

Reference 4.1.4 Sound Output
Setting Examples

After all the necessary items are designated, save the sound settings. (See the picture on the following page.)

Sound Settings *							
Sound Edit Convert View Help							
	Bit Address	Sound Number	Compress	Play Mode	Sound Stop	Title	Original File Name
1	X00000	1(Internal)	Not Compre	Repeat Play	ON	Information	Information.wav
2	X00001	2(CF Card)	Not Compre	Play	ON	Information	Information.wav
3	X00002	1(Internal)	Not Compre	Repeat Play	ON	Information	Information.wav
4	X00003	1(Internal)	Not Compre	Repeat Play	OFF	Information	Information.wav
5	X00004	2(CF Card)	Not Compre	Play(Bit Off)	ON	Error	Error.wav
6	X00005	1(Internal)	Not Compre	Repeat Play	ON	Information	Information.wav
7	X00006	1(Internal)	Not Compre	Play	OFF	Information	Information.wav
8	X00007	1(Internal)	Not Compre	Play(Bit Off)	OFF	Information	Information.wav
9	X00008	2(CF Card)	Not Compre	Repeat Play	ON	Information	Information.wav
10	X00009	1(Internal)	Not Compre	Play	ON	Information	Information.wav
11		-----		Repeat Play	ON		
12		-----		Repeat Play	ON		

* This feature is supported only by the GP77R (except GP-377R), GP-2400T, GP-2500T and GP-2600T series units.

4.1.5 Sound Data Output

■ Play mode: Repeat play Sound Stop: Disabled

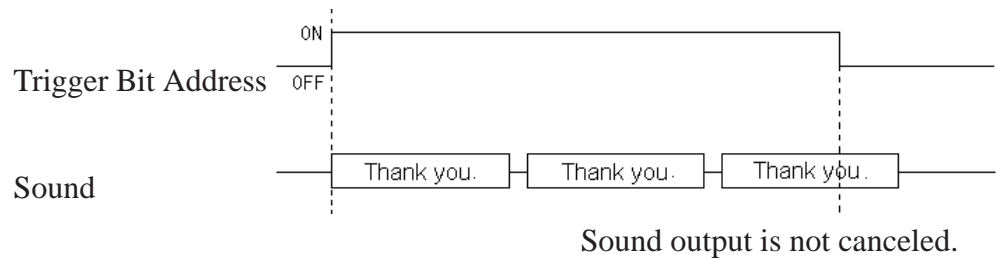

■ Play mode: Repeat play Sound Stop: Enabled

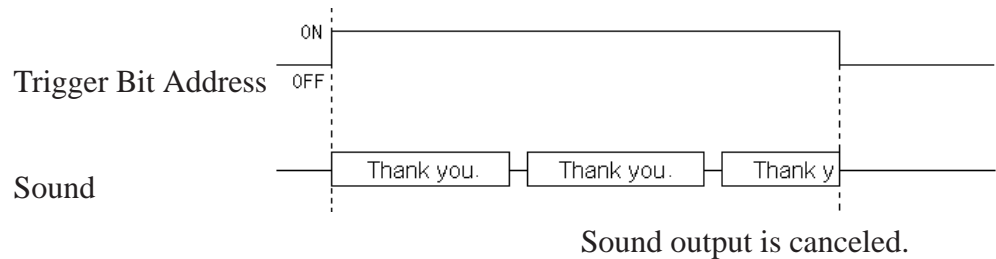

■ Play mode: Play Sound Stop: Disabled

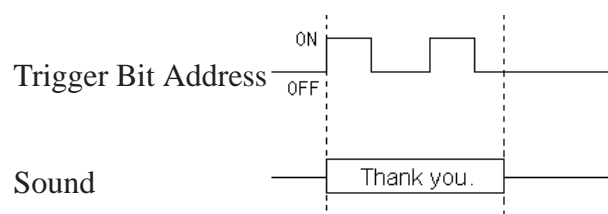
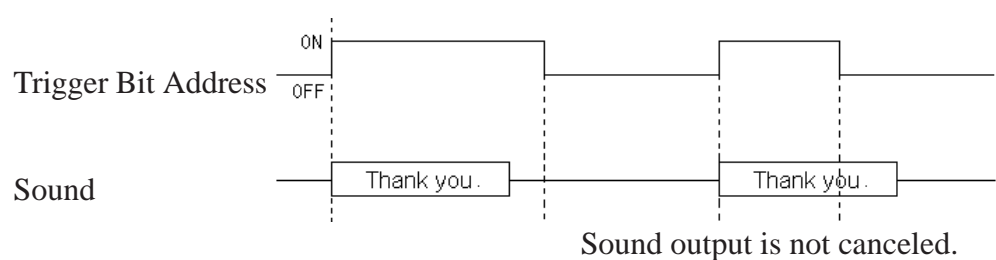

Note: If the Bit has already been turned OFF when sound data output is completed, the next sound data item is not output.

* This feature is supported only by the GP77R (except GP-377R), GP-2400T, GP-2500T and GP-2600T series units.

■ Play mode: Play Sound Stop: Disabled

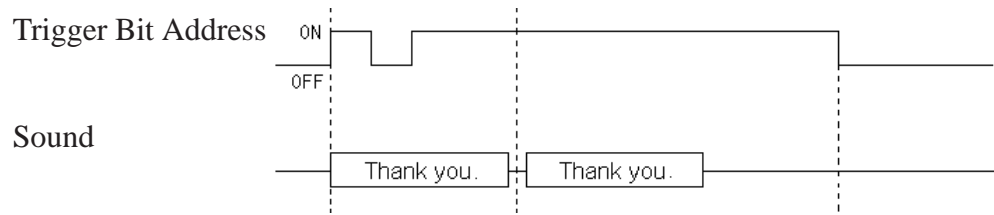

Note: If the Bit is turned ON to OFF to ON while a sound file is being output, and is still turned ON when sound output is completed, sound data is continuously output.

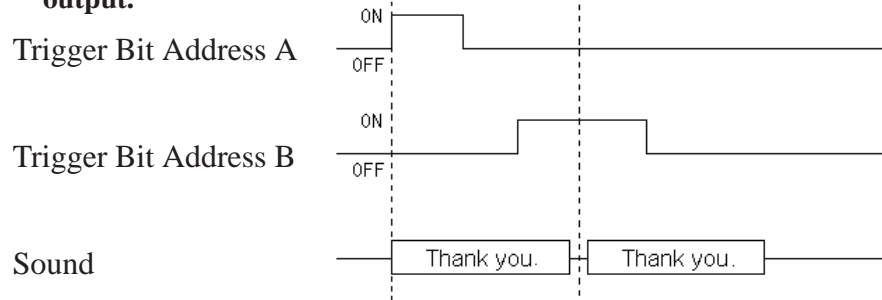

Note: After Trigger Bit Address A's sound data is output, Trigger Bit Address B's sound data is output.

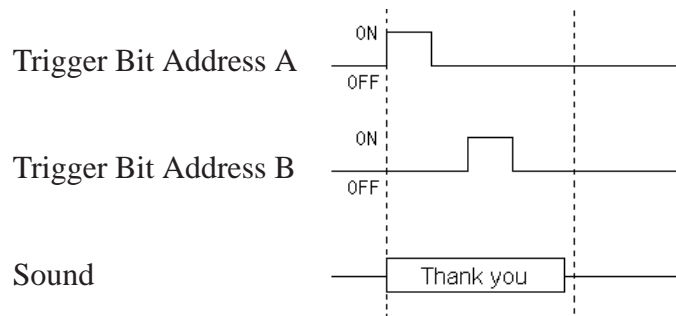

Note: If the Trigger Bit Address B has already been turned OFF when the Trigger Bit Address A's sound output is completed, the Trigger Bit Address B's sound

* This feature is supported only by the GP77R (except GP-377R), GP-2400T, GP-2500T and GP-2600T series units.

■ **Play mode: Play Sound Stop: Enabled**

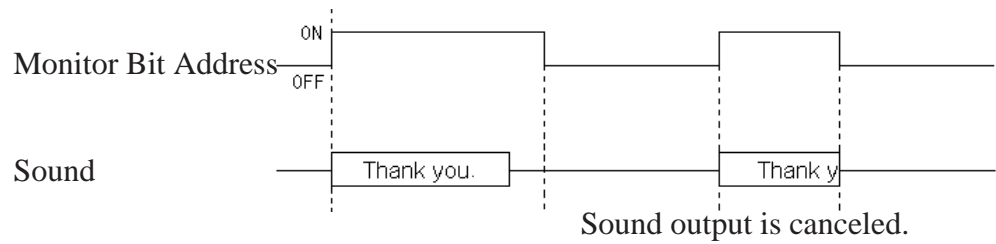

Note: While sound data is being output, the Trigger Bit ON/OFF status is ignored. When multiple types of sound data are played, the Trigger Bit ON/OFF status is also ignored.

■ **Play mode: Play (Bit OFF) Sound Stop: Disabled**

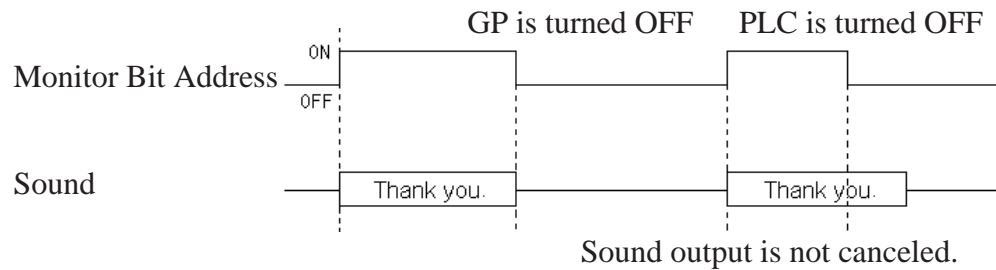

Note: When the Play Mode is Play (Bit OFF), only the LS Area is enabled.

■ **Play mode: Play (Bit OFF) Sound Stop: Enabled**

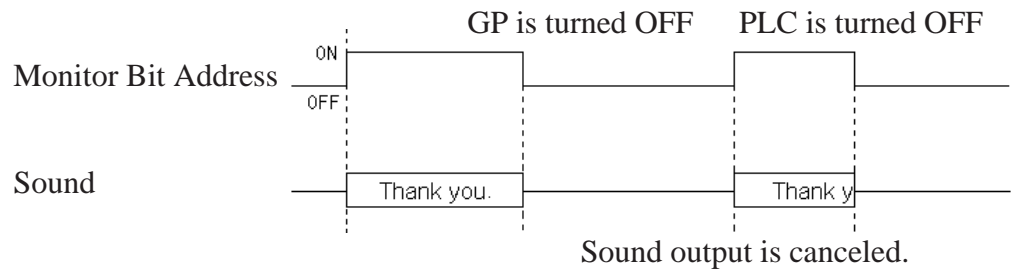

- When the Play Mode is Play (Bit OFF), only the LS Area is enabled.
- All charts shown here are intended to provide only a basic image of the GP's sound data output timing. They do not show the exact time intervals of sound data output.
- When Sound Stop setup is Enabled, it may take slightly longer than expected to stop sound output from the time the Bit is turned OFF.
- When sound data is output, set the Trigger Bit's ON or OFF time period to either the communication cycle time or to 150 ms, whichever is longer.

* This feature is supported only by the GP77R (except GP-377R), GP-2400T, GP-2500T and GP-2600T series units.



4.2 Filing Data (Recipe) Function

4.2.1 Overview

The recipe function is used to transmit preset data (conditions, settings, etc.) to the PLC. These recipes can be used as settings for machine operation, etc. The recipe function's data is called Filing Data.^{*1, *2}

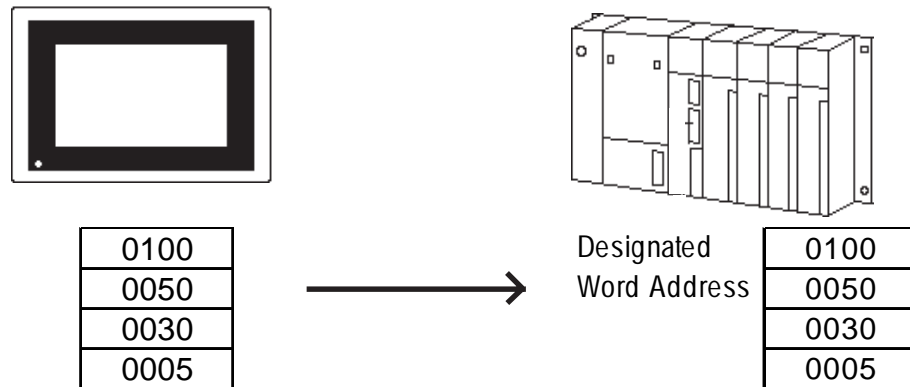

* This feature is supported only by GP77R GP-377 and GP-2000 series units.

4.2.2 Filing Data (Recipe) Function

- To set up filing data, select the Project Manager's [Filing Data]/[Filing List] selection.
Reference *Operation Manual, 10.2 Filing Data (Recipe)*
- There are two methods of transmitting filing data to the PLC. One is automatic transmission, where filing data is sent to the PLC via a PLC trigger. The other is manual transmission, where data selected on the GP screen is sent to the PLC.
- When using manual data transmission, select the Filing Data Display from the Tool Box or [Parts] menus.
- Filing data can be controlled by file numbers for each project file.
- Filing data can be stored in either the GP's internal memory or on a CF card.
- Filing data is stored in the PLC in a series of addresses.
- Filing data can be read out from the PLC to the GP's internal backup SRAM. Once it is read, this filing data can also be written to a CF card.
Reference *4.7.4 External Storage of GP-PRO/PB III data*
- Setting up filing data so that it is transmitted via an LS Area allows filing data to be edited on the GP panel and then written to the PLC.

■ Filing Data Transfer Flow

Filing data is first written from the GP's internal memory or CF card to the GP's backup SRAM, and then transferred to the PLC, either directly or via the LS area.

* This function is supported only by the GP77R, GP377 and GP2000 series units.

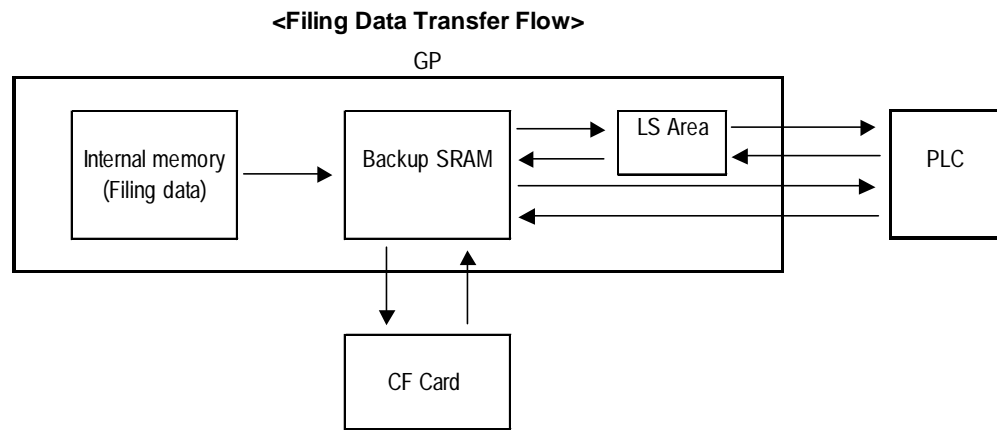

■ Organization of Filing Data

Filing data is organized into folders, files, blocks, and data. Also, to use as much filing data as possible, multiple folders can be used in the GP's internal memory or on a CF card to register multiple filing data items.

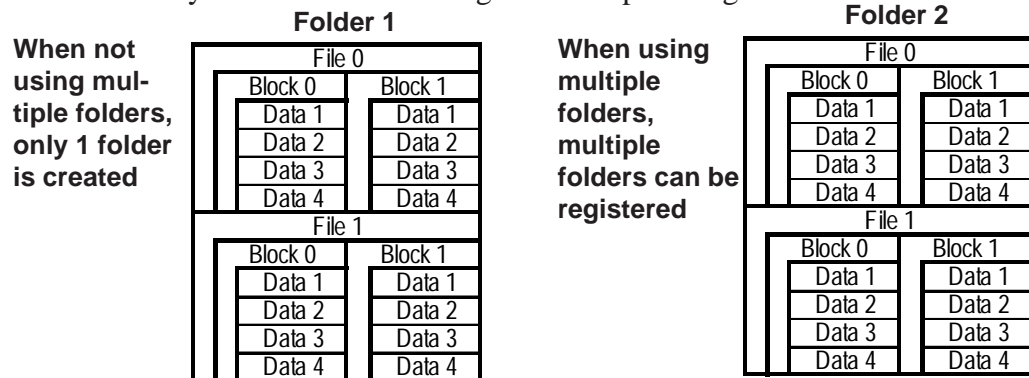

<When multiple folders are not used>

Only 1 folder is registered. In this case, the folder number is usually not designated, however, whenever it is necessary, the number is designated as 1.

<When multiple folders are used>

Multiple filing data folders can be registered. In the GP, the folder numbers need to be designated to transfer data to the GP's internal memory and backup SRAM. Since only one filing data folder can be used on the GP at one time, select which folder will be used.

- Multiple folders can be registered in both the GP's internal memory and in the CF card.
- Up to 64 folders can be registered in the GP's internal memory, and up to 8999 folders in a CF card.
- Select a folder to be used on the GP.
- Only one folder of data can be transferred to the GP's backup SRAM.
- When multiple folders are registered, the files are numbered. The filing data structure is the same as the existing data structure. Also, if a previously created folder is present on the CF Card, this folder will be automatically named "1".

* This function is supported only by the GP77R, GP377 and GP2000 series units.

■ Registered Filing Data

When saving filing data, up to 2,048 filing data files can be registered, with up to 1,650 data blocks in each file, and up to 10,000 pieces of data in each block. (However, when the data format is 32 Bits, only 5,000 data items can be registered.)



Up to 10,000 data items can be registered in a single block. (However, when the data format is 32 Bits, only 5,000 data items can be registered.)

◆ SRAM Storage Capacity Calculation

1 file = 96(fixed value)+(32+2 or 4 x number of data pieces) x number of data blocks ^{*1}

59526 Total capacity of all files

*1 Use “2” for 16 Bit devices, and use “4” for 32 Bit device file calculation.

The following shows Storage Capacity when using 16 Bit Device Data Format.

No. of files	No. of data pieces	No. of data blocks	Total capacity of all files
1	2	1650	59496
1	640	45	59136
1	10000	2	40160

◆ Usage priority of backup SRAM

- 1) Q-tag alarm
- 2) Data sampling
- 3) Trend graph
- 4) LS Area backup
- 5) Logging data
- 6) Filing data

SRAM Memory is used starting from item 1).

To check the GP’s available usage capacity, **Reference** *Operation Manual, “4.5.1 Project Information”*

* This function is supported only by the GP77R, GP377 and GP2000 series units.



- **Data in backup SRAM is erased when:**
- **The GP's memory is initialized.**
- **Data is transmitted.**
- **The GP system and protocol are set up.**
- **GP's self-diagnosis "Internal FEPRAM (screen area)" is performed.**
- **The GP's OFFLINE mode is set up. However, if the GP's system version is 1.30 or higher (GP-PRO/PBIII for Windows95 Ver.2.0 or higher), backup SRAM data is not erased.**
- **These data registration limits will differ depending on your GP's environment conditions such as backup SRAM usage and current settings.**
- **Up to 59520 bytes of filing data can be stored in one folder in the GP's internal memory. When storing the filing data on the CF Card, the maximum folder capacity is determined by the maximum capacity of the backup SRAM. **Reference** 4.11.2 Backup SRAM Amounts for each type of GP (when storing only filing data to the backup SRAM).**
- **As the number of Addresses increases, the more time is required for writing data to the PLC. Depending on the number of Addresses, it may take from several seconds to minutes.**
- **When data is being written, screen displays, such as for tags, may not be updated/refreshed or may appear slowly. Screen changes and Q-tag alarm processing may also be performed slowly. If Base or window screens are changed at this time, screen data such as for tags will also be read out, and data writing to the PLC will be performed at a slower than normal speed.**
- **DO NOT perform any of the following operations at the same time.**
 - **Data transfer between the LS area and the PLC**
 - **Data transfer between SRAM and the PLC: via the File Name Display**
 - **Data transfer between SRAM and the PLC: via the Control Word Address using Transfer Settings**
- **Be sure to perform data transfer after the current data transfer is completed.**
- **During the current data write, the succeeding data write operation cannot be accepted/received.**

* This function is supported only by the GP77R, GP377 and GP2000 series units.

■ LS Area Filing Data Structure

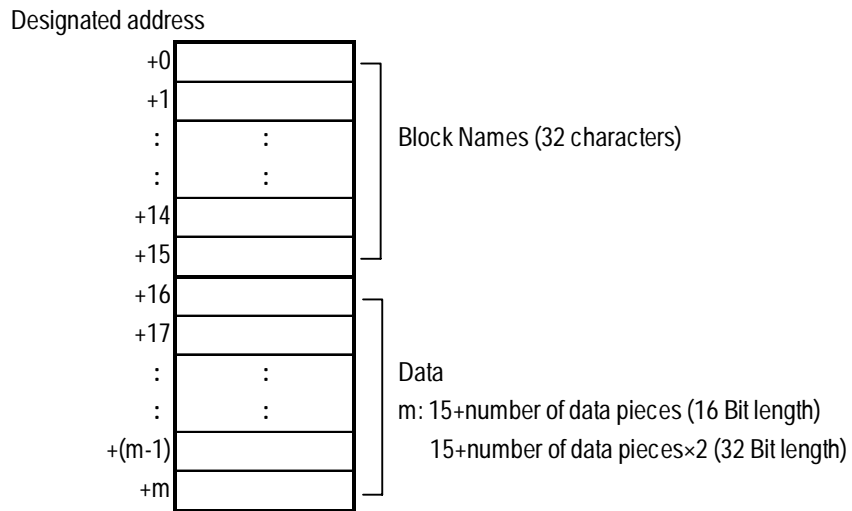

During Data Transmission

Data transmitted between the backup SRAM and LS Area will overwrite the existing Block Name and Block data. Data transmitted from the PLC to the LS Area overwrites only file data and preserves the Block Name.

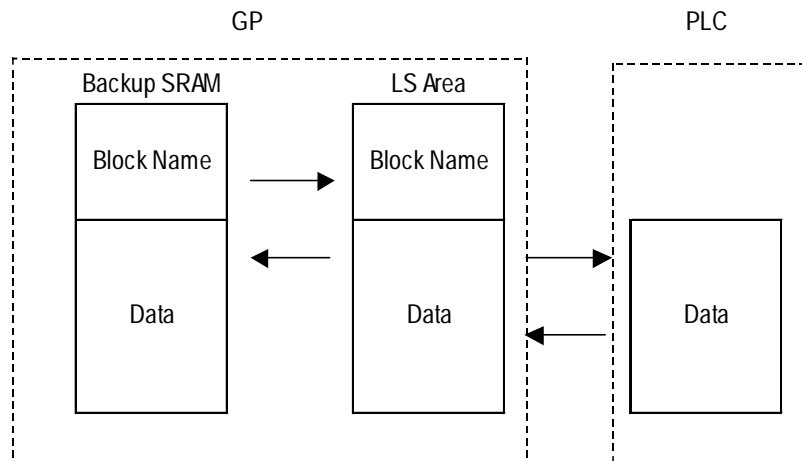

- Note:**
- When a device is used with a 32 Bit system start Address, filing data cannot be transmitted to the PLC via the LS Area.
 - Block Name text characters are stored in order of the character input.
- Reference** *Each Series' User's Manual*

* This function is supported only by the GP77R, GP377 and GP2000 series units.

■ Filing Data Transmission Methods

The method of transmitting filing data can be roughly classified into the following three types.

<Automatic Transmission>

Filing data is transmitted from the GP to the PLC via a PLC trigger. Use the Control Word Address instead of using the Filing Data Display to transfer data between the GP and the PLC (GP→PLC, PLC→GP.)

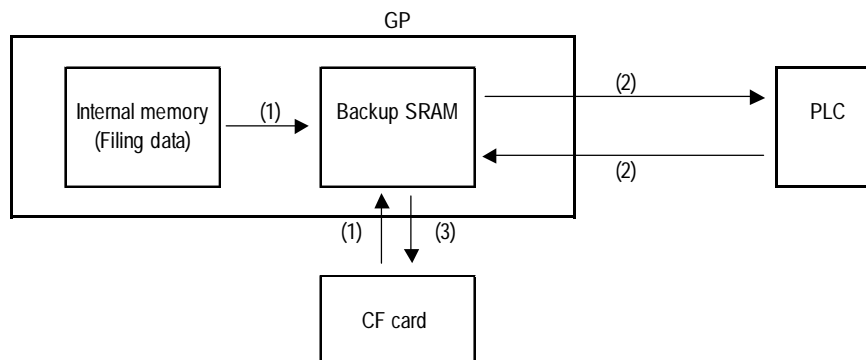

- (1) PLC Trigger **Reference** 4.2.3 Filing Data Settings, Write Settings (From Filing Data To SRAM)
- (2) PLC Trigger **Reference** 4.2.3 Filing Data Settings, PLC & SRAM Data Transmission Settings <SRAM ↔ PLC>
- (3) PLC Trigger **Reference** 4.7.4 External Storage of GP-PRO/PB III data

• Data transfer from SRAM to CF card

Reference 4.4.8 Transferring Data from Backup SRAM to CF Card

Control Address used for CF card data storage

+0	Mode (Command/Status)	
+1	Folder No.	1 to 8999

The folder number designation range will be as follows:

For GP internal (screen data) memory: 1 to 64

For CF card: 1 to 8999



- When a single folder is used, designate the folder number as 1.
- If the designated number's folder does not exist, data will not be transferred to backup SRAM. Also, the Write Completed Bit Address will not be turned ON.
- When data is not transferred to backup SRAM, the GP internal special relay (LS2032)'s bit 9 will turn ON.
- Filing data (folder) names stored on the CF card will be as follows:

Folder Setting	File Name
Use Multiple Folders: OFF	ZF00001.BIN (fixed)
Use Multiple Folders: ON	ZF****.BIN (**** = Folder No. ex: ZF00001. BIN, ZF00002. BIN,etc.)

* This function is supported only by the GP77R, GP377 and GP2000 series units.

<Manual Transmission - type 1>

Filing data is transmitted to the PLC by touching a GP screen touch key. Use the Filing Data Display to transfer data to/from the PLC, using the “SRAM→PLC” touch key and the “PLC→SRAM” touch key.

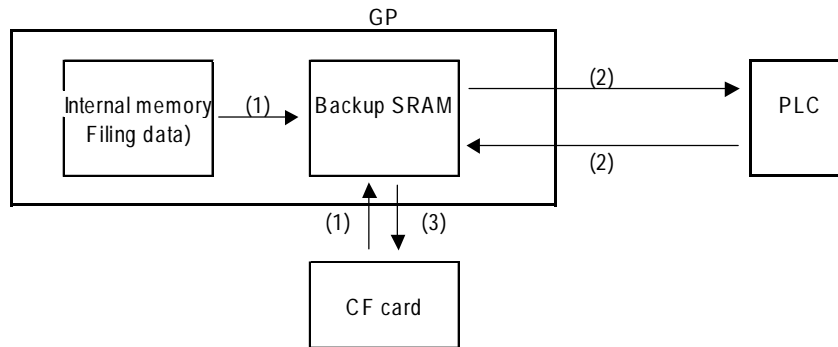

- (1) PLC Trigger **Reference** 4.2.3 Filing Data Setting, Write Settings (From Filing Data To SRAM)
- (2) Screen Touch Keys **Reference** 4.2.7 Manual Filing Data Transmission Example 1
- (3) PLC Trigger **Reference** 4.7.4 External Storage of GP-PRO/PB III data



Note: When filing data is sent back to the PLC from backup SRAM, the newly sent data will overwrite the old. In order to prevent this, beforehand create another data block for the return value data (See the figure below) to send the filing data to and designate that block via the Control Word Address.

File 0			
A	B	A Return Value	B Return Value
50	40	0	0
60	30	0	0

<Manual Transmission - type 2>

Select the desired filing data via the screen’s touch keys, perform any data changes, and then transmit the edited data to the PLC. Use the Filing Data Display to transfer data to/from the PLC, using the “LS→PLC” touch key and the “PLC→LS” touch key.

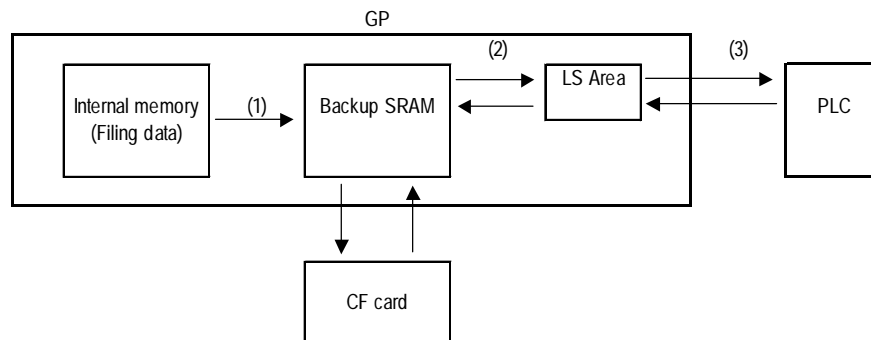

* This function is supported only by the GP77R, GP377 and GP2000 series units.

- (1) PLC Trigger **Reference** 4.2.3 Filing Data Setting, Write Settings (From Filing Data To SRAM)
- (2) Screen touch keys **Reference** 4.2.8 Manual Filing Data Transmission Example 2 ■ Filing Setting Example
- (3) Screen touch keys **Reference** 4.2.8 Manual Filing Data Transmission Example 2 ■ Filing Display Settings

■ Filing Data Setup Procedure

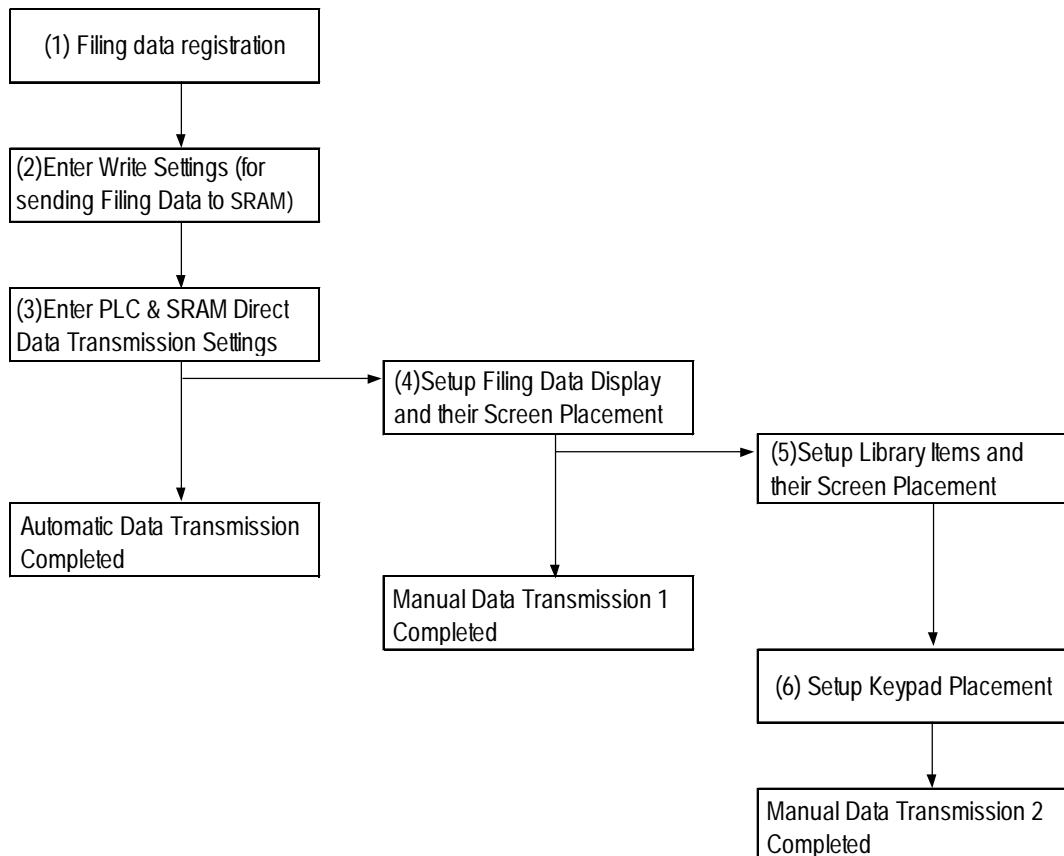

- (1) Filing Data Registration via [Filing Data]/[Filing List]
- (2) Setup of [Write Settings (Send Filing Data to SRAM)] via [Filing Data]/[Filing Setting]
- (3) When performing automatic data transmission, setup the [PLC & SRAM Direct Data Transmission Settings] via the same dialog box. Automatic Data Transmission is completed here.
- (4) When performing manual data transmission - type 1, setup the Filing Data Display and designate its placement. Manual Data Transmission - type 1 is completed here.
- (5) When performing manual data transmission - type 2, setup the Library Items and designate their placement.
- (6) Placement of the Keypad
Manual Data Transmission - type 2 is completed here.

* This function is supported only by the GP77R, GP377 and GP2000 series units.

4.2.3 Filing Data Setting

Make the settings for Use of Multiple Folders and the trigger for filing data transmission. After selecting the Project Manager's [Screen/Setup] - [Filing Data] - [Filing Setting], the following menu will appear.

◆ Filing (ON/OFF)

Check this check box in order to use the filing data.

◆ Use Multiple Folders

Check this check box in order to register 2 or more folders.

◆ Write Settings (From Filing Data To SRAM)

In response to a trigger, filing data stored in the GP's internal memory (screen data) or on a CF card is written to backup SRAM. This prepares for filing data transfer. In order to transfer data to the PLC, you need to first write data to backup SRAM. Only 1 item of filing data can be written to backup SRAM.



When using filing data, be sure to enter the “Write Settings” data.

* This function is supported only by the GP77R, GP377 and GP2000 series units.

◆ **Control Word Addresses (From Filing Data To SRAM)**

Designate a Word Address to use as a trigger, or designate the mode to use when writing to backup SRAM. This trigger controls the data write timing. When using multiple filing data items, designate the folder numbers.

The Control Word Address will be as follows:

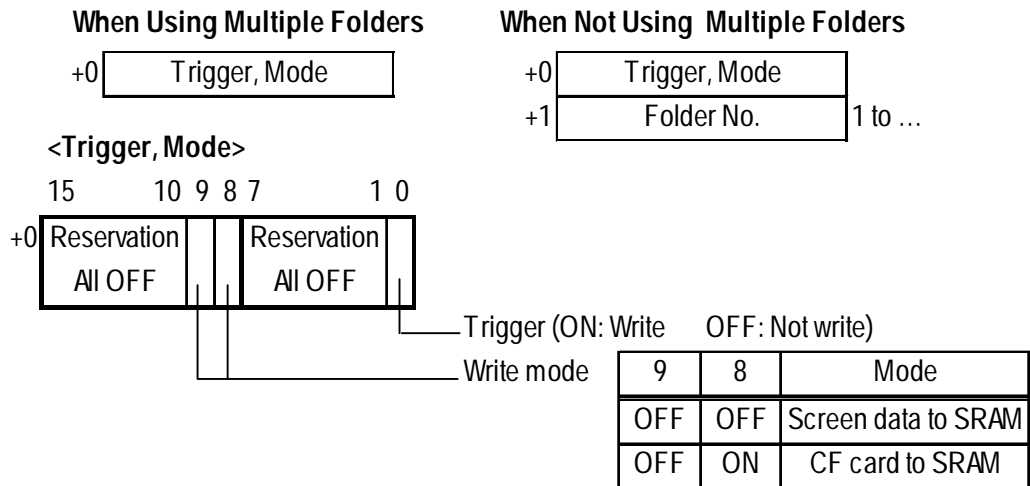

The allowed folder number ranges are as follows.

GP internal memory: 1 to 64

CF card: 1 to 8999

◆ **Write Completed Bit Address (From Filing Data To SRAM)**

Designate a specific Bit Address to be turned ON when the data write to GP backup SRAM is completed.



Note: If data cannot be transmitted to backup SRAM due to insufficient memory, LS2032's Bit 9 will be turned ON. When data is transmitted to backup SRAM again, use either the designated communication cycle time or 150ms, whichever is longer, as the trigger's OFF time.

For communication cycle time details, **Reference** *Device/PLC Connection Manual, "1.1.5 Special Relays"*

	Write Completed Bit Address	LS2032 Bit 9
Normal data transmission	ON	OFF
Data transmission error	-	ON

* This function is supported only by the GP77R, GP377 and GP2000 series units.

◆ **PLC & SRAM Data Transmission Settings < SRAM←→PLC>**

Here, select the method used to transmit filing data either from backup SRAM to the PLC, or from the PLC to backup SRAM. Select this setting when performing automatic data transmission using the Control Word Address feature.

◆ **PLC Controlled Transfer < SRAM←→PLC>**

When this check box is selected, automatic data transmission via the PLC’s trigger is set up. If this box is not checked, data must be transmitted manually using the Editor area Toolbox’s Filing Data Display.

◆ **Control Word Address < SRAM←→PLC>**

Designates a Word Address where the filing data transmission trigger and mode data are stored.

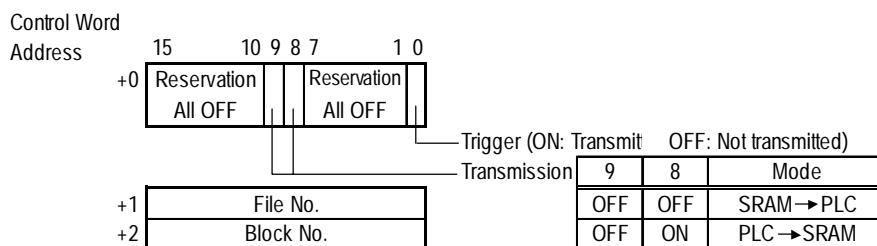

◆ **Transmit Completed Bit Address**

Designates the Bit Address that will be turned ON when filing data transmission is completed.



- Use binary numbers to designate file and block numbers.
- If data transmission cannot be performed, LS2032’s Bit 10 is turned ON. To transmit data to the PLC, use either your standard communication cycle time or 150ms, whichever is longer, as the trigger OFF time.

For Communication cycle time details, **Reference** *Device/PLC Connection Manual “1.1.5 Special Relays”*

	Transmit Completed Bit Address	LS2032 Bit 10
Normal data transmission	ON	OFF
Data transmission error	-	ON

* This function is supported only by the GP77R, GP377 and GP2000 series units.

4.2.4 Filing Data List

The settings for Filing Data can be added, edited, and deleted with the Filing Data List. After selecting the Project Manager's [Screen/Setup] - [Filing Data] - [Filing List], the following menu will appear.

■ Filing Data List

The following is an overview of the Filing Data Setting screen.

◆ When not using multiple folders

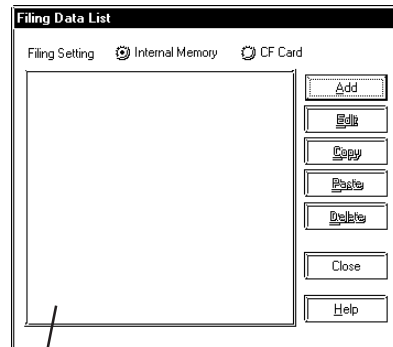

The registered Filing Settings are displayed as a list.

Add

Adds folder and file settings.

Edit

Edits folder and file contents.

Copy

Copies folder and files.

Paste

Pastes copied folders and files.

Delete

Deletes folders and files.

◆ When using multiple folders

Internal Memory indicates the screen data stored in the internal memory. 1-Filing Data is file setting.

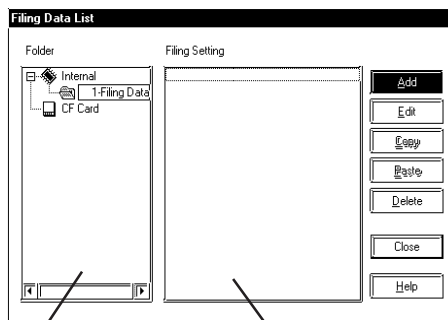

The registered folders and files are displayed as a list.

The registered Filing Settings are displayed as a list.

Add

Adds folder and file settings.

Edit

Edits folder and file contents.

Copy

Copies folder and files.

Paste

Pastes copied folders and files.

Delete

Deletes folders and files.

* This function is supported only by the GP77R, GP377 and GP2000 series units.

■ Filing Data Register

Register additional Filing Data settings.

◆ Registering Filing data

When using or not using multiple folders, select "1-Filing Data" and then click on the [Add] button in the Filing Data List dialog box. The following screen will appear.

Block Name	Block 1	Block 2
D0000	0	0
D0001	0	0
D0002	0	0
D0003	0	0
D0004	0	0
D0005	0	0
D0006	0	0
D0007	0	0
D0008	0	0
D0009	0	0

File No.

Filing data is controlled in individual file units. Here, designate the file numbers of filing data to be registered. Up to 2,048 files can be registered.

Data Storage Start Address

Enter the first Address where the transferred filing data is stored. Data storage areas will be saved in series, starting from the Start Address for the number of filing data items.

No. of Data Blocks

Designate the number of blocks to be registered in one file. A maximum of 1,650 blocks can be designated. (The maximum number will change depending on the number of data blocks.)

No. of Data Items

Designates the number of data items registered in one block. A maximum of 9,999 data items can be registered. (The maximum number will change depending on the number of data blocks)

Data Format

Select either 16 or 32 bit data.

Display Format

Select a filing data display format.

Code +/-

“(minus)” display becomes effective when this check box is checked.

Import

Other file data (CSV format) can be imported and used as filing data.

Export

Filing data can be exported and saved in the CSV format.

* This function is supported only by the GP77R, GP377 and GP2000 series units.

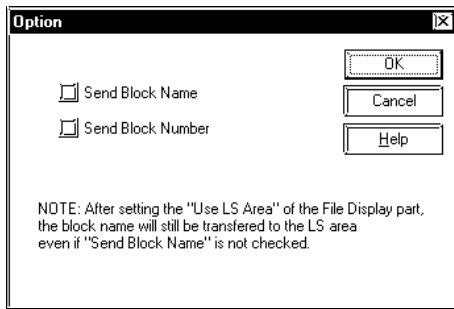

Option

The dialog box on the left appears on the screen. This function is supported only by the GP-2000 series unit.

Send Block Name

The Block Name is sent simultaneously with the data transmission.

Send Block No.

The Block No. is sent simultaneously with the data transmission.

<Output Example using CSV Format (Example of output when data is exported)>

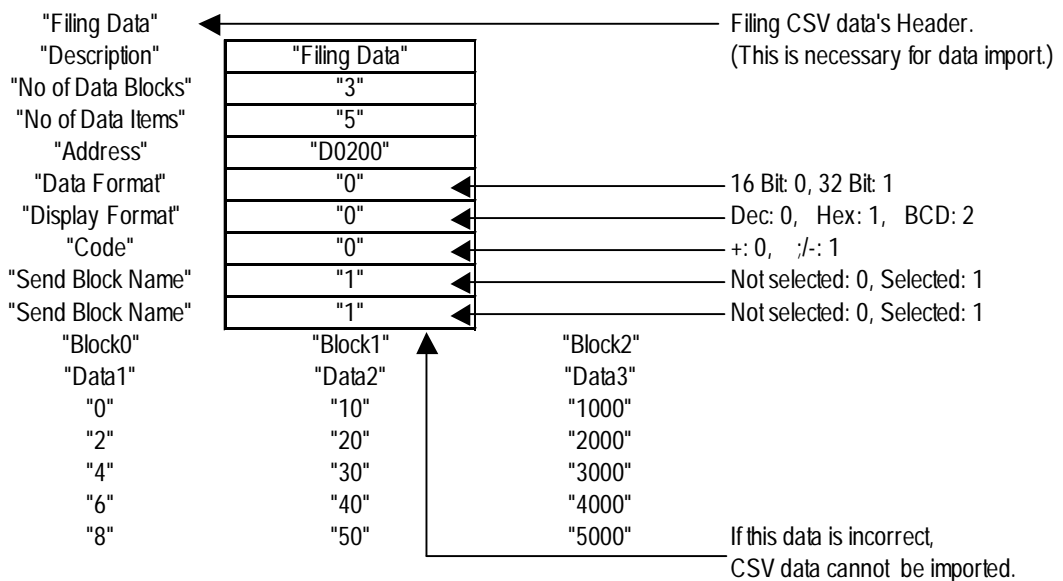

■ Sends Block Name and Block No.

The offset value of the block varies depending on the type of Data Storage Start Address and the Data Format.

Send Block Name		Data Storage Start Address	
		16-bit Address	32-bit Address
Data Format	16 bits	+ 16 words	
	32 bits	+16 words	+8 words

Send Block No.		Data Storage Start Address	
		16-bit Address	32-bit Address
Data Format	16 bits	+ 1 words	
	32 bits	+1 words	+1 words

* This function is supported only by the GP2000 series units.

Example: Put check marks in both check boxes when the Data Storage Start Address is a 16-bit address and the Data Format is set to "16 bit." Press the OK button. The address offset is reflected, bringing the offset value to "+17".

The details of the transfer operation (between backup SRAM and PLC) are described below.

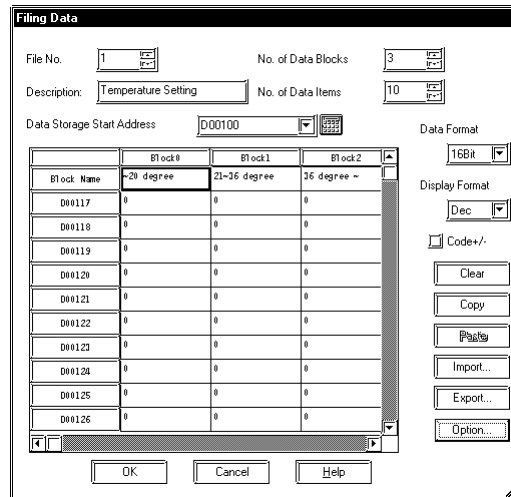

◆ Transferring both Block Number and Block Name (Backup SRAM to PLC)

When transferring Block No. 1

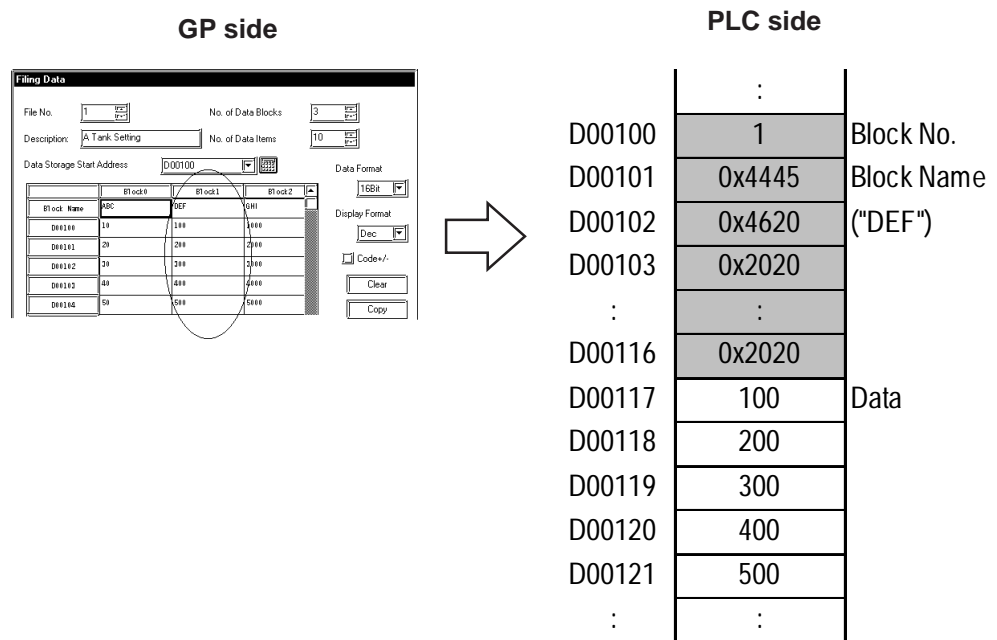

* This function is supported only by the GP2000 series units.



- The Block Name and Block Number can be transferred by automatic transmission, manual transmission or manual transmission via the LS area.
- To configure transmission settings, select or deselect the checkbox for Block Name and Block Number for each file No.
- Even when the Data Format is set to BCD, binary values will be written onto the PLC when the Block Number is transferred from SRAM to the PLC.
- The transmission of the Block Name is fixed at 32 characters. When the Block Name is less than 32 characters, spaces will be appended automatically.
- The order of the character strings stored in the Block Name depends on the settings of the string data.

◆ Transferring both Block Number and Block Name (PLC to backup SRM)

When transferring Block No. 1

Backup SRAM side

:	
1	Block No.
0x4445	Block Name
0x4620	("DEF")
0x2020	
:	
0x2020	
100	Data
200	
300	
400	
500	
:	



PLC side

:		
D00100	1	Block No.
D00101	0x4445	Block Name
D00102	0x4620	("DEF")
D00103	0x2020	
:	:	
D00116	0x2020	
D00117	100	Data
D00118	200	
D00119	300	
D00120	400	
D00121	500	
:	:	



- The Block Name and Block Number can be transferred by automatic transmission, manual transmission or manual transmission via the LS area.
- The Block Numbers can be transferred from SRAM to the PLC, or from SRAM to LS; however, they are not transferred from the PLC to SRAM and LS area to SRAM.
- When File Name Display has been set, changing the File Name before executing a PLC-to-SRAM or LS area-to-SRAM transmission will change the name displayed on the File Name Display.

* This function is supported only by the GP2000 series units.

■ Data Structure of the PLC and LS Area

◆ When the Data Storage Start Address is 16 bits long and Data Format is 16 bits

Block No. and Data

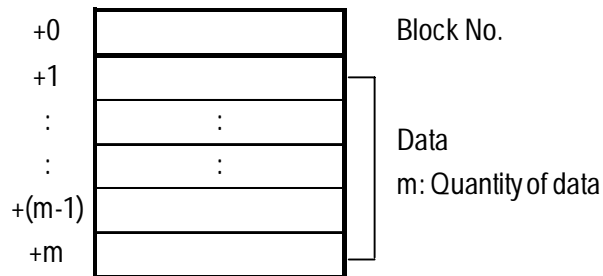

Block Name and Data

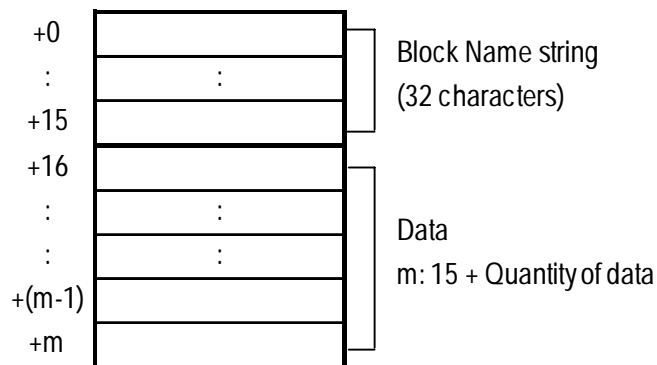

Block No., Block Name and Data

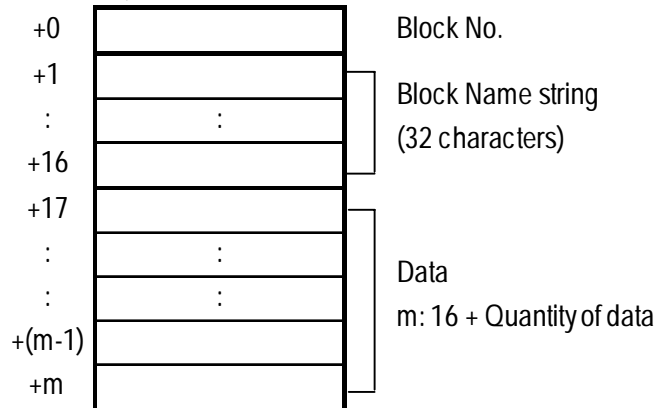

* This function is supported only by the GP2000 series units.

◆ When the Data Storage Start Address is 16 bits long and Data Format is 32 bits

Block No. and Data

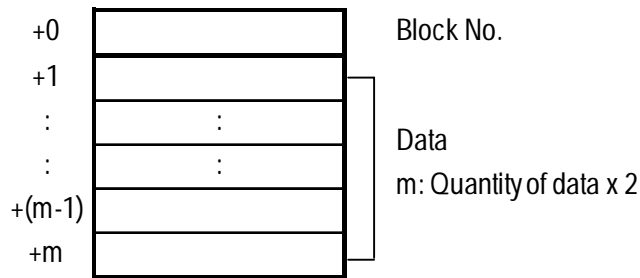

Block Name and Data

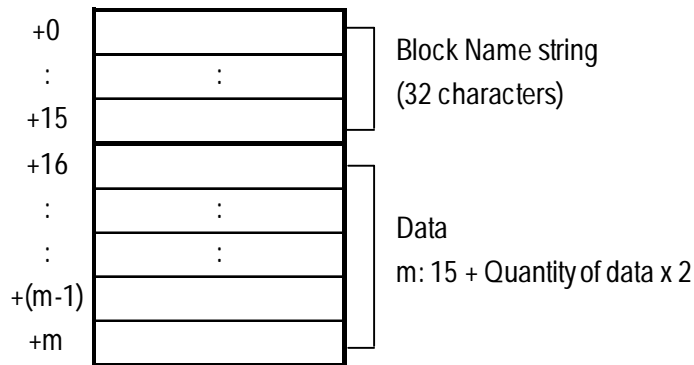

Block No., Block Name and Data

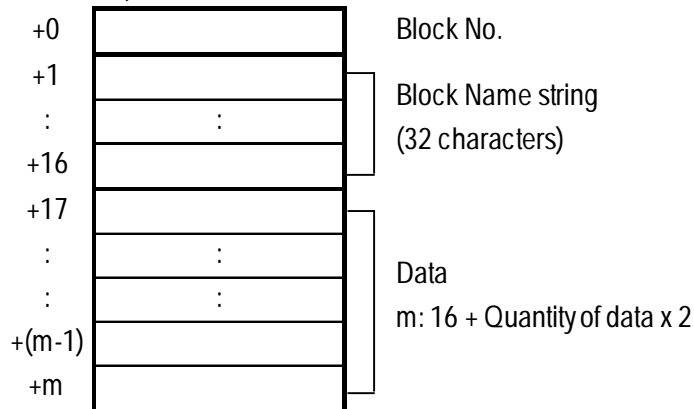

* This function is supported only by the GP2000 series units.

◆ When the Data Storage Start Address is 32 bits long and Data Format is 32 bits

Block No. and Data

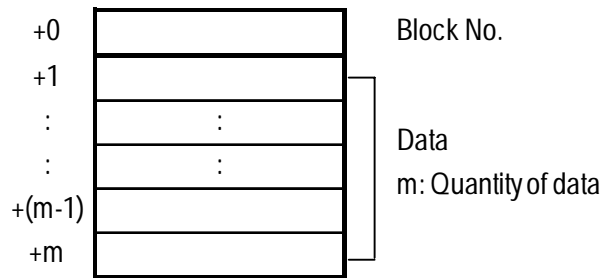

Block Name and Data

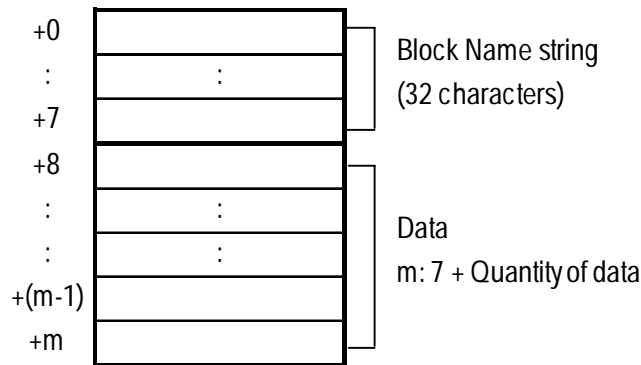

Block No., Block Name and Data

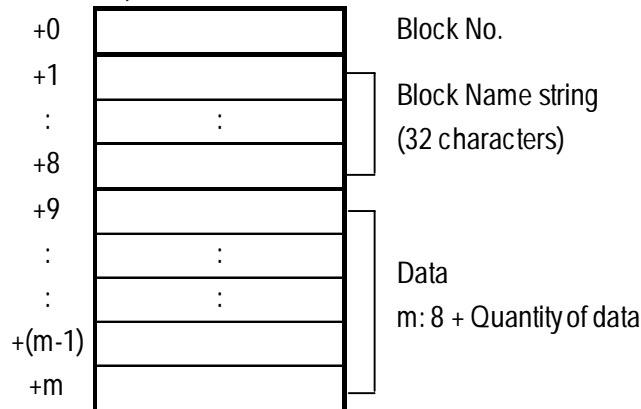

* This function is supported only by the GP2000 series units.

■ **Data Writing for the Block No. and Block Name Transfer**

◆ **SRAM ↔ PLC transfer with automatic transfer or manual transfer bypassing the LS**

<When not transferring the Block No. and Block Name>

Parameter	Description
Sends Block No.	Not selected
Sends Block Name	Not selected
Start Device Address	D0100

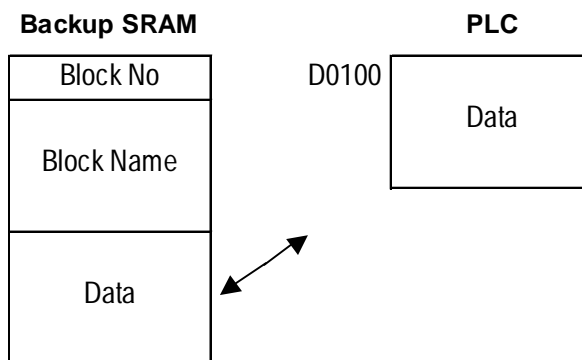

<When transferring the Block No. only>

Parameter	Description
Sends Block No.	Selected
Sends Block Name	Not selected
Start Device Address	D0100

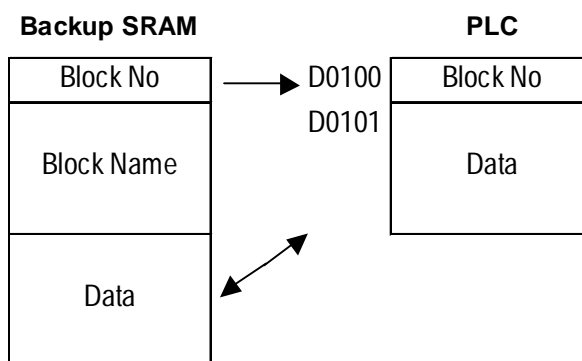

* This function is supported only by the GP2000 series units.

<When transferring the Block Name only>

Parameter	Description
Sends Block No.	Not selected
Sends Block Name	Selected
Start Device Address	D0100

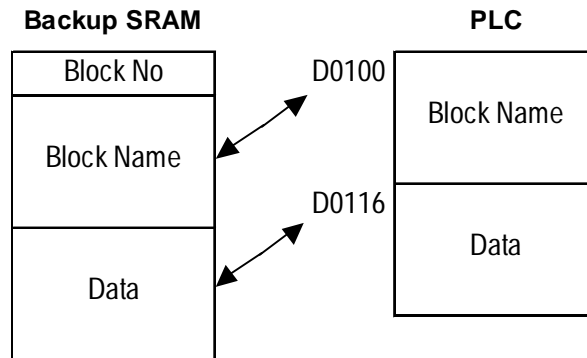

<When transferring the Block No. and Block Name>

Parameter	Description
Sends Block No.	Selected
Sends Block Name	Selected
Start Device Address	D0100

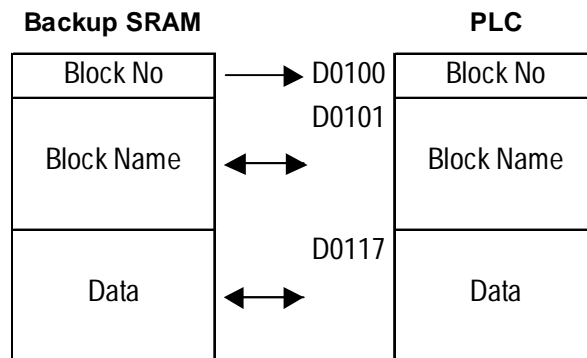

* This function is supported only by the GP2000 series units.

◆SRAM ↔ LS ↔ PLC transfer with manual transfer via LS area

<When not transferring the Block No. and Block Name>

Parameter	Description
Sends Block No.	Not selected
Sends Block Name	Not selected
Start Device Address	D0100
LS Start device address	LS0100

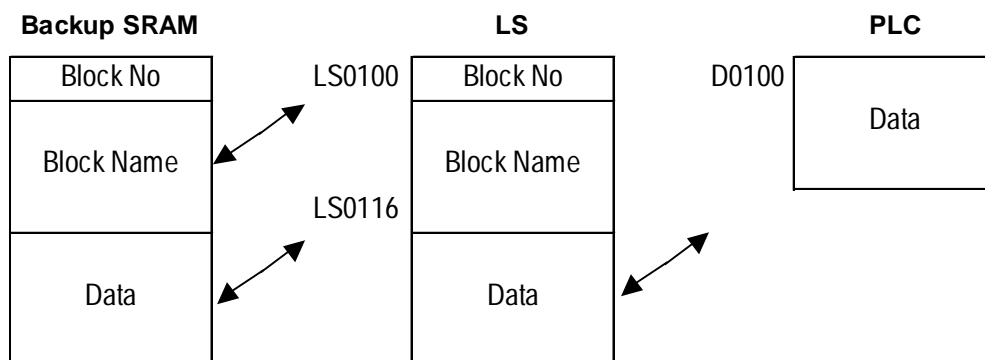

<When transferring the Block No. only>

Parameter	Description
Sends Block No.	Selected
Sends Block Name	Not selected
Start Device Address	D0100
LS Start device address	LS0100

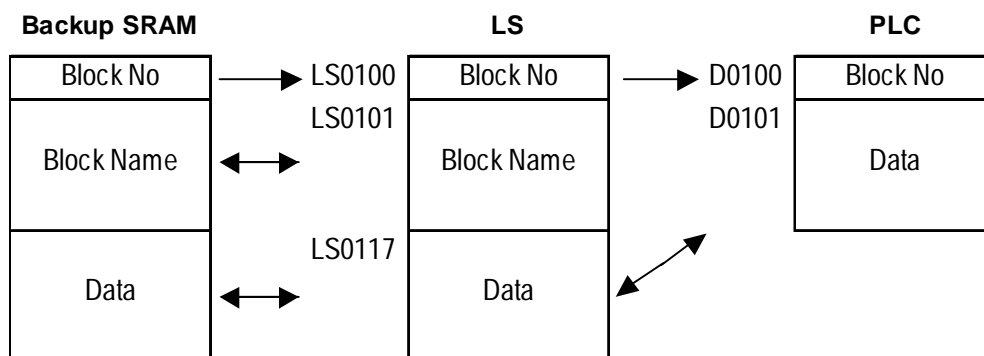

* This function is supported only by the GP2000 series units.

<When transferring the Block Name only>

Parameter	Description
Sends Block No.	Not Selected
Sends Block No.	Selected
Start Device Address	D0100
LS Start device address	LS0100

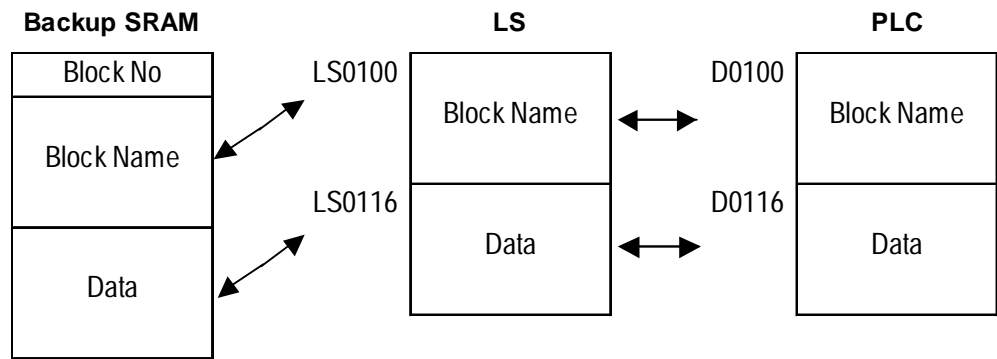

<When transferring the Block No. and Block Name>

Parameter	Description
Sends Block No.	Selected
Sends Block Name	Selected
Start Device Address	D0100
LS Start device address	LS0100

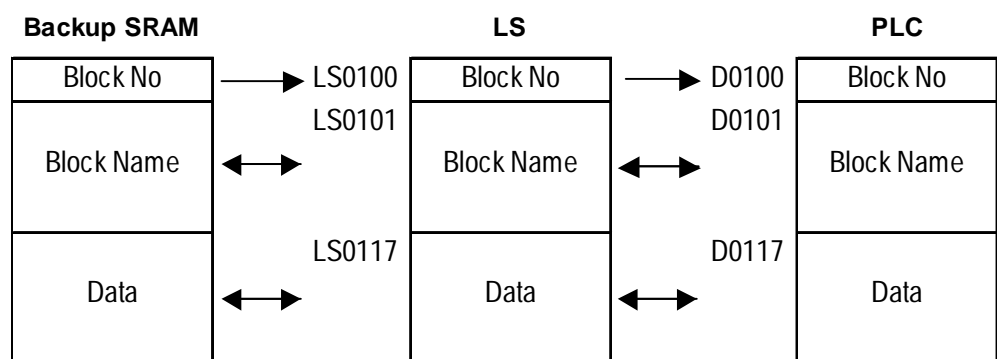

* This function is supported only by the GP2000 series units.

4.2.5 Filing Data Setup

Entering File No., Description, No. of Data Blocks, No. of Data Items and Data Storage Start Address

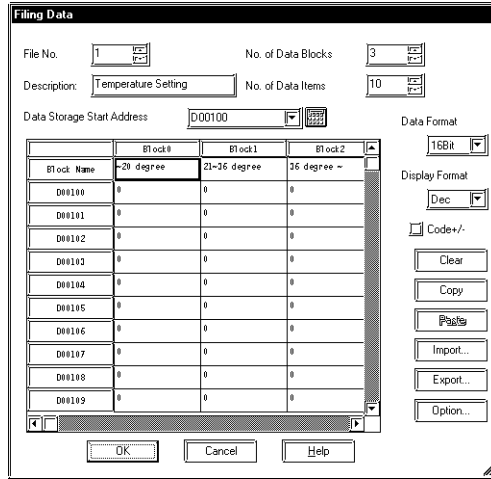

File No.: 1
 Description: Heat Control
 No. of Data Blocks: 3
 No. of Data Items: 10
 Data Storage Start Address: D00100

◆ **Filing Data List Display**

<When using multiple folders>

<When not using a multiple folder>

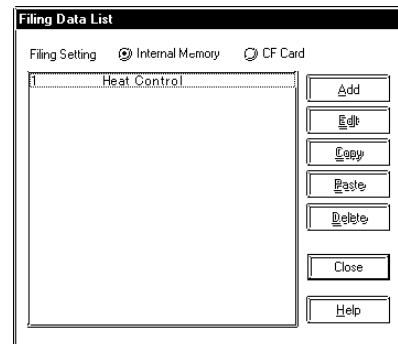
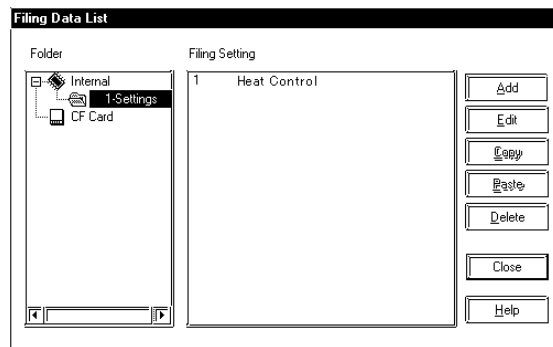

* This function is supported only by the GP77R, GP377 and GP2000 series units.

4.2.6 Automatic Filing Data Transmission

Previously entered filing data is transmitted to the PLC as shown below. There are three methods to transmit data, e.g. via the PLC's trigger or via selecting the desired settings from the two types of screens available. Here, each transmission method is explained.

The 'Filing Data' screen displays the following configuration:

- File No.: 1
- No. of Data Blocks: 3
- Description: Heat Control
- No. of Data Item: 3
- Data Storage Start Address: D00100
- Data Format: 16Bit
- Display Format: Dec

	Block0	Block1	Block2
Block Name	-20°C	21~35°C	36°C
D00100	200	30	55
D00101	202	30	56
D00102	205	28	62

■ Filing Settings

Block 1's data is transmitted when the Control Word Address changes.

The 'Filing Setting' screen displays the following settings:

- Filing (ON/OFF)
- Use Multiple Folders
- Write Settings (From Filing Data To SRAM)
 - Control Word Address: D00200
 - Write Completed Bit Address: M0001
- PLC & SRAM Direct Data Transmission Settings
 - PLC Controlled Transfer
 - Control Word Address: D00201
 - Transmit Completed Bit Address: M0002

Write Settings (From Filing Data To SRAM)

Control Word Address: D00200

Write Completed Bit Address:

M0001

PLC & SRAM Direct Data Transmission Settings

Control Word Address: D00201

Transmit Completed Bit Address:

M0002



Note: When using multiple folders, the Control Word Addresses will be D00200 to D00201, which overlap with the following transfer setting (SRAM↔PLC) Control Word Address (D00201).

* This function is supported only by the GP77R, GP377 and GP2000 series units.

■ Filing Data Data Transfer

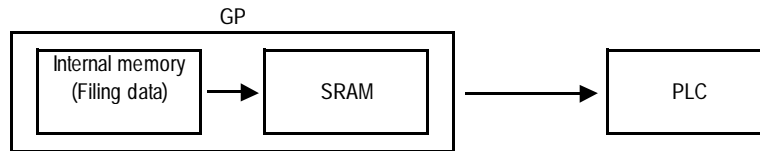

• Filing data to SRAM

When the “0” Bit of a data transmission’s Control Word Address (D00200) is turned ON, all the filing data is written to SRAM.

PLC Trigger Bit Address
1 to D00200

Write Completed Bit Address
M0001

Data processing

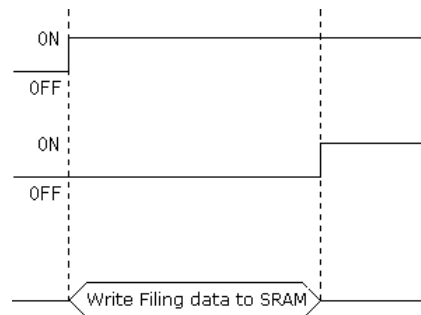

• SRAM to PLC

When the “0” Bit of the data transmission’s Control Word Address (D00201) is turned ON, the designated filing data is written to the PLC.

To designate filing data, prior to transferring filing data a file number is stored in D00202 and a block number is stored in D00203, directly following the Control Word Address.

PLC Trigger Bit Address
1 to D00201

Write Completed Bit Address
M0002

Data processing

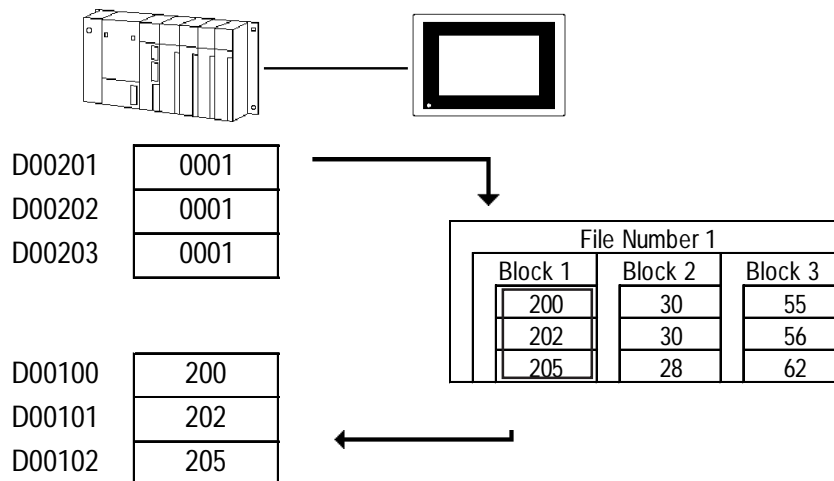
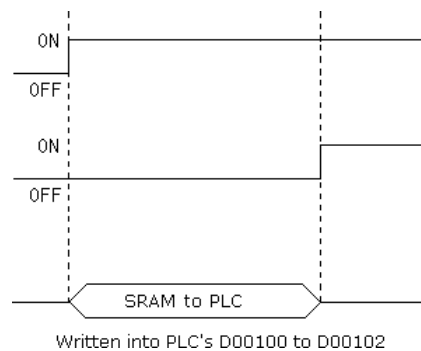

* This function is supported only by the GP77R, GP377 and GP2000 series units.

4.2.7 Manual Filing Data Transmission Example 1

The following explains how to transfer data by selecting the desired screen setting (Manual Transmission 1). Use the same filing data used in "4.2.6 Filing Data Transmission Example (Automatic Transmission)."

Screen Example

In this example, data from File No. 1's Block No. 3 is sent by touching the screen.

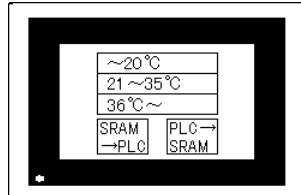

Filing Setting Example

Select the manual transmission mode by leaving the box for "PLC Controlled Transfer" unchecked.

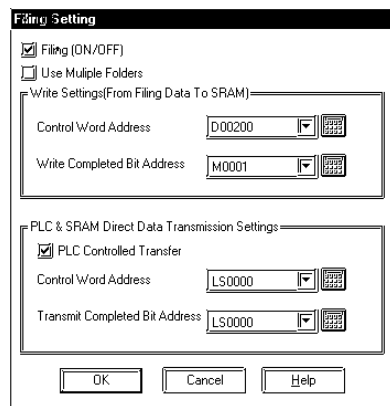

Write Settings (From Filing Data To SRAM)
Control Word Address: D00200
Write Completed Bit Address: M0001
PLC & SRAM Direct Data Transmission Setting
PLC Controlled Transfer: Not selected

Filing Data Display Settings

When manual transmission mode is selected, the part "File Name Display" should be placed.

Reference *Operation Manual, 2.1.16 File Name Display*

General Info.

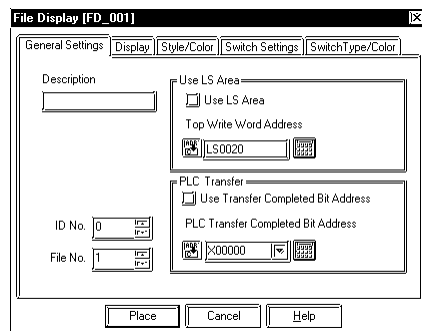

Description: Heat Control
Use LS Area

Use LS Area: Not selected
 Since, in this example, data is transmitted from SRAM to the PLC, it is not transmitted via the LS Area. Keep the default setting.
Top Write Word Address: Not selected
 Not designated. Since this example does not use the LS area, this Address does not need to be designated. When using the LS area, designate the Top Address of the LS area where data is stored.

* This function is supported only by the GP77R, GP377 and GP2000 series units.

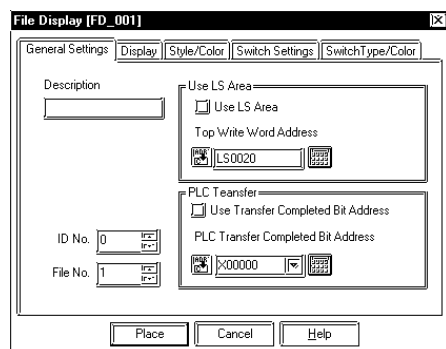

PLC Transfer

Use Transfer Completed Bit Address: Not selected

The example does not turn the PLC Transfer Completed Bit Address ON when the data transfer is completed between the LS area and PLC, and SRAM and PLC. (No information is sent when data transfer is completed.)

When using the Transfer Completed Bit Address, after the Bit ON condition is detected, turn the corresponding Bit OFF on the PLC. Also, when the Transfer Completed Bit Address is used, the special relay (LS2032)'s bit 10 will turn ON when data transfer is not completed normally, between the PLC and LS area, or between the PLC and SRAM.

Reference *Device/PLC Connection Manual, Chapter 1*

PLC Transfer Completed Bit Address: Not designated

Since this example does not use the Transfer Completed Bit Address, this Address does not need to be designated. When using the Transfer Completed Bit Address, designate an Address that will be turned ON when data transfer is completed.

ID No.: 0

In this example, where only one Filing Data Display is placed, the ID No. does not need to be entered. Keep the default setting. When placing two or more Filing Data Displays on the currently displayed screen, be sure not to use the same ID No. for multiple Filing Data Displays. Also, when placing a window containing two or more Filing Data Displays on a Base screen, be sure not to use the same ID No. more than once.

File No.: 1

Enter the previously entered filing data number.

* This function is supported only by the GP77R, GP377 and GP2000 series units.

◆ Display

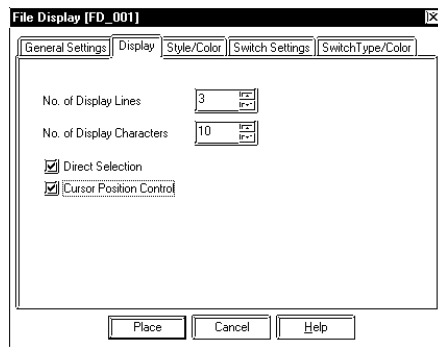

No. of Display Lines: 3
No. of Display Characters: 10
Direct Selection: Selected
Cursor Position Control: Selected

<Cursor Position Control>

- Even when the screens are changed on the GP monitor, the current File Name Display’s cursor position can be preserved.
- Cursor Position Control can be designated when setting up the File Name Display.
- When the GP’s main power is turned ON or the GP is reset, the cursor will appear on the first line.
- The cursor position will be stored for each ID No. (The storage area of an ID No. and its cursor position correspond to each other.) To retain the cursor position, be sure that the File Name Display ID Nos. do not overlap each other on any of the screens. For more detailed information about the File Name Display,

▼ **Reference** ▲ *Operation Manual, 2.1.16 “File Name Display”*

◆ Style/Color

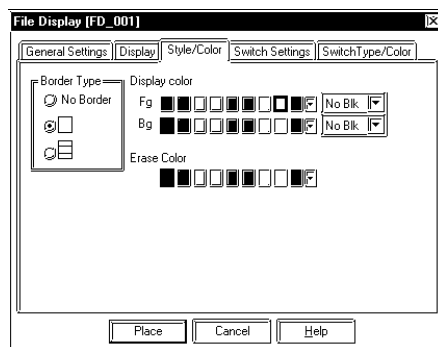

Border Type: Outer and inner borders
Display Color: Select desired colors.

Select the desired colors for Fg (foreground), Bg (background), and Blk (blink).

▼ **Reference** ▲ *2.1.5 Color Settings, A-tag*

Erase Color: Select the desired color.

Select the display area color to use when a Filing Data Display is cleared. When using a monochrome GP, select “Black”.

* This function is supported only by the GP77R, GP377 and GP2000 series units.

◆ **Switch Settings**

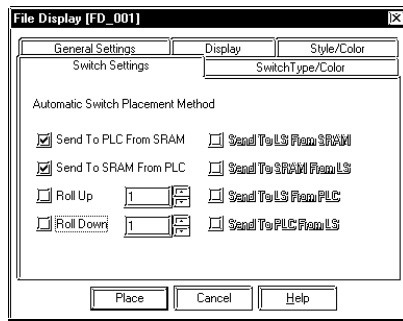

Send To PLC From SRAM: Selected
Send To SRAM From PLC: Selected
Roll Up: Not selected
Roll Down: Not selected
Send To LS From SRAM: Not selected
Send To SRAM From LS: Not selected
Send To LS From PLC: Not selected
Sending To PLC From LS: Not selected
 Select the desired switch shape from the browser.

◆ **Switch Type/Color**

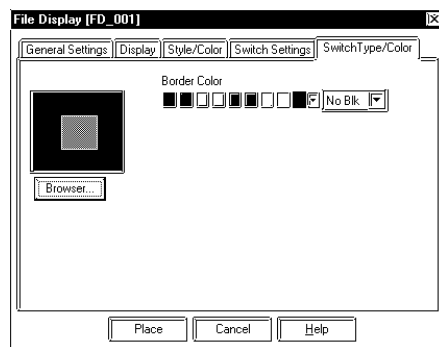

Border Color: Select the desired color.
 Select the desired color for the Filing Data Display's border.

■ **Place**

Click on the Place button to display the Filing Data Display. If desired, change the Part's size via its sizing handles.



Note: To change the Filing Data Display's layout or attributes, first ungroup it.

■ **Filing Data Transmission Flow**

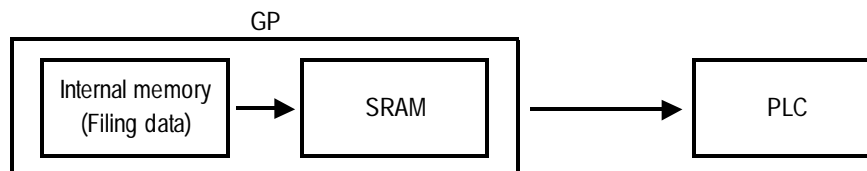

* This function is supported only by the GP77R, GP377 and GP2000 series units.

◆ Filing Data to SRAM

All the filing data is written into the SRAM when the Trigger Bit is turned ON.

Control Word Address
1 to D00200

Write Completed Bit Address
M0001

Data processing

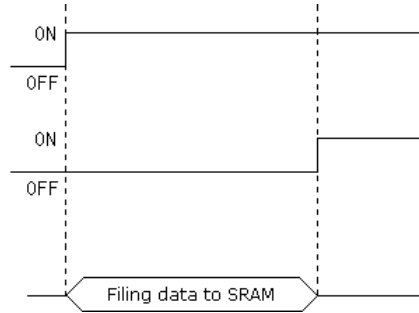

◆ SRAM to PLC

Filing data selected by the GP's touch key is written to the PLC.

■ Operating procedures

- 1) Select an item. (Here, select Block 3 “36°C -”.)

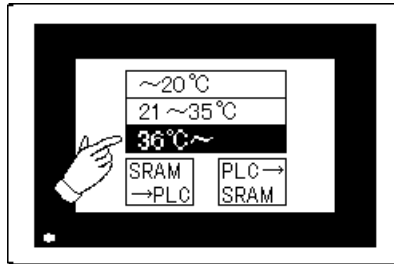

- 2) Touch “SRAM → PLC” key.

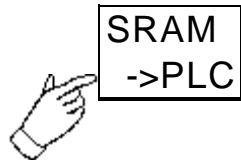

- 3) Filing data is transmitted from SRAM to the PLC.

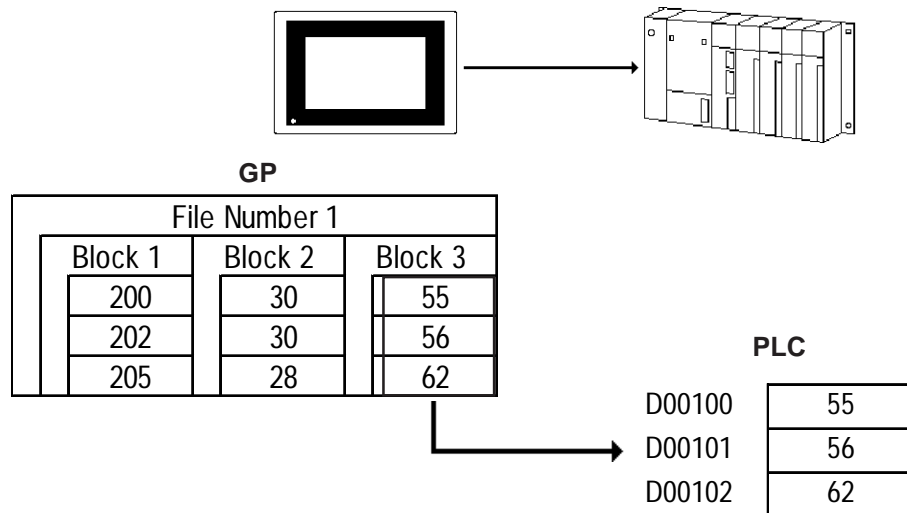

* This function is supported only by the GP77R, GP377 and GP2000 series units.

■ **File Display Settings**

When manual transmission mode is selected, the part "File Data Display" should be placed.

▼ **Reference** ▲ *Operation Manual, 2.1.16 "File Name Display"*

◆ **General Settings**

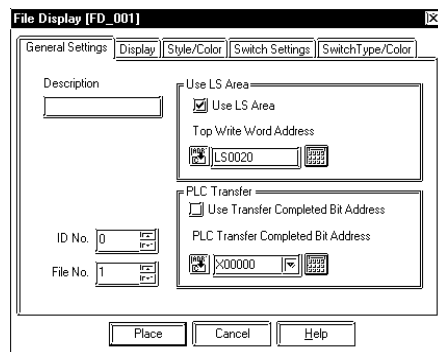

Use LS Area: Selected

Filing data is first transferred to the GP's LS area before being transferred to the PLC. While filing data is being transferred from SRAM to LS, and LS to SRAM, the GP internal special relay (LS2032)'s bit 11 will be turned ON.

Use Transfer Completed Bit Address: Not Selected

Enables/disables the Transfer Completed Bit setting.

ID No.: 0

In this example, where only one Filing Data Display is placed, the ID No. does not need to be entered. Keep the default setting. When placing two or more Filing Data Displays on the currently displayed screen, be sure not to use the same ID No. for multiple Filing Data Displays. Also, when placing a window containing two or more Filing Data Displays on a Base screen, be sure not to use the same ID No. more than once.

File No.: 1

Enter the previously entered filing data number.

◆ **Display**

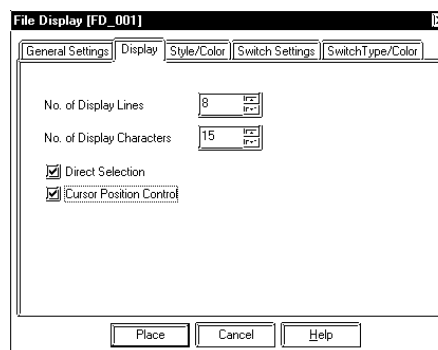

No. of Display Lines: 8

No. of Display Characters: 15

Direct Selection: Selected

Cursor Position Control: Selected



<Cursor Position Control>

- **Even when the screens are changed on the GP monitor, the current File Name Display's cursor position can be retained.**
- **Cursor Position Control can be designated when setting up the File Name Display.**

* This function is supported only by the GP77R, GP377 and GP2000 series units.



- When turning the GP's main power switch ON or resetting the GP, the cursor will appear on the first line.
- The cursor position will be stored for each ID No. (The storage area of an ID No. and a cursor position are in correspondence with each other.) To retain the cursor position, be sure that the File Name Display ID Nos. do not overlap each other on any of the screens. For more detailed information about the File Name Display,

Reference *Operation Manual, 2.1.16 "File Name Display"*

◆ **Switch Settings**

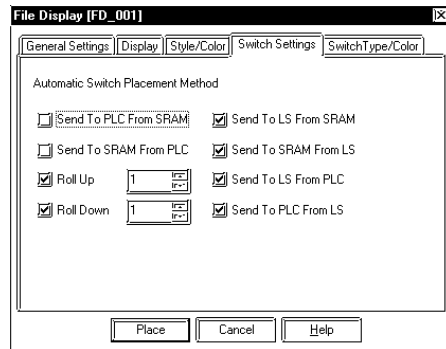

- Send To PLC From SRAM: Not Selected
- Send To SRAM From PLC: Not Selected
- Roll Up: Selected
- Roll Down: Selected
- Send To LS From SRAM: Selected
- Send To SRAM From LS: Selected
- Send To LS From PLC: Selected
- Sending To PLC From LS: Selected

• **Place**

Click on the Place button to display the Filing Data Display. If you wish to change the Part's position or attribute, you need to first ungroup the grouped objects (parts), and then place them in the desired positions.

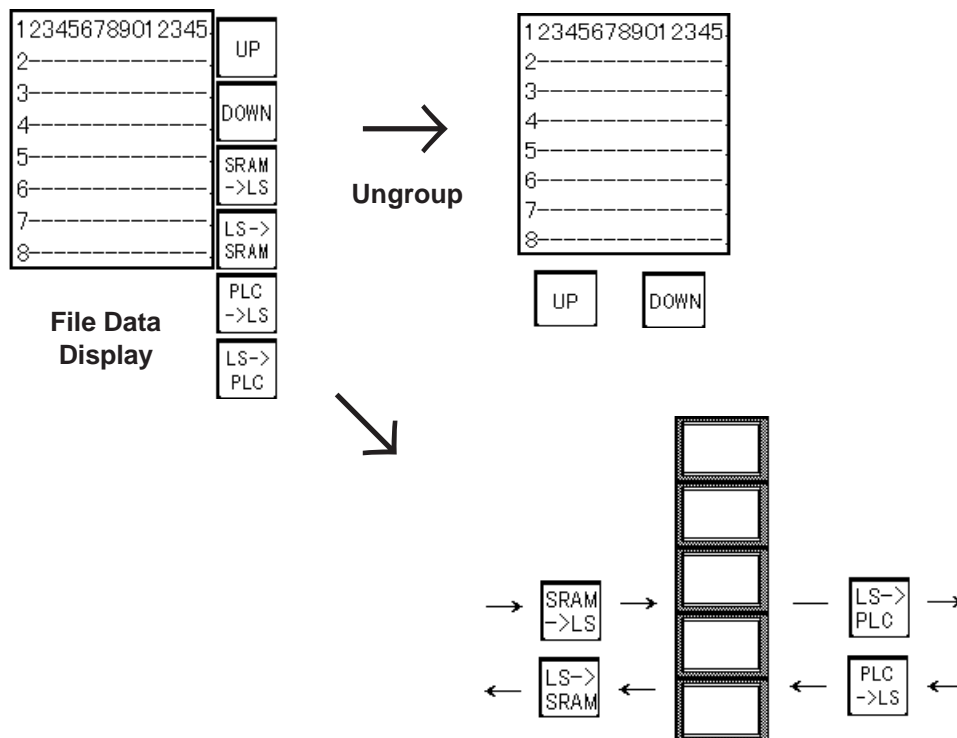

Note: If you wish to change a Part's position or attribute, you need to first ungroup the grouped objects (parts).

* This function is supported only by the GP77R, GP377 and GP2000 series units.

■ Actual Process

1) Writing filing data to SRAM

All filing data is written to SRAM when the Trigger Bit is turned ON.

Trigger Bit Address
D0020000

Write Completed Bit Address
M0001

Data processing

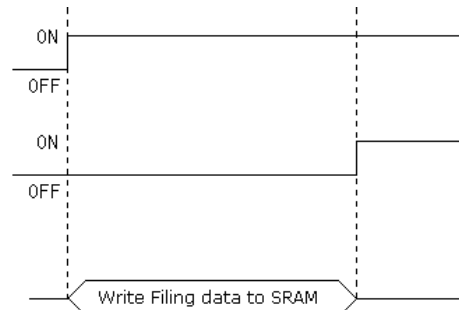

2) Selecting a file name

Select the desired setting by touching Block 2's GP screen data.

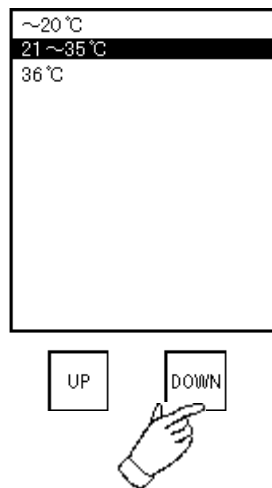

3) Backup SRAM to LS Area

Touching the “SRAM → LS” key will transmit data from SRAM to the LS Area.

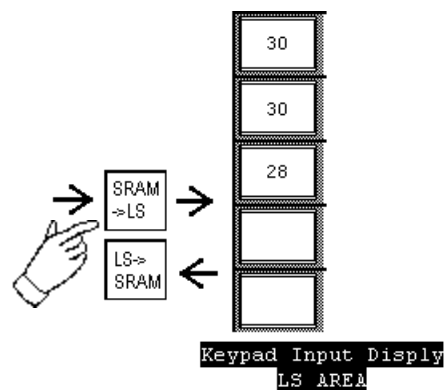

* This function is supported only by the GP77R, GP377 and GP2000 series units.

4) Data Editing

Touch the Keypad Input Display device and display the pop-up keypad. Edit the data with the pop-up keypad.

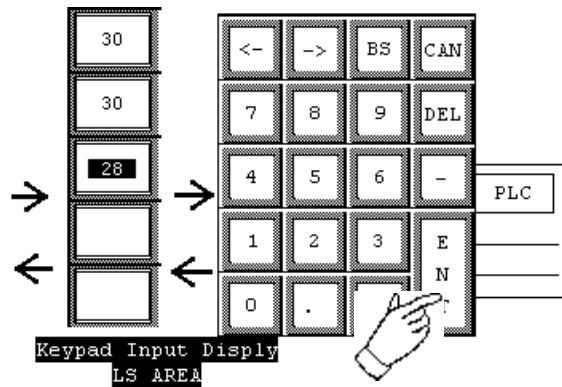

5) LS Area to PLC

The edited data is transmitted to the PLC by touching the LS to PLC key.

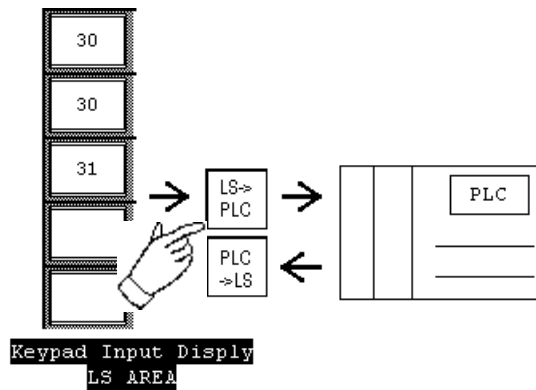

* This function is supported only by the GP77R, GP377 and GP2000 series units.

4.3 Logging Function

With this feature, data of the designated PLC's device is sampled at the designated time or every time a Trigger Bit is turned ON, and is then stored in the GP's backup SRAM. Logging data can be displayed via a Logging Display. Display and print settings can be performed separately.

Reference *Operation Manual, 2.1.17 Data Logging Display*

Logging data can be displayed with its Total, Average, Max. and Min. values, which are set via the Data Calculation Settings.

To analyze the data, create a database with the logging data.

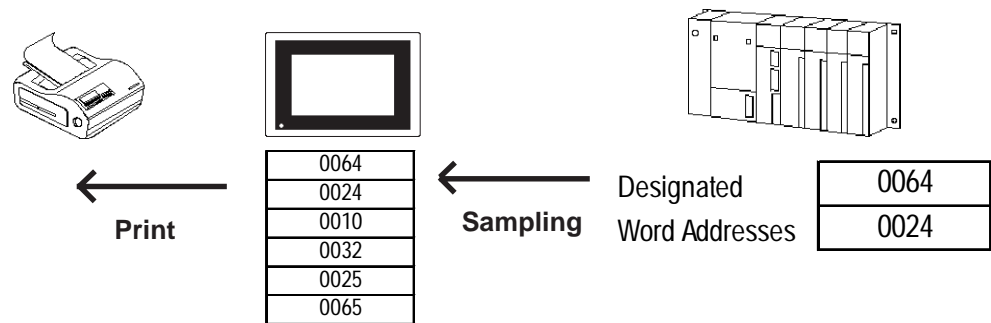

* This function is supported only by the GP77R, GP377 and GP2000 series units.

4.3.1 Logging Function

■ Data Logging Flow

This flow chart shows the logging data flow and each trigger condition.

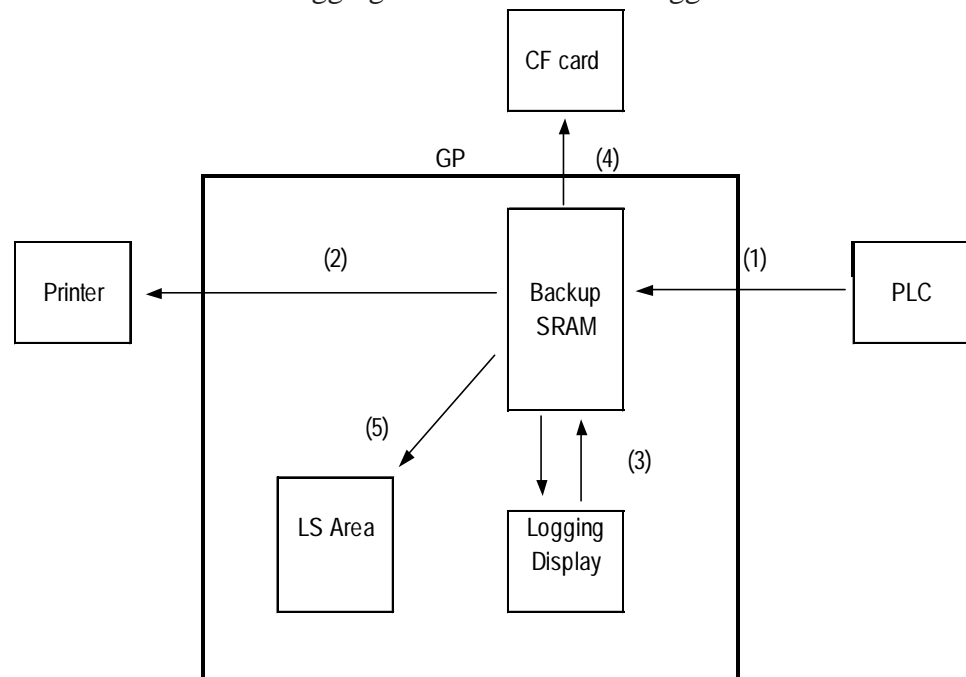

- 1) Logging by the PLC Trigger Bit Address or at designated timing
Reference 4.3.3 “Using the Logging Function”
- 2) Printing for each block via the Control Word Address, or the real time printing
Reference 4.3.3 “Using the Logging Function ■ Print”
- 3) Data display and edit via the Logging Display
Reference 4.3.4 “Display Settings”
- 4) Data storage in a CF card via the Control Word Address
Reference 4.7 “Using the CF Card”
- 5) Data transmission to LS Area via the Control Word Address
Reference 4.3.3 “Using the Logging Function, ■ Write to LS”

■ Group Management of Logging Data

Logging data is managed in the form of files and blocks grouped.

Up to 32 words can be logged at one time. These logged words are called "data". A group of data is called a "block" and a group of blocks are called a "file". Be aware that the number of pieces of data in each block is considered to be the same.

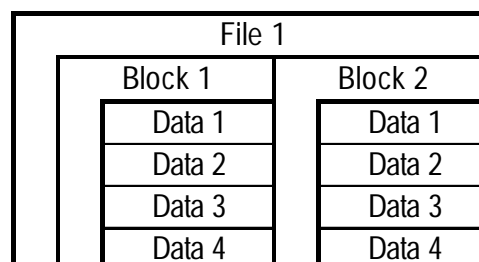

* This function is supported only by the GP77R, GP377 and GP2000 series units.

■ Backup SRAM's Capacity

Backup SRAM's capacity is limited and differs from each series units. The number of logging data, the number of blocks and the frequency of data logging set up must be within these limits.

GP-377 Series	GP-2000 Series	
GP-77R Series	GP-2301/2401/2501/2601 Series	
approx. 95K byte	127K byte	255K byte

The capacity of the backup SRAM used by the logging setting is calculated with the following formula.

▼ Reference ▲ 4.3.1 Logging Function

◆ Setting Example

Number of logging data items: 32 words

Frequency of data logging: 673 times

Number of blocks: 1

<Without Loop Operation>

- Used backup SRAM capacity (byte)

$$= 20 + \{(12 + 2 \times \text{Number of logging data pieces}) \times \text{Frequency of data logging}\} \times \text{Number of blocks}$$

$$= 51168$$

$$51168 \div 1024 = \text{approximately } 50\text{Kbytes}$$

<With Loop Operation>

- Used backup SRAM capacity (byte)

$$= 20 + \{(12 + 2 \times \text{Number of logging data pieces}^{*1}) \times \text{Frequency of data logging}\} \times \text{Number of blocks} + (12 + 2 \times \text{Number of logging data pieces})$$

$$= 51244$$

$$51244 \div 1024 = \text{approximately } 50\text{Kbytes}$$

The above setting example uses approximately 50KB of the backup SRAM.

**1 Regardless whether loop operation is designated or not, when the number of logging data items is an odd number, add 1 to the above calculation. For example, when the number of logging data items is 7, it is considered as 8 words.*

Backup SRAM usage priority order

- 1) Q-tag alarm
- 2) Data sampling
- 3) Trend graph
- 4) LS Area backup
- 5) Logging data
- 6) Filing data

Memory area is used starting from 1).

To check the amount of memory available

Reference Operation Manual, 4.5.1 "Project Information"



Data stored in backup SRAM is erased at the following times:

- When initializing GP memory
- When transmitting screen data from your PC to the GP.
- When setting up the GP system and protocol
- When performing GP's self-diagnosis "Internal FEPRAM (screen area)"

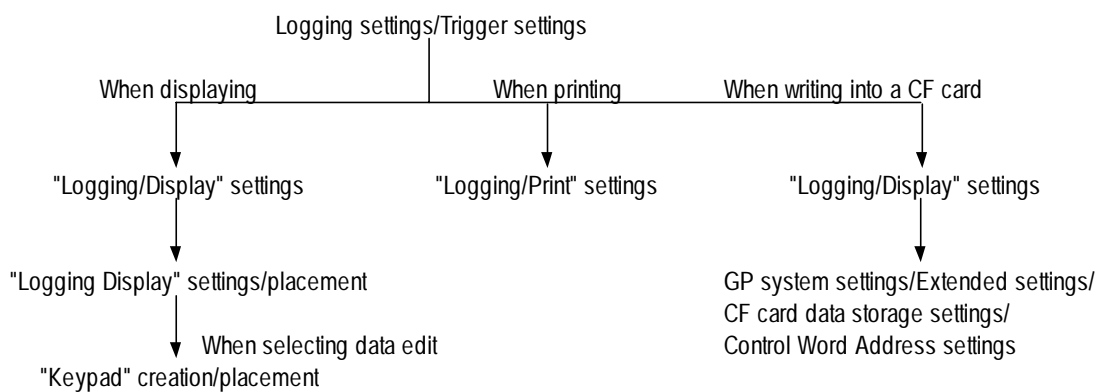
■ Data Logging Procedures (Overview)

* This function is supported only by the GP77R, GP377 and GP2000 series units.

■ Loop Operation

Loop operation can be designated in logging mode. With loop operation selected, when data logging capacity becomes full, logging data will repeatedly be overwritten from the 1st (top) data area (loop operation). Also, the GP's backup SRAM (storage area) becomes one large storage area that has a linked, buffer-like structure.

<Without Loop Operation>

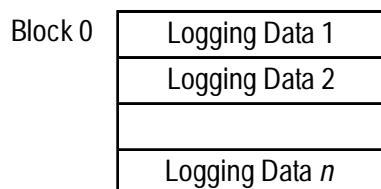

**Each logging data item uses the same number of Words.
The range of the number of Words is from 1 to 32.**

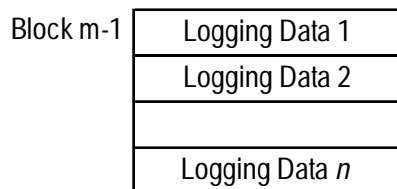
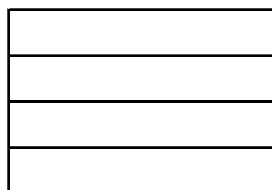
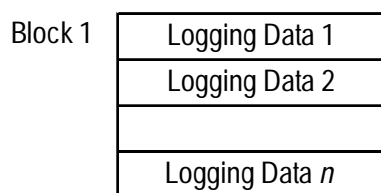

- When data logging is performed for the designated number of blocks, the GP will turn the File Full Bit Address ON and data logging will stop.
- To resume data logging, turn the Data Clear Bit Address ON from the PLC. The GP then clears all logging data and will start data logging from the beginning.

* This function is supported only by the GP77R, GP377 and GP2000 series units.

◆ With Loop operation

When data logging is performed to the end of a loop cycle, data logging repeats from the beginning, and overwrites the existing data.

When data logging is performed to the end of a loop cycle, data logging repeats from the beginning and overwrites the existing data.

Only one block is used, which has a linked, buffer-like structure.

After data logging is completed (and control jumps from the end of the block to the beginning), the GP will turn the File Full Bit Address ON.

Turning this Address ON simply indicates that data logging has been performed from the beginning to the end one time and that data logging will continue.

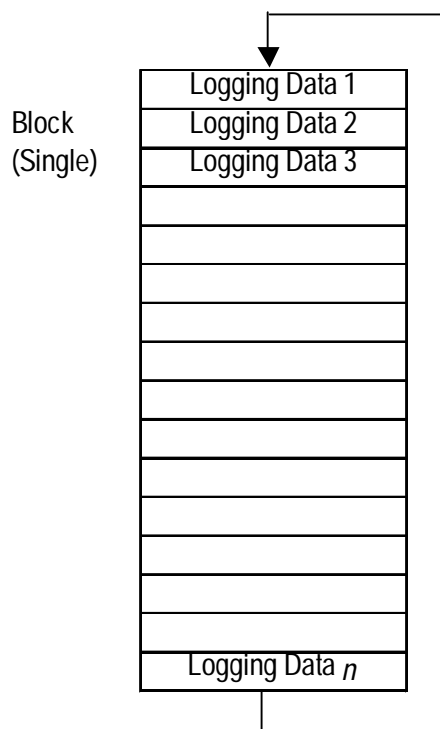

Same as the “Without Loop Operation”, using loop operation, each logging data item also uses from 1 to 32 words.



- **After the PLC detects the File Full Bit's turning ON, turn the Bit OFF.**
- **When the Data Clear Bit Address turns ON from the PLC, the GP clears logging data and repeats data logging from the beginning. When logging data is cleared, the GP turns the Data Clear Bit Address OFF.**

* This function is supported only by the GP77R, GP377 and GP2000 series units.

4.3.2 Logging Data Read Timing



- Note:**
- All the charts shown below are the basic image of GP's logging data read timing. They do not show the exact time intervals of logging data read.
 - If a communication error occurs during logging data read, "***" is displayed on the Logging Display and written to the CSV file, indicating that there is no data.

■ When designating a Bit Address

Logging data is read only one time for each trigger.

When designating a Bit, logging data is read out if the PLC Trigger Bit has been turned ON when the main power is turned ON. After the logging data readout is completed, detect the GP_ACK Bit Address with the connected device (PLC, host), and turn OFF the PLC Trigger Bit Address. When the PLC Trigger Bit Address is turned OFF, the GP_ACK Bit Address is turned OFF automatically.

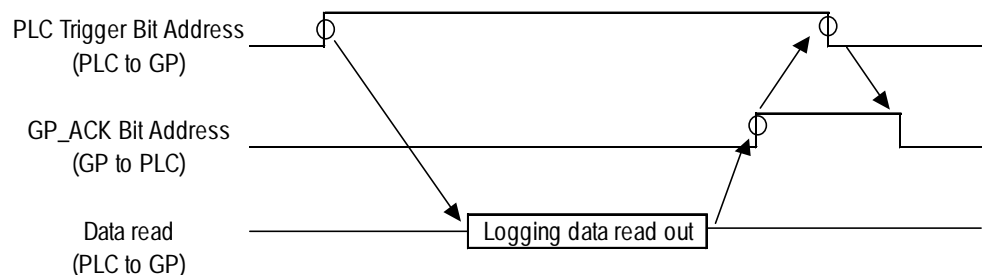

<Procedure>

- 1) Data is set to the PLC Word Address.
- 2) The PLC Trigger Bit Address is turned ON.
- 3) The logging data is read out (one time).
- 4) The GP_ACK Bit Address is turned ON.
- 5) PLC detects the GP_ACK Bit Address is turned ON and the PLC Trigger Bit Address is turned OFF.
- 6) GP detects the PLC Trigger Bit Address is turned OFF and the GP_ACK Bit Address is turned OFF.
- 7) The PLC confirms that the GP_ACK Bit Address is turned OFF.

Prior to performing steps 1) and 2) with the PLC, be sure to confirm that the GP_ACK Bit Address has been turned OFF. Also, assuming that the main power may be turned OFF for some reason, be sure to take appropriate countermeasures such as turning the PLC Trigger Bit and GP_ACK Bit OFF when starting operation.

* This function is supported only by the GP77R, GP377 and GP2000 series units.

■ **When designating time**

Logging data is read only one time at the designated timing. When designating time without using loop operation, a Block's Finish Bit Address is turned ON when a block's data logging is completed, in order to start data read at the data read start time. Logging data in the PLC Word Address is cleared by the PLC.

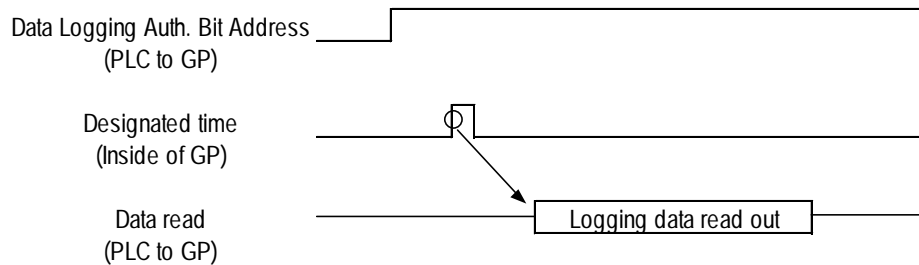

When the time is designated, the start time specified with the logging settings becomes the start data. Therefore, when the GP is turned ON after the start time, the data before power-up will be displayed as "***" and not as the actual values.**

Example: Logging settings

- Start Time: 17:00
- Duration: 30 min.
- Read Count: 4
- Duration: 30 min.

When the GP is turned ON before 17:00

17:00	100
17:30	200
18:00	300
18:30	400

When the GP is turned ON at 18:00

17:00	****
17:30	****
18:00	300
18:30	400

* This function is supported only by the GP77R, GP377 and GP2000 series units.

4.3.3 Using the Logging Function

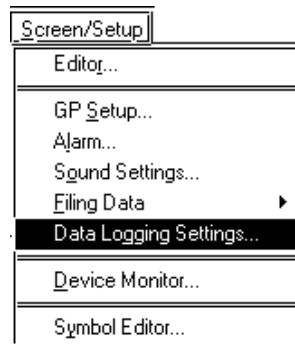

Data Logging Settings

After selecting the Project Manager's [Screen/Setup] - [Data Logging Settings], the following menu will appear.

Set up items in the Trigger Settings, Display, Print, and Write Settings.

■ Data Logging Settings

◆ Trigger Settings (Bit Method)

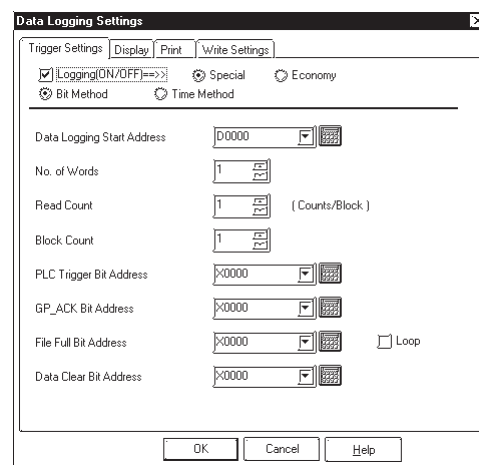

Logging (ON/OFF)

Check this check box when performing data logging.

Bit Method

Select this option when using a Trigger Bit to start data logging.

Data Logging Start Address

Designate the Start Address of the PLC device where data to be logged is stored.

No. of Words

Designate the desired number of words from the Start Address. Up to 32 words can be designated.

Read Count

Designate the frequency of data logging. Data is logged at the frequency designated here and then handled as a block.

Block Count

Designate the number of data blocks. Data is logged for the number of blocks designated here and then handled as a file.

$$1 \leq \text{Times} \times \text{Blocks} \leq 2048$$

PLC Trigger Bit Address

Designate a Bit Address to be used as PLC's trigger. (PLC to GP)

GP_ACK Bit Address

Designate the PLC Bit Address. When data logging is completed one time, GP turns ON the Bit Address designated here. (GP to PLC)

* This function is supported only by the GP77R, GP377 and GP2000 series units.

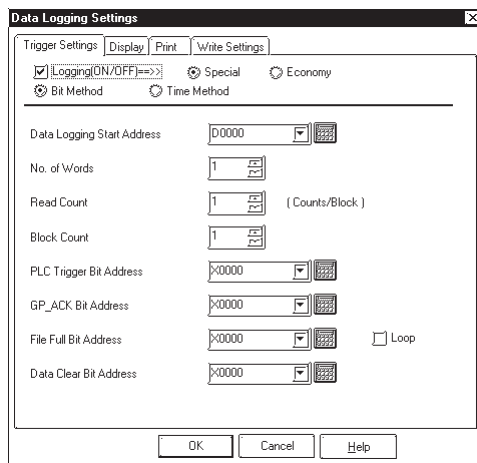

File Full Bit Address

Designate the PLC's Bit Address. When data logging is performed for the designated number of blocks, the Bit Address designated here is turned ON. (GP to PLC) After the PLC detects the Bit Address is turned ON, turn it OFF.

Data Clear Bit Address

Designate the PLC's Bit Address. When the Bit Address designated here is turned ON, data stored in the backup SRAM is deleted. After the backup SRAM data is deleted, GP turns OFF this Bit Address. (PLC to GP, GP to PLC)

Loop

Selecting this feature means when data logging is completed, it will begin again from the top-most data address and overwrite the existing data.

◆ Trigger Settings (Time Method)

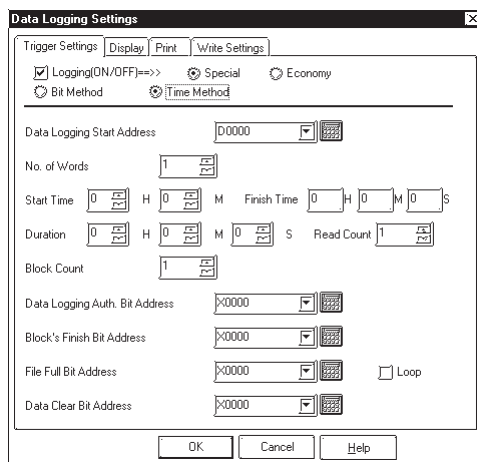

Time Method

Select this option when performing data logging by triggering logging start at the designated timing.

Data Logging Start Address

Designate the Start Address of the PLC device where data to be logged is stored.

No. of Words

Designate the desired number of words counted from the Start Address. Up to 32 words can be designated.

Start Time

Designate the first data logging start time.

Duration

Designate the time period that data logging is performed periodically. "S (second)" setting options are "00", "15", "30", and "45", with 15 second intervals. When designating data logging time, data logged from the start to end times is handled as 1 block.

Read Count

Designate the frequency of data logging between the Start time and End time. Based on the frequency set here, the End time is determined.

* This function is supported only by the GP77R, GP377 and GP2000 series units.

Block Count

Designate the number of data blocks. Data logged for the number of blocks designated here is handled as a file. When designating data logging time, data for a block is logged per day.

$$1 \leq \text{Times} \times \text{Blocks} \leq 2048$$

Data Logging Auth. Bit Address

Designate the PLC's Bit Address. When the Bit Address designated here is turned ON and it becomes the designated logging time, data logging is performed. (PLC to GP)

Block's Finish Bit Address

Designate the PLC's Bit Address. When data logging is completed one time, the Bit Address designated here is turned ON. (GP to PLC) After the PLC detects that the Bit Address is turned ON, turn it OFF.

File Full Bit Address

Designate the PLC's Bit Address. When data logging is completed for block, the Bit Address designated here is turned ON. (GP to PLC) After the PLC detects the Bit Address is turned ON, turn it OFF.

Data Clear Bit Address

Designate the PLC's Bit Address. When the Bit Address designated here is turned ON, data stored in the backup SRAM is deleted. After the data is deleted, GP turns OFF the Bit Address.

(PLC to GP, GP to PLC)

Loop

Selecting this feature means when data logging is completed, it will begin again from the top-most data address and overwrite the existing data.

* This function is supported only by the GP77R, GP377 and GP2000 series units.

<Trigger settings with Loop operation>

Trigger settings will differ depending on the type of Loop operation designated.

[Bit Method]

Item (Trigger Settings)	Without Loop Operation	With Loop Operation
Data Logging Start Address	Designated by user	Designated by user
No. of Words	1 to 32 Words	1 to 32 Words
Read Count	1 to 2048 ^{*1}	1 to 2048
Block Count	1 to 2048 ^{*1}	1 (fixed)
PLC Trigger Bit Address	Designated by user	Designated by user
GP_ACK Bit Address	Designated by user	Designated by user
File Full Bit Address	Designated by user	Designated by user
Data Clear Bit Address	Designated by user	Designated by user

**1. The maximum number of logging Words in all blocks is 2048.
Number of blocks x frequency ≤ 2048*

[Time Method]

Item (Trigger Settings)	Without Loop Operation	With Loop Operation
Data Logging Start Address	Designated by user	Designated by user
No. of Words	1 to 32 Words	1 to 32 Words
Start Time	Hour/Min.	Hour/Min.
Finish Time	No Setting ^{*1}	No Setting ^{*1}
Duration	Hour/Min./Sec.	Hour/Min./Sec.
Read Count	1 to 2048 ^{*2}	1 to 2048 ^{*2}
Block Count	1 to 2048 ^{*2}	1 to 2048 ^{*2}
Data Logging Auth. Bit Address	Designated by user	Designated by user
Block's Finish Bit Address	Designated by user	No Setting
File Full Bit Address	Designated by user	Designated by user
Data Clear Bit Address	Designated by user	Designated by user

**1. The end time is automatically calculated using the time period and frequency.*

**2. The maximum number of logging Words in all blocks is 2048.*

Number of blocks x frequency ≤ 2048

When using loop operation, the number of blocks needs to be designated to decide the Logging area size.

** This function is supported only by the GP77R, GP377 and GP2000 series units.*



The PLC monitors bits at approximately 150 ms intervals. Therefore, a slight time delay may occur until the GP detects the Trigger, or the Data Clear Bit. Set these Bit change intervals to the length of communication cycle or to 150ms, whichever is longer.



- Each piece of data to be logged inside the record is only 16 Bits long. When the PLC device uses 32 Bit length addresses, only the lower 16 Bits of data are logged.
- The GP's internal clock controls time using the last two digits of the year display. Therefore, the logging data's year is controlled by these digits.
- When the Start and End times are the same, or when the time interval is "0", data logging is performed once for each block.
- Data stored in the backup SRAM is cleared via the Data Clear Bit Address, when the Clear Bit changes from OFF to ON.
- When the GP's power is turned ON, if the Data Clear Bit Address's Bit has been turned ON, the GP deletes the backup SRAM logging data and turns OFF the Clear Bit.
- With loop operation and time setup designated, when Data Logging Auth. Bit Address is turned OFF or when the GP's power is turned OFF, after the logging period elapses loop operation becomes the same status as non-loop operation.

(e.g.) Start time 09:00 End time 18:00 Time period 3 hrs.

If the 15:00 logging was skipped due to the GP's power being turned OFF:

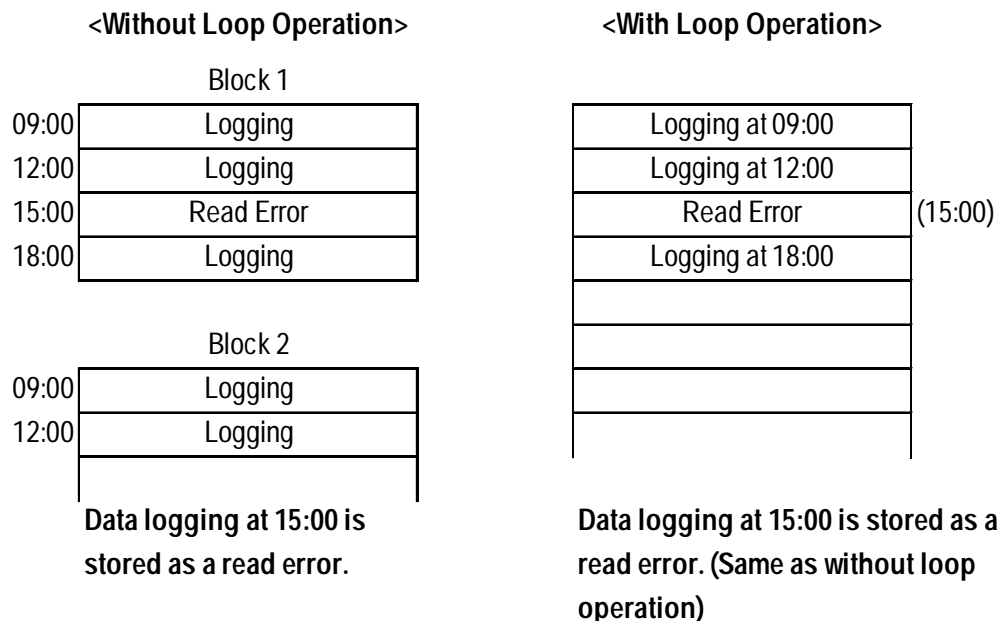

* This function is supported only by the GP77R, GP377 and GP2000 series units.

■ Display

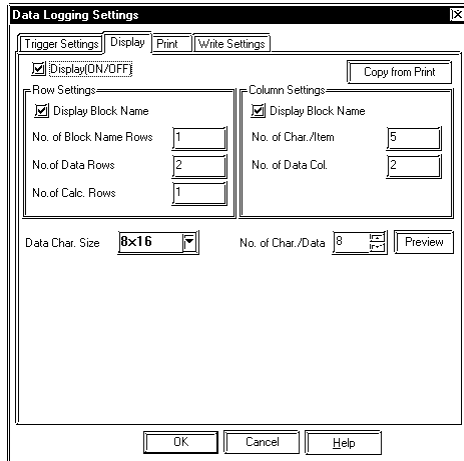

Display (ON/OFF)

Click on this check box to display data using the Logging Display.

Copy from Print

Click this button, when the printing format has already been set up, to use that format for display.

Row Settings

Display Block Name

Check this check box to display data together with its Block Name.

No. of Block Name Rows

Enter a value here to display block names in multiple rows. Up to 3 rows can be set up.

No. of Data Rows

Set up the number of rows in the data display area.

No. of Calc. Rows

Set up the number of rows in the calculation area. Up to 4 rows can be set up.

Column Settings

Display Block Name

Check this check box to display data together with its Block Name.

No. of Char./Item

Designate the maximum number of block name characters.

No. of Data Col.

Designate the number of data display columns in the data display area.

Data Char. Size

Designate the character size for each data in the data display area.

No. of Char. / Data

Designate the number of characters in the data display area.

Preview

The setting contents can be previewed.

Value Copy

When pasting a value, you designate which setting items will be used. As a result, only the designated item(s) will be pasted.

Offset Address / Add

When the offset is designated by the offset address, the column settings area's address offset (the number of words from the logging start address) will be pasted according to the offset designated.

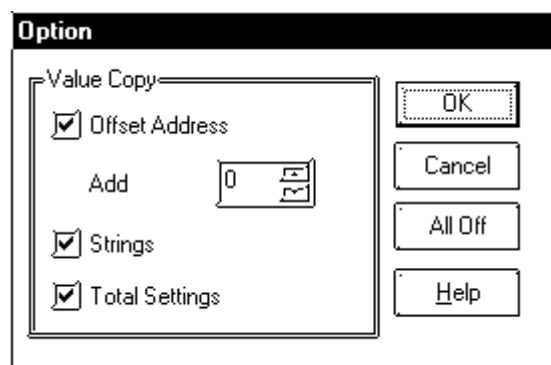

* This function is supported only by the GP77R, GP377 and GP2000 series units.

<Row/Column Settings>

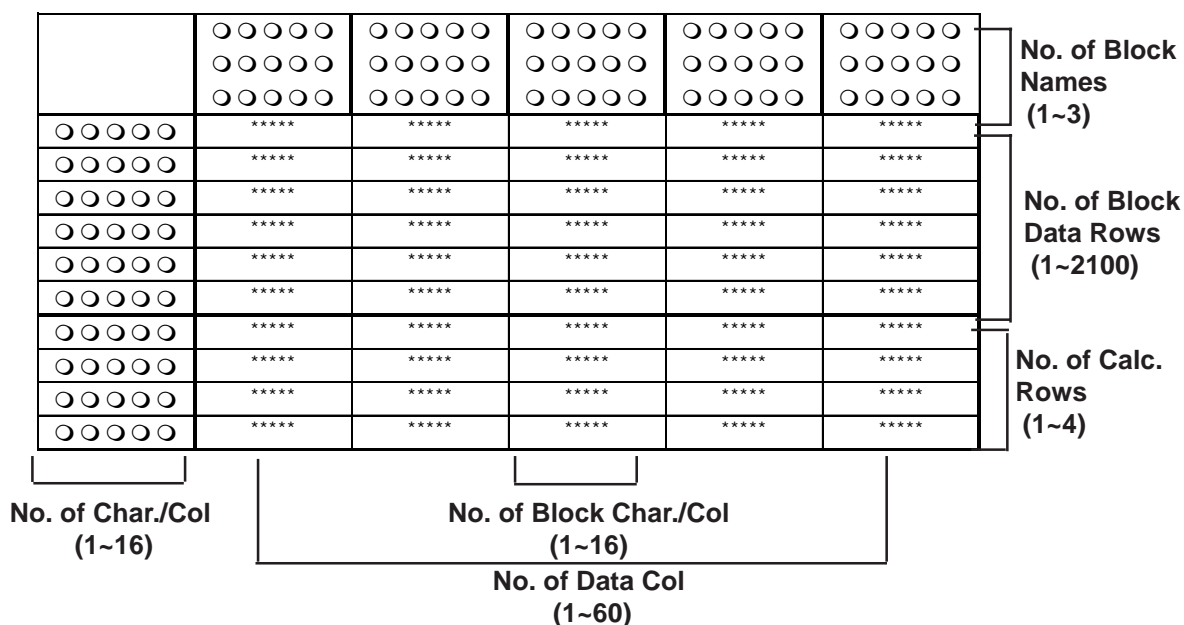

Note: Up to 60 columns and up to 2100 rows of data can be entered. However, since the file capacity is approximately 58KB, depending on the No. of Block Name Rows and No. of Char./Name designated for the cells, these column and row limits will decrease.

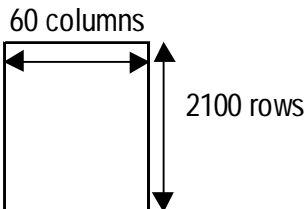

- When the loop feature is used, regardless of the logging frequency, the data display will always be only one row.
- For dialog box display setting information, **Reference** 4.3.4 “Display Settings”.

< Example of display setting with Loop operation >

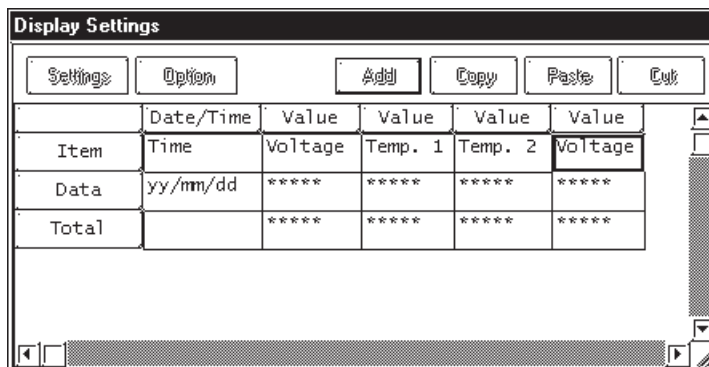

The display row settings used during loop operation are as follows:
(See next page)

* This function is supported only by the GP77R, GP377 and GP2000 series units.

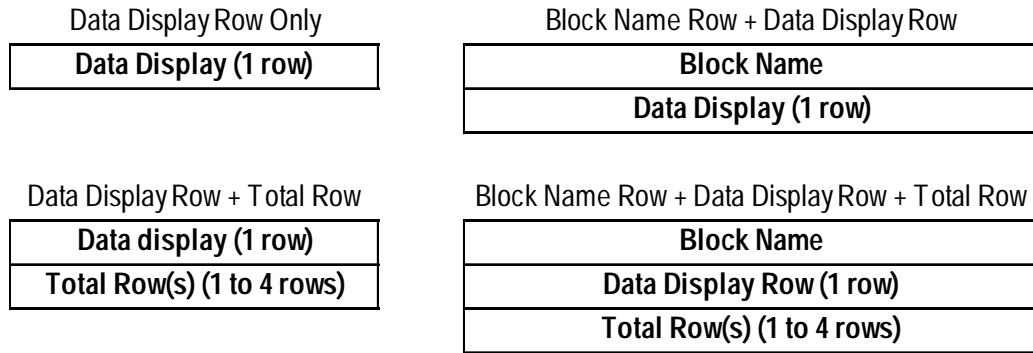

When using the loop feature, the Data Logging Display is as follows:

E.g. When frequency is set to 4

Logging Data (Backup SRAM data)

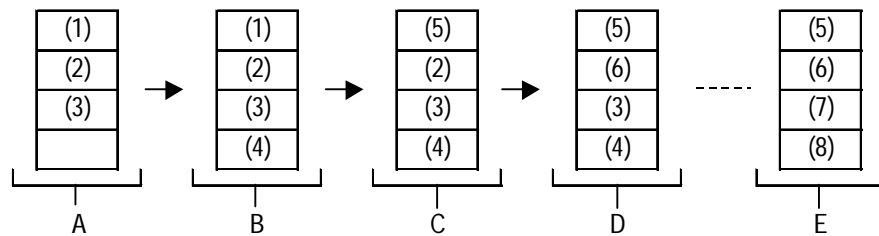

Data Logging Display (Changes over Time)

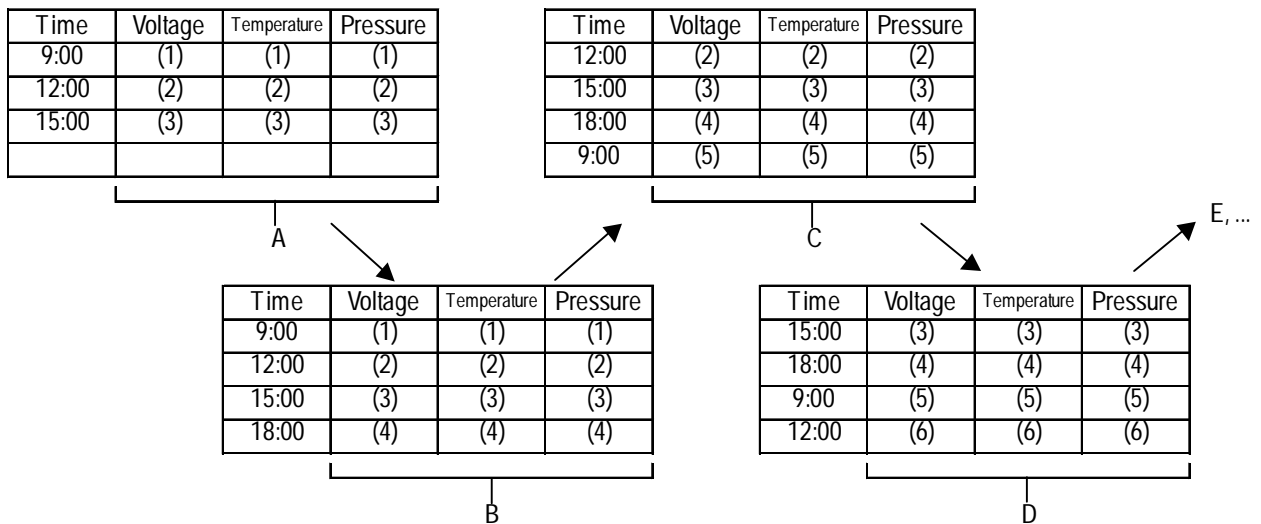

- Here, the oldest (acquired earliest) logging data is displayed in the top-most cell. When a single cycle of data logging is completed from beginning to end, data display rows will then shift upwards one row, every time data is logged.
- When using the loop feature, the Total (Total, Average, Max., Min.) rows will disappear. However, these Total values will be the totals of backup SRAM data at that one pointing in time. Therefore, the new data that overwrites the old data will not be included in the Total values.

* This function is supported only by the GP77R, GP377 and GP2000 series units.

Print

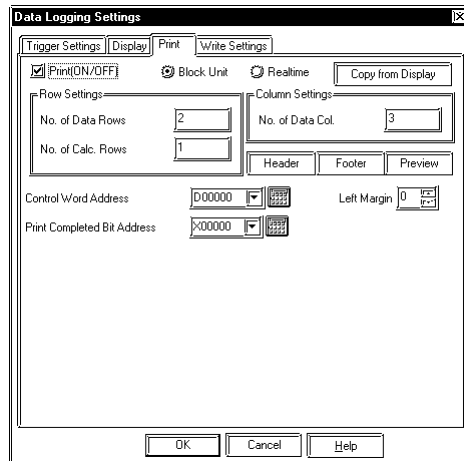

Print (ON/OFF)

Click on this check box to print out the logging data.

Block Unit

Logging data is printed in block units. Printing is started via the Control Word Address.

Realtime

Logging data is printed out each time it is logged.

Copy from Display

Click on this button, when the display format has already been set up, to use that format for printing.

Row Settings

No. of Data Rows

Designates the number of rows in the data print area.

No. of Calc. Rows

Designates the number of rows in the calculation area.

Column Settings

No. of Data Col.

Designates the number of rows in the data print area.

Header

Click on this button to display the header edit window. Enter text on this window. The maximum text entry size is 160 characters for each row and the total of 40 rows.

Footer

Click on this button to display the footer editing window. Enter text in the footer section. The maximum entry size is 160 characters for each row and the total of 40 rows.

Preview

Click on this button to view the printing image of the data, header, and footer areas.

Control Word Address

When data is printed out for each block, the printing starts with the Trigger Bit turned ON. This setting designates that Word Address.

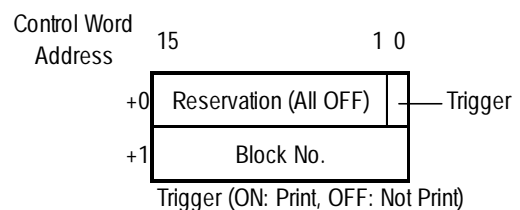

* This function is supported only by the GP77R, GP377 and GP2000 series units.

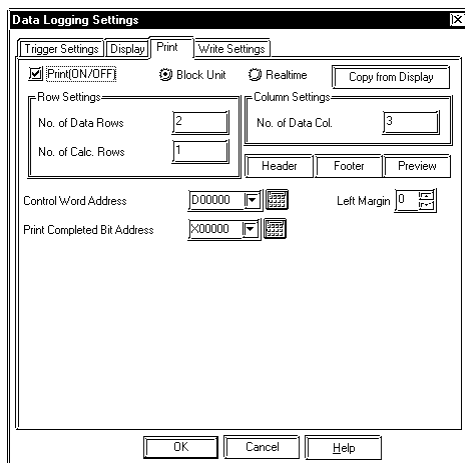

Print Completed Bit Address

Designates the Bit Address to be turned ON at the end of printing, when data is printed out for each block. After confirming that this Bit Address is turned ON, perform the next printing.

Left Margin

Designates the left margin size to be used when printing out the data. The space for the number of the characters designated here is saved as a blank. This setting controls only the data print area.



- For dialog printing settings, refer to **Reference 4.3.5 “Print Settings”**.
- **Note:** When using loop operation and performing real time printing, the Total section will not be printed.
- When using loop operation to perform real time printing, if the logging frequency is not very high or a printer has not yet been connected, printing cannot be performed at the speed the logging data is created, thereby causing a difference between the two. Please note that the first cycle's logging data will not be printed out when data logging is performed to the end of a loop cycle and then repeats from the beginning, overwriting the existing data.

Write to LS

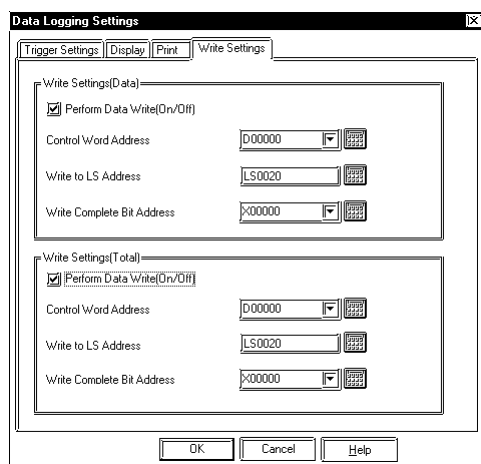

Write Settings (When Writing to LS Area)

Stores logging data in the LS area. Displays logging data items in combination with N-tags.

Perform Data Write (On/Off)

Although all logging data can be displayed at a single time via the display settings, using the LS Area allows each piece of logging data to be displayed separately, together with N-tags. Click on this check box to use this setting.

Control Word Address

Designate a Word Address that is the trigger or mode change for writing data to the LS Area. This Trigger Bit is turned ON or OFF by the PLC. When writing backup SRAM logging data to the LS area, logging data transfer is performed by designating a Block No. (when using loop operation, set to “0”) and turning the Trigger Bit OFF and then ON.

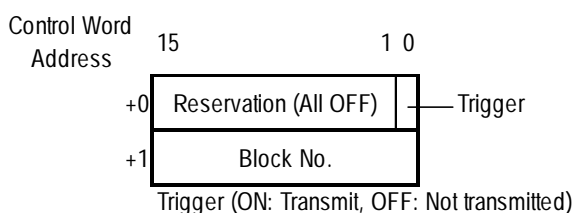

* This function is supported only by the GP77R, GP377 and GP2000 series units.

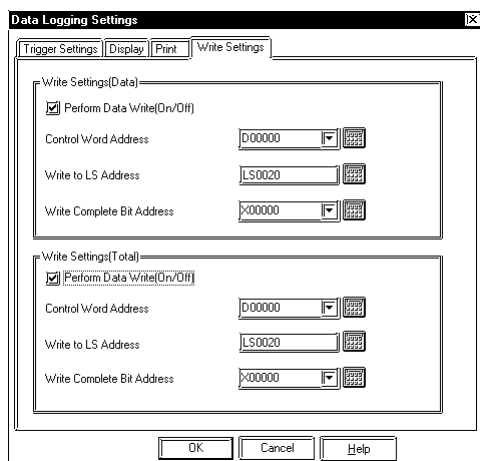

Write to LS Address

Designates the LS Area Address where data is written to.

Write Complete Bit Address

Designates the Bit Address that will be turned ON when data write to the LS Area is completed. After turning the Bit Address ON is detected, use the PLC to turn it OFF. When there is no designated Block No., the Perform Data Write Bit Address is not turned ON.

Write Settings (Total)

Writes each column's total value for each block to the LS area. The Total value is written to the LS area via the Control Word Address, according to the Logging Settings' Display Settings.

Perform Data Write (On/Off)

Designates whether or not the Total value is written to the LS area.

Control Word Address

When writing the Total value to the LS area, transfers the Total value data to the LS area by designating a Block No. and turning the Trigger Bit OFF and then ON.

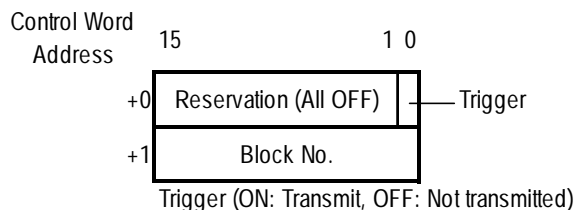

Write to LS Address

Designates the LS Area Address used when writing data.

Write Complete Bit Address

Designates a Bit Address to be turned ON when data write into the LS Area is completed. After the Bit Address ON condition is detected, turn it OFF via the PLC. When there is no designated Block No., the Perform Data Write Bit Address is not turned ON.

* This function is supported only by the GP77R, GP377 and GP2000 series units.

If a data block's size exceeds the LS Area size, that data block cannot be transmitted.

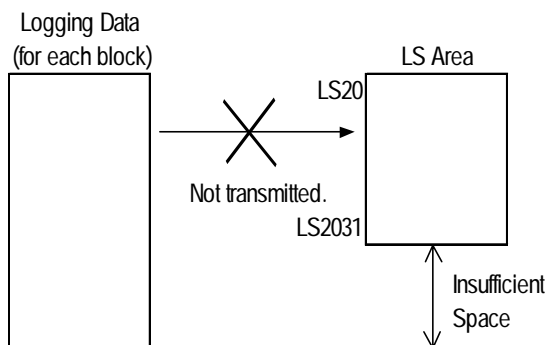

Note: The following is an example of the display settings used when writing each logging data column's total value data to the LS area. (block units)

<Total Value Data and Average Value Data Display>

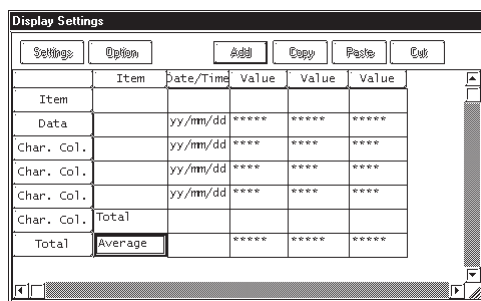

<Total Value Data Write to LS area>

When using the above display settings, the Total value data will be written to the LS area as follows. The Total values (Total, Average, Max., and Min.) are all written as 32 bit data. Also, the Total values will be written from the left column. All values (except Data and Item) will be automatically shifted to the left in a column.

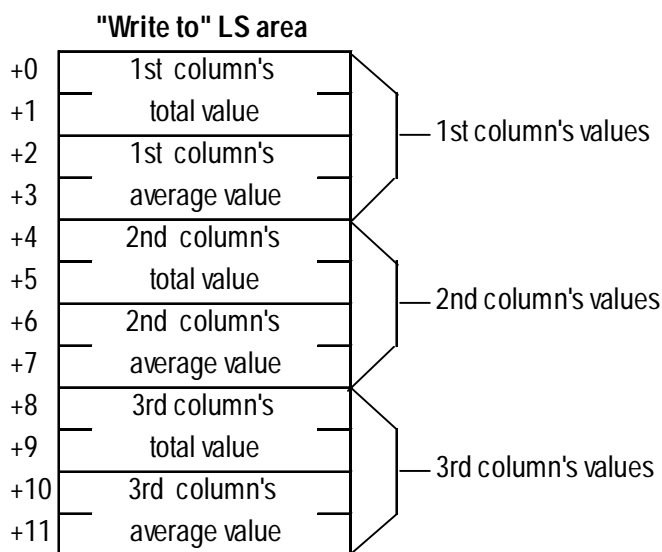

Note: If the size of the Total value data exceeds the LS Area size, that data cannot be transmitted.

* This function is supported only by the GP77R, GP377 and GP2000 series units.

4.3.4 Display Settings

■ Display Settings

In this dialog box, the settings used in the Display tab can be viewed and edited.

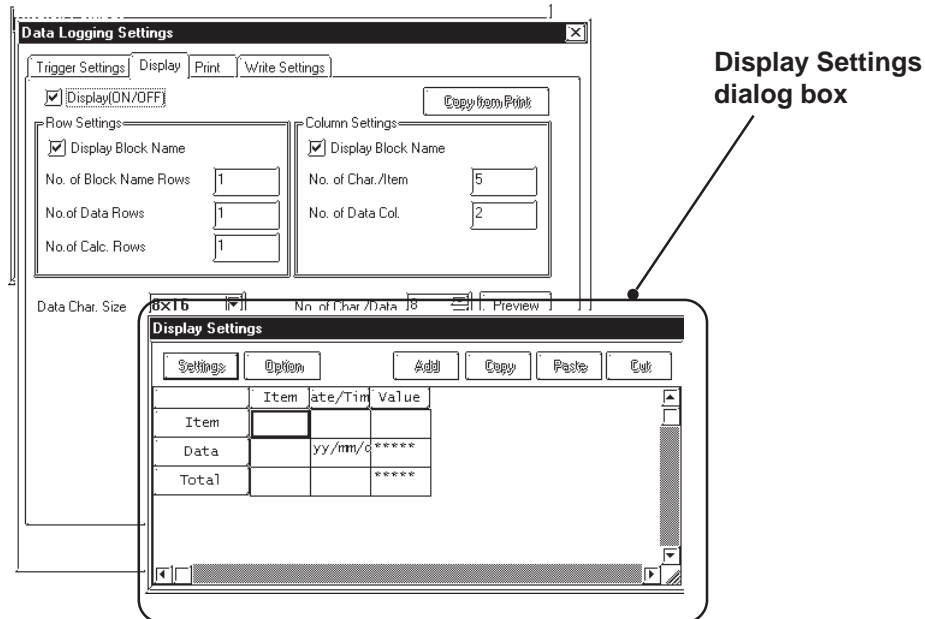

Note: When using loop operation, regardless of the logging frequency, the data display row will be designated as only a single row.

◆ Settings

Rows and columns can be selected to change their attributes.

◆ Add

Select a Data row or Value column and click on the Add button, to create a new row or column.

◆ Copy

Copies the currently selected Data row(s) or Value column(s)' data is copied to the Clipboard.

◆ Paste

Pastes data row or Value column data copied to the Clipboard in the desired position.

◆ Cut

Deletes the currently selected Data row(s) or Value column(s).



Note: When copying row or column data with the same attribute multiple times:

1. Designate the No. of Block Data and No. of Char./Col.
2. Enter all settings for a row or column to create the original data for copying.
3. Select that row or column.
4. Click on the Copy button.
5. Select the destination row or column to paste the copied data to. When copying multiple times, select multiple rows or columns.
6. Click on the Paste button to paste the same attribute to all the selected rows/columns.

* This function is supported only by the GP77R, GP377 and GP2000 series units.

1) Item Name Settings (Display)

■ Enter Item Names

Enter the Item Names for each cell.

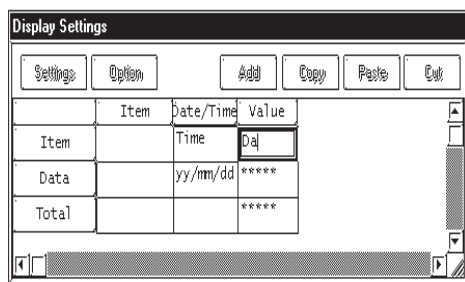

■ Attribute Settings

To change the Item Name attributes, select the Item Name title area and click on the Settings button.

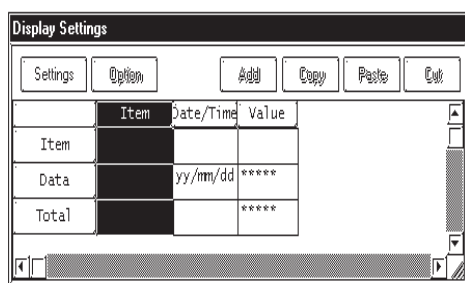

◆ General Info.

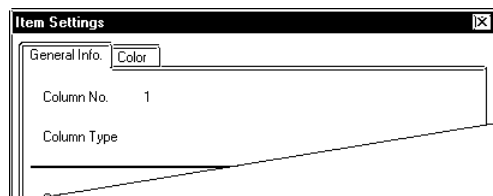

This tab page provides information about the current settings for the Item Name.

◆ Color

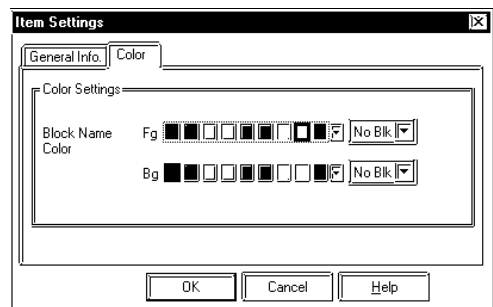

Block Name Color

Select the desired colors for Fg (foreground), Bg (background), and Blk (blink) display.

* This function is supported only by the GP77R, GP377 and GP2000 series units.

2) Column Settings (Display)

■ Attribute Settings

To enter column attribute data, click on a Date/Time or Value title (top bar) and then click on the Settings button.

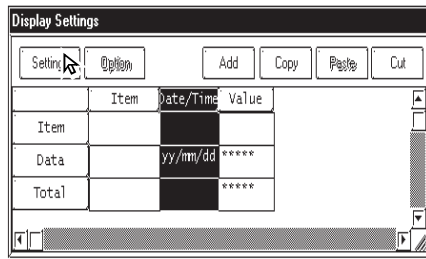

◆ General Info. [Column Type : Date/Time]

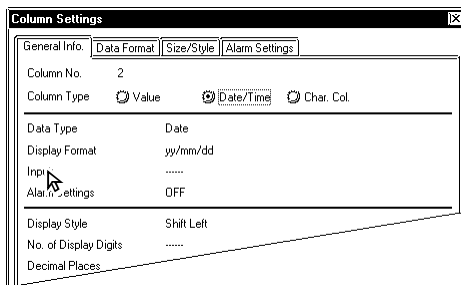

This tab page provides information about the current Column settings.

Column Type

Select the desired display item from Value, Date/Time, or Char.Col.

◆ Data Format

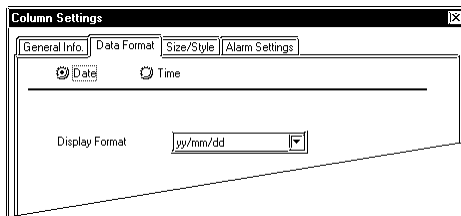

Date

Displays the date.

Time

Displays the time.

Display Format

Select the desired time/date display format.



Note:

There are two types of settings in the Date/Time settings, i.e. date settings and time settings. Time is expressed only by the 24 hour system.

- For date:
 - mm/dd/yy
 - mm/dd
 - yy/mm/dd
 - dd/mm/yy
- For time:
 - hh:mm
 - hh:mm:ss

* This function is supported only by the GP77R, GP377 and GP2000 series units.

◆ **General Info. [Column Type : Value]**

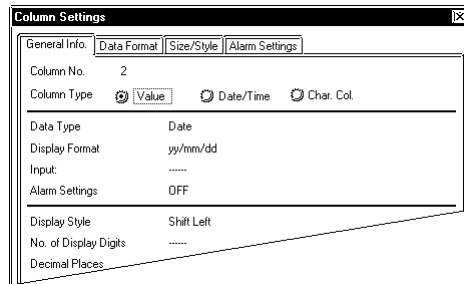

Value

Selecting this option displays actual logging data in the Display Settings area.

◆ **Data Format (Absolute)**

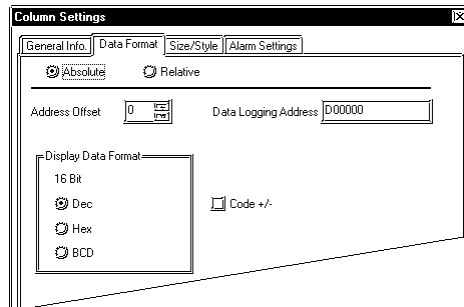

Absolute

Displays Logging Address area Address data.
Address Offset

The Logging Address is changed by the offset value entered here. For example, when the number of logging words is 4, the offset value becomes 0 to 3.

Display Data Format

Select the desired data format from Dec, Hex, and BCD.

Code +/-

Check this check box when displaying negative values. Only available when selecting the Dec data format.

◆ **Data Format (Relative)**

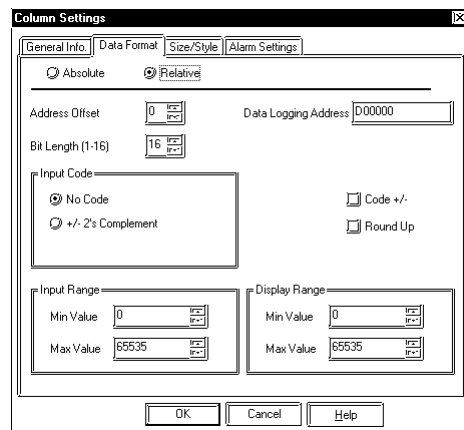

Relative

Data stored in the Address entered in the Logging Address area is converted according to the Input Range area's values and the converted data values are displayed.

Address Offset

The Logging Address is changed by the offset value entered here. For example, when the number of logging words is 4, the offset value becomes 0 to 3.

Bit Length (1-16)

Enter the Enabled Bit length of data to be stored in the Logging Address.

Input Code

No Code

Displays positive values only.

+/-2's Complement

Uses 2's complement to express negative values.

+/-MSB Code

Uses the MSB code system to express negative values.

* This function is supported only by the GP77R, GP377 and GP2000 series units.

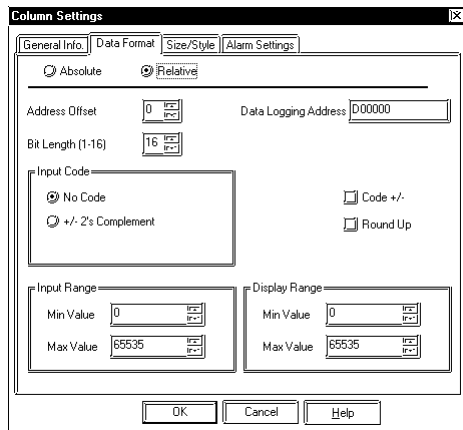
**Code +/-**

Check this check box when displaying negative values. Only available when selecting the Dec data format.

Round Up

The decimal point numbers created during relative value range conversion will be rounded up or off. When this option is not selected, those numbers will be rounded off.

Input Range**Min. Value****Max. Value**

Designates the range of values stored in the Logging Address. The possible ranges vary depending on the Input Code Format.

Display Range**Min. Value****Max. Value**

Designates the range of values displayed in the N-tag. The possible ranges vary depending on the Display Format and Code +/- settings. **Reference 2.17.4 “Relative Data Display Settings”, N-tag**

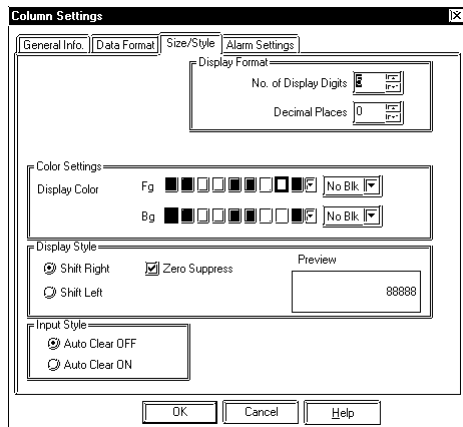
◆ Size/Style**Display Format****No. of Display Digits**

Designates the number of digits for the display within the range of characters designated in the Display tab, usually as 1 to 16 digits. The length designated here includes digits after the decimal point, but not the decimal point itself.

Decimal Places

Designates the number of digits displayed after the decimal point, usually as 0 to 14 digits. This setting is valid only for Dec and BCD formats. Enter “0” when not displaying decimal place numbers.

Color Settings

Select the desired colors for Fg (foreground), Bg (background), and Blk (blink). When the Alarm option is selected, the color attributes designated here are used for normal display.

Reference 2.1.5 “Color Settings”, A-tag

Display Style**Shift Right****Shift Left**

* This function is supported only by the GP77R, GP377 and GP2000 series units.

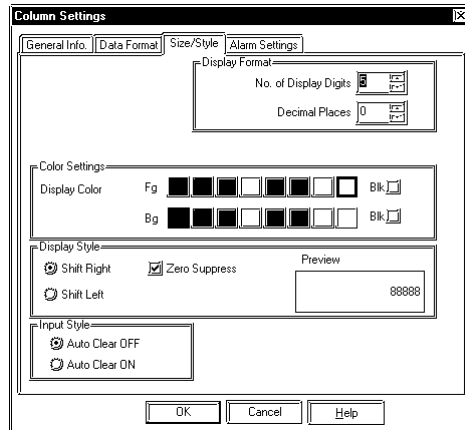

Select the display style from the Shift Right and Shift Left. The data will appear, starting from the side designated here. Shift Left has been selected as the default setting.

Zero Suppress

Check this check box to omit the leading zeros of display data. (e.g) When the Display Length is 4 and the Zero Suppress is NOT selected, “25” appears as 0025.

Input Style

Auto Clear OFF

In this mode, the previously entered values are not cleared and newly entered values are added to those values. To clear the previously entered values, press “CLR” of the touch keyboard.

Auto Clear ON

When the first character of a value is entered (excluding moving the cursor, entering ENT, DEL and BS), the previously entered value is cleared.



Note: Date/Time and Value data, except for the text characters, are centered. Also, a 2 dot space is automatically inserted in the upper, lower, right and left sides.

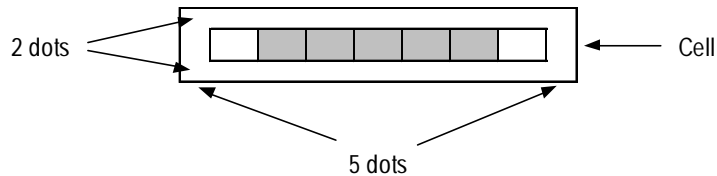

For example, when the number of characters are 7 and the number of numeric value’s digits are 5 in a cell, space for one character is saved on both left and right sides and displayed data is centered.

◆ **Alarm Settings**

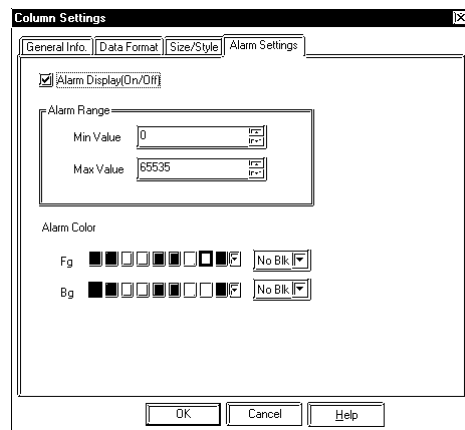

Alarm Display (On/Off)

Select this check box to display the Alarm display.

Alarm Range

Min. Value

Max. Value

When the Alarm Type is set to Direct, designate the Alarm Range. When selecting Relative value display, the Display Range designated in the Data Format tab is used as normal display’s Min. and Max. Values automatically. The possible Alarm ranges varies depending on the Data Format selected.

* This function is supported only by the GP77R, GP377 and GP2000 series units.

Alarm Color

If the data exceeds the Alarm Range, the Alarm display appears in the designated colors.

<Alarm Range List>

Data Format			Alarm Range
		Code+/-	
16 Bits	Dec	+/-	-32768 ~ 32767
		+	0 ~ 65535
	Hex	/	0 ~ FFFF(h)
	BCD	/	0 ~ 9999

◆ **Size/Style**

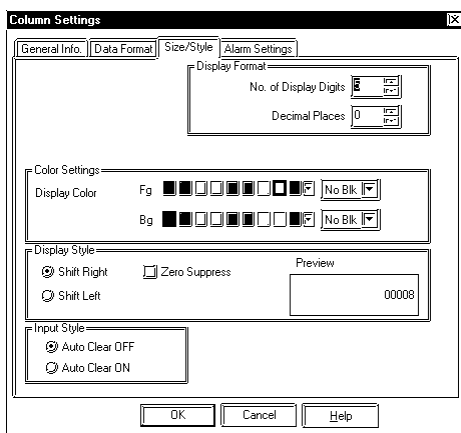

Color Settings

Select the desired colors for Fg (foreground), Bg (background) and Blk (blink).

Reference 2.1.5 “Color Settings”, A-tag

◆ **General Info. [Column Type : Char. Col]**

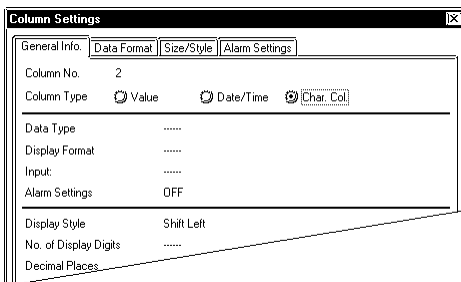

Char.Col

Displays text.

* This function is supported only by the GP77R, GP377 and GP2000 series units.

3) Row Settings (Display)

■ Attribute Settings

Select either Item Name or Data row, and click on the Settings button to edit each row's attributes.

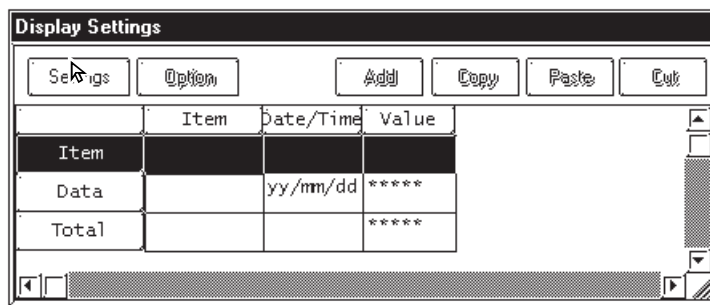

[Selecting Item Name Row]

◆ General Info.

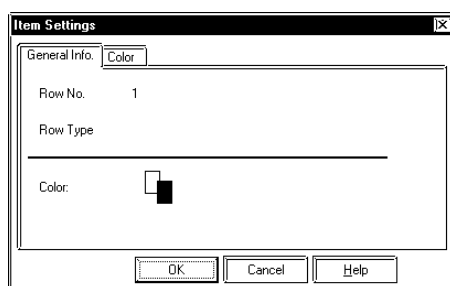

The General Info. page provides information about the current settings for Item Name Settings.

◆ Color

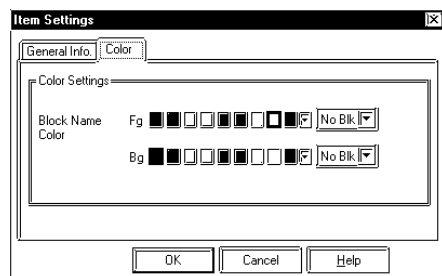

Color Settings

Select the desired colors for Fg (foreground), Bg (background) and Blk (blink).

▶ Reference ◀ 2.1.5 “Color Settings”, A-tag



Note: The row color settings have priority over the column color settings.

[Selecting Data Row]

◆ General Info.

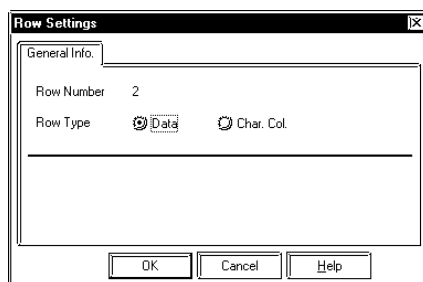

The General Info. page provides information about the current settings for Data settings.

Row Type

Select the desired type of display from the Data and Char.Col. settings.

* This function is supported only by the GP77R, GP377 and GP2000 series units.

4) Totals (Display)

■ Attribute Settings

To set up the calculation attributes, select the Totals cell and click on the Settings button.

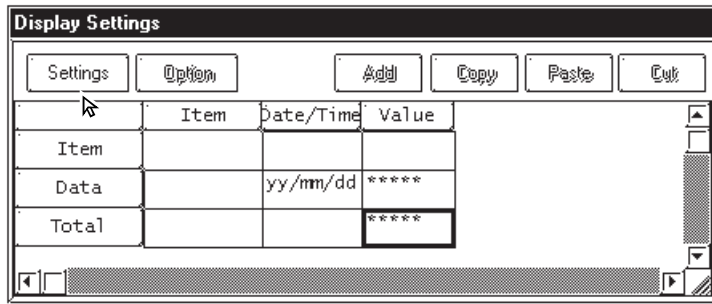

◆ General Info.

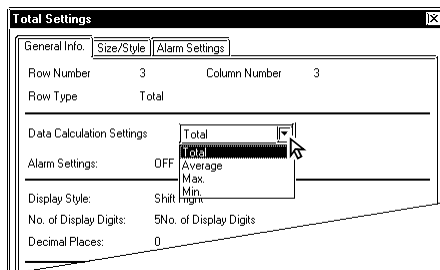

The General Info. page provides information about the current settings for Totals Settings.

Data Calculation Settings

Select the desired calculation item from Total, Average, Maximum and Minimum. The calculation attributes can be set up for the entire Data row or Value column. At this time, the applicable column's attribute is Date/Time or Char.Col., and the Data Calculation Settings cannot be designated. Data calculation is performed via the 32 Bit format.

◆ Size/Style

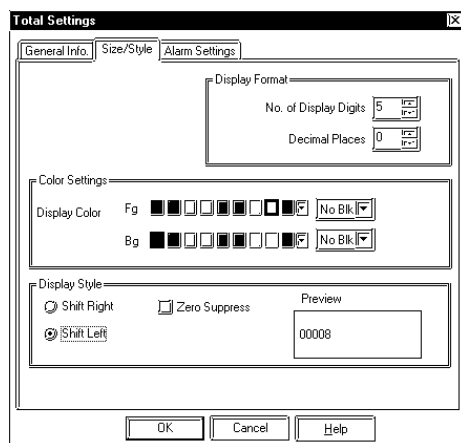

Display Format

No. of Display Digits

Enter the number of display digits. The numbers displayed after the decimal point is also included. (However, the decimal point is not included itself.) Enter a value in a range from 1 to 16.

Decimal Places

Enter the number of digits after the decimal point in a range from 0 to 14. This setting is Enabled only when the Data Format is designated as Dec or BCD. If the values after the decimal point are not displayed, enter "0".

* This function is supported only by the GP77R, GP377 and GP2000 series units.

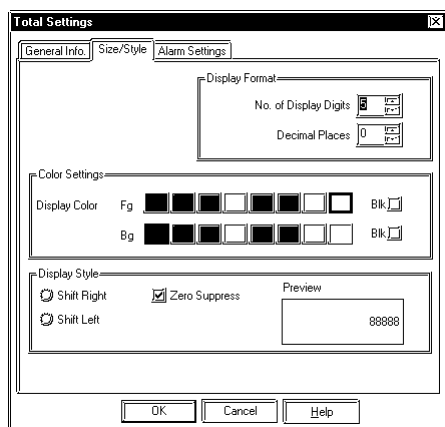

Color Settings

Select the desired colors for Fg (foreground), Bg (background) and Blk (blink). When the Alarm option is selected, the color attributes designated here are used for normal display.

Reference 2.1.5 “Color Settings”, A-tag

Display Style

Shift Right

Shift Left

Select either shift type. Data is displayed from the selected position. The default setting is Shift Left.

Zero Suppress

When 0 suppression check box is checked, all unnecessary 0s are not displayed. When this check is removed, 0s are added to the front of numbers to match the display length designated in the No. of Display Digits area. (e.g. When the No. of Display Digits is 4 and 0 suppression is OFF, value 25 appears as “0025”.)

* This function is supported only by the GP77R, GP377 and GP2000 series units.

■ Display Settings Maximum File Size

The display settings' file size capacity is limited. Therefore, depending on the specific setting combination, the user's file size may exceed this capacity. The following example is the standard display setting size.

- Enter the Block Name in the 1st column and then up to 8 single-byte characters in each column.
- Enter the Block Name in the 1st row and then up to 8 single-byte characters in each row.
- Four rows are available for totals. (Total, Average, Max., Min.)

		No. of value columns						
		Block Name	Date	Time	Value	Value	-----	Value
No. of data display rows	Block Name		ABCDEFGH	ABCDEFGH	ABCDEFGH	ABCDEFGH		ABCDEFGH
	Data display	ABCDEFGH						
	Data display	ABCDEFGH						
	Data display	ABCDEFGH						
	⋮							
	Data display	ABCDEFGH						
	Total (Total)	ABCDEFGH						
	Total (Average)	ABCDEFGH						
	Total (Max.)	ABCDEFGH						
	Total (Min.)	ABCDEFGH						

When using the pattern shown above, the maximum number of value columns and data display rows are as follows:

No. of Value Columns	No. of Data Display Rows	Remarks
32	1007	When the No. of value columns (No. of logging words) is the maximum (32 columns).
16	1116	When the No. of value columns (No. of logging words) is the maximum (16 columns).
8	1170	When the No. of value columns (No. of logging words) is the maximum (8 columns).
4	1197	When the No. of value columns (No. of logging words) is the maximum (4 columns).



Important

When designating the columns as the block name display and entering characters in each column, the file size will become extremely large. Depending on the number of characters entered and other items designated, approximately 1000 rows can be used for the pattern shown above.

* This function is supported only by the GP77R, GP377 and GP2000 series units.

4.3.5 Print Settings

In this dialog box, the current Print Settings applied in the Print screen can be viewed and edited. This function is supported only by the GP77R, GP377 and GP2000 (except GP-2301) series units. (Optional multi-unit must be attached with GP-377R series units.)

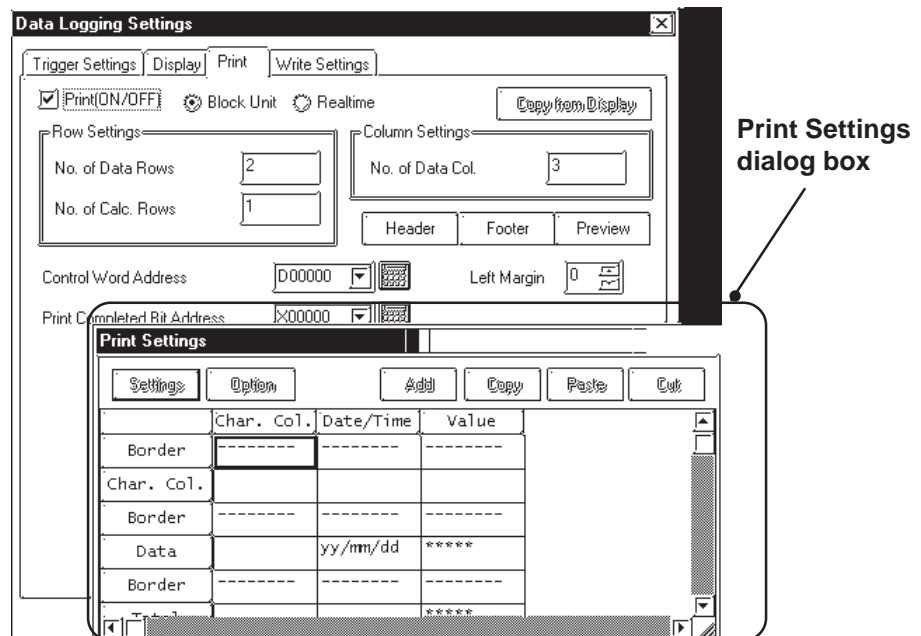

When using the Loop, regardless of the logging frequency, the data display row will be designated as a single row.

◆ Settings

To change row/column attributes, select the desired row or column and click on the Edit button.

◆ Add

Select a row or column and click on the Add button, then one row or column is added.

◆ Copy

Copies the currently selected row or column data to the Clipboard.

◆ Paste

Pastes the copied row or column data to the desired position.

◆ Cut

Deletes the currently selected row(s) or column(s) are deleted.

* This function is supported only by the GP77R, GP377 and GP2000 series units.

1) Column Settings (Print)

■ Attribute Settings

To set up column attributes, select either a Ruled Line, the Date/Time, or a String(Char.Col.), and click on the Settings button.

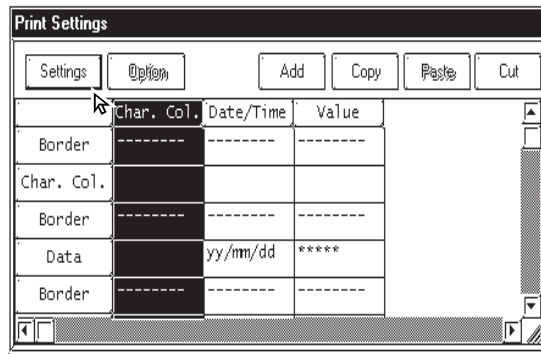

◆ General Info.

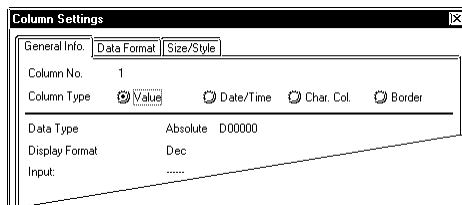

The **General Info.** page provides information about the current Column Settings in use.

Column Type

Select the desired display item from Value, Date/Time, Char.Col. or Border.

◆ General Info. [Column Type : Value]

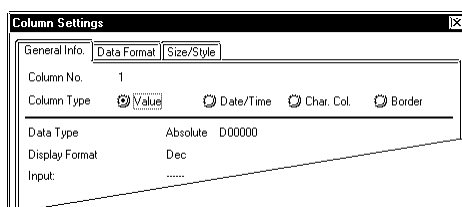

Value

When this option is selected, numeric data is printed out.

◆ Data Format

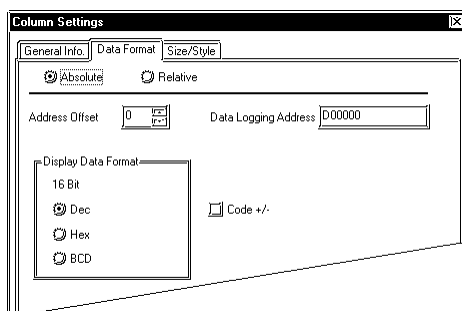

Absolute

Data stored in the Address displayed in the Logging Address area is directly printed out. This data is handled as an absolute value.

Address Offset

The Logging Address is changed by the offset value entered here. For example, when the number of logging words is 4, the offset value becomes 0 to 3.

* This function is supported only by the GP77R, GP377 and GP2000 series units.

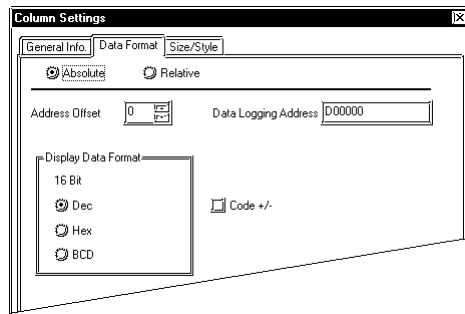

Display Data Format

Select the desired data format from Dec, Hex and BCD.

Code +/-

Check this check box when printing negative values. Only available when selecting the Dec data format.

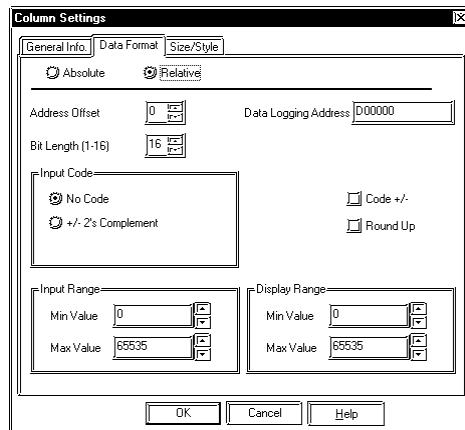

Relative

Data stored in the Address entered in the Logging Address area is converted according to the Input Range area's values and the converted numeric data is printed out.

Address Offset

The Logging Address is changed by the offset value entered here. For example, when the number of logging words is 4, the offset value becomes from 0 to 3.

Bit Length

Enter the Enabled Bit length of data to be stored in the Logging Address.

Input Code Format

No Code

Displays positive values only.

+/-2's Complement

Uses 2's complement to express negative values.

Code +/-

Check this check box when displaying negative values. Only available when selecting the Dec data format.

Round Up

Round up displaying or printing values.

Input Range

Min. Value

Max. Value

Designate the range of values stored in the Logging Address. The possible ranges vary depending on the Input Code Format settings.

* This function is supported only by the GP77R, GP377 and GP2000 series units.

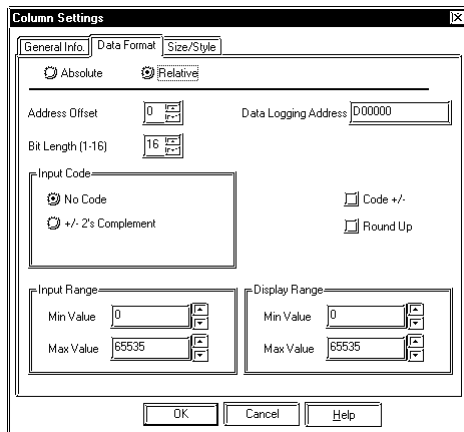

Display Range

Min. Value

Max. Value

Designate the range of values displayed in the N-tag. The possible ranges vary depending on the Display Format and Code +/- settings.

Reference 2.17.4 “Relative Data Display Settings”, N-tag

◆ Size/Style

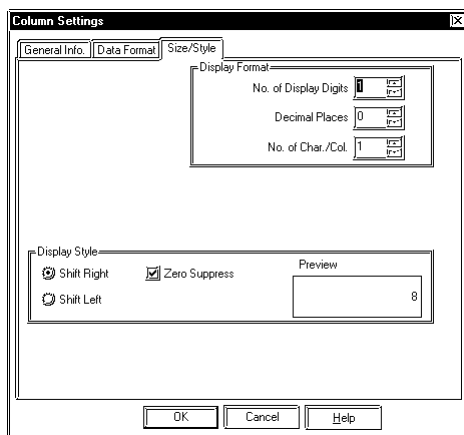

Display Format

No. of Display Digits

Designate the number of digits for the display within the range of characters designated in the Display Setting area, usually 1 to 14 digits. The length designated here includes digits after the decimal point, but not the decimal point itself.

No. of display digits = 1 ~ ((No. of data char.) - (Code +/-) - (Decimal places))

Decimal Places

Designates the number of digits displayed after the decimal point usually as 0 to 16. This setting is valid only for Dec and BCD formats. You can designate the value from 0 to 16. Enter “0” when not displaying decimal place numbers.

Decimal Places = 0 ~ (No. of display digits - 1)

No. of Char./Col.

Designates the cell size. Enter a value in a range from 1 to 32 (digits).

Display Style

Shift Right

Shift Left

Select either shift type. Data is displayed from the selected position. The default setting is Shift Left.

Zero Suppress

When 0 suppression check box is checked, all unnecessary 0s are not displayed. When this check is removed, 0s are added to the front of numbers to match the Display Length. (e.g. When the No. of Display Digits is 4 and 0 suppression is OFF, value 25 appears as “0025”.)

* This function is supported only by the GP77R, GP377 and GP2000 series units.



Note: Date/Time and Value data, except for text data, is printed in the middle of a cell. When the center point cannot be designated due to the number of characters, text is shifted to right for one character. When designating Char. Col. for Column Type, data is printed being shifted left.

◆ **General Info. [Column Type : Date/Time]**

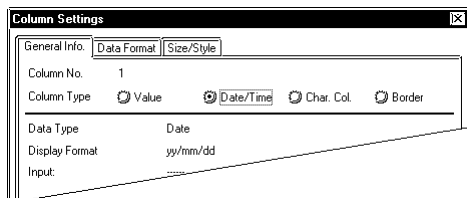

Date/Time

Prints out Time and Date data.

◆ **Data Format**

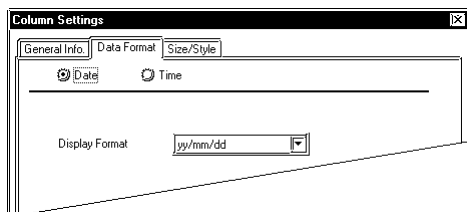

Date

Prints out date data.

Time

Prints out time data.

Display Format

Select the desired time/date display format.



Note: Date/Time settings have two settings, i.e. Date settings and Time settings. Time data is printed out only via the 24 hour system.

- **For date:**
 mm/dd/yy
 mm/dd
 yy/mm/dd
 dd/mm/yy
- **For time:**
 hh:mm
 hh:mm:ss

◆ **Size/Style**

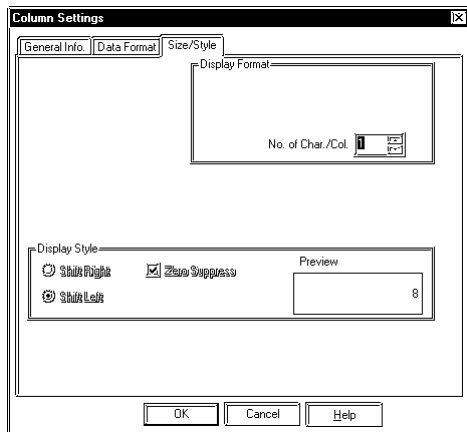

No. of Char./Col.

Designates the cell size. Enter a value from 1 to 32 (digits).

* This function is supported only by the GP77R, GP377 and GP2000 series units.

◆ **General Info. [Column Type : Char. Col.]**

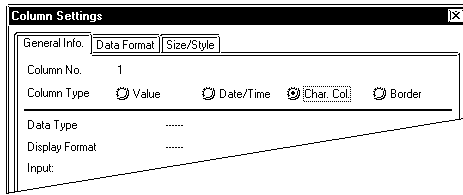

Char. Col.
Prints out the text.

◆ **Size/Style**

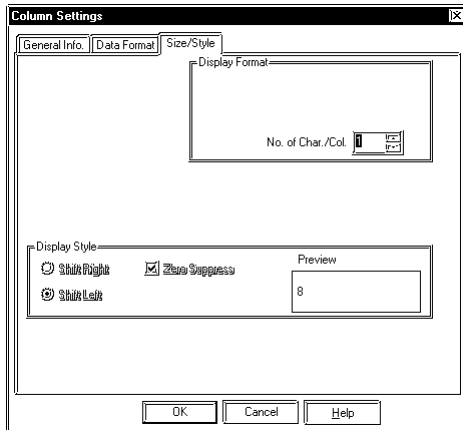

No. of Char./Col.
Designates the cell size. Enter a value from 1 to 32 (digits).

◆ **General Info. [Column Type : Border]**

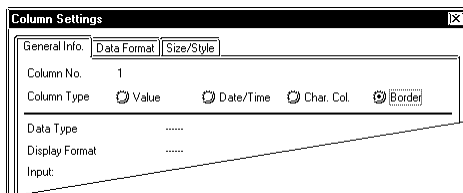

Border
Prints out the borders.

* This function is supported only by the GP77R, GP377 and GP2000 series units.

2) Row Settings (Print)

■ Attribute Settings

To set up row attributes, select Border, String (Char. Col.), or Data(Value), and click on the Settings button.

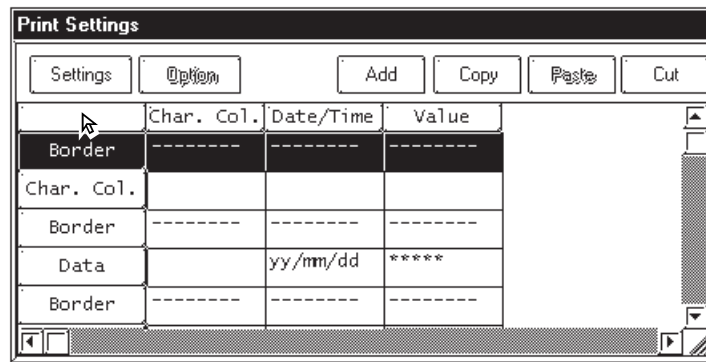

◆ General Info.

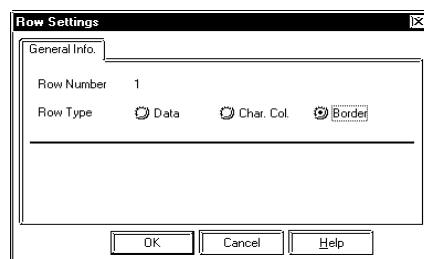

The General Info. page provides information about the current settings for Row Settings.

Row Type

Select the desired print item from Data, Char. Col., and Border.



- With the real-time printing, if the Loop is not used, the header is also printed when the first item of logging data is printed. When the last item of logging data is printed, the footer and total value(s) are printed.
- With both real-time and block printing, when the Loop is not used, after the last item of logging data is printed, page feed is performed.
- The maximum number of columns is 60 and the maximum number of rows is 4200. However, since the setting data file capacity is approximately 58KB (maximum), the number of rows will depend on the No. of Char. Col. to be designated for the number of borders and cells.

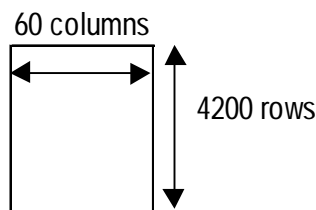

* This function is supported only by the GP77R, GP377 and GP2000 series units.



- If the Windows system's font setting is either Korean (Hangul), Taiwanese or Chinese, image data is printed out.
- Regardless of the printer's color settings, all data is printed in black and white.
- Alarm printing and screen hard copy commands are accepted even during real-time printing. Therefore, during real-time printing, **DO NOT** enter other printing commands.
- While multiple lines of data are being printed, if logging data is cleared, data printing is interrupted. Also, if the GP's power is turned OFF during printing, the remaining data will not be printed out even if the GP's power is turned ON again.
- The printing format consists of the three areas, i.e. header, main data, and footer. Up to 160 characters can be printed per line.

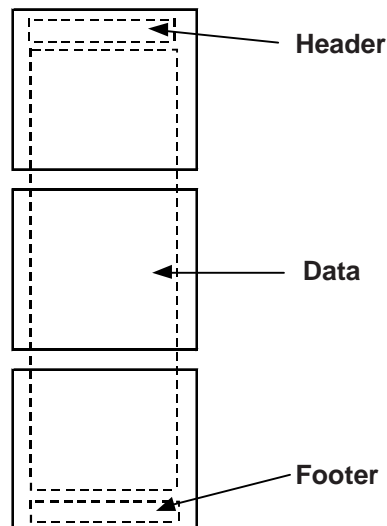

* This function is supported only by the GP77R, GP377 and GP2000 series units.



The following is an example of logging data printout. (The Loop is not used.)

	Appr.	Check	Create	
TIME	VOLTAGE	TEMP 1	TEMP 2	PRESSURE
09:00	3228	30.3	25.3	6.1
10:00	3236	26.4	26.4	6.4
11:00	3244	28.6	27.6	6.2
12:00	3202	30.7	28.7	6.5
13:00	3210	26.9	29.9	6.3
14:00	3219	29.2	24.0	6.0
15:00	3227	31.1	25.1	6.3
16:00	3235	27.3	26.3	6.1
17:00	3243	29.4	27.4	6.4
TOTAL	29044	259.7	240.7	56.3
AVERAGE	3227	28.9	26.7	6.3
MAX.	3244	31.1	29.9	6.5
MIN.	3202	26.4	24.0	6.0

* This function is supported only by the GP77R, GP377 and GP2000 series units.

When using the Loop, regardless of the logging frequency, the data display row will be designated as a single row. Also, Char. Col., Border and Total sections cannot be set.

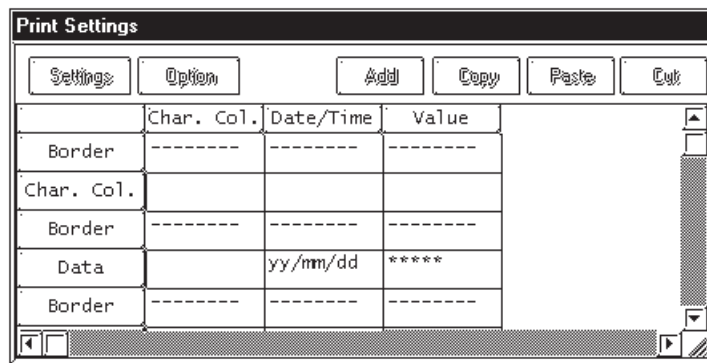

<Real Time Printing - using Loop>

10:00	XXXX	XX.X	XX.X	X.X
11:00	XXXX	XX.X	XX.X	X.X
12:00	XXXX	XX.X	XX.X	X.X
13:00	XXXX	XX.X	XX.X	X.X
14:00	XXXX	XX.X	XX.X	X.X
15:00	XXXX	XX.X	XX.X	X.X
16:00	XXXX	XX.X	XX.X	X.X
17:00	XXXX	XX.X	XX.X	X.X
10:00	XXXX	XX.X	XX.X	X.X
11:00	XXXX	XX.X	XX.X	X.X
12:00	XXXX	XX.X	XX.X	X.X
13:00	XXXX	XX.X	XX.X	X.X

Prints the data display rows only when data logging is performed. The header, footer and other items will not be printed.



With real time printing, when using the Loop, the data display row will be designated as a single row.



- When using the Loop, only real time printing can be used.
- When using the Loop and performing real time printing, the Total section will not be printed.
- When using Loop and performing real time printing, if the logging frequency is not very high or a printer has not yet been connected, printing cannot be performed at the speed the logging data is created, thereby causing a difference between the two. In this case, only part of a single cycle's logging data will not be printed.

* This function is supported only by the GP77R, GP377 and GP2000 series units.

■ **Print Settings Maximum File Size**

The print settings' file size capacity is limited. Therefore, depending on the specific setting, the user's file size may exceed this capacity. (The setting file contains the print header, print footer and print data areas' settings.) The maximum number of characters that can be entered per row is 160. The following is the standard print setting size.

- Enter the Block Name in the 1st column and then up to 8 single-byte characters in each column.
- Enter the Block Name in the 2nd row and then up to 8 single-byte characters in each row.
- Four rows are available for totals (Total, Average, Max., Min.)

		No. of value columns						
		Char. Col.	Date	Time	Value	Value	~	Value
No. of data display rows	Border	-----	-----	-----	-----	-----		-----
	Char. Col.		ABCDEFGH	ABCDEFGH	ABCDEFGH	ABCDEFGH		ABCDEFGH
	Border	-----	-----	-----	-----	-----		-----
	Data display	ABCDEFGH						
	Data display	ABCDEFGH						
	Data display	ABCDEFGH						
	⋮							
	Data display	ABCDEFGH						
	Border	-----	-----	-----	-----	-----		-----
	Total (Total)	ABCDEFGH						
	Total (Average)	ABCDEFGH						
	Total (Max.)	ABCDEFGH						
	Total (Min.)	ABCDEFGH						
	Border	-----	-----	-----	-----	-----		-----

When using the pattern shown above, the maximum number of value columns and data display rows are as follows:

No. of Value Columns	No. of Data Display Rows	Remarks
17	282	The maximum number of characters that can be entered per row is 160. Therefore, when 8 characters are entered for each column, the number of value columns available will be 17.
16	295	When the No. of value columns (number of logging words) is the maximum (16 columns).
8	482	When the No. of value columns (number of logging words) is the maximum (8 columns).
4	683	When the No. of value columns (number of logging words) is the maximum (4 columns).



When designating the columns as the block name display and entering characters in each column, the file size will become extremely large. Depending on the number of characters entered and other items designated, several hundreds rows can be used for the pattern shown above.

* This function is supported only by the GP77R, GP377 and GP2000 series units.

4.3.6 Excel Display of Logging Data

The following example displays CSV file logging data on Excel. For information about saving CSV file data to a CF card, refer to

Reference 4.7 Using the CF Card

Trigger Settings

- Number of logging words: 4
- Start time: 9:00
- Logging interval: 1 hour
- Logging frequency: 8 times
- Number of data blocks: 2
- Loop: not available

Display Settings

Although logging frequency is designated as 8 times in the Trigger Settings, here, designate it as 4 times to display data for 4 logging operations. (For normal operation, designate it as 8 times.)

Item Name	Value	Time&Date	Value	Value	Value	
	Data 3	Time	Data 0	Data 1	Data 2	
Data Display	No.1	****	hh:mm	*** *	***	** ***
Data Display	No.2	****	hh:mm	*** *	***	** ***
Data Display	No.3	****	hh:mm	*** *	***	** ***
Data Display	No.4	****	hh:mm	*** *	***	** ***
Calculation	Total	*****		***** *	*****	***** ***

Excel Data Display

When a CSV file stored in a CF card is opened in Excel using the above settings, the data is displayed as shown below. When storing the backup SRAM's logging data to the CF card, perform the operation described in "CF Card Data Storage Settings"/"Control Word Address".

Reference 4.7.4 External Storage of GP-PRO/PB III data

Date and time data is always displayed.
Display format is "yy/mm/dd" and "hh:mm:ss"

Values are displayed from the left-most column as designated via the Display Settings.

	Date	Time	Data 3	Data 0	Data 1	Data 2
No.1	1998/6/17	9:00:00	1234	123.4	123	12.345
No.2	1998/6/17	10:00:00	****	*** *	***	** ***
No.3	1998/6/17	11:00:00	2345	234.5	234	23.456
No.4	1998/6/17	12:00:00	-1234	-123.4	-123	-12.345
	1998/6/17	13:00:00	1111	111.1	111	1.111
	1998/6/17	14:00:00	2222	222.2	222	2.222
	1998/6/17	15:00:00	3333	333.3	333	3.333
	1998/6/17	16:00:00	4444	444.4	444	4.444
No.1	1998/6/18	9:00:00	3456	345.6	345	3.456
No.2	1998/6/18	10:00:00	3450	345	345	3.45

Data is displayed according to the number of trigger settings.

No data is displayed in the calculation area. Also, one blank row is inserted for spacing.

On GP, years are displayed in two digits. On Excel, they are displayed using 4 digits.

On GP, time is displayed as "9:00:00". On Excel, the first "0" is omitted.

GP values such as "345.0" and "3.450", will appear on Excel with the "0" after the decimal point omitted.

* This function is supported only by the GP77R, GP377 and GP2000 series units.



- **“Date” and “Time” in the first row is always displayed. Only the numerical strings are displayed in the following columns.**
- **Only the rows which have the item name and the data display are displayed.**

■ **CSV File**

◆ **When opening the logging data’s CSV file in Excel:**

• **CSV File Data Format**

```

"", "Date", "Time", "Item Name A", "Item Name B", "Item Name C", "Item Name D"
"Item Name 1", "98/06/17", "09:00:00", "123.4", "123", "12.345", "1234"
"Item Name 2", "98/06/17", "12:00:00", "***.*", "***", "**.*", "*****"
"Item Name 3", "98/06/17", "15:00:00", "234.5", "234", "23.456", "2345"
"Item Name 4", "98/06/17", "18:00:00", "-123.4", "-123", "-12.345", "-1234"
",", ",", ",", ",", ",", ",", ""
"Item Name 1", "98/06/18", "09:00:00", "345.6", "345", "3.456", "3456"
    
```

• **After opening by Excel**

	Date	Time	Item Name A	Item Name B	Item Name C	Item Name D
Item Name 1	1998/6/17	9:00:00	123.4	123	12.345	1234
Item Name 2	1998/6/17	12:00:00	***.*	***	**.*	*****
Item Name 3	1998/6/17	15:00:00	234.5	234	23.456	2345
Item Name 4	1998/6/17	18:00:00	-123.4	-123	-12.345	-1234
Item Name 1	1998/6/18	9:00:00	345.6	345	3.456	3456



Values are displayed as designated via the "Display Settings". Values are output starting from the specified leftmost column, instead of starting from the Address Offset No.



- Note:**
- Values are displayed according to the Display Settings. Therefore, they are not displayed from the Address Offset Number, but from the designated foremost column.
 - When a PLC data read error occurs, “*****” is displayed instead of an actual data value.
 - No data is displayed in the data calculation area.
 - Date and time data is always displayed in the “yy/mm/dd” and “hh:mm:ss” format.
 - Item Names designated via the Display Settings are displayed.
 - When Item Names are not designated for rows or columns, no Item Name is displayed. However, even in such a case, date and time data is displayed.

Date	Time			
1998/6/17	9:00:00	123.4	123	12.345
1998/6/17	12:00:00	***.*	***	**.*

* This function is supported only by the GP77R, GP377 and GP2000 series units.



- When multiple Item Names are entered in multiple lines in one cell, a space (20H) is inserted between each name.
e.g.) 1st line: "Interior", 2nd line: "Temperature" for "Interior Temperature"
- One blank row is inserted between blocks.
- Only logging data is displayed.

◆ When writing logging data to the CF card in auto save mode using the Loop:

(e.g.) When loop frequency is designated as 4 and the Loop is performed twice:

- CSV file

"Date"	"Time"	"Voltage"	"Temperature1 "	"Temperature 2"	"Pressure"
"98/06/17"	"09:00:00"	"3228"	"30.3"	"25.3"	"6.2"
"98/06/17"	"12:00:00"	"3236"	"26.4"	"26.4"	"6.4"
"98/06/17"	"15:00:00"	"3244"	"28.6"	"27.6"	"6.2"
"98/06/17"	"18:00:00"	"3202"	"30.7"	"28.7"	"6.5"
"98/06/18"	"09:00:00"	"3210"	"26.9"	"29.9"	"6.3"
"98/06/18"	"12:00:00"	"3219"	"29.2"	"24.0"	"6.0"
"98/06/18"	"15:00:00"	"3227"	"31.1"	"25.1"	"6.3"
"98/06/18"	"18:00:00"	"3235"	"27.3"	"26.3"	"6.2"

} 1st Loop cycle's data
} 2nd Loop cycle's data

When opened on Excel:

Date	Time	Voltage	Temperature1	Temperature2	Pressure
1998/6/17	9:00:00	3228	30.3	25.3	6.1
1998/6/17	12:00:00	3236	26.4	26.4	6.4
1998/6/17	15:00:00	3244	26.6	27.6	6.2
1998/6/17	18:00:00	3202	30.7	28.7	6.5
1998/6/18	9:00:00	3210	26.9	29.9	6.3
1998/6/18	12:00:00	3219	29.2	24.0	6.0
1998/6/18	15:00:00	3227	31.1	25.1	6.3
1998/6/18	18:00:00	3235	27.3	26.3	6.1



- When writing logging data to a CF card in auto save mode using the Loop, file data will be added to the previous data.
- A file will be added and then opened. If a file with the same name already exists, data is added to that file.
- If a CSV file is too large, it may not be able to be opened by Excel or other applications. For more detailed information, refer to the respective application's manual.

* This function is supported only by the GP77R, GP377 and GP2000 series units.

4.3.7 Data Logging Display Usage Example

Use the Logging Display to display the logging data on the screen. The Logging Display can be used for modifying the logging data with a numeric keypad as well as for display purposes.



Note: When using Loop, the Data Logging Display's Data Calculation Scroll will be designated as None. Therefore, to display the Total data, Total sections will always be displayed on the screen, regardless of the scroll display.

Reference *Operation Manual, 2.1.17 Data Logging Display*

■ Displaying Logging Data

Perform detailed settings such as Trigger Settings according to each application. Here, display-related explanations only are given.

1. Logging Settings/Display

Select the Project Manager's [Project]/[Logging Setting].

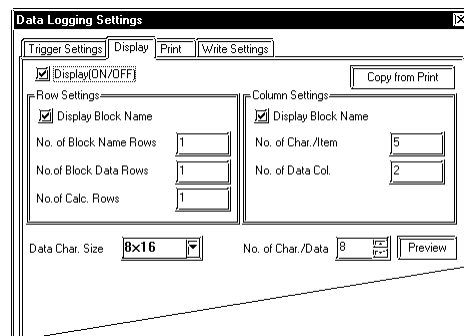

2. Display Settings

Enter Item Name and other required data in the Display Setting dialog box. The format designated in this dialog box is used commonly for all blocks.

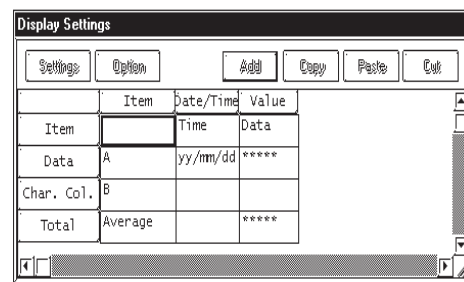

Note: This example does not use the Loop. When using this feature, only one data display row will be used.

* This function is supported only by the GP77R, GP377 and GP2000 series units.

3. Setting the Logging Display

Select the Screen Editor's [Parts]/[Logging Display]. Enter the Row, Column, and Spacing values. The Display Settings designated above are used for the Logging Display.

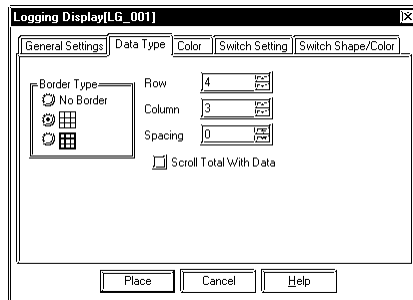

Note: This example does not use the Loop. When using this feature, the Data Logging Display's Data Calculation Scroll will be designated as None. Therefore, to display the Total data, Total sections will always be displayed on the screen, regardless of the scroll display.

Reference Operation Manual, 2.1.17 Data Logging Display

4. Placing the Logging Display

The placed Logging Display on a screen has been grouped. To change its layout, ungroup it first.

ABCD	ABCD	ABCD	BP
ABCD	ABCD	ABCD	
ABCD	ABCD	ABCD	DN
ABCD	ABCD	ABCD	
			R
			L

5. Connect the GP to the PLC and start operation.

After the Logging Display's layout change is completed, send that data to the GP and start operation. The following is an example of an image to be displayed after the Block No. is stored in the Block No. Designated Addr., that is designated via the Logging Display.

	TIME	DATA	BP
A	8:00	156	DN
B	9:00	195	
AVERAGE		175.5	
			L
			R

* This function is supported only by the GP77R, GP377 and GP2000 series units.

■ Display and Edit of Logging Data

1. Set up [Parts]/[Data Logging Display].

Use the same steps up to step 3 above. Here, click on the Data Edit check box. When the interlock function is required to edit data, also check the Interlock check box.

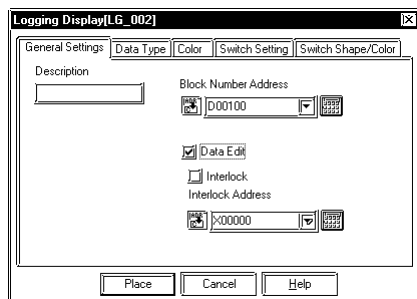

Note: This example does not use the Loop. When using this feature, only one block will be used and the block number designation address setting will be disabled.

Reference *Operation Manual, 2.1.17 “Data Logging Display”*

2. Place the Data Logging Display on your screen.

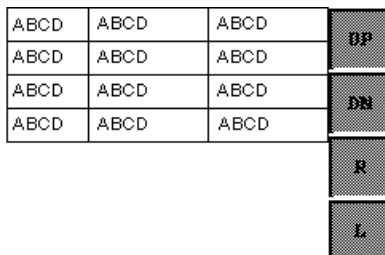

3. Select “Op4-lib4. cpw” from the Library Parts and select a keypad for data logging.

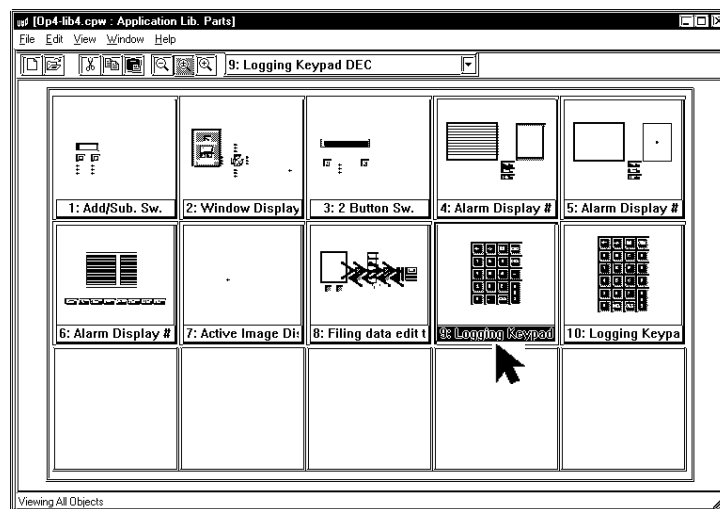

* This function is supported only by the GP77R, GP377 and GP2000 series units.

4. Place the keypad

Since this part has been grouped, to change its layout, ungroup it first.

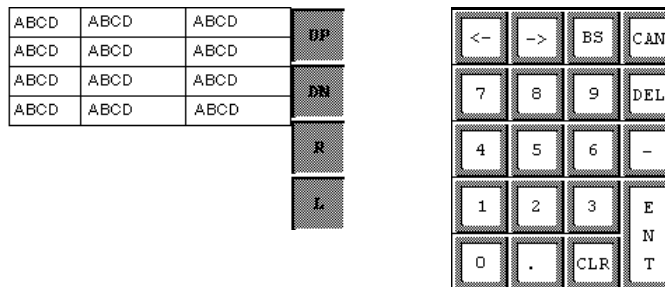

5. Change the layout and send the data to the GP.

After the layout change is completed, send the data to the GP and start operation. The logging data is displayed as shown below.

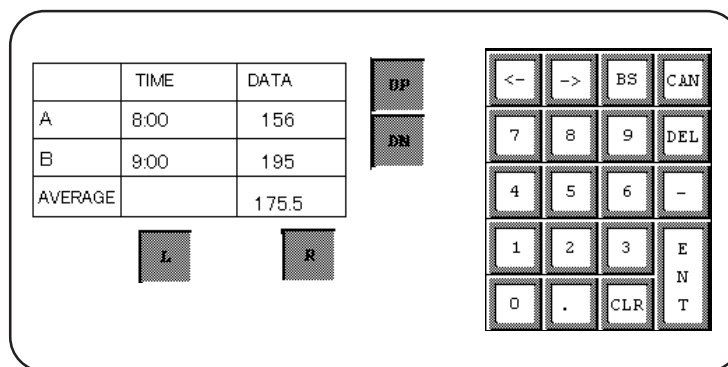

■ Operation During Machine Run

◆ Data Edit

1. Touch the data on the screen to edit it.

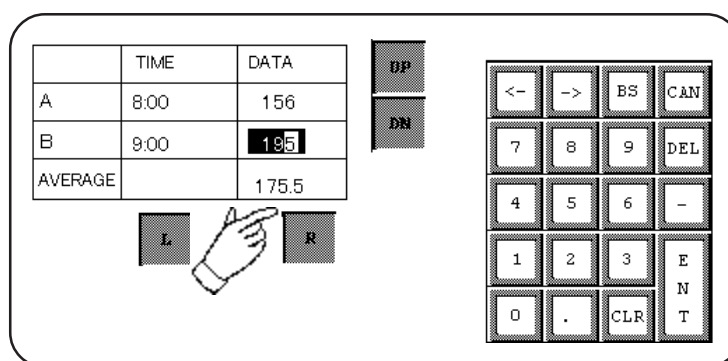

- Data entry procedures are the same as for a K-tag.
- Pressing the [CAN] (cancel) or [ENT] (enter) key takes you out of data entry mode.
- Even if another data area is touched while the current data is being edited, entry location does not shift. To move to another data area, first press the [CAN] key.

* This function is supported only by the GP77R, GP377 and GP2000 series units.

2. Use the keypad to edit the data and press the [ENT] key to store the edited data in the GP's internal SRAM.

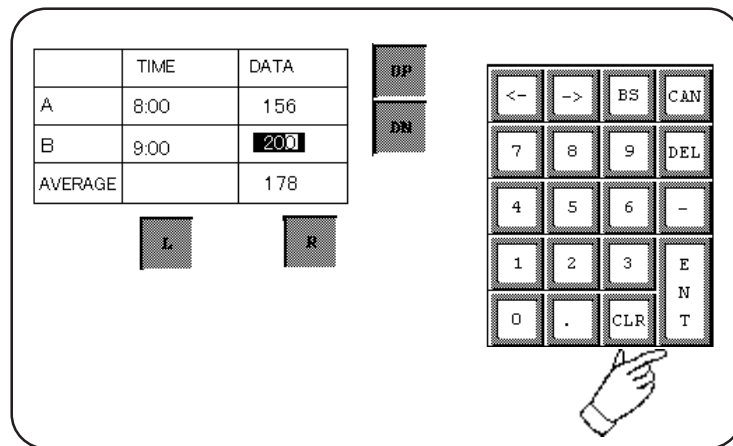

Note: Data can be edited in the cells in A and B rows, Time and Data columns. Block Names and Average values cannot be edited. However, “***”, which is displayed as a result of data read errors, can be edited. Areas whose logging data has not been acquired cannot be edited.

◆ Scroll

Use “UP”, “DN”, “L” and “R” keys to scroll the display areas. The gray colored areas in the figure below represent that they are not currently displayed. Use the scroll keys to move to those data cells.

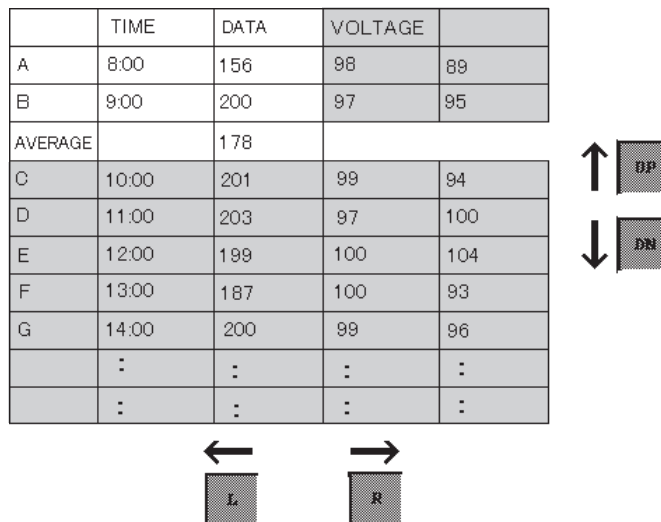

1. Touch the “DN” key.

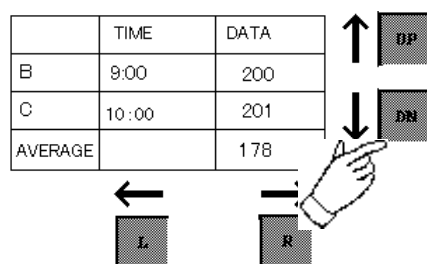

* This function is supported only by the GP2000 series units.

2. Touch the “R” key.

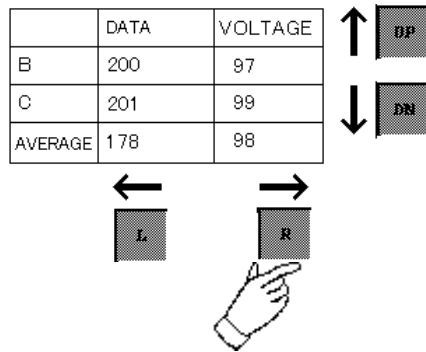

* This function is supported only by the GP2000 series units.

4.3.8 Economy Mode

In economy mode, a maximum of 255 logging words can be specified. (Special mode has a limit of 32 logging words.)

To simplify the settings, only [Loop] is available in Economy mode. Only GP2000 series unit supports this function.

■ Trigger Settings

The trigger settings in Economy mode are as follows.

• When specifying bit

Trigger setting item	Fixed to Loop
Logging start address	○
Number of logging words	1 to 255 words
Number of times	1 to 2048
Number of blocks	Fixed to 1
PLC trigger bit address	○
GP_PACK bit address	○
File bit address	○
Data clear bit address	○

○: can be set.

• When specifying time

Trigger setting item	Fixed to Loop
Logging start address	○
Number of logging words	1 to 255 words
Start time	hour minute
End time	-
Time interval	hour minute second
Number of times	1 to 2048
Number of blocks	1 to 2048
Logging enable bit address	○
Block end bit address	-
File full bit address	○
Data clear bit address	○

○: can be set.

- : cannot be set.

* This function is supported only by the GP2000 series units.

■ Display Settings

The display format is simplified in Economy mode as follows.

	Date/Time	Date/Time	Value	Value	Value	Value	Value
Item							
Data	yy/mm/dd	hh:mm	*****	*****	*****	*****	*****
Total			*****	*****	*****	*****	*****

- A row can be set only for Item Name, Data Display and Summary. Each item has only one row. The rows for Item Name and Summary can be made invalid.
- A column can be set only for Date and Numerical Value. Up to two columns (for date and time) can be set for Date.

■ Printout Settings

The format for printout settings is simplified in Economy mode as follows.

	Date/Time	Date/Time	Value	Value	Value
Data	yy/mm/dd	hh:mm	*****	*****	*****

- Only one row can be set for Data Display only. The total rows for the string and the border cannot be set.
- A column can be set for Date and Numerical Value only. Up to two columns (for date and time) can be set for Date.

* This function is supported only by the GP2000 series units.



The maximum number of characters printable per row is 160 characters, as usual.

■ **Write Settings**

No write settings (the function enabling writing to LS) are available in economy mode.

■ **Saving Data to a CF Card as a CSV File**

The settings are the same as those of Yes Loop in the conventional compatible mode.

■ **Backup SRAM capacity**

• **Fixed to With Loop**

Backup SRAM capacity (byte) =
 $20 + \{(12 + \text{extended data} + 2 \times \text{number of words of logging data}) \times \text{number of times}\} \times \text{number of blocks} + (12 + \text{extended data} + 2 \times \text{number of words of logging data})$

Extended data increases each 16 words by 2 bytes when the logging data exceeds 32 words.

Number of Logging Words	Extended Data
1 to 32 words	0 bytes
33 to 48 words	2 bytes
49 to 64 words	4 bytes
:	:
225 to 240 words	26 bytes
241 to 255 words	28 bytes

* This function is supported only by the GP2000 series units.

■ Usage Restrictions

More than 33 words can be set in Economy mode under the following limited conditions, including the upper limit of the setting file.

- 1 When changing from compatible mode to economy mode in GP-PRO/PBIII for Windows, the previous logging settings will be initialized.
- 2 In the logging settings, Loop is performed. Therefore, the number of blocks is fixed at 1.
- 3 The number of logging words that can be set is between 1 and 255.
- 4 The display format is limited.
- 5 The format of the printout settings is limited. On printing out, the maximum number of words per row is 160 characters, as usual.
- 6 Writing to the LS area is not enabled.
- 7 When the number of logging words is 255, the maximum number of loggings is 472 (when SRAM capacity is 256KB).

**Note:**

- **The greater the number of logging words, the longer the data readout time (communication time) from the PLC.**
- **While the logging data are being read out, the tag display may not be updated or may be extremely delayed. Transition or Q-tag alarm processing may also be slow.**

* This function is supported only by the GP2000 series units.

4.4 CSV Data Transfer Function

4.4.1 Overview

The CSV data transfer function is used to transfer data between a CF card and the PLC. The data is transferred in CSV file format (CSV data). Therefore, general-purpose spreadsheet applications can be used to compile and edit the data.

This function uses the filing function to copy the CSV data stored on a CF card and write it directly to the PLC. When this function is used as a logging function to load data from the PLC, the data can be loaded and saved directly onto a CF card in CSV file format.

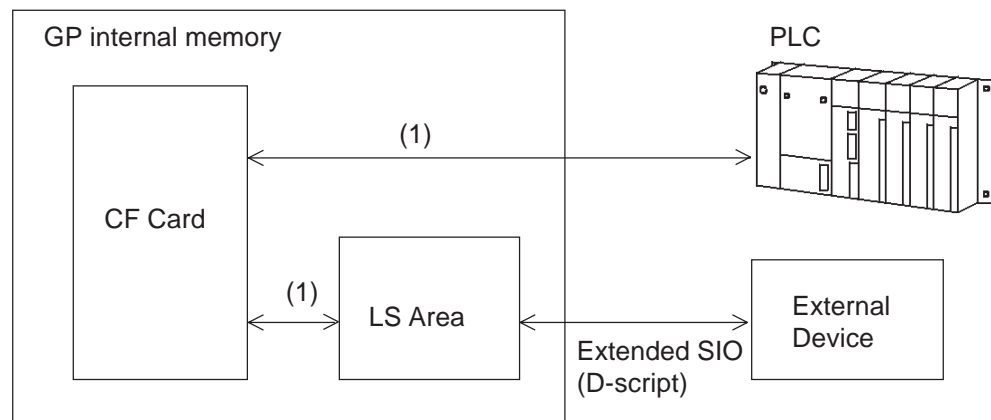

(1) Transfer between a CF card and the PLC or LS area transfer

* This function is supported only by the GP2000 series units.

■ Data Flow in the Filing Application

The data stored on a CF card in CSV file format is transferred directly to the PLC. (The data is written to the device.)

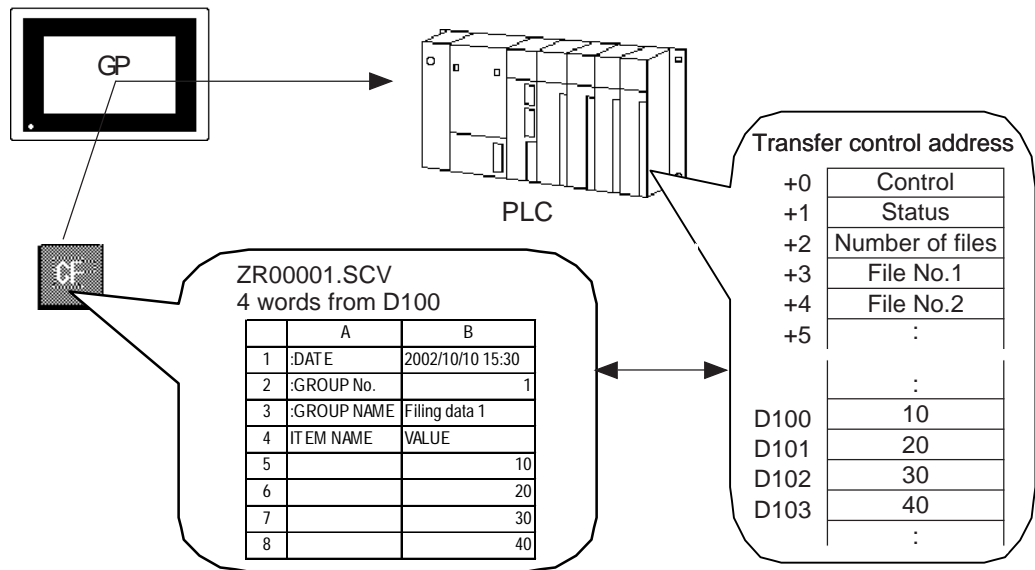

■ Data Flow in the Logging Application

The device data of the PLC is transferred directly to the CF card in CSV file format. (The data is read from the device.)

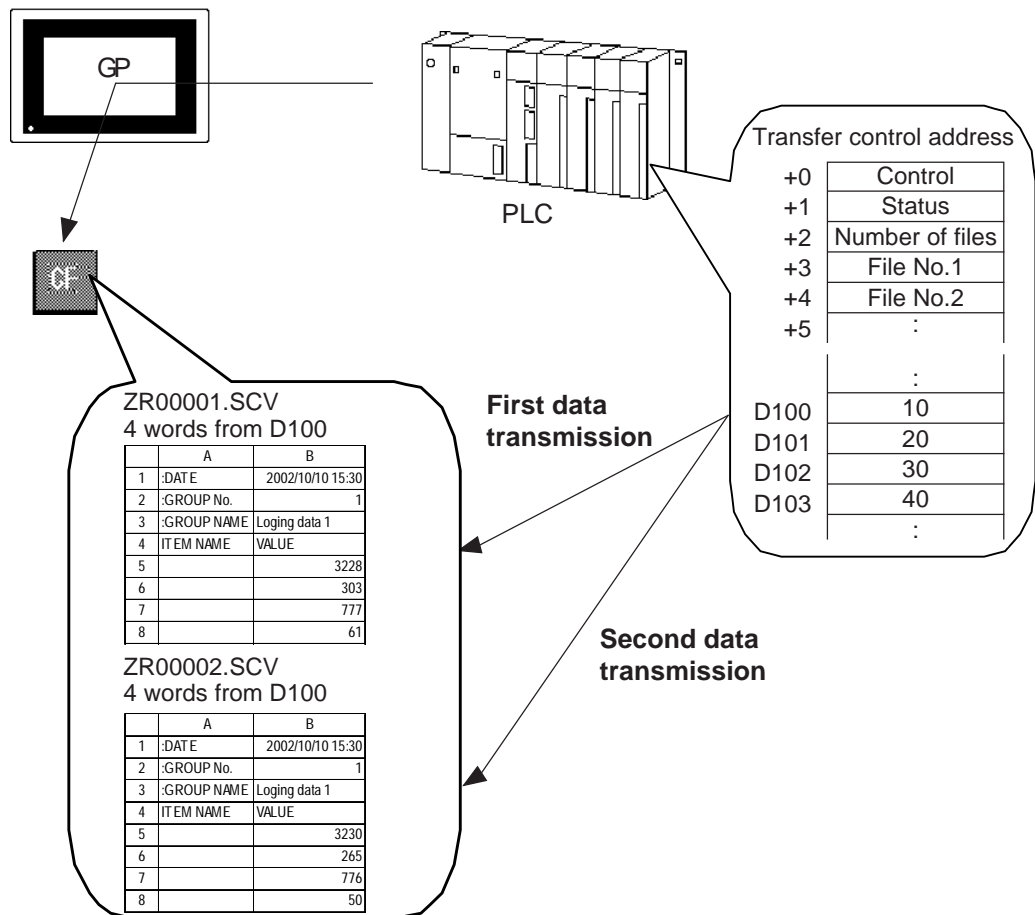

* This function is supported only by the GP2000 series units.

4.4.2 Details

- Data for one recipe is saved as one file in CSV format on a CF card. For the GP2000 series, the Multi Unit (sold separately) is unnecessary.
- The following two CSV data transfer methods are available: Automatic transfer, in which the transfer is started by a trigger signal input from the PLC; and manual transfer, in which transfer is started by a trigger signal input into the Data Transfer Display placed on the GP.

Automatic transfer

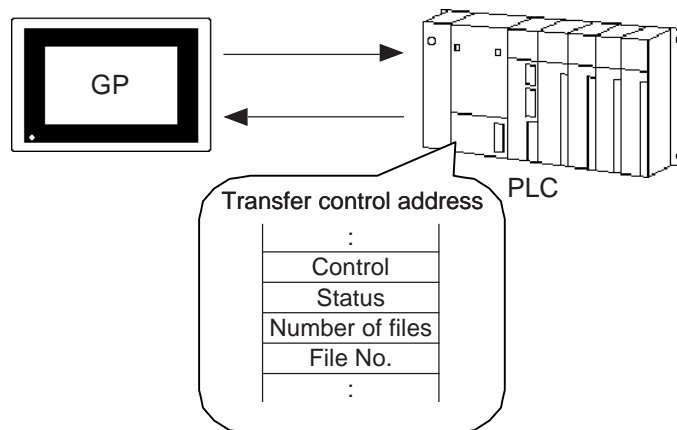

Manual transfer

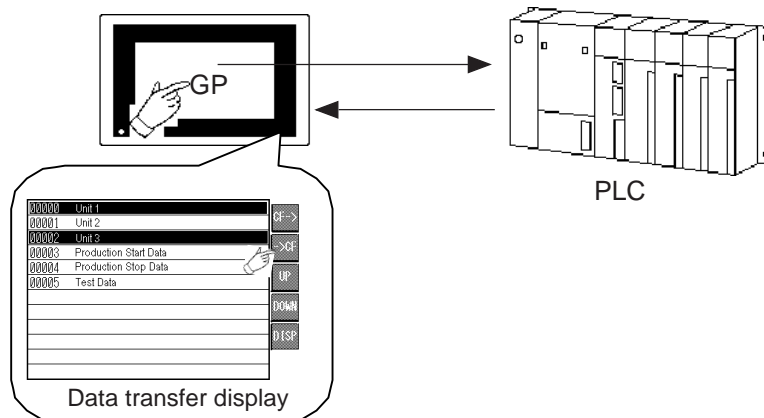

* This function is supported only by the GP2000 series units.

- Automatic transfer can entail two types of operations: conditional operation and address operation.

To select conditional operation, first specify the destination address for the data transfer in the Condition Setting dialog box. To change the destination address for each data transfer, use the address operation.

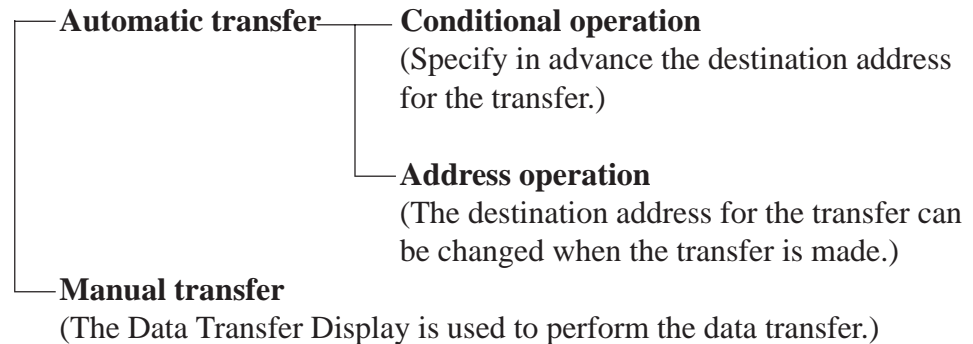

- Make sure to save the CSV data in the FILE folder on the CF card.
- When a PLC-to-CF data transfer is executed with many files stored in the FILE folder, it may take a few seconds to a few tens of seconds for the data to be written to the CF card.
- While data is being loaded to the CF card, the processing speed of switching tags or screens will be slower than normal.

* This function is supported only by the GP2000 series units.

4.4.3 List of Condition Settings

Use this dialog box to configure the data transfer conditions.

■ Setting the control address for the transfer

In the Project Manager's [Screen/Setup], select [Data Transfer Function/Condition Setting]. When selecting automatic transfer, specify the control address. This setting is not required for manual transfer.

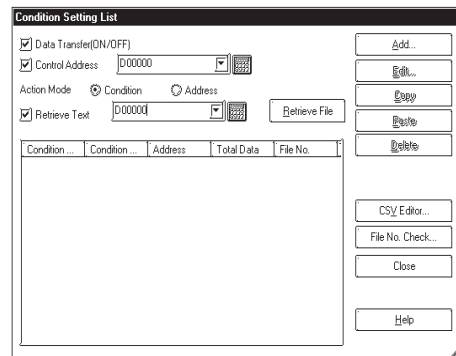

Data transfer (ON/OFF)

Specify whether the data transfer function is to be used.

Control Address

Specify the address that controls the data transfer. This setting is not required for a manual transfer. However, when the operation mode is set to "Address" the control address should be specified and used for the transfer.

Reference "4.4.6 Automatic Transfer Operation on the GP."

Action mode

(Condition)

Configure the transfer conditions in the Condition Setting. The transfer is executed according to the specified transfer conditions.

(Address)

The transfer condition is not used for the operation. The data is transferred indirectly by specifying the device code and address code to the area following the control address. (The setting procedure is the same as that used to specify the indirect device type and address for the E-tag and K-tag.)

Retrieve Text

Enables specifying the address of the string to be searched.

Retrieve File

A search acceleration file (ZRINDEX.CSV) will be generated from the ZR file in the CF card output folder. This file is not automatically updated when CSV files are added or changed.

Add

Use this button to switch to the Condition Setting dialog box in which new transfer conditions can be set up.

* This function is supported only by the GP2000 series units.

Edit

Use this button to switch to the Condition Setting dialog box in which the transfer conditions can be edited.

Copy

Use this button to copy the transfer conditions.

Paste

Use this button to paste the transfer conditions that have been copied.

Delete

Use this button to delete the selected transfer condition.

CSV Editor

Use this button to switch to the CSV List dialog box in which the transfer data can be added or edited.

File No. Check

Use this button to switch to the Check File No. dialog box. Ensure that the file number settings for the transfer condition have not been duplicated.

* This function is supported only by the GP2000 series units.

4.4.4 Condition Setting

Specify the destination word address and quantity of data for each group.

Condition Name (GROUP NAME)*

Specify the group name (an arbitrary name). Up to 32 (single-byte) characters can be used for the group name.

Condition No. (GROUP NO.)

Specify the group number within the range of 0 to 1023.

Assign each group its own unique group number.

Transfer Address

Specify the start address and the quantity of data (1 to 10000) of the destination (source).

The specified address will function as the destination address when the function is used as the Filing Application, and as the source address when the function is used as the Logging Function.

Data Type

Select 16 bits or 32 bits for the data format, and specify whether to use the +/- Code.

File Number

Specify the File No. to be transferred. Set up all file numbers with the same conditions shown here.

Example: When ZR00000.CSV in the table below is selected, the data is transferred to D0100 to D0199. "ZR*****.CSV" is the name of the file in which the data is saved with the CSV data transfer function. For detailed rules regarding file names, [Reference](#) "4.6.4 File Manager Display Function."

Group No.	0	1	2
Destination Address	D0100 to D0199	D0200 to D0299	D0300 to D0399
Quantity of Data	100	10	50
Data Format	No Code 16 bits	No Code 32 bits	With Code 16 bits
File No.	ZR00000 to ZR00009	ZR00010 to ZR00019	ZR00020 to ZR00029

* When data is transferred from a PLC to a CF card, the Group Name will be stored under "Group Name" in the CSV data.

* This function is supported only by the GP2000 series units.



Note: A simplified setting procedure can be used to assign one file name to one group.

Example: Group No.: 0 1 2
 Start No.: 0 1 2
 End No.: 0 1 2

- When two or more files with the same conditions (destination address and quantity of data) exist, specify the block of file with the File No.

Example: Group No.: 0
 Start No.: 0
 End No.: 10

Extended Settings

Configure the parameters on this tab only when logging the data while transferring the data from the PLC to a CF card (reading out the device from the PLC). (The settings can be used for the logging function.)

This function automatically assigns file numbers to the data when the data loaded from the PLC is stored in CSV format. There is no need to set up this parameter when manual transfer mode is used.

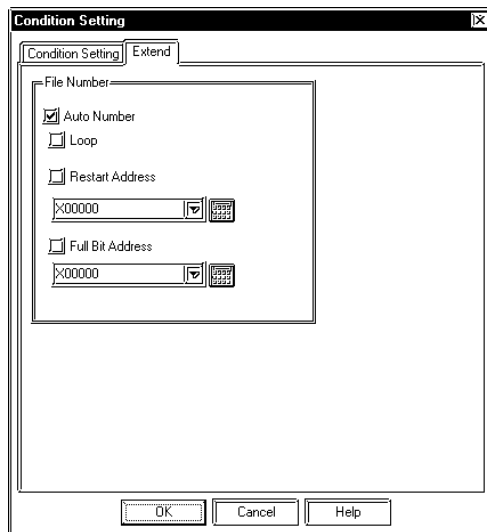

Auto Number

Specify whether you have enabled automatic numbering mode, under which the file number increments automatically, or direct designation of the file number.

When automatic numbering is disabled:

When the automatic numbering function is disabled, you must designate the File No. in the transfer control address.

When automatic numbering is enabled:

When the automatic numbering function is enabled, the file numbers are assigned automatically within the range from the Start No. to the End No. that is specified in the Condition Setting. The file numbers are assigned as follows: When a new file is created and no other file exists, the file is numbered as the Start File No.; when a new file is created and one or more files exist, it is numbered as the "most recent File No. +1"

When the automatic numbering function is used, the created file numbers are written in the File No. area of the transfer control address.

* This function is supported only by the GP2000 series units.

Loop

Specify whether to enable or disable loop operation when the automatic numbering function is enabled.

When loop operation is enabled: When the File No. reaches the final number within the specified range, the oldest file is deleted when the new file is created.

When loop operation is disabled: Numbering stops when the File No. reaches the final number within the specified range.

Restart Address

When loop operation is disabled, turning ON the Restart Address after the full bit address is turned ON will create (overwrite) files starting from the File No. of the "Start No." specified on the Condition Settings tab.

Full Bit Address

This bit address turns ON when the File No. reaches the final number.

** This function is supported only by the GP2000 series units.*

4.4.5 CSV File List

The transfer data can be created with a screen creation editor or with a general-purpose spreadsheet application (such as Microsoft Excel).

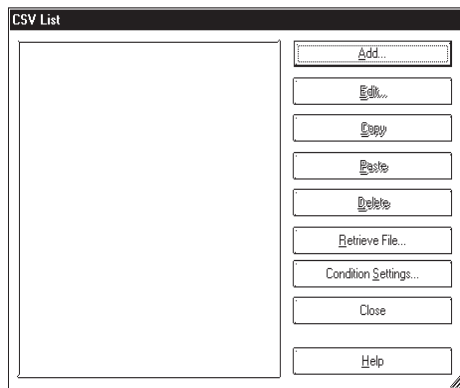

Add

Use this button to create a new CSV file.

Edit

Use this button to edit a CSV file you have created. Select the CSV file to edit and click the "Edit" button.

Copy

Use this button to copy the CSV file you have created.

Paste

Use this button to paste the CSV file you have copied.

Delete

Use this button to delete the CSV file you have selected.

Condition Settings

Use this button to switch to the List of Condition Settings dialog box.

Retrieve File

A search acceleration file (ZRINDEX.CSV) will be generated from the ZR file in the CF card output folder. This file is not automatically updated when CSV files are added or changed.

Condition No. (GROUP NO.)

Specify the Group No. you have specified in the transfer condition. The valid range is from 0 to 1023.

Condition Name (GROUP NAME)

Designate an arbitrary condition name. Up to 32 single-byte characters can be used.

Total Data

Specify the quantity of data to be transferred. The valid range is from 1 to 10000. Specify a number that agrees with the quantity of data you have specified in the transfer condition setting.

Title

You may add comments for each data. The comment cannot be accessed from the GP.

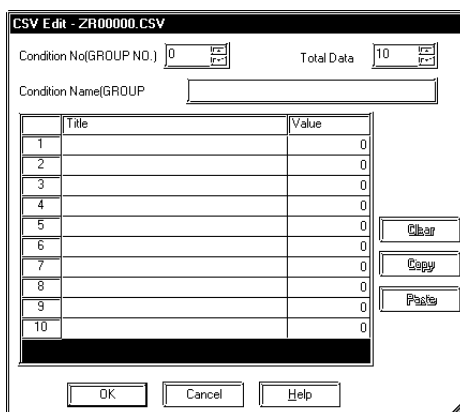

* This function is supported only by the GP2000 series units.

Value

Specify the data to be transferred.

Clear

Use this button to clear the cell currently selected.

Copy

Use this button to copy the cell currently selected.

Paste

Use this button to paste the cell you have copied.

■ Creating data with Microsoft Excel

When creating transfer data with Microsoft Excel, enter the appropriate values or text under ": DATE", ": GROUP NO.", ": GROUP NAME", ": ITEM NAME", and "VALUE." The GP unit transfers the data according to these parameters. When saving the data, save it as a CSV file.

	A	B
1	:DATE	2002/06/13 10:30:00
2	:GROUP NO.	1
3	:GROUP NAME	No.1 Mixer
4	:ITEM NAME	VALUE
5		150
6		230
7		300
8		540

Date and time

Transfer condition No.

Data portion

Group Name

: DATE

Enter the date and time on which the data is created.

When data is transferred from the PLC to the CF card, year is displayed in two digits like "02/06/13 10:30:00".

: GROUP NO.

Enter the transfer condition No.

: GROUP NAME

Enter the user-configured condition name (Group Name). When Data Transfer Display is used for manual transfer, the condition name (Group Name) is displayed on the Data Transfer Display.

Up to 32 characters can be entered for the condition name (Group Name).

Text exceeding 32 characters cannot be displayed on the Data Transfer Display.

* This function is supported only by the GP2000 series units.

ITEM NAME

The area below the Item Name field can be used for entering any desired information. You may enter comments as necessary. However, this information will be lost when data is transferred from the PLC to the CF card in overwrite mode.

VALUE

The lines below the Item Name and Value are the data portion. Data entered for the data portion must be written in decimal system. The data in this area cannot be entered as hexadecimal data.



- ***The transfer condition number and condition name (Group Name) will not be transferred to the PLC. Only the data portion below the Value field will be transferred.***
- ***The file name will be "ZR****.CSV" (a number from 0 to 65535 is designated for ****). When copying a file with a PC, copy the file onto the FILE folder on the CF card.***

* This function is supported only by the GP2000 series units.

- **Status**

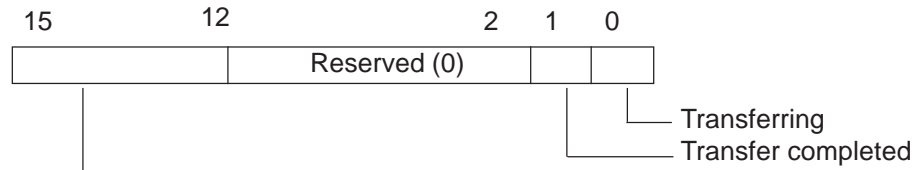

- Error status

- 0: Transfer completed successfully.
 - 1: No File No. (During transfer of data from CF card to PLC, target file to be transferred does not exist.)
 - 2: No transfer condition No. (For CF-to-PLC or PLC-to-CF transfer, the Group No. corresponding to the specified File No. does not exist.)
 - 3: LS area range error (In a CF-to-PLC data transfer in which the start address of the transfer is specified to the LS area, data transfer is attempted to an address outside the specified range of the LS area.)
 - 4: No CF card (No CF card is inserted, or the cover is open.)
 - 5: CF card read error (Read-out from the CF card failed in a CF-to-PLC data transfer.)
 - 6: CF card write error (Data writing failed in a PLC-to-CF data transfer.)
 - 7: CF card error (CF card is invalid or the media inserted is not a CF card.)
 - 8: Reserved
 - 9: No retrieve text (No CSV file matches the retrieve text.)
 - 10 : Index file error (The index file format is incorrect.)

- **Quantity of files**

Specify the number of the files to be transferred.

- **File No. 1**

Specify the first File No. to be transferred.

- **File No. n**

Specify the nth File No. to be transferred.

* This function is supported only by the GP2000 series units.

◆ Control address and status address in data transfer

When a data transfer is completed successfully, the status "Transferring" (bit 0 is ON) changes to "Transfer completed" (the 1st bit is ON). If the transfer has failed, the status "Transferring" (bit 0 is ON) changes to error status and specific error code is set as the status.

When the data transfer is completed, determine the Transmit Completed Bit via the connected device (PLC and the host) and turn OFF the trigger bit. Turning OFF the trigger bit automatically turns OFF bit 1 (transfer-completed) on the status address.

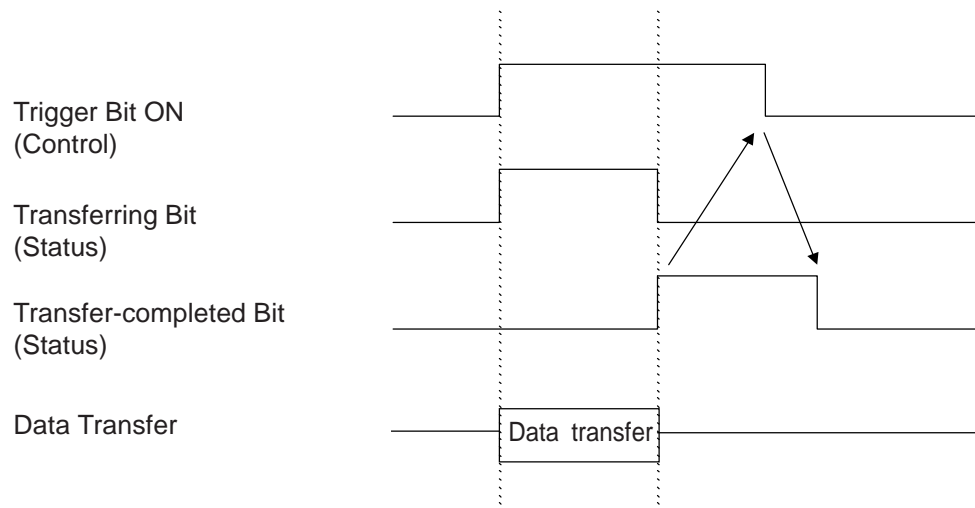

Note: When the number of words of the CSV data does not agree with the number of words specified in the Condition Setting, the transfer is executed with a smaller number of words.

- When two or more files are transferred, the files are transferred in the order of the file numbers specified in the transfer control address of +3 or higher. If an error occurs during the transfer operation, the transfer is aborted after the current transfer is completed. Subsequent files will not be transferred.
- When two or more file numbers are specified in the Condition Setting during execution of a transfer between the CF card and PLC, the transfer is performed with the condition settings of the lower number.
- When the number of files to be transferred is specified as 0, transfer will not take place even if the CF->PLC trigger bit is set to ON. Be aware that with this setting, the status will also not be updated.

* This function is supported only by the GP2000 series units.

◆ **When the automatic numbering function is enabled in the condition setting**

The file number assigned by the automatic numbering function is checked each time a file is created. A File No. is assigned to a created file according to the following rules:

- (1) The new file name is created by adding "1" to the file number with the most recent time stamp among existing files.
- (2) If no free space is left, the file with the oldest time stamp is deleted and a new file is created.

<Operation example of the automatic numbering function>

If no free space remains

The file with the lowest file number is deleted, and a new file is created with the File No. specified by adding "1" to the File No. of the most recently saved file.

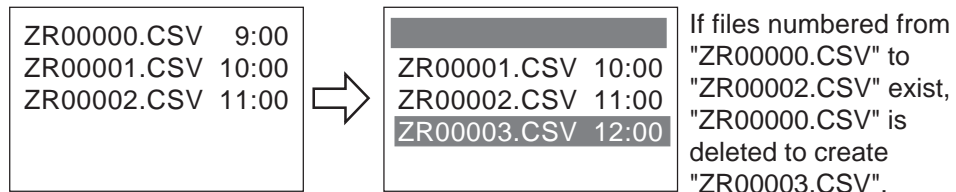

When the File No. reaches the highest number within a specified range

The new file is created by overwriting the file with the lowest File No. within the specified range.

Example: Specified range: 0 to 4

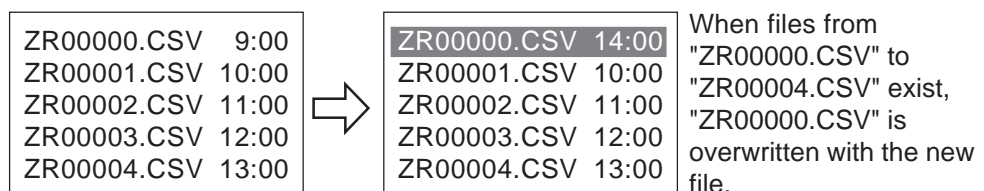

When the file numbers are not contiguous

If the file numbers of existing files are not contiguous, a new file is created by adding "1" to the most recent file number.

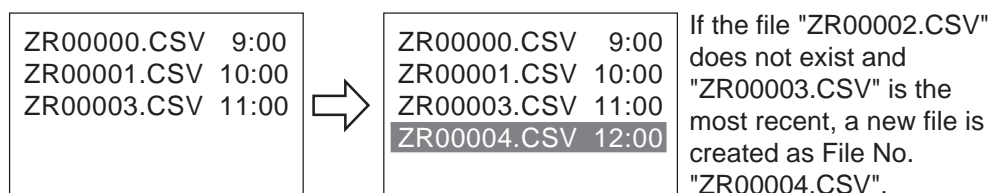

- **When the automatic numbering function is activated, do not attempt to interrupt the file number via the Data Transfer Display. Otherwise, the inserted file will be overwritten.**

* This function is supported only by the GP2000 series units.



Note: If the file numbers do not conform to time stamps in automatic numbering mode, a new file is created by increasing the most recent File No. by one. [This does not occur in normal operation; however, it may occur when files that have been created with PRO-Server (2-way) or the Data Transfer Display are overwritten.] If file names from "ZR0000.CSV" to "ZR00003.CSV" already exist, a new file is created that overwrites the file "ZR00002.CSV".

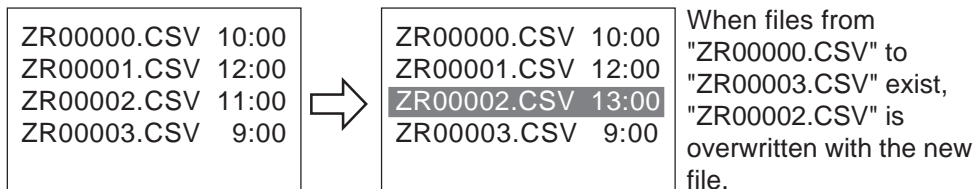

When loop operation is disabled

The full bit address turns ON when files are created in the predetermined range. To create a file that restarts from the starting file, turn ON the restart bit address. Turning ON the trigger bit address of the control address automatically turns OFF the full bit address while the restart bit address is ON. In this case, the files will be overwritten. (Data transfer will not start unless the restart bit address is set to ON.) Check that the full bit address is turned OFF before turning OFF the restart bit address.

The following illustrates the operations of the full bit address, restart bit address, and the PLC-to-CF trigger bit address of the control address.

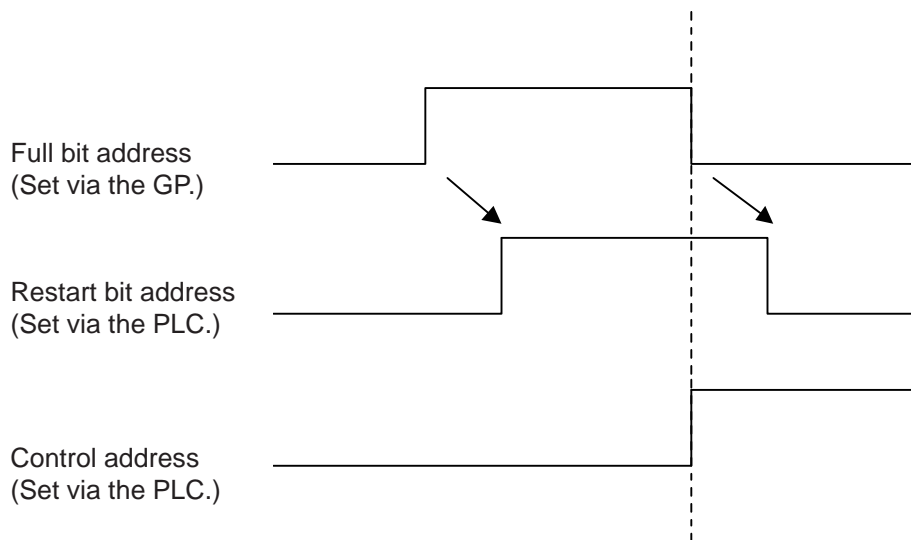

If files already exist up to the predetermined range upon the startup of the GP, turning ON the PLC-to-CF trigger bit of the control will turn ON the full bit address; therefore a PLC-to-CF data copy will not be executed. If the restart bit address is set to ON in this case, a file will again be created with the "most recent File No. +1" within the range specified.

* This function is supported only by the GP2000 series units.

◆ **Search for CSV files - transfer only files matching the condition name**

Search for CSV files with a desired condition name and transfer all matching CSV files. In the following example, the CSV files that match the product number (condition name) read from the barcode reader will be transferred to the PLC.

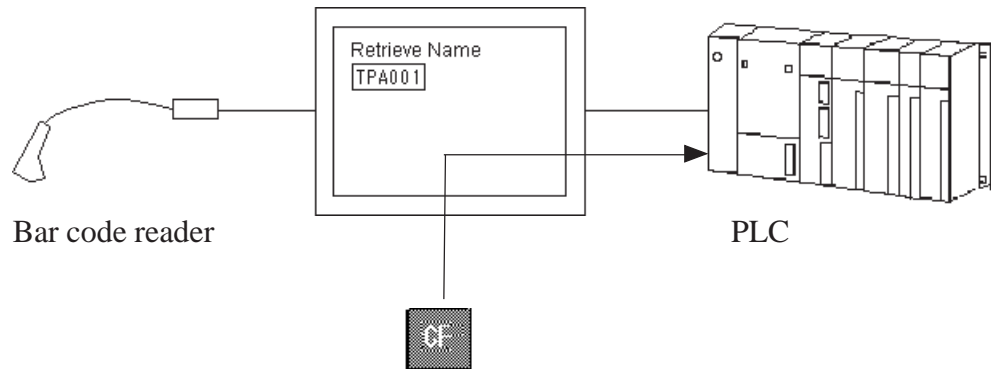

- **The CSV files can be transferred only from the CF card to the PLC. (It is not possible to transfer the CSV files from the PLC to the CF card).**
- **This function is effective only for conditional transfer operations (automatic transfer operations). For data transfer operations, use the touch panel to select a condition name (CSV file) and transfer the file.**

* This function is supported only by the GP2000 series units.

■ Transfer control address

By turning the transfer control address's Condition name search and transfer bit (bit 2) from OFF to ON, it will be possible to search for CSV files within the CF card and transfer all CSV files that match the search condition name.

• Control

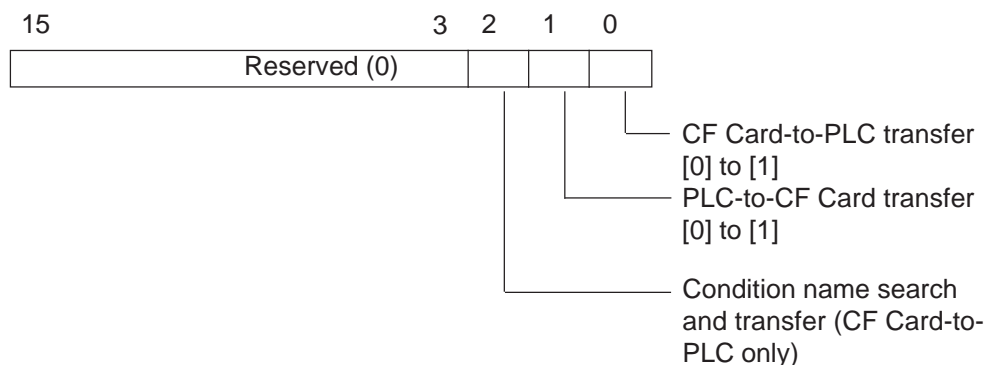

• Status

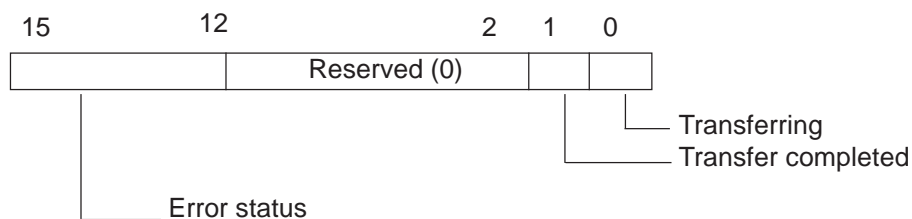

- 0: Transfer completed successfully.
- 1: No File No. (During transfer of data from CF card to PLC, target file to be transferred does not exist.)
- 2: No transfer condition No. (For CF-to-PLC or PLC-to-CF transfer, the Group No. corresponding to the specified File No. does not exist.)
- 3: LS area range error (In a CF-to-PLC data transfer in which the start address of the transfer is specified to the LS area, data transfer is attempted to an address outside the specified range of the LS area.)
- 4: No CF card (No CF card is inserted, or the cover is open.)
- 5: CF card read error (Read-out from the CF card failed in a CF-to-PLC data transfer.)
- 6: CF card write error (Data writing failed in a PLC-to-CF data transfer.)
- 7: CF card error (CF card is invalid or the media inserted is not a CF card.)
- 8: Reserved
- 9: No retrieve text (No CSV file matches the retrieve text.)
- 10: Index file error (The index file format is incorrect.)

* This function is supported only by the GP2000 series units.

■ Status during transfer

- When Control Bit 2 (Condition Name Search and Transfer Trigger Bit) is turned off, Status Bit 1 (Transfer-completed Bit) is automatically turned off.

The following diagram shows the timing of the change of the Control and Status bits during the transfer operation.

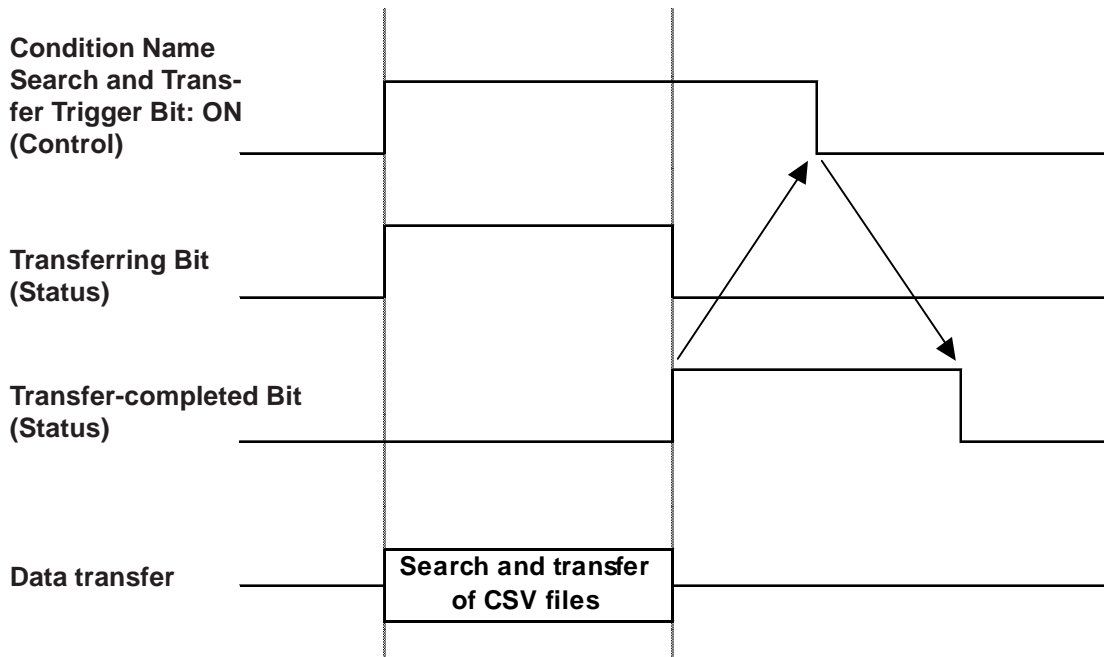

- The following diagram shows the timing of the change of the Transfer Control and Status bits when an error occurs. Before starting the next transfer, clear the Status and Control bits to 0 and turn on the required Control bit.

An error occurs.

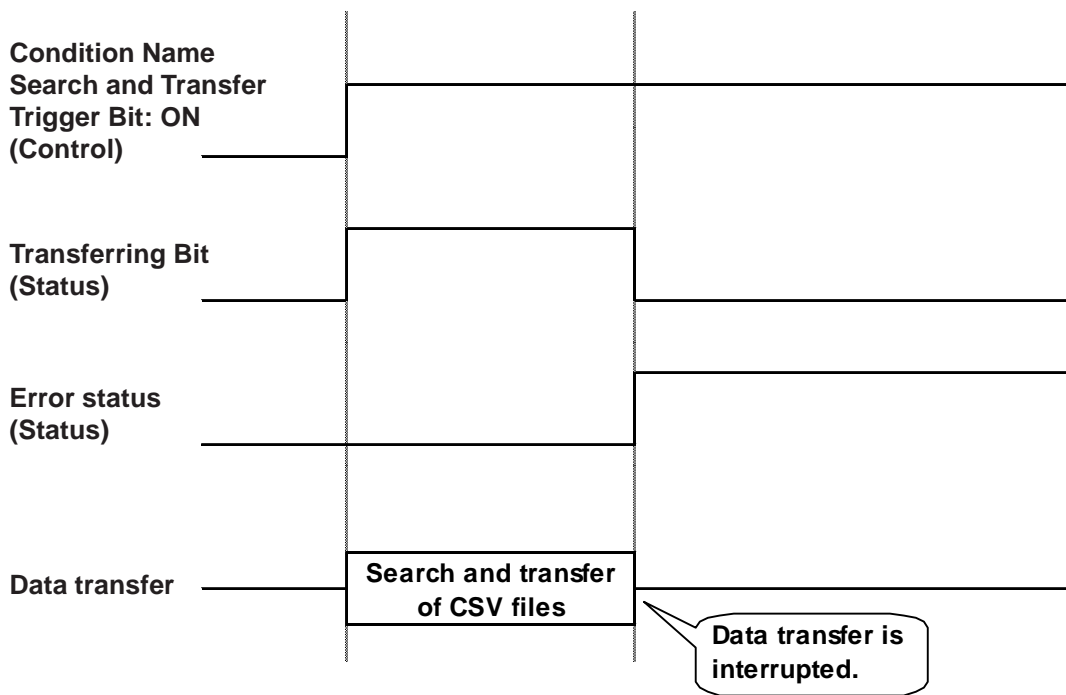

* This function is supported only by the GP2000 series units.

■ **Condition name search address**

In order to search the condition name, it is necessary to store the condition name within the LS area or the PLC device in the “Condition List | Search String”.

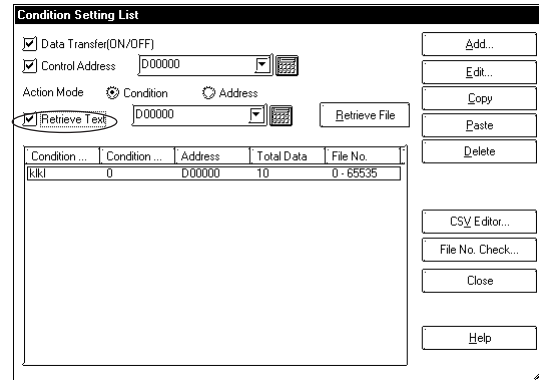

- When “16-bit” is selected, a device that handles 16-bit words is required. A device that handles 8-bit words is required when “32-bit” is selected.
- Condition Name search can be performed only for Data Modes 1, 2, 4 or 5. (Only when storing data in the Device Start Address).
- The address used in the condition name search can be either an LS Area or a PLC Device.

• **Extended System Area Status**

When data transfer is completed, the status is simultaneously to the status area and to the extended system areas LS9200 and LS9201. These areas are read-only.

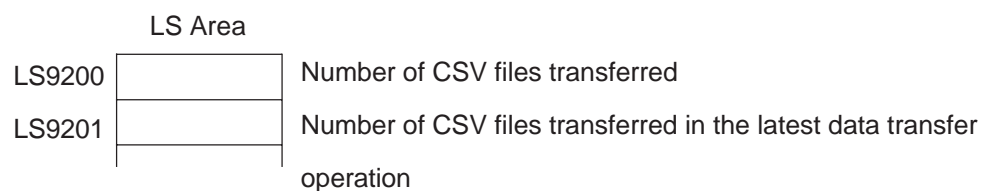

* This function is supported only by the GP2000 series units.

Store the condition names according to the String Data Mode. The following are examples of String Data Mode input.

- Example of String Data Mode 1 (16-bit address)

String "TYPE-A0001"

+0	'T'	'Y'	Condition name to be searched for
+1	'P'	'E'	
+2	'.'	'A'	
+3	'0'	'0'	
+4	'0'	'1'	
+5	0	0	

- Example of String Data Mode 1 (32-bit address)

String "TYPE-A0001"

+0	'T'	'Y'	'P'	'E'	Condition name to be searched for
+1	'.'	'A'	'0'	'0'	
+2	'0'	'1'	' '	' '	
+3	0	0	0	0	

- Example of String Data Mode 2 (16-bit address)

String "TYPE-A0001"

+0	'Y'	'T'	Condition name to be searched for
+1	'E'	'P'	
+2	'A'	'.'	
+3	'0'	'0'	
+4	'1'	'0'	
+5	0	0	

- Example of String Data Mode 2 (32-bit address)

String "TYPE-A0001"

+0	'Y'	'T'	'E'	'P'	Condition name to be searched for
+1	'A'	'.'	'0'	'0'	
+2	'1'	'0'	' '	' '	
+3	0	0	0	0	

- Example of String Data Mode 4 (16-bit address)

String "TYPE-A0001"

+0	'E'	'P'	Condition name to be searched for
+1	'Y'	'T'	
+2	'0'	'0'	
+3	'A'	'.'	
+4	' '	' '	
+5	'1'	'0'	
+6	0	0	

* This function is supported only by the GP2000 series units.

- Example of String Data Mode 4 (32-bit address)

String	"TYPE-A0001"				
+0	'E'	'P'	'Y'	'T'	Condition name to be searched for
+1	'0'	'0'	'A'	'.'	:
+2	' '	' '	'1'	'0'	:
+3	0	0	0	0	:

- Example of String Data Mode 5 (16-bit address)

String	"TYPE-A0001"		
+0	'P'	'E'	Condition name to be searched for
+1	'T'	'Y'	:
+2	'0'	'0'	:
+3	'.'	'A'	:
+4	' '	' '	:
+5	'0'	'1'	:
+6	0	0	:

- Example of String Data Mode 5 (32-bit address)

String	"TYPE-A0001"				
+0	'P'	'E'	'T'	'Y'	Condition name to be searched for
+1	'0'	'0'	'.'	'A'	:
+2	' '	' '	'0'	'1'	:
+3	0	0	0	0	:

Input example of the condition name to be searched for (when the K-tag is used)

- Up to 32 single-byte characters can be used for the condition name to be searched for.
- When the K-tag is used and the number of characters entered is less than the specified number of characters, the surplus character positions are filled with spaces.
- If the specified name is less than 32 characters, write 0 (bin) in the device next to the device storing the last character of the name. The matching operation considers characters before the device containing 0 to be the condition name for the search.
- A space can appear in the condition name being searched for. However, spaces between the last character and 0 are replaced with 0 in the matching operation.

* This function is supported only by the GP2000 series units.

The following is an example of K-tag input.

Specify “12” as the number of characters for the K-tag.

Input the string “DATA 00001” (10 single-byte characters) from the keyboard.

DATA 00001

Values of PLC devices at the K-tag input (String Mode 1)

D100	'D'	'A'
D101	'T'	'A'
D102	' '	'0'
D103	'0'	'0'
D104	'0'	'1'
D105	' '	' '

The characters are stored in the devices as shown at left.



D100	'D'	'A'
D101	'T'	'A'
D102	' '	'0'
D103	'0'	'0'
D104	'0'	'1'
D105	0	0

To use "DATA00001" as the condition name for the search, device D105 must be cleared to 0.

■ Index file

Although the condition name search and transfer operation can be performed without an index file, the search may take a long time if a large number of CSV files are present on the CF card.

For example, if approximately 1000 CSV files are searched, the search operation alone will take about one minute.



The index file is not continually updated; it is updated only when it is created on the OFFLINE screen. The index file must be updated whenever a CSV file is added or deleted from the “FILE” folder.

◆ Creating an index file

An index file can be created either through the Screen Editor software or the GP unit’s off-line screen.

* This function is supported only by the GP2000 series units.

- When creating the index file through the Screen Editor

When you click on the “Retrieve File” button within the “Condition Setting List” or the “CSV List”, the file “ZRINDEX.CSV” (used for fast search) will be created in the “CF Card Output Folder”’s “FILE” folder.

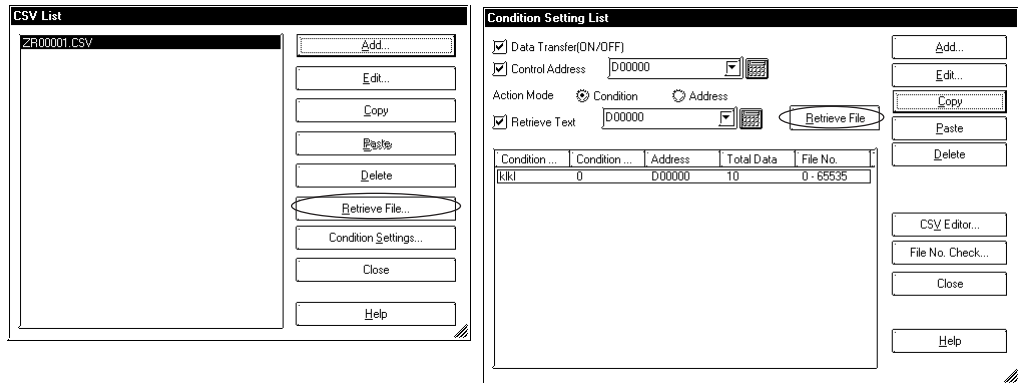

- When creating the index file through the GP unit’s OFFLINE screen

The index file can be created on the following OFFLINE screens.

1. Memory initialization screen

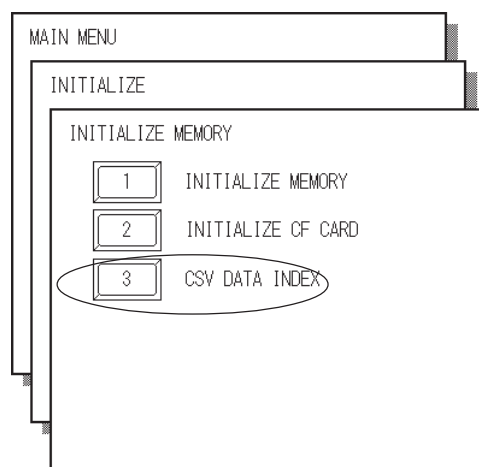

* This function is supported only by the GP2000 series units.

2. CSV data index file creation screen

CREATE CSV DATA INDEX

THE INDEX FILE OF THE CSV DATA IN OF CARD IS UPDATED.

INSERT OF CARD AND PRESS START KEY.

START

CANCEL

A CSV index file has the following format.

(ZRINDEX.CSV file)

```

00000 , Mold TYPEA
00001 , Mold TYPEA 001
00002 , Mold TYPEA 002
00003 , Mold TYPEA 003
00010 , Mold TYPEB
00011 , Mold TYPEB 001
00012 , Mold TYPEB 002
01000 , Setting Day off
01001 , Setting Monday
01002 , Setting Tuesday
01003 , Setting Wednesday
01004 , Setting Thursday
01005 , Setting Friday
65534 , Start setting
65535 , End setting

```

File No.
(5 single-byte
characters)

Condition name
(32 single-byte
characters max.)

The file numbers and condition names in the index file are created according to the CSV files stored in the “FILE” folder. Note that they are not created according to the transfer settings used in the Screen Editor Software.

**Index file size is calculated as follows:**

Note: Size (byte) = [(File number) + (Comma) + (Condition name) + (New line code)] x (Number of files)

E.g.)

File number (5 digits) : 5 bytes

Comma : 1 byte

Condition name (Max) : 32 bytes

* This function is supported only by the GP2000 series units.

New line code (CR, LF) : 2 bytes

Number of files : 3000

$(5+1+32+2) \times 3000 = 120000$ (bytes)



- **When the Condition Name Search and Transfer Trigger Bit is turned on, the condition name search and transfer operation starts immediately. To avoid this, turn off the Condition Name Search and Transfer Trigger Bit before starting the GP.**
- **When the transfer is completed successfully, the status changes from transferring (bit 0 turns on) to transfer-completed (bit 1 turns on).**
- **If Control Bit 0 (CF-to-PLC Trigger Bit) and Control Bit 2 (Condition Name Search and Transfer Trigger Bit) are turned on simultaneously, neither operation will be executed. To execute the condition name search and transfer operation, turn on Control Bit 2 only. Clear Control Bit 0 before starting the next operation.**
- **The period during which the Transferring Status Bit is on includes the time required for the search of the CSV files. Consequently, do not access the "FILE" folder in the CF card while the Transferring Bit is on.**
- **If the transfer fails, an error code is set in the error status.**
- **The end of the condition name to be searched for must be 0 (NULL) or empty (space). (When a K-tag or a setting value display device is used for the input of a condition name, and if the input characters are less than the specified number of characters, the positions of the surplus characters are filled with spaces.)**
- **When the string length stored in the condition name search address is 0 (NULL), a search is made for CSV files with no condition name.**
- **The condition names used for the search are based on the String Data Mode. The available String Data Modes are limited to those shown within the area bordered by the bolded lines below.**

(String Data Mode)

Order of data stored in device	Order of bytes stored in word (LH/HL)	Order of bytes stored in double word (LH/HL)	String Data Mode
Stored from the first data	HL	HL	1
	LH		2
	HL	LH	5
	LH		4
Stored from the last data	HL	HL	3
	LH		7
	HL	LH	8
	LH		6

* This function is supported only by the GP2000 series units.

- **The condition name search and transfer operation searches all CSV files contained in the “FILE” folder on the CF card. The found files are transferred in the order of their CSV file numbers.**
- **The condition name search and transfer operation searches all CSV files contained in the “FILE” folder on the CF card. Therefore, as the number of CSV files in the folder increases, the time required for the search and transfer increases. If an index file has been created, the search automatically refers to the index file. To avoid using the index file, delete it with the CF Card File Manager or another method.**
- **Although the index file can be edited, index file errors and failed transfers will result in the following occurrences. In such cases, create a new index file or delete the existing index file before resuming the transfer operation.**

(ZRINDEX.CSV file)

```

00000 , Mold TYPEA
00001 , Mold TYPEA 001
00002 , Mold TYPEA 002
00003 , Mold TYPEA 003
65536 , Mold TYPEB
00011 , Mold TYPEB 001
00012 , Mold TYPEB 002
01000 , Setting Day off

```

- Some file numbers are missing.
- The file number is not within the range of 0 to 65535. (When an index file is created, only file numbers between 0 and 65535 are used in the index.)
- The file is not in CSV file format.

- **If the CF card contains too many CSV files, considerable time is required to create an index file. If the card contains 4,000 files, for example, index creation takes about 10 minutes.**

* This function is supported only by the GP2000 series units.

and set the trigger bit address of the control from OFF to ON again to recover from the error.

After data is trasfered from the CF card to the PLC, it cannot recover from the error unless the power is turned OFF and ON again or reset. Be careful not to specify an incurrent address or a nonexistent device.

- **Even if the control address is 32 bits long, the number of the device to be used will be 16 (address).**
- **The system will not function with the following protocols:**

Manufacturer	Model
Mitsubishi Electronics	MELSECNET/10
OMRON	SYSMAC CS1 Ethernet
Allen Bradley	PLC-5 Data Highway+
	SLC500 DH485
	Remote I/O
Modicon	Modbus Plus
Digital	CC-Link Intelligent Device
Siemens	S7-200MPI
	S7-300/400MPI

* This function is supported only by the GP2000 series units.

4.4.7 Manual Transfer Operation on the GP

Manual transfer is effective as a filing application. It is available only when overwriting a CSV file stored in the CF card. If no CSV file exists in the CF card, data cannot be transferred from the PLC to the CF card. In manual transfer mode, the transfer is executed with the Data Transfer Display. When a CSV Data Display is set up, it allows you to review and edit the CSV data.

Reference "4.5 CSV Data Display Function."

00000	Unit 1	CF->	1		2		UP
00001	Unit 2		1	:DATE	2002/04/16		DN
00002	Unit 3	>CF	2	:GROUP No.	1		LF
00003	Production Start Data	UP	3	:GROUP NAME	Unit 1		RT
00004	Production Stop Data	DOWN	4	ITEM NAME	VALUE		PRN
00005	Test Data	DISP	5	VALUE			
			6		230		
			7		300		
			8		540		

CSV Data Display

Data Transfer Display

Data Transfer Display

Data Transfer Display displays the CSV data files to be transferred on the CF card in a list, and performs the transfer. In addition, you can select and deselect files directly on the touch-screen panel.

The Data Transfer Display displays the File No. and condition name (Group Name) of the CSV data (ZR00001.CSV, for example). For detailed operation procedures, **Reference** *Operation Manual "2.1.18 Data Transfer Display"*.

Example: When the File No. is "0001" and the condition name (Group Name) is "Unit 1," the display will be "00001 Unit 1".



- **Up to 32 Data Transfer Displays can be set up for the entire project. Displays exceeding the limit will not function.**
- **One Data Transfer Display can be set up on each base screen. Do not set up two or more displays on the same screen; otherwise, switch operation cannot be guaranteed.**
- **When transferring data from the PLC to a CF card, ": GROUP NAME" will store the condition name (Group Name) specified in the condition settings.**

* This function is supported only by the GP2000 series units.



Note: • The CSV data can be selected only in the displayed area. If the page is switched with the UP or DOWN keys, the selection will be deselected.

- Two or more CSV data items can be selected and transferred in a single operation.

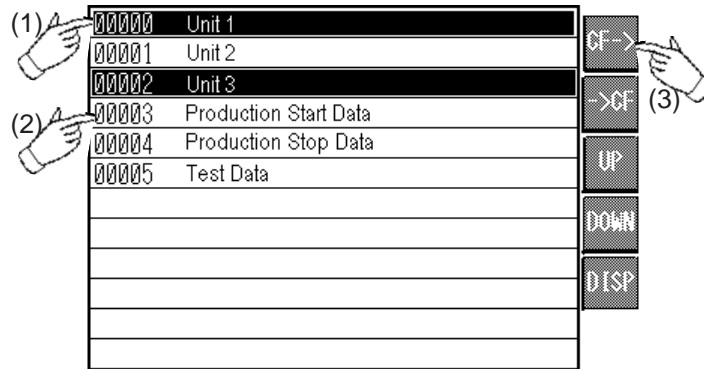

■ Setting parameters

When performing a manual data transfer, set up a Data Transfer Display on the screen and transfer the data with the touch switch.

◆ Information

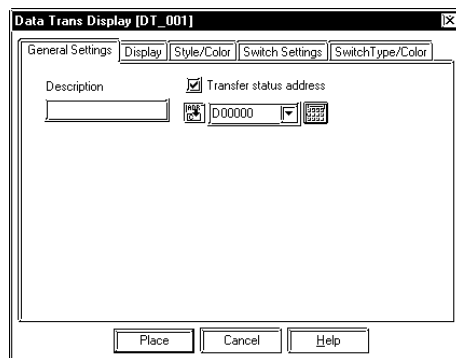

Description

Enter the desired comments for the Data Transfer Display.

Transfer status address

The transfer status is stored in this address. Refer to the following page for the details.

* This function is supported only by the GP2000 series units.

• **Transfer status address**

The address stores the status upon the transfer. When the check mark is removed, the status will not be reflected in the transfer status address. The following is the description of the transfer status.

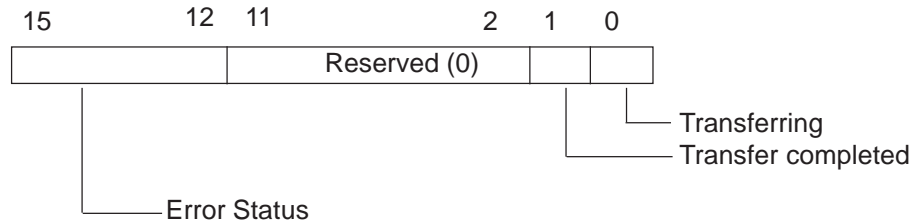

- 0: Transfer completed successfully.
- 1: Reserved
- 2: No transfer condition No. (GROUP No.) (In a CF-to-PLC data transfer, the transfer condition No. corresponding the file No. specified in a PLC-to-CF transfer does not exist.)
- 3: LS area range error (In a CF-to-PLC data transfer in which the start address of the transfer is specified in the LS area, a data transfer is attempted to an address outside the specified range of the LS area.)
- 4: No CF card (No CF card is inserted, or the cover is open.)
- 5: CF card read error (Read-out from the CF card failed in a CF-to-PLC data transfer.)
- 6: CF card write error (Data writing failed in a PLC-to-CF data transfer.)
- 7: CF card error (CF card is invalid or the media inserted is not a CF card.)
- 8: Reserved

The Transmit Completed Bit Address of the transfer status address will not be turned OFF on the GP. Turn OFF the bit via the PLC. The following is the timing chart of the bits during the transfer operation.

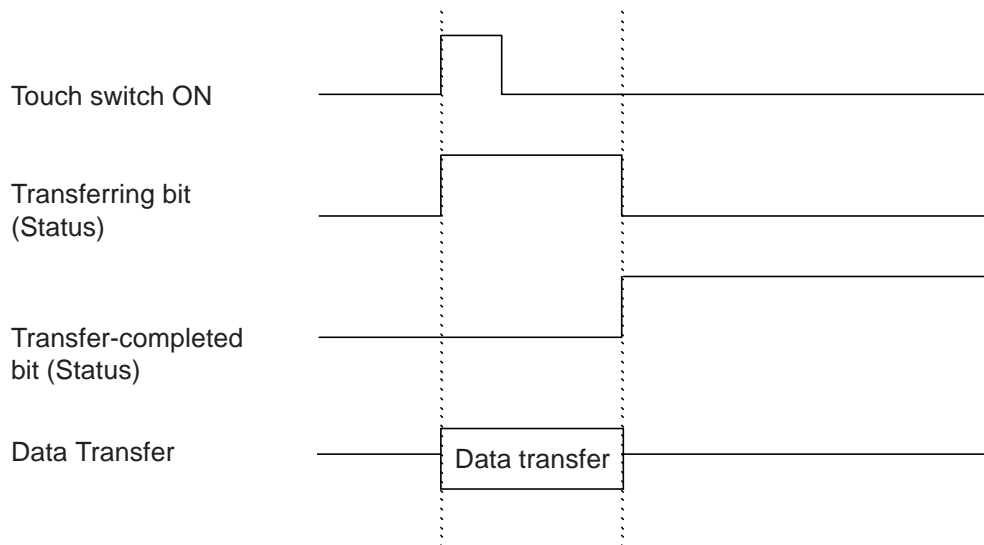

* This function is supported only by the GP2000 series units.

◆ Display format

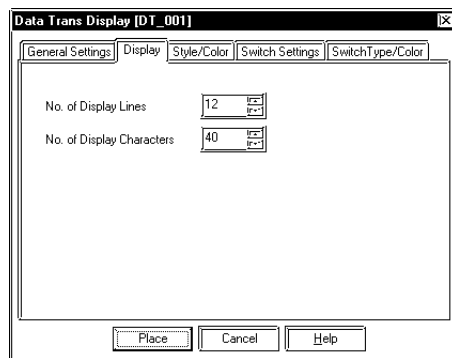

No. of Display Lines

Specify the number of lines for displaying the CSV data file. The valid range is from 1 to 50.

No. of Display Characters

Specify the maximum number of single-byte characters to be displayed in a line. The valid range is from 1 to 100.

◆ Style/Color

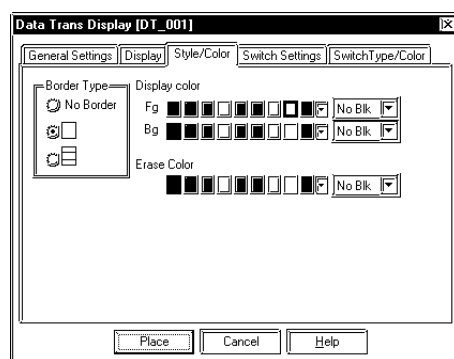

Border Type

Select the desired border type among "No border," "Outer border," and "Outer and inner borders."

Display Color

Select the desired colors for Fg (foreground), Bg (background), and Blk (blink) options.

Erase Color

Select the desired color for the display area that will be used when the parameters are cleared.

◆ Switch Settings

Specify the type of Function Switch to be placed in the same operation. (This tab is not displayed when the attributes of the data transfer function are being changed.)

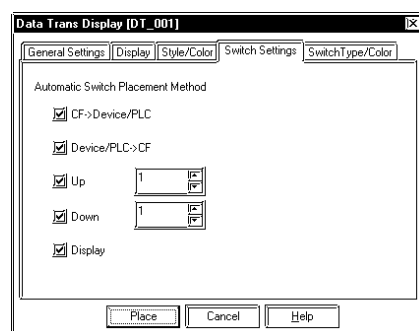

CF→Device/PLC

Touch to select the file to be transferred on the Data Transfer Display, and touch the "CF→" switch to transfer the selected data file. When transferring two or more files in one operation, select and transfer all the desired files at one time.

Device/PLC→CF

In the same manner as with the "CF→Device/PLC" transfer, touch and select the desired file(s) on the Data Transfer Display, and touch the "→CF" switch to transfer the data file. When transferring two or more files in one operation, select and transfer all the desired files at one time.

* This function is supported only by the GP2000 series units.

Up/Down

The Up and Down arrow keys cannot be used to select items or move the selection. Use these keys to switch the pages listing the CSV data.

Display

When the Display switch is touched while a file is selected, the list of CSV data in the selected file will be displayed on the CSV Data Display. When two or more files are selected, the data of the file at the top of the list is displayed on the CSV Data Display.

◆ **Switch Type/Color**

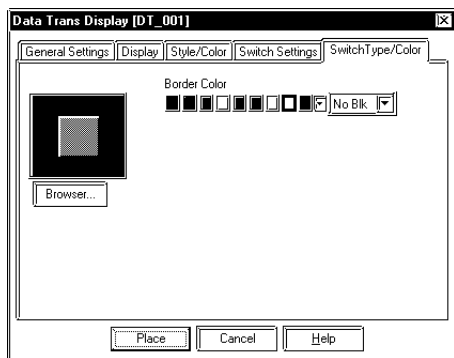

Browser

Select the desired shape for the switch to be placed on the screen.

Border Color

Select the desired color for the border.

* This function is supported only by the GP2000 series units.

4.4.8 Example of Automatic Transfer for Filing Application (Conditional Operation)

When performing automatic transfer, use the transfer control address to transfer the data.

Transferring two or more files from a CF card to the PLC in automatic transfer mode

Transfer the CSV data from files ZR00001 and ZR00010 on the CF card.

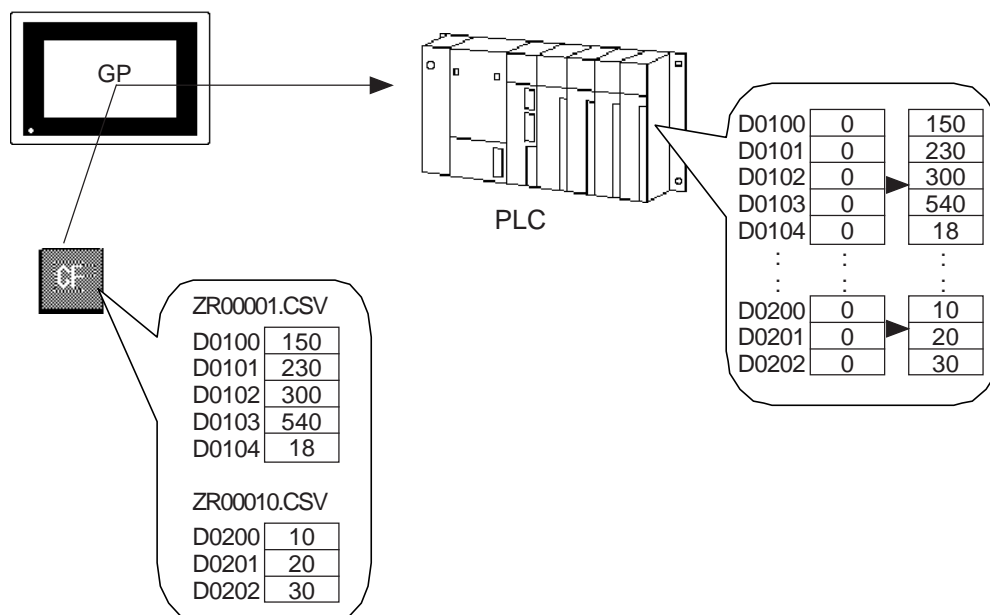

Transfer operation settings

The transfer control address is D0050. The transfer conditions are listed in the following table.

Condition Setting					Extended Settings
Condition No. of transfer	Start address of transfer	Quantity of data	Data format	File No.	
0	D0100	5	16 bits long, No Code	ZR00000 to ZR00009	-
1	D0200	3	16 bits long, No Code	ZR00010 to ZR00019	-

* This function is supported only by the GP2000 series units.

Transfer data**Data of File No. 1 (ZR00001.CSV)**

: DATE	2002/1/19 09:30:00
: GROUP No.	0
: GROUP NAME	Unit 1
ITEM NAME	VALUE
	150
	2130
	300
	540
	18

Data of File No. 10 (ZR00010.CSV)

: DATE	2002/1/19 09:30:00
: GROUP No.	1
: GROUP NAME	Unit 2
ITEM NAME	VALUE
	10
	20
	30

Transfer procedure

1. Set "2" as the number of files to be transferred (D0052).
2. Set "1" as the transfer File No. (D0053).
3. Set "10" as the transfer File No. (D0054).
4. Change bit 0 of the control address (D0050) from OFF to ON.
5. The data will be transferred to the specified device address.
6. After checking the Transmit Completed Bit Address, change bit 0 of the control address from ON to OFF.

D0050	0 → 1	Trigger bit for CF-to-PLC transfer
D0051	0	Transfer status
D0052	2	Number of files to be transferred
D0053	1	Specifies File No. 1.
D0054	10	Specifies File No. 10



Note: When the transfer is completed successfully, D0051 (Status) changes from "Transferring" (bit 0 is ON) to "Transfer-completed" (1st bit is ON).

- If the transfer has failed, "Transferring" (bit 0 is ON) changes to error status, and the error code is set.
- Turning OFF bit 0 of D0050 (Control) in step 6 automatically turns OFF bit 1 (Transfer-completed) of D0051 (Status).
When transferring data sequentially, confirm that the transfer-completed bit has turned OFF before executing the data transfer.

* This function is supported only by the GP2000 series units.

■ Transferring two or more files from the PLC to a CF card in automatic transfer mode

Transfer the files numbered "D0100" to "D0104" and "D0200" to "D0202" from the PLC to the CF card.

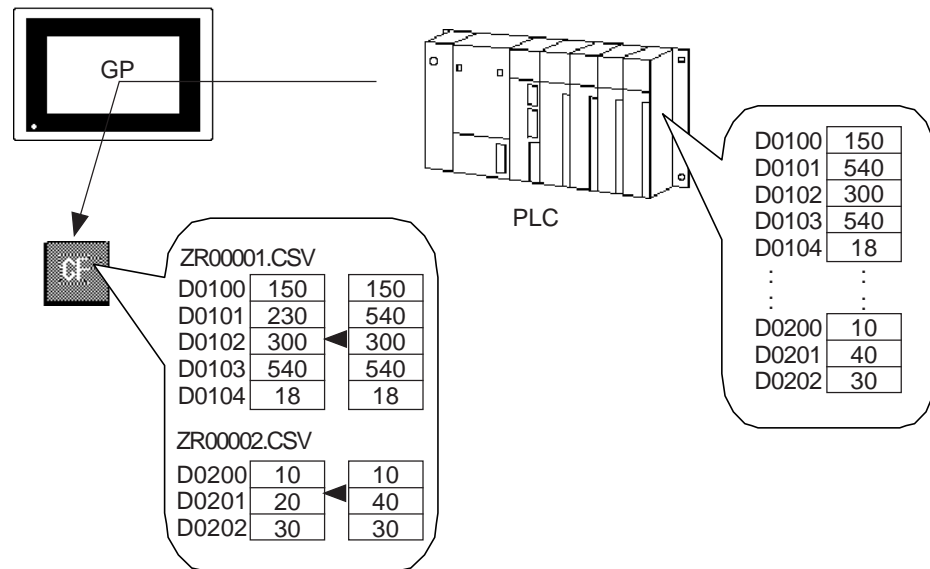

Transfer operation settings

The transfer control address is D0050. The transfer conditions are listed in the following table.

Condition Setting					Extended Settings
Condition No. of transfer	Start address of transfer	Quantity of data	Data format	File No.	
0	D0100	5	16 bits long, No Code	ZR00000 to ZR00009	-
1	D0200	3	16 bits long, No Code	ZR00010 to ZR00019	-

* This function is supported only by the GP2000 series units.

Transfer procedure

1. Specify the number of files to be transferred. (Set "2" to D0052.)
2. Specify the File No. to be transferred. (Set "1" to D0053.)
3. Specify the File No. to be transferred. (Set "10" to D0054.)
4. Change bit 1 of the control address from OFF to ON. (Change bit 1 of D0050 from OFF to ON.)
5. The data will be transferred to the specified File No.
6. After verifying the Transmit Completed Bit, change bit 1 of the control address from ON to OFF.

D0050	0 → 2	Trigger bit for CF-to-PLC transfer
D0051	0	Transfer status
D0052	2	Number of files to be transferred
D0053	1	Specifies File No. 1.
D0054	10	Specifies File No. 10

Transferred CSV data**Data of File No. 1 (ZR00001.CSV)**

: DATE	02/1/19 10:30:00
: GROUP No.	0
: GROUP NAME	Unit 1
ITEM NAME	VALUE
	150
	540
	300
	540
	18

Data of File No. 10 (ZR00010.CSV)

: DATE	02/1/19 10:30:00
: GROUP No.	1
: GROUP NAME	Unit 2
ITEM NAME	VALUE
	10
	40
	30



When data is transferred from the PLC to the CF card, year is displayed in two digits.

* This function is supported only by the GP2000 series units.

4.4.9 Example of Automatic Transfer for Filing Application (Address Operation)

■ Transferring data from a CF card to the PLC

The following example shows the procedure for transferring the CSV data of file ZR00001 on the CF card to the PLC.

Transfer information

Address Operation enables you to specify the following information with a transfer control address.

Transfer control address	D0050
Data format	16 bits long, No Code
File No.	1
Transfer start address	D0100
Quantity of data to be transferred	10
Transfer data	ZR00001.CSV

Transfer data

	A	B
1	:DATE	2002/06/13 10:30:00
2	:GROUP NO.	1
3	:GROUP NAME	No.1 Mixer
4	ITEM NAME	VALUE
5		150
6		230
7		300
8		540

Transfer control address

D0050	0x0001	CF-to-PLC trigger bit
D0051	0	Status
D0052	1	File No.: 1
D0053	0	Mode: Bit length: 16, No Code
D0054	0x0000	Device Code: D-device
D0055	100	Device Address: 100
D0056	10	Quantity of data: 10
D0057	Reserved	
:		
D0065		

* This function is supported only by the GP2000 series units.

Transfer operation

1. Set "0" (Data Format: 16 bits long) to D0053 "Mode Address".
2. Set "1" (File No.) to D0052 "File No. Address".
3. Set "0x0000" (D-device) to D0054 "Device Code".
4. Set "100" (Address 100) to D0055 "Address 100".
5. Set "10" to D0056 "Quantity of data".
6. Change bit 0 (CF-to-PLC Trigger Bit) of D0050 "Control" from OFF to ON.
7. The Transmit Completed Bit of D0051 "Status" changes from OFF to ON.

■ Transferring data from the PLC to a CF card

The following example shows the procedure for transferring the data of D0100 to D0109 on the PLC to a CF card.

Transfer information

Transfer control address	D0050
Data format	16 bits long, No Code
File No.	2
Start address of destination	D0100
Quantity of data to be transferred	10

Transfer control address

D0050	0x0002	CF-to-PLC trigger bit
D0051	0	Status
D0052	2	File No.: 2
D0053	0	Mode: Bit length: 16, No Code
D0054	0x0000	Device Code: D-device
D0055	100	Device Address: 100
D0056	10	Quantity of data: 10
D0057 : D0065	Reserved	

Transfer operation

1. Set "0" (Data Format: 16 bits long) to D0053 "Mode Address".
2. Set "2" (File No.) to D0052 "File No. Address".
3. Set "0x0000" (D-device) to D0054 "Device Code".
4. Set "100" (Address 100) to D0055 "Device Address".
5. Set "10" to D0056 "Quantity of data".
6. Change the 1st bit (PLC-to-CF Trigger Bit) of D0050 "Control" from OFF to ON.
7. The Transmit Completed Bit of D0051 "Status" changes from OFF to ON.

* This function is supported only by the GP2000 series units.

Transfer result

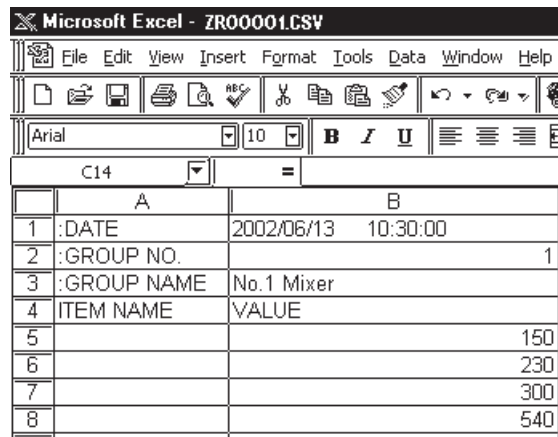

When data is transferred from the PLC to the CF card, year is displayed in two digits.

■ Deleting a file

Deletion information

Transfer Control Address	D0050
File No. to be deleted	2

Transfer Control Address

D0050	0x8000	Control: Deletion bit for file on CF card
D0051	0	Status
D0052	2	File No.: 2
D0053	Reserved	
:		
D0065		

Transfer Operation

1. Set "2" (File No.) to D0052 "File No. Address".
2. Change the 15th bit (trigger bit for file deletion) of D0050 "Control" from OFF to ON.
3. The Transmit Completed Bit (Deletion Completed Bit) of D0051 "Status" changes from OFF to ON.

* This function is supported only by the GP2000 series units.

4.4.10 Example of Manual Transfer for Filing Application

When performing a manual transfer, use the Data Transfer Display to transfer the data.

■ Transferring two or more files from a CF card to the PLC in manual transfer mode

Transfer operation setting

The transfer is executed with the Data Transfer Display. The transfer conditions are listed in the following table.

Condition Setting					Extended Settings
Condition No. of transfer	Start address of transfer	Quantity of data	Data format	File No.	
0	D0100	5	16 bits long, No Code	ZR00000 to ZR00001	-
1	D0200	3	16 bits long, No Code	ZR00002 to ZR00003	-

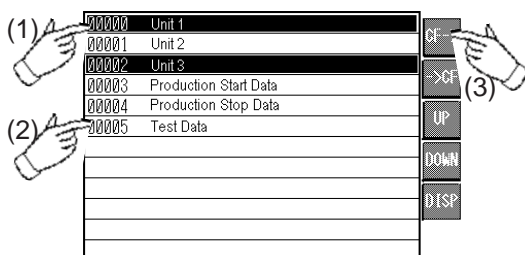

- (1) Touch to select the desired condition name "Unit 1" (Group Name).
- (2) Touch to select the desired condition name "Unit 3" (Group Name).
- (3) Touch the "CF->" key.
- (4) The data is transferred to the PLC according to the transfer condition of the specified condition name.
- (5) Check the Transmit Completed Bit of the transfer status (Bit 1 of D0030 changes from OFF to ON.) (D0030 is set with the data transfer display.)

Transfer data

Data of File No. 1 (ZR00001.CSV)



: DATE	2002/1/19 09:30:00
: GROUP No.	0
: GROUP NAME	Unit 1
ITEM NAME	VALUE
	150
	230
	300
	540
	18

Data of File No. 2 (ZR00002.CSV)

: DATE	2002/1/19 9:40:00
: GROUP No.	1
: GROUP NAME	Unit 2
ITEM NAME	VALUE
	10
	20
	30

* This function is supported only by the GP2000 series units.

Data Transfer Display

Setting parameter	Options	Setting
Transfer Status Address	Not assigned	N/A
	Assigned (word address)	D0030
No. of Lines	Numeral input	12
No. of Characters	Numeral input	40
Style	No border	N/A
		N/A
		Enabled
Switch	CF to PLC	Enabled
	PLC to CF	Enabled
	Roll Up	Enabled
	Roll Down	Enabled
	Display	Enabled

Transferring two or more files from the PLC to a CF card in manual transfer mode

Transfer operation setting

The transfer is executed with the Data Transfer Display. The transfer conditions are listed in the following table.

Condition Setting					Extended Settings
Condition No. of transfer	Start address of transfer	Quantity of data	Data format	File No.	
0	D0100	5	16 bits long, No Code	ZR00000 to ZR00001	-
1	D0200	3	16 bits long, No Code	ZR00002 to ZR00003	-

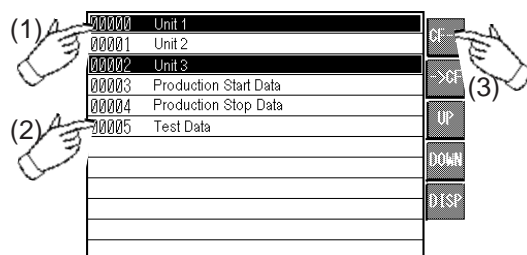

- (1) Touch to select the desired condition name "Unit 1" (Group Name).
- (2) Touch to select the desired condition name "Unit 3" (Group Name).
- (3) Touch the "CF->" key.
- (4) The data is transferred to the CF card according to the transfer condition of the specified condition name.
- (5) Check the Transmit Completed Bit of the transfer status (Bit 1 of D0030 changes from OFF to ON.)

* This function is supported only by the GP2000 series units.



Received Data**Data of File No. 0 (ZR00000.CSV)**

: DATE	2002/1/19 09:30:00
: GROUP No.	0
: GROUP NAME	Unit 1
ITEM NAME	VALUE
	150
	230
	300
	540
	18

Data of File No. 2 (ZR00002.CSV)

: DATE	2002/1/19 09:30:00
: GROUP No.	1
: GROUP NAME	Unit 3
ITEM NAME	VALUE
	10
	20
	30

Data Transfer Display

Setting parameter	Options	Setting
Transfer Status Address	Not assigned	N/A
	Assigned (word address)	D0030
No. of Lines	Numeral input	12
No. of Characters	Numeral input	40
Style	No border	N/A
		N/A
		Enabled
Switch	CF to PLC	Enabled
	PLC to CF	Enabled
	Roll Up	Enabled
	Roll Down	Enabled
	Display	Enabled

* This function is supported only by the GP2000 series units.

4.4.11 Example of Transfer for Logging Application (1)

This example shows the procedure for transferring data from the PLC to a CF card with automatic numbering of the File No. and loop operation.

Transferring two or more groups

Transfer operation setting

The transfer control address is D0050. The transfer conditions are listed in the following table.

Condition Setting					Extended Settings
Condition No. of transfer	Start address of transfer	Quantity of data	Data format	File No.	File No. Designation
					Automatic Numbering
0	D0100	5	16 bits long, No Code	ZR00100 to ZR00199	Loop operation: ON
1	D0200	3	16 bits long, No Code	ZR00200 to ZR00299	Loop operation: ON

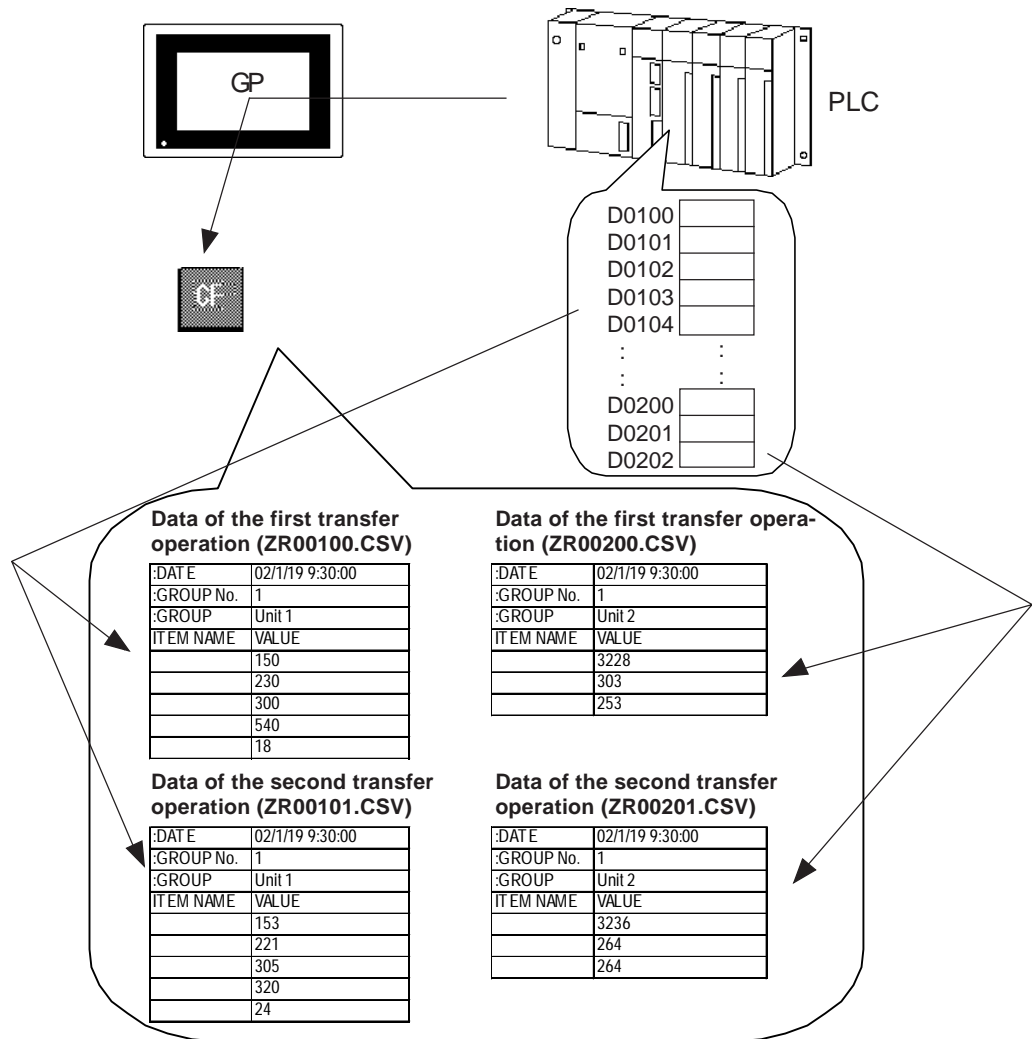

* This function is supported only by the GP2000 series units.

Procedure for first data transmission

- (1) Specify the number of files to be transferred. (Set "2" to D0052.)
- (2) Specify the File No. to be transferred. (Set "100" to D0053.)
- (3) Specify the File No. to be transferred. (Set "200" to D0054.)
- (4) Change bit 1 of the Control Address from OFF to ON. (Change bit 1 of D0050 from OFF to ON.)
- (5) Load the data on the specified device to a CF card.
- (6) After checking the Transmit Completed Bit Address, change bit 1 of the Control Address from ON to OFF.

Procedure for second data transmission

- (1) Change bit 1 of the Control Address from OFF to ON. (Change bit 1 of D0050 from OFF to ON.)
- (2) Load the data on the specified device to a CF card.
- (3) After checking the Transmit Completed Bit Address, change Bit 1 of the Control Address from ON to OFF.

Transfer Control Address

(First transfer operation)			File name to be created
D0050	0 to 2	PLC-to-CF Trigger bit	
D0051	0	Transfer status	
D0052	2	Number of files to be transferred	ZR00100.CSV
D0053	100	Designation of File No. 1	ZR00200.CSV
D0054	200	Designation of File No. 2	
(Second transfer operation)			
D0050	0 to 2	PLC-to-CF Trigger bit	
D0051	0	Transfer status	
D0052	2	Number of files to be transferred	ZR00101.CSV
D0053	100 to 101	Display of File No. created	ZR00201.CSV
D0054	200 to 201	Display of File No. created	
:			
(100th transfer operation)			
D0050	0 to 2	PLC-to-CF Trigger bit	
D0051	0	Transfer status	
D0052	2	Number of files to be transferred	ZR00199.CSV
D0053	198 to 199	Display of File No. created	ZR00299.CSV
D0054	298 to 299	Display of File No. created	
(101st transfer operation)			
D0050	0 to 2	PLC-to-CF Trigger bit	
D0051	0	Transfer status	ZR00100.CSV
D0052	2	Number of files to be transferred	ZR00200.CSV
D0053	199 to 100	Display of File No. created	will be created by
D0054	299 to 200	Display of File No. created	overwriting

* This function is supported only by the GP2000 series units.



As shown in the examples on the previous page, the data is transferred in the order of the file numbers starting from the top, starting with File No. 1 (D0053) and File No. 2 (D0054), and so on. If an error occurs during transmission, the operation is aborted after the current transmission is completed. Subsequent files are not transferred.



- When the transfer operation is completed successfully, D0051 (status) changes from "Transferring" (bit 0 is ON) to "Transmit Completed" (1st bit is ON). The Transmit Completed Bit turns ON after the CSV data is written onto the CF card.
- Turning OFF bit 1 of D0050 (Control) in step (6) of the "Procedure for first data transmission" and in step (3) of the "Procedure for second data transmission" automatically turns OFF bit 2 (Transmit Completed) of D0051 (Status).
If the GP turns OFF during logging and automatic numbering is set, specify transfer control values again according to the "Procedure for first data transmission". Data transfer will restart from the point at which the GP turned OFF.

4.4.12 Example of Transfer for Logging Application (2)

This example shows the procedure for transferring data from the PLC to a CF card with automatic numbering of the File No. and without loop operation.

■ Transferring two or more groups

Transfer operation setting

The transfer control address is D0050. The transfer conditions are listed in the following table.

Condition Setting					Extended Settings
Condition No. of transfer	Start address of transfer	Quantity of data	Data format	File No.	File No. Designation
					Automatic Numbering
0	D0100	5	16 bits long, No Code	ZR00100 to ZR00199	File No. Designation Loop operation: OFF Full Bit address (M0000) Restart Bit Address (M0016)
1	D0200	3	16 bits long, No Code	ZR00200 to ZR00299	File No. Designation Loop operation: OFF Full Bit address (M0001) Restart Bit Address (M0017)

* This function is supported only by the GP2000 series units.

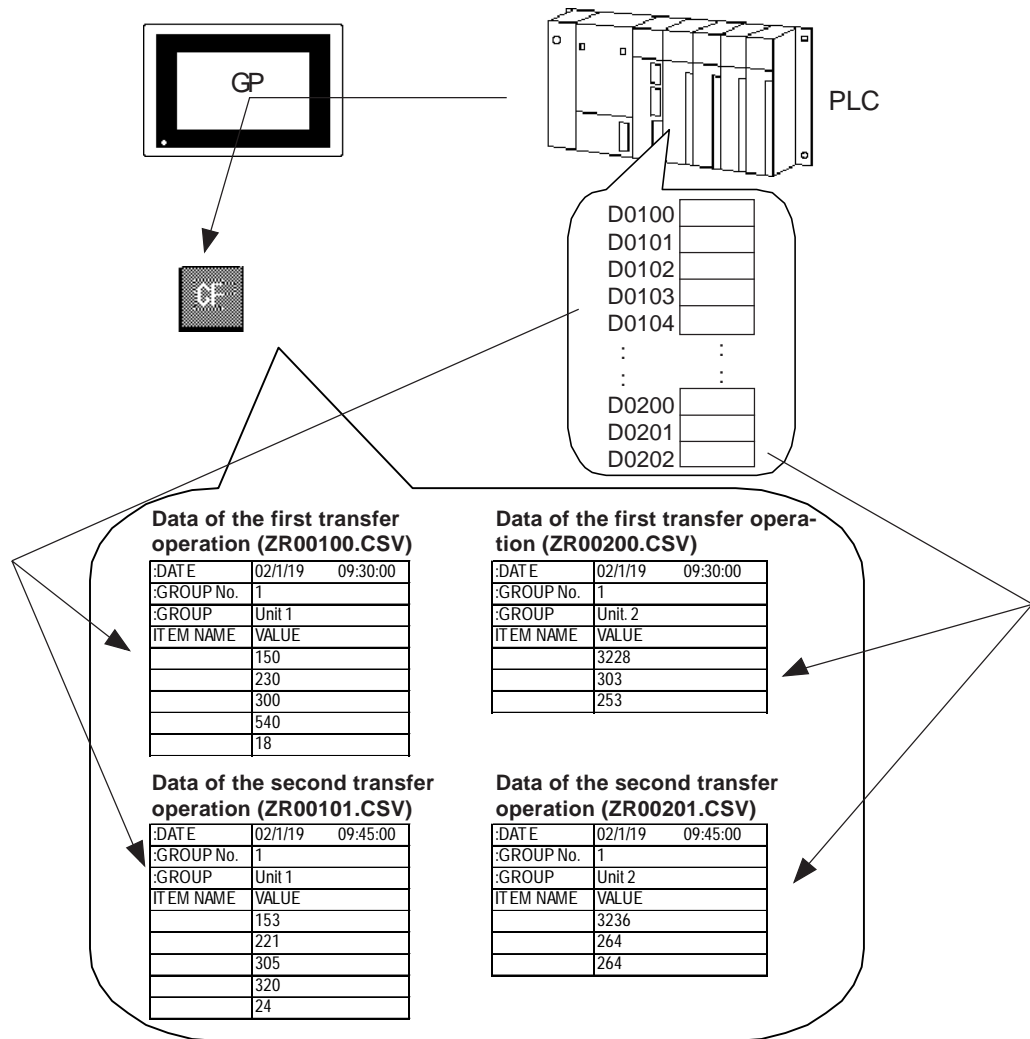

Procedure for first data transmission

- (1)Specify the number of files to be transferred. (Set "2" to D0052.)
- (2)Specify the File No. to be transferred. (Set "100" to D0053.)
- (3)Specify the File No. to be transferred. (Set "200" to D0054.)
- (4)Change bit 1 of the Control Address from OFF to ON. (Change bit 1 of D0050 from OFF to ON.)
- (5)Load the data on the specified device to a CF card.
- (6)After checking the Transmit Completed Bit Address, change bit 1 of the Control Address from ON to OFF.
- (7)Check that the Transmit Completed Bit Address changes from ON to OFF.

Procedure for second data transmission

- (1)Change bit 1 of the Control Address from OFF to ON. (Change bit 1 of D0050 from OFF to ON.)
- (2)Load the data on the specified device to a CF card.
- (3)After checking the Transmit Completed Bit Address, change bit 1 of the Control Address from ON to OFF.
- (4)Check that the Transmit Completed Bit Address changes from ON to OFF.

* This function is supported only by the GP2000 series units.

Procedure for 100th data transmission

- (1) Change bit 1 of the Control Address from OFF to ON. (Change bit 1 of D0050 from OFF to ON.)
- (2) Load the data on the specified device to a CF card.
- (3) After verifying the Transmit Completed Bit Address, change bit 1 of the Control Address from ON to OFF.
- (4) Check that the Transmit Completed Bit Address changes from ON to OFF.
- (5) After checking that Full Bit Address is turned ON, change the Restart Bit from OFF to ON.

Transfer Control Address

(First transfer operation) File name being created

D0050	0 to 2	PLC-to-CF Trigger bit	
D0051	0	Transfer status	
D0052	2	Number of files to be transferred	ZR00100.CSV
D0053	100	Designation of File No. 1	ZR00200.CSV
D0054	200	Designation of File No. 2	

(Second transfer operation)

D0050	0 to 2	PLC-to-CF Trigger bit	
D0051	0	Transfer status	
D0052	2	Number of files to be transferred	ZR00101.CSV
D0053	100 to 101	Display of File No. created	ZR00201.CSV
D0054	200 to 201	Display of File No. created	

:

(100th transfer operation)

D0050	0 to 2	PLC-to-CF Trigger bit	
D0051	0	Transfer status	
D0052	2	Number of files to be transferred	ZR00199.CSV
D0053	198 to 199	Display of File No. created	ZR00299.CSV
D0054	298 to 299	Display of File No. created	

Full Bit Address M0000 and M0001 turn ON.
Turn ON the Restart Bit Address M0016 and M0017.

(201st transfer operation)

D0050	0 to 2	PLC-to-CF Trigger bit	
D0051	0	Transfer status	ZR00100.CSV
D0052	2	Number of files to be transferred	ZR00200.CSV
D0053	199 to 100	Display of File No. created	Creating new files by
D0054	299 to 200	Display of File No. created	overwriting

* This function is supported only by the GP2000 series units.



- **As shown in the example on the previous page, the data is transferred in the order of the file numbers starting from the top, starting with File No. 1 (D0053), File No. 2 (D0054), and so on. If an error occurs during the transmission, the operation is aborted after the current transmission is completed. Subsequent files will not be transferred.**
- **When loop operation is disabled, the Full Bit Address turns ON when files are created within the predetermined range. To repeat the operation, turn ON the Restart Bit Address. In this case, each file created will overwrite an existing file.**

* This function is supported only by the GP2000 series units.



4.5 CSV Data Display Function

4.5.1 Overview

The CSV Data Display is a part that enables the display, editing and printing of the CSV data stored on a CF card. The CSV Data Display allows you to review and edit various CSV data; therefore, it can be combined with a Data Transfer Display or File Manager Display for editing of the data for CSV data transfer or other CSV data without requiring that the data be transferred to the LS area.

◆ Combining the CSV Data Display with the Data Transfer Display

The CSV file of "00000 Unit 1" on the Data Transfer Display is displayed with the CSV Display.

00000	Unit 1	CF->
00001	Unit 2	->CF
00002	Unit 3	UP
00003	Production Start Data	DOWN
00004	Production Stop Data	DISP
00005	Test Data	

1	2	UP	
1	:DATE	2002/04/16	DN
2	:GROUP No.	1	LF
3	:GROUP NAME	Unit 1	RT
4	ITEM NAME	VALUE	PRN
5	VALUE		
6		230	
7		300	
8		540	

CSV Display

Data Transfer Display

◆ Combining the CSV Data Display with the File Manager Display

The CSV file of "ZR00000.CSV" on the File Manager Display is displayed with the CSV Display.

<DIR>		DISP
..		DEL
ZR00000.CSV		
ZR00001.CSV		
ZR00002.CSV		
ZR00003.CSV		
ZR00004.CSV		
ZR00005.CSV		
Time : 02/09/11 09:24		
Size : 112 bytes		

1	2	UP	
1	:DATE	2002/04/16	DN
2	:GROUP No.	1	LF
3	:GROUP NAME	Unit 1	RT
4	ITEM NAME	VALUE	PRN
5		300	
6		230	
7		300	
8		540	

CSV Display

File Manager Display

* This function is supported only by the GP2000 series units.

4.5.2 Details

- Only one CSV Data Display can be set up on the Base Screen.
- The CSV Data Display cannot be used in a window.
- The CSV Data Display and Logging Display cannot coexist on a screen.
- The CSV Data Display and a K-tag cannot coexist on a screen.
- The CSV Data Display and Keypad Input Display cannot coexist on a screen.
- The CSV Data Display and an N-699 tag cannot coexist on a screen.
- All CSV data created (saved) with the GP can be displayed with the CSV Data Display. The following table lists the CSV data created (saved) with the GP.

File Name	Data Type
ZL*****.CSV	Logging Data
ZT*****.CSV	Trend Graph Data
ZS*****.CSV	Sampling Data
ZA*****.CSV	Alarm Active/Block 1 Data
ZH*****.CSV	Alarm History/Block 2 Data
ZG*****.CSV	Alarm Log/Block 3 Data
ZR*****.CSV	Data for CSV Data Transfer

- CSV data created (saved) with the GP is displayed in the order in which files were created.

4.5.3 Setting Parameters

Information

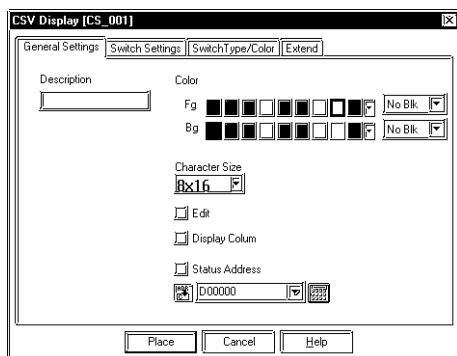

Description

Append the desired comment to the CSV Data Display.

Color

Select the colors for characters and the background color of the CSV Data Display between 64 and 256 colors. The color of the borderline is fixed at white.

Character Size

Specify the character size with the width-to-height ratio.

Edit

Setting the Data Editing to ON enables CSV data editing.

When editing data, you may specify the interlock bit address on the Extended Setting tab.

* This function is supported only by the GP2000 series units.

Display Column

When the Display Column is set to ON, the Line No. and Row No. will be displayed on the lines and rows of the CSV data.

Status Address

When the Status Address setting is enabled, "Outputting the Edited Data," "Printing" status or the error status of the CF card processing is set to the specified address.

◆ **About the Column Display**

The following chart shows the image of the CSV Data Display when the Column Display is enabled. When the Column Display is enabled, the column numbers are displayed continuously, even when the screen is scrolled.

	1	2	3	4	5
1		Date	Time	Data 0	Data 1
2	No. 1	01/12/05	09:00:00	123.4	780
3	No. 2	01/12/05	10:00:00	213.5	235
4	No. 3	01/12/05	11:00:00	149.8	54908
5	No. 4	01/12/05	12:00:00	-178.6	5683
6	No. 5	01/12/05	13:00:00	256.2	48562
7	No. 6	01/12/05	14:00:00	201.2	2019
8	No. 7	01/12/05	15:00:00	196.3	9560

Displays the Column No.

Displays the Column No.



Note: When the Column Display is enabled, the Column Numbers are displayed in uppercase characters. The Column Numbers are separated by 2-dot lines.

Example display of horizontally scrolled screen

	2	3	4	5	6
1	Date	Time	Data 0	Data 1	Da
2	01/12/05	09:00:00	123.4	780	10
3	01/12/05	10:00:00	213.5	235	20
4	01/12/05	11:00:00	149.8	54908	30
5	01/12/05	12:00:00	-178.6	5683	40
6	01/12/05	13:00:00	256.2	48562	50
7	01/12/05	14:00:00	201.2	2019	60
8	01/12/05	15:00:00	196.3	9560	70

* This function is supported only by the GP2000 series units.

◆ **About the Status Address**

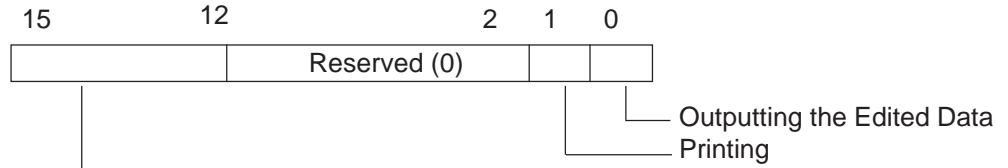

Error status

- 0: Transfer completed successfully.
- 1: Reserved
- 2: Reserved
- 3: Reserved
- 4: No CF card (No CF card is inserted, or the cover is open.)
- 5: CF card read error (Read-out from the CF card failed in a CF-to-PLC data transfer.)
- 6: CF card write error (Data writing failed in a PLC-to-CF data transfer.)
- 7: CF card error (CF card is invalid or the media inserted is not a CF card.)
- 8: Reserved

Outputting the Edited Data

This setting is turned ON when the ENT key is touched after CSV data editing, and it remains ON while the CSV data is read out to the CF card. While the edited data is being output, printing and editing modes are disabled.

Switching to off-line is also disabled while the edited data is being output.

Printing

This setting is turned ON while a printing operation is being executed. The printing and editing modes are disabled while a printing operation is being executed.

Switching to off-line is also disabled while a printing operation is being executed.

■ **Switch Settings**

Specify the type of Function Switch to be placed in the same operation. This tab is not displayed when the attributes of the CSV Data Display are changed.

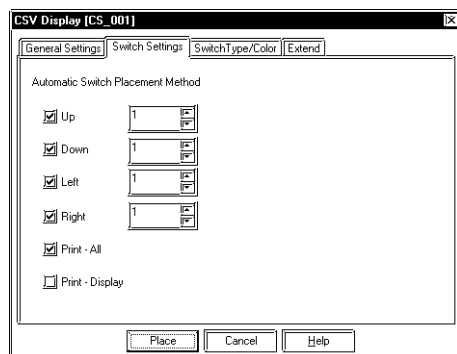

Up

Specify whether to place a switch to scroll the display up.

Down

Specify whether to place a switch to scroll the display down.

Right

Specify whether to place a switch to scroll the display to the right.

* This function is supported only by the GP2000 series units.

■ Switch Type/Color

Specify the shape and color of the Function Switch to be placed in the same operation. This tab is not displayed when the attributes of the CSV Data Display are changed.

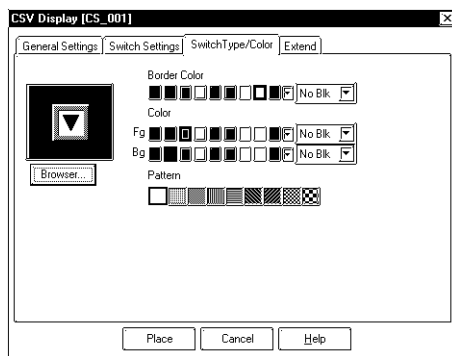

Left

Specify whether to place a switch to scroll the display to the left.

Print-All

Selecting this option will place a switch to print all CSV data on the CSV Data Display.

Print-Display

Selecting this option will place a switch to print the data currently being displayed.

Browser

Specify the shape of the switch.

Border Color

Specify the color for the frame of the switch. Border Color might be unselectable for some switches.

Color

Set the presence/absence in the Fg (foreground) and Bg (background) color settings. This option may not be displayed depending on the switch type selected.

Pattern

Set the presence/absence in the Pattern settings. This option may not be displayed depending on the switch type selected.

■ Extended Settings

This option is enabled only when Data Editing is enabled. Specify the Interlock operation mode for the CSV data editing with the Data Editing mode. Configure the Interlock function on the Extended Settings tab.

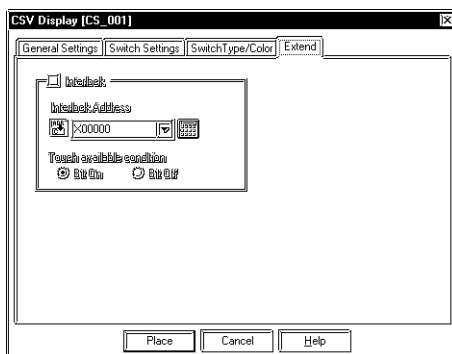

Interlock

Placing a check mark on this option enables the Interlock setting.

Interlock Address

Specify the Interlock Address here.

Touch-available Condition

Select a condition (ON or OFF) for the bit address specified in the Interlock Address setting under which touch operation is enabled.

* This function is supported only by the GP2000 series units.

4.5.4 CSV Data Display (Combination)

The details of the CSV data can be reviewed simply by pasting the Data Transfer Display/File Manager Display and the CSV Data Display on a Base screen of the GP.

■ Combining with Data Transfer Display

The combination of the CSV Data Display and Data Transfer Display displays the data of the CSV data function.

00000	Unit 1	CF->
00001	Unit 2	>CF
00002	Unit 3	UP
00003	Production Start Data	DOWN
00004	Production Stop Data	DISP
00005	Test Data	

1	2	UP	
1	:DATE	2002/04/16	DN
2	:GROUP No.	1	LF
3	:GROUP NAME	Unit 1	RT
4	ITEM NAME	VALUE	PRN
5	VALUE		
6		230	
7		300	
8		540	

CSV Display

Data Transfer Display

The screen displays the data of the CSV file specified with the Data Transfer Display. In the following example, touching the "DISP" switch will display the data of "00000: Unit 1" file specified with the Data Transfer Display.



- **The display will be cleared automatically when the CF card is removed or the cover of the CF-card slot is opened while the CSV file data is displayed with the CSV Data Display.**
- **Switching screens clears the data of the CSV Data Display.**

* This function is supported only by the GP2000 series units.

■ **Combination with the File Manager Display**

When the combination of the File Manager Display and CSV Data Display is used to display the CSV file of Logging Data, the screens will be as follows.

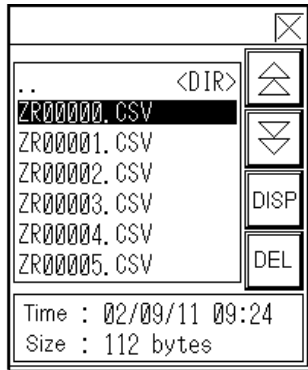

Disp

Data Transfer Display

1	2	UP
1	:DATE	2002/04/16
2	:GROUP No.	1
3	:GROUP NAME	Unit 1
4	ITEM NAME	VALUE
5		300
6		230
7		300
8		540
		PRN

CSV Display

The screen displays the data of the CSV file specified with the File Manager Display. In the following example, touching the "DISP" switch will display the data of the "ZR00000.CSV" file specified with the File Manager Display.

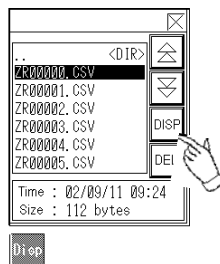

Disp

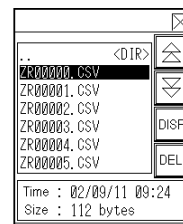
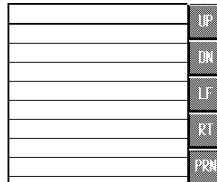

Disp

1	2	UP
1	:DATE	2002/04/16
2	:GROUP No.	1
3	:GROUP NAME	Unit 1
4	ITEM NAME	VALUE
5		300
6		230
7		300
8		540
		PRN



- **The display will be automatically cleared when the CF card is removed or the cover of the CF-card slot is opened while the data of the CSV file is displayed with the CSV Data Display.**
- **Switching screens clears the data of the CSV Data Display.**

■ **Cautions about the display**

- When a file is updated with other functions (such as executing CSV data transfer function from a PLC to a CF card) while its CSV data is displayed, the data will be displayed again. In this case, the data will be displayed starting from the beginning of the file.
- Up to 100 characters can be entered in each cell. Text exceeding the limit will not be displayed.

* This function is supported only by the GP2000 series units.

- The outer borders of the CSV Data Display are 2-dot lines, and the inner borders are 1-dot lines.
- 2-dot spaces are left between the borders separating the cells and the data in the cells.

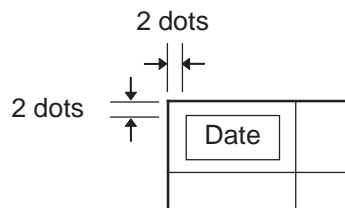

- The height of the cell will be automatically adjusted depending on the height of the character assigned to the cell. (The text size is set to 2 x 1 in the example below.)

1	2	UP
1:DATE	2002/5/1 1	DN
2:GROUP NAME		LF
3:GROUP No.	1	RT
4:GROUP NAME		PRN

- The width of each cell will be automatically adjusted depending on the text width to be displayed. However, when the number of characters is five or less, the width is set to a width of five characters.
- When the text in the rightmost column is too long to be fit in the cell, only the characters within the predetermined width are displayed. Text that extends beyond the cell will not be displayed. To display the hidden portion of the text, use the "LF" or "RT" switches to scroll the screen.
- The display of the text in each cell is fixed as left-aligned.

◆ Valid Data Format

- Data delimited by [""] (double quotation marks), and separated by [,] (commas)

```

"", "Date", "Time", "Data 0", "Data 1"
"No. 1", "01/12/05", "09:00:00", "123.4", "780"
"No. 2", "01/12/05", "10:00:00", "213.5", "235"
    
```

- Data delimited by [,] (commas)

```

, Date, Time, Data 0, Data 1
No. 1, 01/12/05, 09:00:00, 123.4, 780
No. 2, 01/12/05, 10:00:00, 213.5, 235
    
```

* This function is supported only by the GP2000 series units.

4.5.5 CSV Data Editing Function

Touching the desired cell on the CSV Data Display automatically displays a pop-up keyboard on the screen, enabling the editing operation.

■ Editing Function

To edit the CSV data, directly touch the cell you want to edit. When the screen enters Edit mode, a pop-up keyboard appears on the screen and the data in the selected cell is displayed in the editing area on the top of the screen. Touching the ENT key confirms the editing and closes the pop-up keyboard. The CSV file is saved in the CF card.

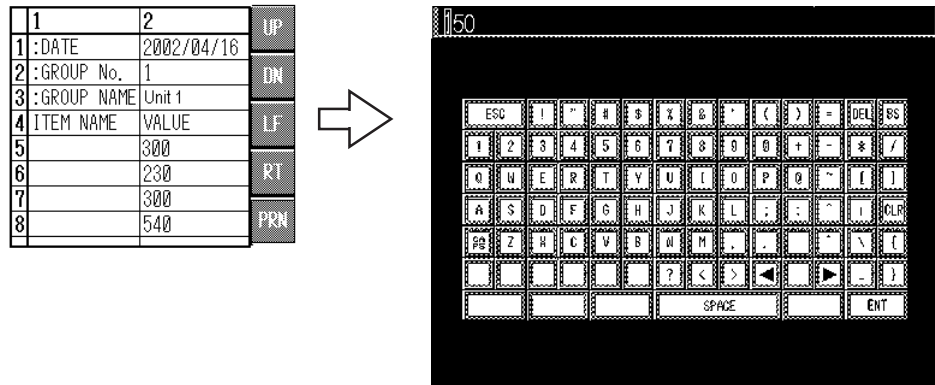

Note: Touching the Caps key allows you to input lower-case characters. In this case, the switch is displayed in reverse video. Touching the Caps switch again returns to uppercase input mode. The status of the Caps key is reset when Edit mode is canceled. The status is also canceled when the keypad screen is switched on a mid-size unit.

◆ The following table shows the maximum number of characters that can be edited by each model.

Model	Maximum editable number of characters	Model	Maximum editable number of characters
GP2300 Series	36	GP2300 Series (Vertical type)	24
GP2301 Series		GP2301 Series (Vertical type)	
GP2301H Series		76	GP2400 Series (Vertical type)
GP2400 Series	GP2401 Series (Vertical type)		
GP2401 Series	GP2500 Series (Vertical type)		
GP2401H Series	GP2501 Series (Vertical type)		72
GP2500 Series	GP2600 Series (Vertical type)		
GP2501 Series	96	GP2601 Series (Vertical type)	
GP2600 Series			
GP2601 Series			

* This function is supported only by the GP2000 series units.



- **The pop-up keyboard for editing uses a local window. If two other local windows are already open, it cannot be displayed. In this case, close one of the windows when you want to edit to data.**
 - **When editing CSV data with a Utag window, do not specify the "High Speed" in the Window setting for the U tag. Otherwise, the pop-up keyboard for editing won't be displayed.**
 - **The CF card data-saving function (the function that retrieves data from backup SRAM, converts it into CSV format, and saves it to a CF card) is disabled during the editing operation. If this function is attempted, the CF card data holding function activates and a write error occurs.**
 - **The data can be edited even if not all data in the cell you want to edit is displayed. In this case, the data editing area displays the hidden portion of the data as well.**
 - **When the Column Display is enabled, the Column Numbers cannot be edited.**
 - **Data inputs are processed as text strings. Therefore, the properties of the inputs such as the number of digits, 16/32 bit length, and decimal/hexadecimal format will not be checked.**
 - **When the Interlock setting is enabled in Edit mode, editing can be performed. However, if editing is attempted again, the screen will not enter Edit mode because the Interlock setting is enabled.**
 - **The system cannot be switched to off-line mode while the edited data is being output to CSV files.**
 - **A temporary file is created after the editing is confirmed in an edit operation. Therefore, editing cannot be performed unless the system has an amount of free space equivalent to or larger than the file to be edited.**
- Example: Editing "ZR0001.CSV"**
- (1) **When touching the ENT key, name the edited file "_CSV\$\$_0.TMP".**
 - (2) **Change the original file name from "ZR00001.CSV" to "_CSV\$\$_1.TMP"**
 - (3) **Change the name "_CSV\$\$_0.TMP" into the original file name "ZR00001.CSV".**
 - (4) **Delete the "_CSV\$\$_0.TMP".**
- If the power turns OFF during editing or editing fails, the "_CSV\$\$_0.TMP" and the "_CSV\$\$_1.TMP" will not be deleted.**
- **When CSV Data Display is rotated by 90° or 180°, the pop-up keyboard for editing operation will not be displayed properly. When performing data editing, use the CSV Data Display rotated by 0° or 270°.**

* This function is supported only by the GP2000 series units.

4.5.6 Printing CSV Data

To print the CSV data displayed on the screen, touch the Print key on the CSV Data Display. The print format can be selected as either "Print-All" (prints all CSV data) or "Print-Display" (prints only the CSV data currently being displayed).

■ Print-All

This print mode prints all CSV data on the CSV Data Display.

Example: Printing the CSV data of Logging Data

	Date	Time	Data 0	Data 1
No. 1	01/12/05	09:00:00	123.4	780
No. 2	01/12/05	10:00:00	213.5	235
No. 3	01/12/05	11:00:00	149.8	54908
No. 4	01/12/05	12:00:00	-178.6	5683
No. 5	01/12/05	13:00:00	256.2	48562
No. 6	01/12/05	14:00:00	201.2	2019
No. 7	01/12/05	15:00:00	196.3	9560
No. 8	01/12/05	16:00:00	230.3	2354



Note: The horizontal lines are not printed.

The portion of the data not currently shown on the CSV Data Display will be printed.

	Date	Time	Data 0	Data 1	Data 2	Data 3
No. 1	01/12/05	09:00:00	123.4	780	10	110
No. 2	01/12/05	10:00:00	213.5	235	20	120
No. 3	01/12/05	11:00:00	149.8	54908	30	130
No. 4	01/12/05	12:00:00	-178.6	5683	40	140
No. 5	01/12/05	13:00:00	256.2	48562	50	150
No. 6	01/12/05	14:00:00	201.2	2019	60	160
No. 7	01/12/05	15:00:00	196.3	9560	70	170
No. 8	01/12/05	16:00:00	230.3	2354	80	180
No. 9	01/12/05	17:00:00	-140.2	4480	100	190
No. 10	01/12/05	17:00:00	780.3	870	110	200
No. 11	01/12/05	18:00:00	-140.2	540	120	210

* This function is supported only by the GP2000 series units.



- **The Column No. will not be printed regardless of the ON/OFF status of the Column Display setting.**
- **Up to 160 characters can be printed in a single line. Any text exceeding 160 characters will be cut off.**

■ Print-Display

This print mode prints the portion of CSV data currently displayed on the CSV Data Display.

Example: Printing the CSV data of Logging Data

	Date	Time	Data 0	Data 1
No. 1	01/12/05	09:00:00	123.4	780
No. 2	01/12/05	10:00:00	213.5	235
No. 3	01/12/05	11:00:00	149.8	54908
No. 4	01/12/05	12:00:00	-178.6	5683
No. 5	01/12/05	13:00:00	256.2	48562
No. 6	01/12/05	14:00:00	201.2	2019
No. 7	01/12/05	15:00:00	196.3	9560
No. 8	01/12/05	16:00:00	230.3	2354



Note: • The horizontal lines are not printed.

Only the portion of data currently shown on the CSV Data Display will be printed.

No. 1	Date	Time	Data 0	Data 1
No. 1	01/12/05	09:00:00	123.4	780
No. 2	01/12/05	10:00:00	213.5	235
No. 3	01/12/05	11:00:00	149.8	54908
No. 4	01/12/05	12:00:00	-178.6	5683
No. 5	01/12/05	13:00:00	256.2	48562
No. 6	01/12/05	14:00:00	201.2	2019
No. 7	01/12/05	15:00:00	196.3	9560
No. 8	01/12/05	16:00:00	230.3	2354

* This function is supported only by the GP2000 series units.



- **The Column No. will not be printed regardless of the ON/OFF status of the Column Display setting.**
- **Up to 160 characters can be printed in a single line. Any text exceeding 160 characters will be cut off.**
- **If the data in the rightmost cell extends beyond the screen and is cut off on the CSV Data Display, the rightmost cell will be cut off on the printout.**
- **The system cannot be switched to off-line mode during the printing operation.**

* This function is supported only by the GP2000 series units.

4.6 File Manager Display Function

4.6.1 Overview

The File Manager Display displays information on the files contained on the CF card in a pop-up window. Touching the startup switch of the File Manager Display displays the information in a pop-up window. Touching the startup switch again closes the pop-up window. Information on the CSV data can be displayed with a combination of the File Manager Display and CSV Data Display.

Reference *"4.5.4 CSV Data Display (Combination)"*.

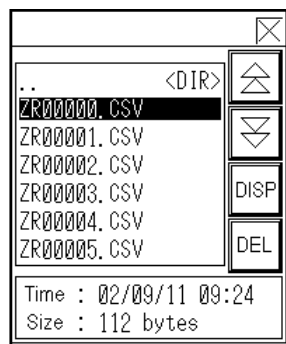

Disp

File Manager Display

1	2	UP
1	:DATE	2002/04/16
2	:GROUP No.	1
3	:GROUP NAME	Unit 1
4	ITEM NAME	VALUE
5		300
6		230
7		300
8		540
		PRN

CSV Data Display

4.6.2 Details

- The File Manager Display cannot be scaled up or down.
- Specify the initial position of the display in 40-dot increments for the X coordinate, and in 20-dot increments for the Y coordinate. If the File Manager Display is placed in a position other than the initial setting, it won't be displayed in the exact position where it was displayed when creating the screen with the PRO/PB III because the GP corrects the display position.
- When the File Manager Display is activated, the root folder of the CF card will be displayed.
- When the GP Type is set to "Portrait Display," the File Manger display is displayed in portrait orientation.

* This function is supported only by the GP2000 series units.

4.6.3 Setting Parameters

■ Information

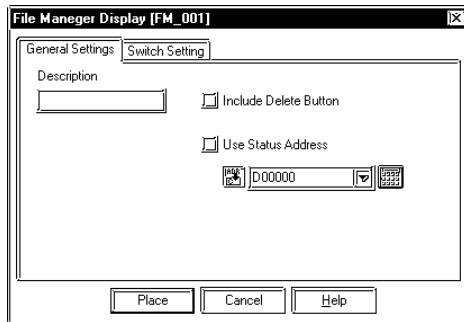

Description

Append the desired comments to the File Manager Display.

Include Delete Button

When this option is selected, a switch for deleting the selected CSV file will be placed.

Use Status Address

When a check mark is placed in this box, the Status Address setting is enabled.

◆ About the Status Address

The following shows the error information that is written in the predetermined word address.



Error status

- 0: Operation completed successfully
- 1: Reserved
- 2: Reserved
- 3: Reserved
- 4: No CF card (No CF card is inserted, or the cover is open.)
- 5: CF card read error (Read-out from the CF card failed in a CF-to-PLC data transfer.)
- 6: Reserved
- 7: CF card error (CF card is invalid or the media inserted is not a CF card.)
- 8: CF card deletion error (File deletion has failed.)

* This function is supported only by the GP2000 series units.

◆ Switch Settings

Configure the parameters for the Display switch used to call up the File Manager Display as a pop-up window.

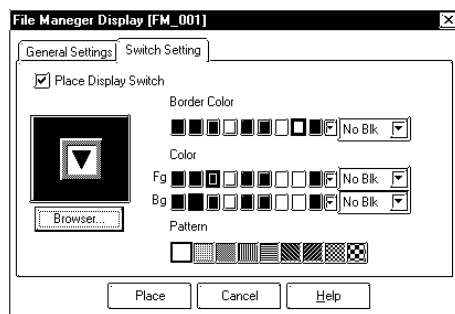

Place Display Switch

Put a check mark in the box to set up the Display switch.

Browser...

Specify the shape of the Display switch.

Border Color

Specify the color for the frame of the Display switch. This option may not be displayed depending on the switch type selected.

Color

Set the presence/absence in the Fg (foreground) and Bg (background) color settings. This option may not be displayed depending on the switch type selected.

Pattern

Set the presence/absence in the Pattern settings. This option may not be displayed depending on the switch type selected.



Note:

The Display switch of the File Manager Display can be set up on the screen with the following procedures: On the File Manager Display dialog box, select the "Switch Settings" tab and put a check mark in the "Place Display switch" option; or, select the "File Manager Display" via "Parts"/"Function Switch" on the Screen Editor.

* This function is supported only by the GP2000 series units.

4.6.4 File Manager Display Function

■ Display function of the File Manager Display

The following screen appears when the File Manager Display is activated.

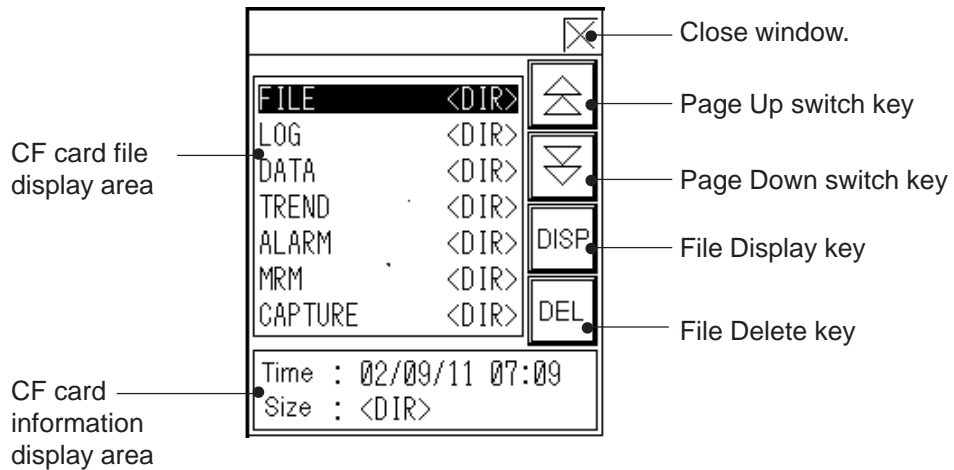

CF card file display area

Displays the folder name of file name on the CF card. <DIR> signs are displayed next to the folder names.

Up to seven folder or file names can be displayed at one time. To select the folder or file, touch the desired folder or file in this area. Touch the selected folder or file again to deselect the folder or file.

CF card information display area

Displays the "time stamp" and "file size" of the selected file. The "file size" is not displayed when a folder is selected.

Close Window

Use this button to close the CF card File Manager window.

Page Up switch key

Use this key to switch to the previous page.

Page Down switch key

Use this key to switch to the following page.

File Display key

Use this key to display the content of the selected folder or file. A CSV file can be display with the CSV Data Display.



Note: When activated, the File Manager Display is displayed in front of all other windows. If the File Manager Display overlaps the Window screen, touch the Display or Window to switch the order. However, if a Touch-key has been placed in the location you have touched, the display order will be switched after the Touch operation is processed.

* This function is supported only by the GP2000 series units.

◆ **Names of files stored on a CF card and processing procedures**

The following table lists the folder names and file names stored on a CF card.

	Folder Name/File Name		Description of process carried out when File Display key is touched
Folder	\\FILE, \\LOG, \\DATA, \\CAPTURE, \\MRM, \\TREND, \\ALARM, \\SRAM		Displays file names in each folder.
File	ZF****.BIN	Filing Data	No display
	ZL****.CSV	Logging Data	Content of CSV data can be displayed on CSV Data Display.
	ZI****.BIN	Image Screen	No display
	ZO****.BIN	Sound Data	No display
	CP****.JPG	Screen Capture Video Capture	No display
	ZC****.MRM	GP Backup Data (MRM file)	No display
	ZT****.CSV	Trend Graph Data	Content of CSV data can be displayed on CSV Data Display.
	ZS****.CSV	Sampling Data	Content of CSV data can be displayed on CSV Data Display.
	ZA****.CSV	Alarm Active/Block 1 Data	Content of CSV data can be displayed on CSV Data Display.
	ZH****.CSV	Alarm History/Block 2 Data	Content of CSV data can be displayed on CSV Data Display.
	ZG****.CSV	Alarm Log/Block 3 Data	Content of CSV data can be displayed on CSV Data Display.
	ZR****.CSV	Data for CSV Data Transfer	Content of CSV data can be displayed on CSV Data Display.
	ZD****.BIN	Backup SRAM Data	No display



- **A local window is used for the File Manager Display. If two other local windows are already displayed on the screen, the File Manager Display cannot be activated. Close either local window and touch the Display switch to bring up the File Manager Display.**
- **If more than one Display switch for File Manager Display is set up on a single screen, only one File Manager Display will function. Touching another Display switch while the File Manager Display is displayed will close the File Manager Display window currently displayed.**
- **If using the File Manager Display together with the U-Tag window, do not select the "High Speed" option on the "Designated Window" setting tab for the U-tag. Otherwise, the File Manager Display will not function properly.**

* This function is supported only by the GP2000 series units.



- **The File Manager is turned OFF while the tables of the index text are being switched. To activate the File Manager again, touch the startup key again.**
- **Do not set up a startup switch on a window. If a startup switch is located on a window, the CF Card File Manager will not be activated.**
- **A startup switch for the File Manager can be located on the base screen only.**

■ Operation procedure for the CF Card File Manager

This section describes the procedures for displaying the files in a folder, or for using the CSV Data Display to display the CSV data.

◆ Touching the File Display key while a folder is selected

If the File Display key is touched while a folder is selected, the contents of the folder will be displayed. Select the ".." column and touch the DISP (display) key to display a folder in a higher directory.

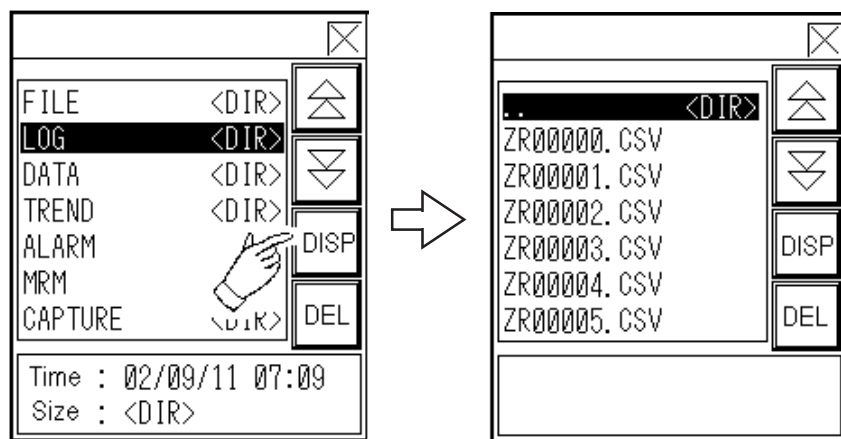

* This function is supported only by the GP2000 series units.

◆ **Touching the File Display key while a CSV file is selected**

Touching the File Display key after selecting a CSV file when the CSV Data Display is set up displays the contents of the CSV data with the CSV Data Display.

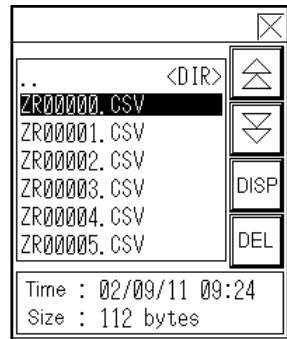

Disp

1	2	
1		UP
2		DN
3		LF
4		RT
5		PRN
6		
7		
8		

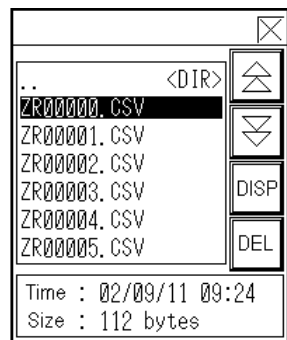

Disp

1	2	
1	:DATE	2002/04/16
2	:GROUP No.	1
3	:GROUP NAME	Unit 1
4	ITEM NAME	VALUE
5		300
6		230
7		300
8		540



Note: • If the File Display key is touched after a file other than the CSV data is selected, the contents of that file will not be displayed.

- If the File Display key is touched on the screen on which no CSV Data Display is set up, no CSV Data Display will appear.

* This function is supported only by the GP2000 series units.

◆ **File Delete key**

Use this key to delete the selected file. When this key is pressed to delete a file, the following confirmation message appears on the screen.

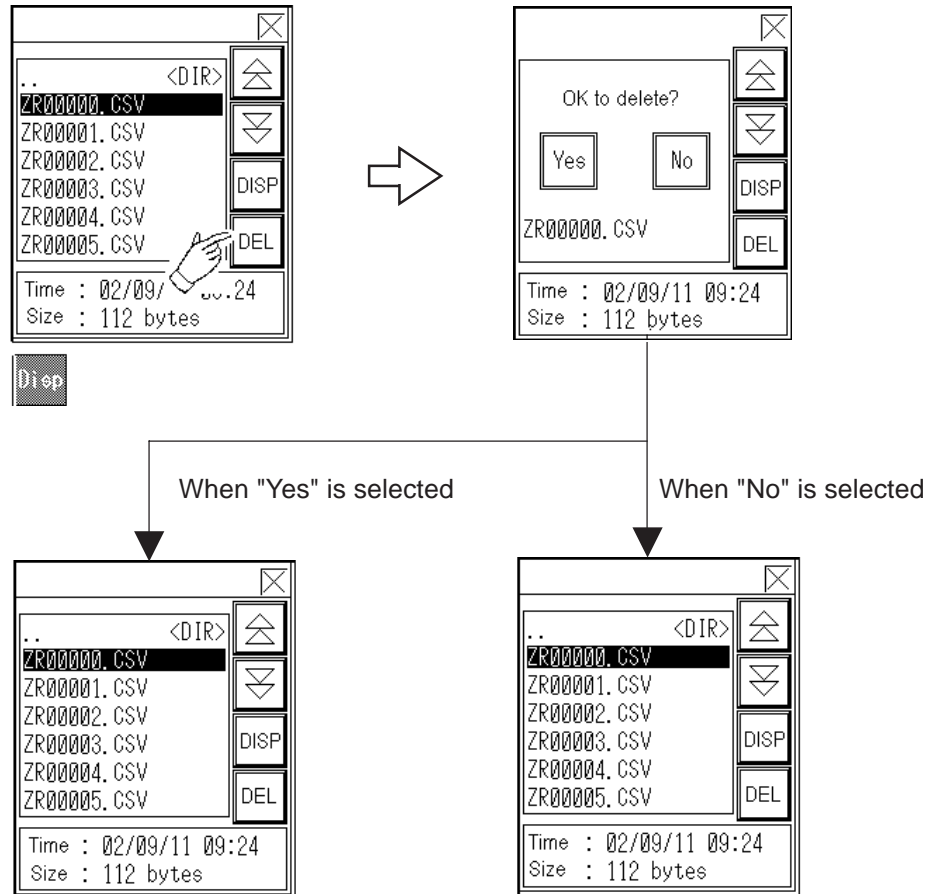

The file deletion operation does not delete read-only files.

* This function is supported only by the GP2000 series units.

◆ Moving the File Manager Display

The File Manager Display can be moved with the following procedure.

1. Touch the top area of the File Manager Display.

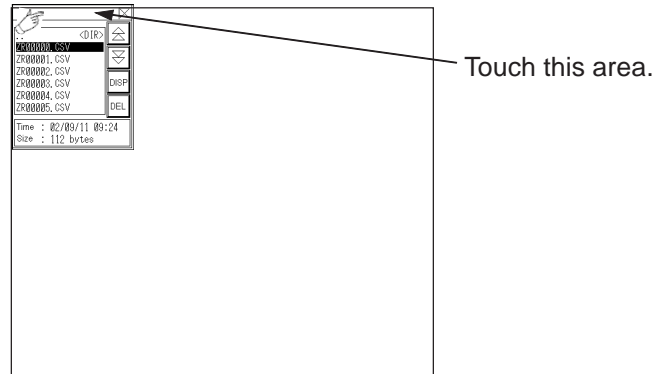

2. Touch the desired location on the screen to which you want to move the File Manager Display. The File Manager Display moves to the specified position.

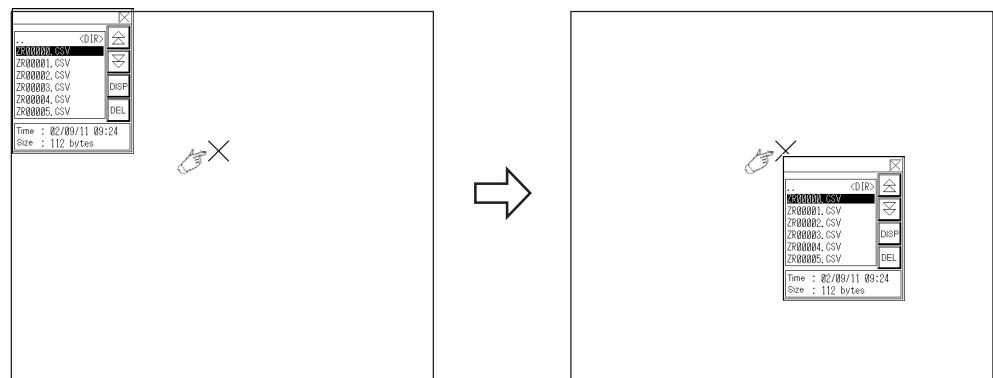

Note: Touching the location where you want to move the File Manager Display specifies the start position for the display. The File Manager Display will be displayed beginning at that point. If the X coordinate of the designated point cannot be divided into 40-dot increments, the File Manager Display will be displayed starting from the nearest possible coordinate that can be divided by 40 dots. The Y coordinate is displayed in 20-dot increments.

- If the window cannot be displayed at the position specified with the Initial Display Position (the window is out of the screen), the coordinates will be adjusted so that the window can be displayed.
- If the window cannot be displayed at the position to which you want to move the File Manager Display (the window is out of the screen), the coordinates will be adjusted so that the window can be displayed.

* This function is supported only by the GP2000 series units.

4.7 Using the CF Card

4.7.1 Overview

The GP77R series (with an optional Multi Unit attached to the GP main unit) and GP2000 series supports the use of CF Cards. The GP-2000 series does not require optional Multi Units.

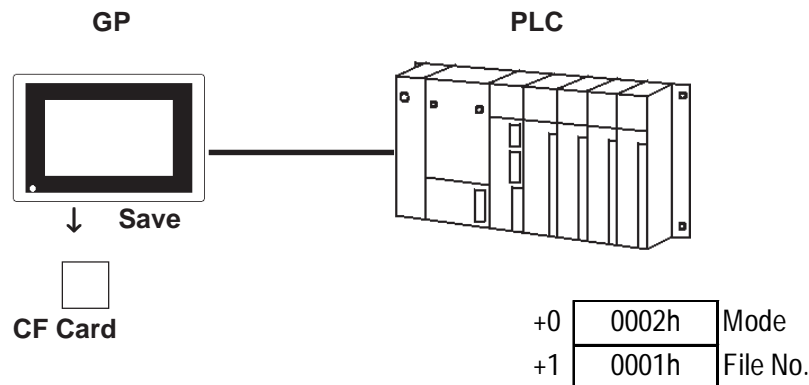

4.7.2 CF Card Features

- ◆ A large volume of image screens and sound data files can be stored on a CF Card, and, via the optional Multi Unit, displayed on/used by the GP unit. An external storage device is required. Filing Data can be saved on the CF Card, and then transferred to the GP unit whenever necessary.

Reference 4.2 “Filing Data (Recipe) Function”

- ◆ All Alarm data, trend graph data, sampled data, and logged data can be saved as CSV files (*.CSV). The saved data can be used for databases and other purposes by transferring it your PC.
- ◆ Screen data can be saved as backup files (*.MRM), which can be then copied to other GP units.
- ◆ Screen capture is possible with all GP2000 Series units. Video screen capture is possible only with GP2500T/GP2600T units equipped with an optional VM unit.

Reference 4.7.10 Screen Capture

4.7.3 CF Card Usage Cautions

Optional Multi Unit is required

- The CF Card can only be used with Digital's GP77R and GP2000 series units. To use the CF Card, please attach the Multi Unit (sold separately) to your GP. For the GP2000 series, the Multi Unit (sold separately) is unnecessary.
- The GP unit used to save data must have its GP system and protocol files set up in advance.

Precautions when saving data

- When the CF Card is initialized by the GP unit, folders will be created automatically. The data transferred to the CF Card is saved in the following file formats.

Folder	Data Saved	File Name
\file	Filing Data	ZF****.BIN
\log	Logged data	ZL****.CSV
\data	Image screens	ZI****.BIN
	Sound data	ZO****.BIN
\mrm	GP backup data (MRM files)	ZC00001.MRM (fixed)
\trend	Trend graph data	ZT****.CSV
	Sampled data	ZS****.CSV
\alarm	Alarm data	
	·Active or block-1 data	ZA****.CSV
	·History or block-2 data	ZH****.CSV
	·Log or block-3 data	ZG****.CSV
\Sram	CSV data transfer data	ZR****.CSV
	Backup SRAM data	ZD****.BIN

- When the Filing data "Multiple Folders" setting is not used, the number of folders is fixed to "1".

4.2 Filing Data (Recipe) Function

- The file numbers can be set:
 - from 1 to 8999 (when using Filing data)
 - from 0 to 65535 (when using data other than Filing data)
 Select or deselect Use Multiple Folders in the Filing data setting area.
- CF Card data file names must be 8 single-byte characters or less. These file names, however, are not compatible with the FAT32 file naming system.
- When storing new data in a CF Card that will require the overwriting of old data, the CF Card's available capacity (amount of free space) must be larger than the size of the data to be stored, since the new data is written before the old data is deleted.
- Enable screen capture with "GP System Settings."

4.7.10 Screen Capture



Note: Enable video capture with a v-tag.

2.28 v-tag (Extended Video Window Display)

■ Precautions when accessing the CF Card

The data on the CF Card may be corrupted if any of the following actions occur during access between the GP unit and the CF Card:

- Turning OFF the GP unit
- Resetting the GP unit
- Inserting or removing the CF Card

To prevent data problems, it is recommended that you prepare in advance a special screen in your project. This screen will be used only for CF Card access and will prevent the GP unit from inadvertently accessing the CF Card. This will also ensure that none of the previous actions are taken before you can check the GP/CF Card's access status.

This type of access monitor screen is shown below:

This screen enables you to check whether data is being loaded to the CF Card. After making sure on this screen that no data is now being loaded to the CF Card, you can then turn OFF the GP unit, reset it, or insert/remove the CF Card.

◆ Example

<Creating the GP Screen>

- (1) Call up a new Base screen, and create a touch-key. Set this touch-key so that it turns an arbitrary PLC bit (i.e. "A") ON.
- (2) Create a library for messages on another Base screen, and register a message saying "Ready to turn the GP unit OFF."
- (3) Go back to the screen where you created the touch-key, and add an L-tag. As the trigger bit for the L-tag, use an arbitrary bit (B) on the PLC, and set it so that it calls up the library screen created in step (2).

<PLC Program>

- (1) Check that the touch key's bit A has been turned ON.
- (2) Check the control word address specified by selecting [GP Setup] - [Extended Settings] - [CF Card Data Storage Settings] to ensure that no data is now being loaded. When the lower eight bits in the control word address read "00", data loading is not being performed.
- (3) After checking that the loading is not in progress, turn ON the trigger bit B for the L-tag.

A message will appear on the GP's screen.

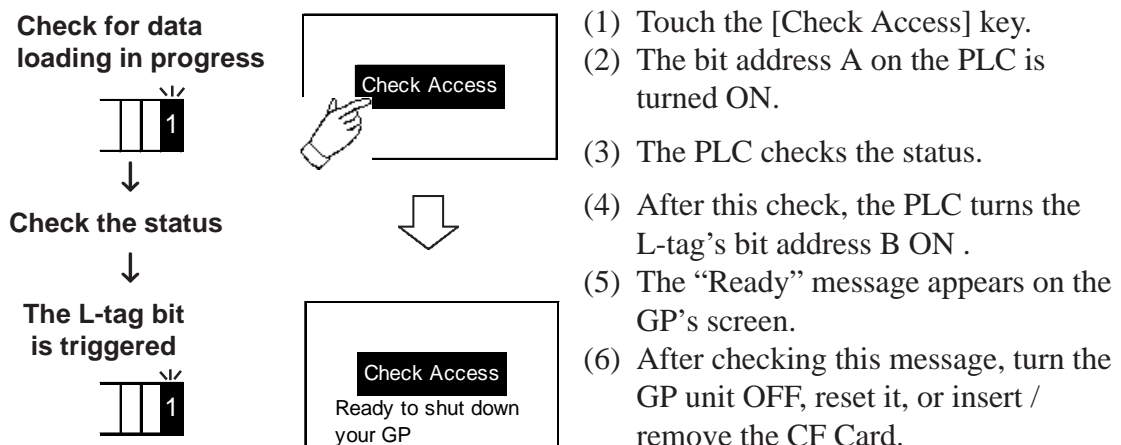

Other Precautions

- When corrupted data on the CF Card cannot be restored
In this case, you will need to re-format the CF Card. Be sure to back up all CF Card data as often as possible, in the event the data becomes unreadable.
- To read CF Card data on your PC, your PC must be equipped with a PC card slot. Insert the CF Card into your PC card CF Card adapter and then insert the adapter into your PC's PC card slot.
- If the CF Card is not inserted into the GP's Multi Unit, do not call up any project screen that uses CF Card data.

4.7.4 External Storage of GP-PRO/PB III data

The procedures for using the CF Card as an external storage device are as follows:

- (1) Prepare the CF Card data output folder.
 - (2) When drawing an object, specify in the image screen, sound data, and filing data settings that the data is to be saved to a CF Card. Data will then be temporarily saved in the CF Card data output folder.
- Reference** 4.2 Filing Data (Recipe) Function, 4.1 Sound Output
- (3) Transfer the project file to the GP unit. The data saved in the CF Card output folder will be transferred to the CF Card, and all other data to the GP's internal memory.
 - (4) During normal GP operation, the data will be loaded from the CF Card whenever necessary.

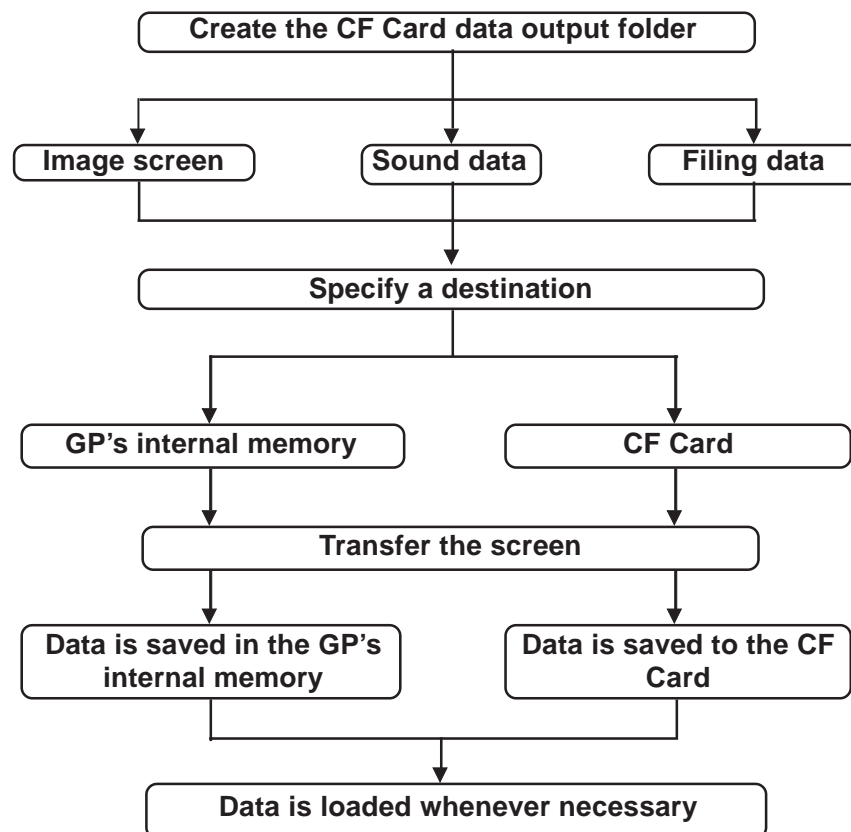

4.7.5 CF Card Data Output Folder Settings

To save data to the CF Card, you need to specify a location (CF Card data output folder) to temporarily save this project data. If you specify the CF Card as the destination of image screen data, sound data, or filing data, it will be output to the CF Card data output folder specified here.

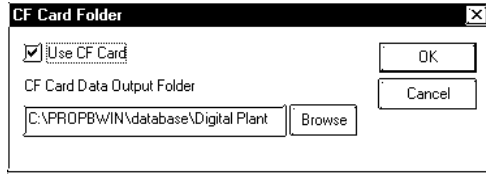

Select [CF Card Folder] from Project Manager's [Project], and check (select) [Use CF Card]. Specify any existing folder, enter its name or click on the [Browse] button to select that folder.

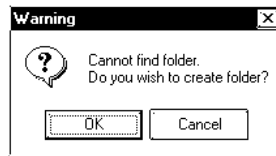

If you specify the CF Card as the destination before selecting [CF Card Folder], one of these messages will appear.

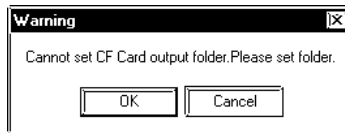

4.7.6 Transferring Data from Output Folder to CF Card

The data saved in the CF Card data output folder is transferred to the GP's CF Card when the project file is transferred to the GP unit. However, to transfer your project's filing data to the CF Card, you will need to select [Filing Data (CF Card)] in the Transfer Settings dialog box.

Reference *Operation Manual, 7.2 "Transferring Screens"*

Transfers Filing Data to the CF Card

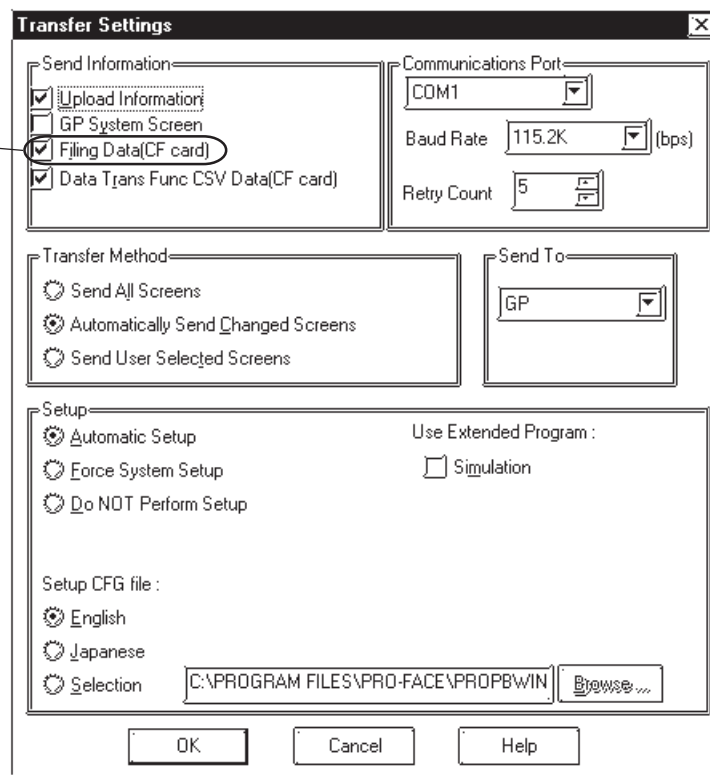



- When data is transferred to the CF Card, any file with the same name will be overwritten, and any file (with a new name) will be saved normally. Therefore, if project data is changed and then transferred to the GP, the previously transferred image screen and sound data files for that project are still remaining on the CF Card.
- When “Memory Link Ethernet Type” is designated as a Device/PLC Type, screen data cannot be transferred to a CF Card.

4.7.7 Using the GP’s OFFLINE Mode

This section describes various actions related to using the CF Card, via the GP’s OFFLINE mode. In OFFLINE mode, the CF Card is initialized and the screen data downloaded to the GP is backed up.

Reference For details, refer to your *Multi Unit Users Manual*



- Unless the Multi Unit (sold separately) is installed in your GP unit, the menu for the CF Card will not appear.
- Prior to using the GP’s OFFLINE Mode, be sure to send the system data to the GP unit using the screen editor software.

■ Initializing the CF Card

You can initialize the CF Card’s memory via the GP’s OFFLINE Mode feature.

Reference your *Users Manual* and *Multi Unit Users Manual*

■ Screen Data Backup

Screen data can be backed up as *.MRM files on the CF Card. These backup files can be returned to the source GP unit or to another GP unit so that their screen data can be used there.



Note: Only one project’s data can be saved on a single CF Card.

◆ Creating a Backup File on the CF Card

A backup file can be created on the CF Card by designating SCREEN DATA TRANSFER ‘s “COPY TO CF CARD” selection in the GP’s OFFLINE Mode.

◆ Copying the Backup File from the CF Card to the GP Unit

A backup file on the CF Card can be copied by designating SCREEN DATA TRANSFER ‘s “COPY FROM CF CARD” selection in the GP’s OFFLINE Mode.

4.7.8 Transferring Data from Backup SRAM to CF Card

Any alarm data, trend graph data, logging data, and sample data stored in backup SRAM during GP unit operation can be saved as CSV files (*.CSV) on the CF Card. This data can be transferred from the GP's backup SRAM to the CF Card by writing an appropriate command to a control address. All CSV files saved on the CF Card can then be loaded into your PC and used for a database by selecting [Transfer] - [Upload Stored Data of CF Card] or by using the CF Card Tool.

To transfer CSV file data stored in the GP's backup SRAM to the CF Card you will need to write a command to a designated control address.

■ **Specifying a Control Address**

To specify a control address, select [GP Setup] - [Extended Settings].

▼ **Reference** ▲ *Operation Manual, 6.2 Menu Setting Items: GP Setup*

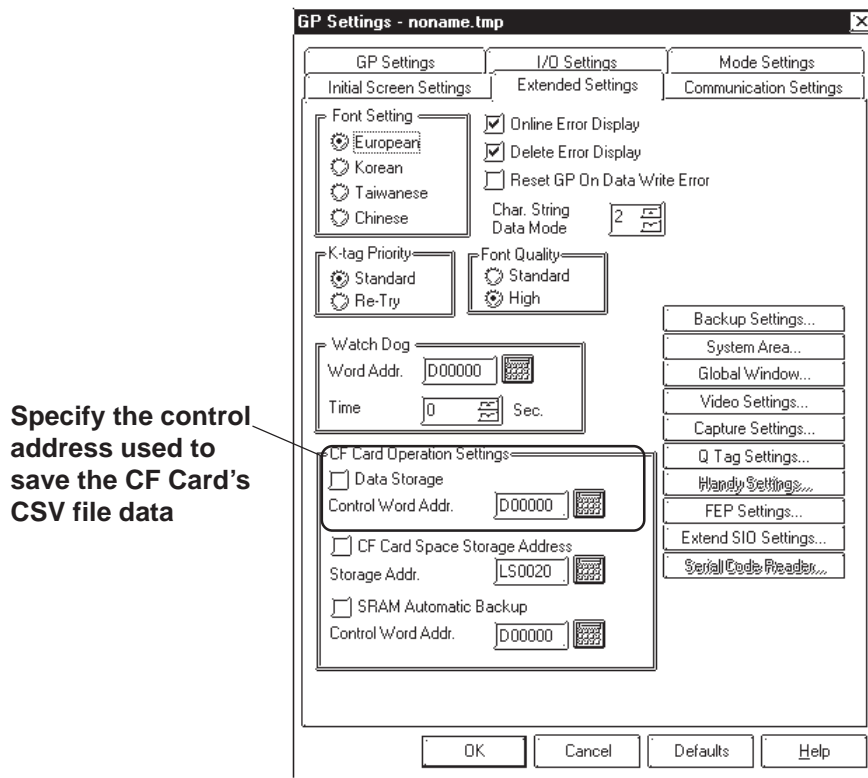

■ **Transferring Data to the CF Card**

The control address is divided into the Mode section - to which a command and a status code can be entered, and the File Number section, where the name of the data file is specified.

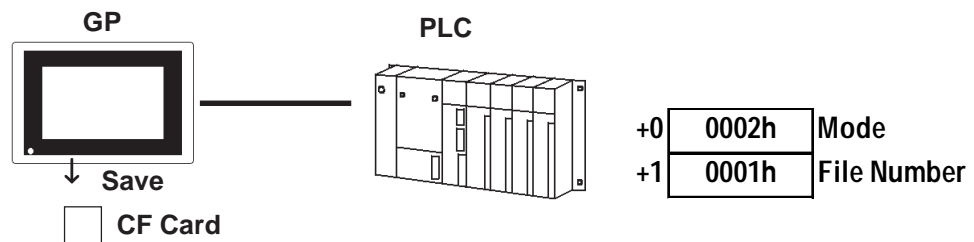

◆ **Mode**

When a command is written to the Mode section's address, the corresponding operation will be performed and its result (status) will be stored.

Mode	Word Data	Description
Command	0001h	Filing Data
	0002h	Logging data
	0003h	Trend graph data
	0004h	Sampling data
	0005h	Alarm active/block-1 data
	0006h	Alarm history/block-2 data
	0007h	Alarm log/block-3 data
	0020h	Logging loop auto-save start
	0021h	Logging loop auto-save finish
Status	0000h	Completed successfully
	0100h	Write error
	0200h	Multi Unit not installed/CF Card not inserted/CF Card access switch OFF
	0300h	No data to be loaded (when no data is specified)
	0400h	File No. Error
	2000h	Logging loop auto-save responding correctly Control Address becomes this value during the auto-save mode. When the value is changed, the auto-save mode finishes.



After the Status data is read out from the GP, before the next command can be written be sure to allow time of at least one communication cycle or one Tag Scan Time period, whichever is longer.

◆ **File Number**

Specify a file number prior to writing a command. The file numbers can be set:

- "1" fixed (when not using Multiple Folders via Filing data)
- from 1 to 8999 (when using Multiple Folders via Filing data)
- from 0 to 65535 (when using data other than Filing data)



- **When data is saved on the CF Card, a folder will be automatically created to save it if there is no specific folder (like \file or \log). However, if no folder can be created (because the CF Card has not been initialized, etc.), a write error will occur.**
- **If a write error occurs, any file that has not finished loading may remain on the CF Card.**



- **It may several seconds to write data depending on the amount.**
- **Tag- and screen-related operations may become slower during the writing of data.**

◆ **Logging Loop Auto Save**

When using the loop feature, the CF Card data write function will operate as follows. Logging data can also be written to the CF Card automatically when the GP's File Full Bit Address turns ON. The file is in CSV format.

• **Starting Auto Save**

When saving logging data to the CF Card in auto save mode and using the loop feature, designate the file number and write 0020h to the mode.

When the GP enters auto save mode normally, the GP writes 2000h to the mode. Only while the mode value is 2000h will auto save mode continue, and when this value changes, auto save mode will end. Therefore, to continue to use this mode, DO NOT change this value. To quit auto save, use the following auto save exit command.

• **Exiting Auto Save**

To exit auto save mode, write 0021h to the mode. When the GP performs auto save quit processing normally, the GP writes 0000h to the mode. When performing auto save quit processing, logging data will be written to the CF Card up to the latest backup SRAM data. Also, when starting or resuming auto save, Block name data and logging data are written to the CF Card from the beginning of the loop, regardless of the previous data save status.

Logging Data (Backup SRAM data)

(1) to (6) indicate logging data.

(1)
(2)
(3)

Quitting auto save in this case causes logging data to be written in (1), (2), and (3) order.

(5)
(6)
(3)
(4)

Quitting auto save in this case causes logging data to be written in (5) and (6) order.

When data (1) to (4) has already been written, data (5) and (6) will be added to them.



- *If a value other than the Auto Save Quit command is entered in auto save mode, logging data acquired up to that point will be written to the CF Card, like the “Auto Save Quit” command. However, the value (command) entered in this mode will not be processed.*
- *In auto save mode, if the file number is changed during data logging, auto save will end at that point and all accumulated logging data will be written to the CF Card.*
- *During loop operation, the current CF Card storage command (0002h) is effective, however, logging data will be output for only 1 loop cycle.*
- *When writing logging data to the CF Card automatically using the loop feature, if the logging frequency is not high and the logging cycle is short, data write to the CF Card will be performed frequently. This, however, can shorten the CF Card’s data write life. Also, if the logging cycle is short, it is possible that data logging can be performed while data is still being written to the CF Card. In this case, until logging data write is completed for that cycle, data logging will be suspended.*
- *When writing backup SRAM data to the CF Card, if the access to backup SRAM is performed from Pro-Server (2-Way Driver), data write to the CF Card will be suspended during the access. When writing data to the CF Card automatically using the loop feature, data write to the CF Card will also be suspended. In this case, until data write to the CF Card resumes, data logging will also be suspended.*
- *When writing data to the CF Card automatically using the loop feature, file data will be added to any existing data.*
- *Adding File data requires that the file be opened. Even if a file with the same name already exists, data will be added to that file.*

4.7.9 Making a Backup of Backup SRAM

All data stored in backup SRAM can be saved to the CF Card as a backup. The files backed up on the CF Card can be transferred to the GP. As an example of the use of this function, backup data can be transferred back to the GP when backup SRAM is cleared in a screen transfer operation. This function is supported only by the GP-2000 Series.



If the setting of the function for using backup SRAM with the Screen Creation Software is changed before a screen is transferred to the GP, the backup data saved to the CF Card will not agree with the screen data. As a result, the data in SRAM may not be transferred back to the GP.

■ Transferring Data from Backup SRAM to the CF Card

The timing of the data transfer from backup SRAM to the CF Card is executed with the control address.

To specify the control address, select [GP Setup] - [Extended Settings].

Reference *Operation Manual, 6.1 Menu Setting Items: GP Setup*

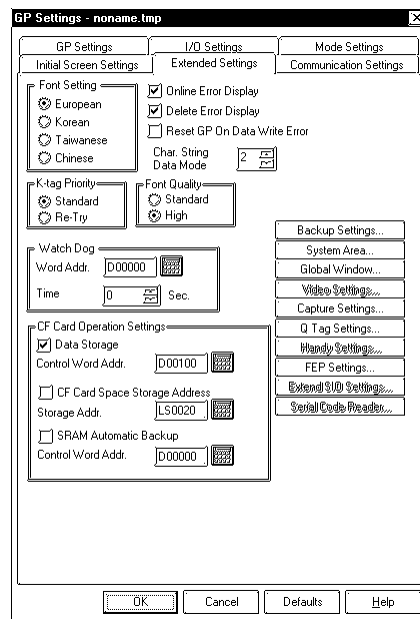

When the control address is specified, the subsequent address (control address + 1) is designated as the status area to which the result of the transfer (whether the transfer is completed successfully or an error has occurred) is set.

For example, when the control address is specified as D00100 via [GP Setup/Extended Settings], D00101 is automatically assigned as the status area.

+0	Control	Transfers backup SRAM to the CF Card.
+1	Status	Error status

• **Control**



SRAM-to-CF Card transfer: Changes bit from [0] to [1].

• **Status**



Transmits completed bit: Changes from [0] to [1].

Error status*

- [0000]: Completed successfully
- [0100]: No CF Card
- [0101]: CF Card write error
- [0111]: CF Card error

* The table below lists the details of the error codes.

Error Code	Error Name	Description
0000	Completed successfully	Backup process completed successfully.
0100	No CF Card	No CF Card is inserted in CF Card slot for the backup operation, or CF Card cover is open.
0101	CF Card write error	Insufficient free space exists on CF Card for backup operation, or CF Card was removed while data was being written.
0111	CF Card error	CF Card is not formatted.

◆ **Details of the Transfer Operation**

Below is the timing chart of the data transfer from backup SRAM to the CF Card. (The illustration below is an example only. The time intervals shown are not accurate.)

Data transfer to the CF Card is executed when the Transfer Trigger Bit, which is the 0th bit of the control, is turned ON. Once the data transfer to the CF Card is completed successfully, the Transmit Completed Bit, which is the 0th bit of the status, is turned ON. If the transfer is not completed because an error occurred during the transmission, the Transmit Completed Bit is not turned ON. (The applicable error status is returned.)

After the data transfer has been completed, detect the ON state of the Transmit Completed Bit with the connected device (PLC, host), and turn OFF the Transfer Trigger Bit. When the control bit is turned OFF, the GP turns OFF the Transmit Completed Bit.

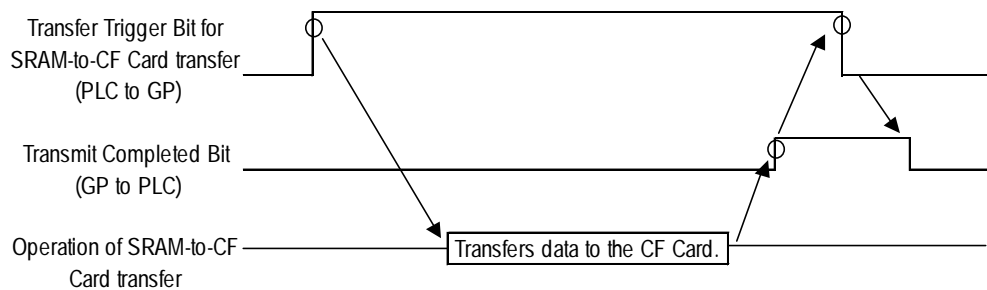

◆ **Cautions concerning Control Bit Operation**

- Before transferring data to the CF Card, confirm that the CF Card save function is not being performed and that the Transmit Completed Bit is turned OFF.
- To prevent accidental power-OFF during operation procedures, turn OFF the Transfer Trigger Bit and Transmit Completed Bit when starting the operation. Be sure to hold the ON/OFF time of the Transfer Trigger Bit for either the communication cycle time or Tag Scan Time, whichever is longer.

◆ **File Sizes for CF Card**

- The data stored in backup SRAM (data on the GP) are saved on the CF Card as a file (backup) with the Control Word Address as the trigger.
- The file size that can be stored on the CF Card varies according to the GP model, as shown below.

GP Model	Size of file stored on the CF Card
GP-2300T, GP-2300S, GP-2300L, GP-2400T, GP-2500L, GP-2500S, GP-2500T, GP-2600T, GLC-2300T, GLC-2300L, GLC-2400T, GLC-2600T	256 KB
GP-2301S, GP-2301L, GP-2301T, GP-2401T, GP-2501L, GP-2501T, GP-2501S, GP-2601T, GP-2301HL, GP-2301HS, GP-2401HT	128 KB

■ **Transfer between Backup SRAM and CF Card in GP's OFFLINE Mode**

In the GP's OFFLINE Mode, the data can be transferred from backup SRAM to the CF Card, or from the CF Card to backup SRAM.

Large unit

In the GP's OFFLINE mode, select [Main Menu/2. Transfer Screen Data/Transfer SRAM Data].

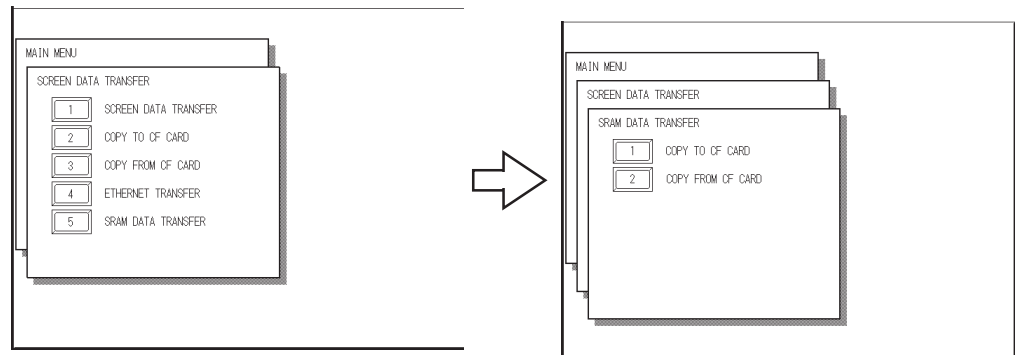

Mid-size unit

In the GP's OFFLINE mode, select [Main Menu/Transfer Screen Data], and then [From SRAM to CF Card] or [From CF Card to SRAM].

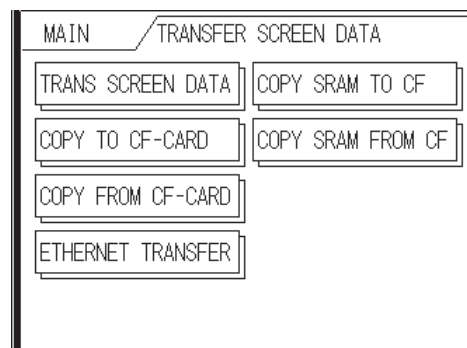

◆ **Transferring Data from Backup SRAM to the CF Card**

Enter the password and press the Start switch to start the transfer. The following is the screen image of the large unit.

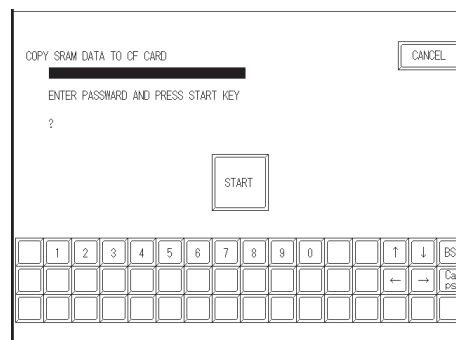

- If an error occurs, one of the following error messages is displayed on the screen.

	Error Message	Description of error
1	Destination space is insufficient.	Data cannot be transferred because remaining free space on CF Card is less than size of backup SRAM file.
2	No CF Card inserted.	No CF Card is inserted into slot, or CF Card cover is open.
3	Data cannot be written to CF Card.	An error occurred while data was being written to CF Card.

◆ **Transferring Data from the CF Card to Backup SRAM**

Enter the password and press the Start switch to start the transfer.
The following is the screen image of a large unit.

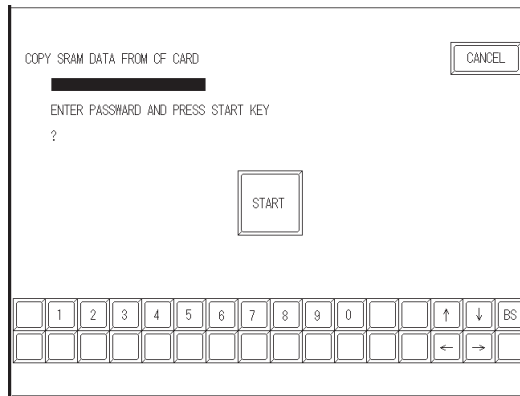

- If an error occurs, one of the following error messages will be displayed on the screen.

	Error Message	Description of error
1	Destination space is insufficient.	Data cannot be transferred because backup file stored on CD Card exceeds SRAM capacity.
2	SRAM data does not agree with screen data.	Content of backup file to be transferred does not agree with screen data.
3	No CF Card inserted.	No CF Card is inserted in slot, or CF Card cover is open.
4	CF Card data error	Error occurred while data was being read from CF Card.
5	No data stored on CF Card	Data cannot be transferred because no backup file exists on CF Card.

■ Destination of CF Card file

The CF Card is saved to SRAM\ZD00001.BIN.

Only one backup data file can be saved on a CF Card.



- **Make sure that the free space on the CF Card exceeds the backup SRAM size. The free space is checked before the process is executed; therefore, the backup SRAM data will not be saved on the CF Card if insufficient free space remains on the CF Card.**
- **When using the CF Card save function, make sure that the data is not stored in the CF Card save control address. The following data can be saved with the CF Card save function:
Filing data, logging data, trend graph data, sampling data (sample data of data sampling) and Q-tag alarm data**
- **If a backup of backup SRAM is performed while a CF Card save function is being executed, the backup will be made after the CF Card save function is completed. The process of writing to the CF Card is suspended while the backup process is executed.**
- **When the SRAM backup data save function is executed with Pro-Server, the operation is disabled if the 2-Way Driver is accessing the SRAM. The process of writing to the CF Card is suspended while the SRAM is being accessed.**
- **Conversely, processing of the CF Card save function is suspended while backup of the backup SRAM is being performed. Note that the logging function is also suspended until the process of writing to the CF Card starts when the loop feature is used to automatically write data to the CF Card.**
- **Only one backup file can be saved to the CF Card.**
- **To create the SRAM folder, select [Format Memory]-[Format CF Card] in OFFLINE mode.**



- The backup file should agree with the screen data settings. When a CF Card-to-SRAM transfer (restore) is executed in OFFLINE mode, conformity of the backup file and screen data settings is checked. If conformity is not confirmed, an error message will be displayed. Data restoration will not be performed.
For the trend graph parts, merely updating (saving) the Base screen on which the parts are set up will not result in the backup file conforming with the screen data, regardless of whether the attributes of the trend graph parts have been modified.
- When performing a CF Card-to-SRAM transfer (restore) in OFFLINE mode, note that all existing data (logging data, for example) will be replaced by the restored data and lost.
- When a CF Card-to-SRAM transfer (restore) is performed in OFFLINE mode, the Brightness, Contrast, and Sound Volume adjustment values are not changed. However, note that the system will operate with the restored data when the power is turned OFF and ON again, or the system is switched to RUN mode.
- When a CF Card-to-SRAM transfer (restore) is executed in OFFLINE mode while the VGA/SVGA display function is enabled with the GP-2500T or GP-2600T unit, the adjusted VGA/SVGA display may be changed. In this case, adjust the display again.
- When a CF Card-to-SRAM transfer (restore) is performed in OFFLINE mode, the information in the Japanese FEP learning function will be overwritten. As a result, the listing order of frequently used conversions displayed by the Japanese FEP may be changed.
- When this function is used with the GLC model, the GLC area will not be stored on the CF Card. The file size is 256 KB.

4.7.10 Screen Capture

With this function, the screen displayed on the GP can be stored on the CF Card in JPEG file format. (A hard copy of the GP screen)

For details of the video screen capture function, **Reference** "4.12.5 Video Control Area Example"



Only the GP-2000 Series supports Screen Capture.

Select [Capture Settings] from the [Extended Settings] tab in the [GP Settings].

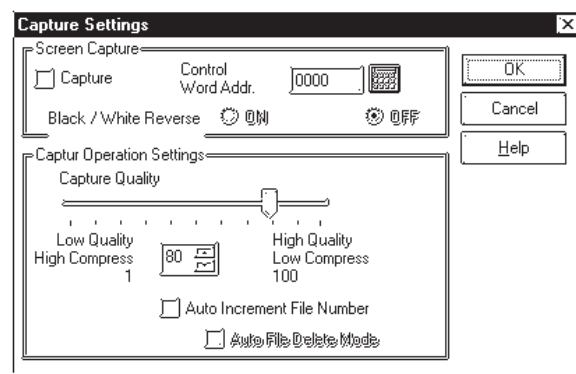

■ **Screen Capture**

◆ **Control Word Address**

To perform screen capture, specify a hard copy file number (between 0 and 65535) using the control word address. Turn ON the File Output Start Bit of the control. When the "Auto Increment File Number" function is enabled, the JPG file name to be stored will be \CAPTURE\CPXXXXXX.JPG. (XXXXXX represents a contiguous sequence of automatically assigned numbers between 0 and 65535.)

address+0	Control
address+1	Status
address+2	Hard copy file number











• **Control**



Bit 0: File Output Start Bit
Changing the bit from [0] to [1] starts File Output.

◆ **Black/White Reverse**

Set this feature in order to save the image data on the CF Card with black and white reversed. The following table describes the results of this effect with mono chrome and color models of the GP.

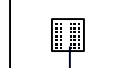
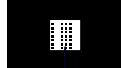
GP-PRO/PBIII (PC screen)	GP Type	GP screen	Reverse Black & White Function (Within the CF Card)	
			Enabled	Disabled
 (White circle)	Monochrome	 (Normal) Black	 Black	 White
		 (Reverse) White		
 (Colors other than black and white) Example: Green	Color	 White	 Black	 White
		 Green	 Green	 Green



- Only black or white can be reversed.
- Other colors cannot be reversed.
- The "Black/White Reverse" function is disabled when the VM Unit is attached.

◆ Details of the Capture Operation

The results of the screen capture and JPEG save processing are stored in the Status Address (Control Word Address + 1).

For the File Output Completed Bit, the 1st bit of the Status Address is turned ON when the capture process is completed.

After the capture operation is completed, detect the ON status of the Output Completed Bit with the connected device (PLC, host) and turn OFF the File Output Bit. When the File Output Bit is turned OFF, the GP turns OFF the File Output Completed Bit.

The following timing chart describes the relationship between the Control and Status in a Capture operation.

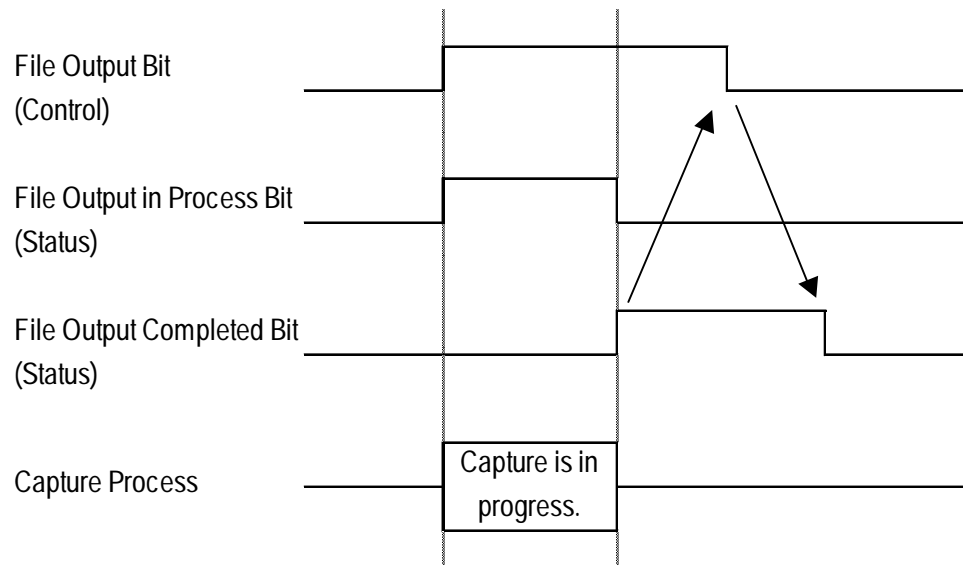

When the File Output Bit is changed from ON to OFF after the File Output Completed Bit is turned ON, the File Output Completed Bit is turned OFF automatically.



- **When this setting is enabled, it will function both with the screen capture and video screen capture functions. This function cannot be set up for individual operation.**
- **Even when the File Output Bit (Control) is turned OFF before the File Output Completed Bit is turned ON, the File Output Complete Bit is turned OFF automatically.**

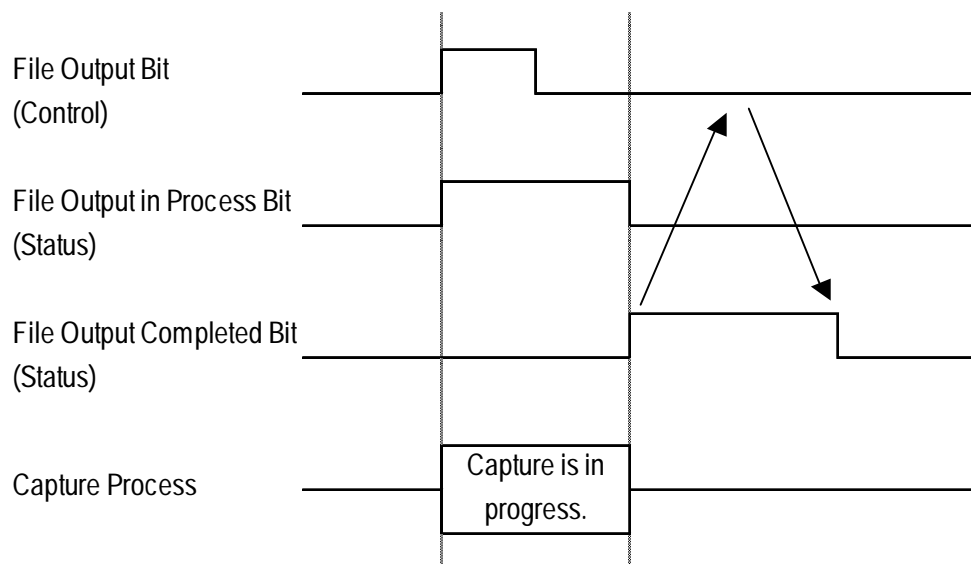

■ Capture Operation Settings

◆ Capture Quality

Sets the quality of the captured image when it is saved as a JPEG file.

Setting Range: 1 to 100 (Default value: 80)

1: Lowest quality, highest compression

100: Highest quality, lowest compression



- **A screen capture normally takes five or six seconds and produces a file size of approximately 200KB (at 80 percent quality). The time required for capture varies with the image quality and screen size.**
- **Tags are not updated while the screen capture is in progress.**
- **When capturing a screen on which the blink setting is active, the blink feature will stop completely while the capture is in progress.**

◆ **Auto Increment File Number Function**

This function allows you to automatically assign a continuous sequence of numbers to the file names when saving JPEG files (CP***.JPG). When a screen is captured, it is saved with a file name automatically assigned by adding 1 to the highest file number of JPEG files saved on the CF Card. The GP searches for the highest file number upon GP power-up, upon opening/closing of the CF Card over, and upon insertion/removal of a CF Card. The saved number is written on the hard copy file number of the control word address.



Note: • When this function is enabled, numbers entered as the hard copy file number of the control word address are ignored.

- To enable the "Auto Increment File Number" function with the video screen capture function, designate the JPEG file number indirectly. **Reference** "2.28.4 Video Capture"

The video screen capture function is supported only by the GP-2500T and GP-2600T units, and an optional VM unit (sold separately) is required.

In addition, enabling "Auto File Delete Mode" allows screens to be captured even when the CF Card does not have sufficient free space or the file number exceeds 65535.

[If no free space is available on the CF Card]

This feature automatically deletes the file with the lowest file number and creates a file with the highest file number + 1.

Example: Files with file numbers CP00100.JPG to CP00300.JPG are saved on the CF Card.

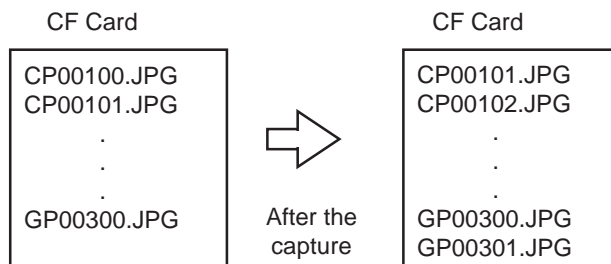

The file CP00100.JPG is deleted and the new file CP00301.JPG is created. However, if CP00100.JPG is a read-only file, the deletion is interrupted and "0101: CF Write Error" is set in bits 12-15 in the Status area.



Note: The amount of free space remaining is displayed in the Available CF Card Space field.

Reference 4.7.11 Checking the CF Card's Available Capacity

[Auto File Delete Mode]

When a file with the highest file No. (CP65535.JPG) exists

This function automatically deletes all JPEG files currently stored on the CF Card and creates a new file named file No. 0 (CP00000.JPG).

Example: Files with file names CP00100.JPG to CP65535.JPG are saved on the All files from CP00001.

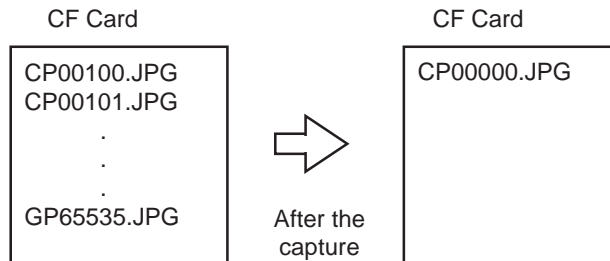

JPG through CP65535.JPG are deleted (this may take a few seconds to a few minutes), and the new file CP00000.JPG is created.



Note: The file number can be reviewed with the hard copy file number (Setting address + 2).

When "Auto File Delete Mode" is disabled, turning ON the File Output Start Bit will not capture a screen when the CF Card does not contain sufficient free space or the maximum file number is exceeded.

[Loop]

When a file with the highest file No. (CP65535.JPG) exists, a new file is created by overwriting file No. 00000.

Example: When files with file Nos. CP65531.JPG to CP65535.JPG exist

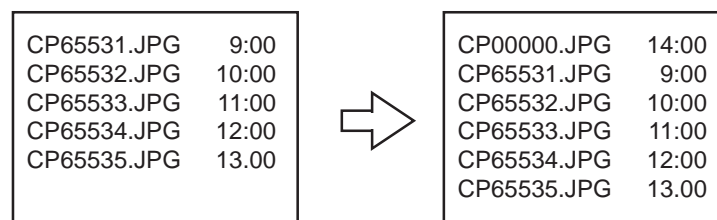

A new file CP00000.JPG is created.

In addition, when files with file Nos. 00000 through 65535 exist on the CF Card, file No. 00000 will be overwritten.



Note: • File numbers assigned to files created with the Auto Numbering loop operation are checked whenever a file is created. The file number of the file to be created is determined according to the following rules:

- (1) When a file is created, the file number assigned to the new file is created by adding 1 to the file number with the most recent time stamp among file numbers in current use.
 - (2) When a file is deleted due to insufficient free space, the file with the oldest time stamp is deleted.
- If data is written to the CF Card that interrupts a file number while the CF Card is in the slot (while a file is being transferred from the 2-Way Driver), the file is overwritten.
 - Loop function is enabled with both the screen capture and video screen capture functions.
 - When a file is deleted due to insufficient free space, the oldest file is deleted in order to create a new file. In such a case, it may take twice as long to save a file compared to saving when there is sufficient free space.

4.7.11 Checking the CF Card's Available Capacity

The current amount of CF Card free space will be stored to the LS area's designated address, using the range from 0 to 65535 (FFFFh). Checking this value stored in the LS area tells you how much CF Card free space is available.

All data stored in the CF Card will be in "KB" units.

In the following cases, the amount of free space available cannot be checked correctly and will be displayed as OKB.

- The optional Multi Unit has not been installed.
- The CF Card has not been inserted.
- The CF Card access switch has been turned OFF.



- **The CF Card free space data value stored in the LS area is an approximate value. Therefore, there is the possibility that exactly that amount of data may not be stored in that space.**
- **Even when the amount of free space exceeds 65535 (FFFFh) Kbytes, the LS area value will be 65535 (FFFFh).**

■ **CF Card Free Space Storage Address Settings**

The Storage Address settings are designated via the GP Settings window's Extended Settings tab.

Reference *Operation Manual, 6.2 Menu Setting Items: GP Setup*

Designates the Storage Address used to store the CF Card's approximate free space value.

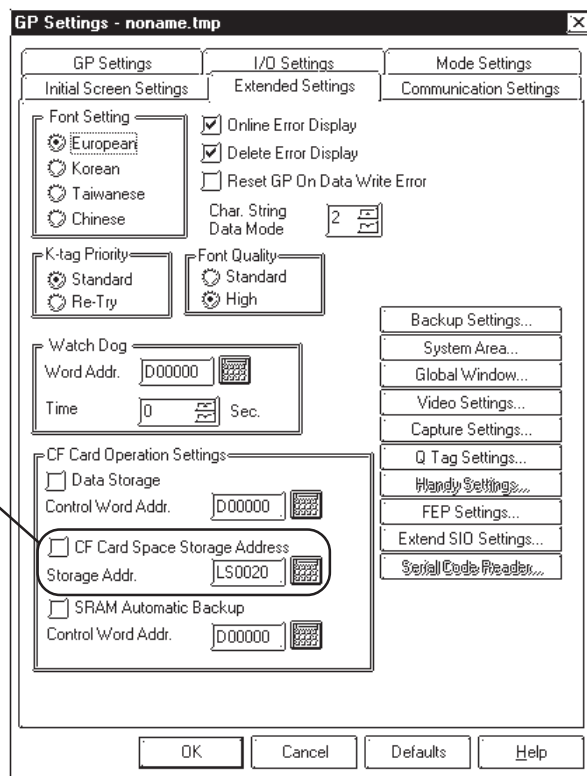

4.8 Serial-Code Reader Compatibility

4.8.1 Overview

The Serial-code reader connects to the GP's extended serial I/F. This function is supported only by the GP2000 (except GP-2301/2401/2501/2601/2401H/2301H) Series units.

4.8.2 Compatible Serial-Code Readers

The following Serial-code readers are compatible:

- Denso's Serial-code reader: QS20H, QS20H-1
- Token's Serial-code reader: THIR-3000, THIR-3000H

4.8.3 Outline of Operation

Specify the Serial-code reader (LS) in the extended SIO setting to connect the Serial-code reader. **Reference** *Operation Manual, 4.2.8. Changing Extend SIO Type*

The data from the Serial-code reader is stored in the LS area in the GP.

The Serial-code reader is not interlocked with the K-tag function. The data read by the Serial-code reader is stored in the LS area because the data volume greatly exceeds that read by a one-dimensional bar code reader.

When the Serial-code reader is used, the data from the Serial-code reader stored in the LS area can be sent to the upper host or partially displayed on the screen with the GP tag function.

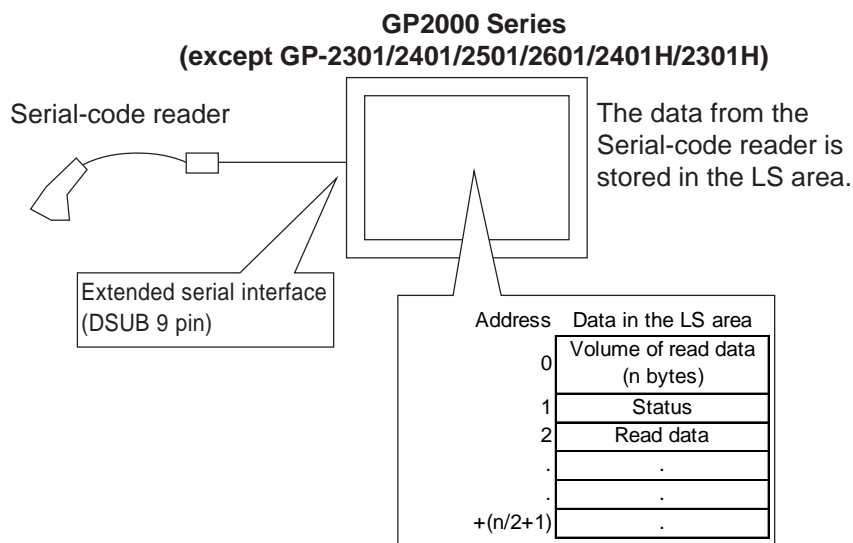

Note: Even if the Serial-code reader is set up, the serial 1-dimensional bar code reader can be also connected. However, the read mode should be set to “normal.”

* This function is supported only by the GP2000 (except GP-2301/2401/2501/2601/2301H/2401H) Series units.

4.8.4 Action Settings

The required settings for the Serial reader are as follows.

Basic settings

- Starting address of LS data storage area
- Communication settings (Communication settings for the extended serial I/F can be set with the extended function settings of the GP system settings or with the GP off-line.)

Extended settings

- Read complete bit address (Setting: ON/OFF)
- Storage mode (Setting: Data clear with 0/ Data clear with space/OFF)
- Maximum number of bytes of data stored in the LS (Setting: ON/OFF)
- Readout mode: (Setting: Standard/Denso's QR code reader/Token's code reader)

[Basic settings]

■ Starting address of data stored in the LS area

Read data is stored in the LS area. The data cannot be in the PLC device. The data is stored in the following order.

LS Area Address	Data
+0	Volume of read data (n bytes)
+1	Status
+2	Read data
.	.
.	.
+(n/2+1)	.

- Volume of read data (n bytes):
The volume of read data is stored.
- Status:
The error code is stored if the data cannot be correctly loaded or cannot be written in the LS area. The types of errors are as follows.

0000h: -

0001h: Data has been successfully read.

0002h: Error reading data; data cannot be stored in the LS area.

0003h: Data exceeding the maximum number of bytes storable in the LS area has been received.

The maximum number of bytes of data are stored in the LS data.

In this case, the read complete bit address (setting is ON) is turned ON. Data exceeding the maximum number of bytes cannot be written in the LS area.

* This function is supported only by GP2000 (except GP-2301/2401/2501/2601/2301H/2401H) Series units.

- The data read by the Serial-code reader is stored in the LS area in accordance with the String Data Mode set in the GP. Therefore, the string can be displayed with the S-tag.
- The usable LS area in the GP-2000 Series is as follows (shaded area).

LS Area Address	Data
LS0000	System data area
LS0020	Load area User area 2012 words
LS2031	Special relay
LS2032	
LS2047	Reservation
LS2048	
LS2095	User area 2000 words * ¹
LS2096	
LS4095	+ 4095 words
LS4096	
LS8191	

- The LS area should be updated after all the data from the Serial-code reader has been read.
- If the volume of the read data exceeds the capacity of above shaded areas, the data within the shaded areas would be written in the LS area. However, the status shows 0003h (Data that exceed the maximum number of bytes of data that can be stored in the LS area have been received).

[Extended settings]

■ Read complete bit address (setting: ON/OFF)

Setting: Present

When all the data are completely written in the LS area, the read complete bit address is turned ON. The read complete bit address is useful for determining whether the GP has retrieved all the data in the host. When the bit is turned ON at the GP side, the bit should be turned OFF at the host side. If the bit is not turned OFF, the next data will not be read in the GP.

Setting: OFF

The complete bit is not turned ON even if all the data is written in the LS area. Control processing of the GP and the host is not necessary. However, if the data were loaded one by one, it would be overwritten.

* This function is supported only by the GP2000 (except GP-2301/2401/2501/2601/2301H/2401H) Series units.

■ **LS Storage Size (Settings: Assign Size/Maximum)**

Setting: Assign Size

The maximum number of bytes for the LS area is the maximum volume of data that can be stored in the LS area. The data can be written to the LS area if it does not exceed the specified maximum number of bytes of data. If data exceeding the maximum number of bytes is read, the overflow data will not be written to the LS area.

Setting: Maximum

Data can be written in the LS area if it does not exceed the maximum usable LS area. However, if the amount of read data exceeds the usable LS area, the overflow data will not be written in the LS area.

■ **Storage Mode**

When processing the serial-data, specify a storage method. You specify whether the data column should be cleared or not. This function is activated only when the LS storage size is set to “Assign Size.”

The following three modes are available.

- OFF
- Clear Data with 0 (Clear with Null)
- Clear Data with Space

When the currently read data size is shorter than the previously read data size, the currently read data can be correctly displayed with the S-tag by clearing the LS area data.

Where clearing of data column is required

(Example) When the LS storage size is set to 14 bytes

		LS area address		Previously read 16bit		Currently read 16bit	
Volume of read data	+0	0	7	0	5		
Status	+1	0	0	0	0		
Data	+2	'1'	'2'	'A'	'B'		
.	+3	'3'	'4'	'C'	'D'		
.	+4	'5'	'6'	'E'	0		
.	+5	'7'	0	0	0	Read data	
	+6	0	0	0	0	[ABCDE]	
	+7	0	0	0	0		

The previously read data in the shaded areas was not cleared and will not be correctly displayed with the S-tag.

When [Clear Data with 0] is selected in the storage mode settings, the data size between the read data size and maximum number of bytes for the LS area is written as 0 (the shaded area described above).

* This function is supported only by GP2000 (except GP-2301/2401/2501/2601/2301H/2401H) Series units.

■ Read Mode

To operate the Serial-code reader, dedicated communication procedures are needed because each Serial-code reader has a manufacturer-specific communication format. As previously described, this new version supports three modes — “Standard”, “Denso QR Code Reader” and “Token’s code reader”— to support the following transfer format.

Standard

Code data	Terminator (CR)
-----------	-----------------

In Standard mode, binary data cannot be handled. In Standard mode, Denso’s Serial-code reader can read data from other manufacturers’ code readers if the above settings are selected.

Denso QR Code Reader

Header	Code mark	Number of digits (4 bytes)	Code data	Terminator	BCC
STX (fixed)	ON	ON	-	CR (fixed)	ON

In “Denso QR Code Reader” mode, binary data can also be handled. However, handling binary data requires that the Serial-code reader be added to the above settings.

Token’s Code Reader

Header	Code data	Terminator
STX (fixed)	-	CR+LF (fixed)

In “Token Code Reader” mode, handling binary data requires that the Serial-code reader be added to the above settings. If the CR+LF code were included in the data, Token’s code reader would determine that reading of the data has finished because, unlike “Denso QR Reader” mode, the number of digits and BCC are not checked.

* This function is supported only by the GP2000 (except GP-2301/2401/2501/2601/2301H/2401H) Series units.

■ Communication Settings

The Serial-code reader loads the data via a serial transfer function. Therefore, the communication baud rate of the reader and the GP should be coordinated. These settings can be changed in the GP system settings in the drawing software or off-line.

◆ Code Reader Data Read Timing

The read timing and operation of read complete bit of the serial code are as follows. (When the Read Complete bit is set to ON, Host-side processing is required. If this bit is set to OFF, Host-side processing is not required.)

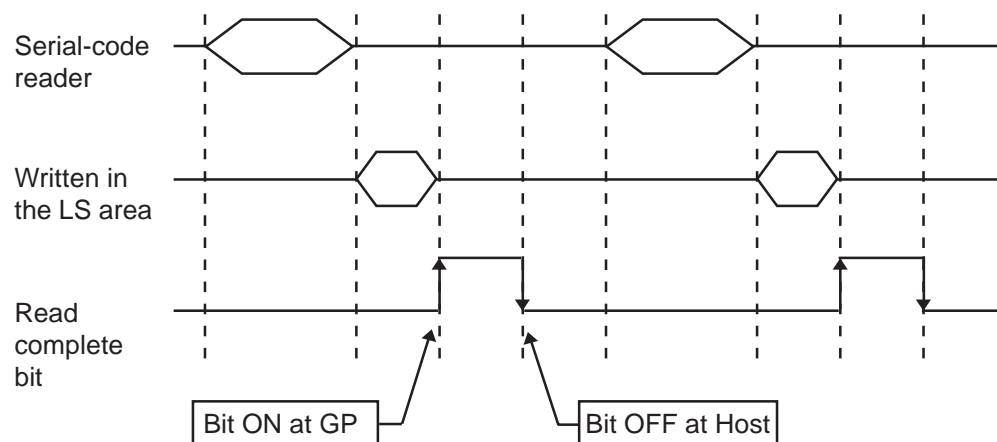

- **Note:** Some models of Serial-code readers can directly read one-dimensional bar codes. The read one-dimensional bar code is also stored in the LS area.

* This function is supported only by GP2000 (except GP-2301/2401/2501/2601/2301H/2401H) Series units.

4.8.5 GP System Settings

Connecting a Two-Dimensional Code reader to the GP allows special data to be read and saved. This feature is supported only by the GP-2000 Series (except GP-2301, GP-2401, GP-2501, GP-2601, GP-2301H and GP-2401H). Open the GP System Settings dialog box and select "Serial Code Reader" from the "Extended Settings" tab.

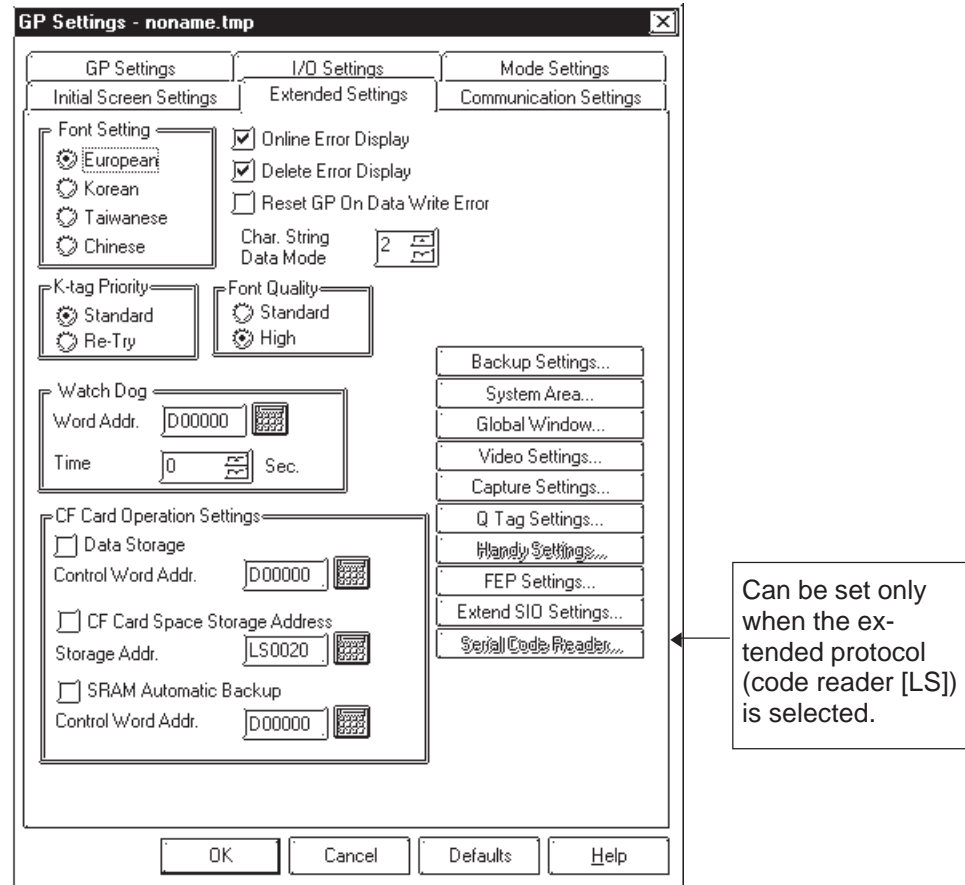

4.8.6 LS Storage Start Address Settings

The data read with the Two-Dimensional Code reader is stored in the LS area. Specify the LS start address to store the data.

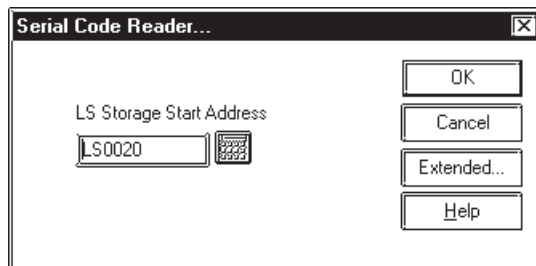

* This function is supported only by the GP2000 (except GP-2301/2401/2501/2601/2301H/2401H) Series units.

4.8.7 Extended Settings

The following items can be set in the Extended Settings dialog box:

Read Complete Bit Address:

Click the check box to specify the bit address.

Storage Mode:

Initialize Settings

Click the check box to specify the maximum number of LS bytes to use.

Max Bytes for LS Area

Select only one of the options. Select the desired mode: "None", "Clear with 0" or "Clear with space".

Readout Mode:

Can choose which mode for reading the data.

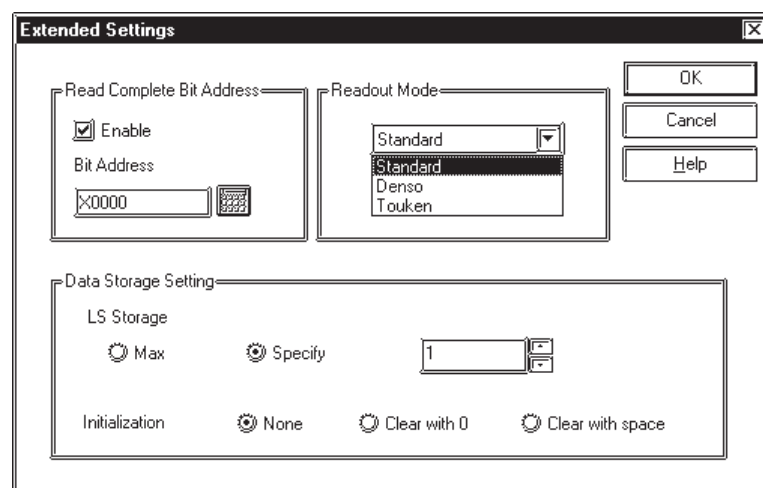

* This function is supported only by GP2000 (except GP-2301/2401/2501/2601/2301H/2401H) Series units.

4.8.8 Extended SIO Communication Settings

To make the setting, open the GP Settings dialog box and select "Extended SIO Settings" from the "Extended Settings" tab.

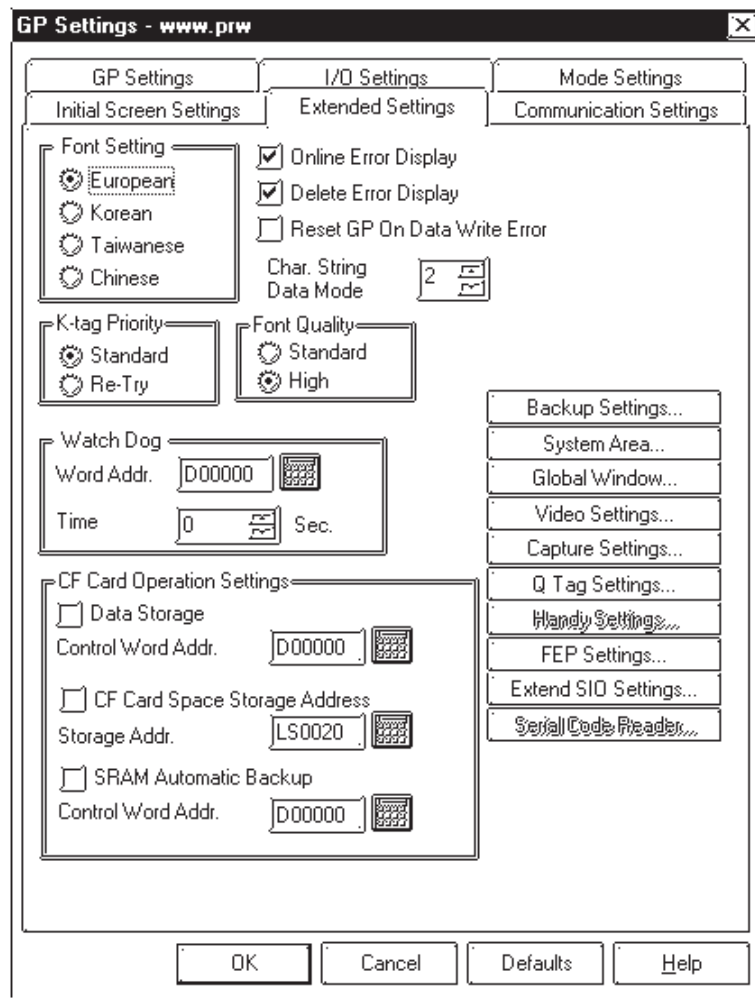

Press the Extended SIO Settings button to specify the communication settings in the following dialog box. Select a transfer speed of 2400, 4800, 9600, 19200 or 34800 bps. The default value of each setting depends on the extended protocol selected.

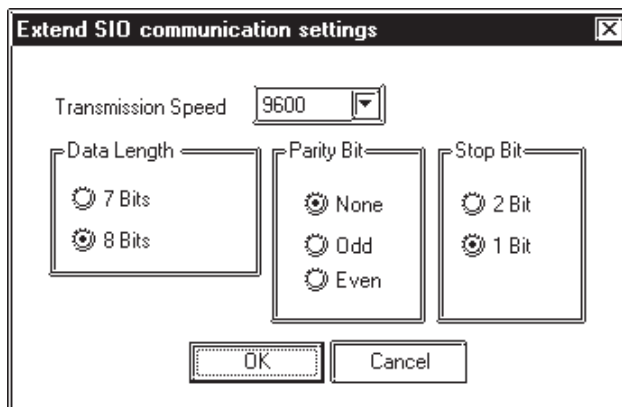

* This function is supported only by the GP2000 (except GP-2301/2401/2501/2601/2301H/2401H) Series units.

4.9 Bar-Code Reader Compatibility

4.9.1 Overview

The GP supports bar code readers that are connectable to the extended serial I/F. This function is supported only by GP2000 (except GP-2301/2401/2501/2601/2301H/2401H) Series units.

To connect a One-Dimensional Code Reader to a GP, make the settings for the Serial Code Reader (K-tag) in the Extended SIO Settings that enable the Extended Serial Interface.

- The Serial-code reader (K tag) handles the data transfer formats [code data + CR] and [code data + (CR+LF)].
- A Serial-code reader can read the code if the code is displayed in the above data transfer format and the number of code characters is within the K-tag's display characters (80 characters max.).

4.9.2 Bar-Code Reader Features

You can use a K-tag to read data from the bar code reader connected to the GP unit's extended serial I/F interface, since it is the same as the bar-code read processing performed from the GP unit's rear face tool connector.

The K-tag's read processing of the bar-code is as follows.

- After reading the data from the bar code reader and the CR code, the GP will automatically write the data in the data storage address. There is no need to press the [ENT] key on the touch keyboard.
- If switching between screens is performed during inputting of the bar code, the switching process takes preference and the data being input is ignored.
- When the data write is completed, "03 bit" of Status in the system data area is highlighted, so that the timing of data writing is acknowledged.



- **If the bar code input with the K-tag is not permitted, the bar code data cannot be written with the K-tag.**
- **When the bar code reader is connected to both the GP tool connector and the extended serial interface, and a bar code data is read into each interface simultaneously, the data may not be correctly written in the K-tag.**

* This function is supported only by GP2000 (except GP-2301/2401/2501/2601/2301H/2401H) Series units.

4.9.3 Tested Bar Code Readers

■ Models

Manufacturer	Model	Type	Remarks
Aimex Corporation	BR-730RS	Pen	Battery powered
	BR-530RS	Pen	Requires separately sold BB-60 for power.
	BW-665RS	Touch Scanner (Read Width: 65mm)	
OPT Electronics	OPT-1125-RS232C	Touch Scanner (Read Width: 60mm)	Requires separately sold DC5300T for power.
	OPT-5125-RS232C	Touch Scanner (Read Width: 80mm)	
	NFT-7175-L-RS232C	Fixed Type (Read width: 60mm)	
Olympus Symbol	LS4004	Laser Scanner	Includes power supply.
	LS4004i	Laser Scanner	Includes power supply.
	LS6004	Laser Scanner	Includes power supply.
	LSH3502AHV	Laser Scanner	Includes power supply.
Keyence Co.	BL-80R	Touch Scanner (Read Width: 105mm)	Includes power supply.
Denso Co.	HC36TR	Touch Scanner (Read Width: 61mm)	For power: separately sold P-200 unit. For connector cable: separately sold KRS-423-XF1K (Sanwa Supply)
	HC61TR	Touch Scanner (Read Width: 61mm)	

■ Readable Data Transfer Formats

The following bar code specifications (data transfer format) are supported by the GP.

(1)

Code Data	Terminator (CR)
-----------	-----------------

(2)

Code Data	Terminator (CR+LF)
-----------	--------------------

When using (2) type of a bar code reader, LF is ignored.



When the read data exceeds the number of displayed characters specified in the K-tag, the data cannot be properly displayed with the K-tag. The maximum number of display characters that can be set with the K-tag is 80.

* This function is supported only by the GP2000 (except GP-2301/2401/2501/2601/2301H/2401H) Series units.

■ Connection Environment

For Opt Electronics' bar code reader

Model: OPT-5125-RS232C-H, OPT-1125-RS232C-K

- Wiring diagram

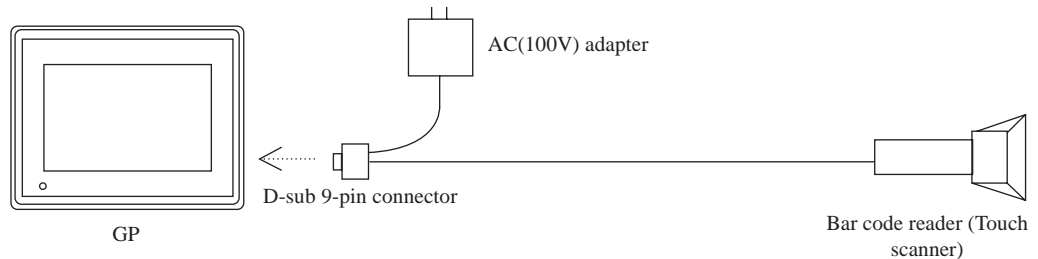

*The bar code reader is directly connected to the GP.

Direction of Signal

GP			Direction of signal	Barcode reader	
Signal		Pin		Pin	Signal
CD	Input	1		1	NC
RD	Input	2	←	2	SD(TXD)
SD	Output	3	→	3	RD(RXD)
ER	Output	4	→	4	-
SG	-	5		5	SG
DR	Input	6	←	6	-
RS	Output	7	→	7	CS(CTS)
CS	Input	8	←	8	RS(RTS)
RI/VCC	Input/ Output	9		9	NC

Connected to No.4 and No.6 pins.

Communication Settings

The communication settings for the extended serial I/F of the GP is specified as the initial data of the bar code reader.

The initial data of Opt Electronics' bar code readers, OPT-5125-232C-H and OPT-1125-232C-K, are as follows.

Transmission rate	Data length	Stop bit	Parity bit
9600bps	8	1	None

* This function is supported only by GP2000 (except GP-2301/2401/2501/2601/2301H/2401H) Series units.

For Opt Electronics' bar code reader

Model: NFT-7175-L-RS232C

- Wiring diagram

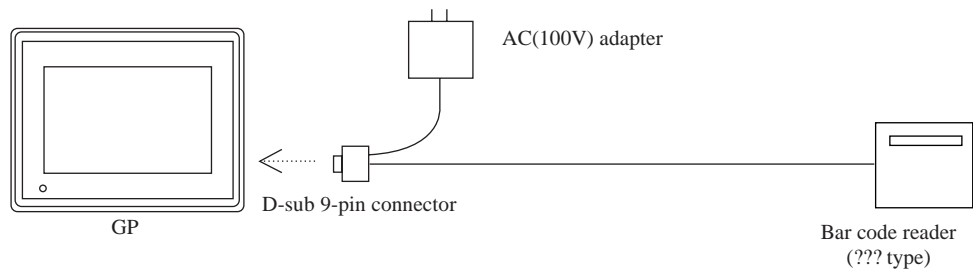

*The bar code reader is directly connected to the GP.

Direction of signal

GP			Direction of signal	Barcode reader	
Signal		Pin		Pin	Signal
CD	Input	1		1	NC
RD	Input	2	←	2	SD(TXD)
SD	Output	3	→	3	RD(RXD)
ER	Output	4	→	4	-
SG	-	5	→	5	SG
DR	Input	6	←	6	-
RS	Output	7	→	7	CS(CTS)
CS	Input	8	←	8	RS(RTS)
RI/VCC	Input/Output	9		9	NC

Connected to No.4 and No.6 pins.

Communication settings

The communication settings of the extended serial I/F of the GP is specified as the initial data of the bar code reader.

The initial data of Opt Electronics' bar code readers, NFT-7175-L-RS-232C, is as follows.

Transmission rate	Data length	Stop bit	Parity bit
9600bps	8	1	None

* This function is supported only by the GP2000 (except GP-2301/2401/2501/2601/2301H/2401H) Series units.

For Imex's bar code reader

Model: BR-730RS

- Wiring diagram

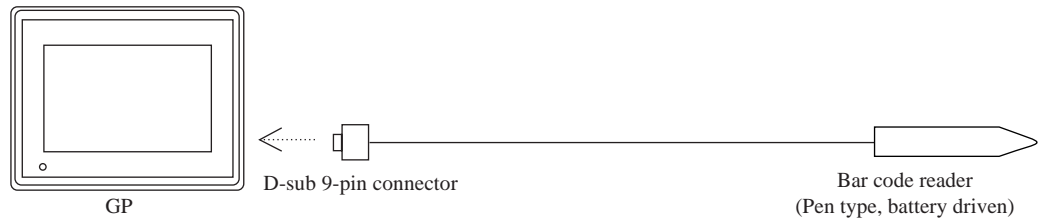

*The bar code reader is directly connected to the GP.

Direction of signal

GP			Direction of signal	Barcode reader	
Signal	Input/Output	Pin		Pin	Signal
CD	Input	1		1	NC
RD	Input	2	←	2	SD(TXD)
SD	Output	3	→	3	RD(RXD)
ER	Output	4	→	4	-
SG	-	5		5	SG
DR	Input	6	←	6	-
RS	Output	7	→	7	CS(CTS)
CS	Input	8	←	8	RS(RTS)
RI/VCC	Input/Output	9		9	NC

Connected to No.4 and No.6 pins.

Communication settings

The communication settings of the extended serial I/F of the GP is specified as the initial data of the bar code reader.

The initial data of Imex's bar code readers, BR-730RS, is as follows.

Transmission rate	Data length	Stop bit	Parity bit
4800bps	8	2	None

* This function is supported only by GP2000 (except GP-2301/2401/2501/2601/2301H/2401H) Series units.

For Imex's bar code reader

Model: BR-530RS

- Wiring diagram

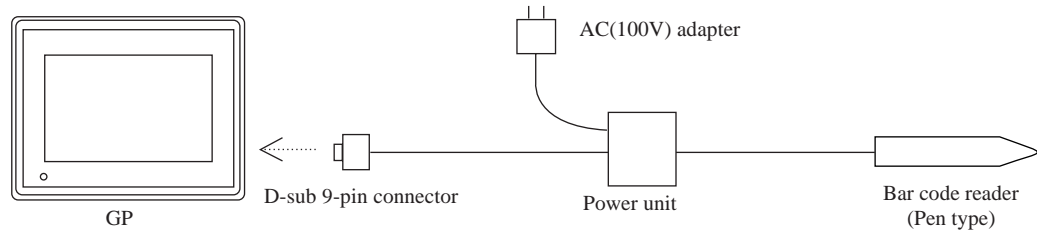

*The bar code reader is directly connected to the GP.

Direction of signal

GP			Direction of signal	Barcode reader	
Signal		Pin		Pin	Signal
CD	Input	1		1	NC
RD	Input	2	←	2	SD(TXD)
SD	Output	3	→	3	RD(RXD)
ER	Output	4	→	4	-
SG	-	5	→	5	SG
DR	Input	6	←	6	-
RS	Output	7	→	7	CS(CTS)
CS	Input	8	←	8	RS(RTS)
RI/VCC	Input/ Output	9		9	NC

Connected to No.4 and No.6 pins.

Communication settings

The communication settings of the extended serial I/F of the GP is specified as the initial data of the bar code reader.

The initial data of Imex's bar code readers, BR-530RS, is as follows.

Transmission rate	Data length	Stop bit	Parity bit
4800bps	8	2	None

* This function is supported only by the GP2000 (except GP-2301/2401/2501/2601/2301H/2401H) Series units.

For Imex's bar code reader

Model: BW-665RS

- Wiring diagram

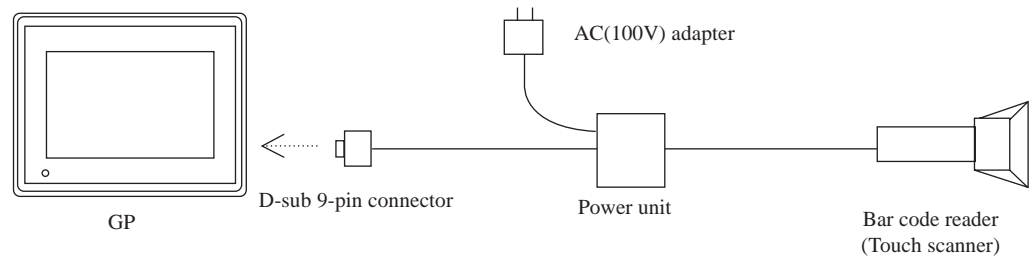

*The bar code reader is directly connected to the GP.

Direction of signal

GP			Direction of signal	Barcode reader	
Signal	Input/Output	Pin		Pin	Signal
CD	Input	1		1	NC
RD	Input	2	←	2	SD(TXD)
SD	Output	3	→	3	RD(RXD)
ER	Output	4	→	4	-
SG	-	5		5	SG
DR	Input	6	←	6	-
RS	Output	7	→	7	CS(CTS)
CS	Input	8	←	8	RS(RTS)
RI/VCC	Input/Output	9		9	NC

Connected to No.4 and No.6 pins.

Communication settings

The communication settings of the extended serial I/F of the GP is specified as the initial data of the bar code reader.

The initial data of Imex's bar code readers, BW-665RS, is as follows.

Transmission rate	Data length	Stop bit	Parity bit
4800bps	8	2	None

* This function is supported only by GP2000 (except GP-2301/2401/2501/2601/2301H/2401H) Series units.

For Olympus Symbol's bar code reader

Model: LSH3502AHV

- Wiring diagram

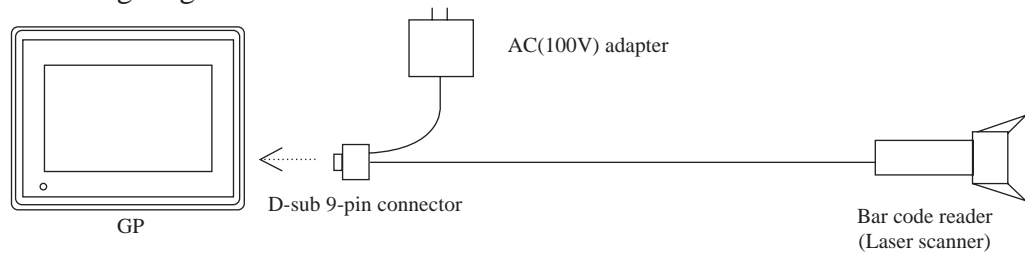

*The bar code reader is directly connected to the GP.

Direction of signal

GP			Direction of signal	Barcode reader	
Signal	Input/Output	Pin		Pin	Signal
CD	Input	1		1	NC
RD	Input	2		2	SD(TXD)
SD	Output	3		3	RD(RXD)
ER	Output	4		4	NC
SG	-	5		5	SG
DR	Input	6		6	NC
RS	Output	7		7	CS(CTS)
CS	Input	8		8	RS(RTS)
RI/VCC	Input/Output	9		9	NC

Communication settings

The communication settings of the extended serial I/F of the GP is specified as the initial data of the bar code reader.

The initial data of Imex's bar code readers, LSH3502AHV, is as follows.

Transmission rate	Data length	Stop bit	Parity bit
9600bps	7	2	Even

* This function is supported only by the GP2000 (except GP-2301/2401/2501/2601/2301H/2401H) Series units.

For Olympus Symbol's bar code reader

Model: LS4004i

- Wiring diagram

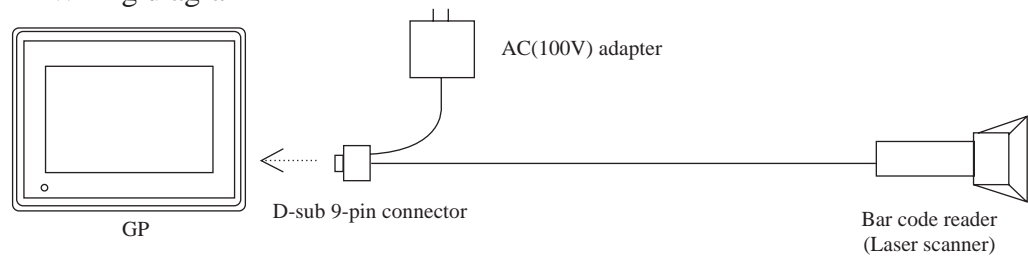

*The bar code reader is directly connected to the GP.

Direction of signal

GP			Direction of signal	Barcode reader	
Signal	Input/Output	Pin		Pin	Signal
CD	Input	1		1	NC
RD	Input	2	←	2	SD(TXD)
SD	Output	3	→	3	RD(RXD)
ER	Output	4		4	NC
SG	-	5		5	SG
DR	Input	6	←	6	DTR
RS	Output	7	→	7	CS(CTS)
CS	Input	8	←	8	RS(RTS)
RI/VCC	Input/Output	9		9	NC

Communication settings

The communication settings of the extended serial I/F of the GP is specified as the initial data of the bar code reader.

The initial data of Imex's bar code readers, LS4004i, is as follows.

Transmission rate	Data length	Stop bit	Parity bit
9600bps	8	1	None

* This function is supported only by GP2000 (except GP-2301/2401/2501/2601/2301H/2401H) Series units.

For Olympus Symbol's bar code reader

Model: VS4004

- Wiring diagram

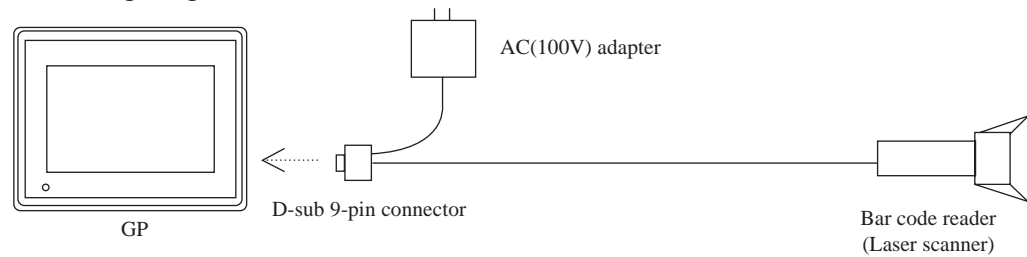

*The bar code reader is directly connected to the GP.

Direction of signal

GP			Direction of signal	Barcode reader	
Signal		Pin		Pin	Signal
CD	Input	1		1	NC
RD	Input	2	←	2	SD(TXD)
SD	Output	3	→	3	RD(RXD)
ER	Output	4		4	NC
SG	-	5		5	SG
DR	Input	6	←	6	DTR
RS	Output	7	→	7	CS(CTS)
CS	Input	8	←	8	RS(RTS)
RI/VCC	Input/ Output	9		9	NC

Communication settings

The communication settings of the extended serial I/F of the GP is specified as the initial data of the bar code reader.

The initial data of Imex's bar code readers, VS4004, is as follows.

Transmission rate	Data length	Stop bit	Parity bit
9600bps	8	1	None

The VS4004, Serial-code reader, can also read the one-dimensional bar code.

* This function is supported only by the GP2000 (except GP-2301/2401/2501/2601/2301H/2401H) Series units.

For Olympus Symbol's bar code reader

Model: VS4004

- Wiring diagram

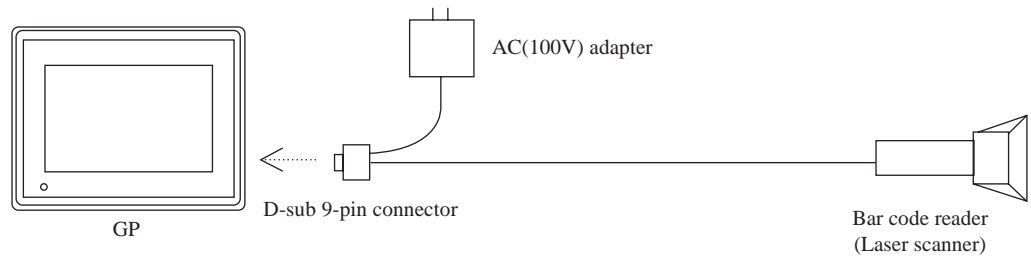

*The bar code reader is directly connected to the GP.

Direction of signal

GP			Direction of signal	Barcode reader	
Signal		Pin		Pin	Signal
CD	Input	1		1	NC
RD	Input	2	←	2	SD(TXD)
SD	Output	3	→	3	RD(RXD)
ER	Output	4		4	NC
SG	-	5		5	SG
DR	Input	6	←	6	DTR
RS	Output	7	→	7	CS(CTS)
CS	Input	8	←	8	RS(RTS)
RI/VCC	Input/ Output	9		9	NC

Communication settings

The communication settings of the extended serial I/F of the GP is specified as the initial data of the bar code reader.

The initial data of Imex's bar code readers, LS6004, is as follows.

Transmission rate	Data length	Stop bit	Parity bit
9600bps	8	1	Even

* This function is supported only by GP2000 (except GP-2301/2401/2501/2601/2301H/2401H) Series units.

Denso's bar code reader

Model: VS4004

- Wiring diagram

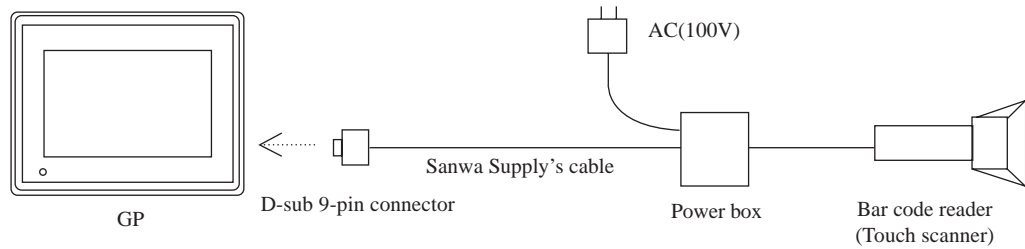

*Sanwa Supply's cable (KRS-423XF1K) is necessary to connect the bar code reader with the GP.

Direction of signal

GP			Direction of signal	Cable			Direction of signal	Barcode reader	
Signal		Pin		Pin	Wiring	Pin		Pin	Signal
CD	Input	1	←	1	[Wiring diagram showing connections between GP pins 1-9 and Barcode reader pins 1-9]	1	←	1	NC
RD	Input	2	←	2		2	←	2	SD(TxD)
SD	Output	3	→	3		3	→	3	RD(RxD)
ER	Output	4	→	4		4	→	4	RTS
SG	-	5		5		5	→	5	CTS
DR	Input	6		6		6		6	NC
RS	Output	7		7		7		7	SG
CS	Input	8		8		8		8	NC
RI/VCC	Input/O utput	9		9		9		9	NC
								20	
								22	

Communication settings

The communication settings of the extended serial I/F of the GP is specified as the initial data of the bar code reader.

The initial data of Imex's bar code readers, VS4004, is as follows.

Transmission rate	Data length	Stop bit	Parity bit
9600bps	8	1	None

* This function is supported only by the GP2000 (except GP-2301/2401/2501/2601/2301H/2401H) Series units.

For Keyence bar code reader

Model: BL-80R

- Wiring diagram

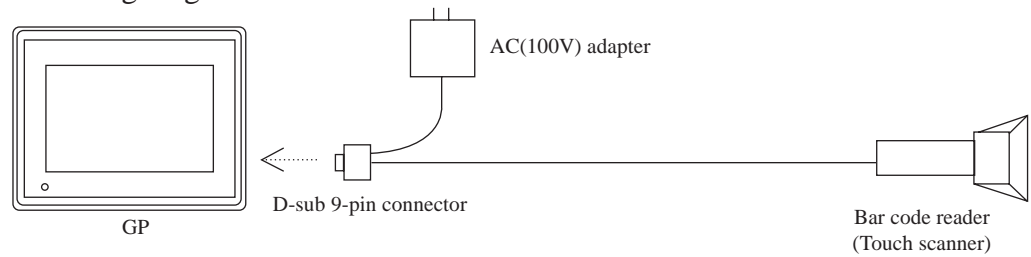

*The bar code reader is directly connected to the GP.

Direction of signal

GP			Direction of signal	Barcode reader	
Signal		Pin		Pin	Signal
CD	Input	1		1	NC
RD	Input	2	←	2	SD(TXD)
SD	Output	3	→	3	RD(RXD)
ER	Output	4	→	4	-
SG	-	5		5	SG
DR	Input	6	←	6	-
RS	Output	7	→	7	CS(CTS)
CS	Input	8	←	8	RS(RTS)
RI/VCC	Input/ Output	9		9	NC

Communication settings

The communication settings of the extended serial I/F of the GP is specified as the initial data of the bar code reader.

The initial data of Imex's bar code readers, BL-80R, is as follows.

Transmission rate	Data length	Stop bit	Parity bit
9600bps	7	1	Even

* This function is supported only by GP2000 (except GP-2301/2401/2501/2601/2301H/2401H) Series units.



4.10 256-color Mode

4.10.1 Overview

The GP2300T/2400T/2500T/2501T/2600T Series features a 256-color mode as well as the previous 64-color mode. Drawing data and image data can both be displayed with 256 colors. However, blink settings are not available in 256-color mode.

4.10.2 256-color Mode Correspondence

- 256 colors are available for drawing data, image data and tags.
- When the 64/256-color modes are switched, all screens (including the windows) are displayed in the selected mode. (The modes cannot be switched for individual windows.) 64/256-color mode setting can be configured on the [GP Setup/Initial Screen Settings] tab.
- When a hard copy of a screen is printed in 256-color mode with the print setting set to "Color Print" mode, the color is reduced from 256 to 64 colors, and the hard copy is printed in pseudo 64 colors. When the print setting is set to "Gray-scale Print", the color is reduced and the hard copy is printed in pseudo 5 colors (gray levels). However, when a hard copy of a 64-color screen is printed in 256-color mode, the hue of the printout may be slightly different from the 64-color mode image. Alarm messages, Q-tag, and logging data are printed in 8 colors or in black.



- **Switching between 64-color mode and 256-color mode can be done only with the drawing editor but not with the GP off-line.**
- **The transparent color in the background of the drawing data (which is specified by the background color, black + Medium-speed Blinking in 64-color mode) is allocated to the color code, 80H (color palette number 255). Therefore, the background colors for the drawing data are 255 colors + the transparent color. For displaying drawing data and image data, 256 colors are available.**
- **If you create screen data where the blink settings are specified in 64-color mode for the image data and display the screen data in 256-color mode, the colors will not display correctly.**
- **Do not specify a transparent color as the clear color for the background color, the A, a, X and Q-tags, the file item indicator and the logging indicator that are created in 256-color mode. Otherwise, the display cannot be updated correctly.**
- **Filling the tiling pattern with black is not available in 256-color mode.**

**This function is supported only by GP2000 Series units.*



- The GP displays black on the screen in 256-color mode when the circle of graph tag (D-tag, G-tag, g-tag), and the graph pattern setting of the half circle sets normal, or the display color of circle graph parts, the half circle graph, and the tank graph are set to the color code 0x80 (the darkest green).
- When using a Tank Graph, the data display area turns the color code 0x80 (the darkest green) for a moment right after switching the screen mode.
- When K-tag and logging functions are edited, the cursor does not blink.

4.10.3 Monochrome (eight levels of gray) mode

Using the monochrome (eight levels of gray) mode, you can display screens, Parts and images, as well as perform screen capture (JPEG file is saved to GP's CF Card).



- Monochrome (eight levels of gray) mode can be used only with monochrome LCD type GP2000 series units (GP-2301HL, GP-2300L, GP-2301L, GP-2500L and GP-2501L).

■ Monochrome (eight levels of gray) settings

Set the "Color Setting" option of the "GP Setup | Initial Screen Settings" to "MONOCHROME 8 HUES".



- Color Setting cannot be changed via the GP unit's OFFLINE screen.

■ Monochrome (eight levels of gray) display

For a monochrome LCD type GP unit, the colors of the Parts will be displayed as shown below.

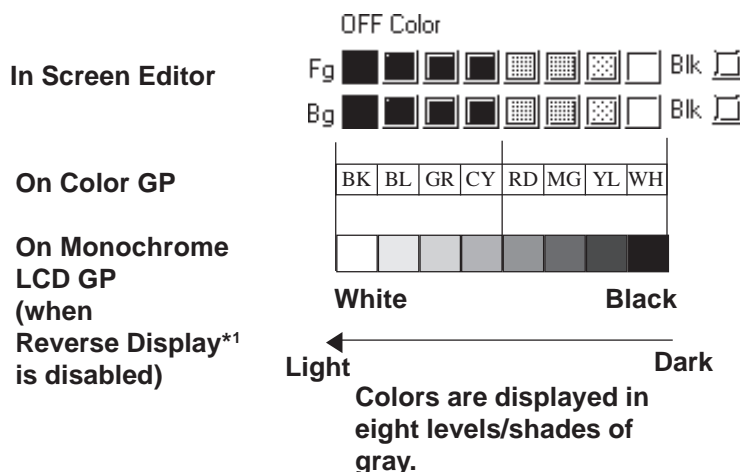

- Depending on the color used, selecting MONOCHROME 8 HUES may cause the GP unit's screen to flicker. Confirm the color before using this mode.

*1 Reverse Display set via the GP-PRO/PBIII's "GP Setup | I/O Settings" tab.

*This function is supported only by the GP2000 Series units.

■ **Screen Capture**

When using the monochrome (eight levels of gray) mode, you can save the screen (currently displayed on the GP unit) to the GP’s CF Card as a JPEG file. **Reference** 4.7.10 *Screen Capture*

■ **Printing out a GP Screen**

A GP screen can be printed out in monochrome (levels/shades of gray).



- This feature is available only with monochrome LCD type GP2000 series units that have a printer I/F (GP-2300L, GP-2500L and GP-2501L only).

[When printer type is PR201, EPSON (High Speed / High Quality) or HP LaserJetII]

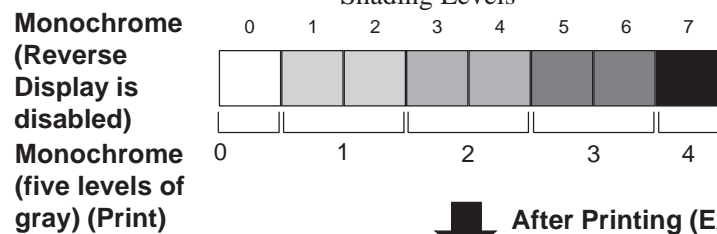

↓ **After Printing (Example)**

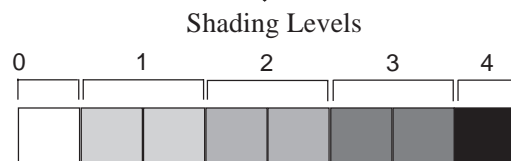

(When “Reverse Color Print” is checked)

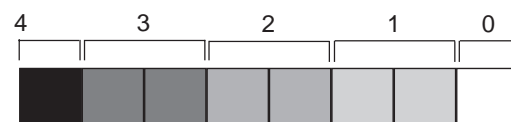

(When “Reverse Color Print” is not checked)



- The “Reverse Color Print” setting cannot be set or changed via the GP’s OFFLINE screen. For details regarding “Reverse Color Print”, **Reference** *Operation Manual 6.2 GP I/O Settings - GP System Settings* ♦ *I/O Settings*.
- With EPSON PM and Stylus printers, printing will be done in grayscale mode.

*This function is supported only by GP2000 Series units.

4.11 Backup SRAM Capacity

4.11.1 Overview

This new version of the GP2000 Series features a larger backup SRAM of 256KB.

* Note that the capacity of the GP-2301, GP-2501 and GP2000H Series is 128KB.

4.11.2 Backup SRAM Amounts for each type of GP

GP70 series (Only the unit installed backup SRAM)	32KB
GP77R series GP377 series	96KB
GP-2301 series GP-2501 series GP2000H series	128KB
GP2000 series	256KB

4.11.3 Backup SRAM Applications

Applications of the Backup SRAM depend on the settings used.

The following features can use the following amounts of SRAM space. Except for the System Data area, if the amount of space required by a feature is not explicitly specified (i.e. left unused), the area is not reserved for that feature.

Applications	E.g.) GP77R series (Total 96KB max.)	GP2301 series GP2501 series GP2000H series (Total 128KB max.)	GP2000 series (Total 256KB max.)
System Administration Area	128 bytes (fixed)	1KB (fixed)	1KB (fixed)
Japanese FEP Learning Function	-	1KB	1KB
Q-tag Alarm	28KB max.	38KB max.	38KB max.
Data Sampling Line Graph	64KB max.	127KB max.	255KB max.
LS Area Backup	8KB max.	24KB max.	24KB max.
Logging Data	95KB max.	127KB max.	255KB max.

■ Calculating Backup SRAM space

Refer to the following explanations about how to calculate the amount of backup SRAM space.

For Logging Data,

▼ **Reference** ▲ “4.3.1 Logging Function” and “4.3.8 Economy Mode”

For Filing Data,

▼ **Reference** ▲ “4.2.2 Filing Data (Recipe) Function”



4.12 Extended Functions of VM Unit

This section describes the extended functions that the GP-2500T/2600T Series supports when the GP Series is equipped with the VM unit.

The extended functions are as follows.

- Video window function
- VGA/SVGA display function

When the GP-2500T/2600T Series is equipped with the VM unit, the GP Series supports the extended function known as the Video Window Function as well as the conventional functions of the GP2000 Series. This chapter describes the Video Window Function.

4.12.1 Displaying Video Window

To display the video screen, specify the part of the GP that the video window should display (the video window display position), the dimensions of the video window (video window size), and which part of the video window should be displayed (the origin of the video display).

Two methods are available to control the video window.

▼ **Reference** ▲ *Operation Manual, 3.6.2 Video Settings*

Standard Mode

Displaying with the V-tag

Control of the video image - including the input channel, the video window display position, and the size of the video window - is specified with the V-tag.

▼ **Reference** ▲ *2.27 V-tag (Video Window Display)*

Displaying with the video control area

The video window can be displayed according to the information written in the video control area, regardless of whether a V-tag is present.

▼ **Reference** ▲ *4.12.2 Video Control Area*

Extended Mode

Displaying with the v-tag

The video screen is used to enter the video settings, and the v-tag is used to display a screen on a base screen. A v-tag allows you to call up a total of 4 image windows on a video window.

▼ **Reference** ▲ *2.28 v-tag (Extended Video Window Display)*

Displaying with the video control area

Even when the Video Control Area is used, you must also use a v-tag. The image window's display is designated via the data (settings) written to the Video Control Area.

▼ **Reference** ▲ *4.12.2 Video Control Area*

■ Resolution

The resolution of the GP screen differs from that of the video images of various video devices. When specifying the video window display position, the video window size, and the origin of the video display, be sure to consider this difference.

GP Resolution : 640x480 dots on the GP screen (GP2500T) or 800x600 dots (GP2600T)

		NTSC		PAL	
		GP-2500	GP-2600	GP-2500	GP-2600
Standard Mode	Standard	320 x 240	320 x 240	384 x 288	384 x 288
	Large	640 x 480	640 x 480	640 x 480 * ¹	768 x 576
Extended Mode	Normal	640 x 480	640 x 480	640 x 480 * ¹	768 x 576
	1/4 Size	320 x 240	320 x 240	384 x 288	384 x 288
	1/16 Size	160 x 120	160 x 120	192 x 144	192 x 144

*¹ When the GP-2500 unit's signal type is set to PAL, and Standard Mode's "Large" is selected, or when Extended Mode's "Normal" is selected, a portion of the screen will not be displayed.

		VGA		SVGA	
		GP-2500	GP-2600	GP-2500	GP-2600
Standard Mode	Standard	640 x 480	800 x 600* ²	640 x 480	680 x 480 * ³
Extended Mode	Normal	640 x 480	640 x 480	680 x 480 * ⁴	800 x 600
	1/4 Size	320 x 240	320 x 240	400 x 300	400 x 300
	1/16 Size	160 x 120	160 x 120	200 x 150	200 x 150

*² When using the GP-2500 in Standard mode with SVGA input, an 800 x 600 screen will be compressed to 640 x 480. (The above feature cannot be used in Extended mode.)

*³ When using the GP-2600 in Standard mode with VGA input, an 640 x 480 screen will be expanded to 800 x 600. (The above feature cannot be used in Extended mode.)

*⁴ When the GP-2500 unit's signal type is set to SVGA, a portion of the screen will not be displayed. (The above feature cannot be used in Standard mode.)



• **A V-tag and a v-tag (small v) cannot be used at the same time.**

4.12.2 Video Control Area

The video control area is the area in which the video information is controlled (address +0 to +21). Each address has each of the functions and the attribute that is controlled is written in the corresponding address. The video is displayed with the attribute. The following table details the functions.

Mode	Start Address of Video Control Area
Standard Mode	LS20 to LS2010, LS2096 to LS8170
Extend Mode	LS20 to LS1989, LS2096 to LS8149

When using the Video Control Area, you can display a video window or an image window while the GP is in RUN mode. For details about the Video Control Area, refer to 4.9.3 Standard Mode and 4.9.4 Extended Mode.



In Standard Mode, you can disable the video control area. When either “Do not change Image Window display settings during RUN mode” or “Do not perform Image Window capture” are used, there is no need to use the video control area.

Reference *Operational Manual, 3.6.2 Video Settings*

4.12.3 Standard Mode

■ Video Control Area

Word Address	Contents	Bit	Remarks
+0	Video ID number	1 to 8999 (However, when input with BCD, 1 to 1999) ^{*1}	Write FFFFHex to display the video window according to the information written in the video control area.
+1	Video Window Control Command Bit 8 will be turned OFF after the ID number loading is finished.	0	Video Window Display Mode (0: No display, 1: Display)
		1	Video Display Size ^{*2} (0: Standard Mode, 1: Large Mode)
		2	Transparent Display (0: Invalid, 1: Valid)
		3	Transparent Run Mode (0: Transparent display of colors except specified colors, 1: Transparent display of specified colors)
		4	Prohibit Touch Input within Video Window (0: Input Valid, 1: Prohibited)
		5	Still (Video Screen Static) (0: Animation, 1: Static Screen)
		6 to 7	Unused (Reserve)
		8	Video ID Reload ^{*3}
		9 to 15	Unused (Reserve)
+2	Input Channel Number	0 to 3	
+3	Transparent Color	0 to 63 (64-color mode) 0 to 255 (256-color mode)	
+4	Video Window Display Function (X-coordinate [GX])	0 to 615 (GP-2500T) 0 to 775 (GP-2600T)	
+5	Video Window Display Function (Y-coordinate [GY])	0 to 455 (GP-2500T) 0 to 575 (GP-2600T)	
+6	Width of Video Window [DX]	GP-2500T NTSC: Standard Mode: 25 to 320, Large Mode: 25 to 640 PAL: Standard Mode: 25 to 384, Large Mode: 25 to 640 GP-2600T NTSC: Standard Mode: 25 to 320, Large Mode: 25 to 640 PAL: Standard Mode: 25 to 384, Large Mode: 25 to 768	
+7	Height of Video Window [DY]	GP-2500T NTSC: Standard Mode: 25 to 240, Large Mode: 25 to 480 PAL: Standard Mode: 25 to 384, Large Mode: 25 to 480 GP-2600T NTSC: Standard Mode: 25 to 240, Large Mode: 25 to 480 PAL: Standard Mode: 25 to 288, Large Mode: 25 to 576	
+8	Point of Origin of Video Display (X-coordinate) [VX]	NTSC: 0 to 639 PAL: 0 to 767	
+9	Point of Origin of Video Display (Y-coordinate) [VY]	NTSC: 0 to 479 PAL: 0 to 575	

Word Address	Contents		Bit	Remarks
+10	Internal Video Window Control Flag - Actions indicated in the right are performed while the bit is ON. - Bits 6 to 8 are for specifying the mode. Turn one of the bits to ON to specify each mode.		0	Update of Coordinate
			1	Unused (Reserve)
			2	UP Operation *4
			3	DOWN Operation *4
			4	RIGHT Operation *4
			5	LEFT Operation *4
			6	Move Mode
			7	Size Change Mode
			8	Scroll Mode
			9 to 15	Unused (Reserve)
+11	Brightness	Channel 0	Low <-> High: 0 to F	
+12	Contrast		Low <-> High: 0 to F	
+13	Hue		Greenish hue <-> Reddish hue: 0 to F	
+14	Brightness	Channel 1	Low <-> High: 0 to F	
+15	Contrast		Low <-> High: 0 to F	
+16	Hue		Greenish hue <-> Reddish hue: 0 to F	
+17	Brightness	Channel 2	Low <-> High: 0 to F	
+18	Contrast		Low <-> High: 0 to F	
+19	Hue		Greenish hue <-> Reddish hue: 0 to F	
+20	Internal Color Control Flag - Actions indicated on the right are performed while the bit is ON. - When a bit is turned ON, the bit is held until the power supply is turned OFF, or the mode is switched from off-line mode to restart mode. - Bits 6 to 8 are for specifying the mode. Turn one of the bits to ON to specify each mode.		0	Update of Color Value
			1	Unused (Reserve)
			2	Color Value +
			3	Color Value -
			4	Unused (Reserve)
			5	Unused (Reserve)
			6	Brightness Adjustment Mode
			7	Contrast Adjustment Mode
			8	Color Adjustment Mode
			9 to 15	Unused (Reserve)
+21	Brightness, Contrast, Hue	Channel 3	0 to 3	Brightness: (Low <-> High: 0 to F)
			4 to 7	Contrast: (Low <-> High: 0 to F)
			8 to 11	Hue: (Greenish hue <-> Reddish hue: 0 to F)
			12 to 15	Unused (Reserve)

**Note:**

- Data is processed in 1-word (16-bit) length in the video control area. Therefore, if the host device uses a 32-bit length, the data cannot be displayed through the video control.
- When setting the data in the video control area, be sure to set the data within the specified range. Otherwise, the data may not display correctly (the image may not appear clearly).

*1 Write 1 to 8999 (1 to 1999 when input with BCD) when selecting "Display with V-Tag" as the control method. Write "FFFFHex" to select "Display with Video Control Area."

*2 The video image is double-zoomed.

*3 Returns to the value specified with the V-tag.

*4 To control the window via touch operation during GP operation, determine the applicable mode (6 to 8) first (turn ON the applicable bit). Then select the applicable operation (2 to 5) (turn ON the applicable bit).

■ ID Number (Word Address +0)

The video ID number area (address +0) in the video control area is where the ID number to specify the V-tag is written. For more information on the operation and applications of the V-tag,

▼Reference▲ 2.27 V-tag (Video Window Display)



Note:

- When V-tags exist whose ID numbers are met on the current base screen, call the V-tag information to the addresses +1 to +9 in the video control area to display the video window.
- When no V-tags exist whose ID numbers appear on the current base screen, the video window is not displayed.

■ Specifying the Video Window Display Position

(GX-GY- Word Addresses +4, +5)

Specify in which part of the GP screen the video window should be displayed. The video window is displayed in the quadrangle. Specify the upper left corner of the quadrangle as the point of origin. The video window is positioned relative to the point of origin. The video window display position (GX-GY) is specified by the resolution of the GP.

GP-2500T

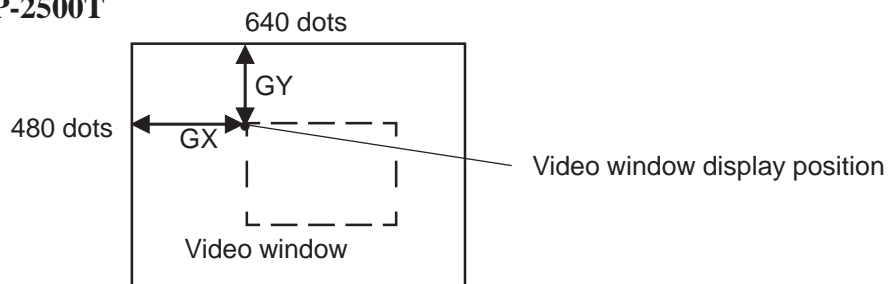

GP-2600T

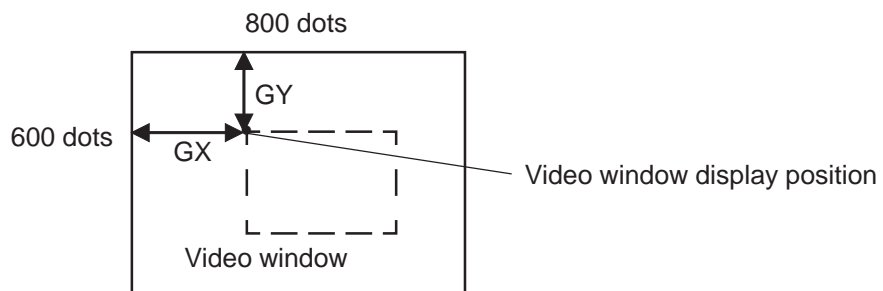

■ Specifying the Video Window Size

(DX, DY - Word Addresses +6, +7)

The point specified with the video window display position (GX/GY) is the “start” (zero) point for screen position and determines the video window size. Specify the width (DX) and height (DY) of the video window based on your GP unit’s screen resolution.

GP-2500T

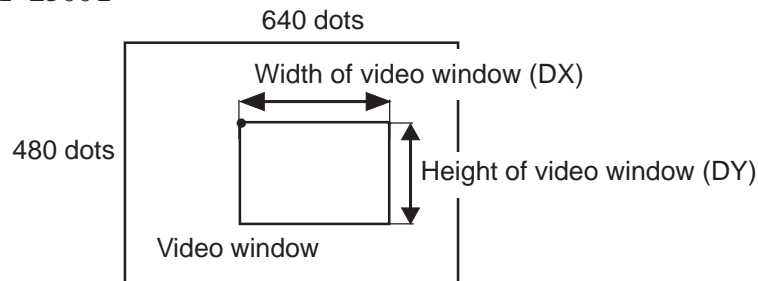

GP-2600T

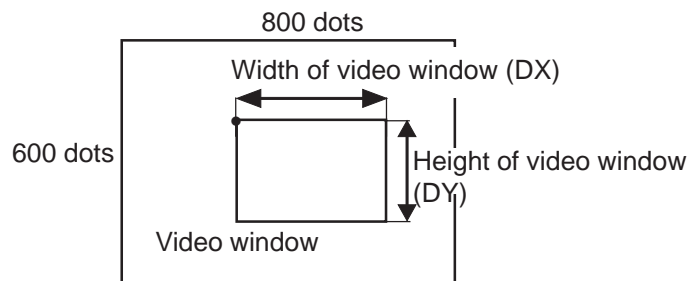

Note: • Maximum size of the video window

	GP-2500T	GP-2600T
NTSC	Standard: 320 X 240, Expansion: 640 X 480	
PAL	Standard: 384 X 288	
	Expansion: 640 X 480	Expansion: 768 X 576

• The minimum size is 25 x 25 dots in both modes.



• The start point of the video window display position (GX/GY) should be specified so that the video window is displayed within the resolution of the GP. When the video window is specified outside of the GP’s resolution, the video window will not be displayed. If you want to display the entire video window, the total values of (DX)+(GX) and (DY)+(GY) should be within the GP’s resolution.

GP-2500T:

DX+GX ≤ ... 640

DY+GY ≤ ... 480

GP-2600T:

DX+GX ≤ ... 800

DY+GY ≤ ... 600

■ Setting the Video Display Origin Point

(VX/VY - Word Address +8, +9)

This setting determines where the video screen should be displayed. The origin point of the video display (VX/VY) is specified via the video resolution feature.

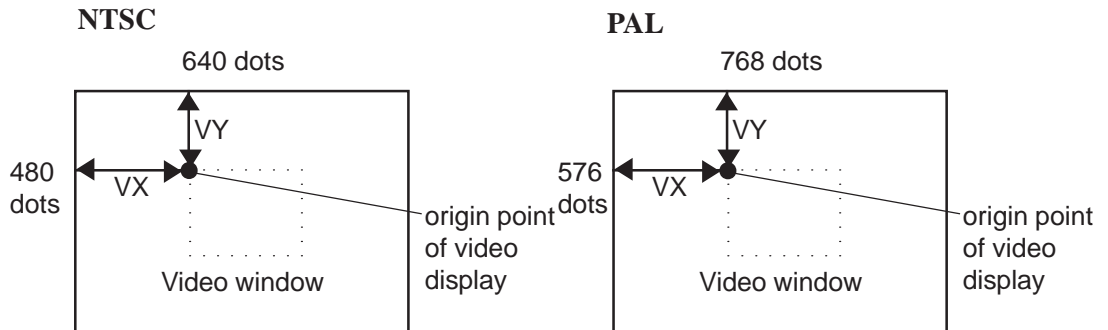

Note: When specifying the origin point of the video display, consider both the mode used (standard mode or large mode) and the video window size.

<Standard Mode>

An area whose width and height are two times greater than those of the video window is displayed on the video screen. The total value of $DX \times 2 + VX$ and $DY \times 2 + VY$, respectively, should be within the area of the video screen (600 x 480 dots).

$$DX \times 2 + VX \leq \dots 640$$

$$DY \times 2 + VY \leq \dots 480$$

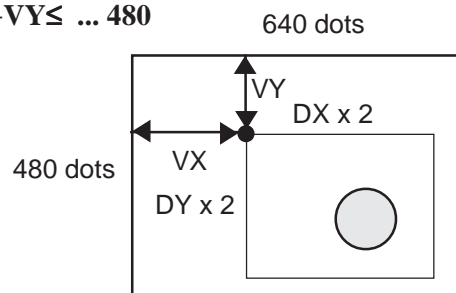

<Large Mode>

An area whose width and height are the same as the width (DX) and height (DY) of the video window, respectively, is displayed on the video screen. The total values of $DX + VX$ and $DY + VY$, respectively, should be within the area of the video screen (600 x 480 dots).

$$DX + VX \leq \dots 640$$

$$DY + VY \leq \dots 480$$

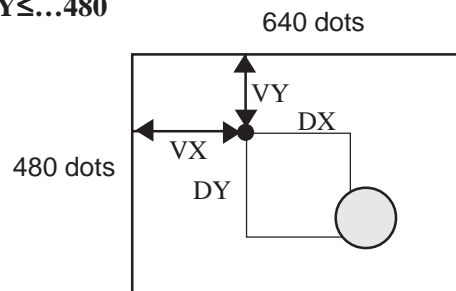

■ Internal Window Control Flag (Word Address +10)

The internal window control flag (address + 10) is the area used for changing the display conditions of the video window.

Use the following steps to make these changes.

- 1) Specify bits 6 to 8 of Word Address 10 to designate the Mode.
- 2) Specify bits 2 to 5 of Word Address 10 to designate the action performed.
- 3) Increment or decrement the value of addresses +4 to +9 to control the video display.

Write the bit for the internal window control flag with the T-tag (touch panel input) to move the video window, change its size, or scroll it.



- **Even if the coordinate value is written in the address (+4 to +9) in the video control area, the display conditions of the video window cannot be changed unless the update bit of the coordinate value of the internal window control flag (address +10) is turned ON.**
- **Once the coordinate value update bit is turned ON, the ON condition is maintained. Therefore, the display conditions of the video window are changed in real time according to the coordinate value written until the bit is turned OFF.**
- **Even if touch panel input is prohibited via the video window settings, touch input is possible when the video window is not displayed.**

■ Internal Color Control Flag (Word Address +20)

The internal color control flag (address +20) is an area used for changing the color display condition of the video window only with the GP.

- 1) Specify bits 6 to 8 of Word Address +20 to designate the Mode.
- 2) Specify the bit 0 of Word Address +20 to be ON.
- 3) Specify bits 2 to 3 of Word Address +20 to adjust the color.

When the bit for the internal color control flag is written with the T-tag (touch panel input), the color display condition of the window can be changed.



- **Even if the color value is written in the address (+11 to +19) in the video control area, the display conditions of the video window cannot be changed unless the update bit of the color value of the internal window control flag (address +20) is turned ON.**
- **Once the color value update bit is turned ON, the ON condition is maintained. Therefore, the display conditions of the video window are changed in real time according to the written color value until the bit is turned OFF.**

4.12.4 Extended Mode

■ Video Control Area

Word Address	Usage	Bit No.	Details
+0	Video Shared Control Commands	0	Transparent Display (0: Invalid, 1: Valid)
		1	Transparent Mode (0: Transparent display of colors except specified colors, 1: Transparent display of specified colors)
		2	Prohibit Touch Input within Video Window (0: Input Valid, 1: Prohibited)
		3	Unused (Reserve)
		4	Capture Output (0: None, 1: Start)
		5 to 15	Unused (Reserve)
+1	Video Shared Control Status	0 to 1	Capture Status (0: None, 1: Now capturing, 2: Completed ^{*1})
		2 to 11	Unused (Reserve)
		12 to 15	JPEG Error Code
+2	JPEG Capture File No.	0 to 65535	
+3	Transparent Color 1	0 to 63 (64-color mode) 0 to 255 (256-color mode)	
+4	Transparent Color 2	0 to 63 (64-color mode) 0 to 255 (256-color mode)	
+5	Transparent Color 3	0 to 63 (64-color mode) 0 to 255 (256-color mode)	
+6	Image Window Display Control	0 to 3	Image Window 0
		4 to 7	Image Window 1
		8 to 11	Image Window 2
		12 to 15	Image Window 3
+7	Image Window 0	JPEG File Number	
+8	Image Window 1	JPEG File Number	
+9	Image Window 2	JPEG File Number	
+10	Image Window 3	JPEG File Number	

*1 Effective only when the Capture-completed Bit is enabled in the [Capture Operation Setting (Screen/Video)] field via [GP Settings/Extended Settings/Capture Settings].

▼ Reference ▲ 4.7.10 Screen Capture

* This function is supported only by the GP-2500T/2600T series units.

+11	Internal Image Window Control Flag Displays on right side when bit turns ON.	0	Coordinate position change	
		1	Unused (Reserve)	
		2	UP	
		3	DOWN	
		4	RIGHT	
		5	LEFT	
		6	Unused (Reserve)	
		7	Unused (Reserve)	
		8	Color value change	
		9	Unused (Reserve)	
		10	Color value +	
		11	Color value -	
		12	Brightness adjustment mode	
		13	Contrast adjustment mode	
		14	Hue adjustment mode	
15	Unused (Reserve)			
+12	Internal Video Control Channel Number	0:Channel 0 1:Channel 1 2:Channel 2 3:Channel 3 4:PC Display		
+13	Video Window Control Command ^{*1}	Video Channel 0 Info.	0	Video DisplayMode (0:Standard Mode 1:1/4 Mode 2:1/16 Mode 3:Reserved)
			1	
			2	Still (Frozen display) (0:Moving display 1:Still display)
			3 to 15	Unused (Reserve)
			+14	Video screen origin point (VX)
+15	Video screen origin point (VY)	NTSC: 0 to 479, PAL: 0 to 575		
+16	Brightness	(Low <-> High: 0 to F)		
+17	Contrast	(Low <-> High: 0 to F)		
+18	Hue	(Green hue <-> Red hue: 0 to F)		

* This function is supported only by the GP-2500T/2600T series units.

Word Address	Usage	Bit No.	Details			
+19	Video Window Control Command *1	Video Channel 1 Info.	0	Video Display Mode (0:Standard Mode		
			1	1:1/4 Mode 2:1/16 Mode 3:Reserved)		
			2	Still (Frozen display) (0:Moving display 1:Still display)		
			3 to 15	Unused (Reserve)		
			+20	Video screen origin point (VX)	NTSC: 0 to 639, PAL: 0 to 767	
			+21	Video screen origin point (VY)	NTSC: 0 to 479, PAL: 0 to 575	
			+22	Brightness	(Low <-> High: 0 to F)	
+23	Contrast	(Low <-> High: 0 to F)				
+24	Hue	(Green hue <-> Red hue: 0 to F)				
+25	Video Window Control Command *1	Video Channel 2 Info.	0	Video Display Mode (0:Standard Mode		
			1	1:1/4 Mode 2:1/16 Mode 3:Reserved)		
			2	Still (Frozen display) (0:Moving display 1:Still display)		
			3 to 15	Unused (Reserve)		
			+26	Video screen origin point (VX)	NTSC: 0 to 639, PAL: 0 to 767	
			+27	Video screen origin point (VY)	NTSC: 0 to 479, PAL: 0 to 575	
			+28	Brightness	(Low <-> High: 0 to F)	
+29	Contrast	(Low <-> High: 0 to F)				
+30	Hue	(Green hue <-> Red hue: 0 to F)				
+31	Video Window Control Command *1	Video Channel 3 Info.	0	Video Display Mode (0:Standard Mode		
			1	1:1/4 Mode 2:1/16 Mode 3:Reserved)		
			2	Still (Frozen display) (0:Moving display 1:Still display)		
			3 to 15	Unused (Reserve)		
			+32	Video screen origin point (VX)	NTSC: 0 to 639, PAL: 0 to 767	
			+33	Video screen origin point (VY)	NTSC: 0 to 479, PAL: 0 to 575	
			+34	Brightness	(Low <-> High: 0 to F)	
+35	Contrast	(Low <-> High: 0 to F)				
+36	Hue	(Green hue <-> Red hue: 0 to F)				

* This function is supported only by the GP-2500T/2600T series units.

Word Address	Usage	Bit No.	Details	
+37	Video Window Control Command ^{*1}	PC Display Info.	0	Video Display Mode (0:Standard Mode
			1	1:1/4 Mode 2:1/16 Mode 3:Reserved)
			2	Still (Frozen display) (0:Moving display 1:Still display)
			3 to 15	Unused (Reserve)
+38	PC Display origin point (VX)		VGA: 0 to 639, SVGA: 0 to 799	
+39	PC Display origin point (VY)		VGA: 0 to 479, SVGA: 0 to 599	
+40	Reserved		Unused (Reserve)	
+41	Reserved		Unused (Reserve)	
+42	Reserved		Unused (Reserve)	

**Note:**

- Data is processed in 1-word (16-bit) length in the video control area. Therefore, if the host device uses a 32-bit length, the data cannot be displayed through the video control.
- When setting the data in the video control area, be sure to set the data within the specified range. Otherwise, the data may not display correctly (the image may not appear clearly).

**important*****1**

- Video display size cannot be changed while in “Still” mode.
- When capturing screen data in Still mode, the Still screen is captured.
- When changing Image window display control from “External Input Device” to “JPEG Display” while in Still mode, you will not be able to re-enter External Input Device mode until Still mode is released.

■ Video Shared Control Command (Word Address +0)

The Video Shared Control Command area is used to control the actions performed inside the video window.

- This area, when a video window is displayed, will use the V-screen setting values for its initial values.
- When the transparent display is “Valid”, The transparent color data used is taken from word addresses +3 to +5. If this display is not used, FFFF(h) is stored to these addresses. Also, when a color is displayed that is outside of the designated colors, only transparent color 1 (word address +3) is used.

* This function is supported only by the GP-2500T/2600T series units.

- When creating capture output, the currently displayed video image is saved to the image window designated in the V-screen, using the JPEG format. The image saved is converted to JPEG and output as a pre-scaling original image. (An NTSC signal image is 640 x 480 dots, and a PAL image, on the GP2500 is 640 x 480, and on the GP2600 is 768 x 576.)
- During image capture, all tag processing and video displays are stopped.
- If the same file already exists on the CF Card, it will be overwritten.



Screen capture typically requires from 2 to 3 seconds, at 80% quality.

■ Video Shared Control Status (Word Address +1)

The Video Shared Control Status area is used to record the result of the actions performed inside the video window. These items are as follows.

- Capture Status

This area turns ON while a JPEG file is being captured.

- JPEG Error Codes

When an error occurs during image capture or during the display on an existing JPEG image, an error code is written to this address. This code is retained until the next image is captured.

Number	Meaning	Details
0 (0000)	Normal Completion	Processing was completed normally.
1 (0001)	JPEG Image is over 800 x 600 dots	An image larger than 800 x 600 dots was displayed.
2 (0010)	Non-supported sample ratio	The JPEG file displayed uses a non-supported sample ratio.
3 (0011)	Other type of compression/expansion error	During either capture (compression) or JPEG file display (length), an internal error has occurred.
4 (0100)	No CF Card	During capture or during JPEG data file display, either the CF Card is not inserted, or the CF Card cover is not closed.
5 (0101)	CF Card Write error	Either the amount of free space remaining on the CF Card is insufficient, or the CF Card was removed during data saving.
6 (0110)	CF Card Read error	During the call up of a JPEG file from the CF Card, either the designated file name does not exist, or the CF Card was removed during readout.
7 (0111)	CF Card error	CF Card has not been formatted yet.
8 (1000)	Cannot Be Saved	The video image can be saved in its original size (1 x 1) in PAL mode. The original image cannot be saved in 1/4 and 1/16 sizes. *1
9 (1001)	Value Exceeded for the Auto Increment File Number	The file name exceeds 65535 when the Auto Increment File Number function is enabled and the file number for the JPEG files of video captures is set to Indirect mode.

*1 This error will not occur with VM Units bearing revision number Rev. A-2 or higher. Image captures that are 1/4 or 1/16 the size of the original image can be saved.

* This function is supported only by the GP-2500T/2600T series units.

■ Image Window Display Control (Word Address +6)

This data is used to designate the image displayed in the Video Window. You can select from “External Input Device” or “CF Card JPEG Image”. If External input device is selected, this becomes the input channel selected in the “Video Screen” area.

This data is used to designate the image displayed in the Video Window. You can select from “External Input Device” or “CF Card JPEG Image”. If External input device is selected, this becomes the input channel selected in the “Video Screen” area.

If “CF Card JPEG Image” is selected, the “expansion/compression” feature can be used. The JPEG file names displayed correspond to the file number areas used. JPEG images up to 800 x 600 can be displayed.

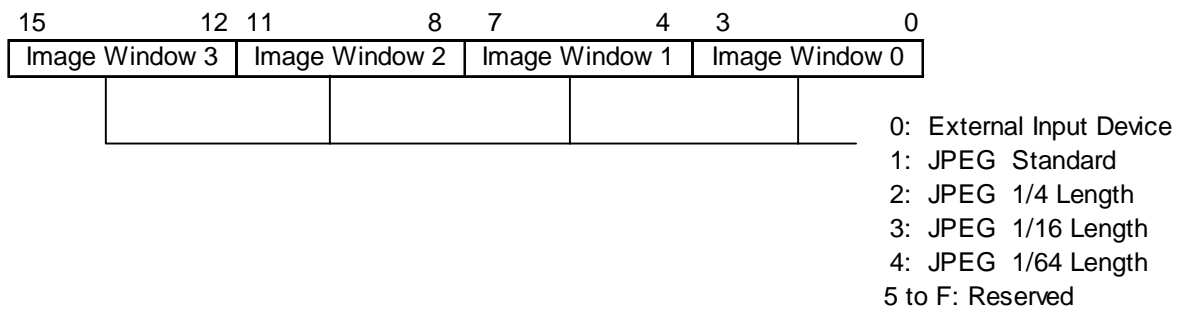

- **When using JPEG's initial settings, the “Window Display Image Control Flag” setting's External Input <--> JPEG Switching becomes invalid (disabled).**
- **When writing in data, expansion/compression cannot be performed.**

■ Internal Image Window Control Flag (Word Address +11)/

Internal Video Control Channel Number (Word Address +12)

This area is used to change the conditions of the image window display.

1. The channel number of the image to be changed is stored in the Internal Video Control Channel Number (Word address +12).
2. The display condition is changed via the Internal Image Window's Control Flag.



- **When the Coordinate Value Change Bit is turned ON, it will remain on. As a result, until this bit is turned OFF, the image window's real-time display will be changed according to this value. Also, when the video window is ON (displayed), this area is set to “0” (cleared).**
- **Even though touch panel input is prohibited inside the video window, once the image window's display has been turned “OFF”, touch panel input can be resumed.**

* This function is supported only by the GP-2500T/2600T series units.

■ **Video Display Origin Point (VX/VY)** [Video channels and PC Display]

This setting determines which of the video channels will be displayed. The video display's origin point (VX, VY) is designated via the (Video) Quality setting.

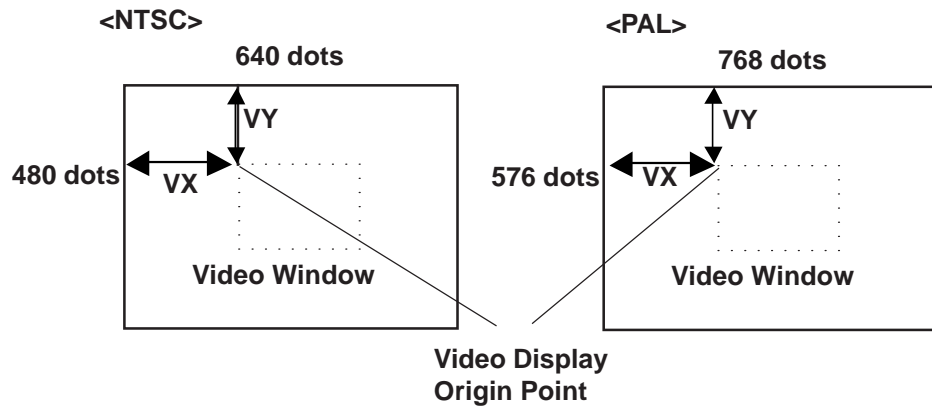

Note: When designating the Video Display Origin Point, be sure to consider the video modes (standard, 1/4, and 1/16) and the video window's size. (The following example uses the GP2500 Series unit.)

<In Standard Mode>

When designating VX and VY values, be sure that the sum of the video image's width (DX) and VX, as well as the sum of the height (DY) and VY do not exceed the borders of the image window.

$$DX + VX < 640$$

$$DY + VY < 480$$

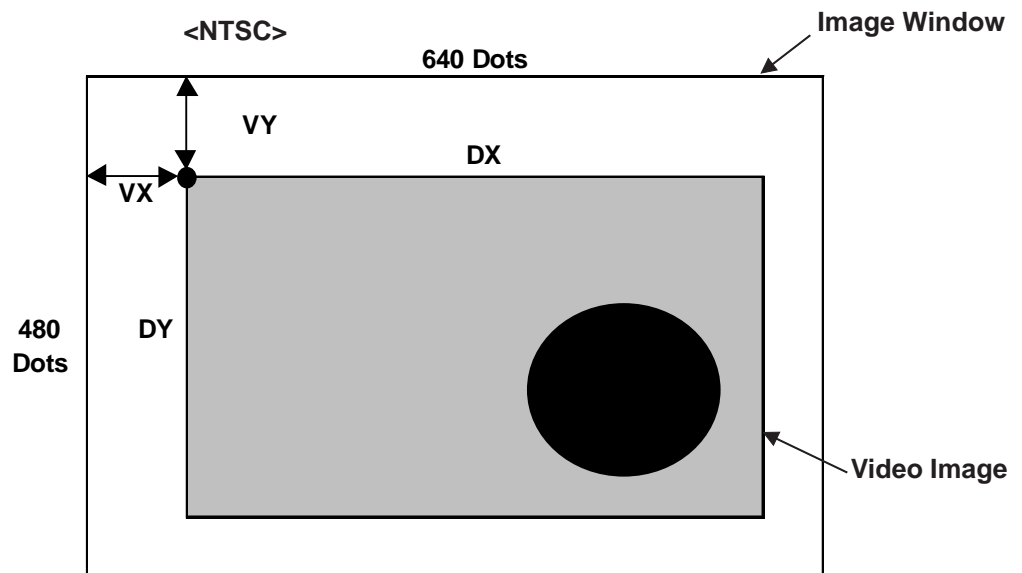

* This function is supported only by the GP-2500T/2600T series units.

<In 1/4 Mode>

When designating VX and VY values, be sure that the sum of two times (2x) the video image's width (DX) and VX, as well as the sum of two times (2x) the height (DY) and VY do not exceed the borders of the image window.

$$(DX \times 2) + VX < 640$$

$$(DY \times 2) + VY < 480$$

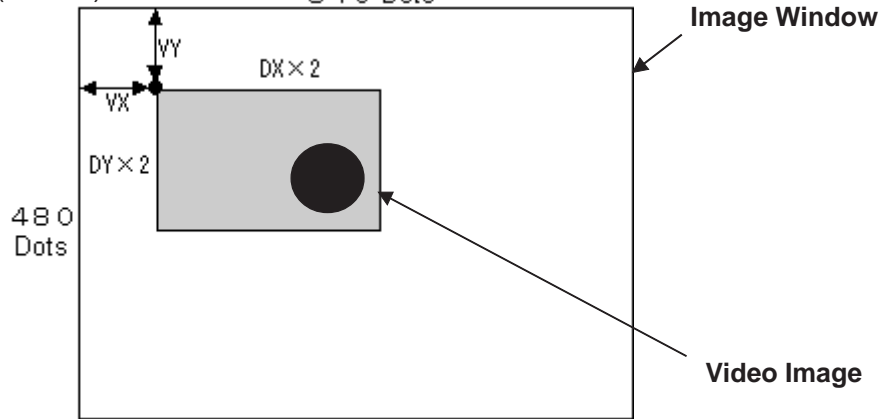
**<In 1/16 Mode>**

When designating VX and VY values, be sure that the sum of four times (4x) the video image's width (DX) and VX, as well as the sum of four times (4x) the height (DY) and VY do not exceed the borders of the image window.

$$(DX \times 4) + VX < 640$$

$$(DY \times 4) + VY < 480$$

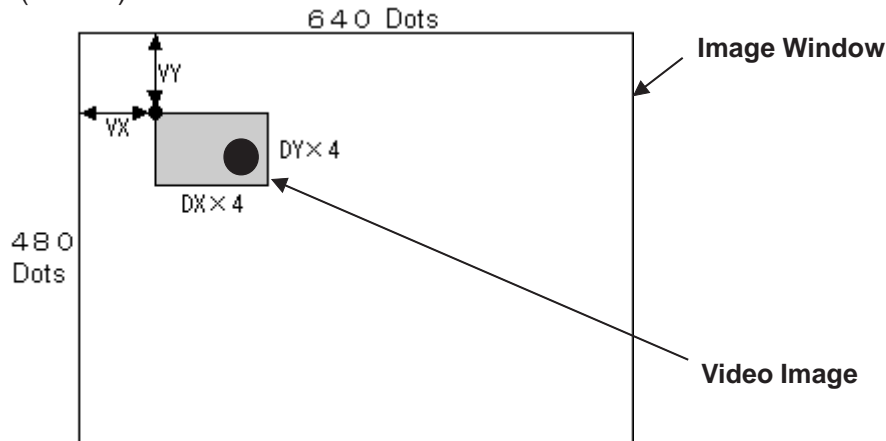

If the video image exceeds the image window's borders, VX or VY's value is automatically adjusted. If that adjustment still fails to bring the image within the limits of the image window, the video image size (DX, DY) is automatically adjusted.

* This function is supported only by the GP-2500T/2600T series units.

4.12.5 Video Control Area Example

■ Changing the Video Window to Transparent

Changing the video window’s transparency color requires the use of this area.

Designating the Transparency Color:

- 1) Turn the Video Common Control Command (+0) area’s Transparent Display (bit 0) ON.
- 2) Turn the Video Common Control Command (+0) area’s Transparency Mode (bit 1) “Designated Color Transparent Display” feature ON.
- 3) Designate the desired transparency color (1 to 3) [+3 to +5]. The color number used is the same as for the screen editor software’s colors.

• **Video Control Area**

+0	Video Common Control Command
+1	Video Common Control Status
+2	JPEG Capture File Number
+3	Transparent Color 1
+4	Transparent Color 2
+5	Transparent Color 3

• **Video Common Control Command (+0)**

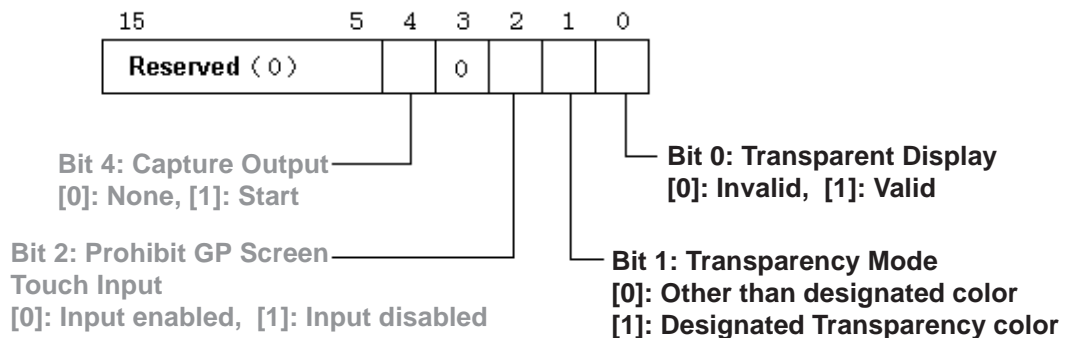

■ Turning Touch Switches behind the Video Window ON/OFF

The video control area is used to turn these switches ON or OFF. This is performed via the Video Common Control Command (+0) area’s “Prohibit GP Screen Touch Input” (bit 2) ON/OFF.

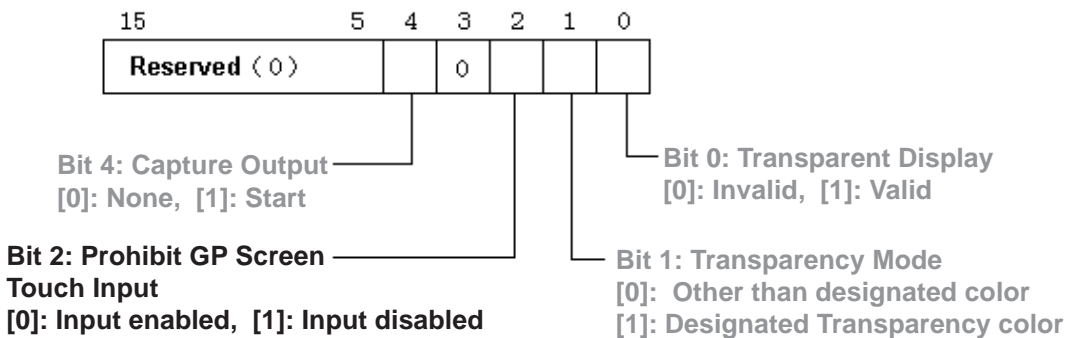

Note: Grey characters indicate that an item’s address cannot be used.

* This function is supported only by the GP-2500T/2600T series units.

■ **Capturing an Image Window’s Video Image (JPEG file)**

The video control area is used to capture video images and save them as JPEG files. Images displayed for each of the channel numbers set in the Video (V) Screen can be captured, one at a time. Images from multiple channels, however, cannot be captured at the same time. To capture an image, follow the steps given below.

- 1) Designate the Video Capture File number.
 - When designating a file number directly, use the screen creation software.
 - When designating the number indirectly, enter the number into the “JPEG Capture File Number” (+2), from 0 to 65535.
- 2) Turn the Video Common Control Command (+0) area’s “Capture Output” (bit 4) ON.

• **Video Control Area**

+0	Video Common Control Command
+1	Video Common Control Status
+2	JPEG Capture File Number

• **Video Control Command (+0)**

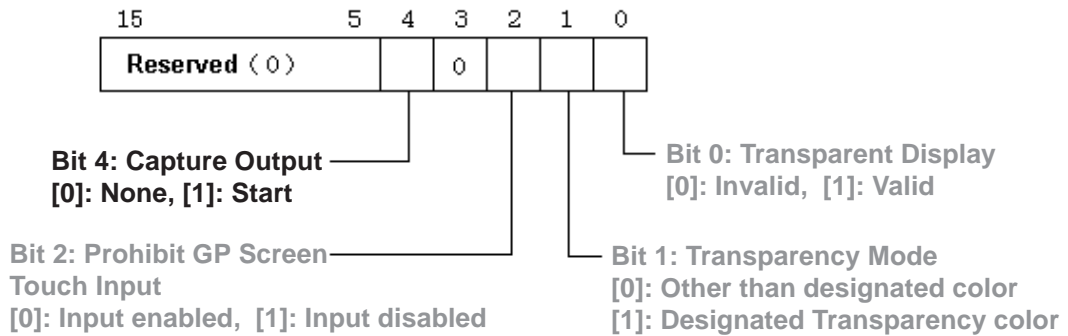

The status of the Capture operation is written to the Video Common Control Status area.

• **Video Common Control Status (+1)**

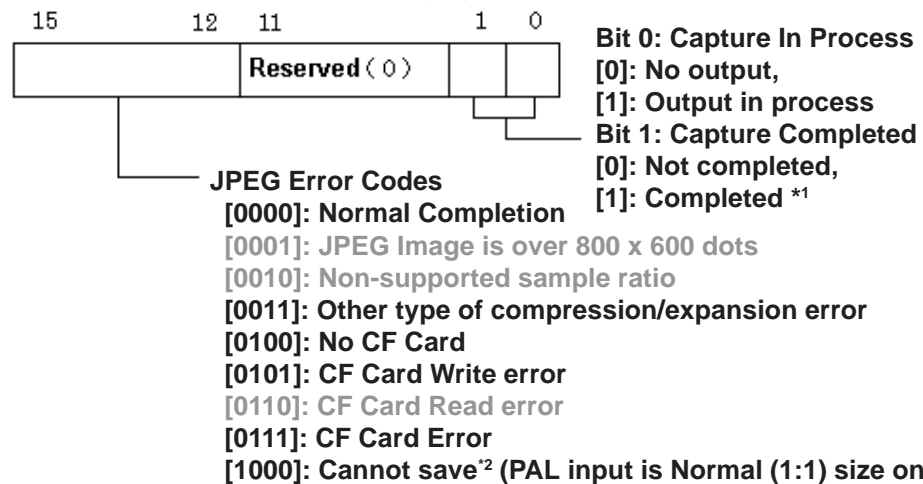

^{*1} Effective only when the Capture-completed Bit is enabled in the [Capture Operation Setting (Screen/Video)] field via [GP Settings/Extended Settings/Capture Settings].

Reference 4.7.10 Screen Capture

^{*2} This error will not occur with VM Units having revision number Rev. A 2 or higher. Images can be captured and saved at 1/4 or 1/16 the size of the riginal image.

* This function is supported only by the GP-2500T/2600T series units.



Note: Grey characters indicate that an item's address cannot be used.

■ **Displaying a CF Card's Captured (JPEG file) Data**

To display CF Card captured (JPEG) data in an image window, use either of two methods. One is to designate in advance a JPEG file number and an image window directly, using the screen creation software. To designate the number indirectly, enter the image window number and the JPEG file number into the Video Control Area.

- **Use the screen creation software to designate in advance a JPEG file number and an image window (Direct method)**

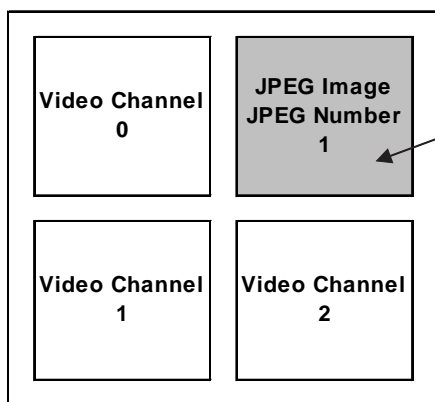

The JPEG file is positioned here. All other images are displayed as video images.

- **Enter the image window number and the JPEG file number into the Video Control Area (Indirect Method).**

Use the Video Control Area's Window Display Image Control Flag (+6) to designate the change from External Input Device to JPEG File Image. You can also designate the JPEG image's display size.

Ex. In Image Window No. 2, JPEG image file No. 5 is displayed at 1/4 expansion.

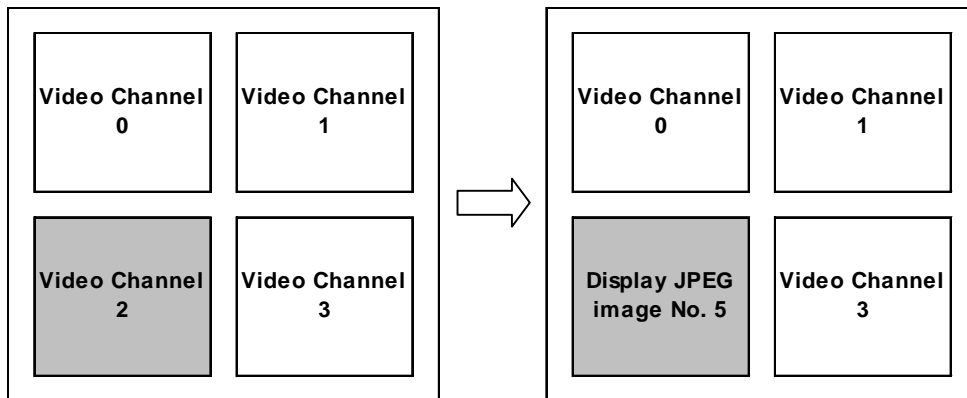

Note: Grey characters indicate that an item's address cannot be used directly.

** This function is supported only by the GP-2500T/2600T series units.*

• When using Expanded Mode

- 1) Write “5” to Image Window 2.
- 2) Write “2” to Window Display Image Control Flag (+6) area’s Image Window 2 (bits 8 to 11).

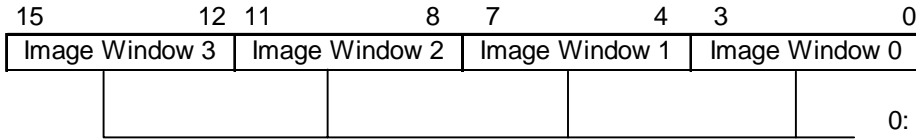

- 0: External Input Device
- 1: JPEG Standard
- 2: JPEG 1/4 Length
- 3: JPEG 1/16 Length
- 4: JPEG 1/64 Length
- 5 to F: Reserved

• Video Common Control Status (+1)

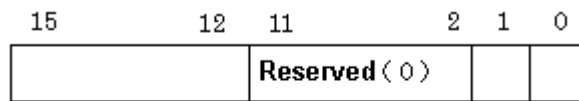

- Bit 0: Capture In Process
- [0]: No output,
- [1]: Output in process
- Bit 1: Capture Completed
- [0]: Not completed,
- [1]: Completed *1

JPEG Error Codes

- [0000]: Normal Completion
- [0001]: JPEG Image is over 800 x 600 dots
- [0010]: Non-supported sample ratio
- [0011]: Other type of compression/expansion error
- [0100]: No CF Card
- [0101]: CF Card Write error
- [0110]: CF Card Read error
- [0111]: CF Card Error
- [1000]: Cannot save*2



Note: When an error occurs while a JPEG Image is being displayed, the error contents will be written into the Video Common Control Status.



Note: Grey characters indicate that an item’s address cannot be used.

*1 Effective only when the Capture-completed Bit is enabled in the [Capture Operation Setting (Screen/Video)] field via [GP Settings/Extended Settings/Capture Settings].

Reference 4.7.10 Screen Capture

*2 This error will not occur with VM Units having revision number Rev. A 2 or higher. Images can be captured and saved at 1/4 or 1/16 the size of the original image.

* This function is supported only by the GP-2500T/2600T series units.

■ **Changing an Image Window’s Display Size**

Use the Video Control Area to make changes in an image’s display size.

The input information received via the video channels or the PC (monitor) display can be changed using the following Image Window Control Command areas.

- +13: Channel Number 0
- +19: Channel Number 1
- +25: Channel Number 2
- +31: Channel Number 3
- +37: PC Image

In the following example, Channel Number 2’s display size is changed from “Normal” to “1/4 Size”. Therefore, write “1” to the Video Channel 2 Information Image Window Control Command (+25).

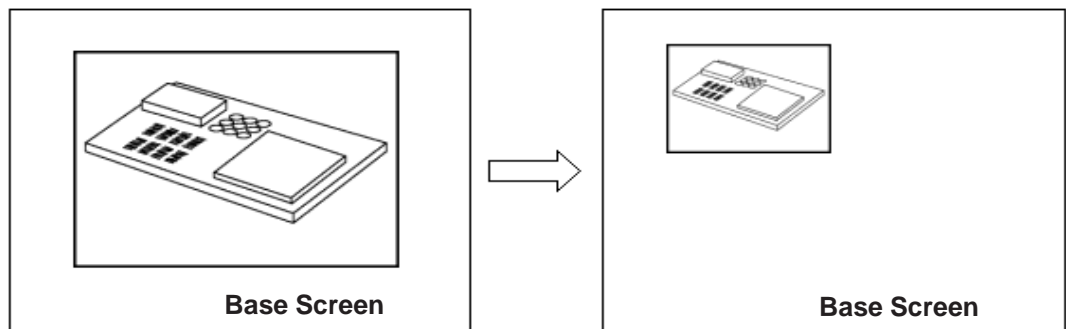

• **Image Window Control Command**

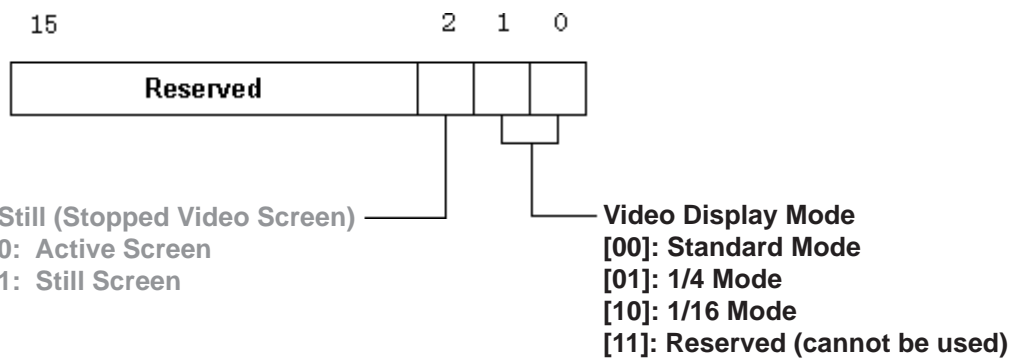

Note: Grey characters indicate that an item’s address cannot be used directly.

* This function is supported only by the GP-2500T/2600T series units.

■ Changing an Image Window's Display Location

Use the Video Control Area to make changes in an image's display location.

1. The display location of the video channels or the PC (monitor) display can be changed directly.
2. The Internal Image Window Control Flag/Internal Video Control Channel Number can be used to change the display position.

To change the display location of the video channels or the PC (monitor) display:

- 1) Turn the Internal Image Window Control Flag area's Coordinate Value Refresh (bit 0) ON.
- 2) Change the display origin points (VX/VY) of the video channels or the PC (monitor) display using the following settings.
 - +14, +15: Channel Number 0
 - +20, +21: Channel Number 1
 - +26, +27: Channel Number 2
 - +32, +33: Channel Number 3
 - +38, +39: PC Image

In the following example, Channel Number 2's display origin point is changed from (0,0) to (100,100).

- 1) Turn the Internal Image Window Control Flag (+11) area's Coordinate Value Refresh (bit 0) ON.
- 2) Write "100" to each of Video Channel 2's Video Image Origin Point coordinates, VX (+26) and VY (+27).

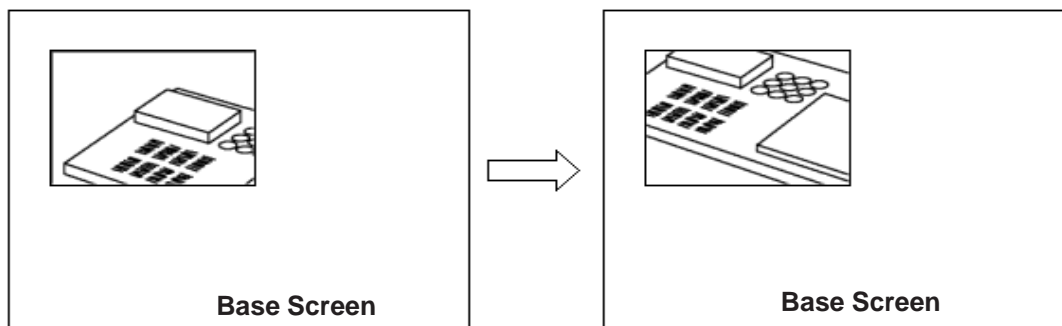

To change the number of the Internal Image Window Control Flag/Internal Video Control Channel:

- 1) Designate the Internal Video Control Channel Number (+12)'s related channel number.
- 2) Change bits 2 to 5 of the Internal Image Window Control Flag (+11). In this case, while any of these bits is turned ON, the display origin point can be changed.



Note: Grey characters indicate that an item's address cannot be used directly.

* This function is supported only by the GP-2500T/2600T series units.

In the following example, Channel Number 2’s display origin point VY is moved lower on the screen.

- 1) Write “2” to the Internal Video Control Channel Number (+12).
- 2) Turn the Internal Image Window Control Flag (+11) area’s bit 3 ON.

• **Internal Video Control Channel Number**

Stores the Channel Numbers controlled by the Internal Image Window Control Flags. The following table shows the Channel Numbers.

Input Channel	Channel Number
Channel 0	0
Channel 1	1
Channel 2	2
Channel 3	3
PC Display	4

• **Internal Image Window Control Flag**

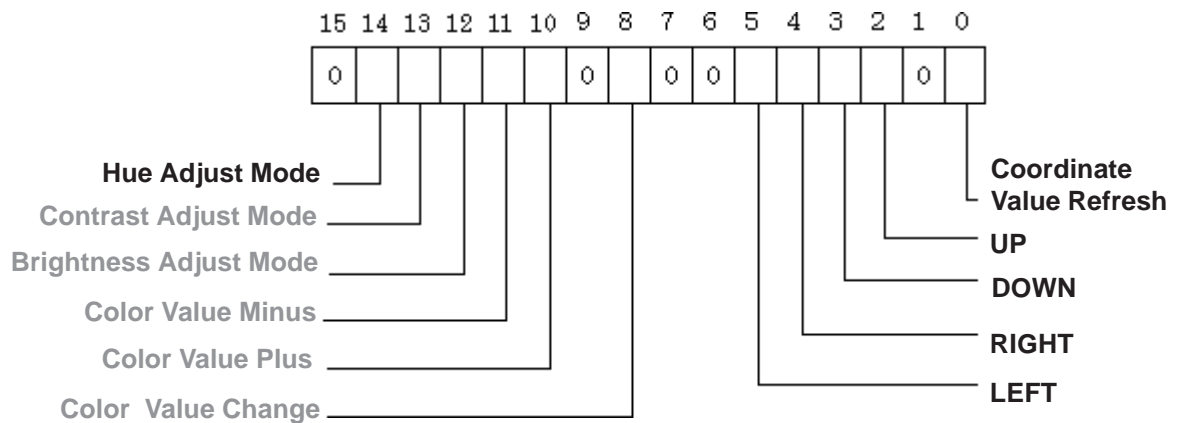

 **Note:** Grey characters indicate that an item’s address cannot be used directly.

* This function is supported only by the GP-2500T/2600T series units.

■ Changing an Image Window's Color Value

Use the Video Control Area to make changes in an image's color, brightness, contrast and hue. To change these values, use the following steps.

1. Change the brightness, contrast and hue values of the video channels directly.
2. The Internal Image Window Control Flag/Internal Video Control Channel Number can be used to change these settings.

To change a video channel's brightness, contrast or hue directly:

- 1) Turn the Internal Image Window Control Flag (+11) area's Color Value Refresh (bit 8) ON.
- 2) Change the brightness, contrast and hue setting values for each of the video channels using the following settings.
 - +16, +17, +18: Channel Number 0
 - +22, +23, +24: Channel Number 1
 - +28, +29, +30: Channel Number 2
 - +34, +35, +36: Channel Number 3

In the following example, Channel Number 2's contrast setting is changed from "8" to "15".

- 1) Turn the Internal Image Window Control Flag (+11) area's Color Value Refresh (bit 8) ON.
- 2) Change Video Channel 2's Contrast setting (+29) from 8 to 15.

To change the number of the Internal Image Window Control Flag/Internal Video Control Channel:

- 1) Designate the Internal Video Control Channel Number (+12)'s related channel number.
- 2) Turn the Internal Image Window Control Flag (+11)'s Adjustment Mode (bits 12 to 14) ON.
- 3) Turn the Internal Image Window Control Flag (+11)'s Color Value Plus (bit 10) or the Color Minus Value (bit 11) ON.

* This function is supported only by the GP-2500T/2600T series units.

In the following example, change the contrast setting for Channel 2.

- 1) Designate the Internal Video Control Channel Number (+12) as “2”.
- 2) Turn the Internal Image Window Control Flag (+11)’s Contrast Adjustment Mode (bit 13) ON.
- 3) Turn the Internal Image Window Control Flag (+11)’s Color Value Plus (bit 10) or the Color Minus Value (bit 11) ON.

• **Internal Image Window Control Flag**

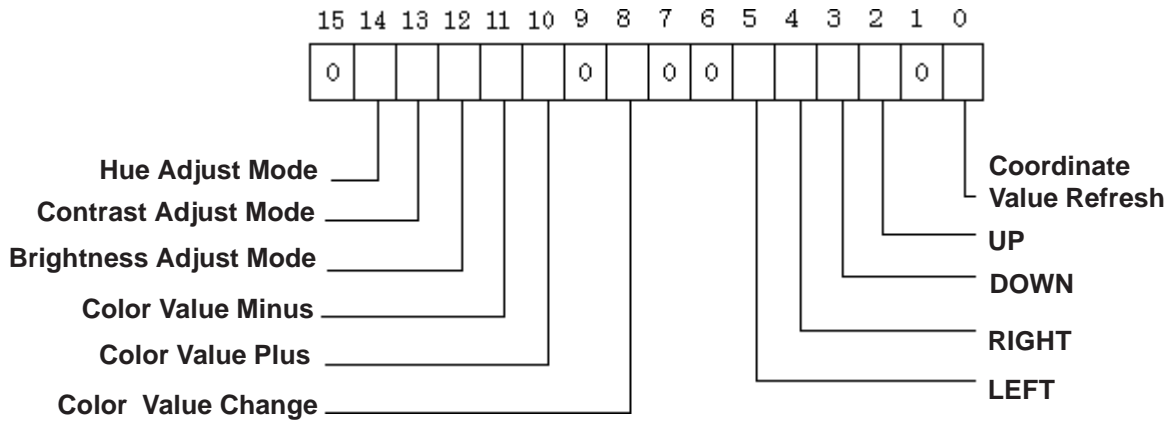

■ **Creating a Still (frozen) Image Window**

The input information received via the video channels or the PC (monitor) display can be changed to a still image by turning the following Image Window Control Command area’s Still (Video Screen Still Bit 2) bit ON.

- +13: Channel Number 0
- +19: Channel Number 1
- +25: Channel Number 2
- +31: Channel Number 3
- +37: PC Image

In the following example, Channel Number 2’s display is changed to “Still”. Therefore, turn the Video Channel 2 Information Image Window Control Command (+25) area’s bit 2 ON.

Note: Grey characters indicate that an item’s address cannot be used directly.

** This function is supported only by the GP-2500T/2600T series units.*

4.12.6 Vide Control Area Settings

■ Specifying the System File

To use the video window function, specify the system file. Use Off-line Mode or GP System Settings in the drawing software to set the system file.

In the GP's OFFLINE Mode, perform the setup as follows: Defaults-> System Environment Settings-> Video Environment Settings-> Adjusting Video Display Condition. For further video setting information,

Reference *Operation Manual, 3.6 Video Data Display (V Screen)*

■ Video Environment Settings

Specify the video environment for controlling the video. The Video Environment Settings menu is displayed only when the optional VM unit is attached to the GP.

SET UP VIDEO OPERATION

STARTING ADDRESS OF VIDEO CONTROL AREA (LS)

CENTER ZOOM OPERATION ON OFF

VIDEO INPUT SIGNAL NTSC PAL

VIDEO MODE COMPATIBLE EXTEND

1 2 3 4 5 6 7 8 9 0 ↑ ↓ BS

← →

◆ Starting Address of Video Control Area

Designate the start address for the Video Control area. "LS" is the only selection available as the start address. When Standard Mode is selected for the video function mode, 22 words are automatically allocated to the address. When Extended Mode is selected, 43 words are allocated. When the start address is set to "0", the video function is disabled.



Important

When the screen of the GP-530VM is used as that of the GP-2000 series with the VM unit, the video control area start address differs between the GP-530VM and the GP-2000 series with the VM unit.

◆ Center Zoom Operation

Specify whether center zoom operation should be valid or invalid. When the center zoom operation is valid, the center of the video screen is displayed when standard mode is switched to large mode. When center zoom operation is invalid, the screen is displayed at the position that is specified according to the point of origin of the video display.



Important

This feature is not available in Extended Mode.

* This function is supported only by the GP-2500T/2600T series units.

◆ **Video Input Signal**

Select “NTSC” or “PAL” as the input signal of the video device.

◆ **Video Mode**

Select “Standard Mode” or “Extend Mode” .

Note: The center zoom function can be set on the GP System Settings in the GP screen creation software.

■ **Adjusting the Video Display (1/4)**

Specify the display condition of the video screen on the GP. The Adjusting Video Display Condition menu is displayed only when the VM unit is attached to the GP.

The display area of NTSC

The display area of PAL

◆ **Input Channel**

Select the channel (0 to 3) that is connected to the video device.

◆ **Mode**

Select the color mode, color or monochrome, of the input from the video device.

◆ **Brightness**

The brightness level of the video window can be adjusted. Press [+] to make the video window brighter and [-] to make the video window darker.

◆ **Contrast**

The contrast level of the video window can be adjusted. Press [+] to make the video window blacker and [-] to make the video window whiter.

* This function is supported only by the GP-2500T/2600T series units.

◆ Color

The hue of the video window can be adjusted. Press [+] for a reddish hue. Press [-] for a greenish hue.



Note: When monochrome is selected as the color mode on the video screen, the hue cannot be adjusted.

◆ Default

Selections for brightness, contrast and hue are assigned to the middle value (8).

■ Adjusting the Video Display (2/4)

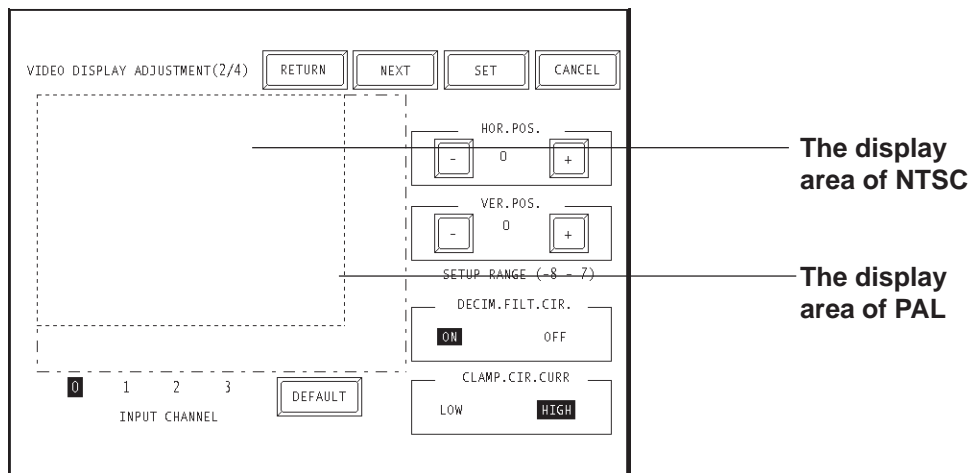

◆ Horizontal Position Adjustment

Occasionally, the video signal's standard horizontal positioning and the image's actual horizontal positioning can be different. When all image screens are used, this can result in the right or left corners of a screen not being shown. This feature is designed to correct this problem.



This horizontal position adjustment setting is applied to all channels. Individual channel settings cannot be applied.

◆ Vertical Position Adjustment

Occasionally, the video signal's standard vertical positioning can differ slightly from the image's actual vertical positioning. When all image screens are used, this can result in cropping of the top or bottom of the screen, or display of screens other than the valid display area. This feature is designed to correct this problem.

◆ Decimeter Filter Circuit Setting

Turns ON and OFF the decimeter circuit built into the decoder. When monochrome signals are being received, disabling the signal processing filter (decimeter) circuit may result in finer image quality. In normal operations, leave the setting at ON.

* This function is supported only by the GP-2500T/2600T series units.

◆ **Clamp Circuit Current Setting**

Adjusts the current level of the clamp circuit. When the video input signal exceeds the standard range, no synchronization signal may be detected, or the black level may not be captured, which results in disruption of the image. In this case, changing the internal current level of the clamp circuit can sometimes stabilize the screen. Under normal operation, leave the setting at "High". If screen disruptions occur, changing the setting to "Low" may solve the problem.



Note: This setting can be configured in the "GP Setup" in the GP screen creation software.

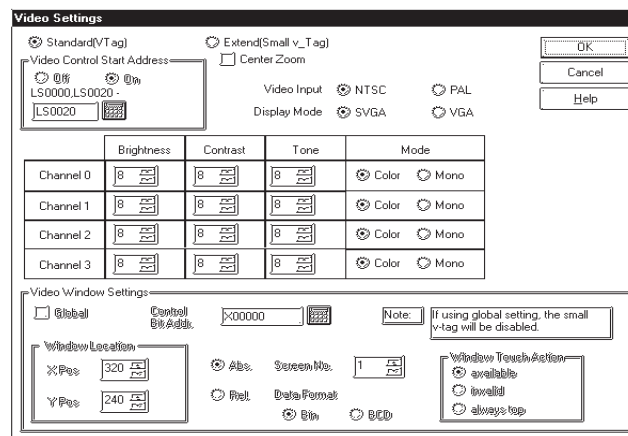

Important If data transmission is performed after off-line adjustment of the settings, the adjustment will be cleared. Make adjustments only after performing transmissions.

■ **Adjusting the Video Display (3/4)**

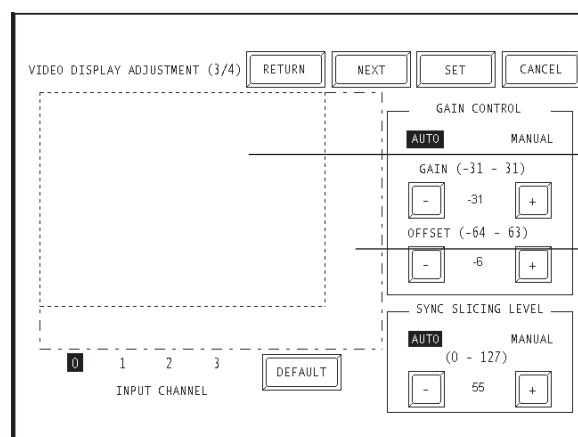

The display area of NTSC

The display area of PAL



- These settings are reflected in all channels. Settings cannot be adjusted for individual channels alone.
- If a transmission is performed after off-line adjustment of the settings, the adjustment will be cleared. Make adjustments only after performing transmissions.

* This function is supported only by the GP-2500T/2600T series units.

◆ Gain Control

Provides gain control for the digital amplifier circuit.

Automatic: Automatically adjusts the gain (amplification factor) and offset (black level) according to the input signal level.

Manual: Permits adjustment of the gain (amplification factor) and offset (black level) to desired values.

◆ Synchronization Slicing Level Adjustment

Set the depth of the level for detecting the synchronization signal. If the synchronization signal depth of the video signal is shallower than the standard, or if the depth varies, the synchronization signal will not be detected. This condition will result in horizontal or vertical blurring of the screen. When this symptom occurs, adjusting the detection level may stabilize the blurred screens. In normal operation, leave the setting at Automatic mode. If screen blurring occurs, changing the setting to a lower level may solve the problem.

■ Adjusting the Video Display (4/4)

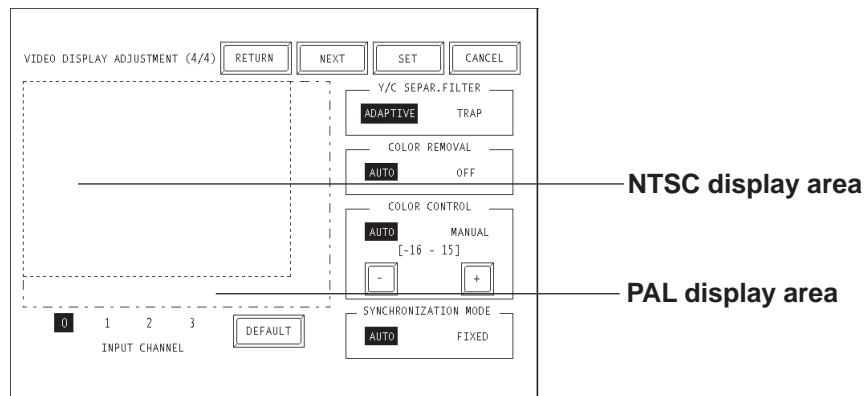

Important

- **These settings are reflected in all channels. Settings cannot be adjusted for individual channels alone.**
- **If a transmission is performed after off-line adjustment of the settings, the adjustment will be cleared. Make adjustments only after performing transmissions.**

* This function is supported only by the GP-2500T/2600T series units.

◆y/c Separation Filter Setting

Selects the input Y/C separation filter. If a significant level of noise related to the color signal is observed when displaying images with higher color saturation, select "Trap". This setting is sometimes effective at reducing the noise level.

◆Color Removal Setting

Select either "Auto" mode, which turns ON/OFF the color removal function automatically, or "OFF" mode, which turns OFF the function. When the amplitude of the color-burst signal is small, the screen may automatically change to monochrome display. Selecting "OFF" mode will force color reproduction of the image.

◆Color Control

Changes the amplification of the Chroma signal. When the amplification value of the Chroma signal (including the colorburst signals) is out of standard range, the standard adjustment features may not render optimal images. Changing this setting may result in optimal images.

◆Input Sync Method

Switches the FIFO mode of the video signal input circuit.

When the frequency of the input video signal is always below the specified value (15,734kHz), the automatic setting adds one line to the stack for the overflow data on a FIFO basis. When the stack becomes full (320 pixels), subsequent input signals cannot be corrected, resulting in the displacement of the displayed data. The fixed setting fixes the number of dots displayed on one line. When the frequency exceeds the specified value, however, irregular data are displayed at the right side of the screen.

* This function is supported only by the GP-2500T/2600T series units.

4.12.7 **VGA/SVGA Display Function**

To activate VGA/SVGA display, connect the GP to the VGA/SVGA port of a Windows-compatible computer.

Turn on the eighth bit of +14 (control) in the system data area to show/hide the VGA/SVGA display. (In memory link mode, use bit number 8 of word 11.)

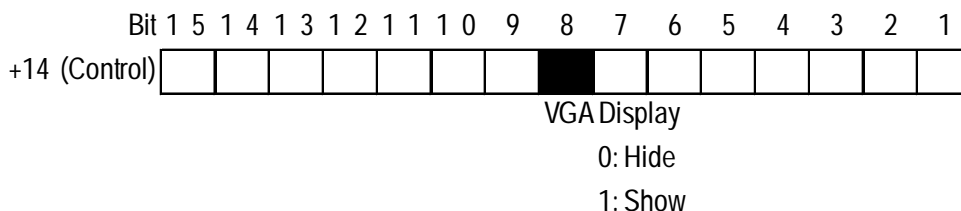

Reference *Device/PLC Connection Manual, 1.1.4 Contents and Range of System Data Area*



Note:

When SVGA is displayed on the GP-2500T, it is compressed to 640 x 480. When VGA is displayed on the GP-2600T, it is magnified to 800 x 600 or displayed at full scale in the center of the screen. Magnification or full-scale display settings can be made only with the GP screen creation software.

Reference *Operation Manual, 3.6.2 Video settings*



Important

Depending on the color(s) displayed when the screen resolution is magnified or reduced, lattice-likelines may appear or flicker on the screen.

- When any area other than the 40 upper or lower dots on the GP screen is touched while the VGA/SVGA display is active, the VGA/SVGA display is turned OFF, and the control bit is also turned OFF.

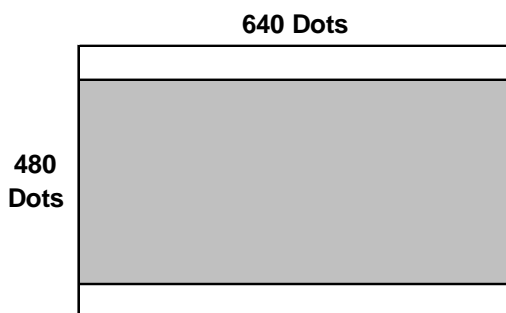

- When VGA/SVGA display is visible, the touch switch on the GP screen is invalid.

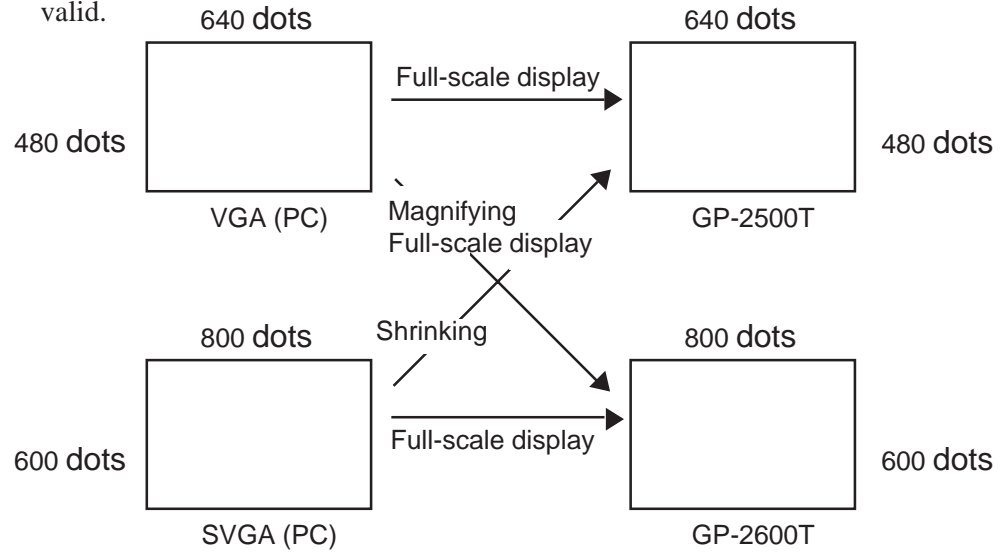

- When VGA is displayed its original on the GP-2600T at the center of the screen.
- If the video window is already displayed, it is temporarily closed while the VGA is displayed. The video window is not displayed until the VGA is turned OFF.

■ Adjusting the VGA/SVGA Display

Adjust the VGA/SVGA display as follows:

- 1 Display the menu bar. For more information on the method of viewing the menu bar,

Reference *GP2000 Series Users Manual, 6.4.3 Touch Panel Settings*

1/4	CF START-UP		OFF-LINE	RESET	CANCEL
-----	-------------	--	----------	-------	--------

- 2 Press at the left end of the menu bar three times to display the next menu.

4/4	PC SCREEN SETTING	POSITION ADJUSTMENT	SCREEN ADJUSTMENT	COLOR ADJUSTMENT	DEFAULT SETTING
-----	-------------------	---------------------	-------------------	------------------	-----------------

- Press POSITION ADJUSTMENT to adjust the horizontal and vertical position.

1/1	POSITION ADJUSTMENT		100 HOR.POS.			100 VER.POS.		EXIT
-----	---------------------	--	--------------	--	--	--------------	--	------

- Press SCREEN ADJUSTMENT to adjust the clock and phase.

1/2	CLOCK ADJUSTMENT	-	CURRENT VALUE XXX	+	EXIT
-----	------------------	---	-------------------	---	------

2/2	PHASE ADJUSTMENT	-	CURRENT VALUE XX (00-63)	+	EXIT
-----	------------------	---	--------------------------	---	------

- Press COLOR ADJUSTMENT to adjust the red, green and blue colors.
- Press DEFAULT SETTING to restore the POSITION ADJUSTMENT, SCREEN ADJUSTMENT and COLOR ADJUSTMENT settings to their default values.

▼ 1/3	RED COLOR ADJUSTMENT	△	X(0-3) LEVEL	▽	△	100 VER.POS.		EXIT
----------	-------------------------	---	-----------------	---	---	-----------------	--	------

▼ 2/3	GREEN COLOR ADJUSTMENT	△	X(0-3) LEVEL	▽	△	100 VER.POS.		EXIT
----------	---------------------------	---	-----------------	---	---	-----------------	--	------

▼ 3/3	BLUE COLOR ADJUSTMENT	△	X(0-3) LEVEL	▽	△	100 VER.POS.		EXIT
----------	--------------------------	---	-----------------	---	---	-----------------	--	------



Note: The results of the horizontal position, vertical position and phase adjustment are saved in the backup SRAM of the GP main unit. Therefore, if the GP unit were replaced, these settings will need to be re-entered into the new GP.



Important: If the PC signal is changed while the PC image settings are being changed (i.e. from VGA to SVGA), the OFFLINE screen's menu will disappear.

4.12.8 **Converting GP-530VM/GP-570VM Screens****■ Conversion from the GP-530VM to GP2000+VM unit****◆ The start address of the video control area is changed from LS16 to LS20.**

The start address allocated to the video control area changed from LS16 to LS20. Because of this change, the start address of the video control area needs to be reset. If the video window is controlled with the PLC or the GP tags, the address also has to be changed.

◆ The system window (alarm message, error display) is brought to the front of the video display.

The system window, including the alarm message, is brought to the front of the video display.

◆ Making video display quality adjustments.

The video image's quality will change from 640 x 400 to 640 x 480 (NTSC). Part of the image (on the right side) displayed on the GP-530VM will not be displayed due to differences in internal processing.

■ Conversion from the GP-570VM to GP2000 +VM unit

When converting from the GP-570VM, consider the following.

◆ The system window (alarm message, error display) is brought to the front of the video display.

The system window such as an alarm message and error display is brought to the front of the VGA display or the video display.

◆ The VGA adjusting method is changed to on-line settings

The method of adjusting the VGA display (horizontal position, vertical position) is changed to on-line setting. Therefore, the off-line setting menu is lost. This setting should be set again in the on-line settings.

◆ Making video display quality adjustments.

The video image's quality will change from 600 x 480 to 640 x 480 (NTSC). Part of the image (on the right side) on the GP-570VM will not display due to differences in internal processing. Move the point of origin for the video display (VX, VY) to (-32, 0)*1.

◆ Images prepared with some video devices will not be displayed on the GP-570VM.

*1 These values will vary depending on the video devices connected to the GP. These values are provided as a reference only.

Index

A

A-tag 2-21
a-tag 2-41
A-tag Example 2-35
About Freeze Mode 2-212
About D-Script 3-1, 4-1, 4-51
About the Status Address 4-148
Active Image Functions 1-2, 2-21
Advanced Features 4-1
Alarm Summary Display Notes 2-45
Application Example (1) 3-68, 3-70
Application Example (2) 3-177
Auto Clear Example 2-134
Automatic Filing Data Transmission 4-25

B

Binary to Decimal String 3-128, 3-129
Bit Control 3-119
Bit Offset and Bit Length Settings 2-164
Bit Operation 3-95
Bit Operation Examples 3-66
Block Display Mode 2-321, 2-325, 2-331

C

C-tag 2-47
Cautions about the display 4-140
Changing Screens 2-251
Channel Settings 2-318
Clear Bit 3-119
Color Settings 2-38
Column Display 4-136
Combination with the File Manager Display 4-140
Combining the CSV Data Display with the Data Tran
4-134
Combining the CSV Data Display with the File Manag
4-134
Combining with Data Transfer Display 4-139
Concat String 3-134
Conditional Branches 3-67, 3-69
Constant/Address 3-95, 3-106
Control address and status address in data transfe
4-95, 4-110
Creating data with Microsoft Excel 4-91
CSVFile 3-177
CSVFileList 4-90

D

D-Script / Global D-Script 3-1, 3-93
D-Script / Global D-Script Limitations 3-62
D-Script Limitations 3-62
D-Script Toolbox 3-100
D-tag 2-51
d-tag 2-55
Data Flow in the Filing Application 4-82
Data Flow in the Logging Application 4-82
Data Input Example 2-131
Data Sampling Settings 3-172
Data Sampling's CSV File Storage Example 3-177
Data Storage Example 3-175
Data Transfer Display 4-112
DataBuffer to LS Device 3-127
Decimal string to Binary 3-121
Device Allocation Table 5
Display function of the File Manager Display 4-150
Display Settings 4-70
Display Timing 2-149

E

E-tag 2-61
Editing Function 4-142
Erase Mode Settings 2-150
Extended Settings 4-88
Extended SIO Script 3-93, 3-163
Extended SIO Script Editor 3-98
Extended SIO Script Errors 3-96
Extended SIO Script Function 3-163

F

F-tag 2-79
File Delete key 4-154
File Header 1-1
File Manager Display 4-147
Filing Data (Recipe) Function 4-13
Flow Charts 3-164
formal trade names 3
Function Name 3-99

G

G-tag 2-85
g-tag 2-91

Get Part String 3-131
 Get String Length 3-133
 Global Window Display 2-268
 GP Display Data Types 1-1
 GP Series Product Names 3, 4
 GP System Area Global Window Display Settings 2-273
 GP System Area Q-tag settings 2-214

H

Hexa String to Binary 3-123
 How to Avoid Overlapping Figures 2-153

I

If no free space remains 4-96
 Indirect Word Addressing Examples 2-76
 Initialization Function (INIT) 3-164

J

J-tag 2-109

K

K-tag 2-115
 k-tag 2-136

L

L-tag 2-142
 l-tag <small L> 2-160
 Label Setting EXT_SIO_RECV 3-115
 Label Setting: EXT_SIO_CTRL 3-113
 Library Display Coordinates 2-147
 Local Window Display 2-269
 Logging Data Read Timing 4-55
 Logging Function 4-49, 4-81, 4-134, 4-147, 4-156,
 4-182, 4-191, 4-205, 4-208, 4-211
 Logical Operation Examples 3-67
 LS Device to DataBuffer 3-125

M

M-tag 2-166
 Main Routine Processing 3-164
 Manual Filing Data Transmission Example 2
 4-36, 4-37, 4-38, 4-45
 Mark Display Using Indirect Mode 2-170
 Memory Control 3-108
 Memory Copy 3-109
 Memory Copy (Variable) 3-110
 Memory Operation 3-95
 Memory Set (memset) 3-111
 Memory Set (Variable) 3-112
 Moving the File Manager Display 4-155

N

N-tag 2-172
 n-tag 2-182
 Names of files stored on a CF card and processing
 4-151
 No. of Sampl. Addr. 3-174
 Notes on Entering BCD Data 2-132
 Notes on Operation Results 3-66
 Notes On XOR Display 2-152

O

Object Drawing Data 2-104
 Offset Address 3-108
 Offset Settings 2-151
 Opened in Excel 3-177
 Operation procedure for the CF Card File Manager
 4-152
 Overlapping Colors on a Color GP 2-154

P

P-tag 2-186
 P-tag Example Setups 2-192
 Place Display Switch 4-149
 PREFACE 1
 Print Settings 4-83, 4-84, 4-87, 4-90, 4-92, 4-113,
 4-116, 4-120, 4-125, 4-126, 4-128, 4-134, 4-138,
 4-143, 4-147, 4-149, 4-151, 4-156, 4-157, 4-158,
 4-160, 4-161, 4-163, 4-167, 4-173, 4-181, 4-182,
 4-183, 4-204, 4-209, 4-211, 4-212, 4-213, 4-218,
 4-226, 4-237, 4-243, 4-245
 Print-All 4-144
 Print-Display 4-145
 Printing 4-137
 Priority and Associativity 3-104
 Procedure for 100th data transmission 4-131
 Procedure for first data transmission 4-128
 Procedure for second data transmission 4-128

Q

Q-tag 2-194
 Q-tag Alarm Summary's CSV File Storage Example 2-224
 Q-tag Examples 2-207, 2-209
 Q-tag Restrictions 2-199, 2-200

R

R-tag 2-226
 Reading the target value 3-162
 Receive Function 1 3-169
 Receive Function 2 3-171

Index

Relative Data Display Settings 2-180
Roll Up and Roll Down Keys 2-213

S

S-tag 2-230
Screen File Types 1-1
Screen Level Change Direction 2-255
Set Bit 3-120
Set String 3-132
Setting the control address for the transfer 4-85
Setting Up T-tags 2-248, 2-250
SIO Port Control 3-113
SIO Port Operation 3-95
SIO_Receive 3-116
SIO_Send 3-116
SIO-Receive Wait 3-117, 3-118
Sound Data Output 4-4, 4-8
Sound Output 4-1
Sound Output Settings 4-2
Special Features 3-1, 4-1
String Control 3-121
String Control Error Status 3-135
String Operation 3-95
Switch Settings 4-137

T

T-tag 2-236
t-tag 2-258
TABLE OF CONTENTS 8
Tag Layout Sheet 5
Tag List (Alphabetical Order) 1-5
Tag List (Function Order) 1-8, 1-12
Tag Setting Cautions 1-16
Tag Size List 1-18
Tih / Tiw-tags 2-262
Toggle Bit 3-120
Touching the File Display key while a CSV file is 4-153
Touching the File Display key while a folder is se 4-152
TRADEMARK RIGHTS 3
Transfer control address 4-93, 4-109
Transfer data 4-118
Transfer operation settings 4-117
Transfer status address 4-114
Transferring data from a CF card to the PLC 4-121
Transferring data from the PLC to a CF card 4-122
Transferring two or more groups 4-127, 4-129
Transmit Function 2 3-170
Trend Graph Data's CSV File Storage Example
2-325, 2-331
Trend Graph Display 2-306

U

U-tag 2-266
U-tag Examples 2-272
Using Arithmetic Operations 2-135
Using Trend Graphs 2-309

V

V-tag 2-274, 2-281
V-tag Examples 2-279, 2-286
Valid Data Format 4-141

W

W-tag 2-291
W-tag Examples 2-297, 3-73
Wait 3-119
When loop operation is disabled 4-97
When the file numbers are not contiguous 4-96

X

X-tag 2-298
X-tag Examples 2-303

Memo