

Pro-face



Web Operation Software

GP-Web

Operation Manual

Copyright © 2001, Digital Electronics Corporation
All right reserved. Made in Japan

PREFACE

Thank you for purchasing the “GP-Web”.

Please read this manual carefully in order to use this software properly, and be sure to keep this manual handy for future reference.

NOTES

- (1) The copyrights to all programs and manuals included in the GP-Web (hereinafter referred to as “this product”) are reserved by the Digital Electronics Corporation. Digital grants the use of this product to its users as described in the “Software Operating Conditions” documentation, included with this product's CD-ROM. Any actions violating the above-mentioned conditions are prohibited by both Japanese and foreign regulations.
- (2) The contents of this manual have been thoroughly inspected. However, if you should find any errors or omissions in this manual, please inform your local GP representative of your findings.
- (3) Please be aware that Digital Electronics Corporation shall not be held liable by the user for any damages, losses, or third party claims arising from the uses of this product.
- (4) Differences may occur between the descriptions found in this manual and the actual functioning of this product. Therefore, the latest information on this product is provided in data files (i.e. Readme.txt files, etc.) and in separate documents. Please consult these sources as well as this manual prior to using the product.
- (5) The specifications set out in this manual are for overseas products only. As a result, some differences may exist between the specifications given here and for those of the identical Japanese product.
- (6) Even though the information contained in and displayed by this product may be related to intangible or intellectual properties of the Digital Electronics Corporation or third parties, the Digital Electronics Corporation shall not warrant or grant the use of said properties to any users and/or other third parties. The Digital Electronics Corporation is not liable for damages related to the rights such as intellectual properties of third parties resulting from the use of the information contained in and displayed by this product.

© Copyright 2001 Digital Electronics Corporation. All rights reserved.

The company names and product names used in this manual are the trade names, trademarks (including registered trademarks), and service marks of their respective companies.

This manual omits individual descriptions of each of these rights.

Contents

PREFACE	1
NOTES	1
Contents	2
Precautions	5
Components	8
Documentation Conventions	8
1 Overview and Environment	
1.1 What is GP-Web?	1-2
1.2 System Design and Setup Procedure	1-3
System Design	1-3
Set Up Procedure	1-5
1.3 Information Flow	1-7
1.4 Applicable GP Units	1-8
1.5 System Requirements	1-9
1.6 Installation	1-11
1.7 License	1-13
2 GP-Web Operation	
2.1 What is “Compiling Data”?	2-2
Starting the GP-Web Compiler	2-2
Using the GP-Web Compiler	2-3
2.2 Template HTML files for the GP-Web Compiler	2-16
Template HTML file for Automatic Creation of default.htm	2-16
Multi Language Table Change Applet	2-20
Screen Change Applets	2-21
Resolution Change Applet	2-23
Synchronization Change Applet	2-24
Data Polling Interval Change Applet	2-25
Drawing Interval Change Applet	2-26
2.3 Sharing the Web Folder	2-27
Sharing the GP-Web Traffic Center Program Folder on the Web	2-27
Sharing the Folder Containing Data Compiled by the GP-Web Compiler	2-28
2.4 GP-Web Traffic Center Program	2-29
Starting the GP-Web Traffic Center Program	2-29
Exiting the GP-Web Traffic Center Program	2-30
Setting up the GP-Web Traffic Center Program	2-30
GP-Web Traffic Center Program Settings Window	2-31
Setting up the User Name and Password of the GP-Web Traffic Center Program	2-33

2.5	Setting Up Security Settings	2-36
	Allowing only specific users access to Internet Web pages	2-36
	Allowing only specific users to use specific functions	
	in communicating via the Internet	2-41
	Prohibiting specific Internet communication functions	2-42
	Allowing only specific users to use specific functions	
	in communicating via the intranet such as Easy Connection	2-43
	Multiple Hierarchical Routing Security	2-45
	Firewall	2-46
	Referencing the Web Share Folder	2-48
2.6	Referring to Logs	2-49
	Starting the Log Viewer	2-49
	GP-Web Information Recorded in the Log Viewer	2-49
2.7	Various Language Supports	2-50
3	Web Browser	
3.1	Web Browser	3-2
3.2	GP Alarm Display	3-3
	GP Alarm Display Diagram	3-4
	Displaying GP Alarm Data on the Web Browser	3-7
3.3	GP Screen JPEG Display Feature	3-9
	Mechanism of GP Screen JPEG Display	3-10
	Displaying JPEG Data on the Web Browser	3-13
3.4	Web Device View	3-14
	Web Device View Design	3-14
	Compiling Web Device View	3-15
	Security in Web Device View	3-17
4	Easy Connection	
4.1	What is Easy Connection?	4-2
4.2	System Design and Setup Procedure	4-3
	System Design	4-3
	Configuration Procedure	4-4
4.3	Installing Easy Connection	4-7
4.4	GP-Web Compiler Routing Setup	4-9
4.5	GP Alarm Display Application	4-10
	Starting and Exiting GP Alarm Display	4-10
	GP Alarm Display	4-11
4.6	GP Screen JPEG Display Application	4-12
	Starting and Exiting GP Screen JPEG Display Application	4-12
	GP Screen JPEG Display	4-13

Appendix A-1





Glossary A-2
Supported Drawing Commands A-5
Supported Tag Commands A-8
GP-Web Part/Library File A-13
Error Messages A-14

Precautions

To prevent program malfunctions or accidents, be sure to observe the following instructions:

Safety Symbols and Terms

This manual uses the following symbols and terms for important information related to the correct and safe operation of this product.

Symbol	Description
 Warning	Incorrect operation resulting from negligence of this instruction may cause death or serious injury.
 Caution	Incorrect operation resulting from negligence of this instruction may cause injury or damage to equipment.
	Indicates Actions/Procedures that should not be performed.
	Indicates Instructions/Procedures that must be performed to ensure correct product use.

Warning

-  Touch panel switches should not be used for a device's Emergency Stop Switch. Generally speaking, all industrial machinery/systems must be equipped with a mechanical, manually operated emergency stop switch. Also, for other kinds of systems, similar mechanical switches must be provided to ensure safe operation of those systems.

Caution

-  Do not turn off your personal computer's power switch during the execution of a program.

■ CD-ROM Usage Precautions

- Do not remove the CD-ROM from the CD-ROM drive while the drive's operation lamp is lit.
- Do not touch the CD-ROM recording surface.
- Do not place CD-ROMs in a place where they may be exposed to extremely high or low temperatures, high humidity, or dust.

■ Drawing Precautions

- Use GP-PRO/PBIII for Windows Ver. 5.0 or later for creating screens. Be sure to use GP-PRO/PBIII for Windows Ver. 6.0 to make full use of the Ver. 1.5 features.
- You can not use all display functions for the GP on your Web browser. Prior to creating a GP-Web project file, be sure to check supported commands.
See "Appendix Supported Drawing Commands" (page A-5).
See "Appendix Supported Tag Commands" (page A-8).
- The display may differ for GP and for your Web browser due to different drawing method even if drawing commands are supported.
- GP-Web does not support the display of data from a GP which is set for vertical (portrait) data display.
- Prior to viewing data from a GP2000 Series unit, use the Pro-Studio [Import GLC Symbol] feature. GLC symbols are important references for both Pro-Server and GP-Web.
- Be sure to design your GP/GLC project data using continuous device addresses to speed up the refresh of screen displays.
- When using a T-tag for entering and then changing screen data, be sure to write that data to the GP's LS area. If the PLC's system data area is used for writing data, even in [Async Mode], using your Web browser to click on the T-tag will cause the GP to change its screen.
- If multiple K tags are placed on one screen, the process will not be executed continuously on GP-Web.
- If you want to use a T tag as a start-up bit for a K tag, place a T tag on top of a K tag on a GP screen and arrange just the K tag to a GP-Web screen. If you don't, and you click on a K tag with a T tag overlaid on top (on GP-Web), an input dialog box will be displayed on the screen, but an input pad will also be displayed for the K tag on the GP side.

■ About GP-Web Display

- The tank graph on GP-Web is displayed differently from that on GP.



- If you click the K tag displayed on the Web browser, the input dialog box appears. In the input dialog box, the current value is displayed.

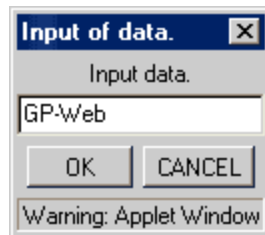

- If you let the input dialog box for the K tag display on your screen, data will not be updated.
- If you click the display area of GP-Web while the input dialog box for the K tag is displayed, the Web browser hides the input dialog box. If you move the mouse pointer over the GP-Web's display area, it will be displayed again.
However, if the user's version of Microsoft Java VM is not the newest, there is the possibility that the input dialog box may not return. To solve this problem, it is recommended that the user install either Microsoft Internet Explorer Ver. 5.01 or later, or Microsoft's latest Java VM. Both of these can be downloaded from Microsoft's home page.
- If you selected "32 bits Float" by the E and K tags, values can be displayed up to 17 digits at maximum on GP, however, the 16th and 17th digits will be rounded off to the 15th digit when displaying those on GP-Web.
- If you use the address used for the interlock address also for the status transition address (e.g. lamp display), there may be some delay between the address status change and its lamp display. This happens because the interlock address is captured directly from GP, while other addresses are from Pro-Server's cache data saved temporarily.
- If you use the older version of GP-Web, that older version of GP-Web Java applets may be stored as the Web browser temporary file (cache memory). The version information of the GP-Web Compiler used for the compilation and GP-Web Java applets currently used are displayed in the Web browser status bar. If they are different each other, press [Ctrl] + [F5] keys to re-download GP-Web Java applets.

Components

The following shows the GP-Web package components. Prior to using this product, check that all these components are present in your package.

■ GP-Web CD-ROM

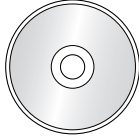

The GP-Web CD-ROM includes:

- GP-Web program
- Japanese manual (in .pdf format)
- English manual (in .pdf format)
- Japanese Installation guide (in .pdf format)
- English Installation guide (in .pdf format)

■ Getting Started Guide (both in Japanese and English)

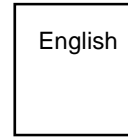
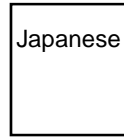

■ User Registration Form (both in Japanese and English)

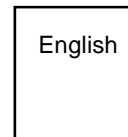
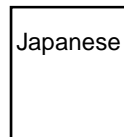

Documentation Conventions

This manual uses the following symbol.

MEMO	Indicates related information or supplementary explanations.
-------------	--

1 | Overview and Environment

- 1.1 What is GP-Web?
- 1.2 System Design and Setup Procedure
- 1.3 Information Flow
- 1.4 Applicable GP Units
- 1.5 System Requirements
- 1.6 Installation
- 1.7 License

1.1 What is GP-Web?

Installing GP-Web in a system using Pro-Server allows GP-PRO/PBIII project screen to be converted to HTML or XML files, which can then be uploaded to the Web. Once they are uploaded to the Web, you can view this data using a Web browser.

GP-Web allows you to do following:

- To monitor site data on a Web browser.
- To monitor data from multiple GP units using one PC's Web browser.
- To monitor site data via the Internet sent from a remote location.

GP-Web consists of the following six applications:

- GP-Web Compiler
- GP-Web Traffic Center Program
- GP Alarm Display Script
- GP Screen JPEG Display Script
- GP-Web Java Applet
- Web Device View Compiler Program

GP-Web Compiler

This product allows you to convert a project file created by GP-PRO/PBIII to an HTML or XML file.

GP-Web Traffic Center Program

This product allows you to send files converted by the GP-Web Compiler to an Internet server, where they can be viewed via a Web browser. The product is used on servers where an Internet Information Server (IIS) and Pro-Server with Pro-Studio for Windows have been installed.

GP Alarm Display Script

This product allows you to view GP internal data stored in SRAM or on a CF Card, using a client PC's Web browser. See section "3.2 GP Alarm Display" (page 3-3).

GP Screen JPEG Display Script

This program allows you to view captured data from GP screens or those entered from the VM unit and stored in a CF Card using a client's PC's Web browser.

For details, see "3.3 GP Screen JPEG Display Feature" (page 3-9).

GP-Web Java Applet

Java applets allow your Web browser to re-create the activity of a GP.

Web Device View Compiler Program

This program allows you to convert the Device View setting file and to display data of multiple devices connected to GPs on a client PC at one time. This program runs on the server where an Internet Information Server (IIS) and Pro-Server with Pro-Studio for Windows Ver.4.0 have been installed.

1.2 System Design and Setup Procedure

This section describes the GP-Web system design and setup procedure.

System Design

Two GP-Web system designs are possible. One is to use an in-house LAN. Another is to access the LAN system from outside, via the Internet or a dialup line.

Using In-House LAN

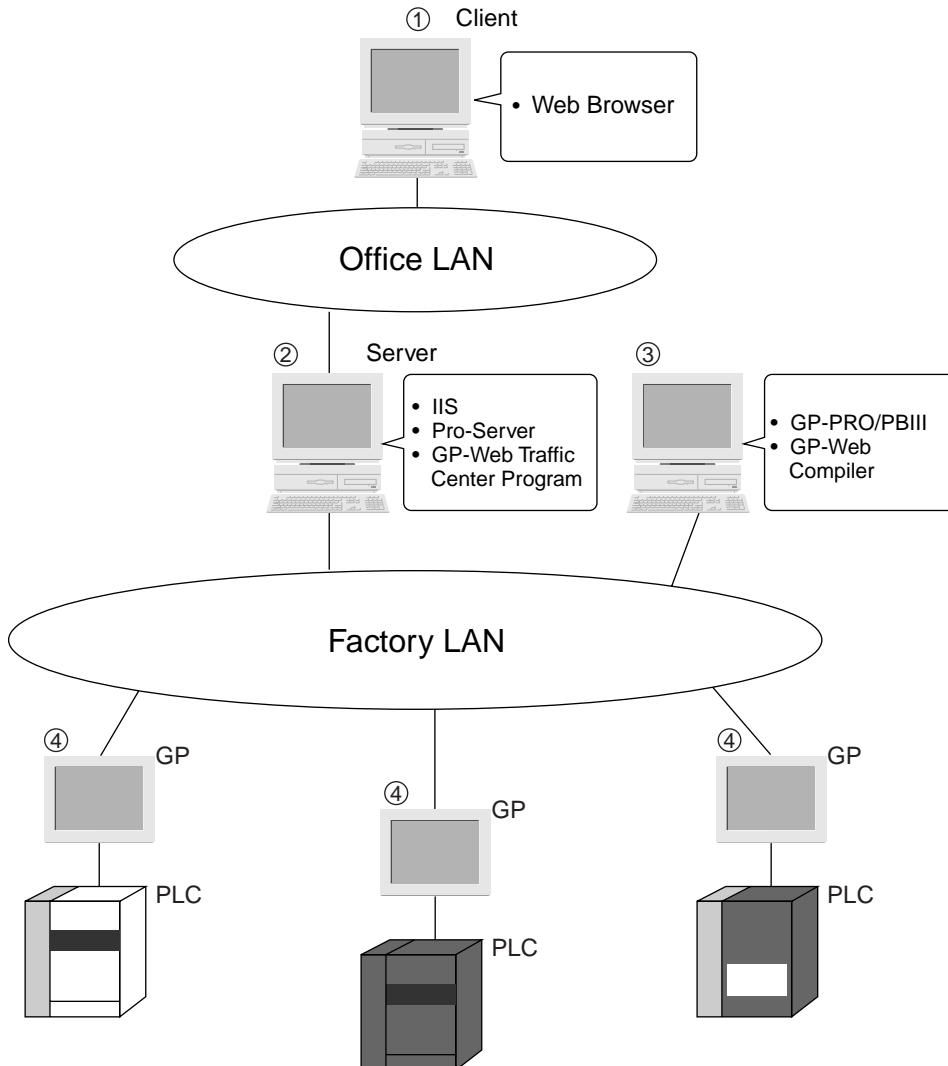

On PC (3), GP screens are converted by the GP-Web Compiler to HTML files which you can view via the Internet. This converted screen data is then copied to the server (2). On the server (2), IIS, Pro-Server and the GP-Web Traffic Center program are running and upload the GP screen data to the Web via the Internet. Then, the client (1) can access the server (2) through the office LAN, which allows them to view GP screens on a Web browser.

Use separate Ethernet cards for the office LAN and for the factory LAN on PC (2).

PCs for (2) and (3) can be combined into one PC.

External Access

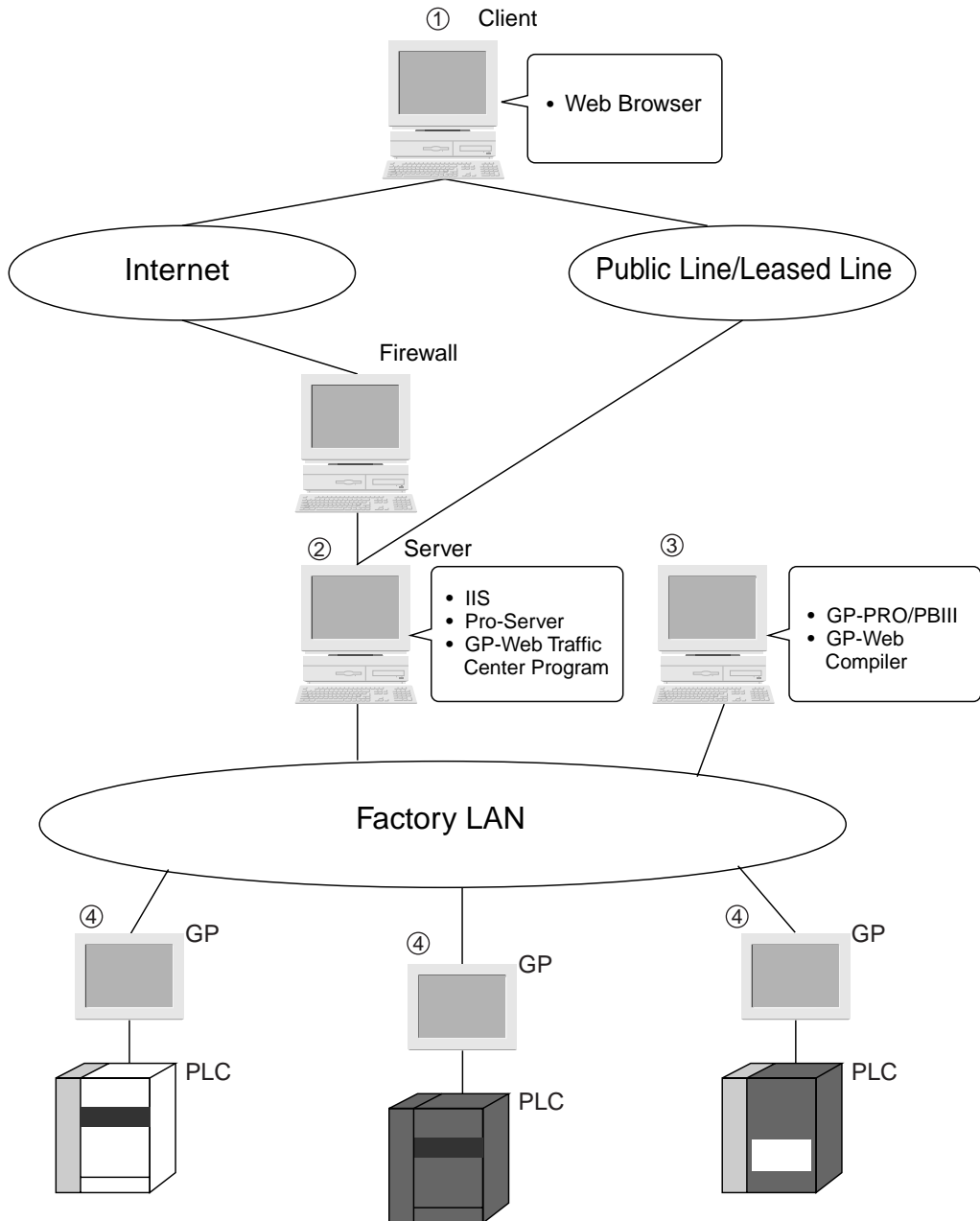

On PC ③, GP screens are converted by the GP-Web Compiler to files you can view via the Internet.

Converted screen data is then copied to the server ②. On server ②, IIS, Pro-Server and the GP-Web Traffic Center program are running and the GP screen data is uploaded to the Web via the Internet. The Client PC ① can access the server ②, via the Internet through the firewall, or via a public/leased phone line. You can view GP screens on the Client PC's Web browser ①.

Use separate Ethernet cards for the office LAN and for the factory LAN on PC ②.

PCs ② and ③ can be combined into one PC.

Set Up Procedure

This section describes the step-by-step procedure to use GP-Web based on the previous System Design installation. Prior to starting, Pro-Server with Pro-Studio for Windows must be installed on server ② and GP-PRO/PBIII for Windows must be installed on PC ③.

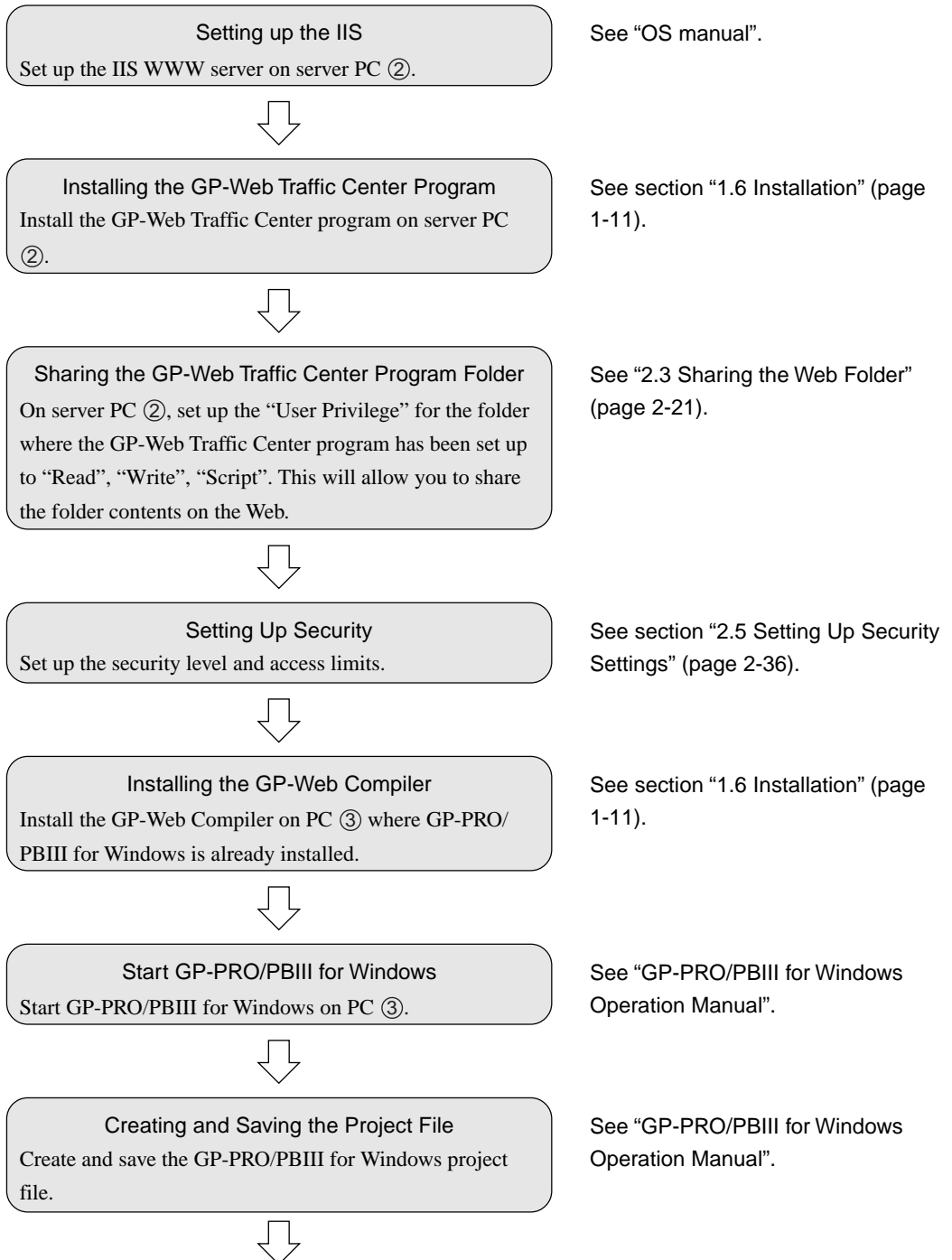

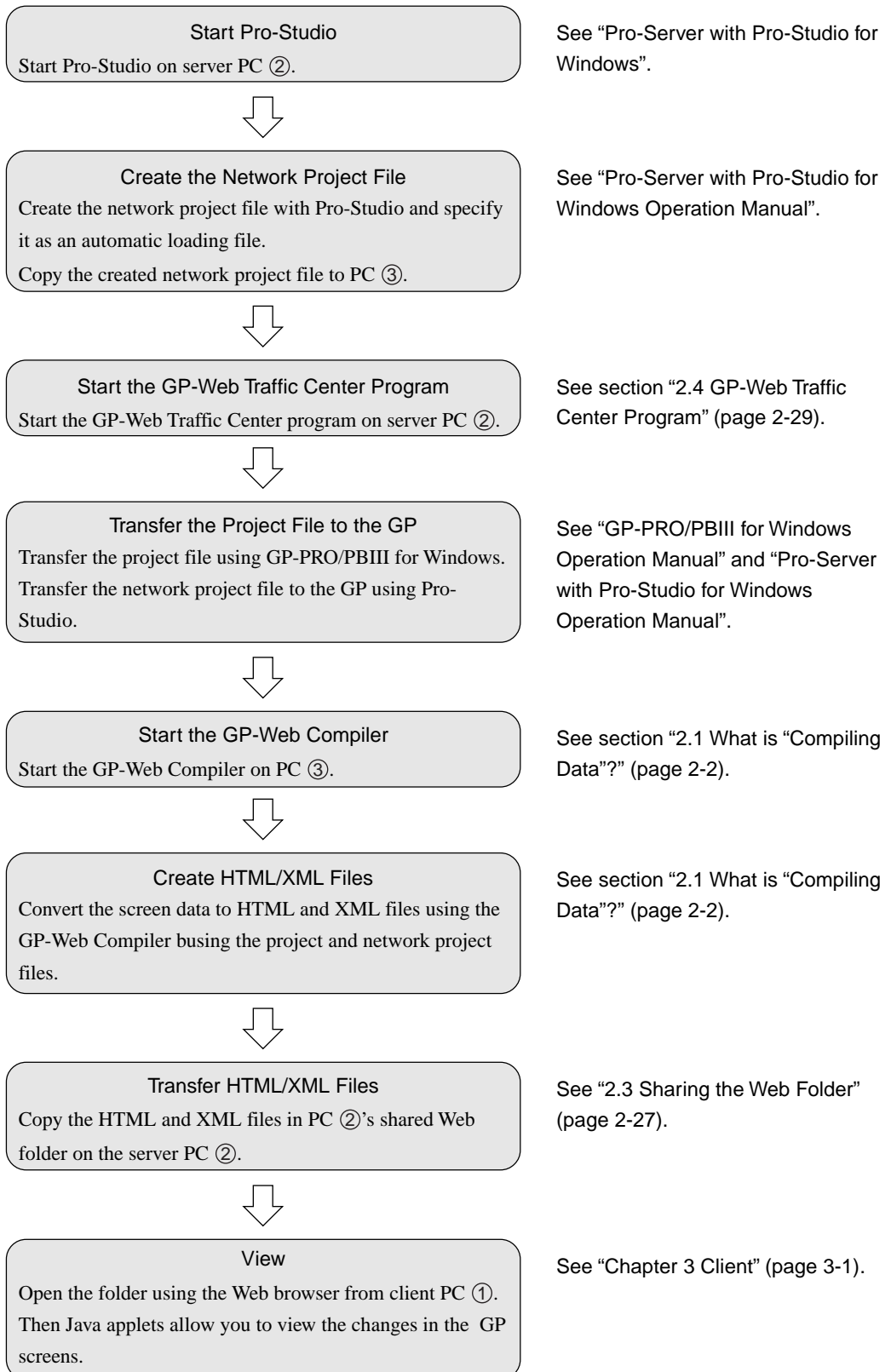

1.3 Information Flow

The GP-PRO/PBIII project file and the Pro-Server network project file are converted to HTML and XML files by the GP-Web Compiler. The IIS then refers to those HTML and XML files. IIS starts, the GP-Web CGI program, which communicates with the GP-Web Traffic Center program. The GP-Web Traffic Center program then connects to Pro-Server and sends GP-Web Java applets. The Java applets are executed on the Web browser of the client PC to provide a GP screen display.

You can also convert the “Device View Setup File” created on Pro-Studio using the Web Device View Compiler program and display GP data on a client PC.

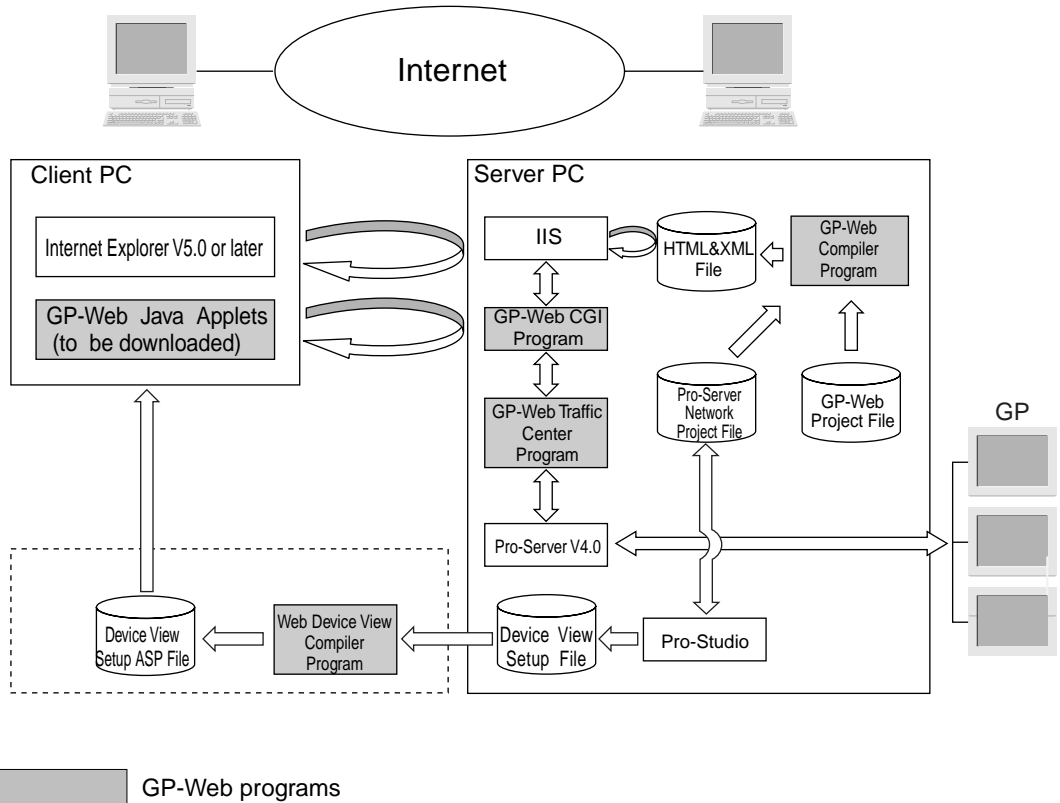

1.4 Applicable GP Units

For a GP to have the GP-Web capability, it must support the 2-Way function. The following table shows these GP models.

Series		Product name	Model	Built-in Ethernet Unit	External Ethernet Unit	Comment		
GP77R Series	GP-377R Series	GP-377RT	GP377R-TC11-24V	×	○	*1		
			GP377R-TC41-24V					
	GP-477R Series	GP-477RE	GP477R-EG11					
			GP477R-EG41-24VP					
	GP-577R Series	GP-577RS	GP577R-SC11					
							GP577R-SC41-24VP	
GP-577RT		GP577R-TC11						
		GP577R-TC41-24VP						
GP2000 Series	GP-2300 Series	GP-2300L	GP2300-LG41-24V	○	×	-		
		GP-2300T	GP2300-TC41-24V					
	GP-2400 Series	GP-2400T	GP2400-TC41-24V					
	GP-2500 Series	GP-2500L	GP2500-LG41-24V					
		GP-2500S	GP2500-SC41-24V					
		GP-2500T	GP2500-TC11					
			GP2500-TC41-24V					
	GP-2501 Series	GP-2501S	GP2501-SC11		×	○	*2	
		GP-2501T	GP2501-TC11					
	GP-2600 Series	GP-2600T			GP2600-TC11			
			GP2600-TC41-24V					
GLC2000 Series	GLC2300 Series	GLC2300L	GLC2300-LG41-24V	○	×			-
		GLC2300T	GLC2300-TC41-24V					
	GLC2400 Series	GLC2400T	GLC2400-TC41-24V					
	GLC2600 Series	GLC2600T	GLC2600-TC41-24V					
IT Series	IT2400 Series	IT2400 TypeA	IT2400-TC41-GP	○	×			-
		IT2400 TypeB	IT2400-TC41-GLC					
						IT2400-TC41-GLC200V		

*1 An expansion Ethernet unit (sold separately) is required for Ethernet functionality.

*2 An expansion Ethernet (sold separately) unit and a bus conversion unit (sold separately) are required for the external Ethernet functionality.

1.5 System Requirements

The following tables show the system requirements for the GP-Web Compiler, the GP-Web Traffic Center program and the client.

GP-Web Compiler

Platform	IBM compatible PC Pentium 133MHz (minimum) Pentium 200MHz or faster (recommended)
OS	Windows NT 4.0 Server/Workstation SP4.0 or later Windows 2000 Server/Professional
Additional Programs	GP-PRO/PBIII for Windows Ver.6.0 or later Pro-Server with Pro-Studio for Windows Ver.4.0 or later (When file modifications such as network project files are required. Possible to acquire GP information without Pro-Server if network project files exist.)
Supported Languages	Japanese/English
Hard Disk Drive	at least 50MB spare capacity
Memory	64MB (minimum)
	128MB or more (provided by user)
Mouse	Supported by OS (required)
Monitor	SVGA or higher

GP-Web Traffic Center Program

Platform	IBM compatible PC Pentium 133MHz (minimum) Pentium 200MHz or faster (recommended)
OS	Windows NT 4.0 Server SP4.0 or later Windows 2000 Server/Professional
Additional Programs	Pro-Server with Pro-Studio for Windows Ver.4.0 or later Internet Information Server Ver.4.0 or later (Windows NT 4.0 Server, Windows 2000 Server/Professional) Microsoft Internet Explorer 5.0 or later (including Java VM)
Supported Languages	Japanese/English
Hard Disk Drive	at least 50MB spare capacity
Memory	64MB (minimum) 128MB or more (recommended)
Mouse	Supported by OS (provided by user)
Monitor	SVGA 64K colors or more

Client

Platform	IBM compatible PC Pentium 133MHz (minimum) Pentium 200MHz or faster (recommended)
OS*1	Windows 95 SR2 or later Windows 98 Windows ME Windows NT 4.0 Server/Workstation SP4.0 or later Windows 2000 Server/Professional
Additional Programs	Microsoft Internet Explorer 5.0 or later (including Java VM)
Supported Languages	Japanese/English/Chinese/Taiwanese/Korean (Error messages are only in English.)
Memory	64MB (minimum) 128MB or more (recommended)
Mouse	Supported by OS (provided by user)
Monitor	SVGA 256 colors (minimum) SVGA 64K colors or more (recommended)

1.6 Installation

This section describes the installation procedure of the GP-Web Compiler and the GP-Web Traffic Center program.

Caution

- Close all application programs before installing the software. Make sure that you also close (or change them to non-resident) all resident programs (e.g. virus checker software) in addition to ordinary application programs.
- When you install these programs on a PC running Windows NT or Windows 2000, be sure to designate an administrator-level user privilege.

MEMO

The GP-Web system consists of four PCs

- (A) Client PC
- (B) GP-Web Server PC
- (C) GP-Web Compiler PC
- (D) Pro-Server PC

These four PCs are not always necessary. A single PC can perform multiple roles. In section “1.2 System Configuration and Configuration Procedure” (page 1-3), the PC (2) is used as a (B) GP-Web Server PC and a (D) Pro-Server PC.

Each PC requires the following software:

- (A) Client PC
 - Internet Explorer 5.0 or later
- (B) GP-Web Server PC
 - IIS Ver.4.0 or later (Additional item installation will be required in case of Windows 2000 Professional. See “OS manual” for details.)
 - GP-Web Traffic Center
- (C) GP-Web Compiler PC
 - GP-PRO/PBIII for Windows Ver.6.0 or later
 - GP-Web Compiler
- (D) Pro-Server PC
 - Pro-Server with Pro-Studio for Windows Ver.3.0 or later
 - GP-Web Traffic Center
 - Web Device View

Installation Procedure

1. Insert the GP-Web CD-ROM into your PC's CD-ROM drive.

The installation program will automatically start and the following window will appear.



2. When you install the GP-Web Compiler, click the [GP-Web Compiler Setup] button. When you install the GP-Web Traffic Center program, click [GP-Web Server Setup].

MEMO

- When you install the GP-Web Compiler, the Web Device View Compiler program is also installed.
- When you install the GP-Web Traffic Center program (GP-Web server), GP-Web Java Applets and CGI programs required for an execution of GP-Web are also installed.
- See “4.3 Installing Easy Connection” (page 4-7) for [Easy Connection Client Setup] and [Easy Connection Server Setup].

Next, the [Choose Setup Language] dialog box will appear.

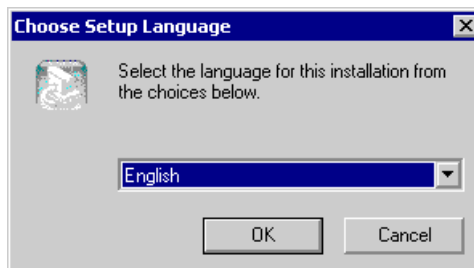

3. Select either [Japanese] or [English] and click the [OK] button.

Follow the instructions given in each following dialog box to complete the software's installation.

Uninstalling GP-Web

When you uninstall the GP-Web server, start the uninstallation procedure after disabling the Web sharing status of the GP-Web Traffic Center program's folder. In the standard installation, the GP-Web Traffic Center program's folder is “C:\Program Files\Pro-face\GP-Web Server\GPWEB”.

1.7 License

The number of clients that can access to the GP-Web system simultaneously is determined by the type of license used.

License Types

Each type of licence is described below.

- Standard 3 Clients This is the standard GP-Web license type. Allows up to 3 clients to access the GP-Web system simultaneously.
- Additional GP-Web 10 Clients 10 clients are added to the standard 3 clients. Allows up to 13 clients can access the GP-Web system simultaneously.
- Unlimited GP-Web Clients An unlimited number of clients can access the GP-Web system simultaneously.
However, the actual number of clients depends on the available system resource of your PC.

Number of Clients

The GP-Web license counts the number of clients based on the number of client Web browsers used. When you start two Web browsers on the same PC, it will be counted as 2 clients. Using the Web browser's ASP to trigger the [GP Alarm Display] will cause the browser to also be calculated as a Client.

If the number of clients accessing the GP-Web system exceeds the number of clients allowed by the license, the message "Traffic Center is currently busy. Your request exceeds the traffic Center's usage limit license. Unable to process." will appear on the Web browser, and communication with the GP system will stop. In this case, close the Web browser and check the limitation of the number of clients.

You can check the number of log in clients from the [GP-Web Traffic Center Resoure Usage Display] Window. See section "2.4 GP-Web Traffic Center Program" (page 2-23).

Increasing the Number of Licenses

An additional 10 GP-Web clients and unlimited GP-Web clients are available as options on separate floppy disks. You can order whichever floppy disk meets to your needs.

After starting the program contained in the floppy disk, the window for entering the KEY CODE will appear. Enter the KEY CODE that you are currently using for your GP-Web installation. If the KEY CODE matches, then the program will continue and the requested number of licenses will be added. For detailed information about how to increase the number of licenses, see ReadmeE.txt in the floppy disk.

MEMO

If the KEY CODE does not match, the program will stop and the number of licenses will not be updated. Be sure you type the correct KEY CODE used for your GP-Web installation.

2 | GP-Web Operation

- 2.1 What is “Compiling Data”?
- 2.2 Template HTML files for the GP-Web Compiler
- 2.3 Sharing the Web Folder
- 2.4 GP-Web Traffic Center Program
- 2.5 Setting Up Security Settings
- 2.6 Referring to Logs
- 2.7 Various Language Supports

2.1 What is “Compiling Data”?

This is where GP-Web converts a GP-PRO/PBIII project file or a Pro-Studio network project file to HTML or XML files. Then, by uploading these HTML or XML files to the Web, they can be viewed on your PC’s Web browser.

MEMO

There is a limit in the Web browser’s display function. Appropriate displays may not be performed even if compile processes are completed successfully. Prior to creating the GP-Web screen, check supported commands in Appendix. See “Appendix Supported Drawing Commands” (page A-5). See “Appendix Supported Tag Commands” (page A-8).

Starting the GP-Web Compiler

There are two ways to start the GP-Web Compiler:

- From the [Transfer] window of GP-PRO/PBIII.
- From the Windows [Start] menu.

Starting GP-Web from the GP-PRO/PBIII [Transfer] Window

1. In the GP-PRO/PBIII [Transfer] window, select [Transfer]-[Start GP-Web Compiler] or click on the  icon.
The project file opened by GP-PRO/PBIII can then be transferred and the [GP-Web Compiler - Project File and Output Folders] window will appear.

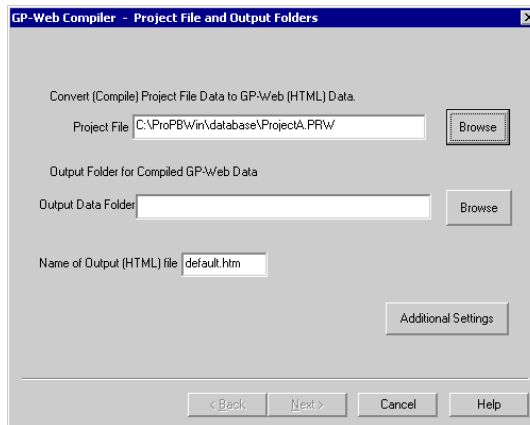

Starting from the [Start] Menu

MEMO

This method runs the GP-Web Compiler without preparing the project file for transfer. Therefore, be sure to use GP-PRO/PBIII to prepare the project file before starting the compile process. See "GP-PRO/PBIII for Windows Operation Manual" for details. However, if GP-PRO/PB III for Windows Ver. 6.0 or later has been installed, the transfer preparation is automatically completed.

1. Click the [Start] menu.
2. Select [Program]-[Pro-face]-[GP-Web]-[GP-Web Compiler].
The [GP-Web Compiler - Project File and Output Folders] window will appear.

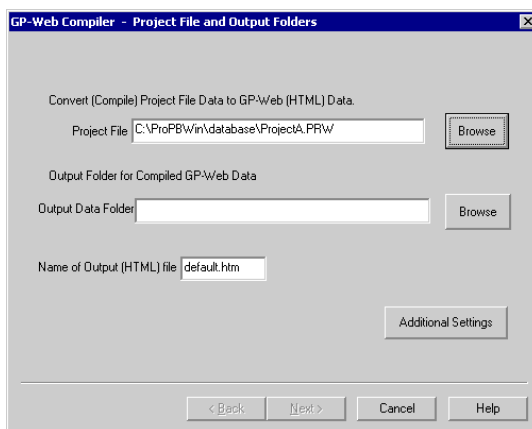

Using the GP-Web Compiler

1. Start the GP-Web Compiler.
The [GP-Web Compiler - Project File and Output Folders] window will appear.

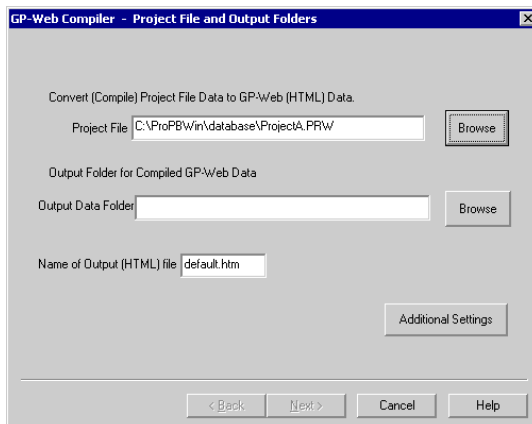

2. Enter the previously prepared GP-PRO/PBIII project's filename in the [Project File] area. Either type in the full path to the file or select the file by clicking the [Browse] button.
3. In [Output Data Folder], specify the folder to be used for the HTML or XML output files. Either type in the full path to the folder or select the folder by clicking the [Browse] button.
4. Enter the HTML output filename that you wish to use in the [Output Data Folder]. Normally, enter the same name as the default filename shown when referring to the Web page with the IIS.

The default filename is default.htw.

The filename can be up to 31 characters.

If the name is used for the [Name of output (HTML) file] is a name other than [default.htm], use the IIS Settings area's [Enable Default Document] to add the desired name. If the name is not added in this way, the data in the Share folder is accessed by the Web Browser.

See section "2.5 Setting Up Security Settings / Referencing the Web Share Folder" (page 2-48).

5. If you wish to designate additional compilation result settings, click the [Additional Settings] button. If not, jump to the step 9.

The [Additional Settings] dialog box will appear.

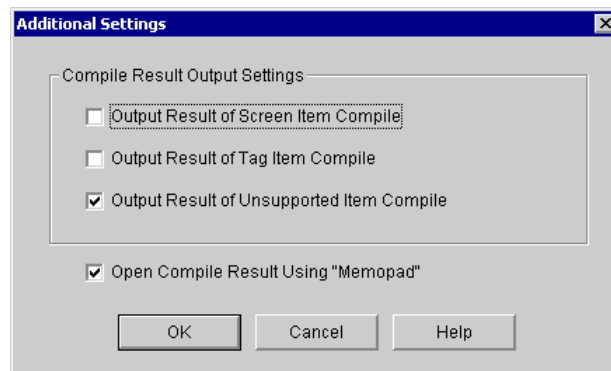

6. In [Compile Result Output Settings], specify the compilation result information that you wish to output by clicking on the corresponding check boxes.

[Output Result of Screen Item Compile] This outputs the result when screen drawing commands have been converted.

[Output Result of Tag Item Compile] This outputs the result when tag commands have been converted.

[Output Result of Unsupported Item Compile] ... This outputs the result when unsupported drawing or tag commands have been converted.

By default, only [Output Result of Unsupported Item Compile] is checked.

7. If you wish to see the compilation result after processing is finished, check the [Open Compile Result Using "Memopad"] box.

By default, this box is checked.

8. Click the [OK] button.

The [Additional Settings] dialog box is closed and control will return to the [GP-Web Compiler - Project File Output Folders] window.

9. Click the [Next] button.

The [GP-Web Compiler-Web Page Format and Network Project Files] window will appear.

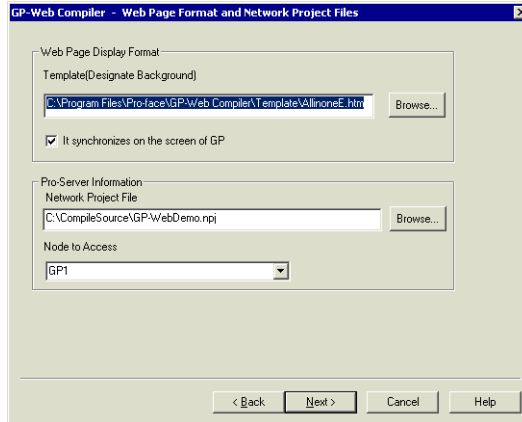

10. In [Web Page Display Format] area's [Template] section, specify the template file used for creating HTML files. You can either type in the full path to the file or select the file by clicking the [Browse] button.

Default is Template.htm which is located in the GP-Web Template folder.

This template HTML file is also user definable. See section "2.2 Template HTML files for GP-Web Compiler" (page 2-16).

11. Specify if you wish to synchronize with GP screens in [Synchronize Screen Switching with GP] of [Web Page Display Format]. If checked, it is synchronized, and if not, it is not synchronized.

The default is unchecked. The following item will be added to the PRAM tag in default.htm according to the setup contents of [Synchronize Screen Switching with GP].

Synchronous: `<PARAM NAME="SYNC" VALUE="SYNCHRONOUS">`

Asynchronous: `<PARAM NAME="SYNC" VALUE="ASYNCHRONOUS">`

12. In [Pro-Server Information] - [The network project to belong], specify the Pro-Server network project file. Either type in the full path to the file or select the file by clicking the [Browse] button.

13. In the [Node to Access] section, specify the web sites to be used.

You can choose nodes defined in the network project file.

14. Click the [Next] button.

The [GP-Web Compiler - GP Alarm Display Settings] window will appear.

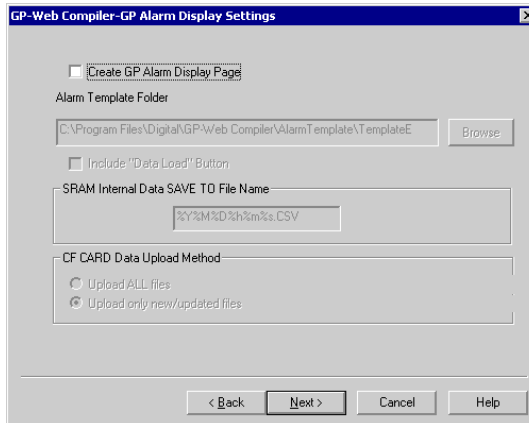

In this window, you can set up the type of display shown on the client's Web browser for GP internal alarm or log data. Pro-Server converts GP internal alarm data to a CSV file which can be displayed by the client.

See section "3.2 GP Alarm Display" (page 3-3) for the details about referring to GP internal data.

15. When you wish to display the alarm or log data on the client's Web browser, click the [Create GP Alarm Display Page] check box. If you do not need to use this feature, jump to step 19. If you do click on this check box, [Alarm Template Folder] and [Include 'Data Load' Button] will become available further setup.

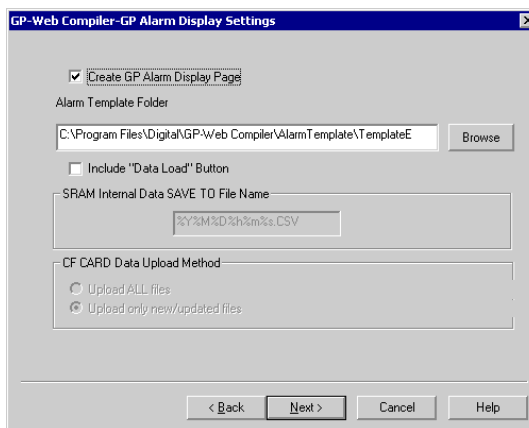

16. In [Alarm Template Folder], specify the folder where the page template for the alarm log display is stored. It "AlarmTemplate" is the default, which is in the GP-Web folder. Specify either "TemplateJ" or "TemplateE". Either type in the full path to the folder or select the folder by clicking the [Browse] button.

In the "TemplateJ" and the "TemplateE" folders, you will find ASP files for your template.

TemplateJ folder Contains Japanese template files.

TemplateE folder Contains English template files.

17. If you wish to enable [Upload of the latest Data] in the GP Alarm Display window, click on the [Include 'Data Load' Button] check box. If not, jump to step 19.

If you check this box, additional settings in the [SRAM Internal Data SAVE TO File Name] area will become available.

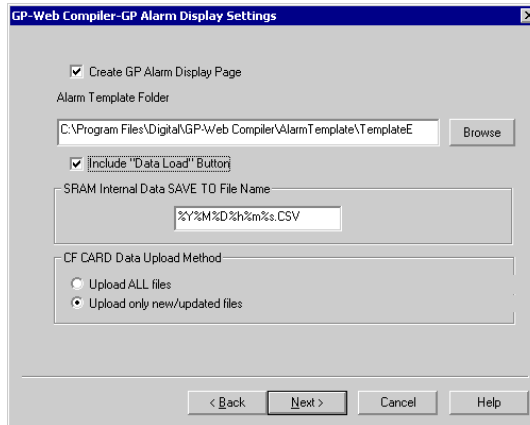

MEMO

- In the GP Alarm Display window, if you click [Upload of the latest Data], a new CSV file will be created from the latest log data. If you do not want client users to create new CSV files, do not check this box.
- If you click [Upload of the latest data], the CSV file will be stored in the GP-Web Server PC, rather than the client PC where the Web browser is open.

18. In the [SRAM Internal Data SAVE TO File Name] area, type the filename used to save GP backup SRAM data.

Log data is saved using the filename entered here, every time the [Upload the latest data] button in the alarm display is clicked. If you specify the date or the time, that data from server PC will be attached to the filename when it is saved.

year %Y

month %M

date- %D

hour %h

minute ... %m

second ... %s

Thus, if you wish to save the file with the year, month, date, hour, minute and second included in the filename, type "%Y%M%D%h%m%s.CSV".

If you type a specific filename, the file contents will be always updated using that name file.

You can use up to 31 characters.

19. In [CF CARD Data Upload Method], select either [Upload All files] or [Upload only new/updated files] when reading files from the GP CF Card.

[Upload All files] All files are read. When a file with same filename is found, the existing file will be updated.

[Upload only new/updated files] All files are read. When a file with same filename is found, the existing file will be updated with the new file if that file is newer. If not, the existing file will not be updated.

20. Click the [Next] button.

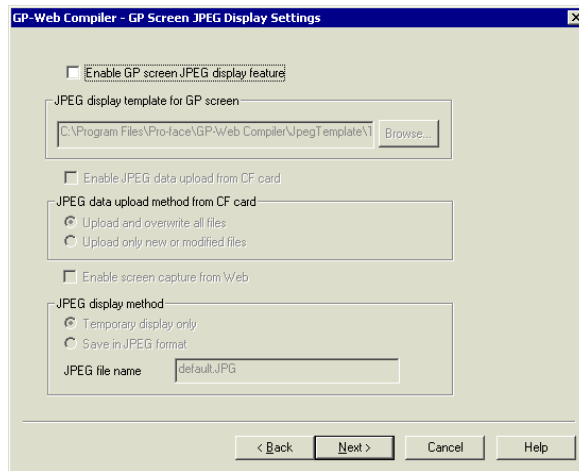

The [GP-Web Compiler – GP Screen JPEG Display Settings] window will appear.

In this window, using the GP screen JPEG image capturing feature supported by GP-PRO/PBIII Ver.6.0 allows you to set to display JPEG images on your Web browser. You can also upload JPEG data from the CF Card attached to the GP system and display those JPEG data on a client PC. For details of referring to GP’s internal data, see “3.3 GP Screen JPEG Display Feature” (page 3-9).

21. Check [Enable GP screen JPEG display feature] to display GP’s JPEG data on a client’s Web browser. If you do not check it, you should jump to the step 28.

When checked, the [JPEG display template for GP screen] field becomes active.

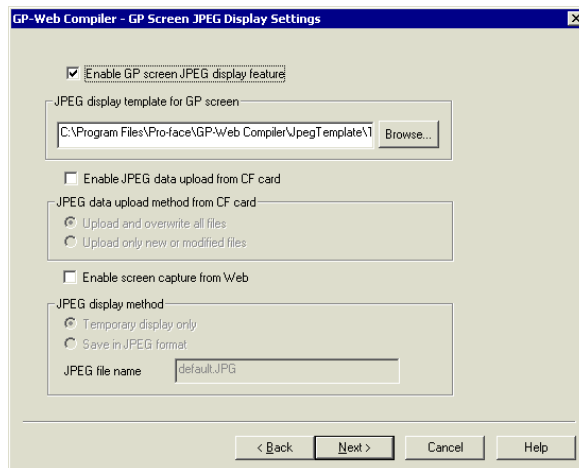

22. In the [JPEG display template for GP screen] field, specify the template folder name for JPEG data of GP screens. As defaults, “TemplateJ” or “TemplateE” is typed under the Japanese or English language environment respectively.

23. Check [Enable JPEG data upload from CF card] to read JPEG data from the CF Card attached to the GP system. If you do not check it, jump to step 28.

When checked, the [JPEG data upload method from CF Card] field becomes active.

24. In the [JPEG data upload method from CF Card] field, select the uploading method of JPEG files from the CF Card attached to the GP system from either [Upload and overwrite all files] or [Upload only new or modified files].

[Upload and overwrite all files] All files are read. If files with the same names exist, they will be overwritten.

[Upload only new or modified files] All files are read. If files with the same names exist and dates of uploaded files are later than those existing files, they will be overwritten. If not, they will be left as they are.

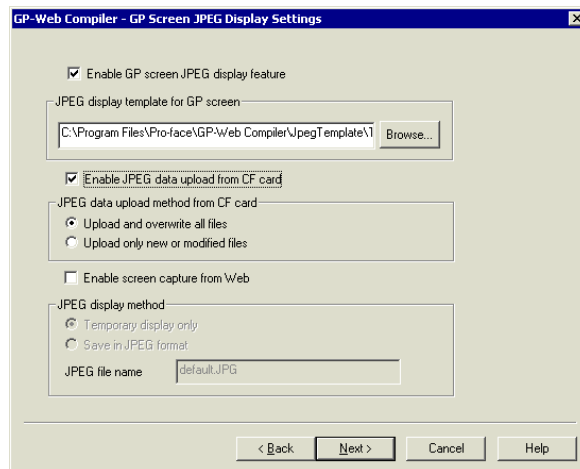

25. Check [Enable screen capture from Web] to add the [GP screen capturing & upload] button in the GP screen JPEG display feature window.

When checked, the [JPEG display method] field becomes active.

26. In the [JPEG display method] field, specify the display method of the GP screen capture.
 [Temporary displays only] .. GP screen capture are displayed temporarily and are not saved.
 [Save in JPEG format] GP screen capture are displayed and saved.

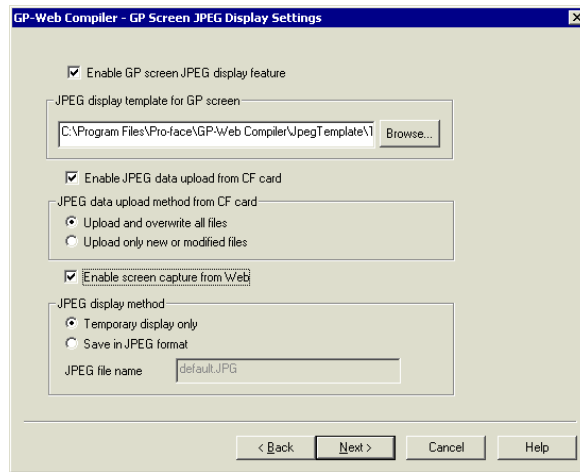

27. If you selected [Save in JPEG format], you should enter the file name to save the screen capture in the [JPEG file name to save] field.

When you click the [GP screen capturing & upload] button in the GP screen JPEG display feature window, the screen capture is saved every time to the file specified here.

year %Y

month %M

date%D

hour%h

minute%m

second%s

If you wish to save the file with the year, month, date, hour, minute and second included in the filename, type “%Y%M%D%h%m%s.JPG”.

If you type a specific filename, the file contents will be always updated.

You can enter up to 31 characters.



28. Click the [Next] button.

The [GP-Web Compiler - Display and Web Server Settings] window will appear.

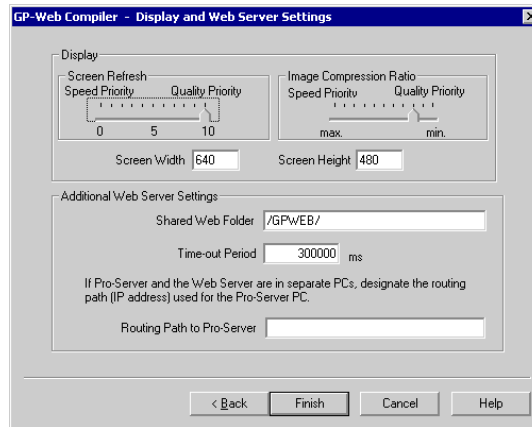

29. In [Display] - [Screen Refresh], set the desired resolution level.

Choosing [Speed Priority] will speed up the screen refresh time. However, there will be a limit to the graphic and tag execution capability by Java applets.

Choosing [Quality Priority] allows you to view all the graphic and tag capability of Java applets. However, the screen refresh will slow.

The following level description shows the GP-Web Java applet processing performed.

- 0 Top priority is communication speed. However, there will be certain restrictions, due to the limitation of graphic and tag execution by Java applets.
- 1 to 4 Creates a rectangle fill pattern.
- 5 Makes text string background colors transparent.
- 6 Makes S-tag background fill patterns and the background colors transparent.
- 7 Makes G-tag graphic colors transparent.
- 10 Performs all functions.

The default is [10].

30. In [Display] - [Image Compression Ratio], specify the JPEG image compression ratio to convert images included in the project file.

When you set this to [max], the display refresh will speed up, since JPEG file sizes become smaller due to the higher JPEG file compression ratio. However, the image quality will become poorer, compared to [min].

When you set it [min], produces image quality closer to original images because of the lower compression ratio. However, the screen refresh will slow down due to larger file sizes.

The default is [8].

31. In [Screen] - [Screen Width] and [Screen Height], enter the display window width and height.
Default is the width and height of the target GP screen resolution.
Both values can be from 1 to 1024.
32. In [Additional Web Server Settings] - [Shared Web Folder], type the Web shared folder name where the GP-Web Traffic Center program is installed.
Default is "/GPWEB/".

MEMO

When you perform the standard installation of the GP-Web Traffic Center program, the program will be installed in the "C:\Program Files\Pro-face\GP-Web Server\GPWEB" folder. Share this folder on the Web with the folder name (alias name) specified here. See section "2.3 Sharing the Web Folder" (page 2-21).

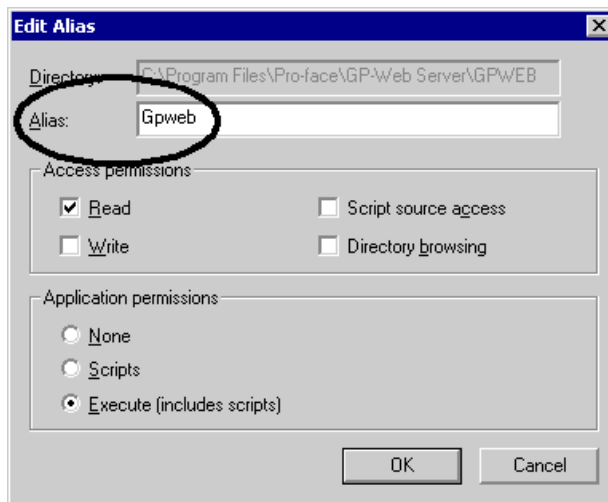

33. In [Additional Web Server Settings] - [Time-out Period], enter the time in ms for Java applets to timeout when the GP-Web CGI program does not respond.
The time range is from 0 ms to 3000000 ms.
Default is "3000000 ms".

34. When IIS and Pro-Server are installed on different PCs, you should specify in [Additional Web Server Settings] - [Routing Path to Pro-Server] the computer name or IP address where Pro-Server exists.

In the following case that the separate data gathering PC and the Web server are used, enter "\\PC2".

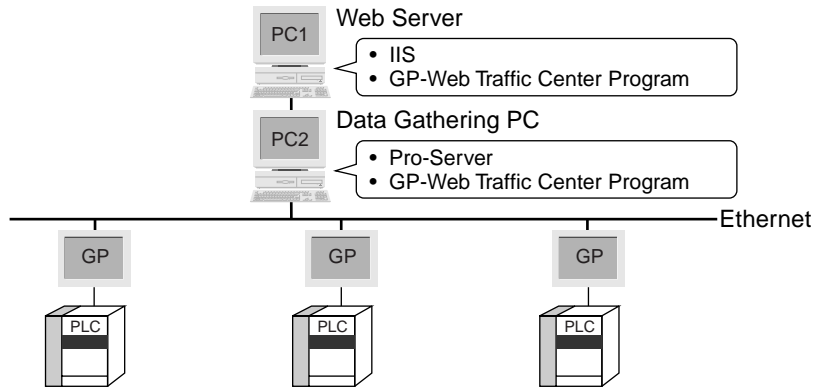

In the following case that one Web server monitors multiple data gathering PCs, enter "\\PC2\\PC3". You should separate each level of the PC name with "\\".

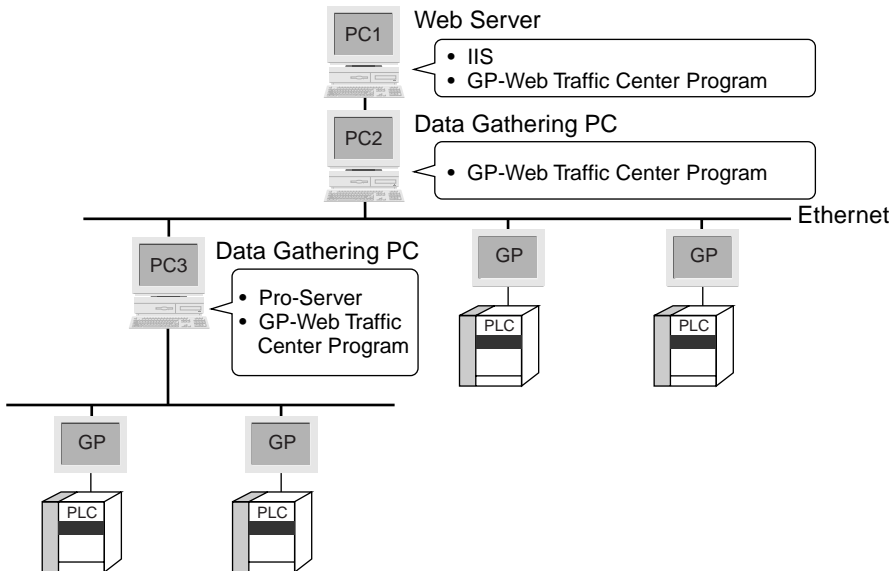

You can type up to 255 characters and use up to 3 hierarchical routing paths.

There are no default values.

MEMO

When you specify computer names, those names need to be decided based on either the DNS or the HOSTS file. If this type of "resolution" is not needed, specify their addresses directly.

35. Click the [Finish] button.

The compile will start.

When the compile has been completed successfully, the following message will appear.

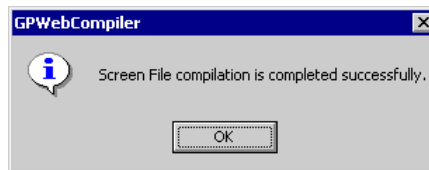

36. In this case, click the [OK] button.

If you have checked [OpenMemoPad] in step 7, the compilation result will be displayed.

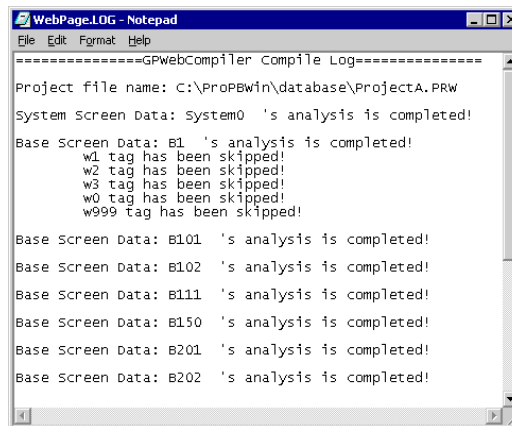

MEMO

- If the compile fails, the following message will appear. Click the [OK] button to close the message window.

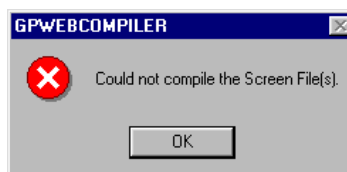

- One reason for a failed compile is that the project file compiled has errors. Check the project file using GP-PRO/PBIII for Windows.

2.2 Template HTML files for the GP-Web Compiler

When you install the GP-Web Compiler, “Template HTML files” are also installed.

The “Template HTML file” is used by the GP-Web Compiler to refer to as its template when it creates HTML files. Titles or frames have been specified in this file. This file contains GP-Web reserved words (reserved replacement marks) and is customizable.

Template HTML file for Automatic Creation of default.htm

“default.htm” is the default display file when referring to the Web page with IIS, and it is used for displaying GP screens on the Web browser. This file is automatically created when GP screens are compiled by the GP-Web Compiler. The Template HTML file is used for this automatic default.htm creation. The GP-Web Compiler creates default.htm from the GP-PRO/PBIII for Windows project file and the Pro-Server network project file based on the Template HTML file.

The Template HTML file is also copied when you have installed the GP-Web Compiler. It will be copied in the “Template” folder which is located in the GP-Web Compiler folder. The following shows the contents of the Template folder.

templateJ.htm This is the template file in Japanese for displaying GP screens on the Web browser.

SampleJX.htm (X:number) This is the sample file in Japanese.

template.htm This is the template file in English for displaying GP screens on the Web browser.

SampleX.htm (X:number) This is the sample file in English.

The Template HTML file, descriptions contain reserved items. These are called “reserved replacement marks”. The following “Template HTML file” explains those reserved replacement marks.

Template HTML file

```
<HTML>
<HEAD>
<META NAME="GENERATOR" Content="GP-Web Compiler 1.0">
</HEAD>
<BODY>

<P>
project title =$$ProjectTitle$$ <BR>
PLC name =$$PLCName$$ <BR>
target channel name of the network project =$$NodeName$$ <BR>
</P>

<applet code=GPWebTemplate.class func=AlarmButton></applet>
<applet code=GPWebTemplate.class func=Main></applet>
<applet code=GPWebTemplate.class func=ScreenChange></applet>
<applet code=GPWebTemplate.class func=QualitySlider></applet>
</BODY>
</HTML>
```

As you can see in “\$\$ProjectTitle\$\$”, characters surrounded by “\$\$” are reserved replacement marks for outputting the project or the network project file information.

Characters starting with “<applet code=GPWebTemplate.class” are applets for changing screen settings. There are 6 types of applets. They are: screen/resolution/synchronization/data polling interval/drawing interval/multi language table change applets.

Specifying GP-PRO/PBIII for Windows Project File Information

The following information describes the reserved replacement marks that are used to output GP-PRO/PBIII for Windows project file information.

The GP-Web Compiler outputs information to the specified location, based on the reserved replacement marks used to output the GP-PRO/PBIII project file information.

The following reserved replacement marks are used.

`$$ProjectFileName$$` Outputs the filename of the project file. This filename does not have the file extension.

`$$ProjectPath$$` Outputs the path name to the project file.

`$$ProjectTitle$$` Outputs comments to the project file.

`$$PLCName$$` Outputs the project file PLC type in English.

`$$PLCNameJ$$` Outputs the project file PLC type in Japanese.

`$$GPType$$` Outputs the project file GP type in English.

`$$GPTypeJ$$` Outputs the project file GP type in Japanese.

Specifying the Pro-Server Network Project File Information

The following information describes the reserved replacement marks that are used to output the Pro-Server network project file information.

The GP-Web Compiler outputs information to the specified location, based on the reserved replacement marks used to output the Pro-Server network project file information.

The following reserved replacement marks are used.

`$$NodeName$$` Outputs the target channel name of the network project file.

`$$NetworkProjectFileName$$` Outputs the filename of the network project file. This filename does not have a file extension.

`$$NetworkProjectPath$$` Outputs the path name to the network project file.

`$$NodeIPAddress$$` Outputs the IP address of the network projects target channel name in “xxx.xxx.xxx.xxx” format (dot notation).

Adding Additional Data to the Template File

When you want the template HTML file to automatically refer to image data, you need to create a folder to store those data files.

The data file should be stored in the same folder as the template HTML file.

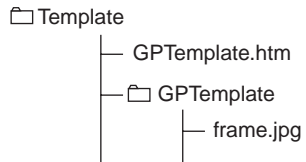

This folder is automatically copied to the output folder when the GP-Web Compiler is started.

Multi Language Table Change Applet

This allows you to display character string table files created in various languages (Korean, Chinese, Taiwanese, ASCII) in compliance with GP-Pro/PBIII Ver. 6.0's multi language feature.

Declaration and Screen

You should add the following declaration statement in the template HTML file using an HTML editor to execute the multi language table change applet.

```
<applet code=GPWebTemplate.class func=TableChange></applet>
```

The following window is displayed at the location that you inserted the declaration statement.

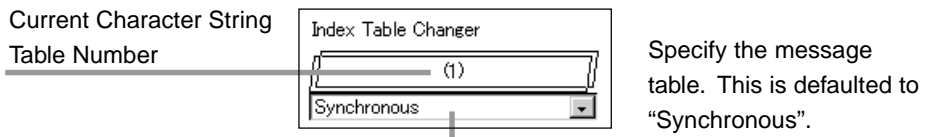

This becomes "Asynchronous" mode when you specify the message table number.

MEMO

This feature has been supported only by the GP2000 Series.

Screen Change Applets

This applet changes to the specified screen number, depending on whether you have used the GP-Web Compiler to specify the synchronization of the GP screen and the Web browser or not.

If the screen change is synchronized, the screen with the number specified in the GP's LS area will be displayed. The screen cannot be changed via the Web browser.

If the GP screen is synchronized, the initial screen set in the GP-PRO/PBIII project file will be displayed first. Then, when you switch the screen number via the screen change applet, the specified number screen will be displayed. The GP screen will not be changed at this time.

Declarations and Screens

To use the screen change applet, use your HTML editor to add the following declaration sentence to the template HTML file.

```
<applet code=GpwebTemplate.class func=ScreenChange></applet>
```

The following screen will be displayed at the location where you added the declaration sentence:



The screenshot shows a graphical user interface for the ScreenChange applet. At the top, the label "ScreenNo" is positioned above a text input field. The input field contains the number "1". Below the input field, there are three buttons arranged horizontally: "Set", "Prev.", and "Next". Each button has a light gray background and a dark border.

[ScreenNo] Enter the screen number that you wish to display.

[Set] button When you click it, the screen with the number specified in [ScreenNo] will be displayed.

[Prev.] button When you click it, the previous screen will appear.

[Next] button When you click it, the next screen will appear.

When the Designated Screen Does Not Exist

When the screen specified by the screen change applet does not exist:

	Synchronize with the GP Screen	Does Not Synchronize with the GP Screen
Screen number specified in the LS area.	The error message, "Error: Cannot find Screen file Number XX." (XX: screen number) will be displayed.	The screen number specified in the LS area is not available.
Screen number specified in [ScreenNo] of the screen change applet.	The screen cannot be changed via Web browser.	The error message, "Error: Cannot find Screen file Number XX." (XX: screen number) will be displayed.
Screen number specified by clicking the [Next] button of the screen change applet.	The screen cannot be changed via Web browser.	By skipping screens not existing, the screen which comes next will be displayed. If there are no screens existing, the screen will not be switched.
Screen number specified by clicking the [Prev.] button of the screen change applet.	The screen cannot be changed via Web browser.	By skipping not existing screens, the screen which showed previously will be displayed. If there are no screens existing, the screen will not be changed.
Initial screen number.	It will be set to the initial screen number defined for the GP system.	The error message, "Error: Cannot find Screen file Number XX." (XX: screen number) will be displayed.

Resolution Change Applet

This applet allows the screen resolution to be changed. You can specify the resolution level, from 0 to 10. Level 0 provides the fastest communication speed, however there will be a limitation to the graphic and tag execution capability of the Java applets. The higher the level, the better the graphic and tag display performance becomes, however the communication speed will slow.

Declarations and Screens

To use the resolution change applet, use your HTML editor to add the following declaration sentence in the template HTML file.

```
<applet code=GpwebTemplate.class func=QualitySlider></applet>
```

The following will appear at the location where you added the declaration sentence:

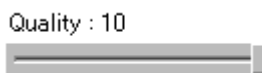

When you move the slide, the [Quality] value will change. When you slide the scale to the far left, the value becomes 0, and 10 for the far right. The following shows at each value's performance:

- 0 Top priority is communication speed. However, there will be a limit, due to the inability of graphic and tag execution by Java applets.
- 1 to 4 Creates a rectangle fill pattern.
- 5 Makes text string background colors transparent.
- 6 Makes S-tag background fill patterns and the background colors transparent.
- 7 Makes G-tag graphic colors transparent.
- 10 Performs all functions.

Synchronization Change Applet

This applet changes the synchronization between the GP and the Web browser.

Declarations and Screens

To execute the synchronization change applet, use your HTML editor to add the following declaration sentence in the HTML template file:

```
<applet code=GPWebTemplate.class func=SyncModeChange></applet>
```

The following will appear at the location where you added the declaration sentence:



[SyncMode] When the GP screen synchronizes with the Web browser, “Sync” will appear. When the two are not synchronized, it “Async” will appear.

[Sync] button Click here and the [SyncMode] will change to “Sync” and the GP screen will synchronize with the Web browser. When they are synchronized, the screen number specified in the GP’s LS area is referred to by the Web browser. Therefore, when the GP screen is changed, the screen on the Web browser changes to the same screen. The screen cannot be changed via the Web browser.

[Async] button Click here and the [SyncMode] will change to “Async” and the synchronization between the GP screen and the Web browser will be cancelled.

Adding Full Synchronous Mode

You can add Full Synchronous mode to the above applet, which allows you to change GP screens from GP-Web.

To use Full Synchronous mode, you should add the following parameter in the template HTML file using an editor.

```
<PARAM NAME=”FULLSYNCMODE” VALUE=”ON”>
```

After you add the parameter, a “Full Synchronous” mode button is attached to the synchronization switching applet.

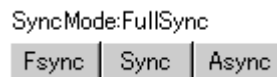

[Fsync] button If you click this button, the following message appears.

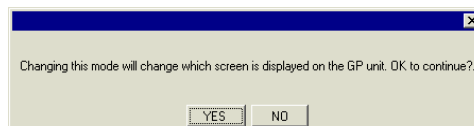

If you click [Yes], it will be shown as [Full Synchronous] in [Synchronous Mode], and GP and the Web browser screens synchronize with each other. Therefore, if you change a screen on the Web browser, the corresponding GP screen will also be changed.

MEMO

The [Full Synchronous] feature can be executed only when the bit 4 of LS2076 of the GP system is equal to "1". If it is equal to "0", an error occurs.

Data Polling Interval Change Applet

This allows you to freeze (stop temporarily) the data polling of GP-Web Java Applets or to change the interval. However, you may not set the data polling interval shorter than the polling interval of the GP-Web Traffic Center program.

Declaration and Screen

Add the following declaration statement in the template HTML file using an HTML editor to execute the data polling interval change applet.

```
<applet code=GPWebTemplate.class func=PollingSpeedChange></applet>
```

The following window appears where you inserted the declaration statement.

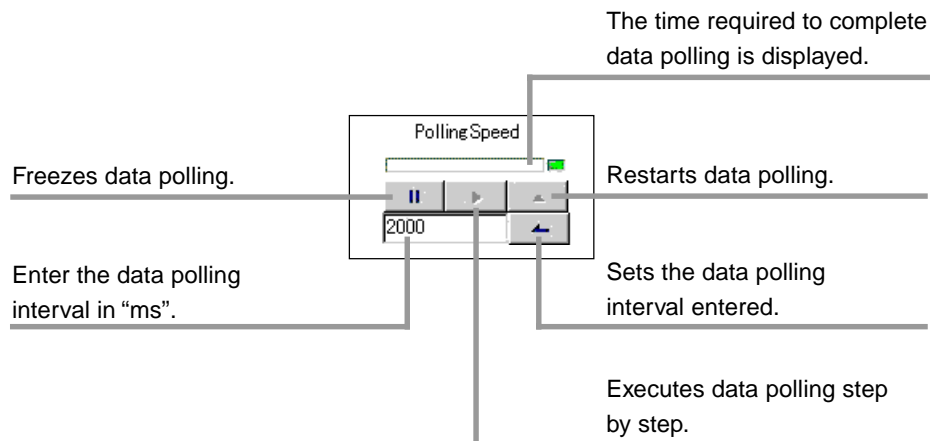

Drawing Interval Change Applet

This allows you to freeze (stop temporarily) the drawing of GP-Web Java Applets or to change the interval.

Declaration and Screen

You should add the following declaration statement in the template HTML file using an HTML editor to execute the drawing interval change applet.

```
<applet code=GPWebTemplate.class func=DrawCycleChange></applet>
```

The following window is displayed at the location that you inserted the declaration statement.

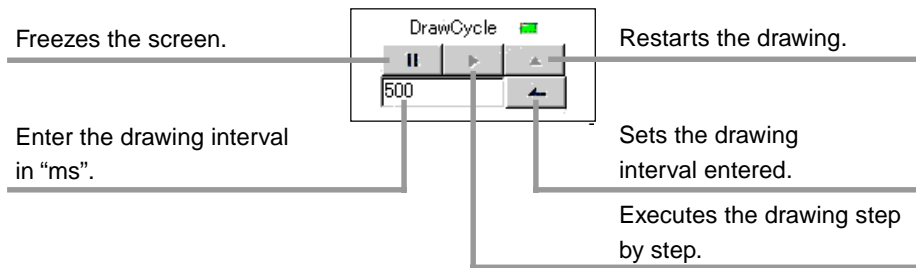

2.3 Sharing the Web Folder

The following two folders should be shared (opened) on the Web to view GP screens on a Web browser.

- the folder where the GP-Web Traffic Center program has been installed
- the folder containing data compiled by the GP-Web Compiler

Subsequent parts in this section describe how to share those folders on the Web using Explorer.

If you share those folders on the Web via IIS, you can set up detailed security items.

See “2.5 Setting up Security Settings” (page 2-36).

Sharing the GP-Web Traffic Center Program Folder on the Web

You should setup the following folder on the GP-Web server PC, where the GP-Web Traffic Center program has been installed, to share that data on the Web. It is C:\Program Files\Pro-face\GP-Web Server\GPWEB, assuming a standard GP-Web installation was performed.

Click the folder to be shared on the Web with the right mouse button, and then select [Properties]. Select the [Share this folder (C):] option in the [Web Sharing] tab. Set these additional items as follows.

- [Alias] ---> [Gpweb]
- [Access permissions] ---> [Read]
- [Application permissions] ---> [Execute (includes scripts)]

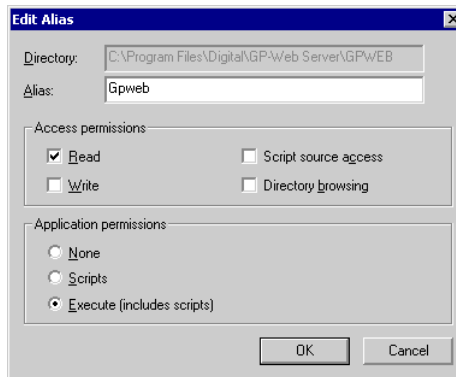

MEMO

- The [Web Sharing] tab may not appear if you use Windows NT4.0 or Windows 2000 and has logged in Windows as a user without the administrator privilege. In such a case, log in as a user with the administrator privilege or set the Web sharing capability using the IIS administrative tool.
- The folder alias to set here should be the same name as that of the [Shared Web] field in the [GP-Web Compiler - Display and Web Server Settings] window. It is recommended to set it to [GPWeb] in the [Web Sharing] tab since the default value of the [Shard Web] field is [/GPWeb/] (the first and the last "/" in "/GPWeb/" stand for separation marks and they are not necessary to add to the alias name).
See “2.1 What is “Compiling Data”?” (page 2-2).
- The alias value is not case sensitive.
- When you uninstall GP-Web server, start the uninstallation procedure after disabling the Web sharing status of the GP-Web Traffic Center program's folder.

Sharing the Folder Containing Data Compiled by the GP-Web Compiler

You should setup the folder where HTML, XML or JPEG files compiled by the GP-Web Compiler are stored to be shared on the Web.

If you performed the compilation on the GP-Web server PC, you should share the output folder on the Web.

If you performed the compilation on a PC other than the GP-Web server PC, you should copy the folder containing compiled data on the GP-Web server and share it on the Web.

You should use the different alias name from that of the GP-Web Traffic Center program folder (normally a name other than "GPWEB").

Share the above two folders on the Web, start the GP-Web Traffic Center program and Pro-Server and specify those URLs of shared Web folders (alias) in the client's Web browser, then GP screens will appear.

http://[IP Address]/[Alias]/

[IP Address] Indicates the GP-Web Server's IP Address, or the domain name registered in the DNS.

[Alias] Indicates alias of Web Share folder used for storage of HTML, XML, JPEG files, as well as others.

See "2.4 GP-Web Traffic Center Program" (page 2-29).

See "3.1 Web Browser" (page 3-2).

2.4 GP-Web Traffic Center Program

This section describes how to start, exit and setup the GP-Web Traffic Center program, and also how to setup the security of the program.

Starting the GP-Web Traffic Center Program

1. Click the [Start] menu.
2. Select [Program]-[Pro-face]-[GP-Web]-[Traffic Center].

The GP-Web Traffic Center program will be started and the [GP-Web Traffic Center Resource Usage Display] window will appear.

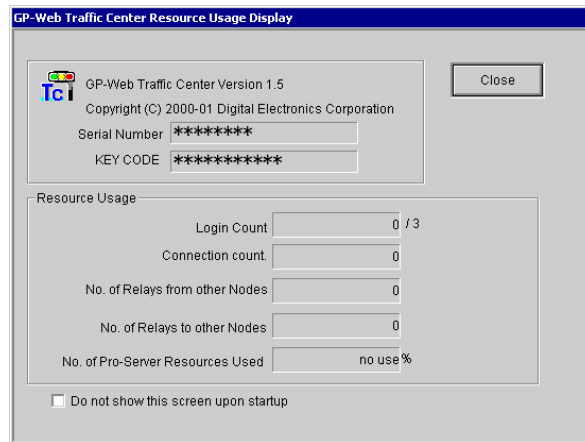

The icon indicating that this program is running will appear in the right side of the task bar.



MEMO

- If Pro-Server has not been started, it will be started automatically when data transfer begins.
- If you check [Do not show this screen upon startup], the [GP-Web Traffic Center Resource Display] window will not appear from the next time. If you wish to display it again, click [Display Resource] on [Program] of the GP-Web Traffic Center program, and then uncheck [Do not show this screen upon startup].

3. Click the [Close] button.

This will close the [GP-Web Traffic Center Resource Usage Display] window. The program icon will remain displayed in the task bar.

MEMO

If Pro-Server Ver. 4.0 or older has been installed, the following screen is displayed.

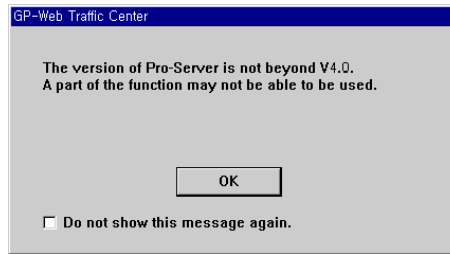

Exiting the GP-Web Traffic Center Program

1. Click the GP-Web Traffic Center program icon.
The menu will appear.

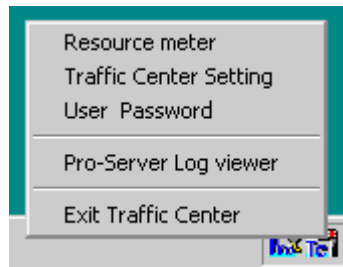

2. Select [Exit Traffic Center].
This will terminate the GP-Web Traffic Center program, and the icon will disappear from the task bar.

MEMO

If you exit Pro-Server, be sure to exit the GP-Web Traffic Center program first.

Setting up the GP-Web Traffic Center Program

With the GP-Web Traffic Center program, you can set up the number to retry when device read errors occur and the polling period used access to the server.

Displaying the GP-Web Traffic Center Program Settings Window

1. Click the GP-Web Traffic Center program icon in the task bar.
The menu will appear.

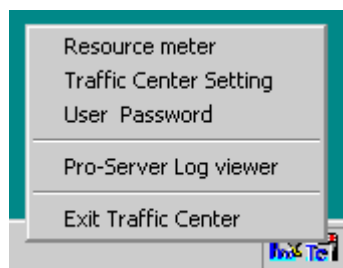

2. Select [Traffic Center Settings].

The [GP-Web Traffic Center Settings] dialog box will appear.

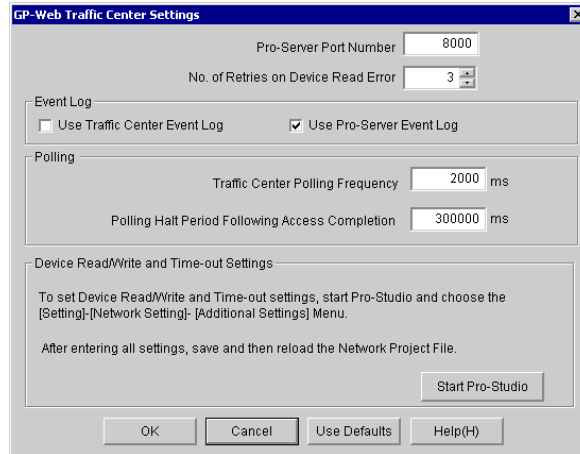

GP-Web Traffic Center Program Settings Window

The following describes each setup item in the [GP-Web Traffic Center Settings] dialog box.

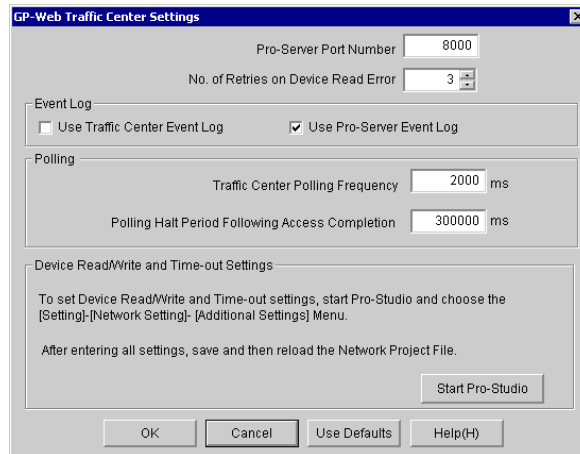

[Pro-Server Port Number]

Type the port number used to connect to the GP-Web Traffic Center program in the intermediate node. This needs to be the same as the port number used when communicating with the GP system via Pro-Server. Default value is “8000”. Do not change this port number unless it overlaps another application. If you change it, you also need to change port number settings of Pro-Server and of the GP.

[No. of Retries on Device Read Error]

Specify the number of times to retry when GP device read errors occur. Default is “3”.

[Use Traffic Center Event Log]

If this is checked, the log contents from the GP-Web Traffic Center program are output to TrafficCenter.log in the GP-Web Traffic Center Program folder. This file is based on the ring buffer format, where older information is replaced with the latest information. Check this when you wish to see the log contents on a PC that does not have Pro-Server. Default is unchecked.

[Use Pro-Server Event Log]

If this is checked, the log contents from the GP-Web Traffic Center program are displayed on the Pro-Server's log viewer. Default is checked.

[Traffic Center Polling Frequency]

Type the period between the point when the access from the upper level occurred and the point for the GP-Web Traffic Center program to access to Pro-Server. The unit is ms. Default is "2000 ms".

If you set this value smaller, the rapid polling and the real time display will be realized, however it will cause a large increase in network traffic. Try to set this value as large as possible.

[Polling Halt Period Following Access Completion]

Enter the time until the GP-Web Traffic Center program stops polling, after the upper-level PC access is completed. The unit is ms. Default is "300000 ms".

[Device Read/Write and Time-out Settings]

Set the value of the Pro-Server device read/write timer using Pro-Studio. When you click [Start Pro-Studio], Pro-Studio starts. "3000 ms" is default for Pro-Server.

Setting up the User Name and Password of the GP-Web Traffic Center Program

You can set the access level for users in the User Name and Password setting window of the GP-Web Traffic Center program.

Displaying the User Name and Password Setting Window of the GP-Web Traffic Center Program

1. Click the GP-Web Traffic Center program icon in the task bar.
The menu will appear.

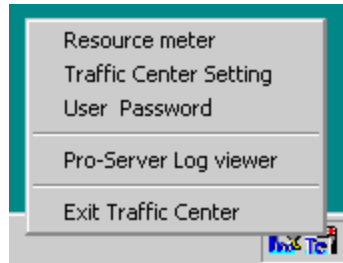

2. Select [User Password].
The [User Name and Password] dialog box will appear.

User Name and Password			
User Name	Password	Access Level	Comment
Anonymity User		GP Reset	

User Name	<input type="text"/>	<input type="button" value="Add"/>	<input type="button" value="Cancel"/>
Password	<input type="text"/>		
Access Level	GP Reset	<input type="button" value="Change"/>	<input type="button" value="Help(H)"/>
Comment	<input type="text"/>	<input type="button" value="Delete"/>	
		<input type="button" value="Save"/>	

Access Level Types

There are following four types as security access levels.

Nothing Nothing allowed.

Read Only Only device read is allowed.

Read/Write Device read and write are allowed.

GP Reset Device read and write, and the GP system reset command are allowed.

User Name and Password Setting Window of the GP-Web Traffic Center Program Settings

The following describes each setup item in the [User Name and Password] dialog box.

[UserName]

Type the username.

You can use alphanumeric characters. Alphabets are not case sensitive and all characters are treated in capital letters. Therefore, “digital” and “DIGITAL” are recognized as same usernames. You can type up to 31 characters.

[Password]

Type the user password to access.

You can only use alphanumeric characters. Alphabets are not case sensitive and all characters are treated in capital letters. You can type up to 24 characters.

[Access Level]

Select the user access level among [None], [Read Only], [Read/Write] and [GP Reset]. For the detail information about each selective item, see “Access Level Types”.

[Comment]

You can use alphanumeric characters. You can type up to 256 characters.

[Add] button

When you click this button, users set will be added in the list. If there are same usernames, the error will occur. Specify the different username.

[Change] button

When you click this button after changing the setup item of the selected user, the changed item will be applied to the list..

[Delete] button

When you click this button, the user selected in the list will be deleted.

[Save] button

When you click this button, the setup contents are saved and the [User Name and Password] dialog box is closed.

[Cancel] button

When you click this button, the [User Name and Password] dialog box is closed without saving the setup contents.

Anonymous Users

The first line in the list is reserved for the item to set the anonymous user. You can not set the username and the password. You can only set the access level. It is defaulted to "GP Reset".

The anonymous user indicates the case when the username is not specified.

2.5 Setting Up Security Settings

By using security settings, you can limit access to the GP system, which will present outsiders from seeing or operating GP screens.

Security is necessary for the following four cases.

- When you wish to allow only specific users to access to the Web pages uploaded via the Internet.
- When you wish to allow only specific users to use specific functions in communicating via the Internet.
- When you wish to prohibit specific functions physically in communicating via the Internet.
- When you wish to allow only specific users to use specific functions in communicating via the intranet, such as Easy Connection.

This section describes security setup procedures for these four cases.

Allowing only specific users access to Internet Web pages

This feature limits accesses to folders uploaded to the Web via IIS.

Setup Procedure

The drive where the folder to be uploaded on the Web is located must be formatted in NTFS. It is assumed the folder where you wish to set up security is shared on the Web.

1. Select [Set]-[Control Panel] from the [Start] menu.

The [Control Panel] window will appear.

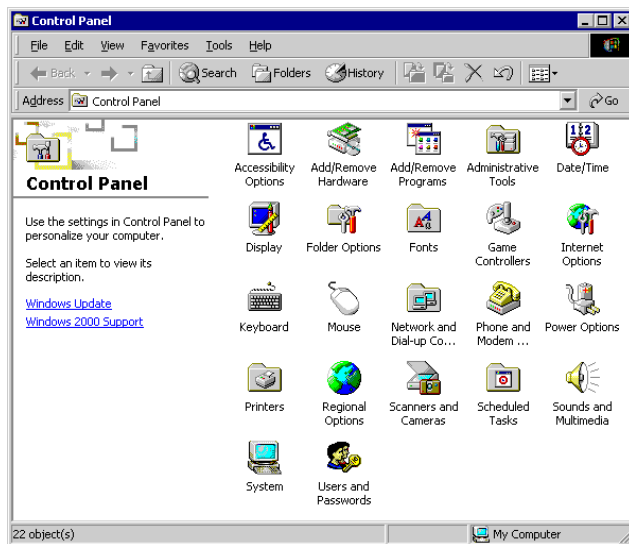

2. Double click [Administrative Tools].

The [Administrative Tools] window will appear.

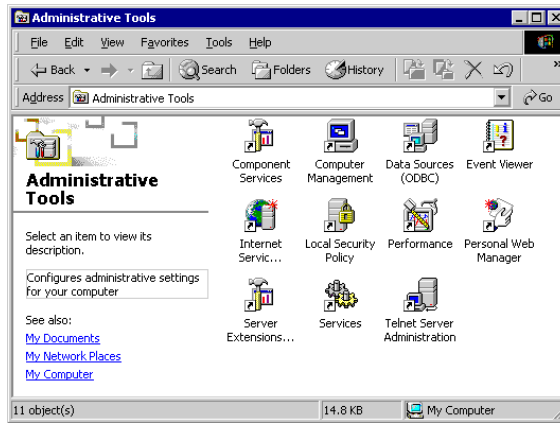

3. Double click [Internet Service Manager].

The Internet service manager will start and the [Internet Information Services] window will appear.

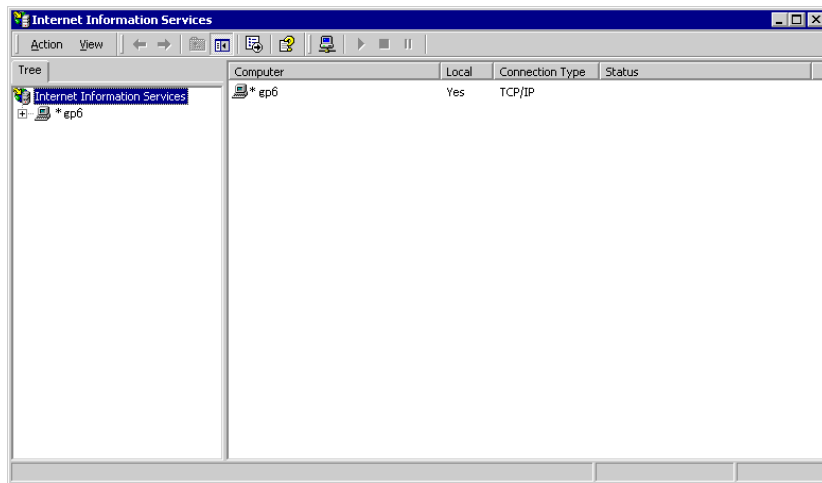

- In the left pane, double click the computer name to show file details.
The [Default Web Site] icon will appear.

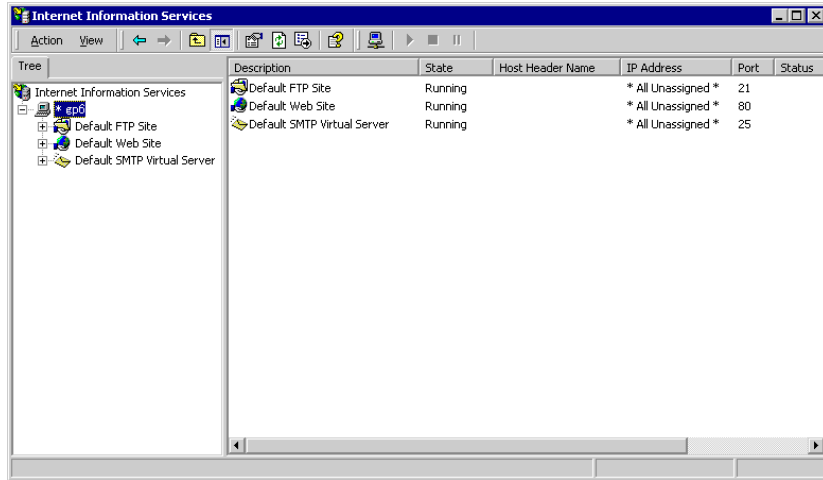

- Double click on the [Default Web Site] icon.
The folder list will be showed also including the Web shared folder.

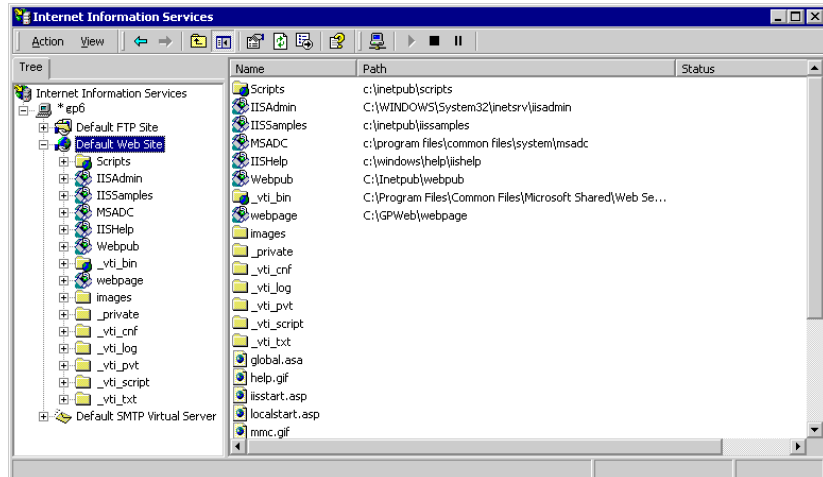

- Use the right-side mouse button to click the folder that you wish to set up the security.
The following menu will appear.

7. Select [Property].

The [webpage Properties] dialog box will appear.

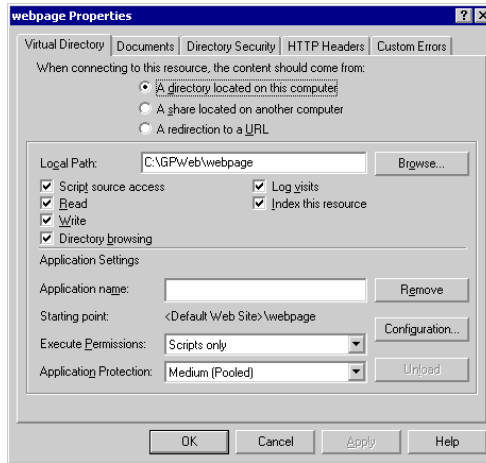

8. Click the [Directory Security] tab.

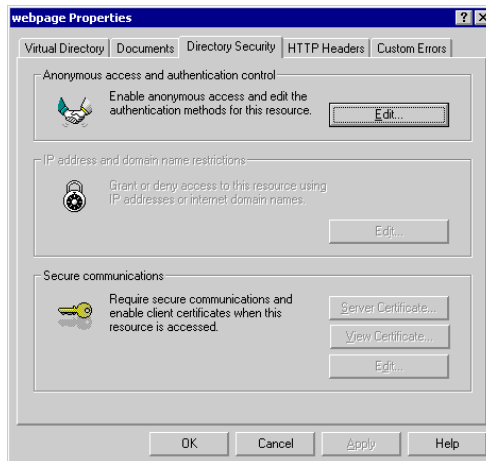

9. Click the [Anonymous Access and Authentication Control]-[Edit...].

The [Authentication Methods] dialog box will appear.

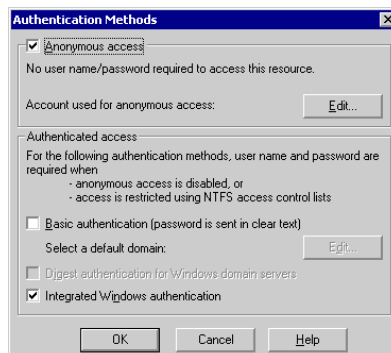

10. Click on [Anonymous access] to uncheck that feature.
11. Click the [OK] button.
(The [webpage Properties] dialog box will appear.)
12. Click the [OK] button.

When you uncheck [Anonymous access], the [Authenticated access] setting is enabled and access is controlled via the Windows password screen.

For example, when you open a folder that has security set on the Web browser, the following dialog box will appear. Enter your user name and the password.

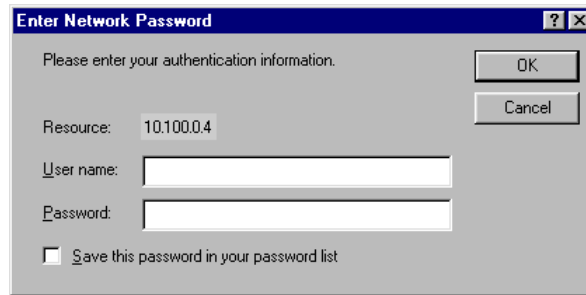

The following dialog box may appear depending on the environment used. In this case, enter the domain name.

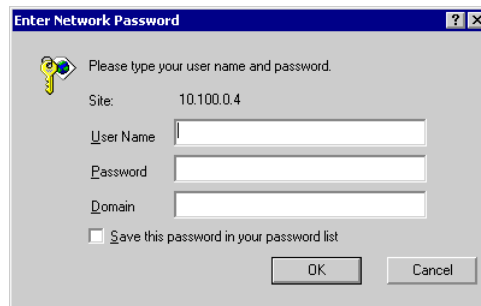

For the detail information about the security setup to the Web shared folder, see the OS manual.

Allowing only specific users to use specific functions in communicating via the Internet

This feature defines users who access to the folder where the GP-Web CGI program has been installed. The folder where the GP-Web CGI program has been installed is located in the GPWEB folder in the GP-Web Traffic Center program. Folders have been separated according to the access of the GP device. There are 3 folder types.

ReadCGI Contains the CGI program for the GP device read.

WriteCGI Contains the CGI program for the GP device write.

ResetCGI Contains the CGI program for the GP reset.

Accesses can be limited by defining the user for each folder depending on the desired access usage. For example, in case of the user that you wish to allow "Read Only", define that user in the ReadCGI folder, and in case of the user that you wish to allow all privileges, define that user in all folders.

Security Setup Procedure

The drive containing the folder to be uploaded to the Web should be formatted in NTFS.

1. Use Explorer to open the GPWEB folder located in the GP-Web Traffic Center program.
The ReadCGI, WriteCGI and ResetCGI folders will appear.
2. Click the folder that you will define with the right mouse button.
The menu will appear.
3. Select [Property].
The property dialog box of the selected folder will appear.

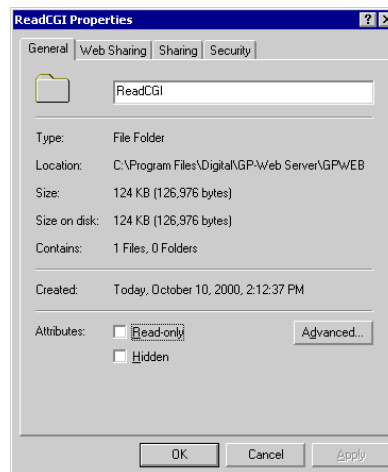

- Click the [Security] tab.

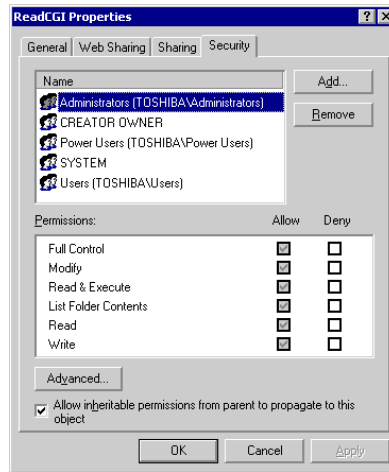

- Define the users that are allowed this type of access.
For the detail information about defining users, see the OS manual.

Prohibiting specific Internet communication functions

Delete the folder where the GP-Web CGI program has been installed. The folder where the GP-Web CGI program has been installed is located in the GPWEB folder in the GP-Web Traffic Center program. Folders have been separated depending on the access usage of the GP device. The following 3 folder types can be used.

ReadCGI Contains the CGI program for the GP device read.

WriteCGI Contains the CGI program for the GP device write.

ResetCGI Contains the CGI program for the GP reset.

Accesses can be limited physically by deleting the corresponding folder, depending on the security settings. For example, if “Write” actions are prohibited, delete the WriteCGI folder.

Setup Procedure

It is assumed that the drive containing the Web data folder has been formatted in NTFS.

- Use Explorer to open the GPWEB folder located in the GP-Web Traffic Center program.
ReadCGI, WriteCGI and ResetCGI will appear.
- Delete the target folder.

Allowing only specific users to use specific functions in communicating via the intranet such as Easy Connection

This security is set using the GP-Web Traffic Center program.

Setup Procedure

1. Click the PC task bar's GP-Web Traffic Center program icon, which is connected to the GP system that you wish to limit access. Also Pro-Server has been installed on this PC.

The following menu will appear.

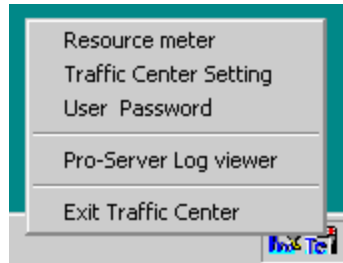

2. Select [User Password].

The [User Name and Password] dialog box will appear.

User Name and Password			
User Name	Password	Access Level	Comment
Anonymity User		GP Reset	

User Name	<input type="text"/>	<input type="button" value="Add"/>	<input type="button" value="Cancel"/>
Password	<input type="text"/>		
Access Level	<input type="text" value="GP Reset"/>	<input type="button" value="Change"/>	<input type="button" value="Help(H)"/>
Comment	<input type="text"/>	<input type="button" value="Delete"/>	
		<input type="button" value="Save"/>	

3. Set User access levels.

For the detail information about this setup method, see “Setting up the User Name and Password of the GP-Web Traffic Center Program” (page 2-27).

When you access a GP where the user name and password have been previously set or when you try to view log data, the following dialog box will appear. Enter the username and password.



Once you enter the username and the password, they will be valid until you exit the browser. When you start the browser again, the Save dialog box will appear.

Multiple Hierarchical Routing Security

The following example describes the multiple hierarchical routing security.

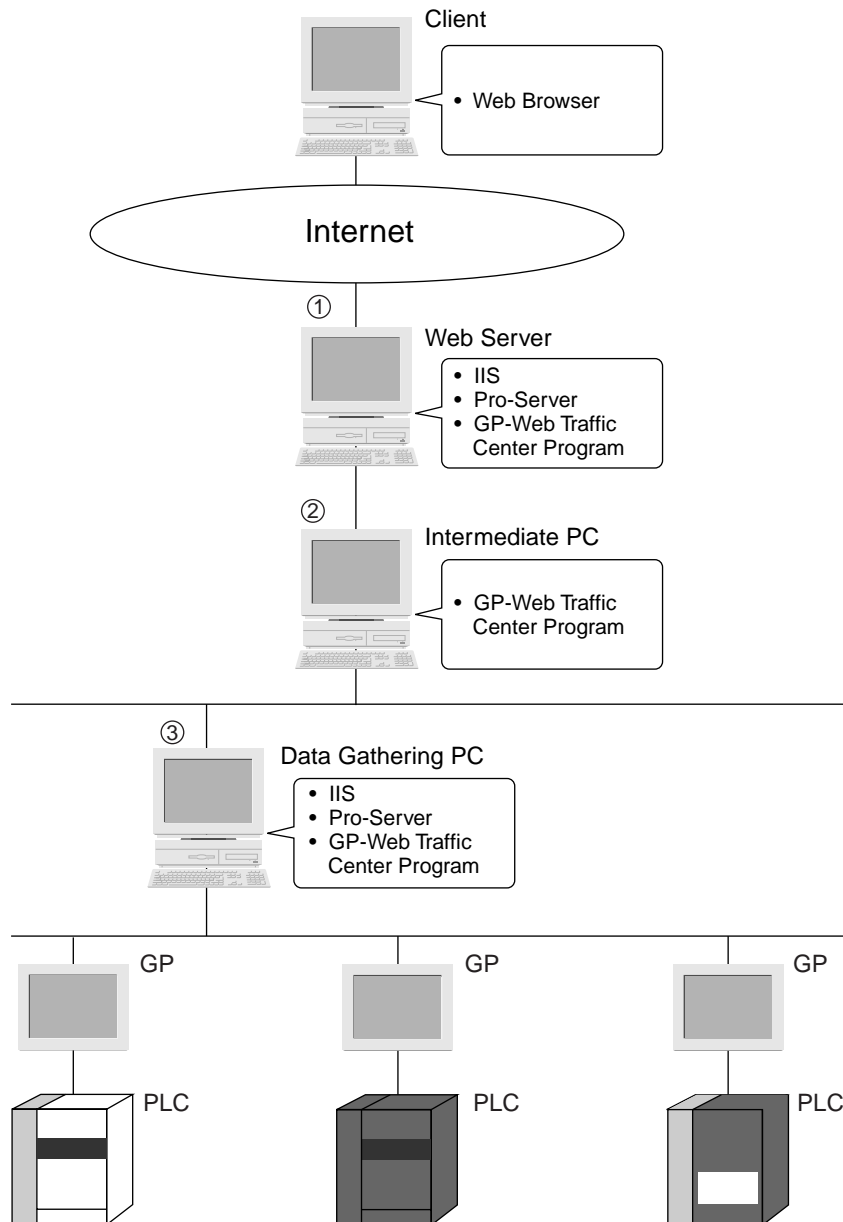

The IIS security can be set to PC①.

When you wish to use the security by the GP-Web Traffic Center program, you need to set user names, passwords and access levels for all PCs in the routing (①, ②, ③). However, on PC① and PC②, only user names are checked and access levels are not checked. The access level will be checked on PC③ which communicates with the GP system.

Firewall

The following examples describe precautions in introducing the firewall for providing additional security intensification.

When you set up the firewall, the following two cases can be considered; between the Internet and the Web server, or between the Web server and the intermediate PC.

Setting the Firewall between the Internet and the Web Server

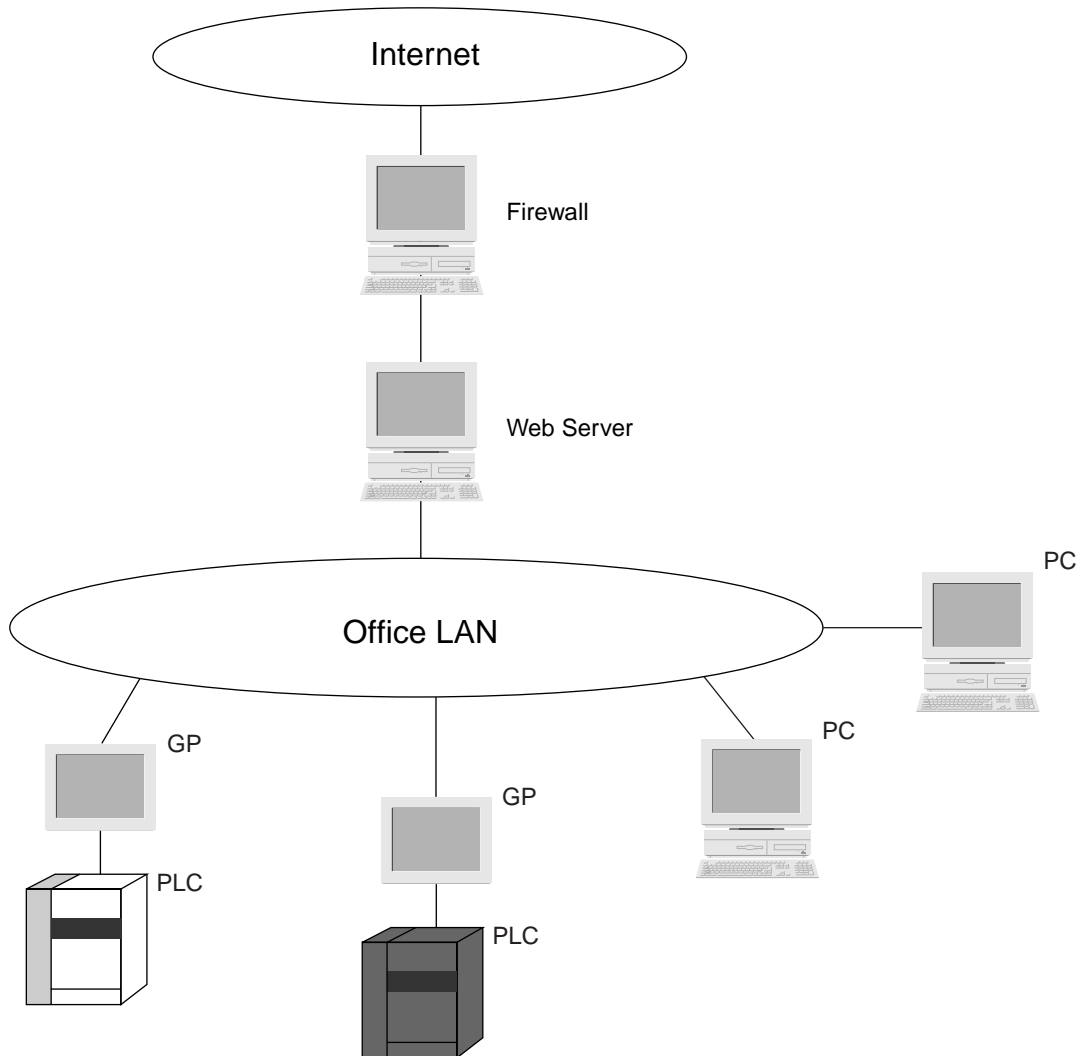

The Web server communicates with GP-Web Java applets based on the http protocol. Set the firewall for the TCP/port number 80 access.

Setting the Firewall between the Web Server and the Intermediate PC

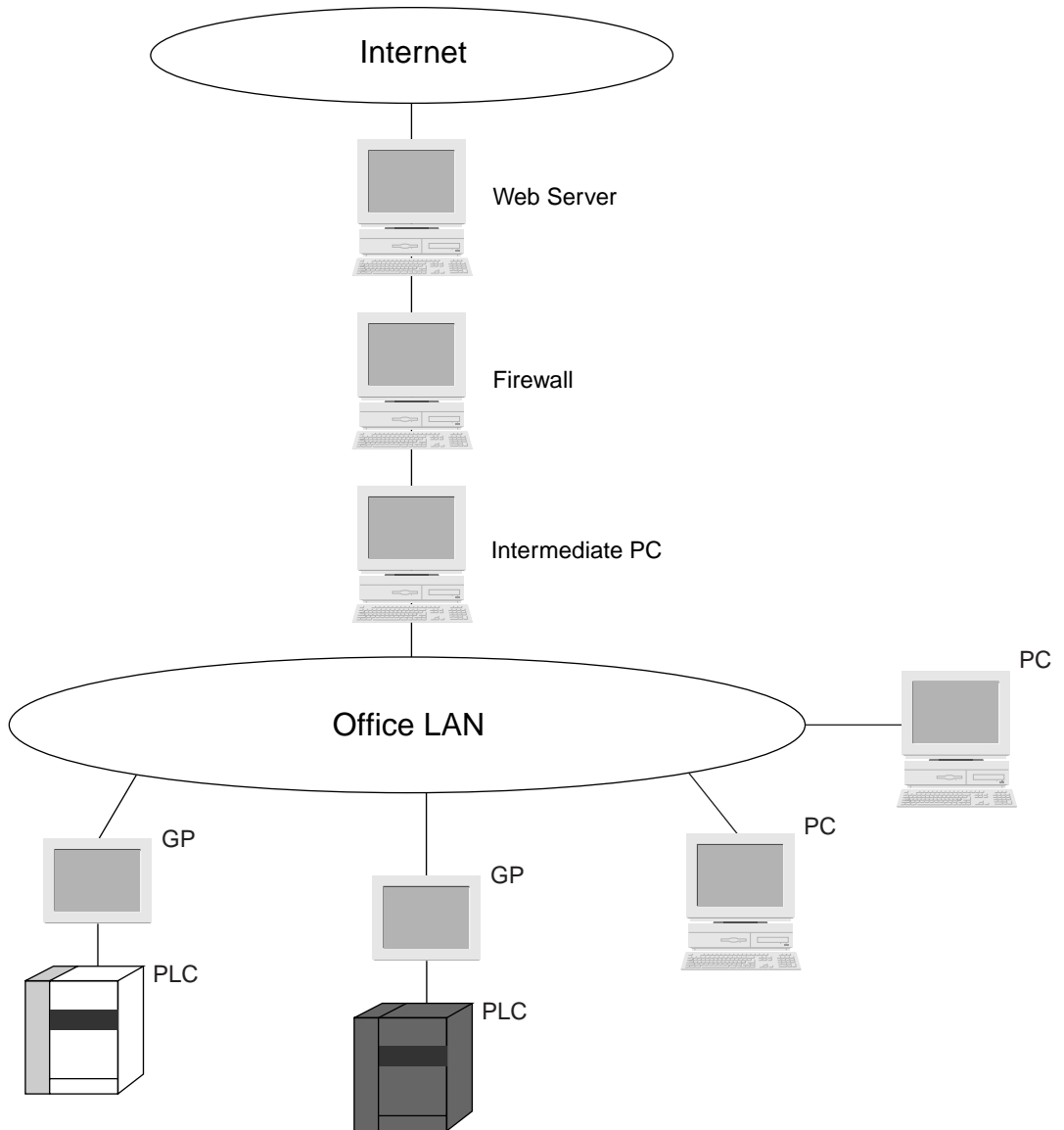

Communications will be done based on their own protocols between GP-Web Traffic Center programs, and between Pro-Server and GPs.

Those protocols are TCP and UDP protocols using [GP-Web Traffic Center Settings] – [Pro-Server Port Number] for GP-Web Traffic Center programs and using 10 continuous port numbers for Pro-Server and GPs.

The initial setting of the port number is “8000”. If you use this initial setting, you need to set TCP and UDP protocols to be able to communicate with port numbers 8000 through 8009.

For the firewall setting locations or setting methods, refer to the manual about the firewall.

Referencing the Web Share Folder

When setting the [GP-Web Compiler - Project File and Output Folders] window's [Name of Output (HTML) file] selection to a name other than "default.htm", the data in the Share folder is referenced by the Web Browser.

If the [Name of Output (HTML) file] has been changed, be sure to also change the Web Share folder settings. Click on the Web Share folder's [Property] selection to call up the following screen. Next, click on the [Documents] tab and select the [Enable Default Document] feature. Add the desired filename to the list shown, to prevent that folder from being accessed.

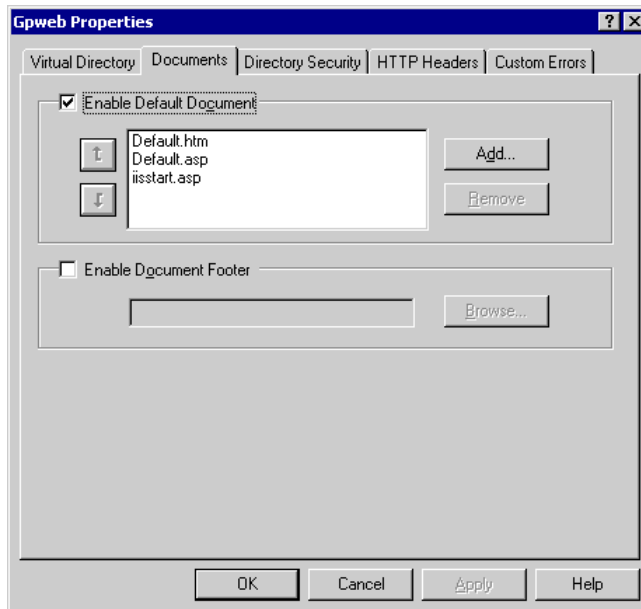

2.6 Referring to Logs

When you enable [Pro-Server Event Log] with the GP-Web Traffic Center program setup, you can view communication records of the GP-Web Traffic Center program using the Pro-Server's log viewer.

Starting the Log Viewer

You can start the Pro-Server's log viewer from the GP-Web Traffic Center program.

1. Click the GP-Web Traffic Center program icon in the task bar.

The menu will appear.

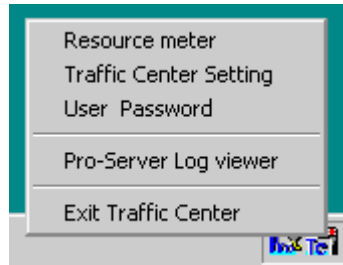

2. Select [Pro-Server Log Viewer].

The [2Way Event Log Viewer] window will appear.

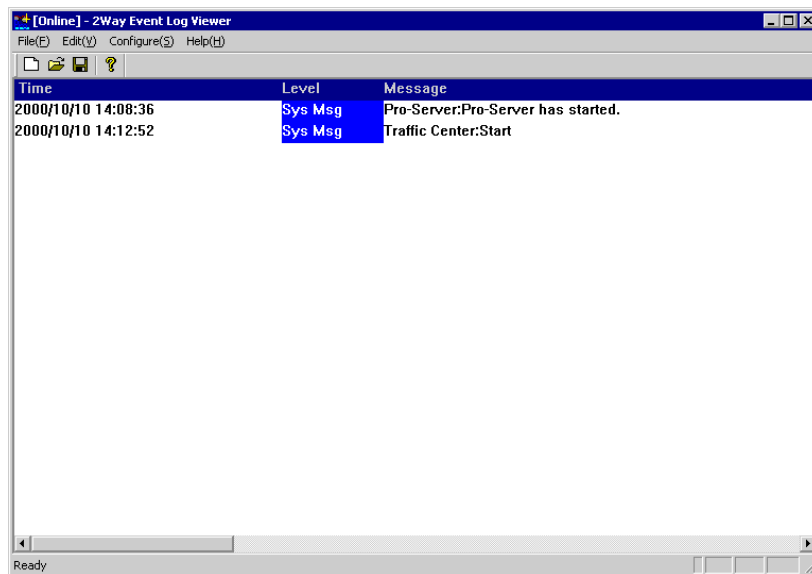

GP-Web Information Recorded in the Log Viewer

The following GP-Web information is recorded in the log viewer:

- Starting and exiting the GP-Web Traffic Center program
- Communication errors

2.7 Various Language Supports

You can view the GP-PRO/PBIII project file created on the European, Chinese, Taiwanese or Korean OS on the Web browser of the client computer with the supported OS loaded simply by performing the normal compilation using the GP-Web Compiler.

Supported Client's OS

	European	Chinese	Taiwanese	Korean
Windows 95	OK	OK	OK	OK
Windows 98	OK	OK	OK	OK
Windows NT4.0	OK	OK	OK	OK
Windows 2000	OK	OK	OK	OK

The following table lists character sets used by GP-Web for the text display and those supported by GP-PRO/PBIII.

Supported Character Sets

	Character sets used by GP-Web for the text display	Character sets supported by GP-PRO/PBIII
ASCII	ISO-8859-1	Code Page 850(Multilingual)
Chinese	GB2312	GB2312-80
Taiwanese	BIG5	BIG5
Korean	EUC-KR	KSC5601-1992 (except for 2-byte characters)

Non-Standard Character Registration

If you use GP-PRO/PBIII with a European language OS, you can register non-standard characters.

Characters can be designed using M8001 through M8128 in the mark sheet which are handled as character codes from 0x80 through 0xFF.

Those non-standard characters can also be displayed on the Web browser by GP-Web.

3 | Web Browser

- 3.1 Web Browser
- 3.2 GP Alarm Display
- 3.3 GP Screen JPEG Display Feature
- 3.4 Web Device View

3.1 Web Browser

When GP screens converted by the GP-Web Compiler are displayed on the Web browser, GP-Web Java applets are performed. Drawing and tag functions of GP screens are executed on the Web browser by Java applets. GP-Web Java applets are downloaded automatically from the server and executed when GP screens are displayed.

The Web browser which can display GP screens on the client PC is only Microsoft Internet Explorer 5.0 or later. However, if you have configured the system by the communication method without using IIS (Easy Connection), you need to have installed GP-Web Traffic Center Program and GP-Web Java applets in advance. For Easy Connection, see "Chapter 4 Easy Connection".

If you install Microsoft Internet Explorer 5.0 on the client PC, include "Java VM". If "Java VM" is not installed on the client PC, the system does not work properly.

To check if "Java VM" is included in existing Microsoft Internet Explorer 5.0, select [Internet Options] from the [Tools] menu of Internet Explorer 5.0. If "Java VM" or "Microsoft VM" is listed on the [Advanced] tab, "Java VM" is installed.

MEMO

- Whenever the Traffic Center Program is installed, GP-Web Java applets are also installed.
- Depending on the amount of memory in the Client PC's video card, GP-Web Java applets may not be able to be displayed. (Insufficient memory error)
To correct this problem, try adjusting the Client PC display's settings, i.e. reducing the number of display colors, etc.
- If a problem occurs with the GP-Web data server's LAN network (such as a line problem, etc.) the screen on your Internet browser may stop being refreshed automatically. If you feel this may have occurred, use your Web browser's [Refresh] feature to read new data into the screen data display.

3.2 GP Alarm Display

If you designate that GP alarms will be displayed, via the GP-Web Compiler, you can view the internal GP alarm on the Web browser of the client PC. This function is called as GP Alarm Display feature.

When you use the GP alarm display function, you need to give the folder uploaded to the Web the shared Web “Write” access and the NTFS “Write” access.

Shared Web “Write” Access

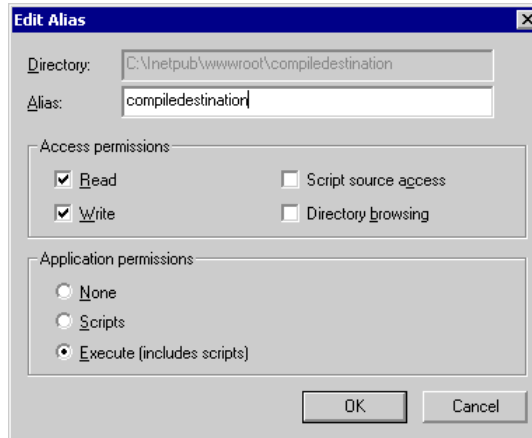

NTFS “Write” Access

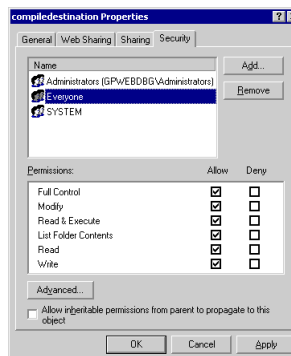

Both screens are for Windows 2000.

MEMO

This description concerns communication with IIS or the Web server. For communication method without using IIS or the Web server (Easy Connection), GP alarm will be displayed by the proprietary application software. For details, see “4.4 GP Alarm Display Application” (page 4-9).

GP Alarm Display Diagram

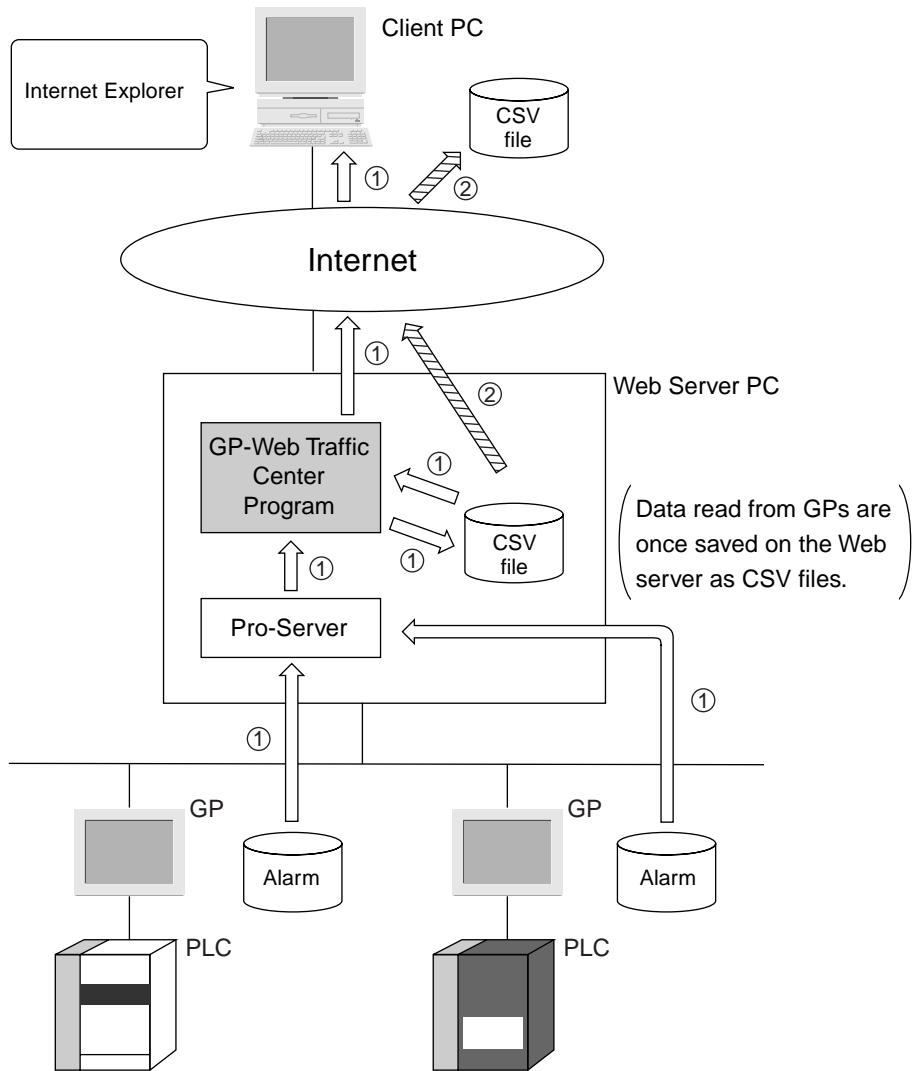

① indicates steps performed when "Upload of the latest Data" is selected in the GP alarm display function.

② indicates step performed when "Download" is selected.

When you use the GP alarm display function, sub folders with the following structure will be created in the GP-Web screen folder.

If you specify [Upload of the latest data], data read from GPs is saved as CSV files in sub folders.

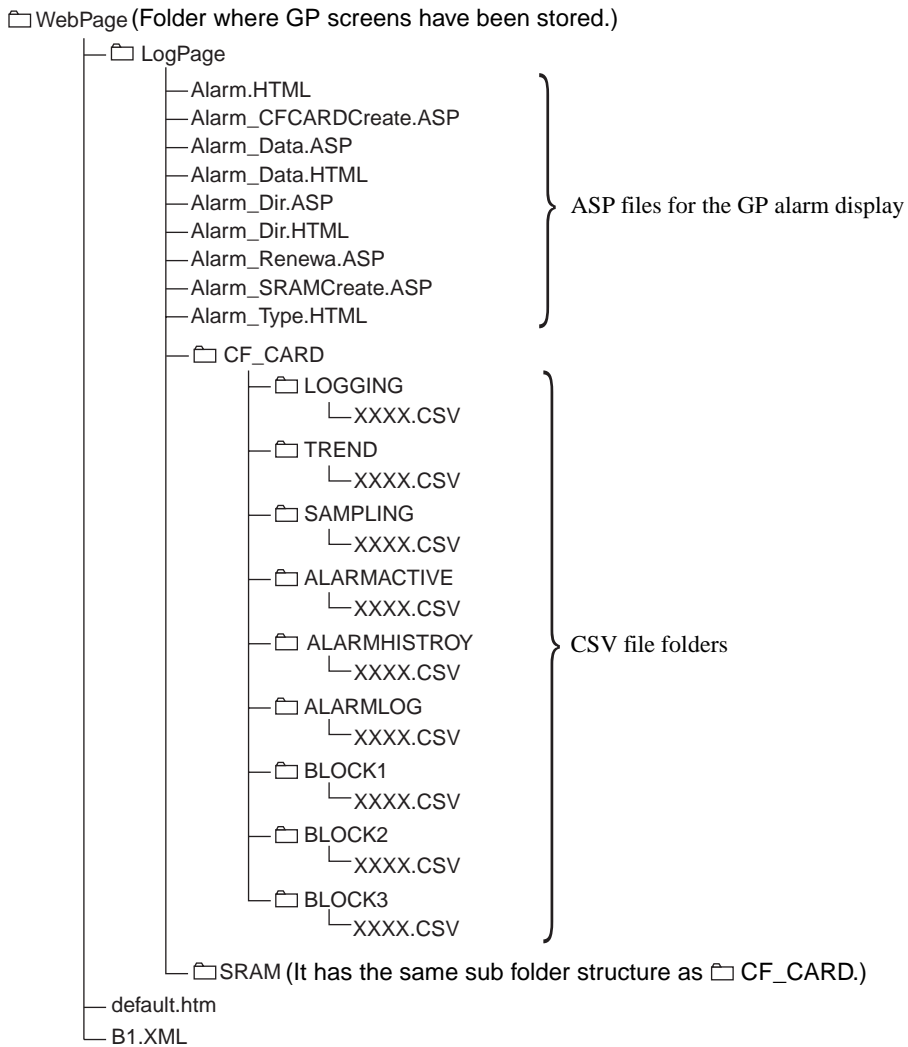

CSV file contents are displayed on the client PC Web browser via the Web server ASP.

About ASP Files for the GP Alarm Display

The GP-Web system uses the ASP function provided by IIS to display the GP alarm data.

Among window contents displayed using the ASP file, the following three items can be modified by editing related HTML files.

- Title of the GP Alarm Display window. (Defaults to AlarmLogMonitor.)
- Background color of the GP Alarm Display window. (Default is white.)
- Deletion of forms that show the GP alarm data type. (Default displays all CF Card and SRAM data.)

These contents are contained in following files.

- Alarm_Data.ASP (Only colors can be edited.)
- Alarm_Dir.ASP (Only colors can be edited.)
- Alarm_Type.html (Titles and GP alarm types can be edited.)

MEMO

Modify only the items mentioned here. Modifying other items may effect the GP Alarm Display.

Displaying GP Alarm Data on the Web Browser

This section describes how to display GP alarm data on the Web browser. The display method differs for past and for current data.

Displaying Past Data

1. If you enable the creation of the GP alarm data pages with the GP-Web Compiler, the [Alarm] button will appear in the GP screen displayed on the Web browser. Click the [Alarm] button.

Alarm

The GP Alarm Display window will appear.

The screenshot shows a Microsoft Internet Explorer browser window displaying the 'GP Alarm Display' page. The address bar shows the URL: `http://gpwebdbg/compiledestination/LogPage/Alarm.html`. The page content includes:

- GP Alarm Display** (Section Header)
- SRAM** (Section Header) with navigation links: [Loading](#), [Trend](#), [Sampling](#), [Alarm.Active](#), [Alarm.History](#), [Alarm.Loading](#), [Block1](#), [Block2](#), [Block3](#)
- CF CARD** (Section Header) with navigation links: [Loading](#), [Trend](#), [Sampling](#), [Alarm.Active](#), [Alarm.History](#), [Alarm.Loading](#), [Block1](#), [Block2](#), [Block3](#)
- CF CARD Alarm Active** (Section Header) with a **UpLoad of the latest data** section containing a **Change** button and a list of CSV files: [ZA00000.CSV](#), [ZA00001.CSV](#), [ZA00002.CSV](#), [ZA00003.CSV](#), and [ZA00004.CSV](#).
- CF CARD Alarm Active CF-CARD/ALARMACTIVE/ZA00000.CSV** (Section Header) with a **Download** button and a table of alarm messages.

Date	Time	Message	Ack Time	Recover Time
00/10/10	21:38:45	GP-Web Test Alarm Message1		
00/10/10	21:38:44	GP-Web Test Alarm Message2		
00/10/10	21:38:44	GP-Web Test Alarm Message3		

2. In the top of GP Alarm Display window, click the name of the data type that you wish to see. If you wish to see SRAM or CF Card data, click the data type name in [SRAM] or [CF CARD].
The list of CSV files will be shown in the lower left part of the window.
3. Click the CSV file that you wish to see.
The contents of the CSV file selected will be shown in the lower right part.
4. If you would like to download the data displayed and store in the client PC, click the [Download] button.
The CSV file will then be stored in the client PC.
If the Excel program is not installed on the client PC, click the right mouse button and select the [Save Target As] from the menu displayed.

Displaying Current Data

1. Follow steps 1 and 2 of “Displaying Past Data”.
2. Click [Upload of the latest data] located in the lower left part of the GP Alarm Display window.
The current GP log data will be stored in CSV file format on the server PC. The CSV filename is equal to the filename specified by the GP-Web Compiler.
The contents of this CSV file will be shown in the lower right pane.
3. If you would like to download the data displayed and store it in the client PC, click the [Download] button.
The CSV file will be stored in the client PC.

MEMO

- If you click [Upload of the latest data], the current alarm will appear in the lower right pane but the CSV filename that log data have been stored will not appear in the lower left list. If you wish to display the CSV filename, click [Update] in the lower left pane.
- If you did not enable [Include 'Data Load' Button] with the GP-Web Compiler, [Upload of the latest data] will not appear. In such a case, convert the GP internal log data to the CSV file by using the Pro-Server's “Action” feature. Copy the converted CSV file to the folder in the LogPage folder in GP-Web. Copy the CF CARD contents to the CF CARD sub folder, and the SRAM contents to the SRAM sub folder. For the folder structure, see the description of folder structure in the clause “GP Alarm Display Diagram” (page 2-43).
- The GP alarm display function does not automatically convert GP internal alarms to CSV files.

3.3 GP Screen JPEG Display Feature

If you designate to display JPEG data of GP screens on the GP-Web Compiler, you can display captured data from GP screens or JPEG data sampled from a VM unit within a CF Card on a client's PC's Web browser. This feature is called as "GP Screen JPEG Display Script".

When you use the GP Screen JPEG Display Script, you must enable write permission for the shared Web and for NTFS access privilege. (For details, see "3.3 GP Alarm Display Feature".)

MEMO

- The capturing process of GP screens can be executed only when the bit 0 of LS2076 of the GP system is equal to "1". If it is equal to "0", an error occurs.
- This feature has been supported only by the GP2000 Series.

Mechanism of GP Screen JPEG Display

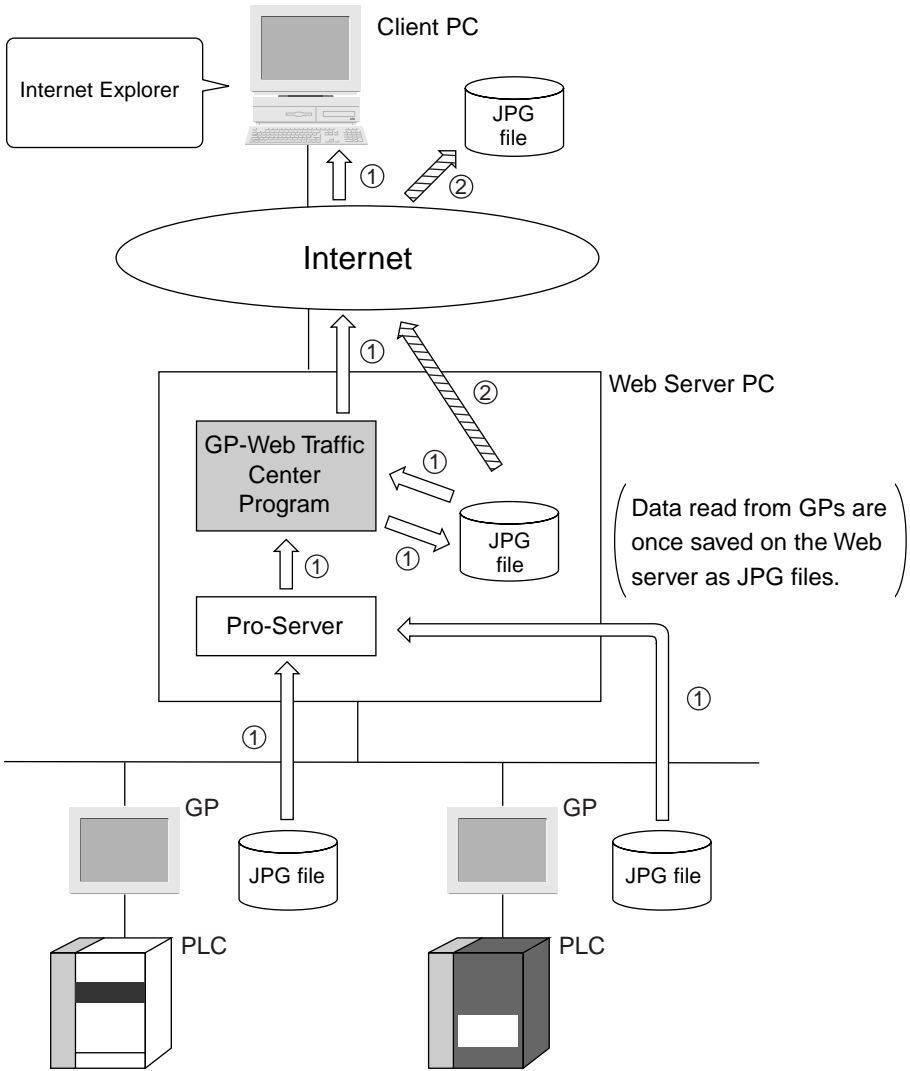

The process ① shows the data flow when you selected [Capture and Upload of GP Screen]/[Upload of the latest data] in the GP Screen JPEG Display Script.

The process ② shows the data flow when you selected [Download] in the GP Screen JPEG Display Script.

If you use the GP Screen JPEG Display Script, the following subfolders are created.
If you select [Upload of the latest data] and [Capture and Upload of GP Screen], JPEG data is read and saved in the created subfolder.

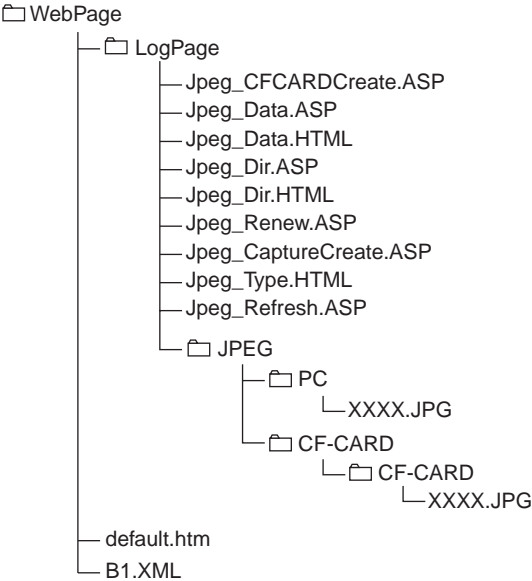

JPEG files mentioned above are displayed on the client PC's Web browser via the Web server's ASP.

The following window appears at the location that you inserted the declaration statement.

JpegDisp

Click [JpegDisp] to open the new browser window. This window consists of buttons to specify JPEG data to display, the JPEG display area and others.

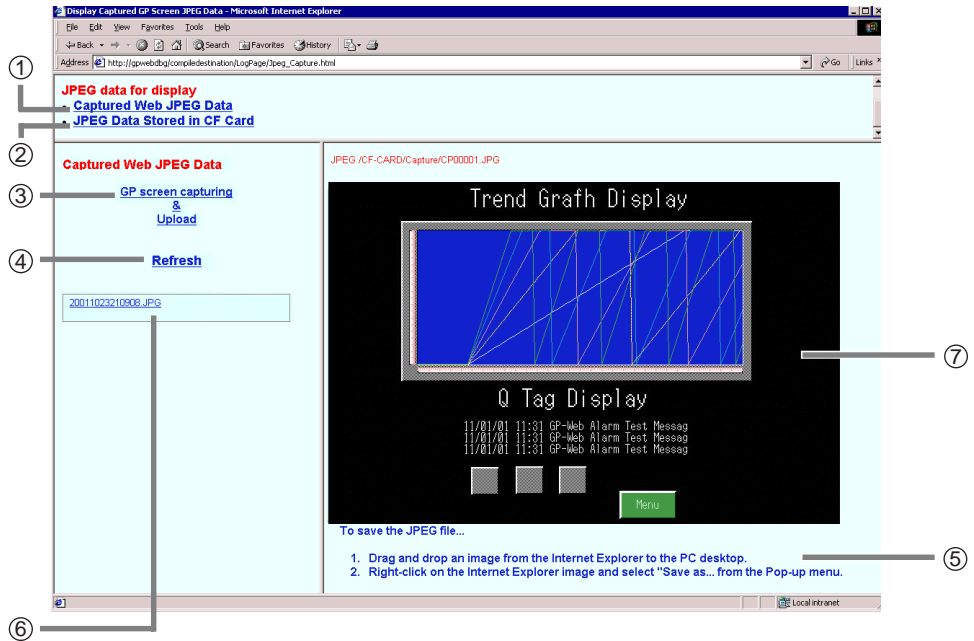

① The [Captured Web JPEG Data] button (①) appears when you have specified [Enable screen capture from Web] on [GP Screen JPEG Display Settings]. If you click this button, JPEG data captured from the Web is displayed in the area ⑦.

The [GP screen capturing & upload] button (②) appears when you have specified [Enable screen capture from Web]. This button is used for uploading GP screen capture data on the server PC.

MEMO

If you use the [GP screen capturing & upload] button (②) frequently, a large load is put on the GP system and it may cause an undesirable influence to the site. You should use the button keeping an appropriate interval.

The [Update] button (③) is to update the capture data list (⑥) saved in the past. If you wish to display capture data saved, click the capture data name (⑥) to display it in the area (⑦).

Texts (⑤) describe how to download JPEG screens displayed to the client PC.

The [JPEG Data Started in CF Card] button (④) is to display JPEG files saved in the CF Card attached to the GP system. If you click this button, the following window appears.

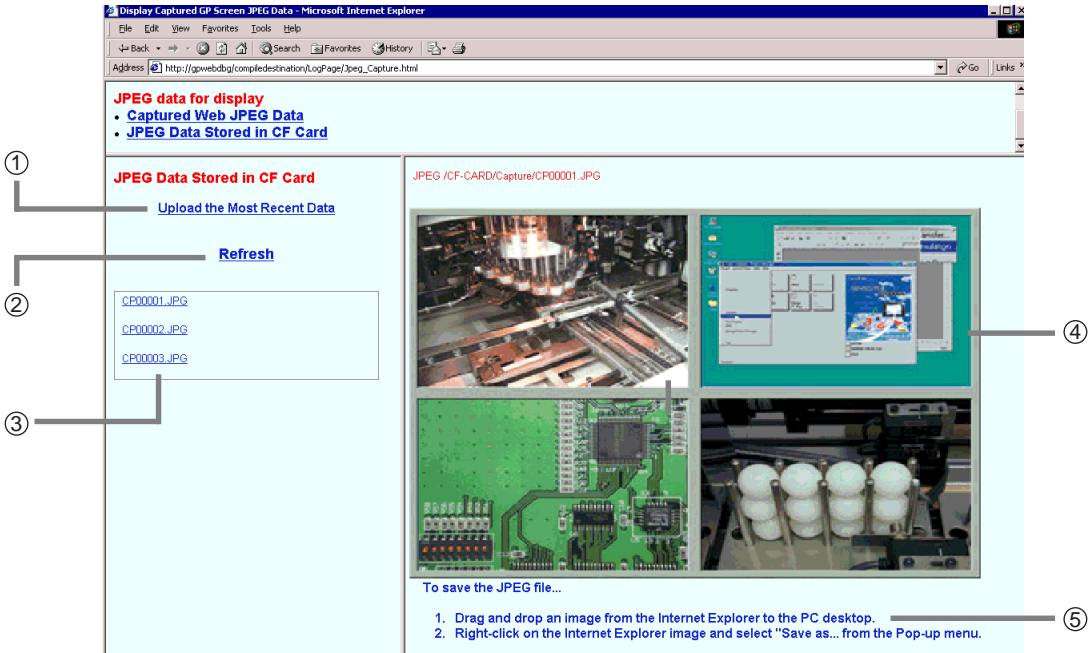

The [Upload of the latest data] button (①) appears if you have specified [Enable JPEG data upload from CF Card] on [GP Screen JPEG Display Settings]. If you click this button, JPEG files saved in the CF Card attached to the GP system are uploaded on the server PC.

The [Update] button (②) is to update the capture data list (③) saved in the past. If you wish to display capture data saved, click the capture data name (③) to display it in the area (④).

Texts (⑤) describe how to download JPEG screens displayed to the client PC.

Displaying JPEG Data on the Web Browser

This section describes how to display JPEG data of GP screens on the Web browser.

If you specify the GP Screen JPEG Display feature on the GP-Web Compiler, the button to be used to display JPEG data is created in the default.htm file.

3.4 Web Device View

Web Device View is the feature to upload a device view setup file (*.#dv) created in Pro-Studio to the Web. You can display multiple GP screens on the Web browser at one time using Web Device View. You must create the setup file for Device View in Pro-Studio, execute a conversion specifying the setup on the Web Device View Compiler program and create an ASP file to use the Web Device View.

MEMO

- Pro-Server with Pro-Studio for Windows Ver.4.0 or later is required to use Web Device View.
- The Web Device View feature cannot use the Easy Connection access method.

Web Device View Design

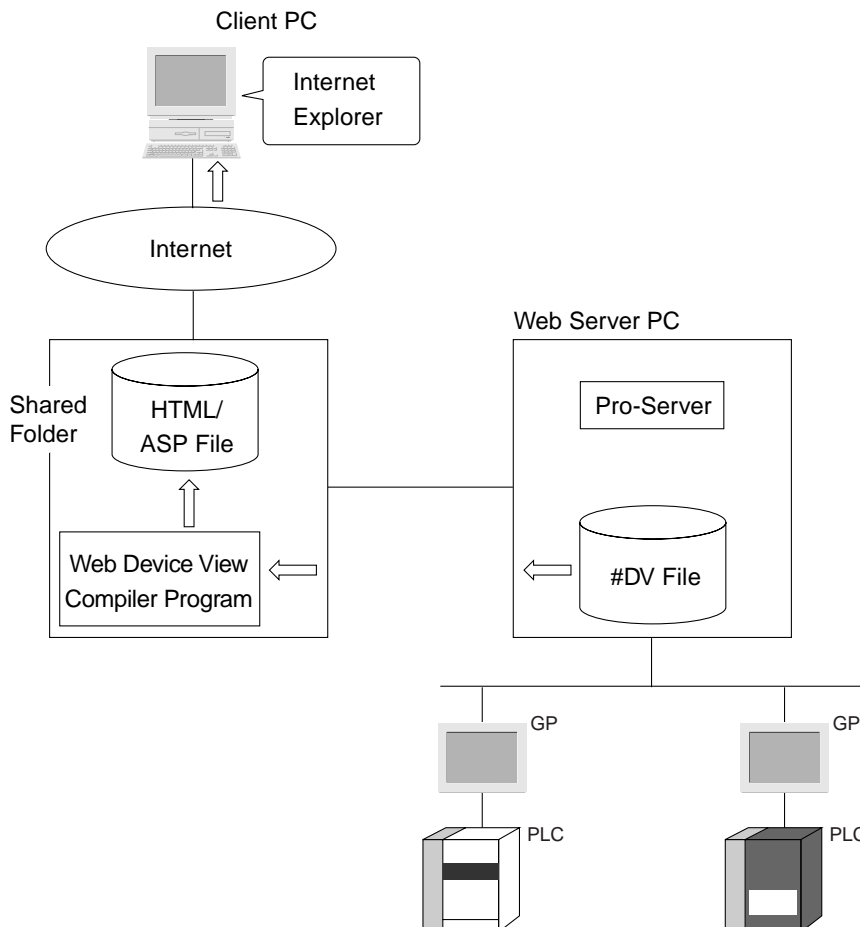

MEMO

The path to the ".#DV" file must be identical in order to use the Device View Setup File (.#DV file) created on Pro-Studio in other environments (PCs).

Compiling Web Device View

1. Create the Device View setup file in Pro-Studio.
See “Pro-Server with Pro-Studio for Windows Operation Manual”
2. Click the [Start] button.
3. Select [Program]-[Pro-face]-[GP-Web]-[Web Dev Compiler].
When the Web Device View Compiler program is started, the [Web Device View Compiler] window appears.

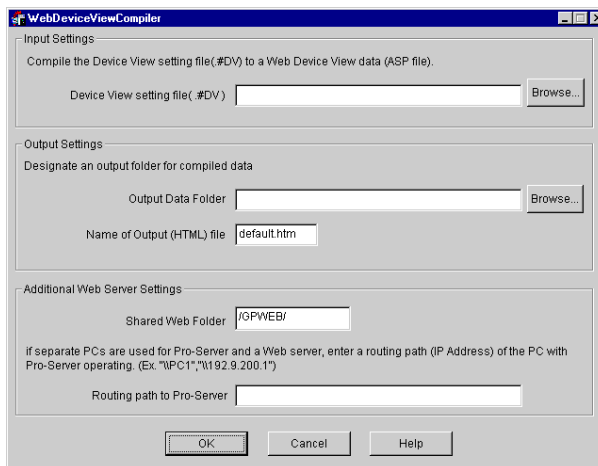

The setting file created on Pro-Studio for Device View has been designated in [Device View setting file (.#DV)] of [Input Settings].

4. Enter the folder to output converted HTML and ASP files in [Output Data Folder] of [Output Settings]. You can either type in the full path to the folder in the text box or select the folder by clicking the [Browse] button.
5. Enter the HTML filename that you wish to convert in [Name of Output (HTML) file] of [Output Settings]. Default filename is “default.htm”.
6. Specify [Shared Web Folder Name], [Time-out Period] and [Routing Path to Pro-Server]. See step 32 through 34 in “Using the GP-Web Compiler” of “2.1 What is Compiling Data?”.
7. Click the [Finish] button.
The compile will start.
When the compile has been completed successfully, the following message appears.



8. Click the [OK] button.

PC Screen Display on Internet Explorer

1. Enter the URL of the HTML file converted on a client PC.

The main menu of the Web Device View appears.

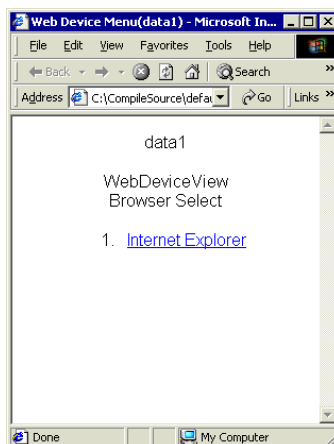

2. Click [1. Internet Explorer].

The following Web Device View appears.

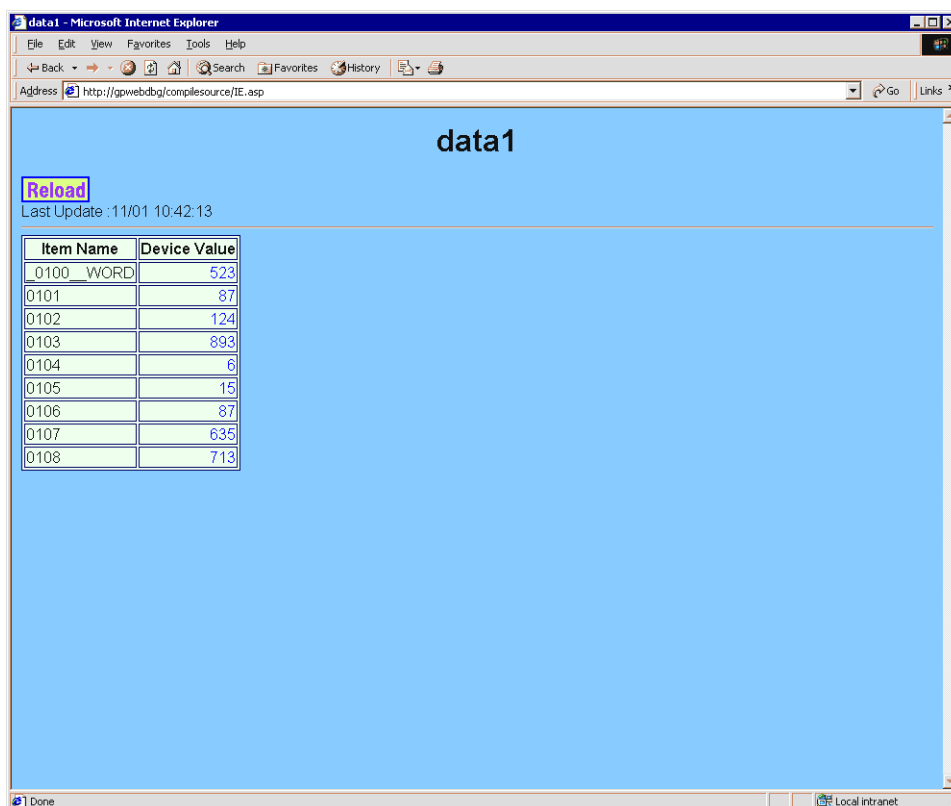

The screen display is not automatically updated in case of Web Device View displaying format on IE (Internet Explorer). Click the [Reload] button to view the latest data. Also, write processing is not allowed. This process is “Read Only”. The number of devices to be displayed depends on the Pro-Server’s Device View feature.

Security in Web Device View

[Displaying format on IE (Internet Explorer)]

Only the security via IIS is effective. The security of GP-Web Traffic Center can not be used.

4 | Easy Connection

- 4.1 What is Easy Connection?
- 4.2 System Design and Setup Procedure
- 4.3 Installing Easy Connection
- 4.4 GP-Web Compiler Routing Setup
- 4.5 GP Alarm Display Application
- 4.6 GP Screen JPEG Display Application

4.1 What is Easy Connection?

In a standard GP-Web system, GP screens converted by the GP-Web Compiler are uploaded to the Web by IIS and the GP-Web Traffic Center program, and then displayed on the client's Web browser.

An alternative communication method is to not use IIS.

With this method, you connect to the server connected to the GP system from the client PC via an intranet. Pro-Server and the GP-Web Traffic Center program need to have been installed on the server. In the client, GP-Web Java applets which are installed with the GP-Web Traffic Center program are required. With this communication method, you can use GP-Web in the environment where IIS is not available. This setup will increase the communication speed will be increased since data does not go through the IIS.

4.2 System Design and Setup Procedure

This section describes the system design and the Easy Connection setup procedure.

System Design

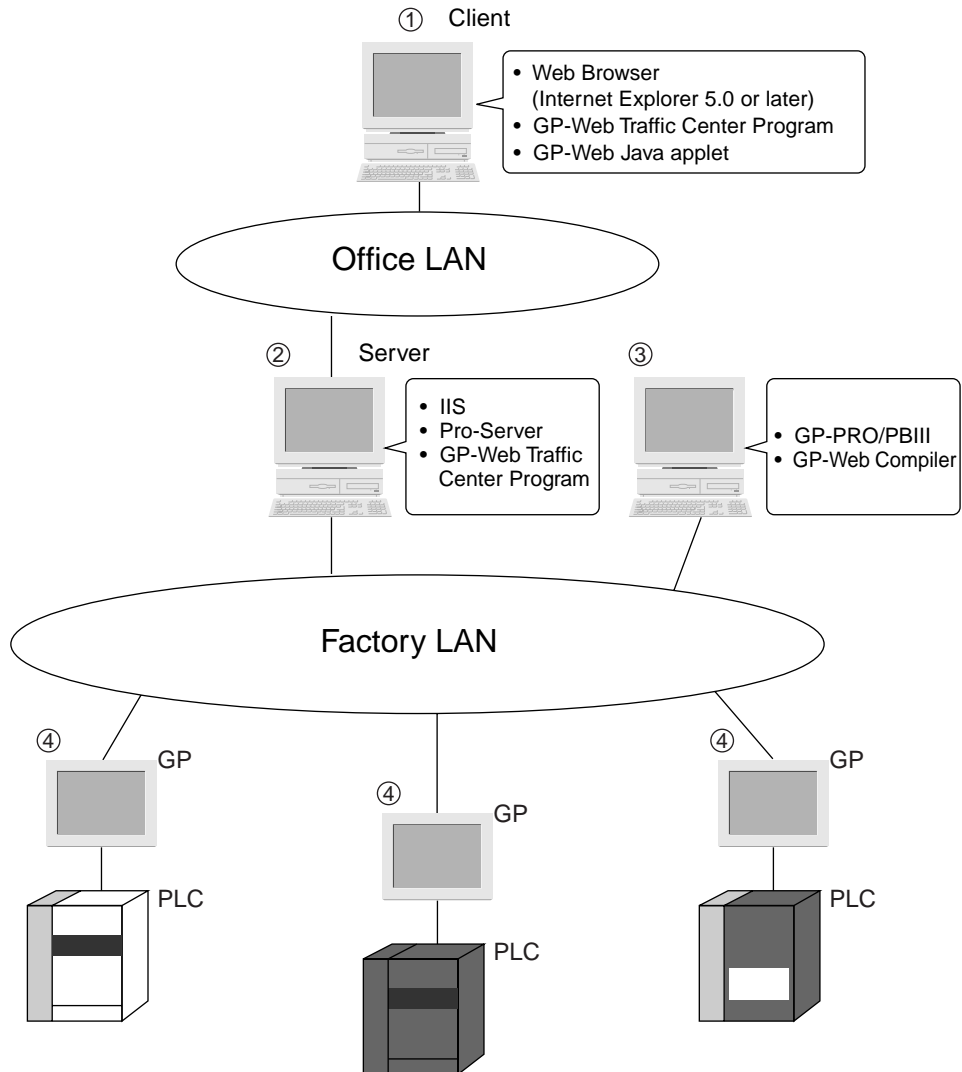

On the PC ③, GP screens are converted by the GP-Web Compiler to the file which you can view via the Internet. Converted screen data is then copied to the server ②. On the server ②, IIS, Pro-Server and the GP-Web Traffic Center program are running. From the client ①, by accessing to the server ② through an intranet, you can communicate directly with the GP-Web Traffic Center program. You can also view GP screens on the Web browser.

Use separate Ethernet cards for the office LAN and for the factory LAN on PC ②.

PCs for ② and ③ can be merged into one PC.

Configuration Procedure

The following describes the step-by-step procedure to execute GP-Web when using Easy Connection. It assumes that Pro-Server with Pro-Studio for Windows has been installed on PC ②, and GP-PRO/PBIII for Windows has been installed on PC ③.

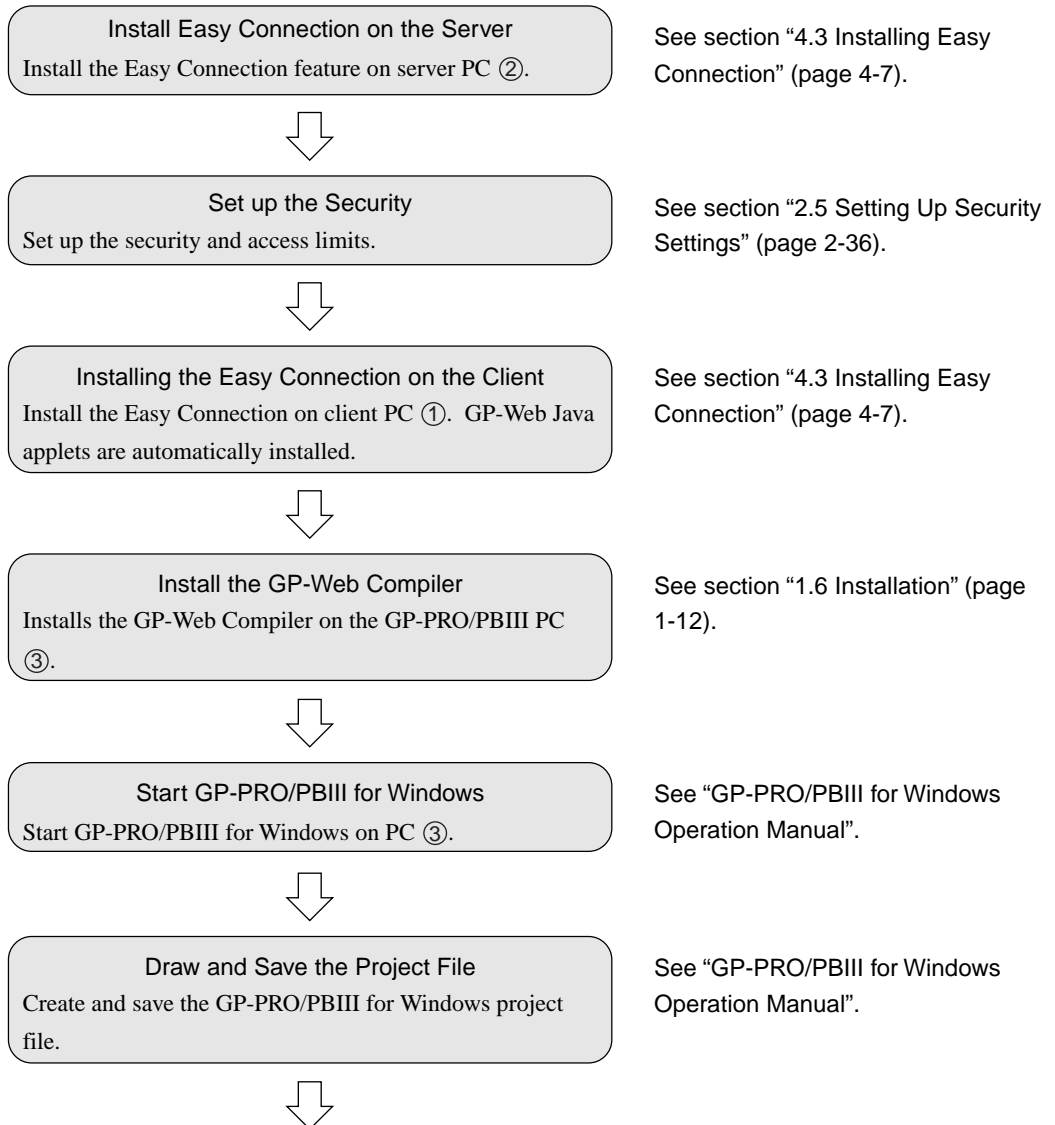

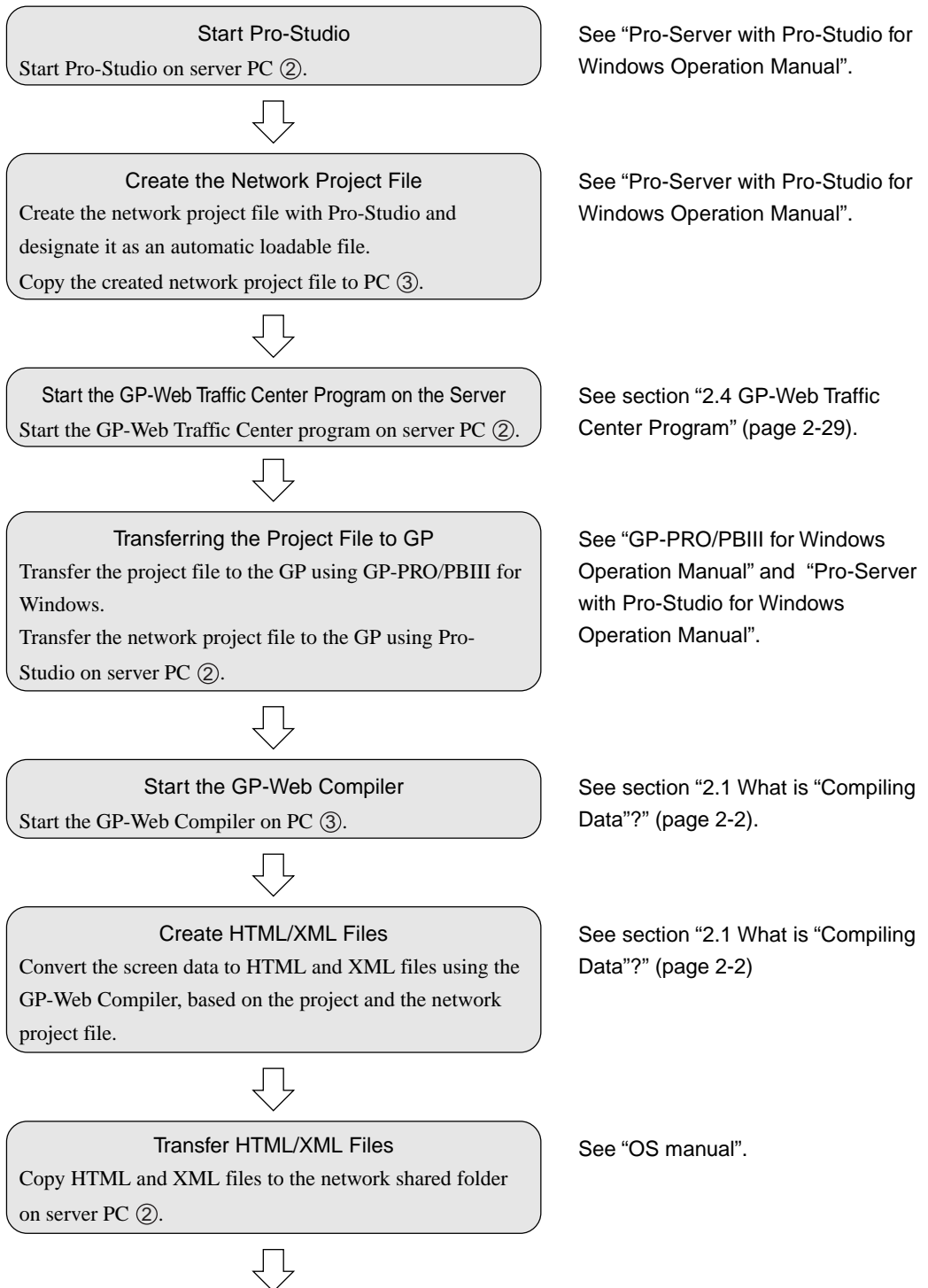

Start the GP-Web Traffic Center Program on the Client

Start the GP-Web Traffic Center program on client PC ①.

See section “2.4 GP-Web Traffic Center Program” (page 2-29).



Execution

Open the folder using the Web browser from client PC ①.
In this case, open the HTML file by selecting [File]-[Open]. Then Java applets are executed so that you can browse GP screens.

See “Chapter 3 Client” (page 3-1).

4.3 Installing Easy Connection

This section describes installation methods of the Easy Connection client and its server.

Cautions

- You must close all application programs before installing the software. Make sure that you also close (or release their resident condition) resident programs (e.g. virus checker) besides ordinal application programs.
- When you install these programs on a PC running Windows NT or Windows 2000, be sure to designate an administrator-level user privilege.

MEMO

Easy Connection Client is installed on the client PC. Easy Connection Server is installed on the server PC. Pro-Server needs to be installed on the server PC.

Installation Procedure

1. Insert the GP-Web CD-ROM into your PC's CD-ROM drive.

The installation program will automatically start and the following window will appear.



2. Click [Easy Connection Client Setup] to install Easy Connection Client, or click [Easy Connection Server Setup] to install Easy Connection Server.

The [Choose Setup Language] dialog box will appear.



3. Select either [Japanese] or [English] and click the [OK] button.

Follow the instruction given in each following dialog box to complete the software's installation.

4.4 GP-Web Compiler Routing Setup

Easy Connection requires a different routing setup for the GP-Web Compiler.

In the step 25 of “Using GP-Web Compiler” (page 2-11), if Pro-Server exists on the server PC, you did not specify the routing. In this communication environment, you must designate the computer name or IP address on the server since the Web server is not used.

For example, type “\\PC1 “ in the following case.

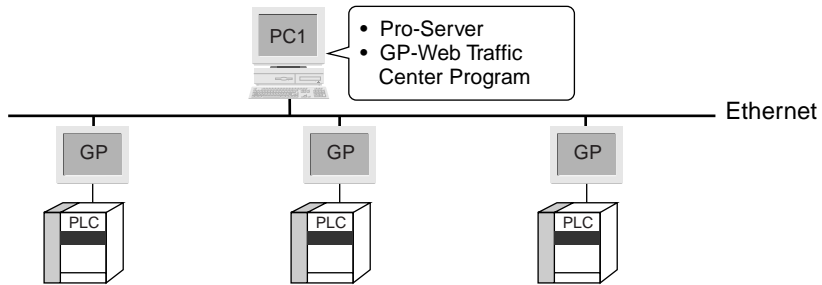

4.5 GP Alarm Display Application

Easy Connection uses the proprietary application software “GP Alarm Display” to display GP alarm data rather than the used GP alarm window displayed on the Web browser.

Starting and Exiting GP Alarm Display

Starting GP Alarm Display

1. If you enable the alarm display function by using the GP-Web Compiler, the [Alarm] button will appear on the GP screen displayed on the Web browser. Click the [Alarm] button.

Alarm

The [GP Alarm Display] window will appear.

TriggerD...	TriggerTi...	Message...	Acknow...	Recover...
00/10/10	10:30:00	ON		
00/10/10	10:30:00	ON		
00/10/10	10:30:00	OFF		

Exiting GP Alarm Display

1. Click the [Exit] button in the [GP Alarm Display] window.

GP Alarm Display

The following information describes how to display GP alarm data via the GP Alarm Display. The display method differs between past and current data.

Displaying Past Data

1. Start the GP Alarm Display.

The [GP Alarm Display] window will appear.

The screenshot shows the 'GP Alarm Display' window with the following components:

- SRAM Section:** Radio buttons for Logging, AlarmLog (selected), Trend, Block1, Sampling, Block2, AlarmActive, Block3, and AlarmHistory.
- CF CARD Section:** Radio buttons for Logging, AlarmLog, Trend, Block1, Sampling, Block2, AlarmActive, Block3, and AlarmHistory.
- Path:** \DTP_NT\TEMP\LogPage\SRAM\ALARMLOG\001010103000.csv
- File List:** A list of CSV files including 001010102000.csv and 001010103000.csv.
- Data Table:** A table with columns: TriggerD..., TriggerTi..., Message..., Acknow..., Recover... and rows of alarm data.
- Buttons:** Completion, UpLoad of the latest Data, and WebPage.

TriggerD...	TriggerTi...	Message...	Acknow...	Recover...
00/10/10	10:30:00	ON		
00/10/10	10:30:00	ON		
00/10/10	10:30:00	OFF		

2. In the top of the [GP Alarm Display] window, click the data type that you wish to see. Click the data type name in [SRAM] when you wish to see the SRAM data and the data type name in [CF CARD] for the CF Card data respectively.

The list of CSV files will appear in the lower left part of the window

3. Select the CSV file that you wish to see.

The contents of the CSV file selected will be shown in the lower right part.

Displaying Current Data

1. Follow steps 1 and 2 of "Displaying Past Data".
2. Click the [Upload of the latest Data] button.

Current GP alarm data will be stored in the server PC in CSV format. The CSV filename is the same as the filename specified by the GP-Web Compiler.

The contents of this CSV file will be shown in the lower right pane.

MEMO

If you did not enable [Include "Data Load" Button] with the GP-Web Compiler, [Uploaded of the latest data] will not appear. In that case, convert the GP internal log data to a CSV file using Pro-Server's Action feature. Copy the converted CSV file to the folder in the LogPage folder in the GP-Web screen folder. Copy the CF CARD contents to the CF CARD sub folder, and the SRAM contents to the SRAM sub folder. For the folder structure, see the description of folder structure in the clause "GP Alarm Display Diagram" (page 3-4).

4.6 GP Screen JPEG Display Application

Easy Connection uses the exclusive application called GP Screen JPEG Display Application instead of the GP screen JPEG display browser where GP screen JPEG data are displayed on the Web browser.

Starting and Exiting GP Screen JPEG Display Application

Starting GP Screen JPEG Display Application

1. If you have enabled the GP screen JPEG display feature on the GP-Web Compiler, the [Jpeg Display] button is added on the Web browser.

A rectangular button with the text "JpegDisp" in a sans-serif font.

2. Click the [Jpeg Disp] button.

GP Screen JPEG Display Application starts and the following window appears.

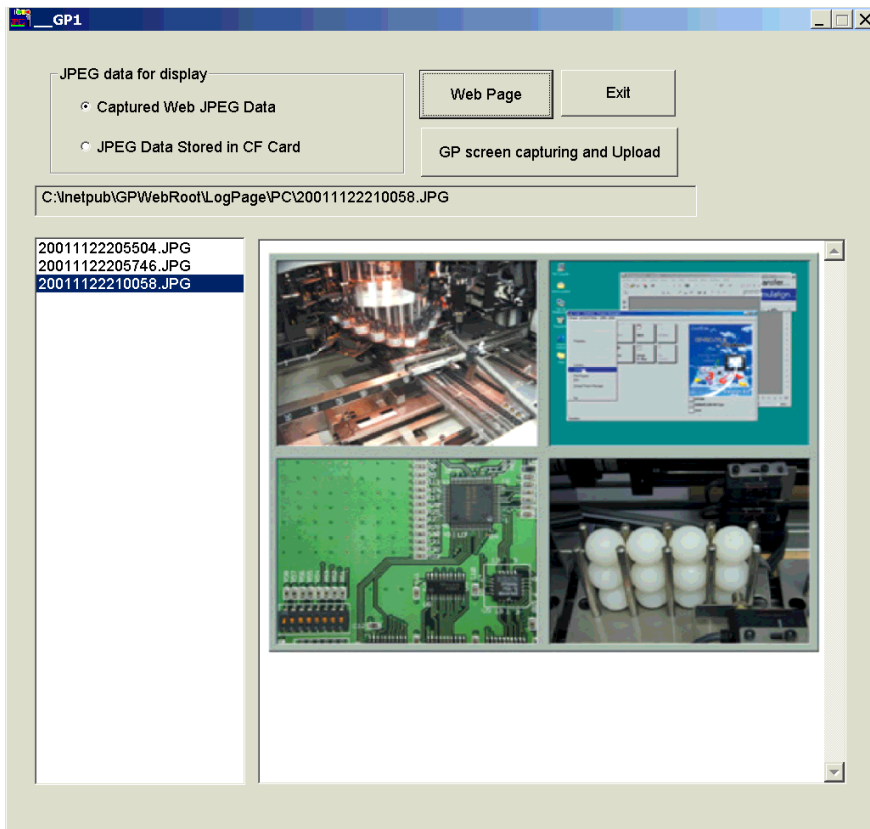

Exiting GP Screen JPEG Display Application

1. Click the [Exit] button shown in the above window.

GP Screen JPEG Display

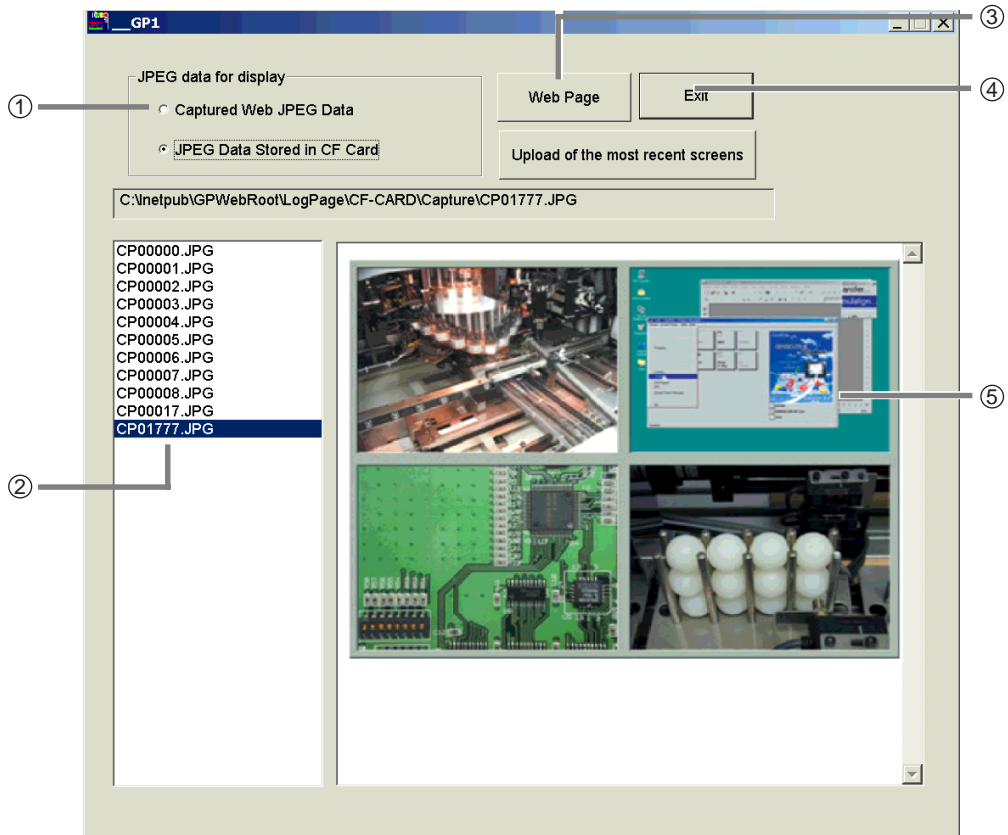

Select JPEG data to display either from [Capture Data from the Web] or [Data Saved in the CF Card]. The selected data is displayed in the area ⑤.

The list of data saved in the past is displayed in the area ②. If you wish to display capture data saved in the past, click any capture data name in the area ② to display it in the area ⑤.

The [Upload of GP Screen Capture] button (④) is to upload GP screen capture data to the server PC.

The [Web Page] button (③) is to specify the Web page folder where \LogPage folder exists when this program is started standalone.

A | Appendix

Glossary
Supported Drawing Commands
Supported Tag Commands
GP-Web Part/Library File
Error Messages

Glossary

This section describes this manual's Web-related terms.

ASP File

ASP is the abbreviation of Active Server Pages. ASP files are HTML files which include script language descriptions, and you can run script processes by starting your browser with these files specified.

Cable TV Connection

This indicates the full time Internet connection services that cable TV companies provide by using their cable TV lines.

CGI program

CGI is the abbreviation of Common Gateway Interface. According to requests from Web browsers, CGI programs are started on Web servers and servers respond those results back to Web browsers. CGI programs allow you to create dynamic pages where you can not describe only with HTML.

Data Polling Interval Change Applet

This allows you to freeze (stop temporarily) the data polling of GP-Web Java Applets or to change the interval.

Drawing Interval Change Applet

This allows you to freeze (stop temporarily) the drawing of GP-Web Java Applets or to change the interval.

Fire Wall

This indicates routers or hosts, or their functional roles, which protect in-house LANs from outside environments by setting up communication restrictions when connections are made from the Internet to in-house LANs.

GP-Web CGI Program

This indicates CGI programs for the GP-Web system called by GP-Web Java applets via IIS. This calls the GP-Web Traffic Center program to do data communications with Pro-Server.

GP-Web Compiler

This indicates the program which converts project files created by GP-PRO/PBIII to HTML/XML files.

GP-Web Java Applet

This indicates the Java applet to realize GP screen drawings on your browser by using the Java language. GP drawing and tag commands are processed by this Java applet.

GP-Web Resolution Change Applet

This indicates the Java applet to dynamically switch the resolution of the base screen displayed by the GP-Web Java applet by having inter-applet communications with the GP-Web Java applet.

GP-Web Screen Change Applet

This indicates the Java applet to switch the number of the base screen displayed by the GP-Web Java applet by having inter-applet communications with the GP-Web Java applet. Screens are switched only when they are asynchronous to GP screens.

GP-Web Synchronization Change Applet

This indicates the Java applet to dynamically switch the synchronization of the GP-Web Java applet to GP screens by having inter-applet communications with the GP-Web Java applet.

GP-Web Traffic Center Program

This indicates the program which intermediates data communications with Pro-Server on the GP-Web system.

GP Screen JPEG Display Script

This program allows you to see captured data from GP screens or those entered from the VM unit and stored in a CF Card on a client's PC's Web browser.

HTML file

HTML is the abbreviation of Hyper Text Markup Language and is the language for creating Web pages. It is used for describing logical structures or looks of documents. It is also possible to build images, sounds, animations and other document locations in documents. You can view the contents of those HTML files by reading those in your Web browser.

IIS

IIS is the abbreviation of Internet Information Server and is the Internet server software by Microsoft. The Web service is provided to users on Windows software. This integrates various server capabilities such as the Web server, the FTP server, the SMTP server or the limited NNTP service. This is bundled in the standard Windows NT Server or the Windows 2000 Server/Professional software package.

Internet

This indicates the computer network which connects networks in all over the world mutually by using TCP/IP. There are no computers which unifies the whole network, and it works on the base that computers in all over the world are connected mutually.

Internet Service Provider

This indicates companies which provide the Internet connection services. This may be abbreviated to ISP.

Intranet

This indicates LAN which is built by adopting the standard Internet technology such as TCP/IP. Unlike the Internet, the network is limited to the in-house usage.

Java

This indicates the object oriented program language developed by Sun Microsystems. Programs written in Java are converted to the intermediate format and sent to Web browsers. Programs will be executed on Web browsers.

Java Applet

This indicates programs written in Java. Java applets are downloaded on Web browsers and executed in Web browser windows.

Multi Language Table Change Applet

This Java applet allows you to switch numbers of character string table files being compliant to the multi-language feature of GP-PRO/PB III Ver. 6.0 and created in various languages (Korean, Chinese, Taiwanese, European).

Proxy Router

This indicates computers, standing between the Internet and in-house LANs, which route the Internet requests "on behalf of" computers on internal networks which can not be connected to the Internet directly. Or the software realizing the function mentioned here.

Shared Web Folder

This indicates the folder uploaded to the Web by using IIS. HTML files or CGI programs for homepages are stored in this folder.

Web Device View

This program allows you to display multiple GP data at one time on Web browser. This program runs on the server where Internet Information Server (IIS) and Pro-Server with Pro-Studio for Windows Ver.4.0 have been installed.

Web Device View Compiler Program

This program allows you to convert the Device View setup file (.#dv) created on Pro-Server to the file for the Web Device View (ASP file).

XML file

XML is the abbreviation of Extensible Markup Language and is the language for describing document structures. Unlike HTML, you can define your own document structure. By using XML files, you can exchange or distribute documents or data on the Internet. In case of GP-Web, parameters of GP drawing or tag commands are sent to GP-Web Java applets in this file format.

Supported Drawing Commands

Among GP-PRO/PBIII drawing commands, the following commands are supported by GP-Web.

Only the following drawing features are supported.

- line/poly-line command
- rectangle command
- circle/ellipse command
- arc/sector command
- polygon fill command
- ruler command
- text string command
- mark call-up command

Among these drawing commands, there are some functions not available with GP-Web. Functions available and not available with GP-Web are listed below for each drawing command.

The display may differ for GP and for your Web browser even if drawing commands are supported.

		Ver. 1.0/1.1/1.5
Line/Poly-line Command		
	specifying a display color	Yes
	blinking a display color	Yes
	specifying a background color	No
	blinking a background color	No
	drawing an arrow	Yes
	drawing a solid line	Yes
	drawing a dotted line	No
Rectangle Command		
	specifying a display color	Yes
	blinking a display color	Yes
	specifying a background color	No
	blinking a background color	No
	drawing a solid line	Yes
	drawing a dotted line	No
	chamfering	Yes
	specifying the number of dots in chamfering	Yes
	solid fill pattern	Yes
	fill patterns except for a solid fill	No

		Ver. 1.0/1.1/1.5
Circle/Ellipse Command		
	specifying a display color	Yes
	blinking a display color	Yes
	specifying a background color	No
	blinking a background color	No
	drawing a solid line	Yes
	drawing a dotted line	No
	solid fill pattern	Yes
	fill patterns except for a solid fill	No
Arc/Sector Command		
	specifying a display color	Yes
	blinking a display color	Yes
	specifying a background color	No
	blinking a background color	No
	drawing a solid line	Yes
	drawing a dotted line	No
Polygon Fill Command		
	specifying a display color	Yes
	blinking a display color	Yes
	specifying a background color	No
	blinking a background color	No
	drawing a solid line	Yes
	drawing a dotted line	No
	solid fill pattern	Yes
	fill patterns except for a solid fill	No
Ruler Command		
	specifying a display color	Yes
	blinking a display color	Yes
	specifying a background color	No
	blinking a background color	No
	drawing a solid line	Yes
	drawing a dotted line	No
	ruler type	Yes
	number of graduations to be divided	Yes

		Ver. 1.0/1.1/1.5
Text String Command		
	specifying a display color	Yes
	blinking a display color	Yes
	specifying a background color	Yes
	blinking a background color	Yes
	specifying a shade color of a carving style	Yes
	blinking a shade color of a carving style	Yes
	text direction	Yes
	text style	Yes
	text size	Yes
	text rotation angle	Yes
	text font	No
Mark Call-up Command		
	specifying a display color	Yes
	blinking a display color	Yes
	specifying a background color	Yes
	blinking a background color	Yes
	specifying a mark size	Yes

Supported Tag Commands

The following GP-PRO/PBIII tag commands are supported by GP-Web.

Only the following tags are supported.

- C tag
- E tag
- F tag
- G tag
- K tag
- L tag
- N tag
- S tag
- T tag
- U tag

Among these tag commands, there are some features not available with GP-Web. Refer to the following list for each tag command.

The display may differ for GP and for your Web browser even if drawing commands are supported.

		Ver. 1.0	Ver. 1.1	Ver. 1.5
C Tag				
	character size	–	Yes	Yes
	specifying a display color	–	Yes	Yes
	blinking a display color	–	Yes	Yes
	specifying display rotation	–	Yes	Yes
	specifying a tiling pattern	–	Yes	Yes
	specifying a background color	–	Yes	Yes
	character size (full/half)	–	Yes	Yes
	specifying a background color at tiling	–	Yes	Yes
E Tag				
	specifying data (absolute/relative)	–	Yes	Yes
	specifying a sign	–	Yes	Yes
	rounding off numbers	–	Yes	Yes
	specifying a display data form	–	Yes	Yes
	specifying display address (indirect)	–	No	No
	bit length when [relative] is selected	–	Yes	Yes
	input sign when [relative] is selected	–	Yes	Yes
	input display when [relative] is selected	–	Yes	Yes
	input range when [relative] is selected	–	Yes	Yes
	display range when [relative] is selected	–	Yes	Yes
	character size	–	Yes	Yes
	the number of digits to be displayed	–	Yes	Yes
	the number of decimals	–	Yes	Yes
	display style		Yes	Yes

		Ver. 1.0	Ver. 1.1	Ver. 1.5
E Tag				
	specifying a range	–	Yes	Yes
	the number of ranges	–	Yes	Yes
	setting a range	–	Yes	Yes
	specifying a number color	–	Yes	Yes
	blinking a number color	–	Yes	Yes
	specifying a background pattern	–	Yes	Yes
	specifying a background color	–	Yes	Yes
	blinking a background color	–	Yes	Yes
	operation	–	Yes	Yes
	specifying display rotation	–	Yes	Yes
F Tag				
	specifying a display (direct/indirect)	–	Yes	Yes
	type of screen (base screen/image screen)	–	Yes	Yes
	type of screen (CF card image screen)	–	No	No
	screen number	–	Yes	Yes
	specifying a word address	–	Yes	Yes
	specifying a display data form when [relative] is selected	–	Yes	Yes
	operation mode (area move/move between 2 points)	–	Yes	Yes
	displaying a display data form	–	Yes	Yes
G Tag				
	specifying data (absolute/relative)	Yes	Yes	Yes
	display mode	Yes	Yes	Yes
	display a data form when [absolute] is selected (BIN/BCD)	Yes	Yes	Yes
	input range when [relative] is selected	Yes	Yes	Yes
	chart type (bar chart/pie chart/half-pie chart)	Yes	Yes	Yes
	fill patterns for a bar chart	Yes	Yes	Yes
	chart fill patterns except for a bar chart	No	No	No
	indicating a starting point of a meter-type pie or half-pie chart	Yes	Yes	Yes
	specifying a display color	Yes	Yes	Yes
	specifying a background color	No	No	No
	blinking a background color	No	No	No
	displaying alarm	Yes	Yes	Yes
	specifying alarm background color	No	No	No
	blinking alarm background color	No	No	No
	specifying display rotation	No	Yes	Yes

		Ver. 1.0	Ver. 1.1	Ver. 1.5
K Tag				
	specifying a data (absolute/relative/character string)	–	Yes	Yes
	specifying a word address	–	Yes	Yes
	specifying a starting bit address	–	No	No
	specifying a display address (indirect)	–	No	No
	specifying a sign	–	Yes	Yes
	rounding off numbers	–	Yes	Yes
	specifying display/write data form	–	Yes	Yes
	bit length when [relative] is selected	–	Yes	Yes
	input sign when [relative] is selected	–	Yes	Yes
	input range when [relative] is selected	–	Yes	Yes
	display range when [relative] is selected	–	Yes	Yes
	the number of characters to be displayed when [character string] is selected	–	Yes	Yes
	character size	–	Yes	Yes
	the number of digits to be displayed	–	Yes	Yes
	the number of decimals (direct/indirect)	–	Yes	Yes
	specifying display style	–	Yes	Yes
	automatic clear	–	No	No
	checking the number of digits to be input	–	No	No
	bar code input	–	No	No
	alarm (direct/indirect/color change)	–	Yes	Yes
	specifying an alarm display color	–	Yes	Yes
	blinking an alarm display color	–	Yes	Yes
	specifying an alarm background color	–	Yes	Yes
	blinking an alarm background color	–	Yes	Yes
	operation	–	Yes	Yes
	specifying display rotation	–	Yes	Yes
L Tag				
	screen number (direct/indirect/state)	Yes	Yes	Yes
	starting method	Yes	Yes	Yes
	calling the base screen and the image screen	Yes	Yes	Yes
	delete action (enable/unable)	Yes	Yes	Yes
	display a data form when [indirect] is selected (BIN/BCD)	Yes	Yes	Yes
	calling image screens in the CF Card	No	No	No

		Ver. 1.0	Ver. 1.1	Ver. 1.5
N Tag				
	specifying data (absolute/relative)	Yes	Yes	Yes
	specifying if to show a negative number	Yes	Yes	Yes
	specifying a display data form	Yes	Yes	Yes
	access a data length	Yes	Yes	Yes
	input range when [relative] is selected	Yes	Yes	Yes
	text size	Yes	Yes	Yes
	text font	No	No	No
	number of digits to be displayed	Yes	Yes	Yes
	specifying a display color	Yes	Yes	Yes
	blinking a display color	Yes	Yes	Yes
	specifying a background color	Yes	Yes	Yes
	blinking a background color	No	No	No
	alarm process	Yes	Yes	Yes
	specifying an alarm color	Yes	Yes	Yes
	blinking an alarm color	Yes	Yes	Yes
	specifying an alarm background color	Yes	Yes	Yes
	blinking an alarm background color	No	No	No
	operator process	Yes	Yes	Yes
	specifying display rotation	No	Yes	Yes
S Tag				
	starting method	Yes	Yes	Yes
	post-start read	Yes	Yes	Yes
	text size	Yes	Yes	Yes
	text font	No	No	No
	number of texts to be displayed	Yes	Yes	Yes
	specifying a text color	Yes	Yes	Yes
	blinking a text color	Yes	Yes	Yes
	specifying a background color	Yes	Yes	Yes
	blinking a background color	Yes	Yes	Yes
	display location	Yes	Yes	Yes
	clearing display	Yes	Yes	Yes
	specifying display angle	Yes	Yes	Yes

		Ver. 1.0	Ver. 1.1	Ver. 1.5
T Tag				
	write action mode (bit/word/special)	Yes	Yes	Yes
	specifying an operator	Yes	Yes	Yes
	hierarchical screen switching	Yes	Yes	Yes
	special actions except for T tag extension	No	No	No
	Q tag extended action	No	No	No
	function key process	No	No	No
	interlock capability	Yes	Yes	Yes
	grouping with the automatic disable capability	Yes	Yes	Yes
	addition/subtraction on/from a specified digit	Yes	Yes	Yes
	GP reset	Yes	Yes	Yes
	AUX output	No	No	No
	buzzer sound	Yes	Yes	Yes
	reverse display	Yes	Yes	Yes
U Tag				
	specifying method of the window registration screen (direct/indirect)	Yes	Yes	Yes
	display a data form when [indirect] is selected (BIN/BCD)	Yes	Yes	Yes
	action mode	Yes	Yes	Yes
	reshuffling of overlapped screens	Yes	Yes	Yes

GP-Web Part/Library File

Part/Library files are also available with GP-Web. You should use those Part/Library files when drawing a screen using GP-PRO/PBIII for Windows. Otherwise, the screen may not be able to be drawn.

When you install the GP-Web Compiler, the GP-Web Part files and the GP-Web Library files will also be installed to the PDB and the CPW folders in the GP-PRO/PBIII folder respectively.

The following figure shows each folder structure and the Part/Library filenames.

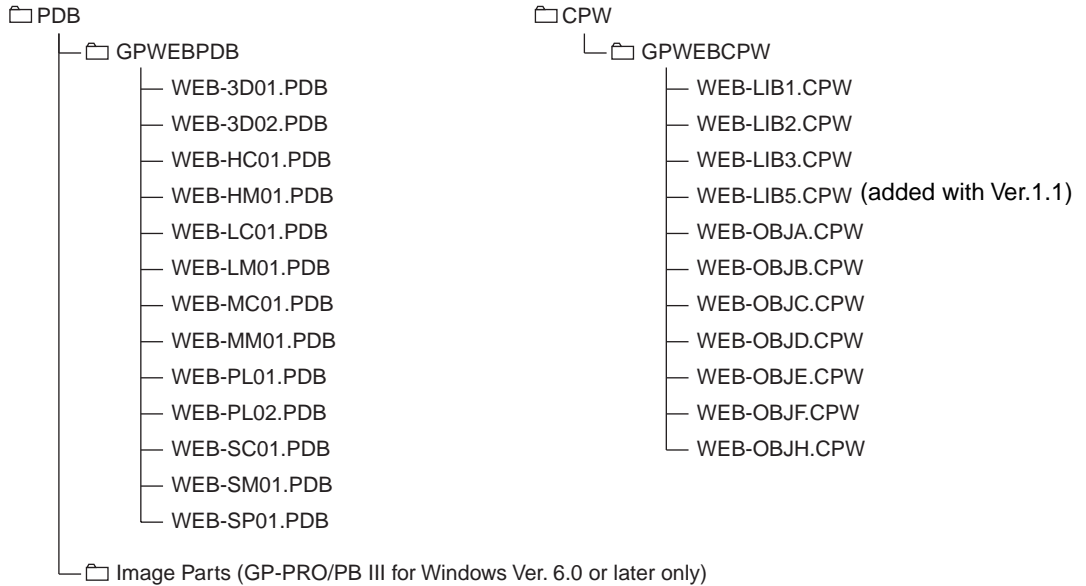

The following restrictions apply.

- Rectangle is the only pattern that you can specify.
- You can not specify the file item operation key, the logging operation key and offline with the special action of the special switch.
- The display of tank graphs is slightly different from that of GP.
See “About GP-Web display” (page 5).

The GP-Web Library files are set to read only. When you edit the GP-Web Library files, use “Save As” to save changes.

The following parts cannot be used on GP-Web.

- Dashed-line graphs
- Keypads
- Alarms
- File item display unit
- Logging display unit

Image parts using the BPD file in the image parts folder can also be used on GP-Web. The user created BPD file can be used on GP-Web as well.

Error Messages

GP-Web displays the following messages if an error occurs.

Error code is displayed in Error Message window or Web browser.

MEMO

GP-Web also displays Pro-Server error messages. If you find such messages, refer to the Pro-Server manual.

For GP-Web Java Applets:

Code	Message
18000	Cannot find Screen File Number XXXX.
18001	Cannot find Screen File XXXX.
18002	Applet cannot be started, because Communication method has not been designated.
18003	XML Analysis error
18004	Primary node name does not exist in browser.(DEFNODE parameter is not designated in the HTML file.)
18005	Polling start-up failure error
18006	Read Error: Image File
18007	Read Error: Mark File
18008	Cannot start the GP Log Data Display program.
18010	Unable to locate Bit Map Screen Data file.
18021	Data transfer has been interrupted (Transmission Time Out)
18022	Cannot link Traffic Center DLL (DirectTCX.DLL)
18024	Pro-Server returned error after attempting device read.
18025	Pro-Server returned error after attempting device write.
18023	Pro-Server returned error after analyzing device name.
18026	Pro-Server returned error after attempting GP reset.
18027	Due to network error, unable to send data
18028	Response communication data packet contains illegal data
18029	Response communication data packet header is illegal
18030	Illegal code in communication data packet :
18031	System Error
18032	User Name data entry has been cancelled. This is because the current user does not have the access privilege.
18033	Cannot find File : XXXX
18034	JAVA Error : XXXX
18035	OS has detected error after calling DirectTCX.DLL : XXXX
18036	Incorrect version of protocol format.

For GP-Web Traffic Center Program:

Code	Message
19000	Cannot use TCP/IP: Details XXXX XXXX
19001	An error has occurred in TCP/IP socket: Details XXXX XXXX
19002	Received XXXX bytes of data. Data is too large.
19003	System error: Received only XXXX byte in XXXX byte data reception request.
19004	System locked. Program will be shut down
19005	Insufficient memory. Cannot start up the Traffic Center.
19006	Too much data being transmitted. Cannot process all the data.
19007	Pro-Server is not properly installed.
19008	Insufficient memory or memory conflict. Cannot process.
19010	Protocol error. Received illegal data. : XXXX
19011	Received an unsupported (system) code (XXXX). Cannot process.
19012	Received an unsupported command (XXXX). Cannot process.
19013	Duplex routing requested:XXXX
19014	Data syntax error.
19015	Data format version error.
19016	Pro-Server version is too old. Cannot perform processing.
19017	Cannot decode the data's encryption. Illegal circuit data.
19018	An error has occurred in CGI or the Traffic Center API.
19020	Frame reception has been interrupted.
19021	Receive Node response has stopped during data transmission.
19022	Data communication has been interrupted.
19023	The Traffic Center has not started correctly.
19024	Traffic Center is busy.
19025	The Traffic Center is shut down.
19026	No response from the Traffic Center.
19027	The Traffic Center has already been started.
19028	The Traffic Center has failed to respond within the defined period.
19029	The Traffic Center communication line(s) to external devices is/are disconnected and the Traffic Center cannot respond.

Code	Message
19030	Pro-Server is shut down. Traffic Center cannot continue processing and will be shut down.
19031	An error has occurred during communication with a GP. (MtoM LAN protocol error)
19032	Traffic Center is currently busy. Your request exceeds the Traffic Center's usage limit license. Unable to process.
19050	Invalid routing data - cannot be processed.
19051	(XXXX) is not registered as an authorized user.
19052	(XXXX) has no usage right(s).

For GP-Web CGI and GP-Web Traffic Center Program API:

Code	Message
19501	Cannot create the designated file.
19502	Protocol data error. Unreadable words or inconsistent description in the data packet.
19503	A communication error has occurred during data transfer
19504	Parameter error

For GP-Web Compiler:

Code	Message
20001	Illegal block abort is detected in segmented PRW files.
20002	Code that cannot be analyzed has been detected.
20003	Invalid device address in Project File.Invalid device address in Project File.
20004	Cannot write to XXXX file.
20005	PRW segmented file size is incorrect.
20006	PRW segmented file contents are incorrect.
20007	Cannot access the designated file XXXX.
20008	Cannot process due to insufficient memory.
20009	XXXX file is damaged. Cannot read.
20010	XXXX file is not a project file.
20011	Cannot find the designated PLC protocol table (PLCTBL).Designate the correct Pro-PB folder.
20012	Data Transfer settings are not correct.
20013	Could not convert the Image File.
20014	Could not convert the Alarm Log file data.
20015	No Alarm Log file. Cannot create.
20016	Designate the "SAVE TO" folder. The Web page will be saved in this folder
20017	Illegal/Invalid folder name
20018	No valid Web Compiler found in the Web Compiler folder.
20019	Designate "SAVE FROM" Project File correctly.
20020	Cannot save setting data. Check the SAVE TO folder.
20021	Selected template file is incorrect. Re-enter.
20022	GPTypes.ID file does not exist or is corrupted.
20023	Designate the Alarm Log data READ TO folder.
20024	Network Project File is not designated. Cannot verify the settings. OK to continue processing?
20025	Node is not designated. Designate the Network Project File and designate that file's node.

Code	Message
20026	Network Project is not designated correctly, or the designated node does not exist in the Network Project. OK to continue processing?
20027	OK to continue processing?
20028	Illegal CSV file name
20029	Network Project File has not been designated.
20030	Node has not been designated. Designate the Network Project File and designate that file's node.
20031	Name of HTML output file is not designated.
20032	The template file for Alarms is not correct.
20033	The designated Node is illegal/does not exist.
20034	This is not a Network Project File.
20035	The allowed screen size range is from 1 to 1024.
20036	The Timeout value can be from 1 to 3000000.
20037	XXXX is not ready for data transfer. Perform the data transfer preparation in Pro-PB/Win
20038	Cannot find or open XXXX
20039	XXXX is not a Project File. Invalid file format.
20040	Cannot write to the output file.
20041	Error in Project File XXXX.(Error code XXXX)
20042	CF Card folder is not yet created inside the Project File.
20043	Invalid password. Re-enter the password.
20501	Warning!. Unrecognizable substitution mark (\$\$) in template. XXXX
20502	Warning!. Missing substitution end mark (\$\$) in template. XXXX
20503	Warning!. No GP Web applet description in template. Browser cannot display the project.
20504	Warning!. Illegal GP Web applet attribute description in template. XXXX

For ASP:

Code	Message
21001	Upload of latest data has failed
21002	Cannot find the designated folder
21003	Cannot find the designated file
21004	File open error or designated file does not exist
21005	Unable to extract character string
21006	CF CARD file(s) does not exist

For Easy Connection:

Code	Message
21201	CSV file read has failed
21202	DirectTCX.dll has not been installed properly
21203	Designated file does not exist, or read in of file failed
21204	It failed in the formation of Folder if there was a mistake in the choice of Folder
21205	Designated folder is not Web Page folder
21206	Select Alarm Item before you push the "UpLoad" button
21207	CF CARD file(s) does not exist

For Licence Application:

Code	Message
22201	GP-Web Server is not installed properly
22202	Entered data is different from registered KEY CODE
22203	License setup has failed
22204	Same item has been previously registered
22205	It has already registered by the same establishment

For WebDeviceViewCompiler resource:

Code	Message
20701	Designate an output folder.
20702	A Device View setting file is not entered.
20703	An output folder is not entered.
20704	An output HTML file name is not entered.
20705	Incorrect routing path.
20706	The designated output folder does not exist. OK to create %s ?
20707	The designated Device View setting file does not exist.
20708	Unable to compile Possible causes are: The file in the Template folder or output folder may be in use, or Read-only file.
20709	Unable to compile. The output folder does not exist.
20710	Unable to compile. The Template folder does not exist.
20711	The shared web folder is not entered.
20712	Unable to create the designated folder(%s).