

Pro-face



Pro-Server

2 Way Communicator

with Pro-Studio for Windows

Operation Manual

Copyright 2001, Digital Electronics Corporation
All right reserved. Made in Japan

PREFACE

Thank you for purchasing Digital's "Pro-Server with Pro-Studio for Windows" for use with Digital's GP series touch panels.

To ensure correct use of this product, be sure to carefully read the manuals included and keep them nearby so that you can refer to them whenever required.

NOTE

- (1) The copyrights to all programs and manuals included in the "Pro-Server with Pro-Studio for Windows" (hereinafter referred to as "this product") are reserved by the Digital Electronics Corporation. Digital grants the use of this product to its users as described in the "Software Operating and License Conditions" section. Any actions violating the above-mentioned conditions are prohibited by both Japanese and foreign regulations.
- (2) The contents of this manual have been thoroughly checked. However, if you should find any errors or omissions in this manual, please contact your local representative and inform them of your findings.
- (3) Please be aware that Digital Electronics Corporation shall not be held liable by the user for any damages, losses, or third party claims arising from the uses of this product.
- (4) Differences may occur between the descriptions found in this manual and the actual functioning of this product. The latest information about this product is provided in the accompanying data files (i.e. Readme.txt files, etc.) and/or separate documents. Please consult these sources as well as this manual prior to use.
- (5) Even though the information contained in and displayed by this product may be related to intangible or intellectual properties of the Digital Electronics Corporation or third parties, the Digital Electronics Corporation shall not warrant or grant the use of said properties to any users and/or other third parties.

TRADEMARK RIGHTS

The company names and product names used in this manual are the trade names, trademarks (including registered trademarks), and service marks of their respective companies.

This product omits individual descriptions of each of these rights.

Trademark/Tradename	Right Holder
Microsoft, MS-DOS, Windows, Windows 95, Windows 98, Windows 98 SE, Windows Me, Windows NT, Windows 2000, Windows Explorer, ActiveX	Microsoft, U.S.
Intel, Pentium, MMX	Intel, U.S.
Ethernet	Xerox, U.S.
IBM, VGA, PC/AT, OS/2	IBM, U.S.
FIX32, FIX-MMI, FIX-FA, ifix	Intellution, U.S.

The following terms used in this manual differ from the above mentioned formal trade names and trademarks.

Term used in this manual	Formal Trade Name or Trademark
Windows 95	Microsoft® Windows® 95 Operating System
Windows 98	Microsoft® Windows® 98 Operating System
Windows 98 SE	Microsoft® Windows® 98 SE Operating System
Windows Me	Microsoft® Windows® Me Operating System
Windows NT	Microsoft® Windows® NT Operating System
Windows 2000	Microsoft® Windows® 2000 Operating System

HOW TO USE THIS MANUAL

Structure of This Manual

This manual, titled “Pro-Server with Pro-Studio for Windows Operation Manual” describes how to use the “Pro-Server with Pro-Studio for Windows” software, hereinafter referred to as “this software”

The following table describes the GP-PRO/PBIII for Windows software’s manuals, which are often referred to in this manual.

Vol. 1	Operation Manual	Describes the procedures for the installation and operation of GP-PRO/PBIII for Windows.
Vol. 2	Tag Reference Manual	Includes detailed descriptions on the “tags” used to specify the functions used on the GP’s screen.
Vol. 3	Parts List	Describes the library of pre-made Parts included with this product as well as a variety of diagram symbols.
Vol. 4	PLC Connection Manual	Describes the procedures to create connections between GP series units and other manufacture PLCs.

In addition to this manual, information on additional/modified functions may be provided as data files.

TABLE OF CONTENTS

PREFACE	1
NOTE	1
TRADEMARK RIGHTS	2
HOW TO USE THIS MANUAL	3
TABLE OF CONTENTS	4
MANUAL SYMBOLS AND TERMINOLOGY	8
PRECAUTIONS	9
PACKAGE CONTENTS	10
OPERATING ENVIRONMENT	11

Chapter 1 Introduction

1.1 Outline	1-2
1.2 What is the 2-Way Driver?	1-3
1.3 System Configuration	1-4
1.3.1 External Configuration	1-4
1.3.2 Internal Configuration	1-5
1.4 Application Interfaces	1-11
1.4.1 DDE function Outline	1-11
1.4.2 Simple DLL Function	1-12
1.4.3 OPC Interface Function	1-13
1.4.4 SRAM Backup Data Storage Function	1-14
1.5 Provider Information Outline	1-15
1.5.1 Providing Information to the Host	1-15
1.5.2 Providing Information between GPs	1-16
1.5.3 Action Feature Overview	1-17
1.6 Overview of Data View	1-18
1.7 Configuring the System	1-19

Chapter 2 Pro-Server Fundamentals

2.1 Installing the Software	2-2
2.2 Starting and Exiting the Software	2-5
2.2.1 Starting and Using Pro-Studio	2-5
2.2.2 Exiting Pro-Studio	2-9
2.2.3 Starting and Exiting Pro-Server	2-10
2.3 Screen Item Names and Functions	2-12

Chapter 3 Operation

3.1	Registering Network Entry Nodes	3-2
3.2	Registering Symbols	3-5
3.2.1	Importing Symbols	3-8
3.2.2	Symbol Export	3-9
3.2.3	Importing the GLC Symbols	3-10
3.3	Registering Provider Data	3-12
3.3.1	Checking for Provider Data Errors	3-15
3.3.2	Action Items	3-17
3.4	Using the DDE Function	3-18
3.5	Using the VBA Support Function	3-22
3.6	Saving Backup Data in SRAM	3-29
3.7	Device Data Backup and Restoration	3-31
3.7.1	Device Data Backup	3-31
3.7.2	Restoring Device Data	3-34
3.8	GP Capture Data Saving Function	3-36
3.9	Security Function	3-38
3.9.1	User Level Password Settings	3-38
3.9.2	Remote Password Setup	3-40
3.10	Configuring the System	3-42
3.11	Configuring the Network	3-44
3.11.1	Configuring Ethernet Cards	3-46
3.12	Printing the Setting Data	3-47

Chapter 4 Action Items

4.1	Overview	4-2
4.2	Action Item Registration	4-3
4.3	Action Item "Contents"	4-4
4.3.1	Start Application	4-4
4.3.2	Write Data to Excel Book	4-5
4.3.3	Alarm Log (with Sound Alert Features)	4-8
4.3.4	Upload of GP Log Data	4-10
4.3.5	Automatic Download of GP Filing Data	4-13
4.3.6	Automatic Upload of GP Filing Data	4-15
4.3.7	Automatic Upload of Access Data	4-17
4.3.8	Automatic Download of Access Data	4-19
4.3.9	Download Recipe Data for Excel	4-21
4.3.10	Writing Data to E-Mail	4-24
4.3.11	Upload to Database	4-26
4.3.12	Download from Database	4-29
4.3.13	Upload of GP JPEG Data	4-32
4.4	Action Item Designation	4-35

Chapter 5 GP Setup

5.1 Transferring Data to GPs	5-2
------------------------------------	-----

Chapter 6 Tools

6.1 Device Monitoring	6-2
6.2 GP Status Monitoring	6-4
6.3 Read Performance Measuring Tool	6-6

Chapter 7 Data View

7.1 Data View Overview	7-2
7.2 Device View	7-4
7.2.1 Setting Sampling Target Device	7-4
7.2.2 Setting the Data Sampling Condition	7-8
7.2.3 Editing Sampled Data	7-16
7.2.4 Option	7-19
7.2.5 Playback Feature	7-24
7.2.6 Other Features	7-26
7.3 GP-Viewer	7-30
7.3.1 Starting GP-Viewer	7-30
7.3.2 Setting the Data Sampling Condition	7-32
7.3.3 Editing Sampled Data	7-40
7.3.4 Setting Drawing	7-43
7.3.5 Playback Feature	7-45
7.3.6 Other Features	7-47
7.4 Checking the Data Sampling Status	7-59
7.5 System Time Bar	7-61

Chapter 8 Maintenance via Ethernet

8.1 Transferring Network Project Files	8-2
8.2 Transferring Only Updated Screen Data to GPs	8-3
8.3 Searching for a Network Node	8-5

Chapter 9 Simple DLL Function

9.1 Simple DLL (ProEasy.DLL) Function	9-2
9.1.1 Precautions When Using Functions	9-2
9.1.2 Direct Read/Write Function	9-5
9.1.3 Cache Read Function	9-10
9.1.4 Additional Functions	9-14
9.2 Examples of Simple DLL Function	9-20
9.2.1 VG Feature Help	9-20
9.2.2 VC Function Help	9-33

Chapter 10 OPC Server

10.1 OPC Server	10-2
-----------------------	------

Appendices

A.1 DDE Function Details	A-2
A.1.1 DDE Address	A-2
A.1.2 Device Address Options	A-3
A.2 Error Messages	A-5
A.2.1 Pro-Server with Pro-Studio for Windows Error Messages	A-5
A.2.2 2-Way Driver Error Messages and Syslog Features	A-10
A.3 Scale Conversion using Excel.....	A-14
A.4 GP Ethernet Settings	A-15

MANUAL SYMBOLS AND TERMINOLOGY





This manual uses the following symbols and terminology.

If you have any questions about the contents of this manual, please contact your local GP distributor.

Also, If you have any question about your personal computer or Windows, please contact your local distributor or manufacturer.

Safety Symbols and Terms

This manual uses the following symbols and terms for important information related to the correct and safe operation of this product.

Symbol	Description
 Warning	Incorrect operation resulting from negligence of this instruction may cause death or serious injury.
 Caution	Incorrect operation resulting from negligence of this instruction may cause injury or damage to equipment.
	Indicates Instructions/Procedures that must be performed to ensure correct product use.
	Indicates Actions/Procedures that should not be performed.

General Information Symbols and Terms

This manual uses the following symbols and term for general information.

Symbol	Description
	Provides hints on correct use, or supplementary information.
Reference →	Indicates (manual name, page number) related information.
Pro-Server with Pro-Studio for Windows	Downloading Ethernet (2-Way Driver) information to the GP allows the Host PC to use the network to send and receive data from a PLC, via the GP.
Screen editor software	Indicates "GP-PRO/PBIII for Windows".
PLC	Acronym for Programmable Logic Controller.

PRECAUTIONS

Product Usage Precautions

To prevent program malfunctions or accidents, be sure to observe the following instructions:

Warning

- ❗ Touch panel switches should NOT be used for a device's Emergency Stop switch. Generally speaking, all industrial machinery/systems must be equipped with a mechanical emergency stop switch that can only be operated by people. Also, for other kinds of systems, similar mechanical switches must be provided to ensure safe operation of that system.

Cautions

- ⊘ Do not turn off your personal computer's power switch during the execution of a program.
- Do not change the contents of this product's project files using the Text Editor software.

■ CD-ROM Usage Precautions

To prevent CD-ROM damage or malfunctions, please observe the following instructions:

- Do not remove a CD-ROM disk from the CD-ROM drive while the operation lamp is lit.
- Do not touch the CD-ROM recording surface.
- Do not store the CD-ROM disk in a place where it may be exposed to extremely high or low temperatures, high humidity, or dust.

PACKAGE CONTENTS

The Pro-Server with Pro-Studio for Windows 4.0 package includes the following items. Check that there are no missing items before using the software.

■ Pro-Server with Pro-Studio for Windows 4.0

Application CD-ROM



■ Packing List (Japanese/English)

(Front)

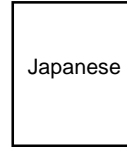

(Rear)

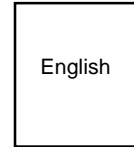

■ Installation Guide (Japanese/English)

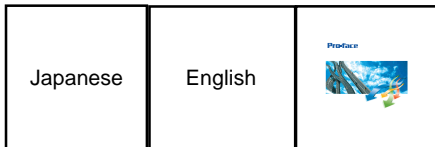

■ User Registration (Japanese/English)

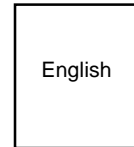
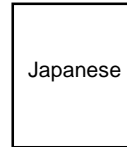

OPERATING ENVIRONMENT

■ Pro-Server with Pro-Studio for Windows

Item	Specification	Remark
Personal Computer	IBM Compatible	Pentium 133MHz or faster processor
Display	VGA (640 x 480) or higher	64 bit color or higher
Hard Disk Space Requirements	20 MB or more	30 MB or more is recommended
Memory Requirements	32 MB or more	128 MB or more is recommended
CD-ROM Drive	Windows compatible	
OS Requirements	Windows 95 (English or Japanese)	OSR2 or higher
	Windows 98 (English or Japanese)	
	Windows Me (English or Japanese)	
	Windows NT 4.0 (English or Japanese)	Service Pack 3.0 or higher
	Windows 2000 (English or Japanese)	
Related software	Microsoft Access 97 or later Microsoft Excel 97 or later Browser (IE V4.0 or later)	When using action contents
Supported languages	Japanese, English	
Printer	Any printers that your OS supports	
Mouse	Windows compatible	Mouse is required for operation.
Ethernet Board	10BASE-2/5/T, 100BASE-T	
Network Configuration	TCP/IP Protocol*2	Set up from Control Panel.
Additional Items	Ethernet Hub, Ethernet cables, etc.	User supplied

The following operating environment is required when you use the OPC Server.

Item	Specification	Remark
OS Requirements	Windows NT 4.0	Service Pack 3.0 or higher
	Windows 2000	
Hard Disk Space	100 MB or more	
Memory	64 MB or more	

MEMO

- Depending on the type of Ethernet hub used, Pro-Server may be unable to transmit data. Be sure to test and confirm the compatibility of Pro-Server with your Ethernet network prior to installing a complete Pro-Server with Pro-Studio for Windows system.
- When using a Switching Hub, if the GP and the Switch Hub are started at the same time, a communication error can occur. If the Switching Hub cannot be started first, Set the GP's [START TIME] to slow the start of the GP.

*1 You can not use this feature with the OPC Server.

*2 Until the TCP/IP protocol is set, Pro-Server with Pro-Studio cannot be used.

When installing and using the GP-Viewer, the following system environment is required.

Related Software	Microsoft Internet Explorer Ver. 5.0 or higher	Includes JavaVM (Ver.5.0.3176 or higher)
------------------	--	--

MEMO

- When using Microsoft Internet Explorer Ver. 5.0, some of the features may not display as desired. To solve this problem, please use Microsoft Internet Explorer Ver. 5.01 or later, in combination with the latest version of Microsoft Java VM. The latest versions of Microsoft Internet Explorer and Microsoft Java VM can be downloaded from Microsoft's homepage.
- When using GP-Viewer on a PC with GP-Web installed, please be sure the version of GP-Web is 1.5 or later.

■ 2-Way Driver

Hardware

Series Name		Product Name	Model	Built-in Ethernet Unit	External Ethernet Unit	Comment
GP77R series	GP-377R series	GP-377RT	GP377R-TC11-24V	X	○	*1
			GP377R-TC41-24V			
	GP-477R series	GP-477RE	GP477R-EG11			
			GP477R-EG41-24VP			
	GP-577R series	GP-577RS	GP577R-SC11			
			GP577R-SC41-24VP			
GP-577RT			GP577R-TC11			
		GP577R-TC41-24VP				
GP2000 series	GP-2300 series	GP-2300L	GP2300-LG41-24V	○	X	-
			GP2300-TC41-24V			
	GP-2400 series	GP-2400T	GP2400-TC41-24V			
			GP-2500 series*1	GP-2500L	GP2500-LG41-24V	○
	GP2500-SC41-24V					
	GP2500-TC11					
			GP2500-TC41-24V			
	GP-2501 series	GP-2501S	GP2501-SC11	X		
GP2501-TC11						
GP-2600 series*1	GP-2600T	GP2600-TC11	○			
		GP2600-TC41-24V				
GLC2000 series	GLC2300 series	GLC2300L	GLC2300-LG41-24V	○	X	-
			GLC2300-TC41-24V			
	GLC2400 series	GLC2400T	GLC2400-TC41-24V			
	GLC2600 series*1	GLC2600T	GLC2600-TC41-24V	○	○	*2
IT series	IT2400 series	IT2400 TypeA	IT2400-TC41-GP	○	X	-
			IT2400-TC41-GP200V			
		IT2400 TypeB	IT2400-TC41-GLC			
			IT2400-TC41-GLC200V			

MEMO

The Expansion Ethernet unit is required to use the 2-Way Driver with a GP77R series or a GP2501 series unit. Therefore, you cannot use the expansion units required protocol.

You cannot use both the 2-Way Driver and the Ethernet protocol together with a GP77R series on a GP2501 series unit.

Reference → “Pro-Server compatible PLC Vendors and Models”

Settings used will differ (IP Address Port No., etc.), depending on the type of Ethernet unit used, i.e. built-in type or expansion unit type.

Reference → “Using an Ethernet protocol with the 2-Way Driver”

*1 An expansion Ethernet unit (sold separately) is required.

*2 An expansion Ethernet unit (sold separately) and a bus conversion unit (sold separately) are required to use an external Ethernet unit.

■ Software

GP-PRO/PB III for Windows (Screen creation software)

Screen Creation Software	Language	Software Version	System Version			
			GP70	GP77R	GP377R	GP2000
GP-PRO/PB III for Windows	Japanese	Ver. 3.0	Ver. 1.51	Ver. 2.40	-	-
	ML	Ver. 3.0	Ver. 1.51	Ver. 2.40a	-	-
	Japanese	Ver. 4.0	Ver. 1.54	Ver. 2.60	Ver. 2.60	-
	Japanese/ML	Ver. 5.0	Ver. 1.55	Ver. 2.64	Ver. 2.64	Ver. 3.10
	Japanese/ML	Ver. 6.0	Ver. 1.55	Ver. 2.68	Ver. 2.68	Ver. 3.30

The following restrictions apply to Pro-Server and any related software.

Pro-Server and GP-PRO/PB III for Windows

Feature	Compatibility Requirement
GP screen capture (capturing JPEG files)	GP-PRO/PB III for Windows V6.0 or later
LS area extension	GP-PRO/PB III for Windows V6.0 or later
Online screen upload	GP-PRO/PB III for Windows V6.0 or later

■ Pro-Server compatible PLC Vendors and Models

Vendor Name	Device/PLC Type (in GP-PRO/PBIII for Windows)	GP/GLC Series			Comment
		GP77R GP-2501	GP-2000 GLC-2000	GP-2300 GLC-2300	
Mitsubishi Electric	MITSUBISHI MELSEC-AnN(LINK)	○	○	○	
	MITSUBISHI MELSEC-AnN(CPU)	○	○	○	
	MITSUBISHI MELSEC-AnA(LINK)	○	○	○	
	MITSUBISHI MELSEC-AnA(CPU)	○	○	○	
	MITSUBISHI MELSEC-A(JPCN1)	X	X	○	*1
	MITSUBISHI MELSEC-A(ETHER)	X	○	○	*2
	MITSUBISHI MELSEC-FX(CPU)	○	○	○	
	MITSUBISHI MELSEC-FX2(LINK)	○	○	○	
	MITSUBISHI MELSEC-QnA(LINK)	○	○	○	
	MITSUBISHI MELSEC-QnA(CPU)	○	○	○	
	MITSUBISHI MELSEC-Q(CPU)	○	○	○	
	MITSUBISHI MELSEC-Q(ETHER)	X	○	○	*2
	MITSUBISHI MELSEC NET/10	X	X	◆	*1 *3
Omron	MITSUBISHI FREQROL SERIES	○	○	○	
	OMRON SYSMAC-C SERIES	○	○	○	
	OMRON SYSMAC-CV SERIES	○	○	○	
	OMRON SYSMAC-CS1 SERIES	○	○	○	
	OMRON SYSMAC-CS1(ETHER)	X	X	X	*1 *3
Sharp	OMRON THERMAC NEO SERIES	○	○	○	
SHARP NewSatellite JW Series	○	○	○		
Yokogawa Electric	YOKOGAWA FACTORY ACE 1:1 Comm.	○	○	○	
	YOKOGAWA FACTORY ACE 1:n Comm.	○	○	○	
	YOKOGAWA FA-M3 (ETHER)	X	○	○	*2
Fuji Electric	FUJI MICRES-F SERIES	○	○	○	
	FUJI MICREX-F SERIES (FLT)	○	○	○	
	FUJI MICREX-F SERIES (T LINK)	X	X	○	*1
	FLEX-PC SERIES (LINK)	○	○	○	
	FLEX-PC SERIES (CPU)	○	○	○	
	FUJI INVETER	○	○	○	
	FUJI TEMPERATURE PXR	○	○	○	
Toyoa Machine Works	TOYOTA TOYOPUC-PC2 SERIES	○	○	○	
	TOYOTA TOYOPUC-PC2 1:n Comm.	○	○	○	
	TOYOTA TOYOPUC-PC3J SERIES	○	○	○	
	TOYOTA TOYOPUC-PC3J 1:n Comm.	○	○	○	
Yasukawa Electric	YASKAWA Memocon-SC SERIES	○	○	○	
	YASKAWA GL120/130 SERIES	○	○	○	
	YASKAWA PROGIC8 SERIES	○	○	○	
	YASKAWA GP9200SH SERIES	○	○	○	
Hitachi	HITACHI HIDIC-S10f _z SERIES	○	○	○	
	HITACHI HIDIC-S10f _z (JPCN1)	X	X	○	*1
	HITACHI HIDIC-H SERIES	○	○	○	
	HITACHI HIDIC-H2 SERIES	○	○	○	
	HITACHI HIZAC-EC SERIES	○	○	○	
Toshiba	TOSHIBA PROSEC-EX2000 SERIES	○	○	○	
	TOSHIBA PROSEC-T SERIES	○	○	○	
	TOSHIBA PROSEC-T(ETHER)	X	○	○	*2
Matsushita Electric Works	MATSUSHITA MEWNET-FP SERIES	○	○	○	
Koyo Electronics Industries	KOYO KOSTAC-SG8 SERIES	○	○	○	
	KOYO KOSTAC-SR21/22 SERIES	○	○	○	
	KOYO DL-305 SERIES	○	○	○	
	KOYO DL-205/405 SERIES	○	○	○	

Vendor Name	Device/PLC Type (in GP-PRO/PBIII for Windows)	GP/GLC Series			Comment
		GP77R GP-2501	GP-2000 GLC-2000	GP-2300 GLC-2300	
Toshiba Machine	TOSHIBA TC200 SERIES	○	○	○	
	TOSHIBA TC200-S SERIES	○	○	○	
GE FANUC Automation	GE FANUC SERIES 90SNP-X	○	○	○	
	GE FANUC SERIES 90-30/70SNP	○	○	○	
FANUC	FANUC Power Mate SERIES	○	○	○	
IDEC Izumi	IZUMI IDEC 1	○	○	○	
	IZUMI IDEC 2	○	○	○	
	IZUMI IDEC 3	○	○	○	
	IZUMI MICRO3	○	○	○	
	IZUMI FC3/FC4A SERIES	○	○	○	
Siemens AG	SIEMENS S5 90-115 SERIES	○	○	○	
	SIEMENS S5 135-155 SERIES	○	○	○	
	SIEMENS S5 3964R Protocol	○	○	○	
	PROFIBUS-DP	X	X	○	*1
	SIEMENS S7-200PPI	○	○	○	
	SIMATIC S7-300/400 via MPI	○	○	○	
	SIMATIC S7 via 3964/RK512	○	○	○	
Rockwell (Allen Bradley)	Interbus-SLAVE	X	X	○	*1
	SIMATIC 545/555 CPU	○	○	○	
	Allen Bradley PLC-5 SERIES	○	○	○	
	Allen Bradley SLC500 SERIES	○	○	○	
	AB Data Highway Plus	X	X	◆	*1 *3
	AB Slc500 DH485	◆	◆	◆	*3
	AB Remote IO	X	X	◆	*1 *3
Keyence	KEYENCE KV-10/16/24/40 SERIES	○	○	○	
	KEYENCE KZ300 SERIES	○	○	○	
	KEYENCE KZ-A500 SERIES(CPU)	○	○	○	
	KEYENCE KZ-A500 SERIES(LINK)	○	○	○	
Shinko Electric	SHINKO SELMART SERIES	○	○	○	
Matsushita Electric Industrial	Panadac 7000 SERIES	○	○	○	
	MINAS-A/S SERIES	○	○	○	
Modicon Corp.	Modicon Modbus(MASTER)	○	○	○	
	Modicon Modbus(SLAVE)	○	○	○	
	Modicon Modbus Plus	X	X	◆	*1 *3
FATEK	FATEK FACON FB	○	○	○	
ORIM VEXTA	ORIM VEXTA E1 SERIES	○	○	○	
Yamatake	YAMATAKE SCD SERIES	○	○	○	
Toho Electronics	TOHO TTM SERIES	○	○	○	
RKC INSTRUMENT	RKC CB/SR-Mini SERIES	○	○	○	
Shinko Technos	SHINKO TECHNOS INDICATING	○	○	○	
Other Device	DeviceNet Slave I/O	X	X	○	*1
	JPCN-1(Standard)	X	X	○	*1
	CC-Link Type	X	X	○	*1
	CC-Link Intelligent Device	X	X	X	*4
	Memory Link SIO Type	○	○	○	
	Memory Link Ethernet Type	X	○	○	*2

MEMO

Protocols before V1.2 can be used, however it cannot detect write errors.

*1 An expansion Ethernet unit is required to use the 2-Way Driver with GP77R/GP-2501 series units. The attachment of this unit prevents the attachment of any other expansion units, which in turn prevents the use of any other protocols.

Expansion units cannot be attached to GP-2300/GP-2400/GLC2300/GLC2400 series units. Therefore, you will not be able to use protocols that require expansion units.

*2 You cannot use both the 2-Way Driver and Ethernet protocols at the same time on GP77R/GP-2501 series units.

*3 You can use the 2-Way Driver together with listed protocols, however, there are device restrictions for Pro-Server access. Screens only need to be created for the devices that can be accessed.

Mitsubishi Electric	MELSEC NET/10	Supports only link devices and the LS area.
Omron	SYSMAC-CS1(ETHER)	Supports only the LS area.
Rockwell	AB Data Highway Plus	Supports only the LS area.
Rockwell	AB S1c500 DH485	Supports only the LS area.
Rockwell	AB Remote IO	Supports only the LS area.
Modicon Corp.	Modicon Modbus Plus	Supports only the LS area.

*4 This protocol cannot be used with the 2-Way Driver.

1 Introduction

This chapter describes how to use this software to configure a system in which you can gather data from devices/PLCs connected to networked GPs.

- 1.1 Outline
- 1.2 What is the 2-Way Driver?
- 1.3 System Configuration
- 1.4 Application Interface
- 1.5 Provider Information Outline
- 1.6 Overview of Data View
- 1.7 Configuring the System

1.1 Outline

The Pro-Server software reads/writes/collects data to and from PLC, and GP's data via a network (Ethernet). Pro-Server on your PC lets you use commercially available application software or programs you have created to read/write/collect data on the GPs and PLCs connected to the network.

It can also save and playback (Playback Feature) the saved data.

MEMO

The GP reads and writes data via the 2-Way driver only when it is not serving as a display and operation panel, which is its first priority. Also, reading or writing a large volume of data may cause the GP to temporarily stop refreshing its display.

1.2 What is the 2-Way Driver?

The 2-Way Driver is software that allows the host PC to access data on GPs or PLCs connected to a network (Ethernet). One advantage of this software is that you can transfer data to the host PC, regardless of type of PLC being used.

To use the 2-Way function, Pro-Server software and an Ethernet compatible GP unit are required.

1.3 System Configuration

1.3.1 External Configuration

- Pro-Studio allows you to easily designate a PLC device as a symbol.
- Designate a symbol using Excel, SCADA software, and VB applications, and Pro-Server can easily read that data out.

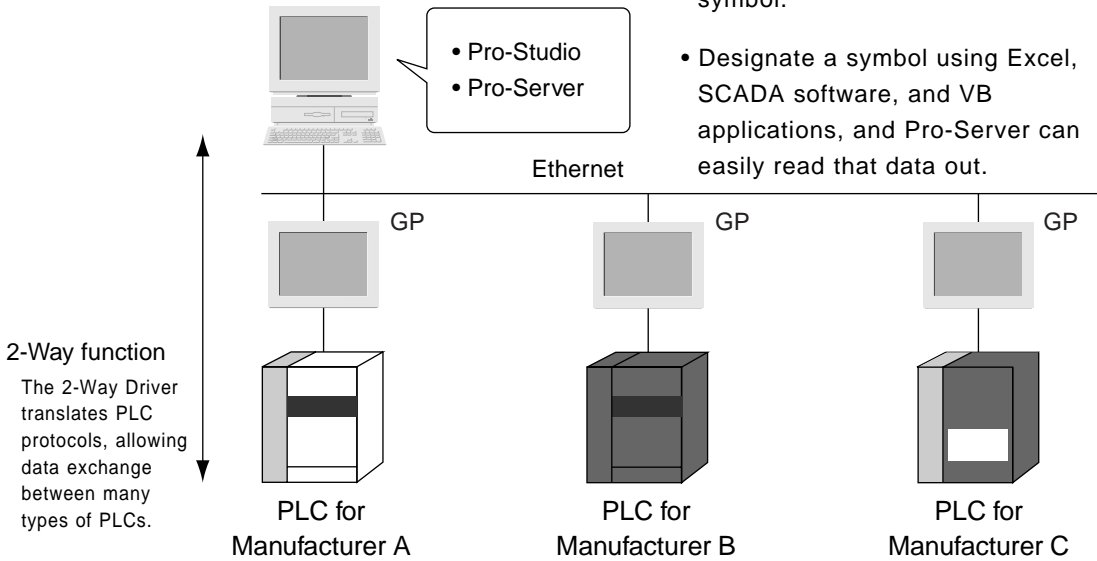

1.3.2 Internal Configuration

Off-line

Inside your PC, information such as node names of the connected GPs, symbol names for accessing the PLC devices, and information read from the GPs is all set up and controlled via this software. The file in which this information is stored is called a network project file (*.npj) and is used by Pro-Server for its data exchange with application programs.

To exchange data with the host PC, each GP must have the 2-Way Driver and the network project information downloaded to it, along with the GP's screen information, via GP-PRO/PBIII for Windows Ver. 3.0 or later. The 2-Way Driver is factory installed in the GP2000 and GLC2000 Series units.

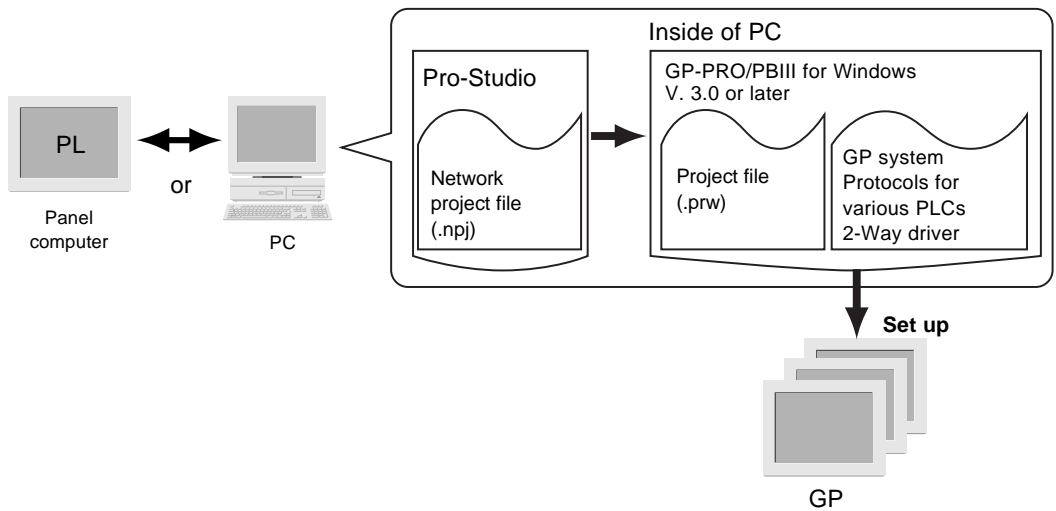

On-line

In response to an application's request, this software accesses PLC data, by way of the GP, using the network project file. Each GP must have the 2-Way driver downloaded to it, together with the protocol that corresponds to the connected PLC.

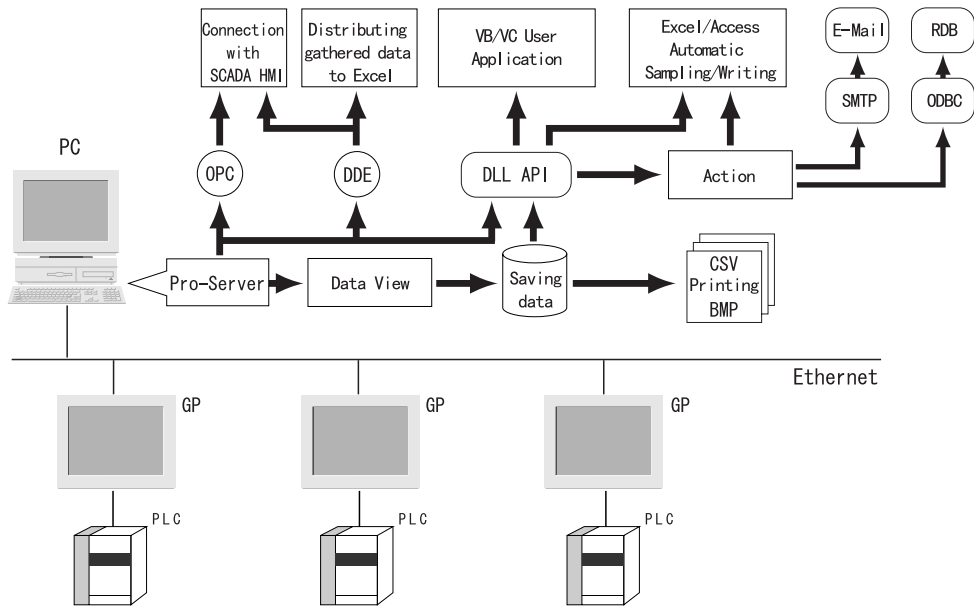

MEMO

- Transferring screen data in on-line mode or downloading a network project file, will temporarily cause the Transfer screen to appear and all other data transfer operations to stop.
- After screen transfer is completed, the screen will re-activate and regular operation will resume.

Pro-Studio (Performs Network project file editing/setting)

This software is used to set and register symbols for the GPs and PLCs designated as data providers.

Physical IP addresses, PLC device addresses, etc. can all be converted into symbols.

Pro-Server (Performs Data exchange between applications and GPs)

This software that communicates with GPs according to the requests made by Excel, VB, SCADA or other applications.

2-Way Driver (Protocol conversion driver built into GPs)

This driver selects the applicable PLC protocol, based on the Pro-Server read/write command. GP77R series units requires setup and then transfer to the GP unit via the screen editor software GP2000 and GLC2000 series unit 2-Way Driver software is factory installed.

Using an Ethernet protocol with the 2-Way Driver

Pro-face's GP2000 (GP-2501 does not support this function) and GLC2000 Series units can simultaneously use an Ethernet communication protocol and the 2-Way Driver feature to communicate with a PLC. However, the IP address and the Port No. used for differ depending on whether the internal Ethernet I/F or the Expansion Ethernet I/F is used.

When using the GP/GLC Unit's Internal I/F

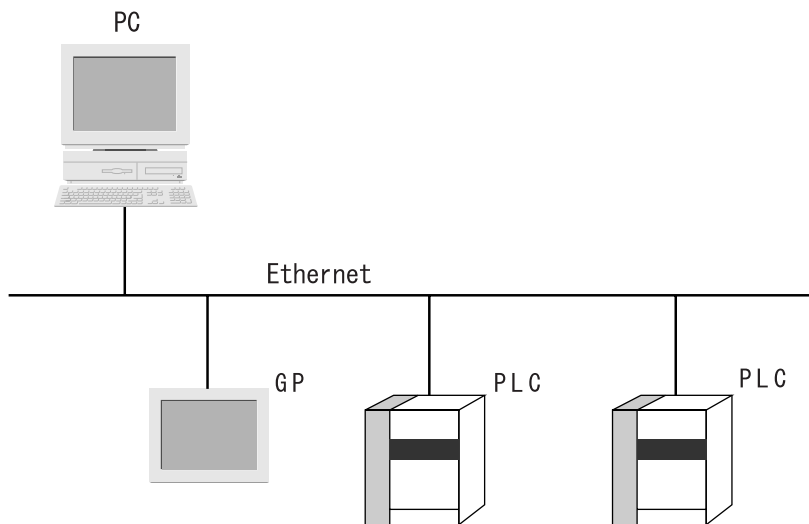

Using the GP/GLC's internal Ethernet I/F to communicate with a PLC allows you to also use the 2-Way Driver feature. However, while you will need only one IP Address, you will need to designate two Port No.s. One will be for when you transfer data to a PLC, and the other will be when using the 2-Way feature.

In order to transfer data to a PLC, you will need to enter your GP/GLC unit's Ethernet settings via the OFFLINE mode's [INITIALIZE] -> [PLC SETUP] -> [PLC SETUP] -> [SETUP ETHERNET INFORMATION] screen. However, the Subnet Mask and IP Address must be entered in the [PLC SETUP] -> [SETUP ETHERNET EXT. INFORMATION] screen. This data must also be entered in the GP-PRO/PBIII for Windows software's Project Manager screen [GP Setup] menu's [Communication Settings] tab.

The entering of Ethernet settings for communication using the 2-Way Driver feature is done via the previously mentioned OFFLINE mode. Select the [INITIALIZE] -> [PLC SETUP] -> [EXPANSION SETTINGS] -> [ETHERNET SETUP] area, and enter the required setting data there. You need to also enter the required settings in the Pro-Studio program's [Register/Edit Node] area, and the [Port No.] in the [Configure] -> [Network] area.

The following table describes what each setting is used for.

Setting	PLC Transfer Settings	2-Way Driver Settings	Remarks
IP Address	O	X	These settings apply to a single Ethernet I/F and only one setting value can be entered. When the PLC Transfer Settings are not entered, the 2-Way Driver Settings will be enabled.
Subnet Mask	O	X	
Gateway (IP Route Address)	O	X	
Port No.	O	O	Be sure the Port No.s used are not the same. Port numbers are allocated continuously for a total of 10 No.s, starting from the 2-Way Driver Port No. entered.

O: Setting enabled X: Setting disabled

When using the GP/GLC Unit's Rear Face Expansion Ethernet I/F

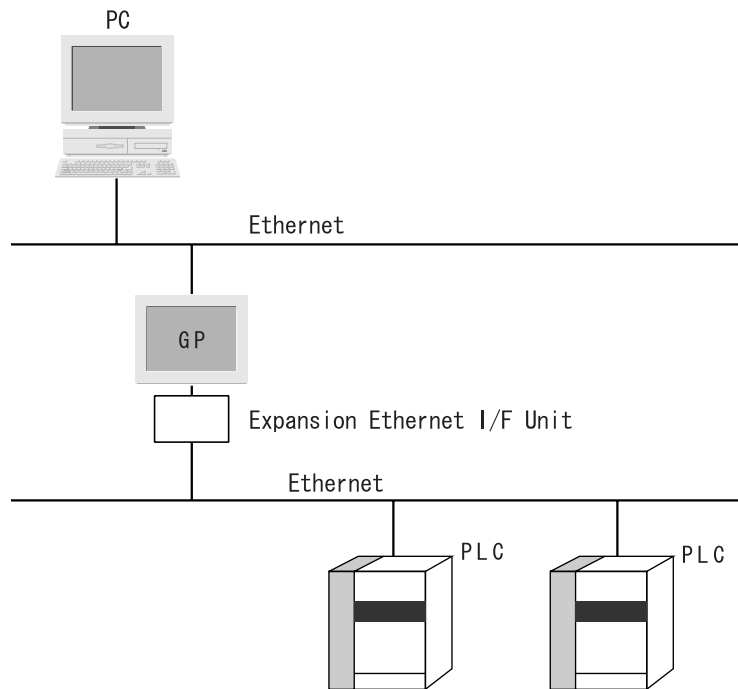

After attaching the Expansion Ethernet I/F Unit, your GP unit is now equipped with two Ethernet I/F units. (The Ethernet Expansion Unit cannot be used with the GP-2300, GP-2400, GLC2300 or GLC2400 series units.)

The Expansion Ethernet I/F Unit is used for PLC data transfer and the internal Ethernet I/F is used for data transfer via the 2-Way Driver.

Use of the Expansion Ethernet I/F Unit will require the setting of a separate IP Address.

In order to transfer data to a PLC, you will need to enter your GP/GLC unit's Ethernet settings via the OFFLINE mode's [INITIALIZE] -> [PLC SETUP] -> [PLC SETUP] -> [SETUP ETHERNET INFORMATION] screen. However, the Subnet Mask and IP Address must be entered in the [PLC SETUP] -> [SETUP ETHERNET EXT. INFORMATION] screen. This data must also be entered in the GP-PRO/PBIII for Windows software's Project Manager screen [GP Setup] menu's [Communication Settings] tab.

The entering of Ethernet settings for communication using the 2-Way Driver feature via the internal Ethernet I/F is done using the GP unit's previously mentioned OFFLINE mode. Select the [INITIALIZE] -> [PLC SETUP] -> [EXPANSION SETTINGS] -> [ETHERNET SETUP] area, and enter the required setting data there. Also, enter the required settings in the Pro-Studio program's [Register/Edit Node] area. Also, enter the [Port No.] in the [Configure] -> [Network] area.

The following table describes what each setting is used for.

Setting	PLC Transfer Settings	2-Way Driver Settings	Remarks
IP Address	O	O	The PLC communication settings used are allocated to the Expansion Ethernet I/F Unit, and the 2-Way Driver settings are allocated to the GP's internal Ethernet I/F.
Subnet Mask	O	O	
Gateway (IP Route Address)	O	O	
Port No.	O	O	

O: Setting enabled X: Setting disabled

1.4 Application Interfaces

1.4.1 DDE function Outline

The DDE (Dynamic Data Exchange) function can be used with your PC's commercial applications (SCADA or MMI software) and Excel, which supports the DDE client function that provides for program-less data exchange.

Once a DDE link is established, Pro-Server monitors the internal data and, if a stored value changes, notifies the client of the change. Pro-Server provides the client with the data being monitored when a read-out request is received and writes the data when a write request is received.

DDE function

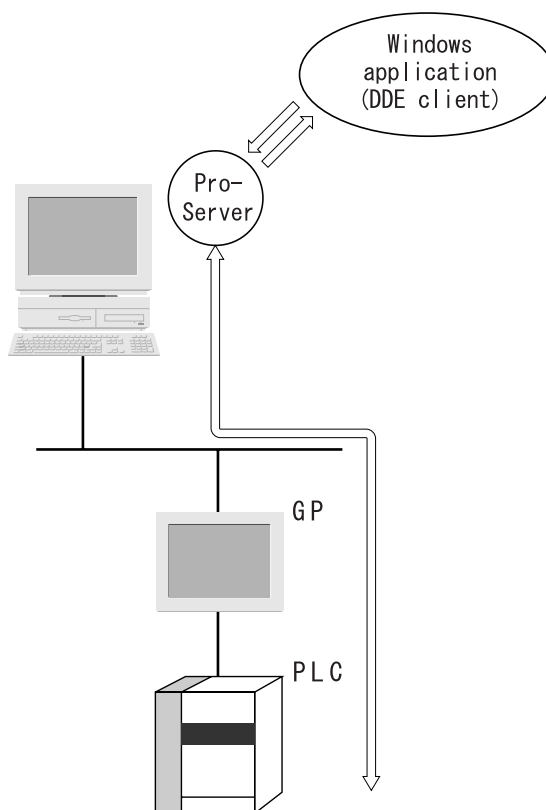
**MEMO**

Excel's client feature does not support data write, so the DDE's write feature cannot be used. When writing data using Excel, please use the VBA feature.

1.4.2 Simple DLL Function

The applications you create with Visual Basic or Visual C will request Pro-Server to read/write PLC data via a GP. The function (API) for this is provided in the form of a DLL. In both read and write operations, the function will not be completed until communication between the two units is finished.

Simple DLL Connection

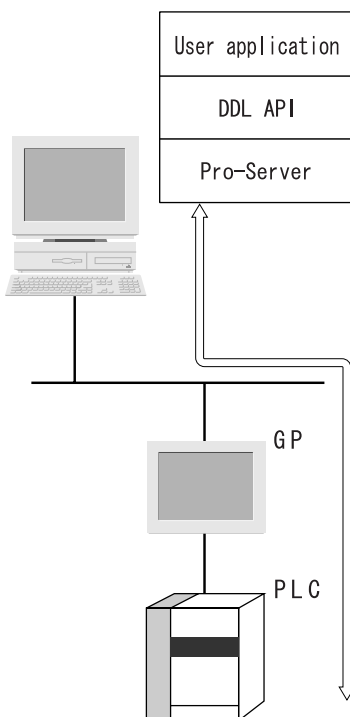
**MEMO**

In environments where data transfer errors can frequently occur, be sure your applications include a data transfer retry feature.

1.4.3 OPC Interface Function

Installing a Pro-Server OPC server allows you to use applications that have an OPC client function, such as Intellution's iFIX, as well as others.

The OPC interface function can only be used on a Windows NT or Windows 2000 system.

OPC Interface Design

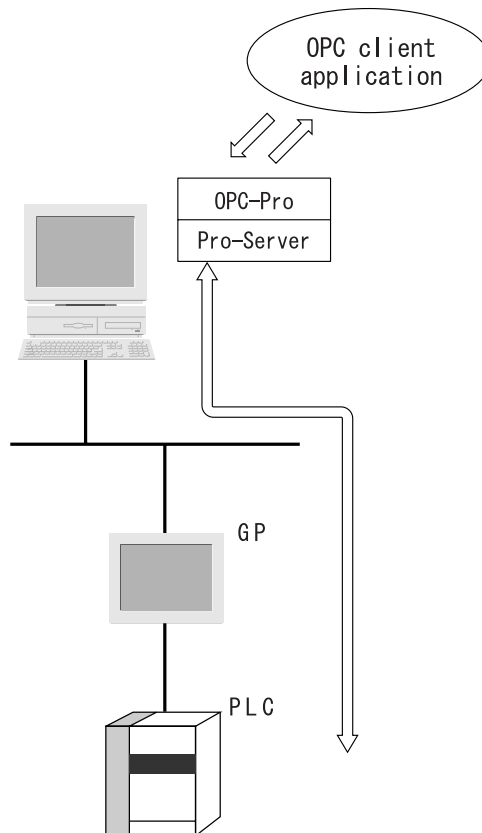

1.4.4 SRAM Backup Data Storage Function

The backup data in the SRAM of each GP can be easily transferred to the host PC. This SRAM backup function is available for logging data, trend data, sampling data, alarm data (log/history), and others.

SRAM Backup Function

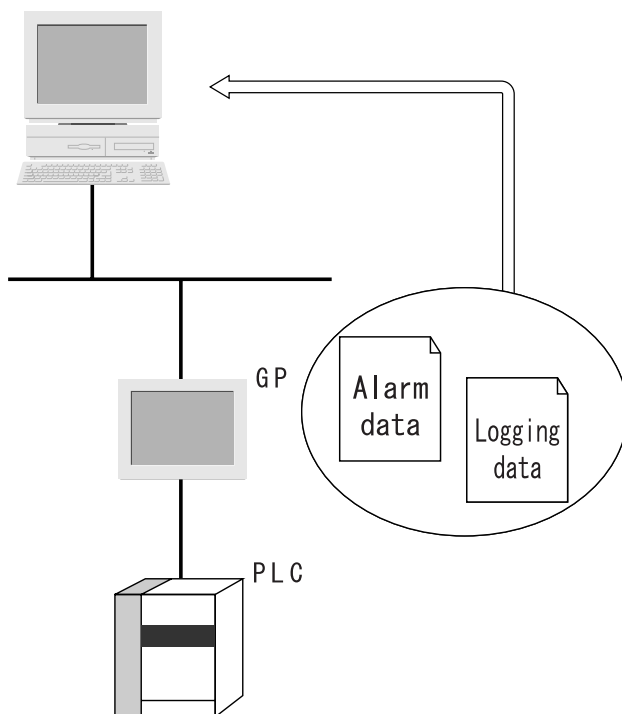

For details about the types of data you can transfer to the host PC, refer to the GP-PRO/PBIII for Windows Tag Reference Manual.

Reference → “GP-PRO/PBIII for Windows Tag Reference Manual”

MEMO Alarm data (active) can be captured on Pro-Server using an alarm block.

1.5 Provider Information Outline

1.5.1 Providing Information to the Host

When a designated trigger's condition(s) is/are satisfied, PLC data is first translated by the GP's resident 2-Way driver using the appropriate PLC manufacture's protocol, then collected by Pro-Studio and provided to the host PC. Therefore, since Pro-Server can temporarily store this data in the PC's memory, overall network traffic can be reduced.

For the procedure to register symbols in Pro-Server's PC memory area, refer to 3.2 Registering Symbols.

Reference → "3.2 Registering Symbols"

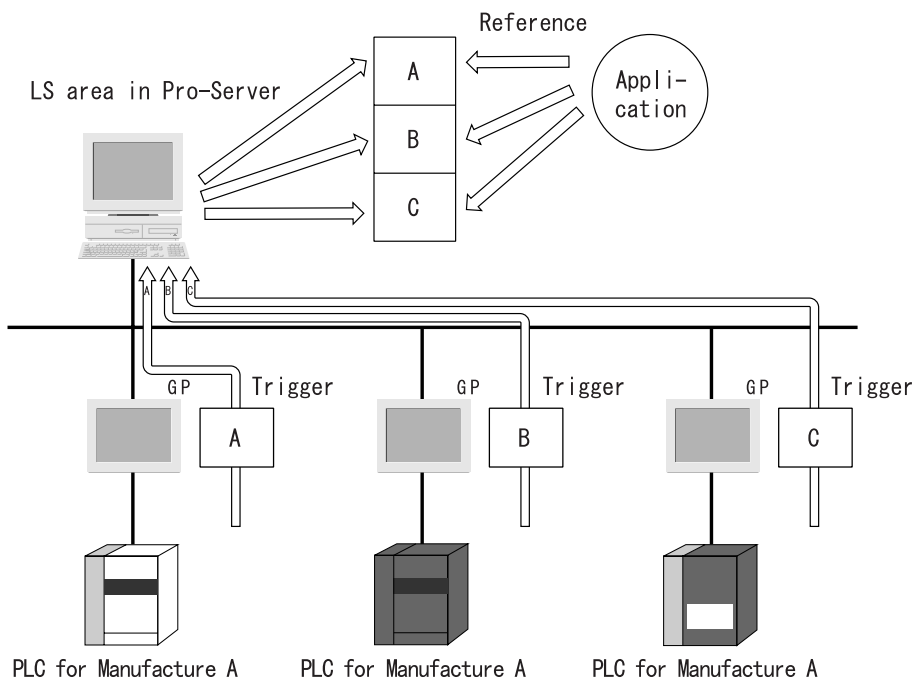

1.5.2 Providing Information between GPs

Even if your system lacks a host PC or Pro-Server, you can transfer the provider information setting file setup in Pro-Studio to each GP. This then allows device data to be exchanged, via the GP, between PLCs on the network, at a predetermined times or event, regardless of the brand of PLC used.

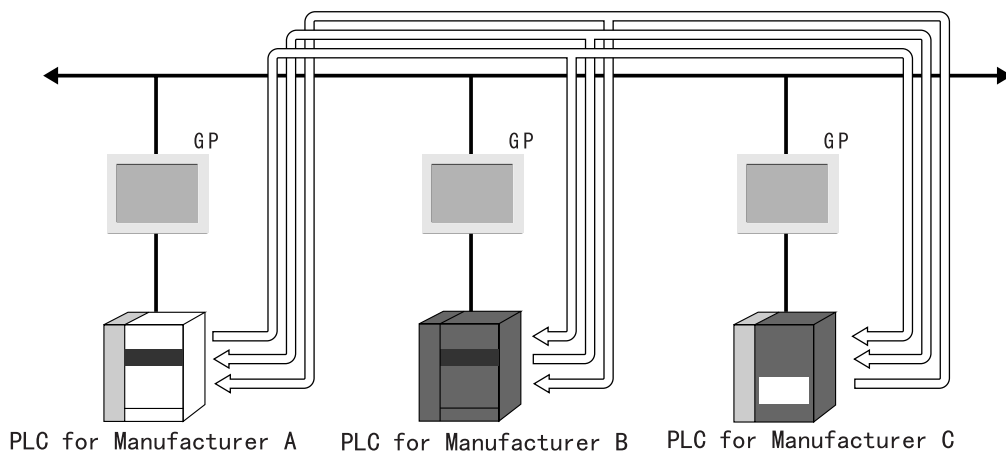

1.5.3 Action Feature Overview

When the designated trigger conditions are fulfilled, an “Action” feature allows an application in a remote PC on the network to be activated. Also, the program triggered by the Action feature is called the “Action Contents” .

Action Features

- Automatic Upload of Access Data (requires Microsoft Access)
- Automatic Download of Access Data (requires Microsoft Access)
- Write Data to Excel Book (requires Microsoft Excel)
- Download of Excel Recipe (requires Microsoft Excel)
- Upload of GP Log Data
- Automatic Download of GP Filing Data
- Automatic Upload of GP Filing Data
- Data Transfer via Mail
- Alarm Log (with Sound Alert Feature) (requires Microsoft Access)
- Data Upload to Database (requires Microsoft Access/Excel)
- Data Download from Database (requires Microsoft Access/Excel)
- Start Application
- Upload of GP JPEG Data

Action Feature Overview

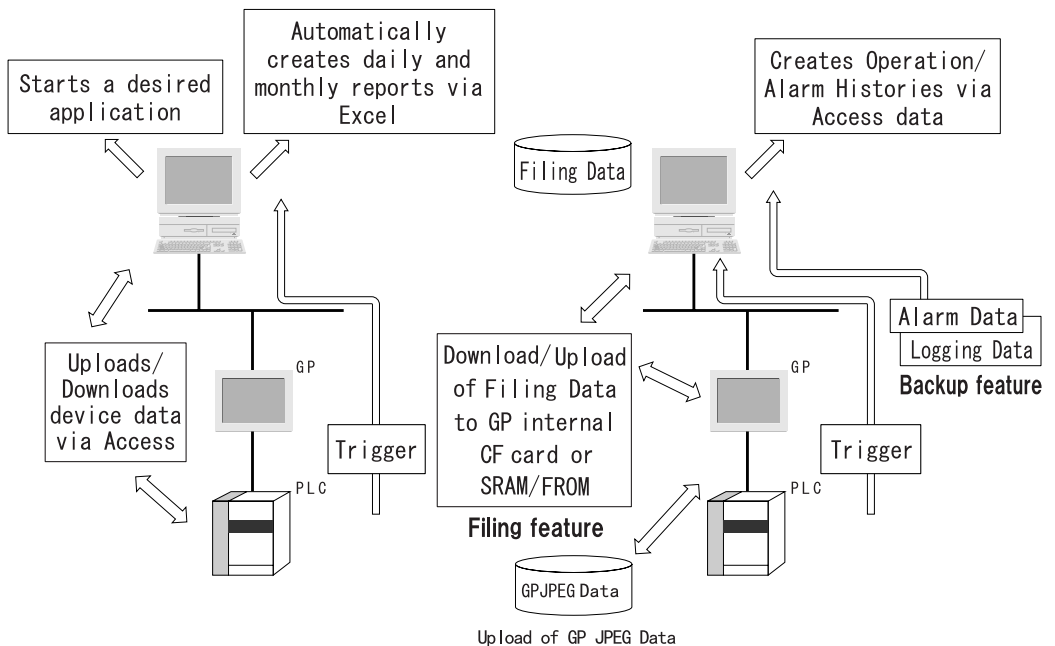

1.6 Overview of Data View

When a designated trigger's condition(s) is/are satisfied, PLC data is first translated by the GP's resident 2-Way Driver using that PLC's protocol, and then is collected by Pro-Studio and saved on the server PC. Data View allows you to display the collected data on Pro-face's exclusive browser (GP-Viewer, Device View) in real-time. You can also change the data collection condition or set the synchronization style with GPs (GP-Viewer only) using Data View. Device data of multiple PLCs can be collected at the same time (Device View only).

In addition to the above, you can playback device data already collected on Data View (Playback Feature) or on user-created applications (System Time Bar).

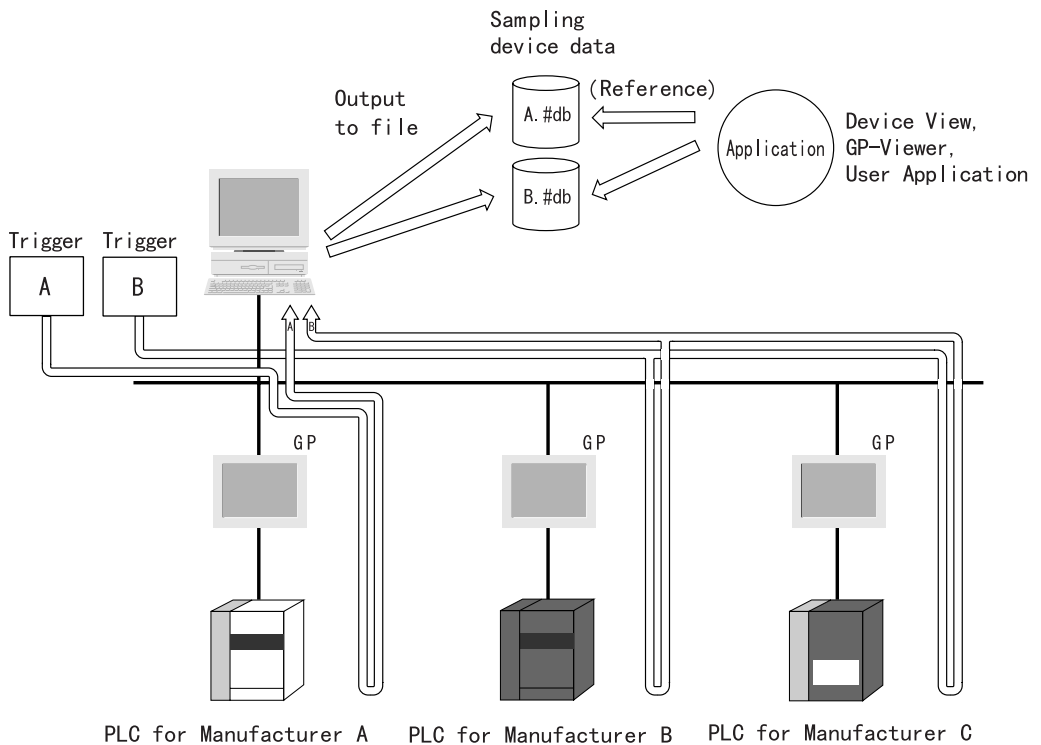

MEMO

Collected device data can be viewed using a variety of tools, such as Device View and GP-Viewer.

1.7 Configuring the System

The following explanation describes the steps you must follow to start Pro-Server, and assumes that GP-PRO/PBIII is already installed on your PC.

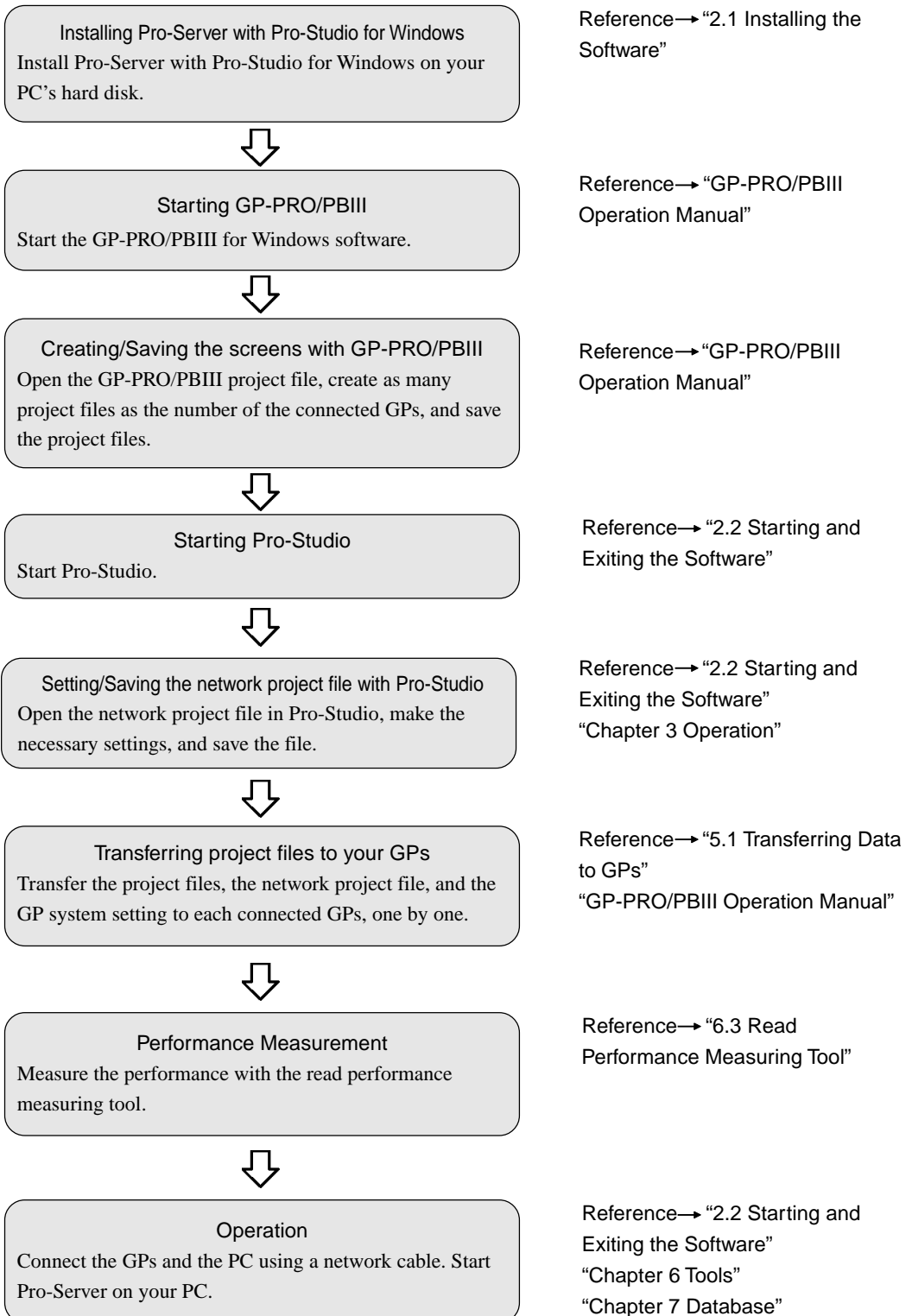

2 | Pro-Server Fundamentals

This chapter describes how to install this software. It also explains the procedures for starting and exiting the software.

- 2.1 Installing the Software
- 2.2 Starting and Exiting the Software
- 2.3 Screen Item Names and Functions

2.1 Installing the Software

Install this software from the CD-ROM to your hard disk. The following explanation assumes that Windows is already installed on your hard disk.

MEMO

- Prior to installing the software, exit all programs except the Pro-Server with Pro-Studio for Windows Setup program. Be sure to quit all memory-resident programs (such as Virus detection software).
- If an older version of this software is currently installed on your PC, be sure to uninstall it prior to installing this software.
- Copying the master CD-ROM files to your hard disk does not install this software. To be able to start this software, you must use the Setup program (step 2 below).

1. Insert the CD-ROM into your PC's CD-ROM drive.
2. Click the [Start] button and, when the Start menu appears, select [Run].



3. Type "X:/2WSetup.exe" and then click [OK]. ("x" represents the drive letter assigned to your CD-ROM drive.)

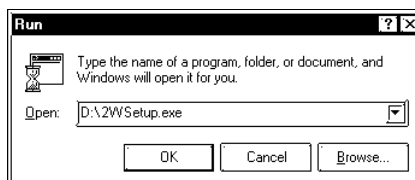

The master CD-ROM supports the AutoPlay feature, which means inserting it into your CD-ROM drive will automatically start the Setup program.

- The installation menu appears. Click the "Pro-Server with Pro-Studio Setup" bar.

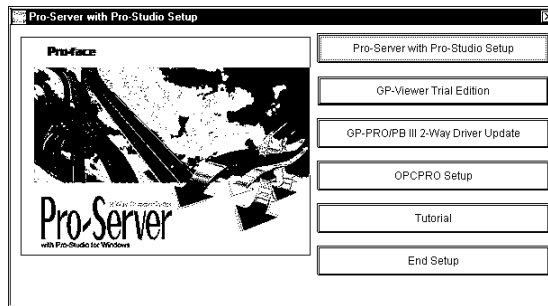

- Select which language you wish to use in the Setup program (English or Japanese) and click "OK".



- The User Information screen will appear. Enter all the information and click the [Next] button.

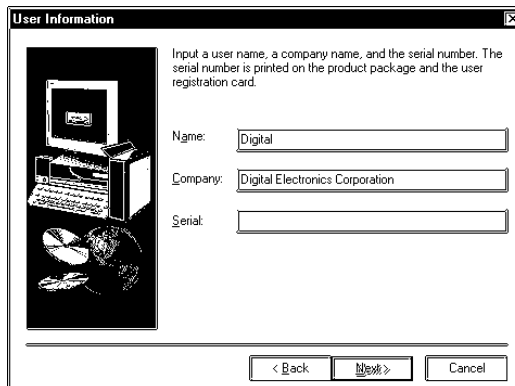

7. The key code entry screen then appears. Enter the code printed on the rear of your CD-ROM case and click [Next].

The data entered must also include the “-” character.

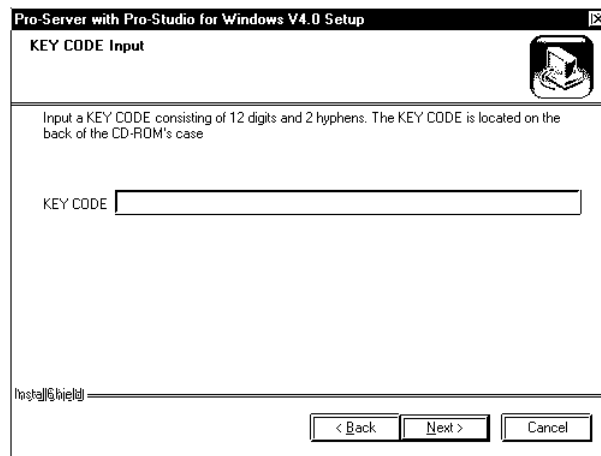

After this, follow the instructions displayed on the screen.

In addition to the Pro-Server with Pro-Studio for Windows program, the “2Wsetup.exe” command can be used to start the following items.

- GP-PRO/PBIII 2-Way Driver Update

As GP-PRO/PBIII for Windows Ver. 6.0 software includes the 2-Way Driver for Pro-Server with Pro-Studio for Windows Ver. 4.0, the driver requires no update.

If you use an earlier version of GP-PRO/PBIII for Windows, update your software to a 2-Way Driver compatible with the Pro-Server with Pro-Studio for Windows Ver. 4.0.

- OPCPRO Setup

Two types of OPCs, for the server and for the client, can be installed via this item.

Be sure to install the OPC server in a personal computer running this software.

- Tutorial

The tutorial uses HTML files to explain the installation, setup and usage of the Pro-Studio software.

- GP-Viewer Trial Version Setup

Install the GP-Viewer after Pro-Server installation is completed.

2.2 Starting and Exiting the Software

This section describes how to start and exit this software.

2.2.1 Starting and Using Pro-Studio

The following explanation assumes that the Windows desktop is already displayed.

1. Click [Start] button and when the Start menu appears, point to [Programs], [Pro-face] and [Pro-Server with Studio], and select [Pro-Studio].

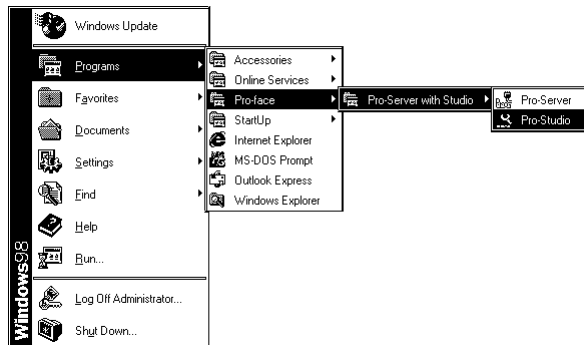

Double-clicking on the desired network project file (*.npj) in Windows Explorer automatically starts Pro-Studio.

2. The program's main window will appear. The left-side window shows a list of network entry node GPs; the right-side window shows the symbols registered for each GP. Use this screen to enter a variety of settings to configure your system.

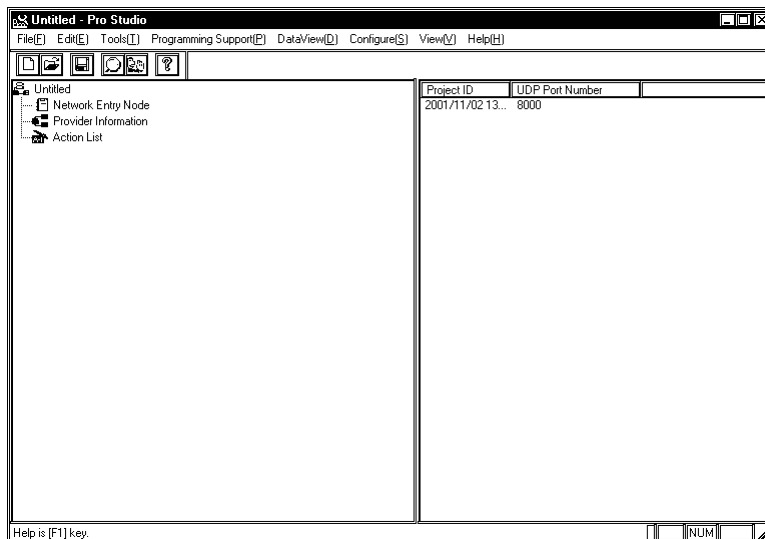

MEMO

- Starting Pro-Studio automatically starts Pro-Server. Pro-Server resides in memory and its indicator appears on the right side of the taskbar.
- Quitting Pro-Server automatically exits Pro-Studio as well.

To start Pro-Server only, click the [Start] button and, when the Start menu appears, point to [Programs], [Pro-face] and [Pro-Server with Studio] and then click on [Pro-Server].

Creating a Network Project File

A network project file (*.npj file) stores information such as the network entry nodes, symbols, and provider information settings.

Creating a New Network Project

The following explains how to open a window and create new network projects.

1. Select [New(N)] in the [File(E)] menu.

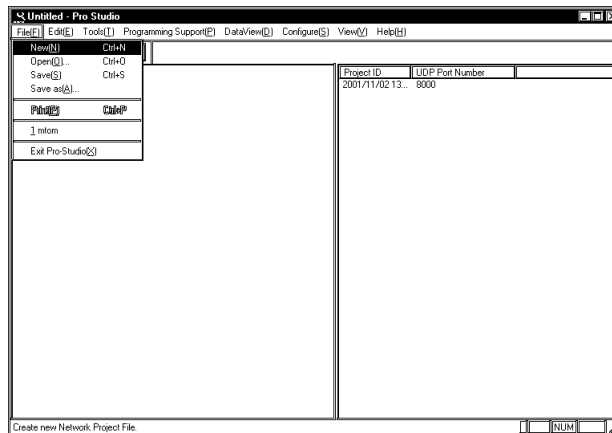

Opening/Saving a Network Project File

The following procedures explain how to open, close, and save a network project file. Before you proceed, open the Pro-Studio main window.

Opening a Network Project File

1. In the program's main window, click [Open(O)] in the [File(E)] menu.

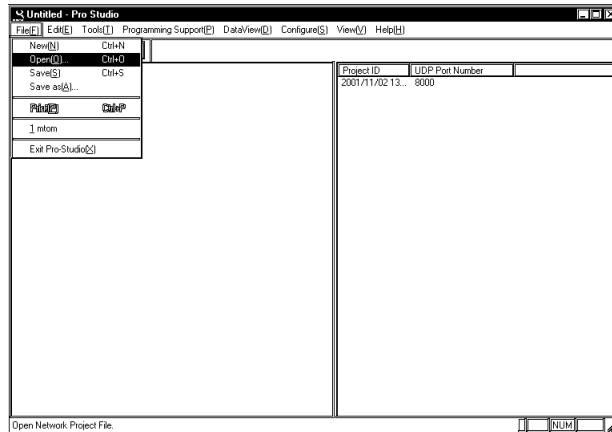

2. Select the file you wish to open, and click [Open(O)].

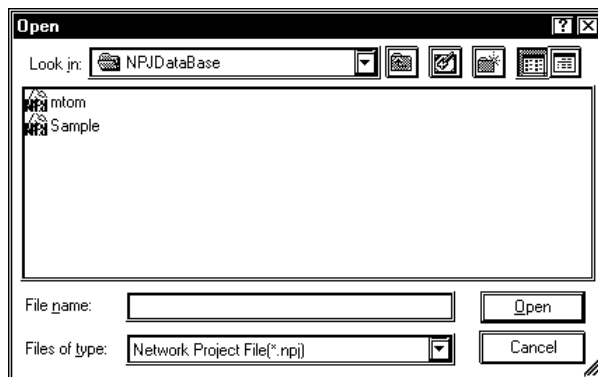

3. The file opens.

Saving a Network Project File

1. In the program's main window, click [Save(S)] or [Save as(A)] in the [File(E)] menu.

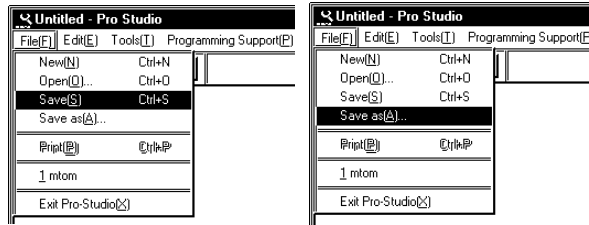

2. If you have selected [Save(S)], the file is saved by overwriting the existing contents. If you have selected [Save as(A)], in the following dialog box, save the file with a new file name.

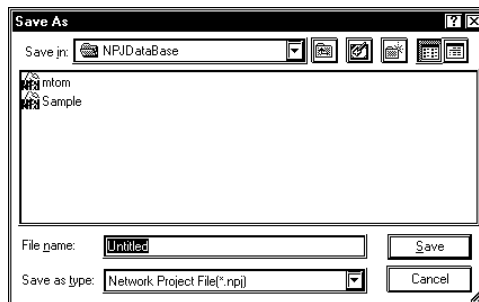

2.2.2 Exiting Pro-Studio

The following describes the procedure for exiting Pro-Studio.

1. Click [Exit Pro-Studio(X)] in the [File(F)] menu.

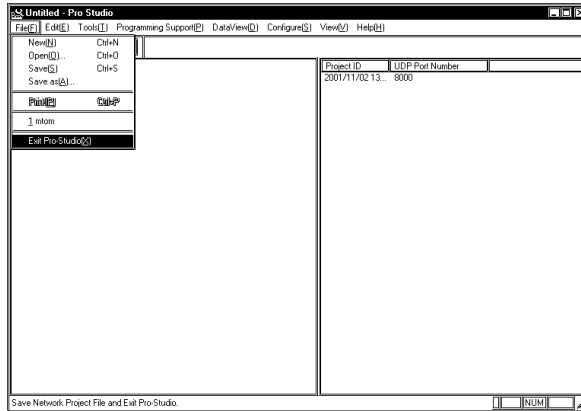

MEMO

- If you change the settings of a currently open project and then attempt to close it, you will be asked whether or not to save the new settings. Clicking [Yes] saves the settings by overwriting the existing contents, and then exits Pro-Studio. Clicking [No] exits Pro-Studio without saving the changes.
- Exiting Pro-Server automatically closes Pro-Studio. To be sure to terminate all communication, be sure to exit Pro-Server.

2.2.3 Starting and Exiting Pro-Server

The following explanation assumes that the Windows desktop is already displayed.

Starting Pro-Server

1. Click the [Start] button and, when the Start menu appears, point to [Programs] [Pro-face] and [Pro-Server with Studio], and then click [Pro-Server].

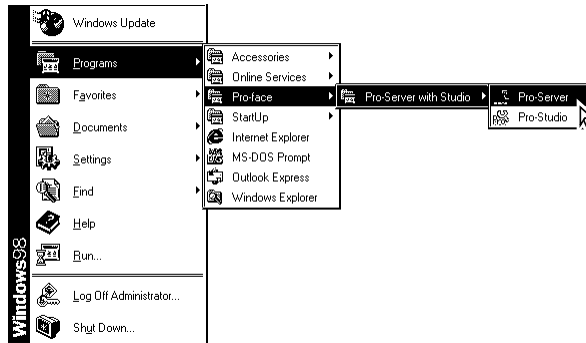

2. While Pro-Server is running, the Pro-Server icon appears on the right side of the task tray.

**MEMO**

Starting Pro-Studio automatically starts Pro Server.

Exiting Pro-Server

1. To exit Pro-Server, right-click on the Pro-Server icon on the right side of the task tray.

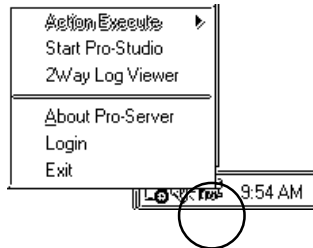

2. When the shortcut menu appears, click [Exit].



MEMO

- Exiting Pro-Server automatically exits Pro-Studio.
- If an application uses Pro-Server as a DDE client, an alarm message will appear before you exit this software.
- An alarm message dialog will appear when you try to exit Pro-Server while it is collecting data.

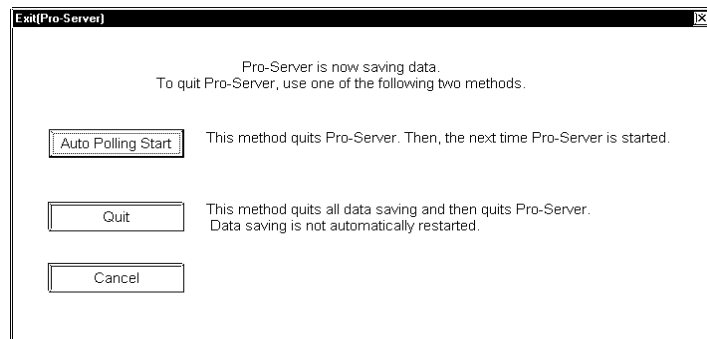

2.3 Screen Item Names and Functions

The names and functions of Pro-Studio's main screen items are as follows:

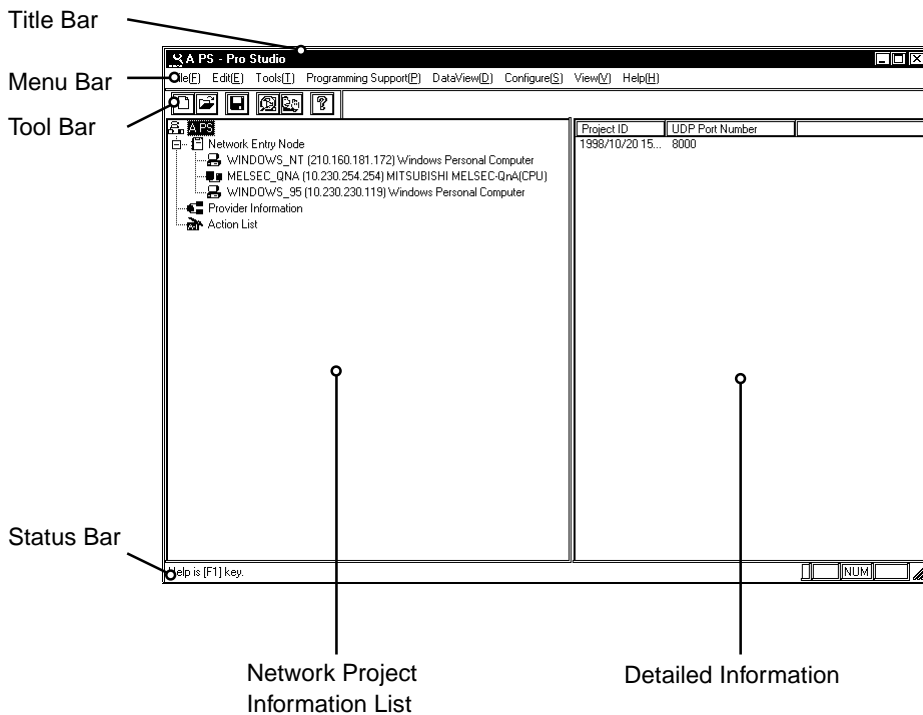

Title Bar

Displays the currently open network project file (*.npj)'s name.

Menu Bar

Displays the menu to be used to operate Pro-Studio. Use the mouse or keypad to select a desired menu, and the pull-down menu appears.

Tool Bar

Displays icons that represent frequently used commands. Click on an icon to execute that command.

Status Bar

Displays operation-related messages and other information.

Network Project Information List

Displays the currently open network project file's contents in a tree structure.

Detailed Information

Displays network project information list, nodes, symbols, and actions.

3 | Operation

This chapter describes how to register various types of system information.

- 3.1 Registering Network Entry Nodes
- 3.2 Registering Symbols
- 3.3 Registering Provider Data
- 3.4 Using the DDE Function
- 3.5 Using the VBA Support Function
- 3.6 Saving Backup Data in SRAM
- 3.7 Device Data Backup and Restoration
- 3.8 GP Capture Data Saving Function
- 3.9 Security Function
- 3.10 Configuring the System
- 3.11 Configuring the Network
- 3.12 Printing the Setting Data

3.1 Registering Network Entry Nodes

The procedure for entering the node name, IP address, sub net mask, gateway, and PLC type information is described below. The node name can be the same as the project file name with the PLC type automatically determined by selecting GP-PRO-PB III's project file (*.prw). To transfer provider data from a GP to the PC, you must first register the PC as a network entry node.

(The following description assumes that Pro-Studio's main window is open)

1. Select [Register Node] in the [Edit(E)] menu.

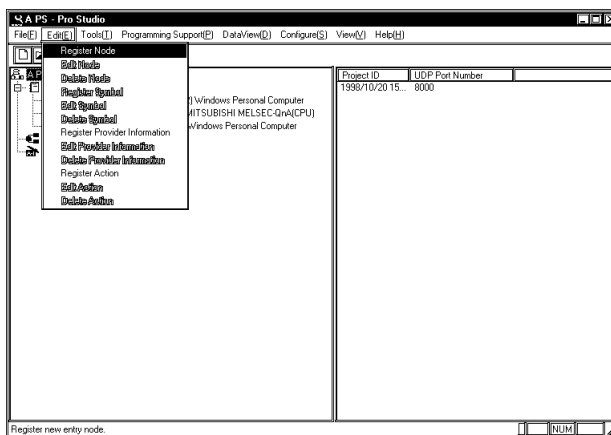

You can right-click on the network entry node and select [Register Node] from the shortcut menu that appears.

- The [Register Node] window will appear. Enter the necessary data for all the items and click [OK]. Designate [Gateway] only when required. Designate [IP Address] so that it does not overlap with any other addresses.

A “Node” indicates a name of a communicator that performs communication activities on the network, which is usually a GP unit or personal computer. This node name must:

- Consist of 31 characters or less.
- Begin with an alphabetic letter.
- Use alphanumeric characters (no differentiation between upper and lowercase letters), _ (underscore), ~ (tilde), and 80h or higher ASCII characters.

MEMO

- Select the GP-PRO/PBIII for Windows project file (.prw) you wish to use.
- You may also drag the file from Windows Explorer and drop it in the Pro-Studio's main window.

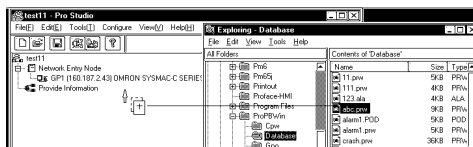

MEMO

The character string data mode is set according to the data storage order of the used PLC. Normally, it is automatically set to the mode according to the data storage order of the used PLC, therefore, you do not have to change it.



(I) Device Storage Order of Data	(II) Byte LH/HL Storage Order in Word	(III) Word LH/HL Storage Order in Double-Word	Character String Data Mode
Store from the front data	LH	LH	4
		HL	2
	HL	LH	5
		HL	1
Store from the end data	LH	LH	6
		HL	7
	HL	LH	8
		HL	3

The detailed settings of the selected network entry node are shown in the right-side window.

- After registration is completed, the registered node name will be added to the network node list.

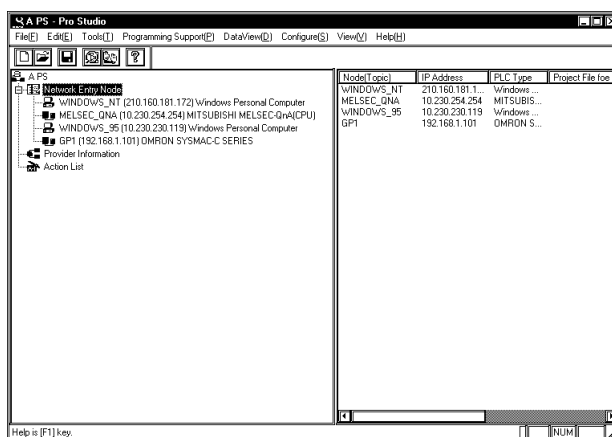
If you wish to change a node (topic)'s data after it has been registered, simply right-click on the topic to bring up a list of selections. From these, click either the [Edit Node] or [Delete Node] selections, or, from the menu bar, click the [Edit] menu's [Edit Node] or [Delete Node] items.

**MEMO**

Clicking either  or  allows you to edit the registered nodes, in the order of registration. When  is clicked on while the last registered node is highlighted, the “edit” mode will change to the “add” mode and a new node will be added.

3.2 Registering Symbols

The following describes how to enter symbol name, device address, data type, and polling time data. The device address you enter will be converted internally into a device code that can be used inside the GPs. Polling time refers to how often Pro-Server polls the GP when data is read out through a DDE. You may also import symbols that have been exported from GP-PRO/PBIII. Symbols can be registered for each network entry node.

(The following description assumes that the program's main window is open)

1. Click on the right section of the window. Or, click on the right-side window and then click [Register Symbol] in the [Edit(E)] menu.

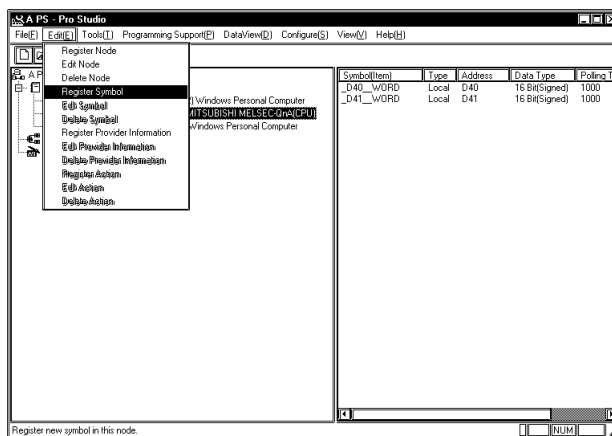

2. The [Register Symbol] window then appears. Enter all items and click [OK].

A symbol must

- Consist of 31 characters or fewer.
- Begin with an alphabetic letter.
- Use alphanumeric characters (no differentiation between upper and lowercase letters), _ (underscore), ~ (tilde), and 80h or higher ASCII characters.

[Create from Address]

After selecting a Device Address, click on this button to automatically register the Device Address as a symbol.

You can use up to 27 names as PC exclusive device names, that is, LS, LSA, LSB, LSC, LSD ... LSY and LSZ. The device address ranges from 0000 to 9999 in Word Address, using in Decimal. The bit values range from 00000 to 9999F, which designates the first four (4) digits in Decimal, then the last digit in HEX.

MEMO

The PC exclusive LS area can also be used for the setup area of the simple DLL function, the provider function or the action item function.

[Global Symbol]

Clicking on the Global Symbol check box automatically designates the same symbol for all of the registered network nodes. This setting will be ignored if the device specified by the symbol does not

exist in the registered network nodes.

[Polling Time]

The data here shows an example of data being read out via the DDE feature. Under certain conditions the polling time used for collecting or writing data for each symbol, distributing data and monitoring devices may not be performed.

These conditions include the number of currently registered GPs, number of Tags used on each screen sent, type of PLC connection, and number of other currently open Windows applications.

Entering “0” will allow the system to operate at maximum speed. Use this value as a benchmark when entering other values to “fine-tune” your system.

3. When all settings are selected, the detailed settings appear in the right-side window.

If you wish to change a symbol’s data after it has been registered, simply right-click the symbol name (right-window) to bring up a list of selections. From these, click on either the [Edit Symbol] or [Delete

Symbol] selections, or, from the menu bar, click on the [Edit (E)] menu's [Edit Symbol] or [Delete Symbol] items.

3.2.1 Importing Symbols

This section describes how to import symbols. The usable symbol data include symbols imported from GP-PRO/PBIII (*.lbe), symbols exported from other network project file (*.2ws), and comment data (*.csv) from GPP function software for Windows (Mitsubishi Electric).

1. Click [Import Symbol] in the [Tools(T)] menu.

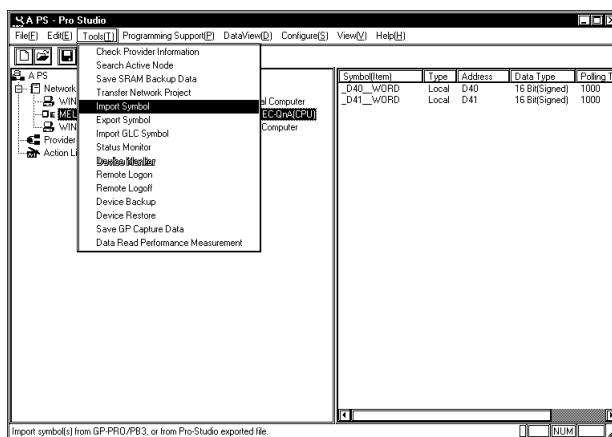

You can also right-click the registered network node and click [Import Symbol] on the shortcut menu.

2. The following dialog box will appear. Select the file type to be imported. Then, click a desired file and then the [Open] button.

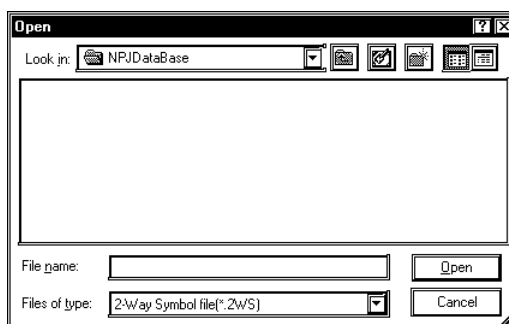

3. The following dialog box will appear, and the designated symbol will be imported.



3.2.2 Symbol Export

The created symbols can be exported in a file format (*.lbe) that can be used on GP-PRO/PBIII for Windows. Also, these symbols can be exported in a file format (*.2ws) that can be imported to another network project.

1. Select the [Tool(T)]'s [Export Symbol] from the Menu Bar.

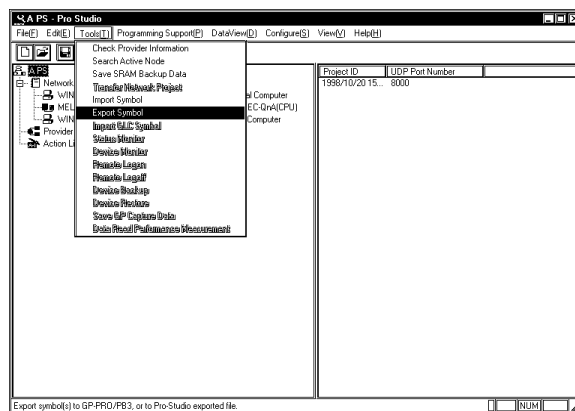

Right-clicking on a desired node can also be used to select [Export Symbol].

2. The following dialog box will appear. Designate the format and name of the file to be exported and click [Export].

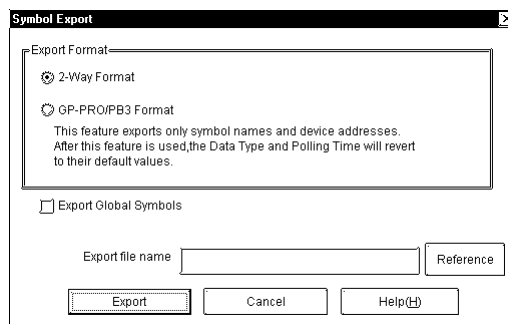

3. The following dialog box will appear and the symbol will be exported.



3.2.3 Importing the GLC Symbols

In order for Pro-Server to access GP symbols (variables), the GLC symbols registered in the GP-PRO/PBIII for Windows project file (*.prw) must be imported to a Network Project using Pro-Studio.

1. Select the target node from the Network Entry Node list

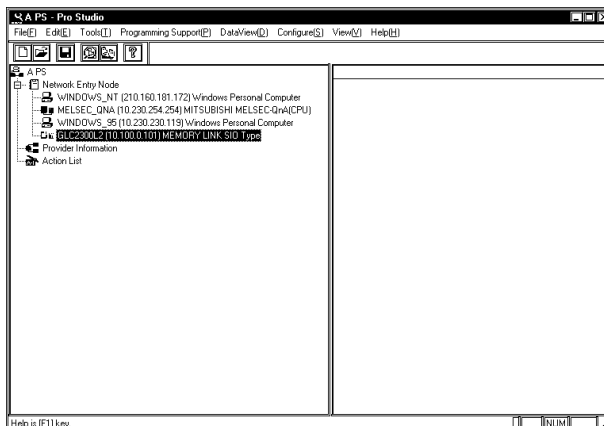

2. Designate the project file to import in the [Edit Node] screen's [Project File (PRO/PB3)] window.

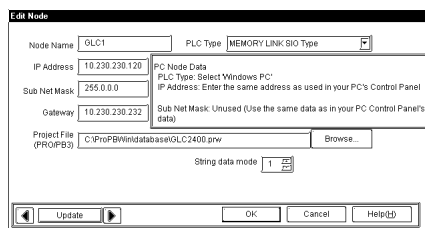
**MEMO**

If the designated project file name is incorrect, an alarm message dialog box will appear.

3. Select the [Tools(T)] menu [Import GLC Symbol] command.

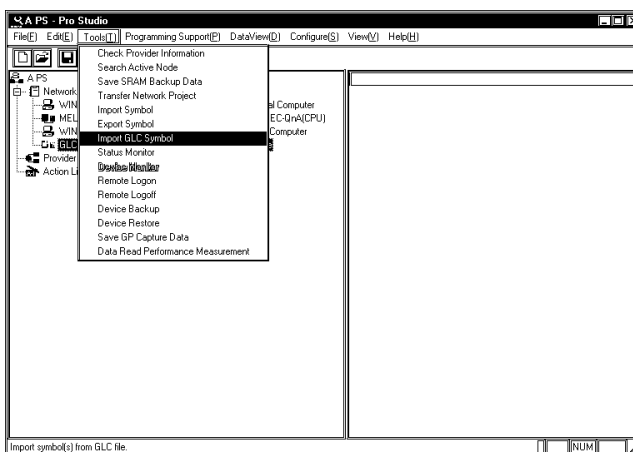

4. The following dialog box will appear and the GLC symbols will be imported.

3.3 Registering Provider Data

Here you can designate the data each network node GP provides periodically or when the trigger condition is satisfied, as well as the data storage location for the GP or PC that receives the data. (The following description assumes that the Pro-Studio main window is open.)

1. Click [Register Provider Information] in the [Edit(E)] menu.

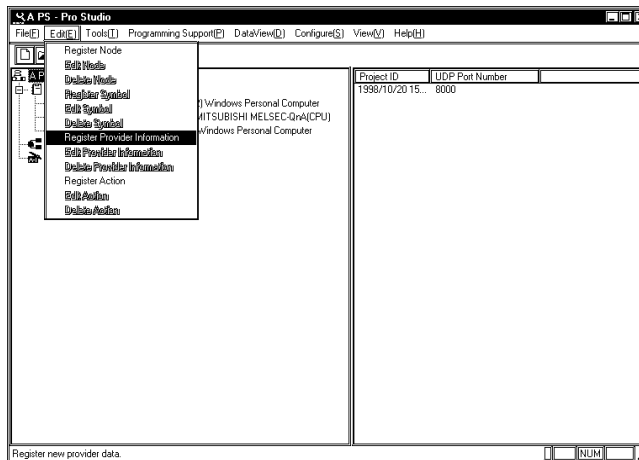

Right-clicking on the provider information list can also be used to select [Register Provide Information].

2. The [Provider Node] window appears. Select the desired node and click [OK].

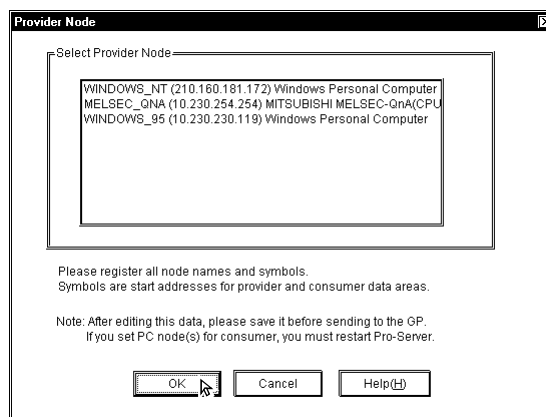

3. The [Provide Information] dialog box will appear. Perform all the settings and click the [OK] button. For Advanced settings, click on [Advanced...].

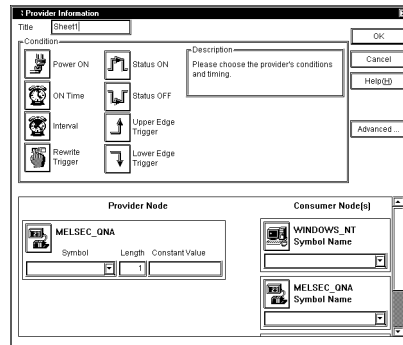

For details of each item, refer to On-line Help.

Reference → “On-line Help”

If the Provider and Consumer’s symbols are not the same data type, they cannot be selected.

When a large volume of data is sent, the GP will not refresh its display while data is being provided.

In addition, the volume of data that can be sent at one time will vary depending on each PLC type.

Please refer to your PLC’s manual to confirm the volume of data that can be sent at one time.

(Range of Provider Data Length)

Bit data: 1 to 16

Others: 1 to 255

You can register up to three “symbol names” for one “Provider information”.

The following items are displayed by selecting the provider's condition.

Condition	Setup Items				Remarks
	Symbol Name	Time/Interval Setup	Designated Interval	Processing after Providing	
Power ON	X	X	X	X	
On Time	X	O	X	X	
Interval	X	O	◆	X	
Rewrite Trigger	O	O	◆	X	
Status ON	O	O	◆	X	
Status OFF	O	O	◆	X	
Upper Edge Trigger	O	O	◆	◆	*1
Lower Edge Trigger	O	O	◆	◆	*2

X : Setting enabled O : Setting disabled ◆ : Option (need to be set when checkboxes are checked)

*1 If you designate “Upper Edge Trigger” and check “OFF Time After Providing”, the device designated by the symbol name is set to OFF (0) when the providing process is completed.

*2 If you designate “Lower Edge Trigger” and check “ON Time After Providing”, the device designated by the symbol name is set to ON (1) when the providing process is completed.

MEMO

- The check interval is defaulted to “0 (zero)” ms. “0” ms will run as fast as possible. You should adjust the check interval if your system requires it.
- The process after providing should be set to “Complete Process”. The process is completed even when a providing error occurred.

4. The [Providing Configuration] window appears. Enter the necessary items and then click [OK].

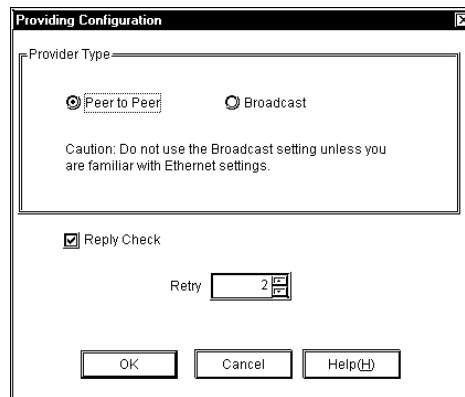

Transmission Type	Response Check	
Peer to Peer	Performe(Default)	None
Broadcast	Performe(Default)	None

The Broadcast feature places a load even on devices that are not related to data transfer, and an alarm message will appear to inform you of this.

If you wish to change a node (topic)’s data after it has been registered, simply right-click on the topic to bring up a list of selections. From these, click either the [Edit Node] or [Delete Node] selections, or, from the menu bar, click the [Edit(E)] menu’s [Edit Node] or [Delete Node] items.

When two GP units are started simultaneously and one is set to provide data to the other (“Consumer”), if the sending unit sends the data before the Consumer finishes its start-up process, an error will be displayed on the Consumer GP. Since this error can usually be fixed by simply sending the data again, set “Retry” to one (1) to prevent the error message display.

In environments where data transfer errors can frequently occur, setting the number of data transfer retries can prevent unnecessary communication errors.

3.3.1 Checking for Provider Data Errors

The following procedure explains how to check provider data. If, after registering provider data, you delete the relevant symbol name or network node, or alter any symbol's data type, an error message will appear. If no errors are found in the provider data, the data's file size when it is downloaded to the GP will be displayed. The file size shown in this dialog box reflects the amount of GP screen area used. (The following description assumes that the program's main window is open)

1. Click the [Check Provider Information] item in the [Tools(I)] menu.

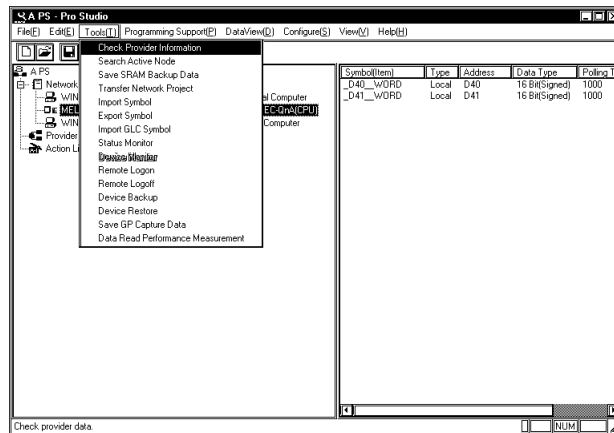

2. The following dialog box appears.



Although the program checks provider data automatically during saving, it will not display the file size.

In the following cases an error will occur:

After entering provider information,

- the data type of a symbol has been changed,
- a symbol name has been changed or deleted, or
- a node name has been changed or deleted.

If an error occurs, you will not be able to transfer the network project file (*.npj) to the GP.

DO NOT edit or delete a symbol, or that symbol's designated provider node.

Maximum size of provider information data is 64 kbytes.

Rule of thumb

Base.....36bytes

Register Node.....72bytes

RegisterProvideInformation.....120bytes

3.3.2 Action Items

Using the action item function, you can designate the desired action item(s) (called action item “contents”) so that a Consumer (only a Windows OS personal computer) which has received provider information will perform them.

You can start action items by setting the symbol name of the Provider node to the action name.

Action items must be set up, however, it is possible that they are not used during normal operation.

For a detailed explanation of action item functions, refer to “Chapter 4 Action Items”.

3.4 Using the DDE Function

Pro-Server incorporates the DDE server function and therefore can exchange data with applications that support the DDE client function. The following description assumes that the program's main window is open.

DDE: String Copy

1. Click the desired symbol name.

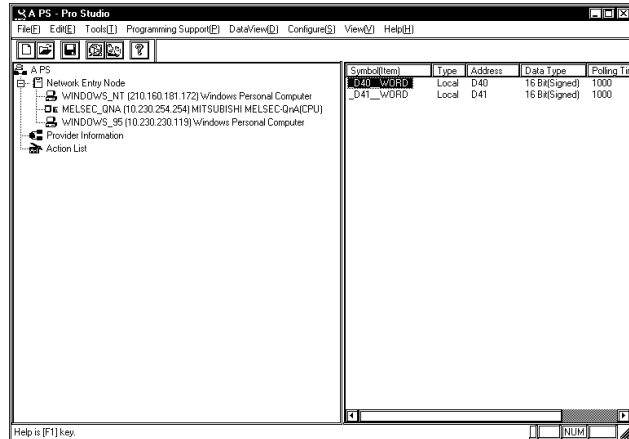

MEMO

With Excel, you cannot use DDE to write data because Excel does not support data writing as a DDE client. To write data to Excel, use the VBA function.

2. Click [DDE: String Copy] on the [Programming Support(P)] menu. Or, right-click the symbol name, and then select [DDE: String Copy].

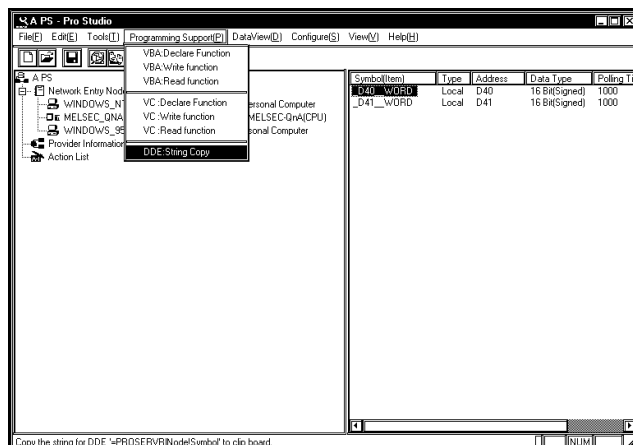

3. When the following dialog appears you can paste the copied string into any DDE-compatible software.

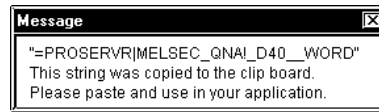

4. Here, the copied string is pasted into an Excel worksheet to create a DDE link.

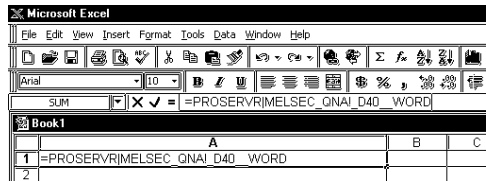

MEMO

When a symbol's data is text and is copied to an Excel cell, only the first character of the text will be displayed. In this case, edit that Excel cell and add the required characters.

Ex.

=PROSERVER|GP1!' SYMBOL.*20'

Be sure to put "" around "!".

Reference → "A.1 DDE Function Details"

When Creating an LS Area inside your PC:

When using the (data) distribution feature, the creation of an internal LS (Pro Server) area inside your PC will allow you to easily read out data periodically from one or more PLCs. The setting of the DDE feature to read out collected data from the LS area will allow the data in the LS area to be refreshed faster.

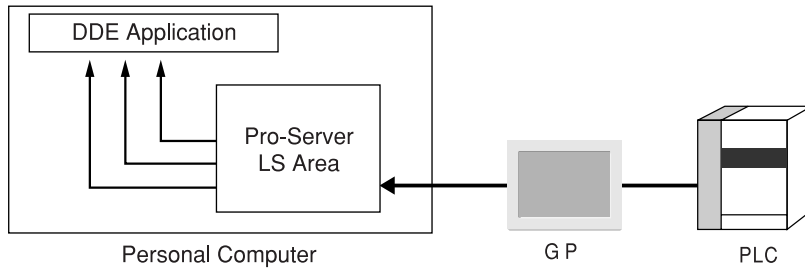

1. Call up the Register Node feature to register the Host PC.

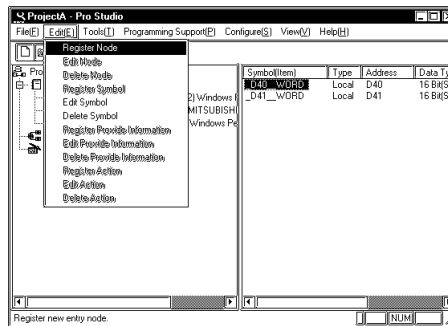

To Register a Node, refer to “3.1 Registering Network Entry Nodes”

2. Designate the Host PC.

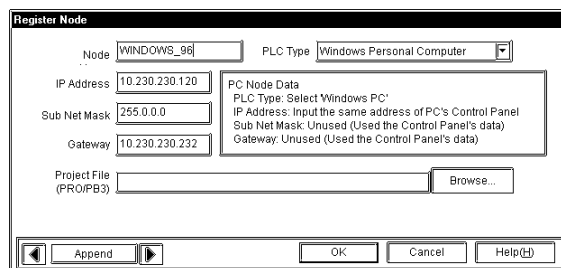

[PLC Type]

Designate the Host PC.

3. Enter the settings for the PC's internal LS area.

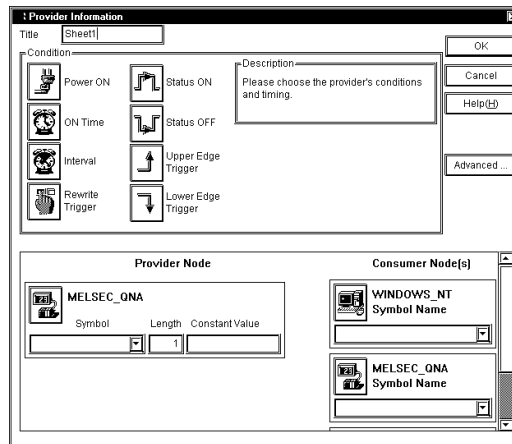

[Consumer Node(s)]

Designate the LS area name that the host PC will use. You should designate the LS area name that you wish to use among LS, LSA, LSB ... LSY and LSZ.

For detailed Provider information, refer to “3.3 Registering Provider Data”.

When Creating an LS Area inside your GP

Creating an LS area inside your GP will allow your PC to easily read out data periodically from the GP. The setting of this feature allows data to be read out faster. This feature also speeds up data writing.

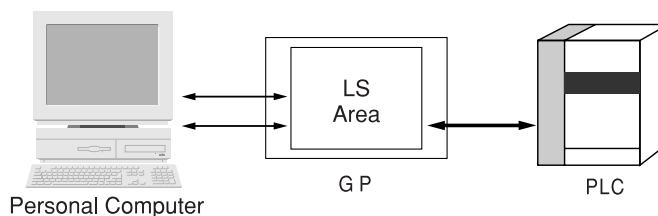

MEMO

The GP's LS area will vary depending on the GP system used. The following table shows LS area sizes according to GP system versions.

LS Area Size	GP
4096	GP77R SERIES
8192	GP-2000 SERIES/GLC2000 SERIES/IT SERIES

For the GP's LS area size, the 2-Way Driver will automatically decide its accessible range.

GP-PRO/PBIII for Windows Ver. 6.0 or later should be installed on the GP system to use the LS area up to 8192.

3.5 Using the VBA Support Function

Pro-Server can read and write data both to and from applications supporting Visual Basic and Visual C++ using read and write functions. The following procedures explain how to write data from Excel to a designated symbol via a programming support function.

When developing applications with VB or VC, refer to “Chapter 9 Simple DLL Function”.

VBA: Declare statement

1. Selecting [VBA: Declaration statement] from [Programming Support].

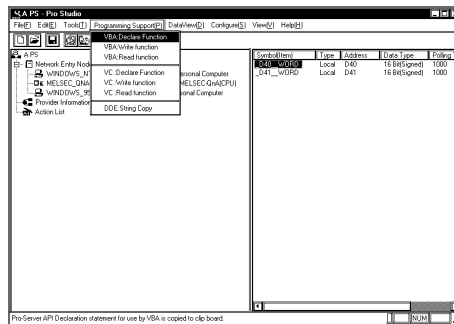

2. The declaration is copied to the Clip board.

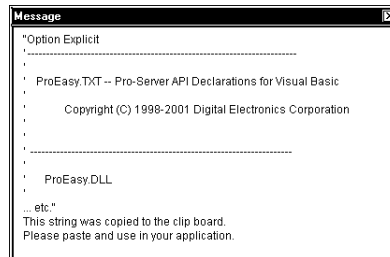

3. Start-up Microsoft Excel. Select [Visual Basic Editor] from the [Tools] menu's [Macro] feature.

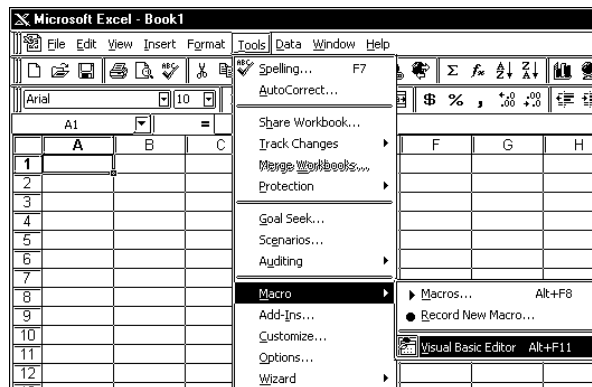

4. Select [Module] from [Insert] in the Visual Basic Editor.

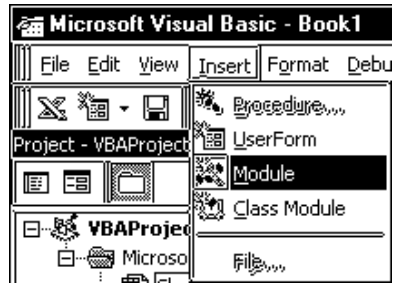

5. Paste the declare statement in the inserted standard module.

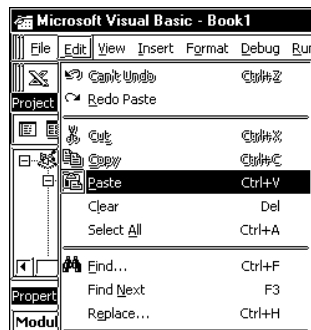

6. This completes function declaration.

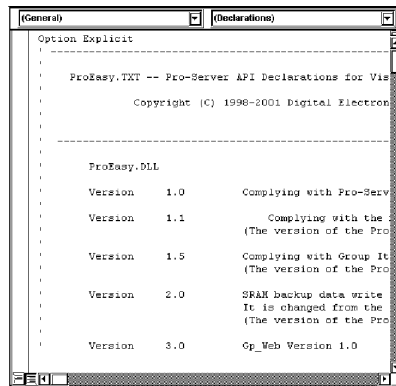

VBA: Write Function

- Click the desired symbol name.

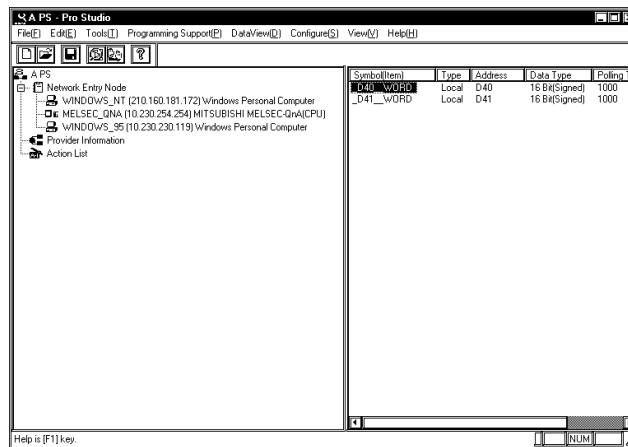

- Select [Programming Support(P)]'s [VBA: Write function] from the Menu Bar.

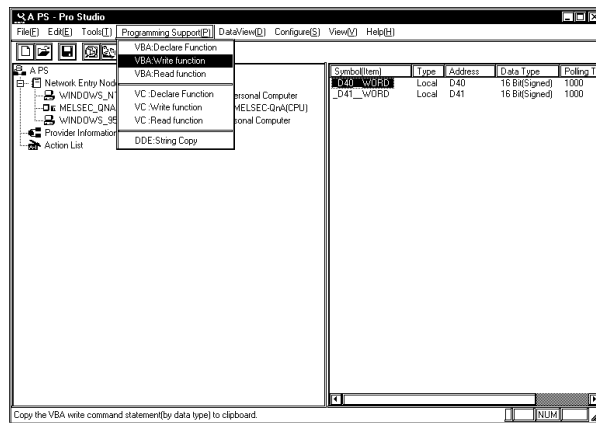

- Write Command is now copied to the Clipboard.

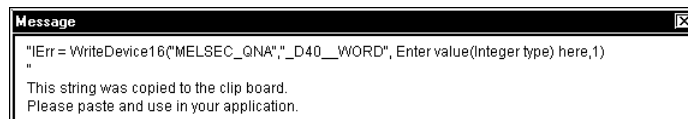

10. In Microsoft Excel, select the [Control Toolbox] from the [Views] menu's [Tool bars] feature.

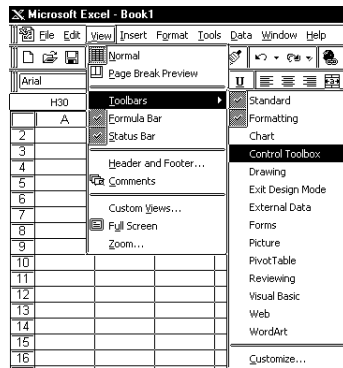

11. Paste the command button onto the sheet.

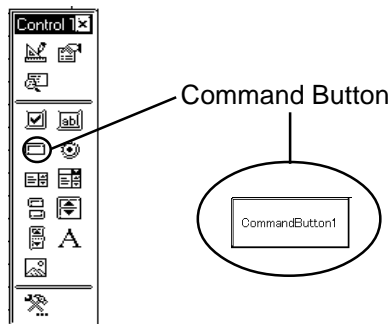

12. Double click the button. The following VBA creation screen is displayed.

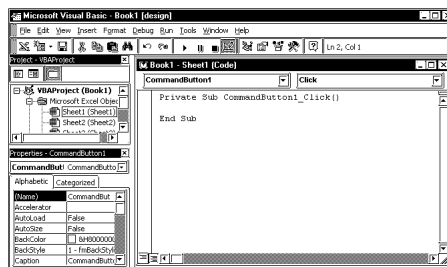

13. Paste the instruction statement in the program position of the VBA creation screen.

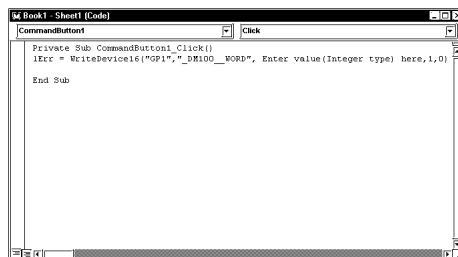

14. Input the value to be written into the PLC device whose symbol is indicated. Replace the words 'Input value here' with the numeric value.

Example) When set to 100,

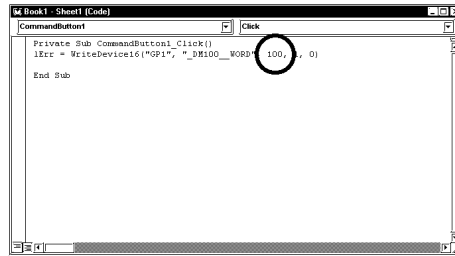

15. Click on the [Design] icon to quit the Design Mode.

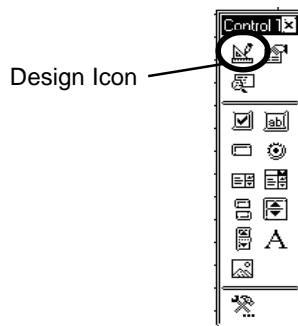

16. Thus, when you click Excel's Command Button, "100" is written to the PLC symbol's device.

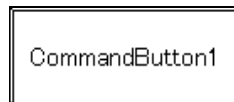

The Device Monitor feature allows you to easily check that the data has been written successfully.

Reference → "Chapter 6 Tools"

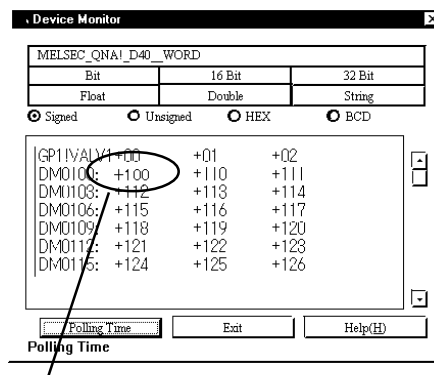

"100" has been written to the device.

(Reference)

Cells that have been designated as using Excel's Range Function can write data to a GP or PLC device. If you then change the value entered in this cell and push the Command Button, the device's data will be immediately refreshed.

Reference → 3-25, step 11.

1. Input the value to be written to the symbol's PLC device.

Here, enter "Range("A1")" in the space shown by "Enter value here"

"IErr = WriteDevice16("GP1", "_DM100_WORD", Range("A1"), 1, 0)"

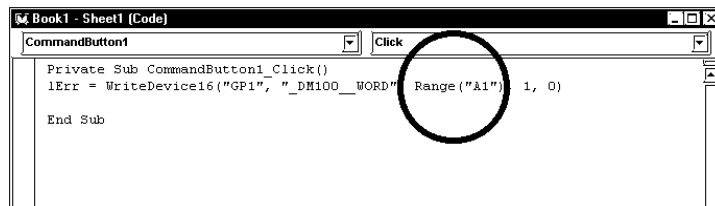

2. Click the [Design] icon to quit the Design Mode.

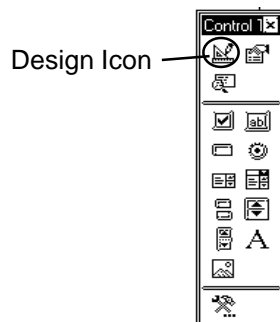

3. Thus, when you enter 100 in Excel's worksheet cell A1, and press the Command Button, "100" is written to the GP or PLC symbol's device.

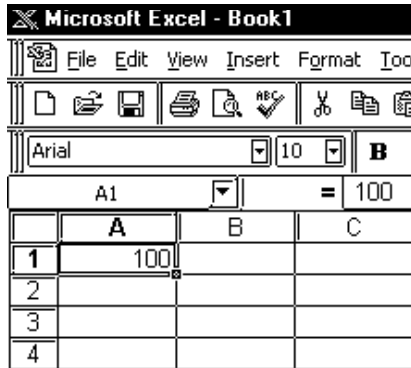

The Device Monitor feature allows you to easily check that the data has been written successfully.

Reference → Chapter 5, "Monitoring"

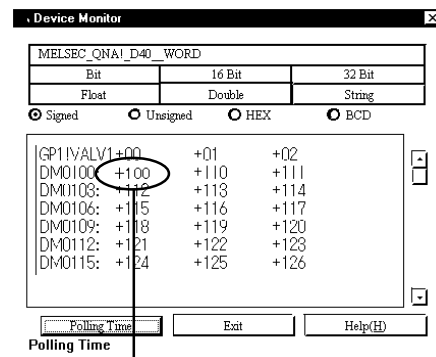

"100" has been written to the device.

3.6 Saving Backup Data in SRAM

Pro-Studio allows you to upload backup data stored in a GP's SRAM to the host PC as a comma-delimited CSV (Comma Separated Value) file. You can open CSV files using Excel, Access, or any application that supports the CSV file editing format. There are eight types of backup data you can upload (or save).

1. Click [Save SRAM Backup Data] on the [Tools(T)] menu.

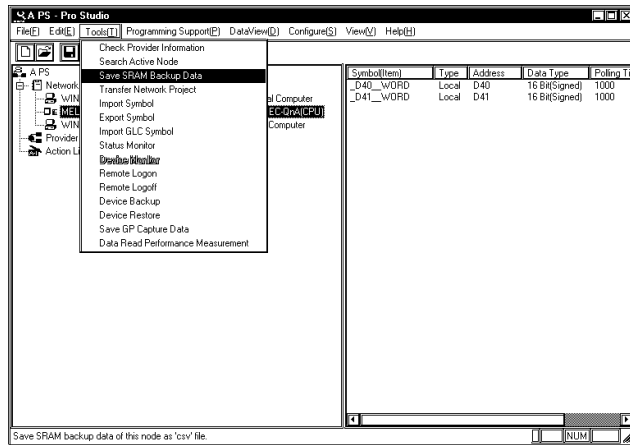

2. The [Save SRAM Backup Data] window appears. After selecting the network entry node, the data you wish to save, and the file in which the data is saved, click [Save].

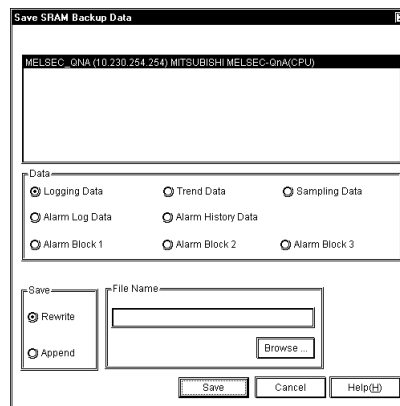

For detailed information about each data, refer to GP-PRO/PBIII for Windows Tag Reference Manual.
Reference → “GP-PRO/PBIII for Windows Tag Reference Manual”

3. The time elapsed for saving is shown.

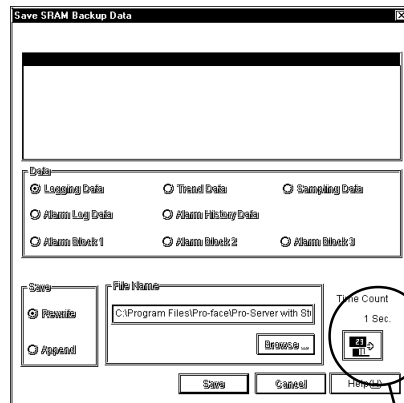

Saving time is shown.

4. When the saving process has been completed successfully, the following window appears.



MEMO

To open an SRAM backup data file you saved using Excel, start Excel, click [Open] on the [File] menu, and then select [Text file (*.prn; *.txt; *.csv)] as [Save as type].

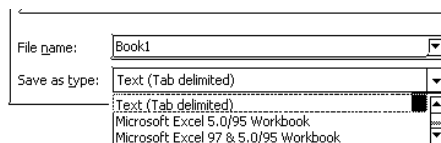

3.7 Device Data Backup and Restoration

The device data backup function allows you to collect a series of device data via the Internet and to save it as data files.

The device data restoration function allows you to restore collected data from a series of devices.

The data saving format can be either BIN (binary) or CSV.

3.7.1 Device Data Backup

1. Click the [Tools (T)] menu in the [Device Backup] window.

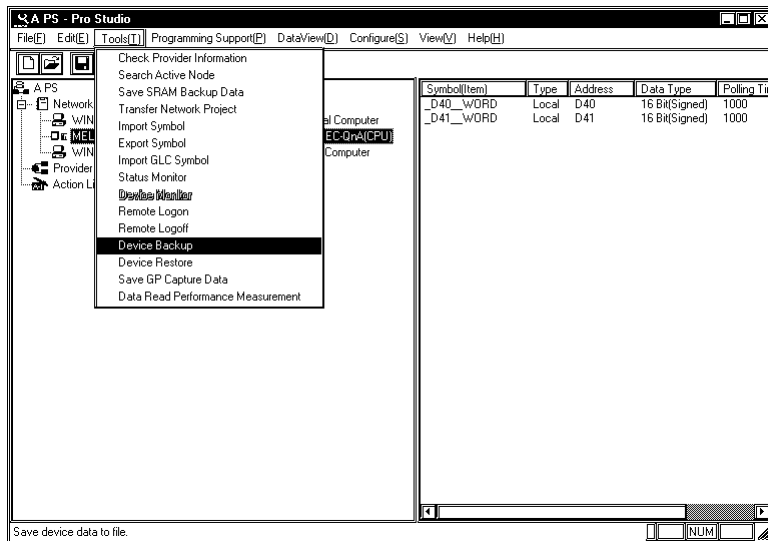

2. The [Device Backup] window appears. After selecting all items, click [Backup].

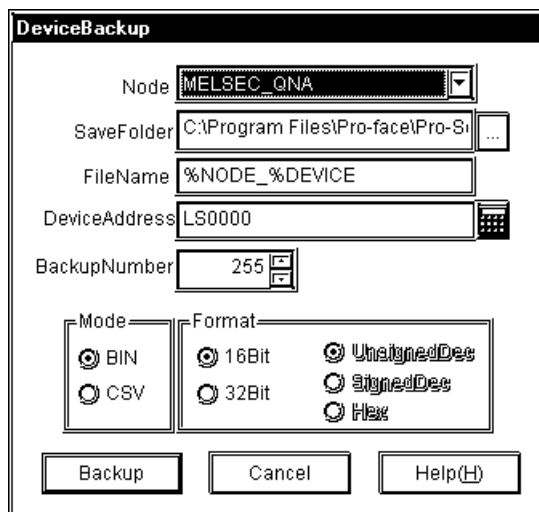

[Node Name]

Select the node name. If unselected, the error dialog will appear.

[Save Folder]

Enter the path to the folder that you wish to save data. This is defaulted to the “NPJDataBase” folder in the current directory of Pro-Server. If not entered, the error dialog will appear.

[File Name]

Enter the file name. By default, the file name will vary depending on the node name, the device address, the saved type and the data type. If not entered, the error dialog will appear.

[Device Address]

Enter the device address that you wish to start saving. This is defaulted to “LS0000”. If not entered or entered incorrectly, the error dialog will appear.

[Backup Number]

Enter the number of backup data. The minimum value is 1, and this is defaulted to 255.

[Mode]

Select the saved type. This is defaulted to “BIN” (binary).

[Format]

Select the data type. This is defaulted to “16 bits unsigned decimal”. Select the number system only when the saved type is CSV.

3. The backup processing status is displayed in the [now] dialog.

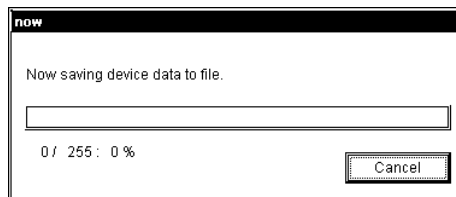

4. When the backup process has been completed successfully, the following window appears.
Click [OK] to exit the process.

**MEMO**

- The following shows the data contents for CSV device data.
Node name, (Node name for backup) (CR)
Device name, (Device address to start backup) (CR)
Number, (Number of backup data) (CR)
Device length, (Bit length of the backup device) (CR)
Data type, unsigned decimal (CR)
Date, (Backup date) (CR)
(CR)
Data, comment (CR)
(Value of the first device address), (Name of the first device address) (CR)
(Value of the second device address), (Name of the second device address)
(CR)
- The backup date should be written in a format of (year)/(month)/(day) (space)
(hour):(minute). If (minute), if it is one digit, use 0 (zero) in the second digit.

3.7.2 Restoring Device Data

1. Click [Device Restore] on the [Tools (I)] menu of the Menu Bar.

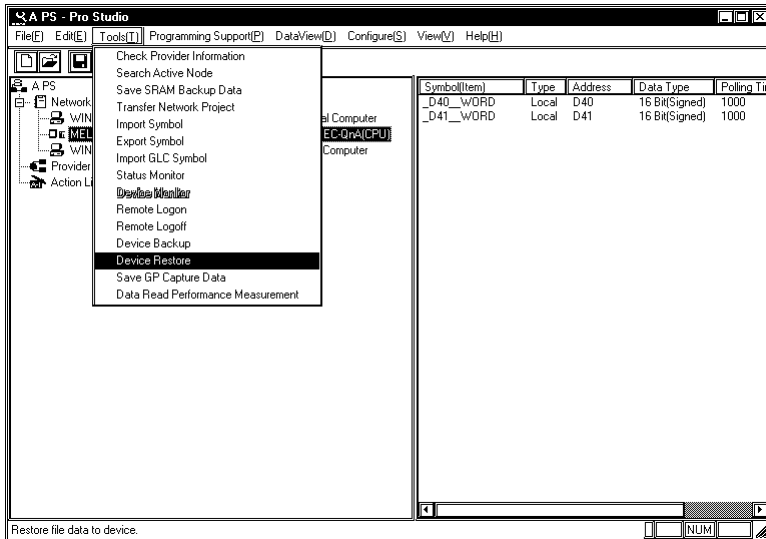

2. The [Device Restore] window appears. After selecting all items, click [Restore].

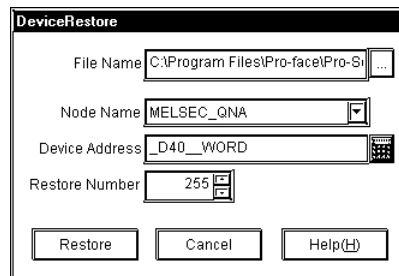

[File Name]

Enter the file name. All buttons except for the cancel button will stay dimmed until you designate the correct file.

[Node Name]

Select the node name from the selection box. If unselected, the error dialog will appear.

[Device Address]

Enter the device address to start the restoration. When you enter the file name, the header address saved in the file is entered. If not entered or entered incorrectly, the error dialog will appear.

[Restore Number]

Enter the number of restoration data. The minimum value is 1, and the maximum value depends on collected data files. When you enter the file name, the number of data saved in the file is displayed.

3. The restoration processing status is displayed in the [now] dialog.

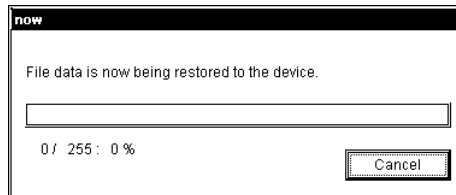

4. When the restoration process has been completed successfully, the following window appears. Click [OK] to exit the process.



3.8 GP Capture Data Saving Function

Pro-Server allows you to read the on-line GP capturing data on your network. This screen capturing is realized by two different ways, the way to execute it using the action item function or the interactive way.

This section describes the interactive capturing procedure.

For the procedure using the action item function, refer to “Chapter 4 Action Items”.

Reference → “Chapter 4 Action Items”

MEMO

- You can use this function only on GP-2000 series/GLC2000 series/IT series.
- Prior to performing this function with the CF Card inserted into the GP because the read data is temporarily saved in the CF Card.

1. Click [Save GP Capture Data] on the [Tools (T)] menu of the Menu Bar.

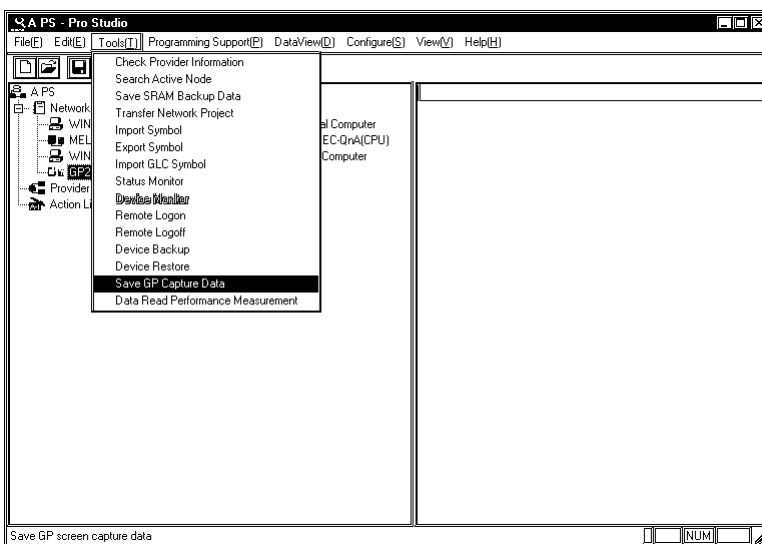

2. The [Screen Capture & Save] window appears. After selecting all items, click [Save].

The screenshot shows a dialog box titled "Screen Capture & Save". It has three input fields: "Node Name" with a dropdown menu showing "GP2300L1", "Folder Name" with a text box containing "C:\Program Files\Pro-face\Pro-Ser" and a browse button "...", and "File Name" with a text box containing "%NODE%Y%M%D%h%m" and a "Default" button. Below these fields is a checkbox labeled "Show Browse" which is currently unchecked. At the bottom of the dialog are three buttons: "Save", "Cancel", and "Help(H)".

[Node Name]

Select the node name. If unselected, the error dialog will appear.

[Folder Name]

Enter the folder name to save data. This defaults to the "NPJDataBase" folder in the current directory of Pro-Server. If not entered, the error dialog will appear.

[File Name]

Enter the file name. This defaults to %NODE%Y%M%D%h%m%s (node name, year, month, day, hour, minute).

[Show Browser]

Select if you wish to display it on your browser after uploading the GP screen. If you check (ON) the box, it will be displayed on your browser. This defaults to unchecked (OFF).

MEMO

When you execute [Save GP Capture Data], drawings and operations on the GP screen will stop for a few seconds. Therefore, you cannot normally execute the GP screen capturing operation from upper-level PCs. You should set the bit "0" of GP's LS2076 to "ON (1)" to capture GP screens from upper-level PCs. The bit "0" of LS2076 will be set to "ON (1)" while capturing.

3.9 Security Function

Pro-Server has a security function to protect PLC and GP data.

The following items are included in this function:

- Passwords to set up user levels (User level password)
- Password to protect accesses from unregistered personal computers (Remote password)

3.9.1 User Level Password Settings

Pro-Server can restrict the range of functions available to a user via three different password levels.

MEMO

Be sure to write down every password registered so as not to forget it. You cannot log on to the system without the correct password.

1. Select [Password] in the [Configure(S)] menu.

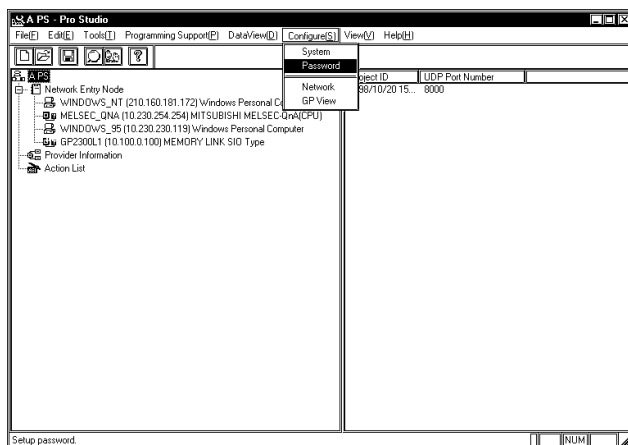

2. The Password window appears. Specify whether you enable or disable the password check by turning on the corresponding option. If you select [Enable], enter all the items and then click [OK].

Operations available for each level are as follows:

Level	Change settings	Writing data	Reading data
Administrator	○	○	○
Read / Write	×	○	○
Read only	×	×	○
Disconnect	×	×	×

Change Settings...Provider information setting changes, etc.

Writing data.....Data write via device monitor

Reading data.....Data read via device monitor

If you enter a password, the following Login window will appear at the start of Pro-Server/Pro-Studio.

3.9.2 Remote Password Setup

In order to prevent illegal accesses by a personal computer that has not been registered on the network, a password can be registered for the entire network.

When remote access is attempted from a personal computer that has not been registered as a network node, a dialog box will appear asking for the password. After the registered password is correctly entered, remote access can be performed.

MEMO

Be sure to write down each registered password. If a password is forgotten, remote access cannot be performed.

1. Select [Network] in the [Configure(S)] menu.

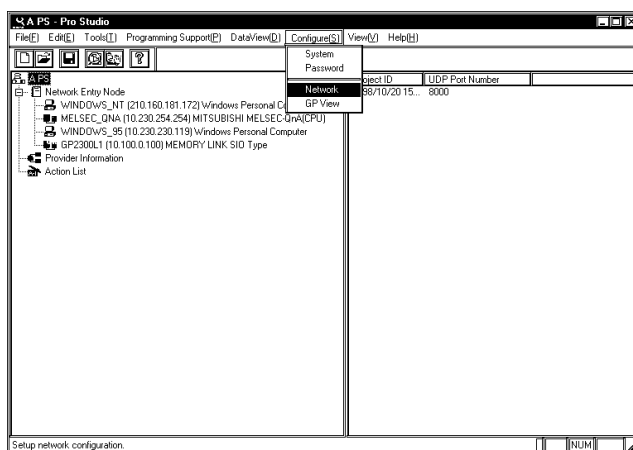

- The [Network Configuration] dialog box will appear. Enter a password in [Network Remote Password] and click the [OK] button.

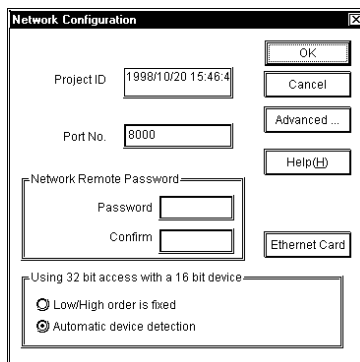

When selecting a node via a personal computer that has not been registered as a network node and selecting [Tool]'s [Remote Logon] from the Menu Bar, a dialog box will appear, asking for the password.

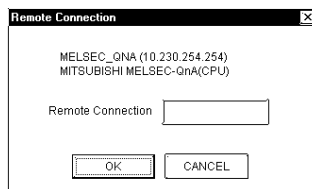

3.10 Configuring the System

The following describes how to enter Pro-Server and Pro-Studio system information. (The following description assumes the program's main window is open).

- 1. Select [System] in the [Configure(S)] menu.

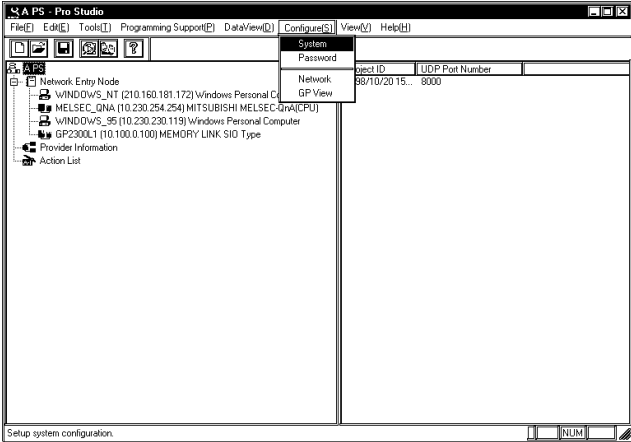

2. The [System Configuration] window will appear. Enter all necessary data and click [OK].

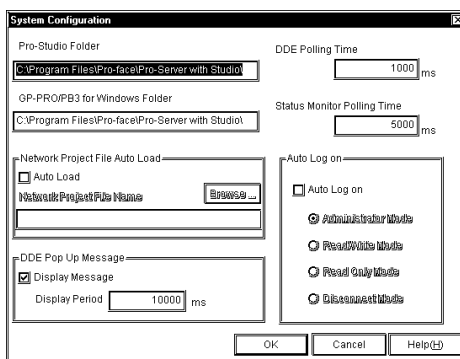

[DDE Polling Time]

The DDE polling time designated here will be used as an initial value of the polling time when a symbol is registered.

[GP-PRO/PBIII for Windows Folder]

Designate the folder where GP-PRO/PBIII for Windows is installed. The default is “C:\ProPBWin”.

[Network Project File Auto Load]

The designated network project file is loaded automatically when Pro-Server starts.

For access rights by modes:

Reference → “3.9.1 User Level Password Settings”.

For the detailed information for other items:

Reference → On-line Help.

MEMO

- The polling time used set for collecting or writing data for each symbol, providing data and monitoring devices may not be able to be performed under certain conditions. These conditions include the currently registered number of GPs, number of Tags used on each screen sent, type of PLC connection, and number of other currently open Windows applications. Entering “0” will allow the system to operate at its maximum speed. Use this value as a benchmark when entering other values to “fine-tune” your system.
- If you create and add Pro-Server’s short-cut to the Windows Start Up menu, Pro-Server will start automatically with a network project that has been designated via [Network Project File Auto Load].

3.11 Configuring the Network

Follow the procedure below to change the Network Port Number setting. The ports to be used should be consecutive ports, beginning with the first port number entered. The default port number setting is “8000” which uses ports 8000 and 8001. The following description assumes the Pro-Studio main window is open.

1. Click [Network] in the [Configure(S)].

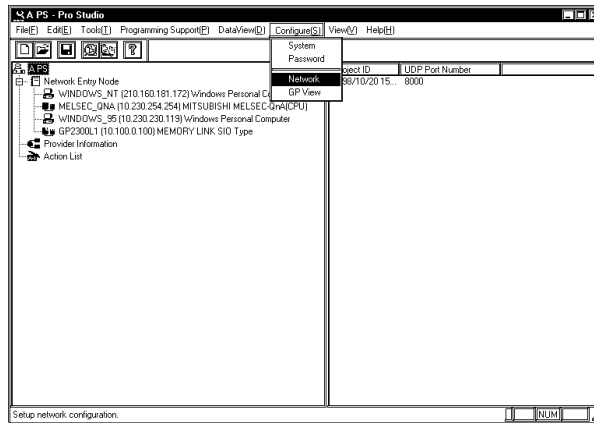

2. The [Network Configuration] window will appear. Enter all necessary data and click [OK]. To enter advanced settings, click on [Advanced].

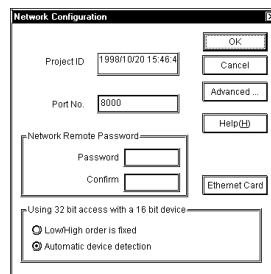

[Port No.]

For port numbers, ten numbers in series are used, starting from the designated number.

[Network Remote Password]

For a remote password through network, refer to “3.10.2 Setting the Remote Password”.

[Using 32 bit Access with a 16 bit device]

Selects the access order of sequential two 16-bit devices which are regarded as a single 32-bit device.

3. The [Advanced Configuration] window will appear. Enter all necessary data and click [OK].

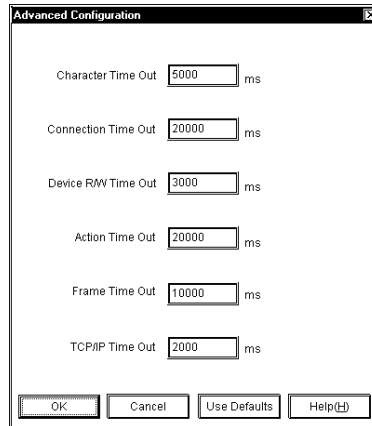

The image shows a dialog box titled "Advanced Configuration" with a close button in the top right corner. It contains six input fields, each with a numerical value and the unit "ms":

- Character Time Out: 5000 ms
- Connection Time Out: 20000 ms
- Device RW Time Out: 3000 ms
- Action Time Out: 20000 ms
- Frame Time Out: 10000 ms
- TCP/IP Time Out: 2000 ms

At the bottom of the dialog box, there are four buttons: "OK", "Cancel", "Use Defaults", and "Help(F1)".

After you have selected an advanced setting, the following message appears.

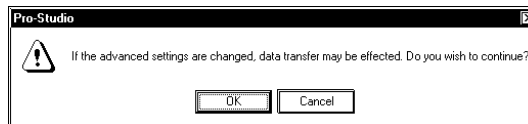

Clicking [Use Defaults] resets all values to the default values.

3.11.1 Configuring Ethernet Cards

If the PC for Pro-Server has equipped with two or more Ethernet cards, it is required to designate the specific card for Pro-Server to use. If the PC has only one Ethernet card, there is no need to change the settings.

These settings are not available on a PC running Windows 95.

1. Select [Configure(s)] menu's [Network Configuration] item.

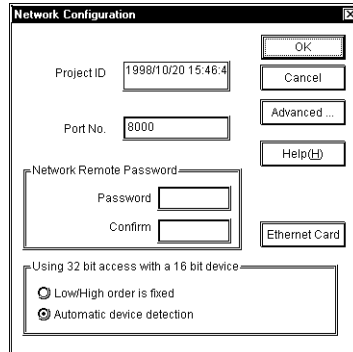

2. Click the [Ethernet Card] button. The Ethernet Card window will appear.

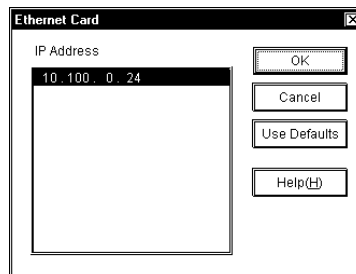

3. Select the IP address of the card to be used by Pro-Server and click OK.

MEMO

After changing the Ethernet card, make sure to restart both Pro-Server and Pro-Studio.

3.12 Printing the Setting Data

You can Print Pro-Studio Setting data.

The items that can be printed are as follows:

- Provider's list

IP address, sub net mask, PLC type

- Registered symbol information by provider

Symbol name, symbol type, device address, data type, polling time

- Registered provider information data by provider

Provider title, provider contents (conditions, symbol name, check interval,

provider, receiver)

1. Select the [File(F)] menu's [Print(P)] command.

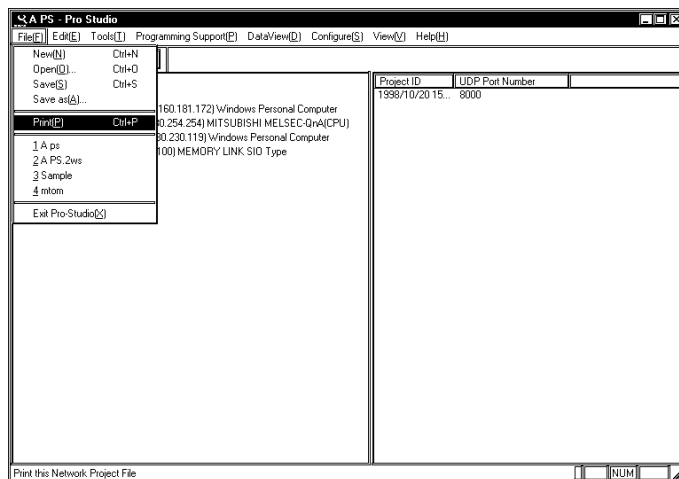

When no Network Project file (*.npj) is open, a dialog box will appear to ask a target file to print.

2. The default printer will print the data.

Printable paper size is A4 only.

4 | Action Items

This chapter describes the detail about Action Items.

- 4.1 Overview
- 4.2 Action Item Registration
- 4.3 Action Item “Contents”
- 4.4 Action Item Designation

4.1 Overview

Using the action item function, you can designate the desired action item(s) so that a Consumer (only a Windows computer) that has received provider information will perform them.

To use an action item, first, use the Setup Menu to register it. A registered action item can then be used by designating the action's name instead of a symbol name in the [Provider Information] dialog box.

4.2 Action Item Registration

The following procedure explains how to register an action item.

1. Select the [Edit(E)] menu's [Register Action] selection.

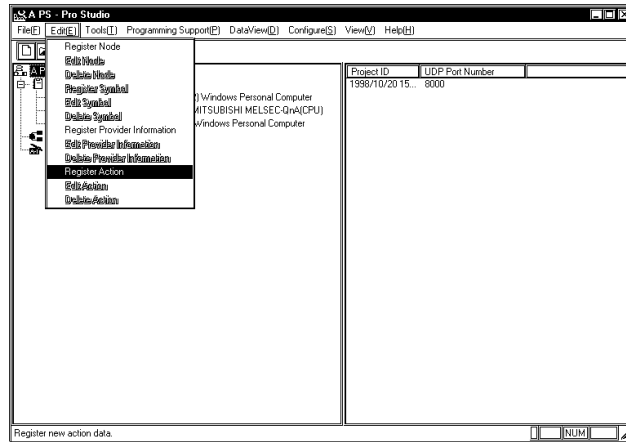

2. The [Edit Action] dialog box will appear. Select the desired action item from the pull-down menu and designate the action name.

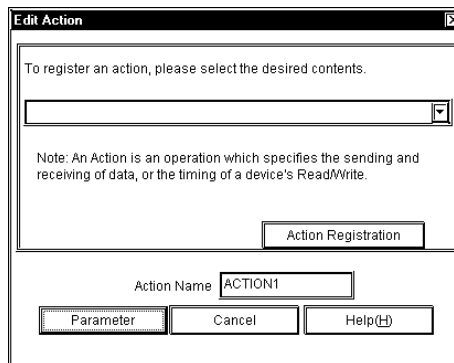

[Action Registration]

It is necessary to register the action item contents to the registry when you created it by yourself. To register new action items, click the [Action Registration] button.

MEMO

Action item contents prepared by Pro-Server with Pro-Studio are automatically registered at the installation time so that you do not need to perform this operation for those.

3. Clicking the [Parameter] button will call up detailed settings for each selected action item.

4.3 Action Item "Contents"

The following description explains how to enter settings for individual action items.

The following explanations assume that the [Register Action] dialog box has been opened, an action selected from the pull-down menu, and the [Parameter] button has been pressed to bring up that action item's [Setting Parameters] dialog box.

4.3.1 Start Application

1. The following screen will appear.

[Application Name]

Enter the name of the application to be started here. This includes any user-created applications as well. (e.g. *.exe, *.com)

[Startup Options]

When a start up option or Provider data are used as a parameter, enter the data and click the appropriate check box.

[Node name]

The Provider node name is automatically added as startup options.

[Write data]

Provider data (write data) is automatically added as startup options. If there are multiple Provider data, "<single-byte space>, <Provider data>" is added in turn.

(Example) : <starting options><single-byte space><Provider data><single-byte space><Provider data> ...

[Current Folder]

Designate the current folder of [Application Name].

4.3.2 Write Data to Excel Book

1. The following screen will appear.

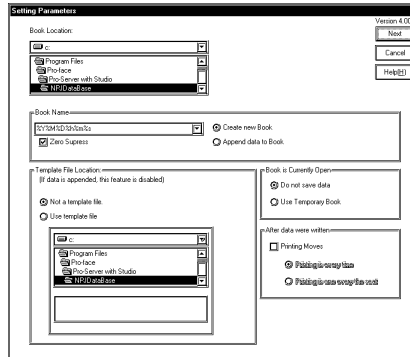

[Book Location]

If you check the Save To Folder location in the action parameter display, and if the folder exists, the contents exactly as you designated is displayed.

If the folder does not exist, the following window appears.

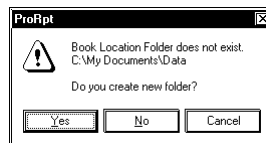

Click [Yes] to create the folder. The folder creation window will appear. If you click [No], the folder designation window will appear to designate the Save To Folder location.

If you click [Cancel], the process is canceled.

[Book Name]

Enter the book name.

[Zero Suppress]

If you check this option, no zeros are supplied to the file name even though the file name includes any of “%M%D%h%m%s” (month, day, hour, minute, second).

If you do not check this option, 0 (zero) is supplied to the file name if the file name includes any of “%M%D%h%m%s” (month, day, hour, minute, second) and that number is one digit.

The default is “checked”.

MEMO

Writing in the Excel sheet is performed while searching blank cells. A large amount of data in a sheet will slow down a writing process.

A sheet is divided by setting a book name as "%Y%M%D%h%m%s" so that a writing process will be speeded up.

[File Save Method]

When you normally wish to make a new book, check the upper button. If you wish to add historical data, etc., click on the lower button.

[Template File Location]

If you wish to use a previously made template file, click the [Use Template file] button, and then select the desired template file (*.xlt).

MEMO

Only the sheet1 should exist within the designated template file.

[Book is Currently Open]

Select the action from [Do not save data] or [Use Temporary Book] when books with the same filename are open on writing.

If you selected [Do not save data], written data are not saved when book files with the same filename are open in advance.

If you selected [Use Temporary Book], written data are saved as a separate filename temporarily. The temporary filename will be "%Y%M%D%h%m%s.xls".

[After data were written]

Select when printing is required after data write. Timing can be set to [every time] or [every sheet].

If you selected [every time], printing is executed every time data are written.

If you selected [every sheet], printing is executed after data are written to all the designated cell range.

2. Clicking the previous Excel Setting screen's upper right corner [Next] button calls up the following screen.

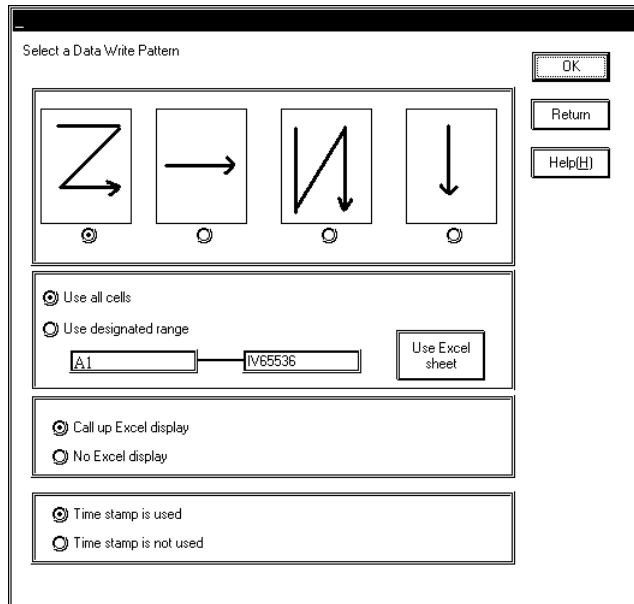

[Select a Data Write Pattern] [Write Data Range]

Designate the sheet's data write pattern, and the write data's cell range. If you click [Use Excel sheet], you can designate the range in the Excel environment. When the designated write data cell range is filled with write data, the new sheet is automatically created and the write data process is continuously executed on the newly created sheet.

[Call up Excel display]

When [Call up Excel display] is checked, as soon as the designated trigger conditions are met, Excel will automatically start and the data will be written to the Book.

Once the data write is finished, however, Excel will quit after a preset interval.

[Time Stamp]

Selecting [Time stamp is used] will write the Provider's time data.

4.3.3 Alarm Log (with Sound Alert Features)

This feature allows the simultaneous output of sound data and display of alarm data, while automatically saving a Provider's Alarm history data.

Also, after creating the following table data with Microsoft Access, an Action Item's table designation settings can be used to compare the Provider data and a Key Code, and then perform the actions designated in the table.

mdb file name: Alarm.mdb

Table name: TemperatureAlarm_TBL

Key_Code	WAV	DISP1	DISP2
1	Machine1.wav	Machine1	High Temp.
2	Machine2.wav	Machine2	Low Temp.
3	Machine3.wav	Machine3	High Temp.

Designate the WAV files.

Enter the message you wish to have appear when the Action Item is started.

MEMO

The sample of Alarm.mdb is available in "\Pro-Server with Pro-Studio\Pro-SDK".

1. When the Setting Parameters screen appears, enter the following data.

[mdb Filename]

Ex. "Alarm.mdb"

[Table]

Ex. "Temp Alarm_TBL"

[Key Field]

Ex. "Key_Code"

[WAV Data Field]

Ex. "Wav"

[Message Display Field]

Ex. "DISP1, DISP2"

[Log Data Save Table]

If you check the Save To Folder location in the action parameter display, and if the folder exists, the contents will display exactly as you designated.

If the folder does not exist, the following window appears.

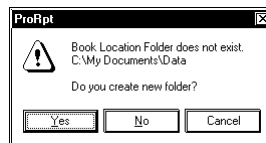

Click [Yes] to create the folder. The folder creation window will appear. If you click [No], the folder designation window will appear to designate the Save To Folder location.

If you click [Cancel], the process is canceled.

[Number of Log Data Items]

Enter the number of items to be logged. When the number of items exceeds this value, the oldest item is deleted.

4.3.4 Upload of GP Log Data

Back-up data can be read online from the provider's SRAM or CF Card by designating the read source. If XLS format is selected for the save format, Microsoft Excel must be installed.

1. The following screen will appear.

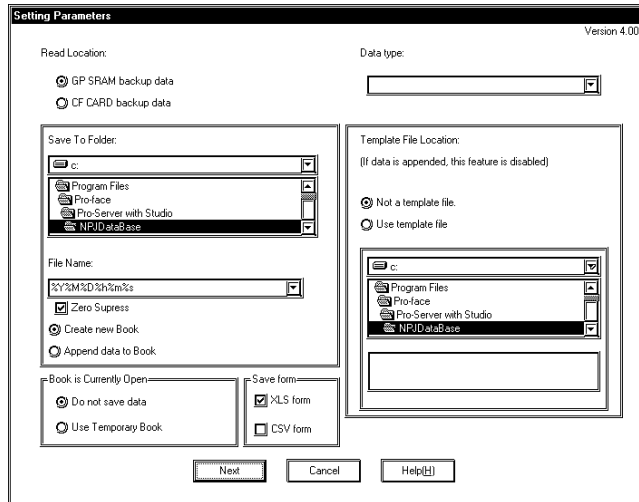

[Read Location]

Select a location to read data from, i.e. either SRAM or the CF Card.

[Data type]

Select one of the following items from the pull-down box

Logging Data

Trend Graph Data

Sampling Data

Alarm History Data

Alarm Log Data

Block 1 (When designating an alarm block in GP-PRO/PBIII for Windows)

Block 2 (When designating an alarm block in GP-PRO/PBIII for Windows)

Block 3 (When designating an alarm block in GP-PRO/PBIII for Windows)

[Save To Folder]

If you check the Save To Folder location in the action parameter display, and if the folder exists, the contents will appear exactly as you designated.

If the folder does not exist, the following window appears.

Click [Yes] to create the folder. The folder creation window will appear. If you click [No], the folder designation window will appear to designate the Save To Folder location.

If you click [Cancel], the process is canceled.

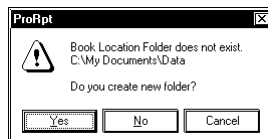
**[File Name]**

Default setting is a full date stamp, %Y%M%D%h%m%s

[Zero Suppress]

If you check this option, no zeros are supplied to the file name even though the file name includes any of "%M%D%h%m%s" (month, day, hour, minute, second).

If you do not check this option, 0 (zero) is supplied to the file name if the file name includes any of "%M%D%h%m%s" (month, day, hour, minute, second) and that number is one digit.

The default is "checked".

[File Save Method]

Select either [Create new Book] or [Append data to Book].

If you designate the fixed file name, it will be written in the sheet1.

[Book is Currently Open]

Select the action from [Do not save data] or [Use Temporary Book] when books with the same filename are open on writing.

If you selected [Do not save data], written data are not saved when book files with the same filename are open in advance.

If you selected [Use Temporary Book], written data are saved as a separate filename temporarily. The temporary filename will be "%Y%M%D%h%m%s.xls".

[Save form]

Selects from Excel (.xls) or text (.csv) file formats.

[Template File Location]

If [Use template file] is selected, be sure to enter the Drive, Folder and Template File name.

2. Clicking the previous Setting screen's [Next] button calls up the following screen.

[Select a Data Write Pattern]

Select the radio button that corresponds to the data write direction desired.

[Write Data Range]

Select the data range used for the data written to the file.

Clicking [Use Excel Sheet] will call up an Excel sheet and allow you to designate the range directly.

MEMO

When CSV is selected as a saving format, Template and Data write pattern can not be selected. Data write is fixed to [Z] type, [Use all cells], [Item names are not used], and [Time stamp is not used].

4.3.5 Automatic Download of GP Filing Data

This action item will automatically download filing data to a Provider's SRAM area, CF-Card, or internal FROM memory area.

Only data that has been previously uploaded from a GP can be downloaded. Also, uploaded data can only be modified, not added to or deleted.

MEMO

When data is being written to a GP's internal memory (FROM) or to its CF Card, the GP will switch to OFFLINE mode until the data transfer is completed. After the transfer is completed, the GP will be reset.

1. The following screen will appear.

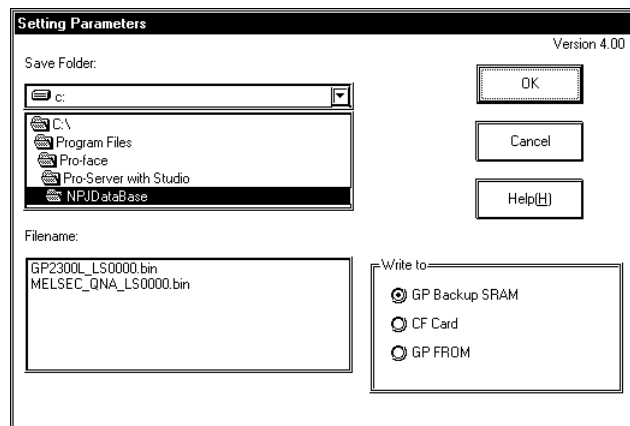

[Save Folder]

If you check the Save To Folder location in the action parameter display, and if the folder exists, the contents exactly as you designated is displayed.

If the folder does not exist, the following window appears.

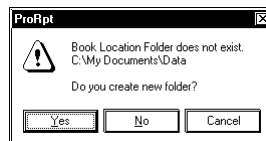

Click [Yes] to create the folder. The folder creation window will appear. If you click [No], the folder designation window will appear to designate the Save To Folder location.

If you click [Cancel], the process is canceled.

[Filename]

Designates where the write data source file will be saved. (either .bin or .xls)

[Write to]

Designates the write data's destination.

4.3.6 Automatic Upload of GP Filing Data

This action item will automatically upload filing data from a Provider's SRAM area, CF-Card, or internal FROM memory area.

MEMO

When data is being read from a GP's internal memory (FROM), the GP will switch to OFFLINE mode until the data transfer is completed. After the transfer is completed, the GP will be reset.

1. The following screen will appear.

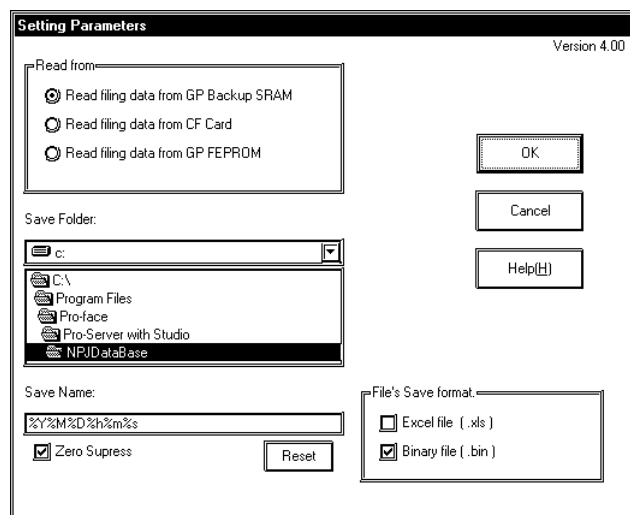

[Read from]

Designates the read data source file.

(SRAM, CF Card or internal FROM)

[Save Folder]

If you check the Save To Folder location in the action parameter display, and if the folder exists, the contents will appear exactly as you designated.

If the folder does not exist, the following window appears.

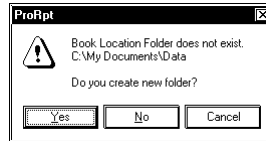

Click [Yes] to create the folder. The folder creation window will appear. If you click [No], the folder designation window will appear to designate the Save To Folder location.

If you click [Cancel], the process is canceled.

[Save Name]

Designate the file name used.

Default value is %Y%M%D%h%m%s. The [Reset] button will make your entry back to the default value.

[Zero Suppress]

If you check this option, no zeros are supplied to the file name even though the file name includes any of "%M%D%h%m%s" (month, day, hour, minute, second).

If you do not check this option, 0 (zero) is supplied to the file name if the file name includes any of "%M%D%h%m%s" (month, day, hour, minute, second) and that number is one digit.

The default is "checked".

[File's Save format]

Designates the format used when the file is saved. Either Excel (*.xls) or Binary (*.bin - for GP-PRO/PBIII for Windows) formats.

MEMO

When using a CF Card, the file No. is based on the Provider's data, to allow the saving of multiple files.

Ex. A file named ZF00002.BIN would be used for Provider 2.

4.3.7 Automatic Upload of Access Data

After the following table data has been created with Microsoft Access, the table data designated by an Action Item's settings is used to compare the Provider data and a Key_Code, and then read the device designated in the table.

Ex. This file will be named BIBLIO.mdb

Microsoft Access Table Structure Ex. "MAIN_TABLE"

Key_Code	.mdb (filename) *1	TBL (database table name)
1		Table 1
2		Table 2
3		Table 3

*1 If a duplicate file name exists, leave this cell blank.

Database Table Name Ex. "Table 1"

Node	Symbol	Type	Data *2	Number
_GP1	D1000_WORD	2	1,2,3,4,5	5
_GP1	D1010_WORD	2		7
_GP2	DM1000_WORD	2		5

Table 2
Table 3

*2 PLC device data is read out according to the data in the table.

Data Structure: Multiple data items are delineated by commas within a single field.

1. When the Setting Screen Appears, enter the following data, based on the above example.

[Access Data Folder]

Enter the save destination (drive and folder).

[mdb Filename]

Designate the mdb filename.

[Table]

Select the reference table.

When an mdb file is selected, all the mdb tables are automatically displayed.

[Save Folder]

If you check the Save To Folder location in the action parameter display, and if the folder exists, the contents you designated are displayed.

If the folder does not exist, the following window appears.

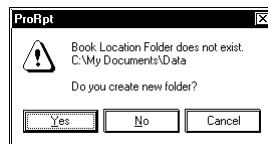

Click [Yes] to create the folder. The folder creation window will appear. If you click [No], the folder designation window will appear to designate the Save To Folder location.

If you click [Cancel], the process is canceled.

[Save Filename]

Designate the save filename.

Default value is %Y%M%D%h%m%s. The [Reset] button will make your entry back to the default value.

[Zero Suppress]

If you check this option, no zeros are supplied to the file name even though the file name includes any of "%M%D%h%m%s" (month, day, hour, minute, second).

If you do not check this option, 0 (zero) is supplied to the file name if the file name includes any of "%M%D%h%m%s" (month, day, hour, minute, second) and that number is one digit.

The default is "checked".

4.3.8 Automatic Download of Access Data

After the following table data has been created with Microsoft Access, the table data designated by the Action Item settings is used to compare the Provider data and a Key_Code, and then write the designated device data into the table.

KEY Master Table

Key_Code	.mdb (filename)	TBL (database table name)
1	c:\ACCESSDEMO.mdb	Table 1
2	c:\ACCESSDEMO.mdb	Table 2
3	c:\ACCESSDEMO.mdb	Table 3
4	c:\ACCESSDEMO.mdb	Table 4
5	c:\ACCESSDEMO.mdb	Table 5

Database Table Name Ex. "Table 1"

Node	Symbol	Type	Data*1	Number
_GP1	D1000_WORD	2	10,20,30	3
_GP1	D1010_WORD	2	15,25,35	3
_GP2	DM1000_WORD	2	30,40,50	3

Table 2

Table 3

*1 Delimited by commas

1. When the Setting Screen Appears, enter the following data, based on the above example.

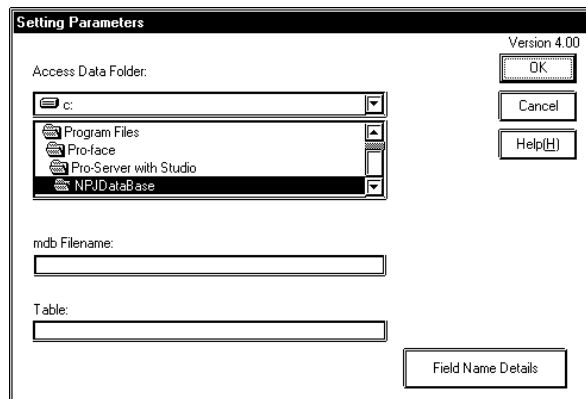

[Access Data Folder]

Designate the Access file name (drive and folder)

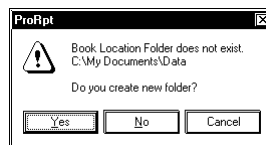

Click [Yes] to create the folder. The folder creation window will appear. If you click [No], the folder designation window will appear to designate the Save To Folder location.

If you click [Cancel], the process is canceled.

[mdb Filename]

Select the desired mdb file.

[Table]

Select the desired Table file.

MEMO

Be sure to select the mdb file with the KEY Master Table Type data.

4.3.9 Download Recipe Data for Excel

This feature writes Microsoft Excel sheet data to the specified device address. The following two types of Excel sheet data can be used for designating write data.

MEMO

- A device access is executed in 255 per scan. If you designated more than 255, a time lag will occur.
- If you designate a device address that do not exist, a device access error will occur.

Column Change [One Sheet Mode] Type

If the provider's data and a Block No. matches, the data in that column will be written into the device address specified in [Address]. Only one device address can be specified. [Item] specifies the number of sequential words (up to 10,000 words) to write from the first address specified in [Address].

Block		3	
Item		5	
Address		D108	
Data Type		2	
Block1	Block2		Block3
	1	12	21
	13	2	6
	18	7	3
	8	17	10
	22	9	14

MEMO

The sample table file is available in "\Pro-Server with Pro-Studio\Pro-SDK".

Column Change [Any Sheet Mode] Type

If the provider's data and a Sheet No. matches, the data in that sheet will be written into the device address(es) specified in [Address]. Multiple device addresses can be specified at a time. [Item] specifies the number of sequential words to write from the first address specified in [Address].

Block	4			
Block Name	1	2	3	4
Address	D100	D200	D300	D400
Item	7	5	7	2
Data Type	2	2	2	3
	1	2	1	4
	2	4	2	4
	2	5	2	
	3	6	3	
	4	7	4	
	5		5	
	7		7	

1. After selection, the following setting window will appear.

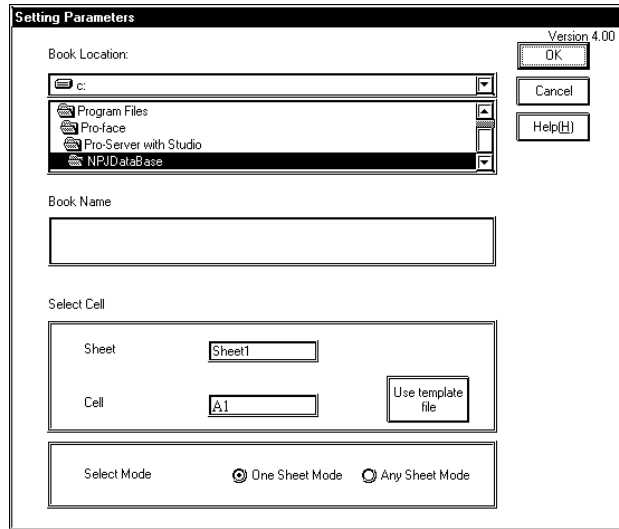

[Book Location]

Designate the Excel file name.

If you check the Save To Folder location in the action parameter display, and if the folder exists, the contents you designated are displayed.

If the folder does not exist, the following window appears.

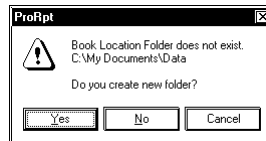

Click [Yes] to create the folder. The folder creation window will appear. If you click [No], the folder designation window will appear to designate the Save To Folder location.

If you click [Cancel], the process is canceled.

[Select Cell:Sheet]

Select the desired Excel sheet name to read. When [Any Sheet Mode] is selected in [Column change], sheet name will change to [Sheet%n].

[Select Cell:Cell]

Designate the first cell to be read. Click [Reference] to allow you to designate the cell at Excel.

[Select Mode]

Designate the data sheet type to be written.

4.3.10 Writing Data to E-Mail

E-Mail can be sent without programming. The provider's data or the message sheet created by Excel can be used as mail contents. Multiple error information can also be sent to E-Mail and this feature allows you to urgently contact employees or managers about site problems without a human intervention.

There are three mailing methods available.

- Send Provider data as Title
- Send fixed Title
- Send Title and message using Provider data

The following describes the setup contents of each method.

"Send Provider Data as Title"

Uncheck [Title name] and [Table] and designate the symbol type to the Provider information setup.

"Send Fixed Title"

Check [Title name] field and designate a Title.

"Send Title and Message Using Provider Data"

Check [Table name] and designate the template file created by Microsoft Excel.

If Provider data matches to the value in the Key_Code field, data in that line will be sent.

Example of Microsoft Excel Message Sheet

Key_Code	Title	Message	Address
1	Device A Failure	Valve 1 failed.	a@zzzzz.com, ab@zzzzz.com
1	Device A Failure	Device A stopped due to a failure.	kanri@zzzzz.com
1	Device A Failure	Valve 1 failed. The repair part is at F1.	c@zzzzz.com
2	Device C Failure	Valve 2 failed.	a@zzzzz.com
2	Device C Failure	Device C stopped due to a failure.	kanri@zzzzz.com
2	Device C Failure	Valve 2 failed. The repair part is at F1.	b@zzzzz.com
3	Device B Failure	Oil pressure of device B is abnormal.	a@zzzzz.com
3	Device B Failure	Oil pressure of device B is abnormal.	b@zzzzz.com
3	Device B Failure	Device B stopped due to a failure.	kanri@zzzzz.com

MEMO

- You can register, at maximum, 5 messages with the same Key_Code.
- If it fails in sending, an error message will appear in the log viewer.

1. After selection, the following setting window will appear.

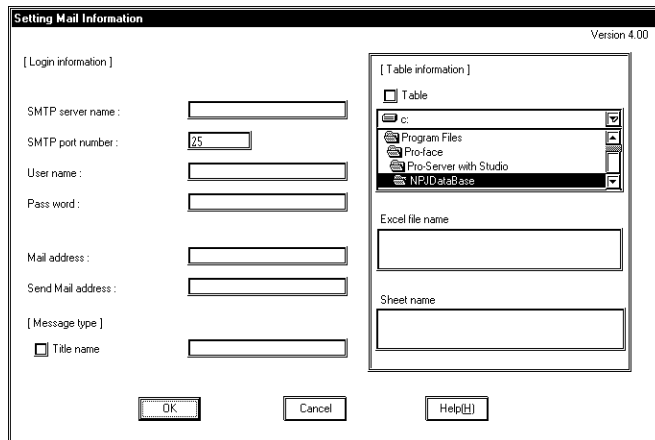

[Mail server settings]

Specify the mail server to send.

[Mail address]

Enter the sender's mail address

[Send Mail address]

Enter a receiver's mail address.

[Message type]

Set when sending a fixed message attached.

[Table information]

Designate when Microsoft Excel message sheet is used to send.

If provider's data matches Key_code, title and message in the specific line will be sent.

If you check the Save To Folder location in the action parameter display, and if the folder exists, the contents you designated are displayed.

If the folder does not exist, the following window appears.

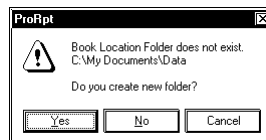

Click [Yes] to create the folder. The folder creation window will appear. If you click [No], the folder designation window will appear to designate the Save To Folder location.

If you click [Cancel], the process is canceled.

4.3.11 Upload to Database

Reads data from device address(es) specified by Microsoft Excel or Access and write into designated relational database.

Using Excel, the data will directly be written into the relational database. Using Access, data will once be saved in file and then be written into the relational database. Even if it is presently not possible to connect to the relational database, the saved data can be written to the relational database at the next action start-up.

The table field of the designated contents should exist in the relational database.

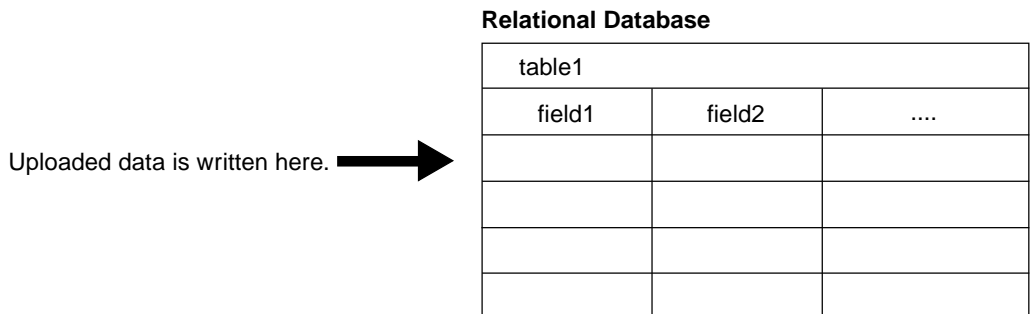

Example of Microsoft Excel/Access Sheet/Table (respectively)

Data Base	Table	Device	Field	Type
DBA	table1	D100	field1	2
DBA	table1	D101	field2	2
DBB	table2	D102	field1	2

MEMO

The sample table file (ProDB.xls) is available in "\Pro-Server with Pro-Studio\Pro-SDK".

When using ProDB.xls, DataBase.mdb is in the same folder as the sample in the relational database.

1. After selection, the following setting window will appear.

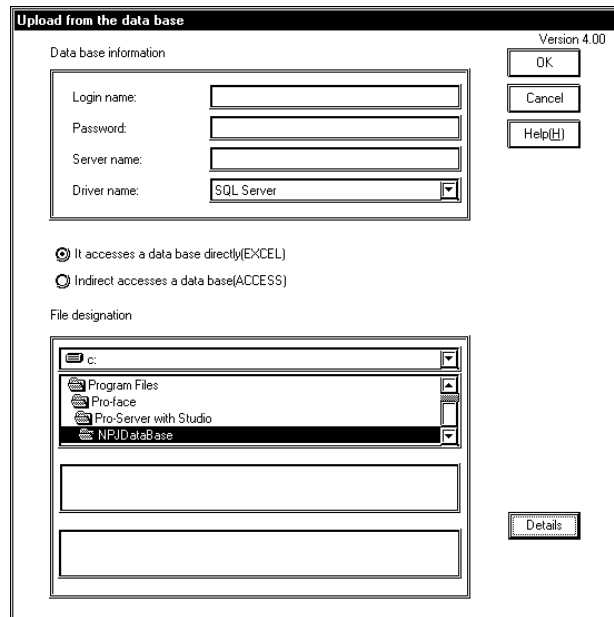

[Database Information]

Designate required informations to access database server.

[Database Access Method]

Select whether write to the database at once (Excel) or write to the database after save (Access).

[File designation]

Designate a file location and a sheet/table name.

If you check the Save To Folder location in the action parameter display, and if the folder exists, the contents exactly as you designated is displayed.

If the folder does not exist, the following window appears.

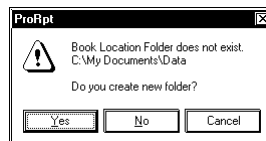

Click [Yes] to create the folder. The folder creation window will appear. If you click [No], the folder designation window will appear to designate the Save To Folder location.

If you click [Cancel], the process is canceled.

2. When clicking [Details], the following setting window will appear.

A setup of details

Automatic establishment

Node name:

Time:

A setup of a server

Server connection time:

Retry number of times:

[Automatic establishment]

Select when provider's name and/or data time are required to be written and enter the target field name(s).

[A setup of a server]

Enter the sequential communication time to database server and the number to retry.

4.3.12 Download from Database

Reads data from the relational database specified by Microsoft Excel or Access and write into the specific device address(es).

Using Excel, the data will directly be written into the specified device address(es), while, using Access, data will once be written once as Access file and then be written into the specified device address(es).

Example of Microsoft Excel/Access Sheet/Table (respectively)

Data Base	Table	Device	Field	Type
DBA	table1	D100	field1	2
DBA	table1	D101	field2	2
DBB	table2	D102	field1	2

seq No.	F1	F2	F3
1	100	110	130
2	101	111	131
3	102	112	132
4	103	113	133

1. After selection, the following setting window will appear.

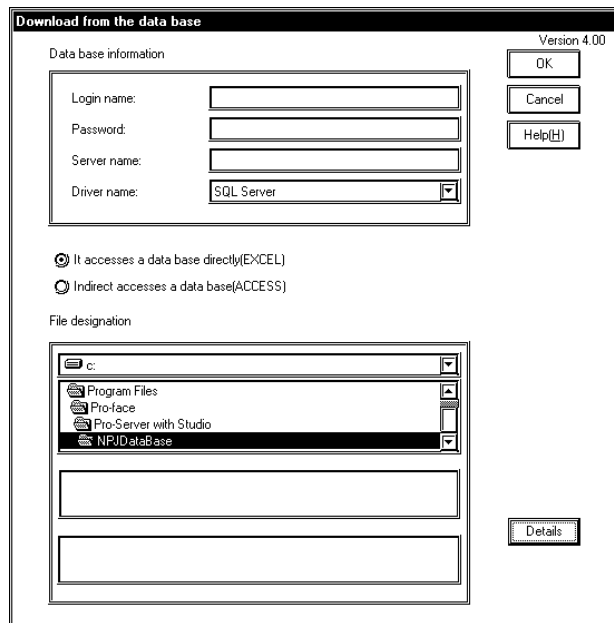

[Database Information]

Designate the required information to access the database server.

[Database Access Method]

Select data is written from the database at once (Excel) or written after being saved (Access).

[File designation]

Designate a file location and a sheet/table name.

If you check the Save To Folder location in the action parameter display, and if the folder exists, the contents exactly as you designated is displayed.

If the folder does not exist, the following window appears.

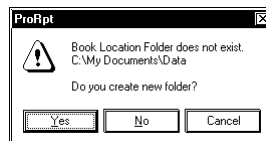

Click [Yes] to create the folder. The folder creation window will appear. If you click [No], the folder designation window will appear to designate the Save To Folder location.

If you click [Cancel], the process is canceled.

- When clicking [Details], the following setting window will appear.

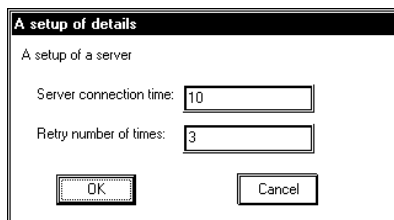

A setup of details

A setup of a server

Server connection time:

Retry number of times:

[A setup of a server]

Enter the communication time to the database server and the number of retries performed.

4.3.13 Upload of GP JPEG Data

Pro-Server allows you to read the on-line GP screen data in your PC. If the VM unit is attached to the GP, video capture data can also be read.

Prior to performing this action with the CF Card inserted into the GP because the read data is temporarily saved in the CF Card.

You can use this action on GP-2000 series, GLC2000 series and IT series.

1. The following window appears. After designating all items, click [OK].

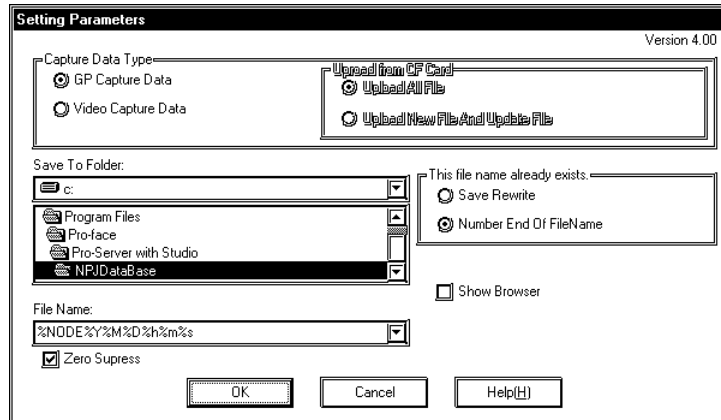

[Capture Data Type]

Select data to read.

If you selected "GP Capture Data", the displayed GP screen is captured and uploaded.

If you selected "Video Capture Data", the video screen data saved in the CF Card is uploaded. If you select [Video Capture Data], you can not designate [File Name], [Zero Suppress] or [Show Browser].

The default is "GP Capture Data".

[Upload from CF Card]

You should select either to upload all the video screen data in the CF Card, or to upload only files that do not exist in the directory designated by [Save To] or that have been updated.

This defaults to "Upload All Files".

This item can be designated only when [Video Screen Saving Data] has been selected at [Select Data to Read].

For how to capture video screens:

Reference → "GP-PRO/PBIII for Windows Tag Reference"

[Save To Folder]

If you check the Save To Folder location in the action parameter display, and if the folder exists, the contents exactly as you designated is displayed.

If the folder does not exist, the following window appears.

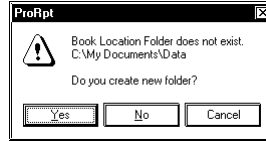

Click [Yes] to create the folder. The folder creation window will appear. If you click [No], the folder designation window will appear to designate the Save To Folder location.

If you click [Cancel], the process is canceled.

[File Name]

Designate the file name to save JPEG files read. The extension is "*.jpg". This is defaulted to "%NODE%Y%M%D%h%m%s" (node name, year, month, day, hour, minute, second). The exact file name in the CF Card is used if [Video Screen Saving Data] has been selected at [Select Data to Read].

[Zero Suppress]

If you check this option, no zeros are supplied to the file name even though the file name includes any of "%M%D%h%m%s" (month, day, hour, minute, second).

If you do not check this option, 0 (zero) is supplied to the file name if the file name includes any of "%M%D%h%m%s" (month, day, hour, minute, second) and that number is one digit.

The default is "checked".

[This file name already exists.]

If you wish to overwrite existing files, check [Save Rewrite]. If you do not want to overwrite existing files, check [Number End of File Name].

This is defaulted to [Number End of File Name].

[Show Browser]

When this item is checked, the data uploaded is displayed using a special JPEG file browser.

This browser can be used to print, copy or call (start up) other Windows JPEG "viewer" applications (Internet Explorer, Paint, etc.).

MEMO

When you execute [Save GP Capture Data], drawings and operations on the GP screen will stop for a few seconds. Therefore, you cannot normally execute the GP screen capturing operation from upper-level PCs. You should set the bit "0" of GP's LS2076 to "ON (1)" to capture GP screens from upper-level PCs. The bit "0" of LS2077 will be set to "ON (1)" while capturing.

4.4 Action Item Designation

The following description explains how to designate an action item.

Transfer the Network Project file to the GP unit to make the specific Action effective. Action items can be designated via the [Provide Information] dialog box.

1. Designate the Condition and Provider Node Symbol Names. Then, select an action item for the Consumer's symbol name.

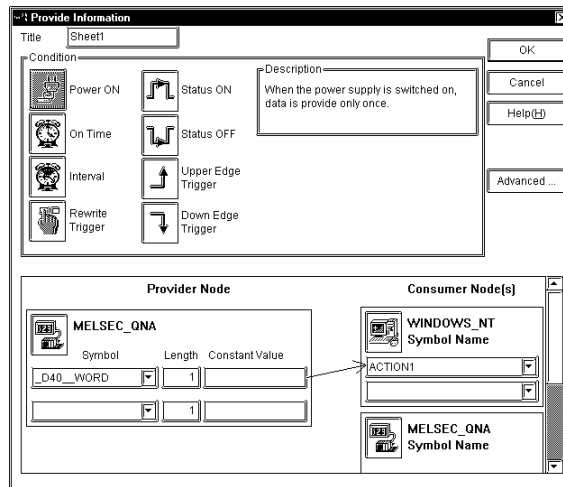

An action item can be selected only via the Consumer's Windows computer.

For the detailed information about entering configuration data, refer to “3.3 Registering Provider Data”
Action items must be registered before they can be used. To register new action items, click the [Action Registration] button.

Reference → “4.2 Action Item Registration”

- Click the [OK] button, and the action will be added to the Provider information list.

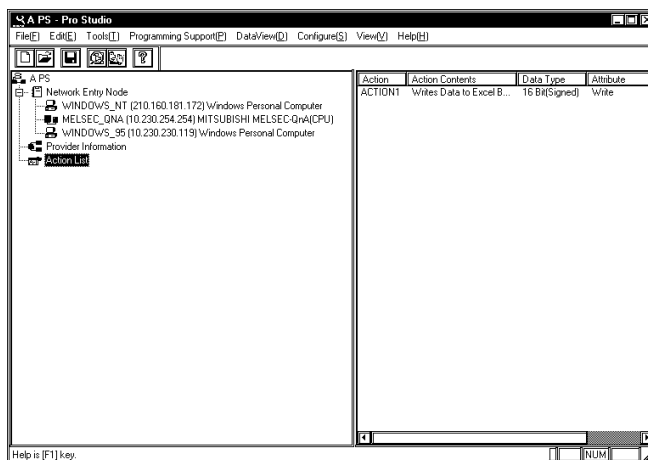

The following table shows the data types that you can designate to the Provider node's symbol name for each action item.

Action Items	Bit	16 Bits				32 Bits				Single Precision	Double Precision	Character
		Signed	Unsigned	HEX	BCD	Signed	Unsigned	HEX	BCD			
Start an Application	<input type="radio"/>	<input type="radio"/>	<input type="radio"/>	<input type="radio"/>	<input type="radio"/>	<input type="radio"/>	<input type="radio"/>	<input type="radio"/>	<input type="radio"/>	<input type="radio"/>	<input type="radio"/>	<input type="radio"/>
Write Data to Excel Book	<input type="radio"/>	<input type="radio"/>	<input type="radio"/>	<input type="radio"/>	<input type="radio"/>	<input type="radio"/>	<input type="radio"/>	<input type="radio"/>	<input type="radio"/>	<input type="radio"/>	<input type="radio"/>	<input type="radio"/>
Alarm Log (with voice notification feature)	<input type="radio"/>	<input type="radio"/>	<input type="radio"/>	<input type="radio"/>	<input type="radio"/>	<input type="radio"/>	<input type="radio"/>	<input type="radio"/>	<input type="radio"/>	<input type="radio"/>	<input type="radio"/>	<input type="checkbox"/>
Upload of GP Log Data	<input type="radio"/>	<input type="radio"/>	<input type="radio"/>	<input type="radio"/>	<input type="radio"/>	<input type="radio"/>	<input type="radio"/>	<input type="radio"/>	<input type="radio"/>	<input type="radio"/>	<input type="radio"/>	<input type="checkbox"/>
Automatic Download of GP Filing Data	<input type="radio"/>	<input type="radio"/>	<input type="radio"/>	<input type="radio"/>	<input type="radio"/>	<input type="radio"/>	<input type="radio"/>	<input type="radio"/>	<input type="radio"/>	<input type="radio"/>	<input type="radio"/>	<input type="checkbox"/>
Automatic Upload of GP Filing Data	<input type="radio"/>	<input type="radio"/>	<input type="radio"/>	<input type="radio"/>	<input type="radio"/>	<input type="radio"/>	<input type="radio"/>	<input type="radio"/>	<input type="radio"/>	<input type="radio"/>	<input type="radio"/>	<input type="checkbox"/>
Automatic Upload of Access Data	<input type="radio"/>	<input type="radio"/>	<input type="radio"/>	<input type="radio"/>	<input type="radio"/>	<input type="radio"/>	<input type="radio"/>	<input type="radio"/>	<input type="radio"/>	<input type="radio"/>	<input type="radio"/>	<input type="checkbox"/>
Automatic Download of Access Data	<input type="radio"/>	<input type="radio"/>	<input type="radio"/>	<input type="radio"/>	<input type="radio"/>	<input type="radio"/>	<input type="radio"/>	<input type="radio"/>	<input type="radio"/>	<input type="radio"/>	<input type="radio"/>	<input type="checkbox"/>
Download of Excel Receipt	<input type="radio"/>	<input type="radio"/>	<input type="radio"/>	<input type="radio"/>	<input type="radio"/>	<input type="radio"/>	<input type="radio"/>	<input type="radio"/>	<input type="radio"/>	<input type="radio"/>	<input type="radio"/>	<input type="checkbox"/>
Data Sending by Mail (Specifying an Subject)	<input type="radio"/>	<input type="radio"/>	<input type="radio"/>	<input type="radio"/>	<input type="radio"/>	<input type="radio"/>	<input type="radio"/>	<input type="radio"/>	<input type="radio"/>	<input type="radio"/>	<input type="radio"/>	<input type="radio"/>
Data Sending by Mail (Specifying a Table)	<input type="checkbox"/>	<input type="radio"/>	<input type="radio"/>	<input type="radio"/>	<input type="checkbox"/>	<input type="checkbox"/>	<input type="checkbox"/>	<input type="checkbox"/>	<input type="checkbox"/>	<input type="checkbox"/>	<input type="checkbox"/>	<input type="checkbox"/>
Data Sending by Mail (no specifications)	<input type="checkbox"/>	<input type="checkbox"/>	<input type="checkbox"/>	<input type="checkbox"/>	<input type="checkbox"/>	<input type="checkbox"/>	<input type="checkbox"/>	<input type="checkbox"/>	<input type="checkbox"/>	<input type="checkbox"/>	<input type="checkbox"/>	<input type="radio"/>
Download to Database	<input type="radio"/>	<input type="radio"/>	<input type="radio"/>	<input type="radio"/>	<input type="radio"/>	<input type="radio"/>	<input type="radio"/>	<input type="radio"/>	<input type="radio"/>	<input type="radio"/>	<input type="radio"/>	<input type="radio"/>
Upload from Database	<input type="checkbox"/>	<input type="radio"/>	<input type="radio"/>	<input type="radio"/>	<input type="checkbox"/>	<input type="checkbox"/>	<input type="checkbox"/>	<input type="checkbox"/>	<input type="checkbox"/>	<input type="checkbox"/>	<input type="checkbox"/>	<input type="radio"/>
Upload of GP JPEG Data	<input type="radio"/>	<input type="radio"/>	<input type="radio"/>	<input type="radio"/>	<input type="radio"/>	<input type="radio"/>	<input type="radio"/>	<input type="radio"/>	<input type="radio"/>	<input type="radio"/>	<input type="radio"/>	<input type="radio"/>

When an Action designates a Data Type using a value (1 to 12), be sure to use the following table values.

Value	Data Type	Value	Data Type
1	Bit	7	Unsigned 32 Bit
2	Signed 16 Bit	8	HEX 32 Bit
3	Unsigned 16 Bit	9	BCD 32 Bit
4	HEX 16 Bit	10	Float
5	BCD 16 Bit	11	Double
6	Signed 32 Bit	12	String

5 | GP Setup

This chapter explains how to transfer a Pro-Studio network project file (*.npj) and a GP-PRO/PB III project file (*.PRW) to a connected GP.

5.1 Transferring Data to GPs

5.1 Transferring Data to GPs

In the GP-PRO/PBIII screen editor software, select the network project file and node name and transfer the desired data to the connected GPs. The following description assumes that the GP-PRO/PBIII Ver. 3.0 Transfer feature's window is open.

MEMO

Be sure to first install the 2-Way driver in order to transfer a network project file (*.npj) from the GP-PRO/PB III for Windows to a GP unit.

Reference → “2.1 Installing the Software”

1. Click on [2WayDriver] in the [Setup] menu.

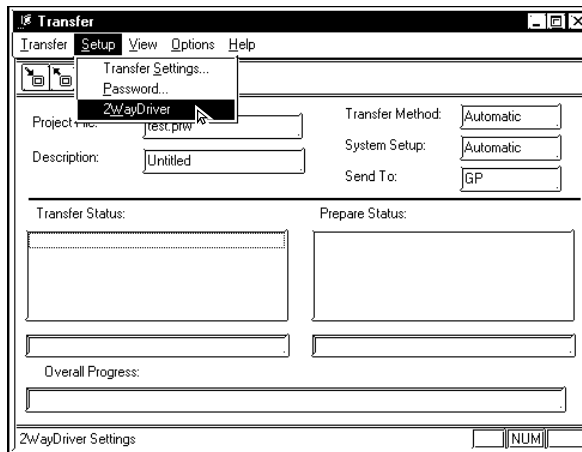

MEMO

- When transferring the network project file with GP-PRO/PBIII for Windows, use the data transfer cable.
- Transferring your screen data in the on-line mode temporarily causes the GP to display the transfer screen. The initial screen will be restored as soon as the data transfer is completed.

2. Select [TwoWayEther] from the [Driver Type] pull-down list.

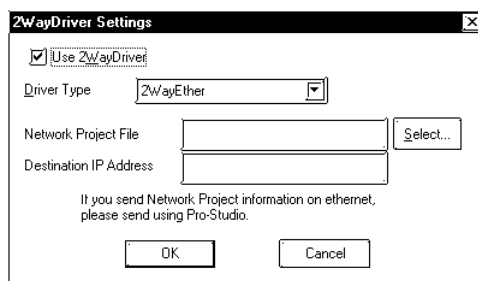
**MEMO**

To send to GP77R series, be sure to click on the [Use 2Way Driver] checkbox. Otherwise, the 2-Way Driver will not function. [Use 2Way Driver] checkbox is initially checked for GP2000, GLC2000 series.

3. Select [2WayEther] from the [Driver Type] pull-down list.

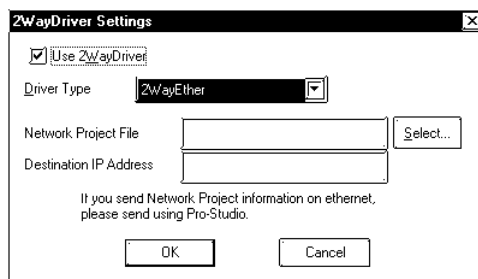

4. Select the network project file and the network node to which you wish to transfer the information and then click [OK].

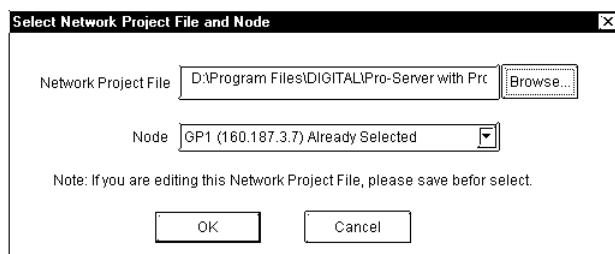

5. Click [Send] on the Transfer menu or the Send Screen button to transfer the information to the GP.

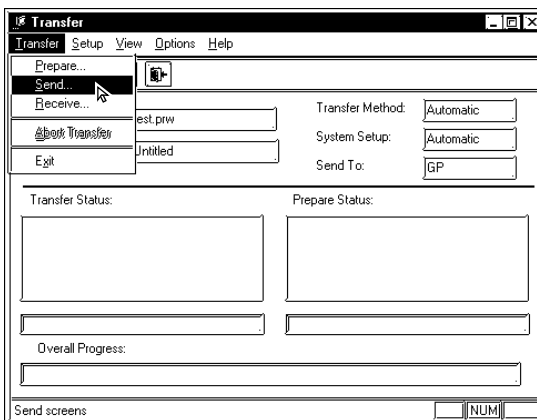

Send
Screen
button

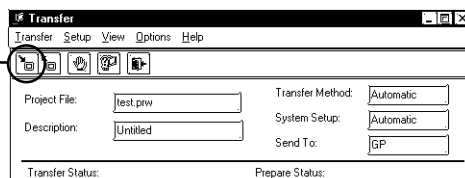

6. The transfer is completed if no error message is displayed.

6 | Tools

This chapter describes monitoring tools.

- 6.1 Device Monitoring
- 6.2 GP Status Monitoring
- 6.3 Read Performance Measuring Tool

6.1 Device Monitoring

Any selected device can be monitored via this feature, which allows you to check the status of data communication. Also, in the [Device Monitor] window, you can specify the IP and device addresses.

1. Click on the symbol name you want to monitor.

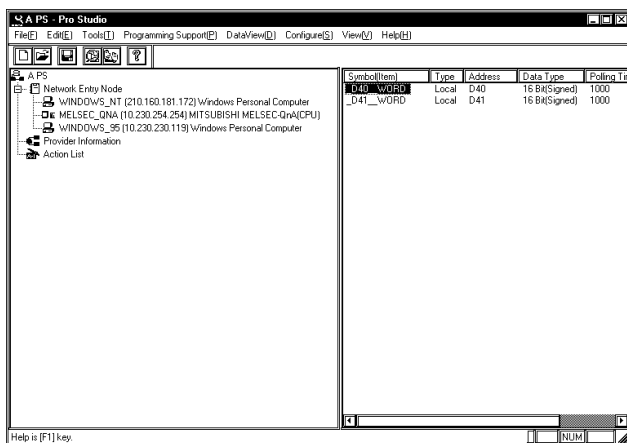

[Symbol (Item)]

The registered symbol names are listed here.

2. Click [Device Monitor] in the [Tools(I)] menu.

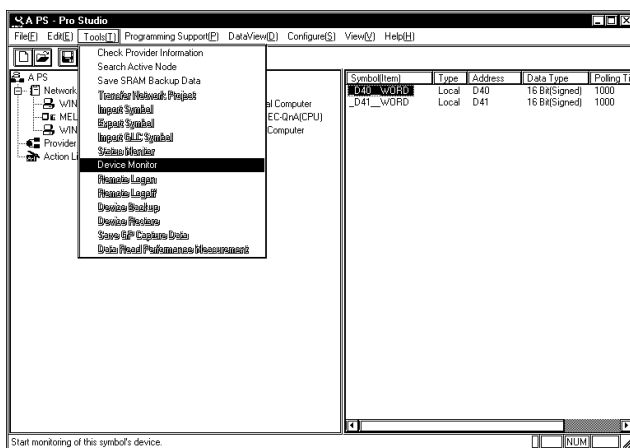

You can right-click the symbol to select [Device Monitor] from the shortcut menu.

3. To change the polling time and the number of displayed decimal places, click [Polling Time].

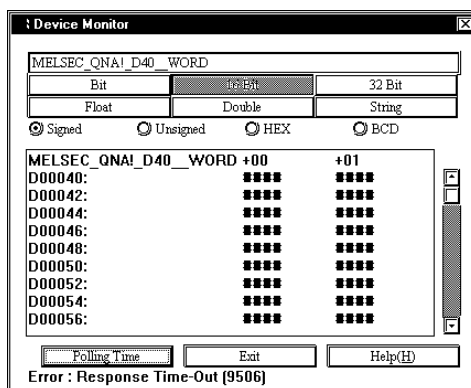

You can type in the IP address or device address directly.

Reference → On-line Help.

4. Enter the desired polling time, number of decimal places displayed and then click [OK].

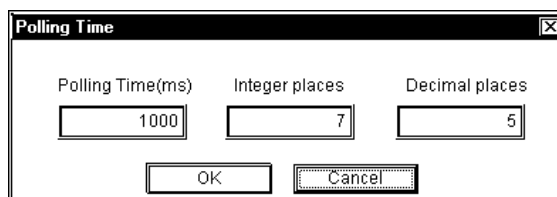

Up to 15 values can be entered (total of both integer and decimal place values)

For details of each item, refer to On-line Help.

Reference → “On-line Help”

MEMO

The polling time set for collecting or writing data for each symbol, distributing data and monitoring devices may not be able to be performed under certain conditions. These conditions include the currently registered number of GPs, number of Tags used on each screen sent, type of PLC connection, and number of other currently open Windows applications. Entering “0” will allow the system to operate at its maximum speed. Please use this value as a benchmark when entering other values to “fine-tune” your system.

If you try to monitor an in-existent device, the communication error message will appear on the GP screen.

6.2 GP Status Monitoring

Here, you can monitor the status of any GP connected to the network.

1. Click the node you wish to monitor.

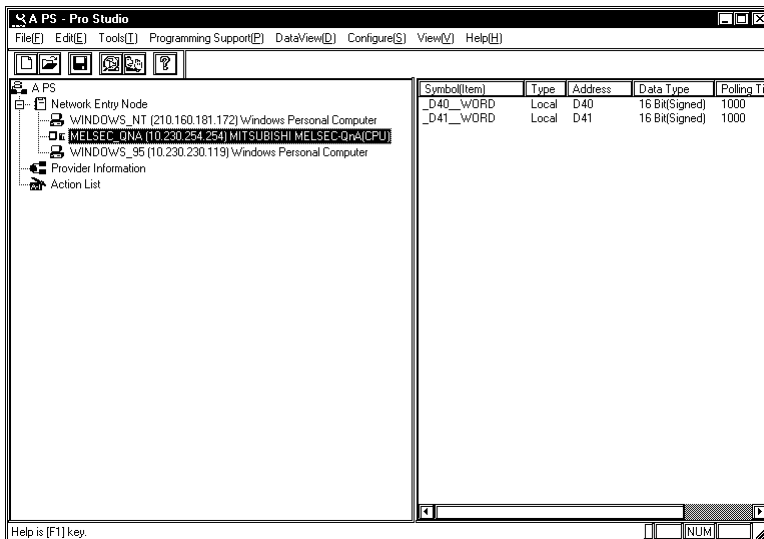

You can right-click the symbol to select [Status Monitor] from the shortcut menu.

2. Click [Status Monitor] in the [Tools(T)] menu.

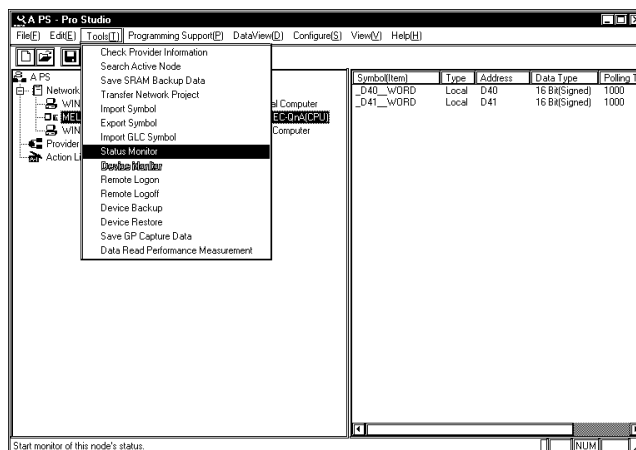

3. Monitor the status of the GP. To change the polling time, click [Setting].
Click [Clear] to clear communication error codes of the selected node.

If you click [Clear], the following communication error codes will be cleared.

- PLC communication error code
- PLC communication error code (for an extension)
- 2-Way communication error code

Reference →“A.2.2 2-Way Driver Error Messages and Syslog Features”

4. Set the polling time and then click [OK].

MEMO

The polling time set for collecting or writing data for each symbol, distributing data and monitoring devices may not be able to be performed under certain conditions. These conditions include the number of currently registered GPs, number of Tags used on each screen sent, type of PLC connection, and number of other currently open Windows software. Entering “0” will allow the system to operate at its maximum speed. Please use this value as a benchmark when entering other values to “fine-tune” your system.

6.3 Read Performance Measuring Tool

This tool allows you to measure the data read performance from the designated node.

1. Click [Data Read Performance Measurement] on the [Tools (I)] bar of the Menu Bar.

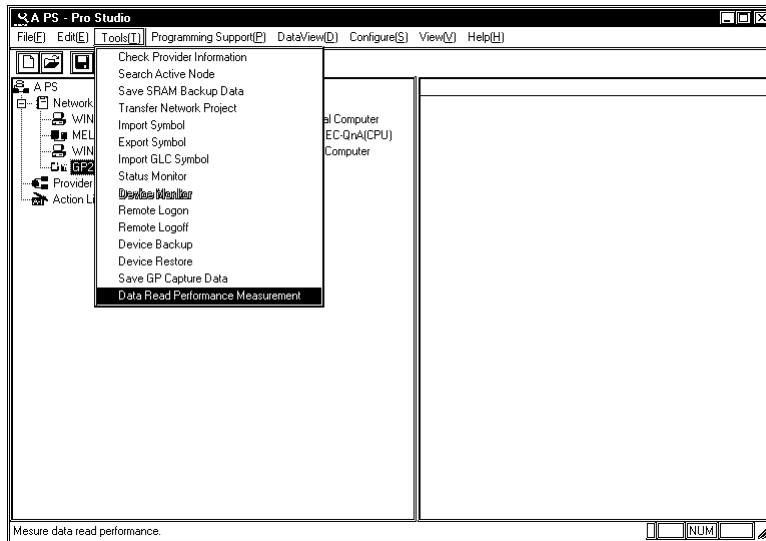

2. The [Data Read Performance Measurement] window appears. After designating all items, click [Begin].

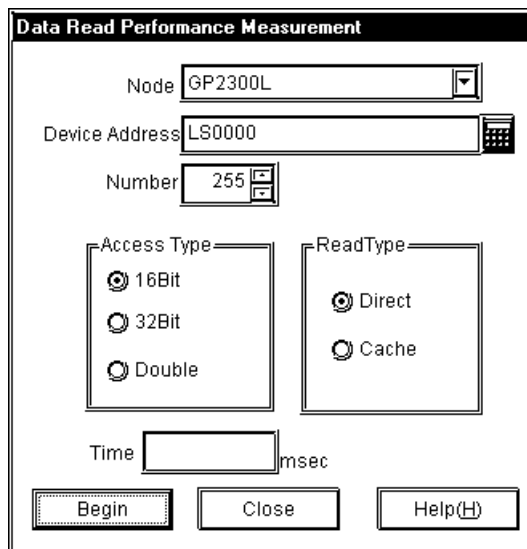

[Node]

Select the node name. All entry node names have been registered. If unselected, the error dialog will appear.

[Device Address]

Enter the device address or the symbol name to start measuring. This is defaulted to “LS0000” (This will vary depending on the PLC model). If not entered or entered an incorrect address, the error dialog will appear.

If you click the right-side icon, the [Device Address Entry] window appears and you can designate the device address from this window.

[Number]

Enter the number of device addresses to measure. This is defaulted to 255. The minimum value is 1 and the maximum value depends on the device address or the address type. You can enter the value up to 65535.

[Access Type]

Select the access type. This is defaulted to “16 Bit”.

[Read Type]

Designate the read type. This is defaulted to “Direct”.

[Time]

The measured read performance value after the execution is displayed.

3. The processing status of the read performance measuring is displayed in the [now] dialog.

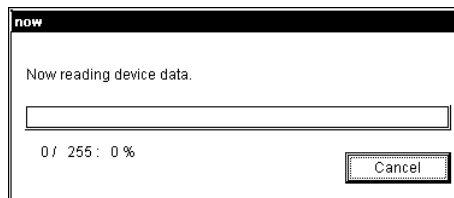

4. The measured result is displayed in the [Time] field of the [Data Read Performance Measurement] window.

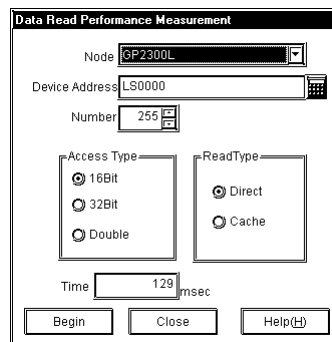

MEMO

[Time] may vary depending on the environmental condition (number of tags on a screen, PLC connection style, application software running on Windows at the same time and so on).

7 | Data View

This chapter describes data sampling/viewing tools, “GP-Viewer” and “Device View”.

- 7.1 Data View Overview
- 7.2 Device View
- 7.3 GP-Viewer
- 7.4 Checking the Data Sampling Status
- 7.5 System Time Bar

7.1 Data View Overview

The [Data View(D)] menu of the menu bar allows you to start the tool to display data saved on Pro-Server in various formats.

The following shows the overview of the display tool.

Device View

Device View allows you to sample data from devices connected to Ethernet to monitor the status or to playback saved device data on Device View.

GP-Viewer

GP-Viewer allows you to sample screen data from the GP system connected to Ethernet to display screen data or to playback saved GP data on GP-Viewer.

In addition to the above, you can also use the [Data Sampling Status] dialog showing the data sampling status on Pro-Server or the tool such as System Time Bar applicable to user created application software.

The frame structures of Device View, GP_Viewer and the [Data Sampling Status] dialog differ from other windows. The following shows the general view.

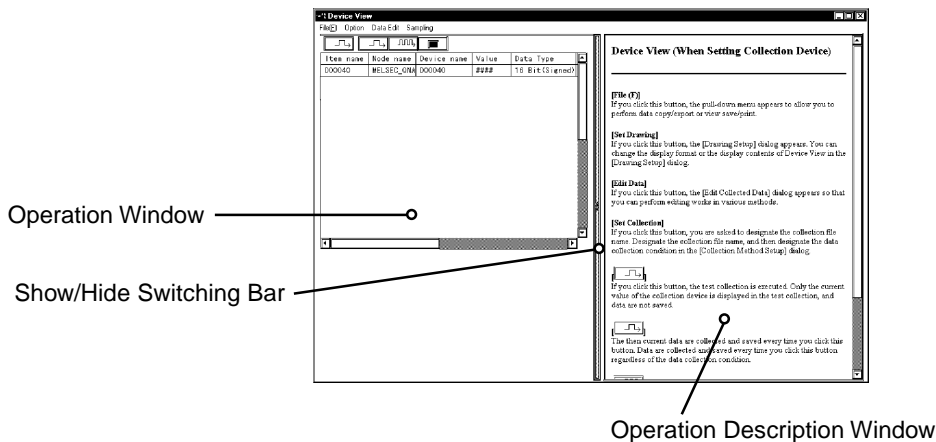

MEMO

You can only install the trial version of "GP Viewer" from the "Pro-Server with Pro-Studio for Windows Ver.4.0" CD-ROM. When a trial version of the GP-Viewer software is used, the words "Trial Edition" will appear on the splash screen. All the program's features, however, are the same as the official version.

You need to purchase it separately to use the official version of "GP_Viewer".

In this chapter, the whole usage procedure of "GP_Viewer" is described.

Following four files are created by Device View.

- ***.#DV Sampled device information (text format)
- ***.#DB Sampling method information (text format)
- ***.#SR Sampled device optimal information (text format)
- ***.#DR Saved data (binary format)

MEMO

When using Data View, the database accessed, even if it is only temporarily, will be registered as a network project. If, during data polling the system should go down, once the system is restored, simply restarting Pro-Server will automatically restarts the data polling. (Polling data is saved in a file using the same file extension as a Network Project file - NPJ_DBs.)

When Pro-Server is started, the Network Project's registered databases are read. As a result, if a large number of databases are registered, Pro-Server's startup will be slowed, and can result in the use of a large amount of system resources. As a result, please be sure to delete any temporary databases that are no longer used from the Network Project's registry. To do this, open Pro-Studio's [DataView (D)] menu's [Data Sampling Status] dialog box. Click on the unneeded database names and press your PC keyboard's [Delete] key. Even though this deletes the database from the Network Project, the database itself is not deleted. If needed, the database file can be reopened by simply re-registering it in the Network Project.

7.2 Device View

Device View allows you to sample data from devices connected to Ethernet to monitor the status or to playback saved device data on Device View.

You can also view non-sequential devices or devices of multiple entry nodes at one time.

7.2.1 Setting Sampling Target Device

This section describes how to designate the device that you wish to sample data. After you completed the setup, you can monitor data of the target device.

1. After selecting the entry node that you wish to sample data, click [Device View] on the [Data View (D)] menu of the Menu Bar.

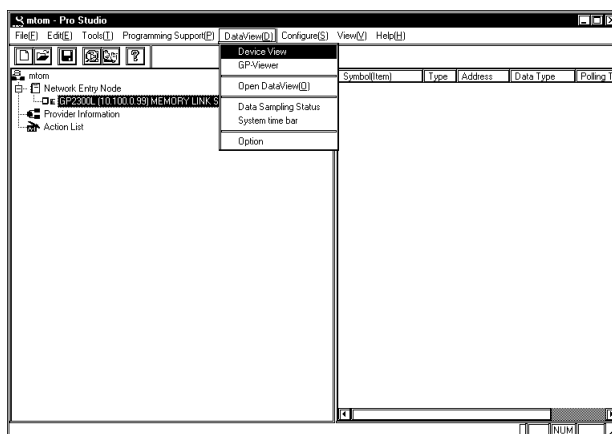

You can also right-click the entry node to select “GP-Viewer”.

- The [Data sampling source] window appears. After designating each item for the device that you wish to sample data, click [Next].

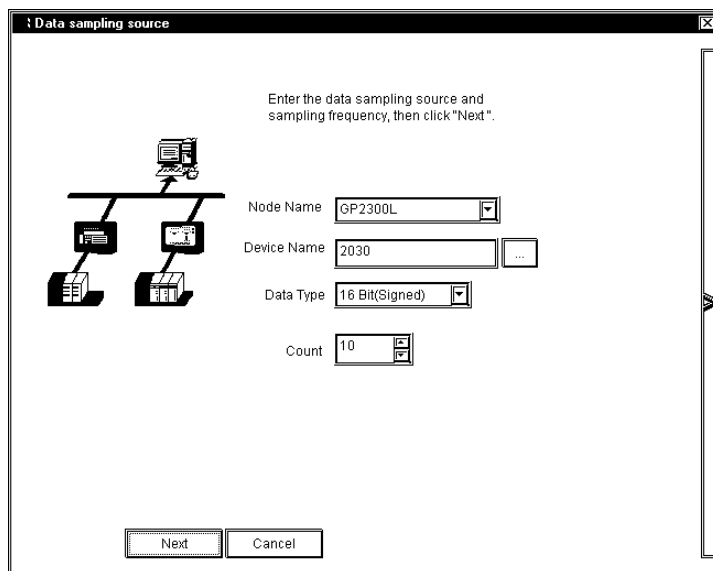

[Node Name]

Enter the node name to sample data. Node names registered in the network project file are displayed.

[Device Name]

Enter the device name to sample data. If you click [Browse], the symbol entry window appears.

[Device Type]

Designate the device model to sample data.

[Count]

Designate the number of sequential devices from the device to sample data. You can designate up to 255.

3. The [Data Input] window appears. Conditions that you have designated so far are displayed in the window. You can also click and edit each item. If you have made a mistake, click [Back]. If you do not have other devices to sample data, click [OK].

The screenshot shows a window titled "Data Input" with a scrollable table and several buttons. The table contains 10 rows of data, each with a serial number, item name, node name, device name, and a value of 0. The buttons include "Append", "Delete", "Upper", "Lower", "Back", "OK", and "Cancel".

??	Item name	Node name	Device name	Value
1	2030	GP2300L	2030	0
2	2031	GP2300L	2031	0
3	2032	GP2300L	2032	0
4	2033	GP2300L	2033	0
5	2034	GP2300L	2034	0
6	2035	GP2300L	2035	0
7	2036	GP2300L	2036	0
8	2037	GP2300L	2037	0
9	2038	GP2300L	2038	0
10	2039	GP2300L	2039	0

MEMO

Be sure to connect to the GP system since the communication process will start with the designated GP system when you click [OK].

[Append]

Use this button to append the device to sample data.

The [Data sampling source] window appears so that you can designate the device to append.

[Delete]

Use this button to delete lines.

Select lines to delete and then click [Delete].

[Upper], [Lower]

Use these buttons to change the order of lines.

Select the line that you wish to change the order, and then click either [Upper] or [Lower].

4. The selected device data is displayed on Device View.

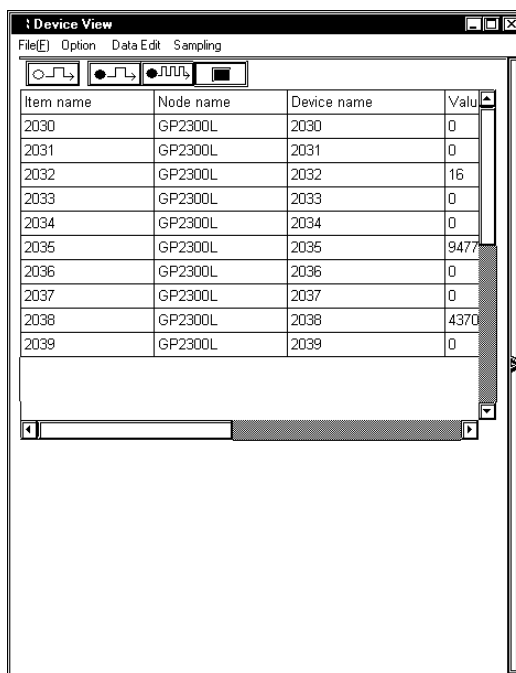

The screenshot shows a window titled "Device View" with a menu bar containing "File[F]", "Option", "Data Edit", and "Sampling". Below the menu bar is a toolbar with four icons. The main area of the window contains a table with the following data:

Item name	Node name	Device name	Value
2030	GP2300L	2030	0
2031	GP2300L	2031	0
2032	GP2300L	2032	16
2033	GP2300L	2033	0
2034	GP2300L	2034	0
2035	GP2300L	2035	9477
2036	GP2300L	2036	0
2037	GP2300L	2037	0
2038	GP2300L	2038	4370
2039	GP2300L	2039	0

MEMO

The contents here displayed on Device View are device data at the moment when you click [OK] in the step 3. This data is not updated.

7.2.2 Setting the Data Sampling Condition

This feature allows you to setup the data sampling condition from the sampling target device.

This section describes operations after you selected the sampling target device.

1. Click [Sampling] of Device View.

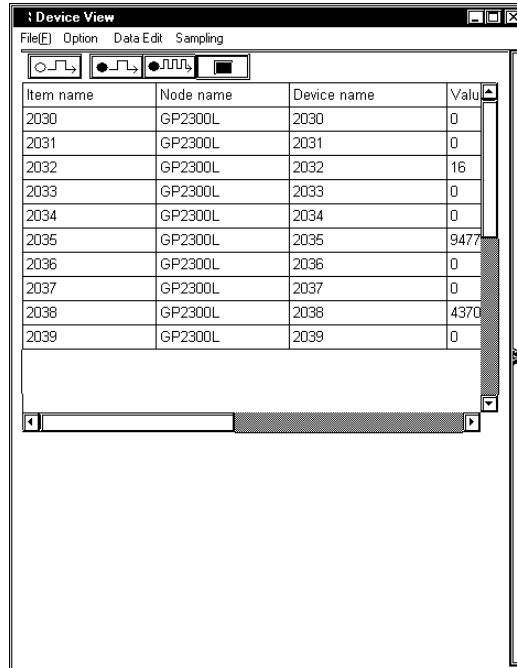

2. The following dialog appears. Click [Yes].

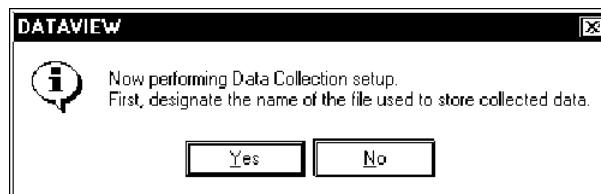

3. The [Save As] dialog appears, and you can create the file to save the sampled data. The file extension is (.DB). After you designated the file name, click [Save].

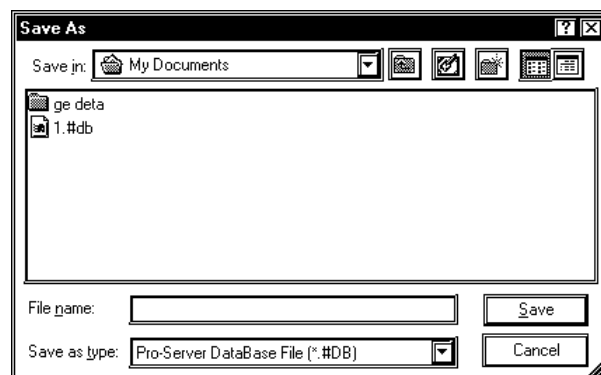

4. The [Sampling method] dialog appears.

Check the “Sampling method” that you wish to execute.

The contents of the “Condition” field differ depending on the “Sampling method” selected. You should perform the setting according to the contents displayed.

When You Selected “Regular Sampling” in “Sampling method” :

The setup contents are as the following. You should designate [Data sampling in specified seconds] and [Sampling using cache] in the “Condition” field.

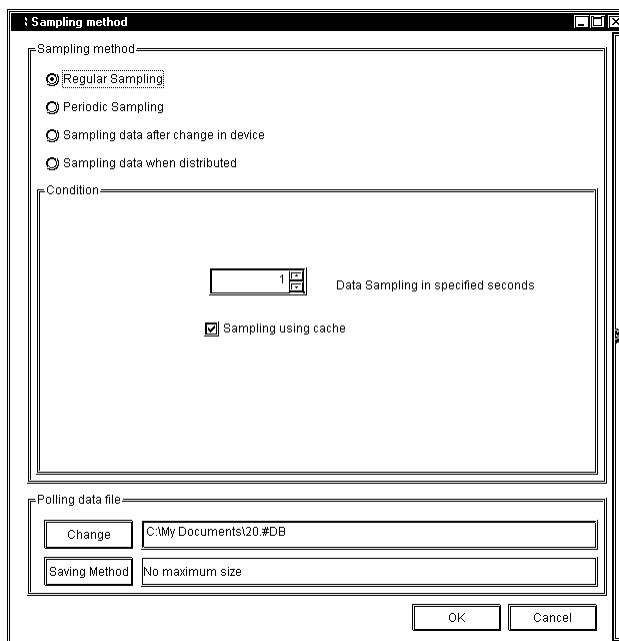

[Data sampling in specified seconds]

Designate the device data capturing interval in second. This is defaulted to “1 second”.

[Sampling using cache]

Check this box to use the cache to sample device data.

When You Selected “Periodic Sampling” in “Sampling method” :

The following settings are available. You should create the periodical sampling schedule using the [Append], the [Delete], and the [Edit] buttons in the “Condition” field.

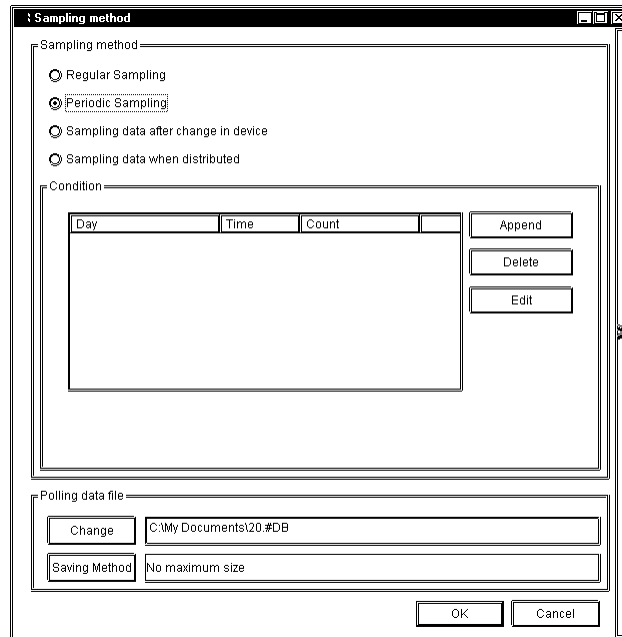

[Delete]

After selecting unnecessary schedules, click [Delete] to delete selected schedules.

[Append]

Click this button to create the new sampling schedule.

If you click the [Append] button, the [Designate the data sampling date] dialog appears. Designate each item in the [Designate the data sampling date] dialog, and then click [Next].

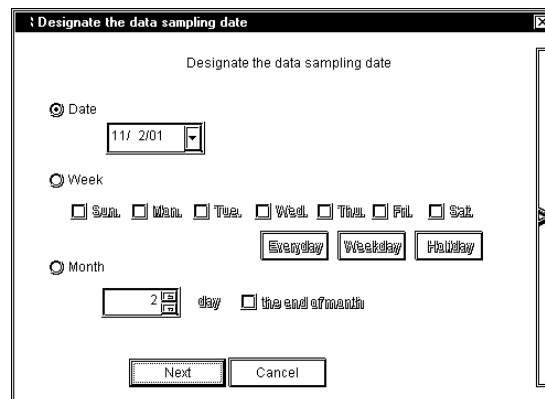

[Date]

Designate the date to sample device data. Device data are sampled on the day designated here.

[Week]

Designate a day of a week to sample device data. Check the day that you wish to sample device data. You can also click [Everyday] (Fri), [Weekday] (Mon, Tue, Wed, Thu, Fri) or [Holiday] (Sat, Sun) under the day check boxes.

[Month]

Designate a day of a month to sample device data. You can designate either a particular day (one day) or the last day every month. Device data are sampled on the day designated here every month.

If you click [Next], the [Designate the sampling time] dialog appears. Designate each item in the [Designate the sampling time] dialog, and then click [OK].

[Append] allows you to create the new sampling schedule and it will be displayed in the schedule field.

[Start Time]

Designate the time to start capturing device data. The sampling will start at the time designated here.

[Sampling count]

If you wish to sample device data once, check [One time only].

If you wish to repeat device data sampling, designate the sampling condition. You should designate the sampling interval and the number of sampling.

[Edit]

Click this button to change the contents of the selected schedule.

When You Selected “Sampling data after change in device” in “Sampling method”:

The contents of the “Condition” field are as the following. You should designate [Sampling Condition], [Interval Condition], and [Data sampling - from start to finish of data reception] in the “Condition” field.

[Sampling Condition]

Designate the timing to sample device data. You should designate the node name that you wish to perform a sampling, the target device name, the device model, and the device change condition.

[Interval Condition]

Designate intervals to check the device change and to sample data when the status changed.

[Data sampling - from start to finish of data reception]

Designate the intervals to save data “before and after” the device change occurred and the sampling condition was satisfied. Intervals designated here should be longer than the sampling interval.

When You Selected “Sampling data when distributed” in “Sampling method”:

The contents of the “Condition” field are as the following.

[Provide Sheet]

If pre-defined Provider information setups exist, select it from the pull-down list.

Be sure to set the [Provide Information] interval to 1000ms or longer.

[Sampling using cache]

Check this box to use the cache to sample device data.

[Data Sampling – from start to finish of data reception]

Designate the sampling method “before and after” receiving the Provider information. You should designate sampling times “before” and “after” receiving (in second), and the sampling interval (in second).

5. Designate each item in the “Polling data file” field of the [Sampling method] dialog, and then click [OK].

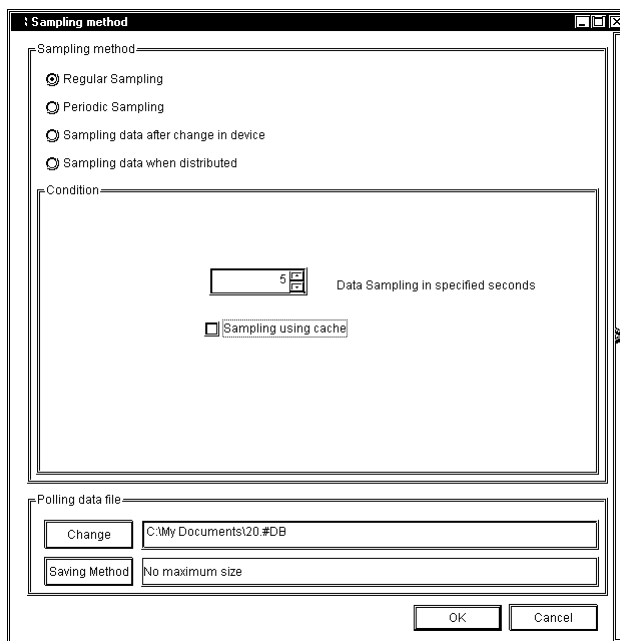

[Change]

Use this button to change the folder to save sampled data.

[Saving Method]

If you click this button, the [Saving Method] dialog appears. Designate each item in the [Saving Method] dialog, and then click [OK].

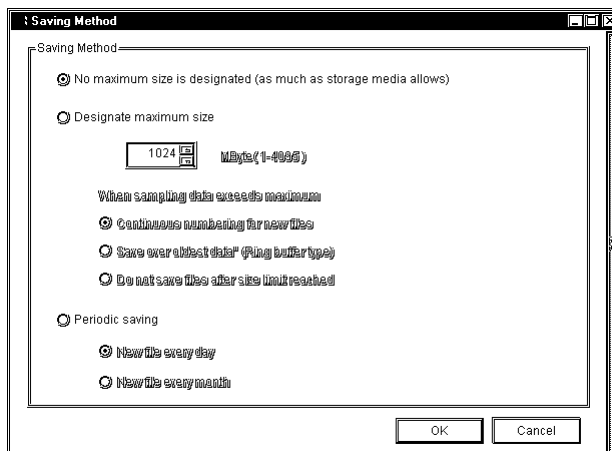

[Saving Method]

Designate the folder to save sampled data. You should designate the total volume (size) of data to save among “No maximum size is designated (as much as storage media allows)”, “Designate maximum size” and “Periodic saving”.

If you selected “Designate maximum size”, you should also designate the maximum data size (in MByte) and the sampling method.

- Selecting "Continuous numbering for new files"

When the maximum allowed size is exceeded, the following new file is created:

```
****.[Sequence number]. #DT ABCD.0.#DT -> ABCD.1.#DT
```

- Selecting "Save over oldest data"

The oldest Polling data is overwritten when the maximum allowed size is exceeded.



- Selecting "Do not save files after size limit reached"

When the maximum allowed size is exceeded, Polling is stopped and an error message appears.

If you selected “Periodic saving”, you should also designate the interval to upload the files.

6. Execute the device data sampling.

If you wish to test the sampling, click  button. The sampling process starts and the contents are displayed on Device View. The sampled data are not saved at this time.

If you wish to sample data once, click  button. Data are sampled and saved every time you click the  button regardless of the designated data sampling condition. If you wish to sample data according to the designated data sampling condition, click the  button. The data “Sample & Save” is executed according to the data sampling condition, and the contents are displayed on Device View. The display contents are updated according to the data change.

When you start the device data sampling, various buttons for viewing sampled data are appended on Device View.

Refer to “7.2.5 Playback Feature” for the viewing method of sampled device data.

Reference → “7.2.5 Playback Feature”

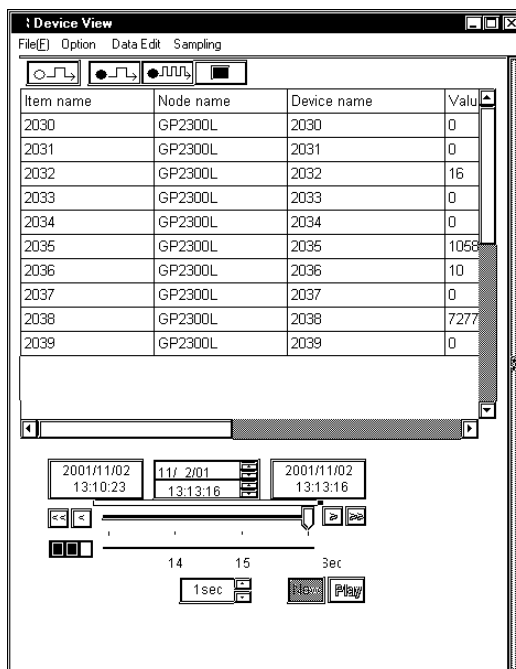

7.2.3 Editing Sampled Data

This feature allows you to edit saved device data.

1. Click [Data Edit] of Device View.

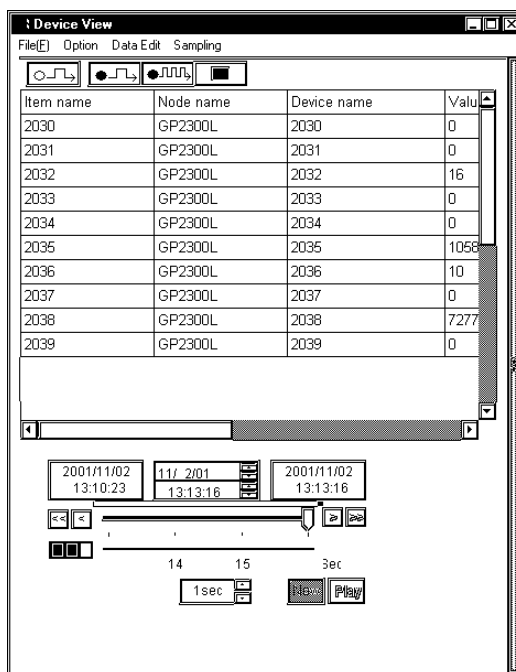

2. The [Data Edit] dialog appears. You can edit data in various methods. The following part describes the major operation method after the [Data Edit] dialog appeared.

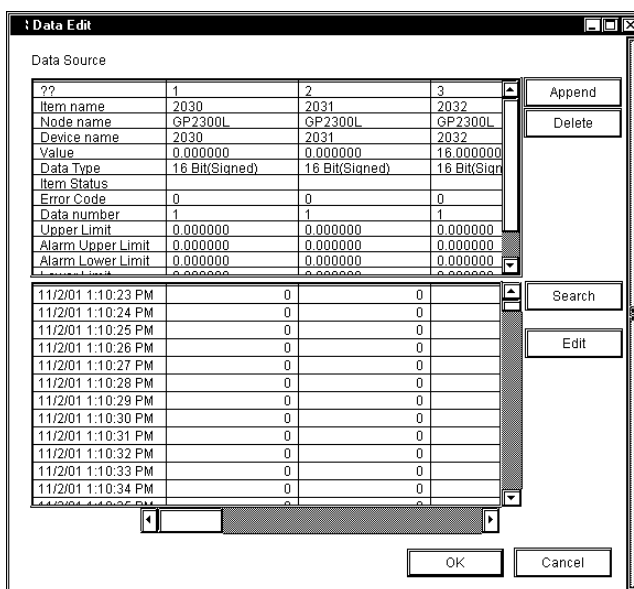

MEMO

Although you can start multiple Device View windows, you cannot edit data simultaneously.

Appending Sampled Data

1. Click [Append] of the [Data Edit] dialog.
2. The next dialog appears. Designate each item about the device that you wish to append, and then click [OK]. Items are equal to those in the [Data sampling source] dialog.

Reference → “7.2.1 Setting the Sampling Target Device”

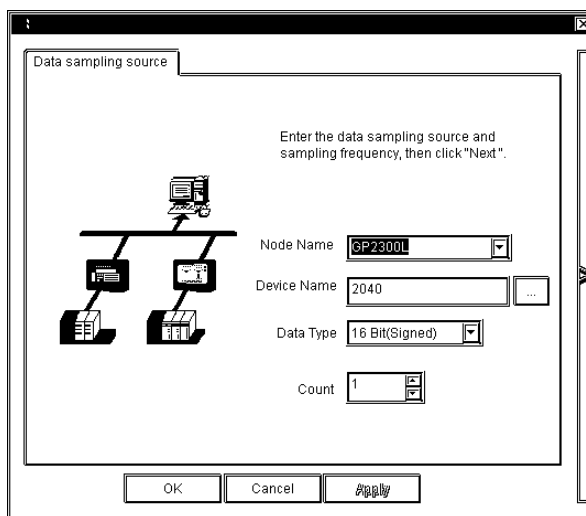

3. The device data that you wish to append are displayed in the [Data Edit] dialog.

Deleting Sampled Data

1. Select the data that you wish to delete in the [Data Edit] dialog.
2. Click [Delete]. The selected data will be deleted.

Searching Sampled Data

1. Click [Search] in the [Data Edit] dialog.
2. The [Search] dialog appears. Enter the date that you wish to search, and then click [OK].

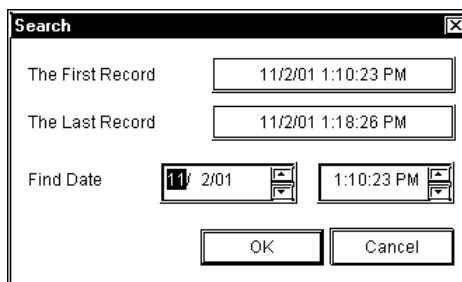

3. The display contents are updated and data are displayed showing one closest to the date entered in the middle.

Editing Data Source

1. Click the data source field that you wish to edit. The column including the selected field is highlighted so that you can enter data from the keyboard in the selected field. The pull-down list may appear depending on the selected item.

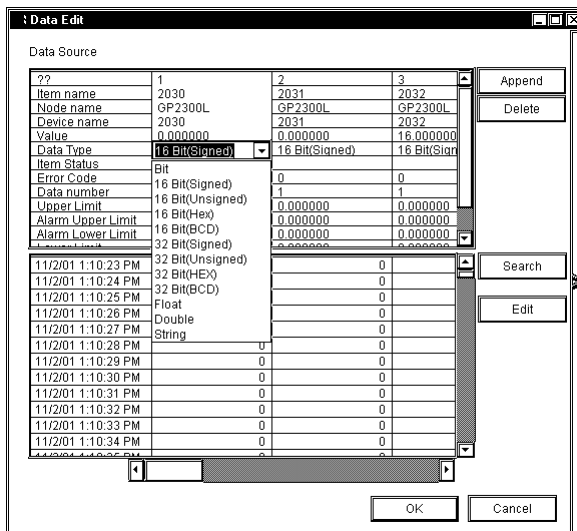

2. Enter the new contents from the keyboard. The contents of the selected field are updated.

MEMO

Data cannot be edited during Polling.

Editing Saved Data

1. Click [Edit] of the [Data Edit] dialog.
2. The [Edit] button in the [Data Edit] dialog is dimmed, and the [Delete Record] button appears.

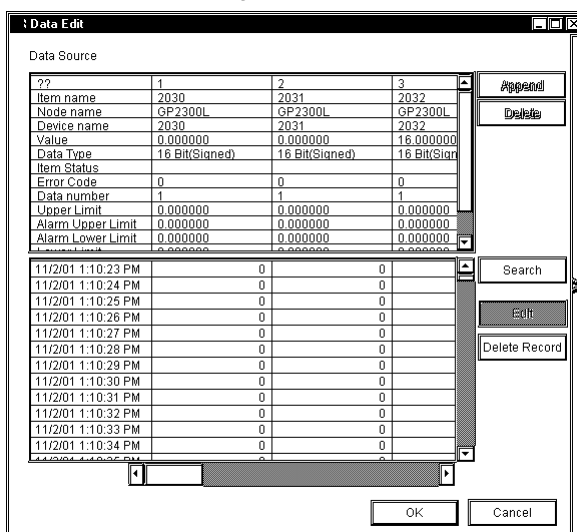

3. Select the data that you wish to delete, and then click [Delete Record]. The selected data will be deleted.

MEMO

Click on [OK] to set the selections made in [Edit] and/or [Delete Record].

Click on [Cancel] to delete all current selections.

7.2.4 Option

This feature allows you to change the display format of the data display area in Device View.

1. Click [Option] of Device View.

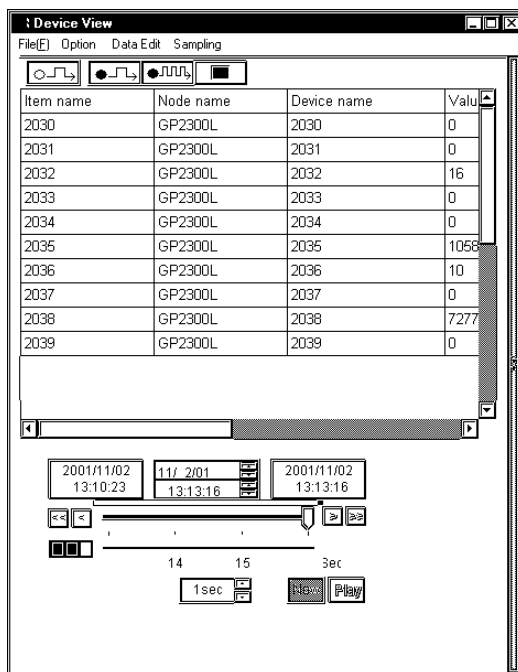

2. The [Option] dialog appears. You can change the display contents or format of the data display area in various methods. The following part describes the major operation method after the [Option] dialog appeared.

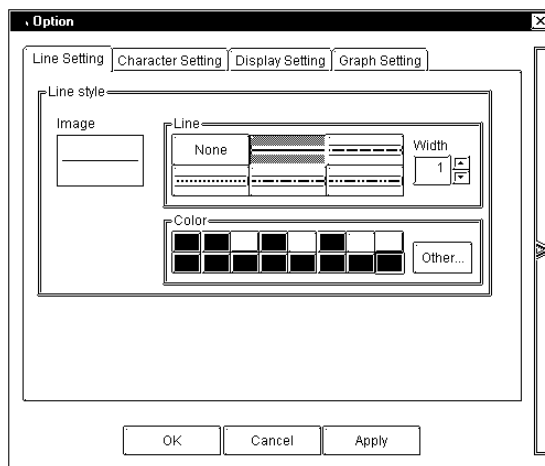

Setting a Line

1. Click the [Line setting] tab in the [Option] dialog.
2. Items on the [Line setting] tab appear. Designate each item in the [Line Style] field, and then click [OK].

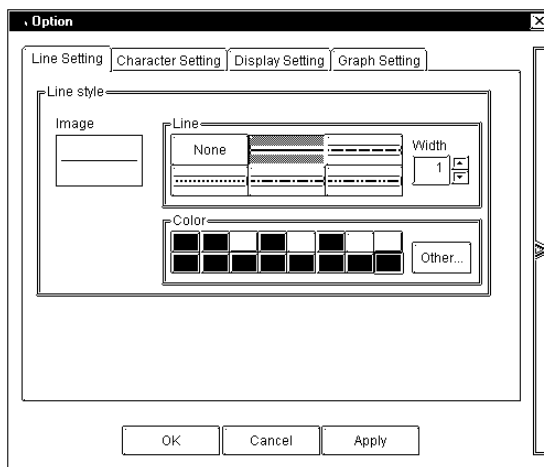

[Line]

Select the ruled line that you wish to use among 6 styles. Also designate the thickness of the ruled line. The unit is point and it is defaulted to 1 point.

[Color]

Select the ruled line color among 16 colors. If you do not find one that you wish to use among those, click [Other]. The [Color Setup] dialog appears so that you can select or create the color that you wish to use.

Character Setting

1. Click the [Character Setting] tab in the [Option] dialog.
2. Items on the [Character Setting] tab appear. Designate each item, and then click [OK].

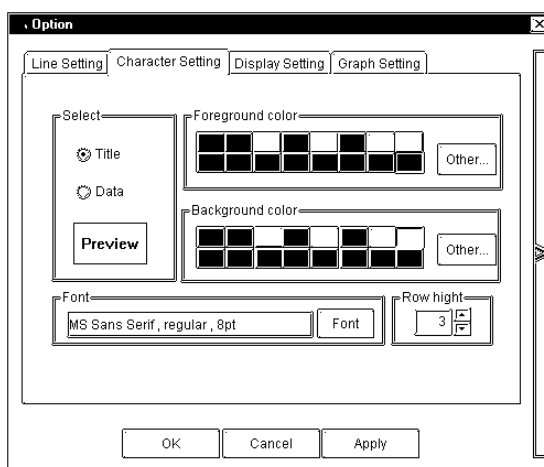

[Select]

Select which texts you wish to change, “Title” texts on the top or “Data” texts.

[Foreground color]

Select the text color among 16 colors. If you do not find the color that you wish to use among those, click the [Other] button. The [Color Setup] dialog appears so that you can select or create the color that you wish to use.

[Background color]

Select the background color among 16 colors. If you do not find the color that you wish to use among those, click the [Other] button. The [Edit Color] dialog appears so that you can select or create the color that you wish to use.

[Font]

Select the font that you wish to use. Click [Font]. The [Font] dialog appears. Designate each item such as the “font to use”, the “font style”, the “font size” and the “type”, and then click [OK].

[Row height]

Designate the row height of the data display area. The unit is “point” and it is defaulted to 3 points.

Setting the Display Contents

1. Click the [Display Setting] tab in the [Option] dialog.
2. Items on the [Display Setting] tab appear. Designate each item, and then click [OK].

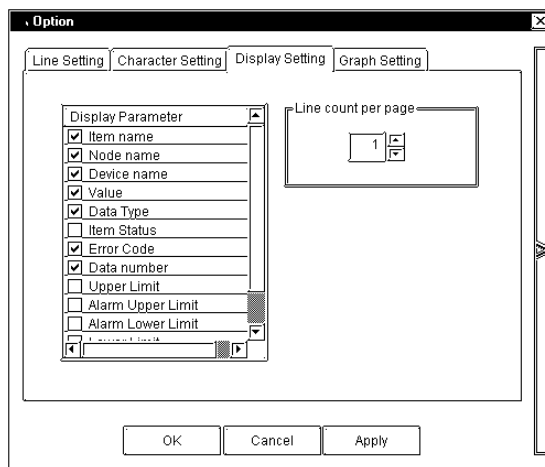

[Parameters]

Select parameters that you wish to display in the data display area. Check each item that you wish to display. The following describes the overview of each item.

Item name: Designated symbol name.

Node name: Designated node name.

Device name: Designated device name.

Value: The latest data.

Data Type: Designated device data type.

Item Status: (reserved)

Error Code: Error code when an error occurred in sampling. (normally 0)

Data number: (reserved)

Upper Limit: The upper limit value to display the graph. (Even if you designate a greater value than this, the graph remains in the 100% status.)

Alarm Upper Limit: The alarm upper limit value to display the graph. (including this value)

Alarm Lower Limit: The alarm lower limit value to display the graph. (including this value)

Lower Limit: The lower limit value to display the graph. (If you designate a less value than this, the graph will not be displayed.)

Graph: The horizontal bar graph is displayed according to values of “Upper Limit”, “Alarm Upper Limit”, “Alarm Lower Limit” and “Lower Limit”.

[Line count per page]

Designate the number of data lines per page that you wish to display in the data display area. If the actual number of data exceeds the number of data per page, the [Previous] and the [Next] buttons are displayed in the left and the right sides under the data display area respectively. You can switch pages using these buttons.

Setting the Graph Color

1. Click [Graph Setting] tab in the [Option] dialog.
2. Items in the [Graph Setting] tab appear. Designate each item, and then click [OK].

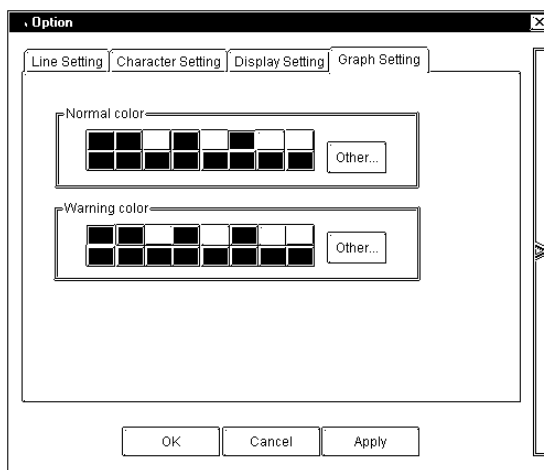

[Normal color]

Select the normal graph color among 16 colors. If you do not find the color that you wish to use among those, click the [Other] button. The [Color Setup] dialog appears so that you can select or create the color that you wish to use.

[Warning color]

Select the warning graph color among 16 colors. If you do not find the color that you wish to use among those, click the [Other] button. The [Edit Color] dialog appears so that you can select or create the color that you wish to use.

7.2.5 Playback Feature

This feature allows you to playback sampled device data on Device View.

1. Select [Open Data View (O)] on [Data View (D)] of the menu bar.

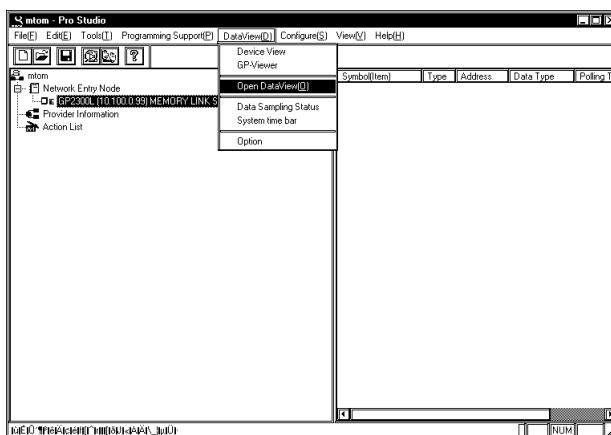

2. The [Open] dialog appears. Select the device data (.#DV) that you wish to playback, and then click [Open].

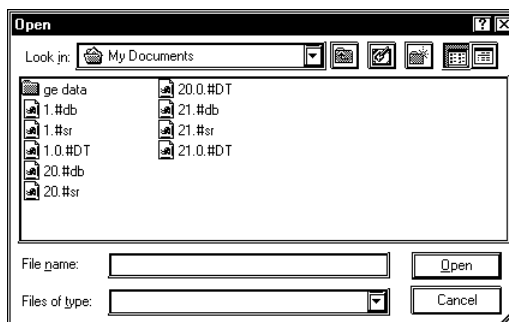

MEMO

You can also playback data in the saving process.

3. The contents of device data that you wish to playback are displayed on Device View. You can playback device data using various buttons on Device View.

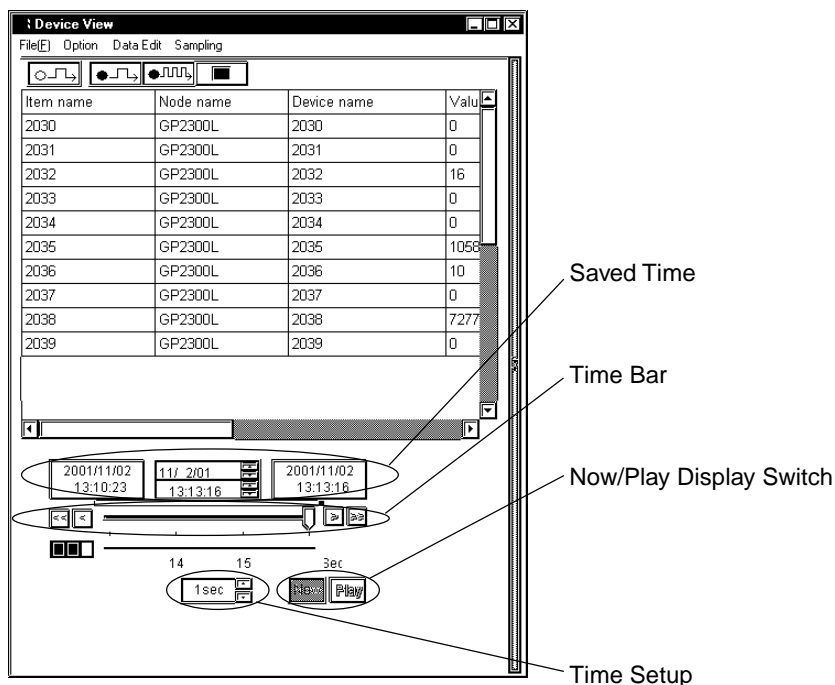

[Saved Time]

This field shows the saved time of the saved device data.

The field shows, from the left, the saving start time, the time for currently displayed data and the last saved time. When the current status is displayed, the time for currently displayed data is identical to the last saved time.

[Time Bar]

Saved data can be displayed by sliding the time bar control to either side. The data saving process continues even while you operate the control.

[Time Setup]

You can designate the time unit for one graduation of the time bar.

[Now/Play Display Switch]

[Now] and [Play] buttons are available. You can playback the saved data from the designated time either by sliding the time bar control to the time that you wish to start the playback or by clicking the [Play] button after clicking the time for currently displayed data (the center field of [Saved Time]) and then entering the time to start the playback.

7.2.6 Other Features

This section describes the File menu and options of Device View.

1. If you click [File (E)] of Device View, 8 options are available. The following describes the overview of each option.

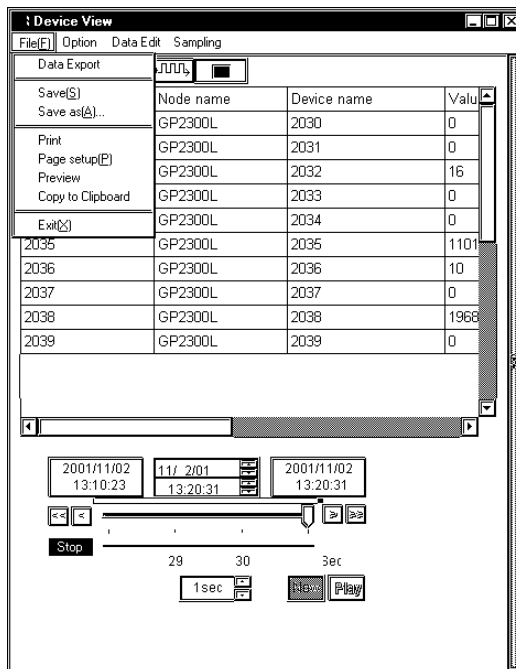

Exporting Data

1. Select [Data Export] on the [File(E)] menu.
2. The [Export] dialog appears. Designate each item, and then click [Export].

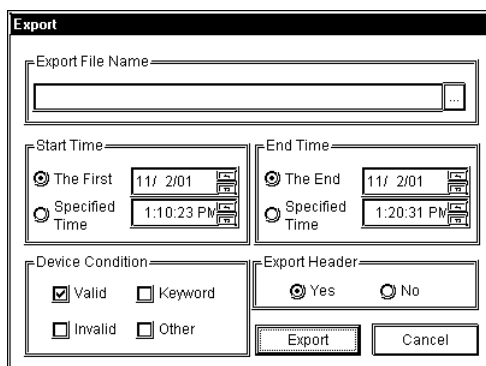

[Export File Name]

Designate the location and the file name to save exported data. The file extension is (.CSV).

[Start Time]

Designate the time to start exporting data. To export Polling data immediately, click on the [The First] checkbox. To export Polling data after a specific period of time elapses, click on the [Specified Time] checkbox. If you checked “Specified Time”, you should also designate the start time to export.

[End Time]

Designate the time to end exporting data. To wait until all data is polled before exporting, click on the [The End] checkbox. To export Polling data after a specific period of time elapses, click on the [Specified Time] checkbox. If you checked “Specified Time”, you should also designate the end time to export.

[Device Condition]

This is the reserved data. You should not change the designated value.

[Export Header]

If you wish to include the header information in exported data, check “Yes”. If not, check “No”.

[Export]

Executes the data export.

[Cancel]

The process is stopped and goes back to Device View.

MEMO

- Although you can start multiple Device View programs, you cannot export data simultaneously.
- Data can be exported during Polling. However, if the [Designate maximum size/Save over oldest data] selection is used, data export cannot be performed.

Saving Data

1. If you wish to save displayed data on Device View, click [Save (S)] on the [File (E)] menu.

Data are overwritten.

If you wish to save displayed data on Device View as a separate file name, click [Save As (A)] on the [File (E)] menu. The [Save As] dialog appears. Enter the file name, and then click [Save].

Print

1. Click [Print] on the [File (E)] menu. The printing process is executed.

Page Setup

1. Click [Page setup(P)] on the [File (E)] menu.
2. The [Page setup] dialog appears. Designate each item, and then click [OK].

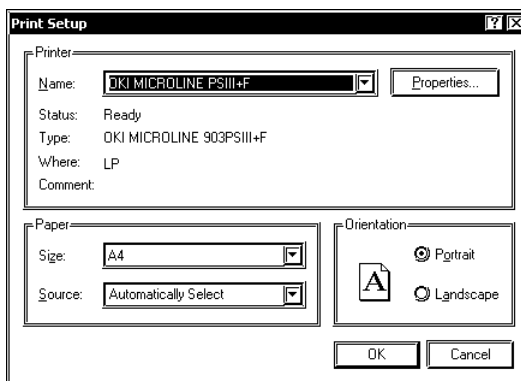

MEMO

The contents of the [Page setup] dialog differ depending on your printer. Refer to the user manual of your printer for details.

Preview

1. Click [Preview] on the [File (E)] menu.
2. The print preview appears.

Copy to Clipboard

1. Click [Copy to Clipboard] on the [File (E)] menu.
2. The data value displayed on Device View is copied into the clipboard.
3. Paste the data value onto the application used.

MEMO

You can only copy data in the data display area of Device View into the clipboard. You cannot copy data such as a title.

Exit

1. Click [Exit(X)] on the [File (E)] menu. Exits Device View.

Option

This is selected on [Data View (D)] of the menu bar.

1. Select [Option] on [Data View (D)] of the menu bar.

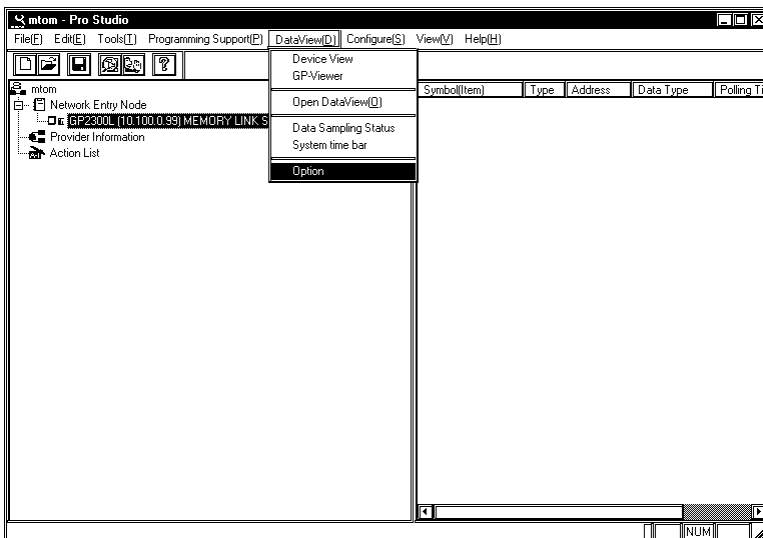

2. The [Data View Options] dialog appears.

You can select “Show/Hide” of the setup menu and the save button.

If you uncheck “Display menu”, the [Option], the [Data Edit], and the [Sampling] menus are hidden on Device View.

If you uncheck “Display button” buttons are hidden on Device View.

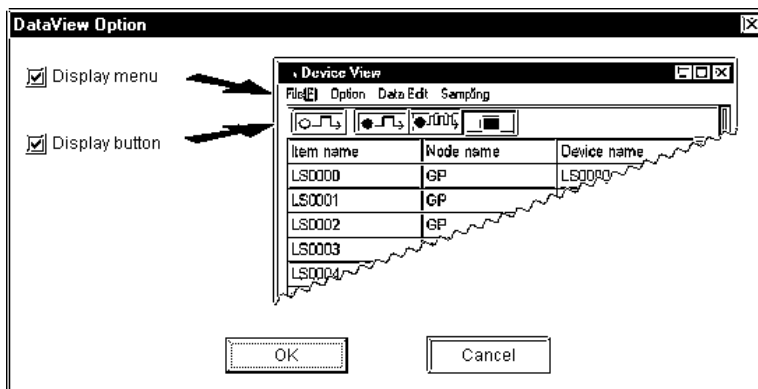

7.3 GP-Viewer

GP-Viewer allows you to sample screen data from the GP system connected to Ethernet to display screen data or to playback saved GP data on GP-Viewer.

7.3.1 Starting GP-Viewer

When you start GP-Viewer, screens on the GP system are displayed on the GP-Viewer browser in real time.

1. After selecting the entry node to use GP-Viewer, select [GP-Viewer] on [Data View (D)] of the menu bar.

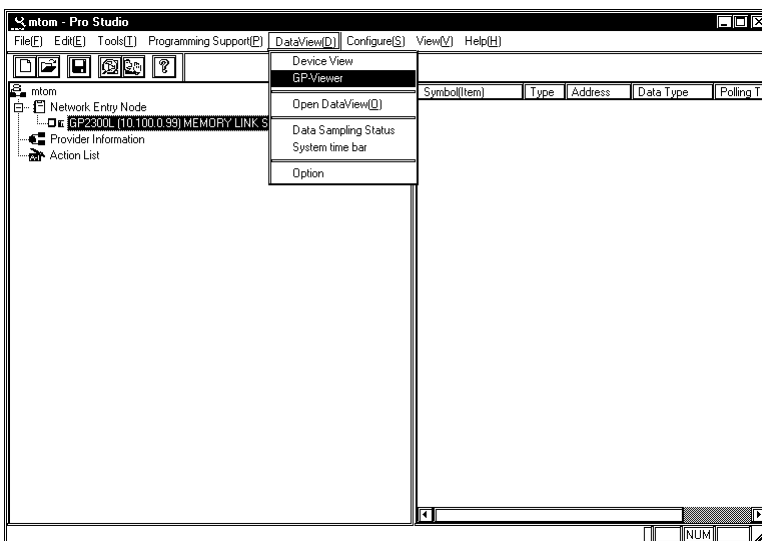

MEMO

- You should make sure to connect to the GP system because the communication process will start when you click [GP-Viewer].
- You can upload the connected GP screen on GP77R SERIES, however, the GP system is reset once. If your model does not support the online uploading function, the warning window appears.
- If the password protection has been set to the GP screen, the password entry dialog appears.
- The GP-Viewer screen refresh period is set via Pro-Studio's -> [Configure] -> [System] -> [DDE Polling Time] dialog box (Default: 1000ms). If the GP-Viewer's screen refresh time becomes too slow, increasing the [DDE Polling Time] value will speed it up.

2. While the upload process from the GP system is running, the following dialog appears. The dialog will disappear when the upload process is completed.

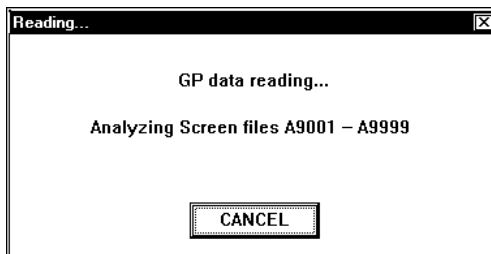

3. The selected GP screen data are displayed on GP-Viewer.

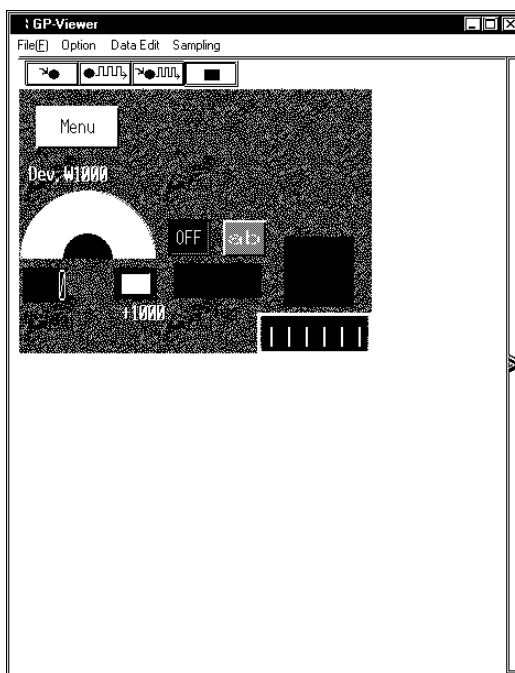
**MEMO**

Data have been monitored but not been saved at this stage.

7.3.2 Setting the Data Sampling Condition

This feature allows you to set the data sampling condition from the target device.

The following part describes the procedure after GP-Viewer is started.

1. Click [Sampling] of GP-Viewer.

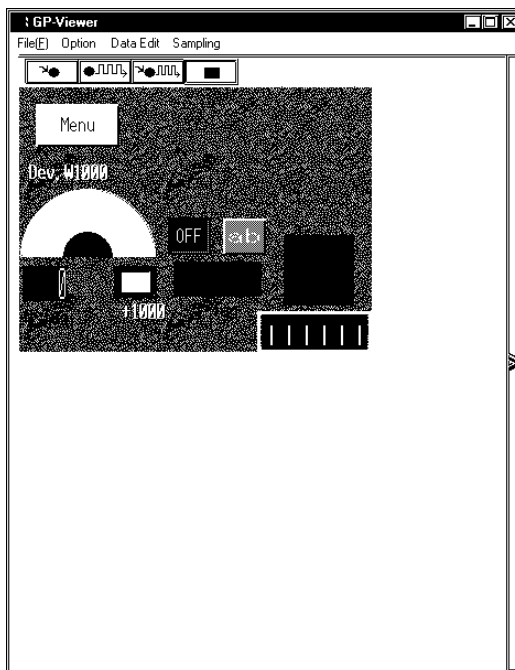

2. The next dialog appears. Click [Yes].

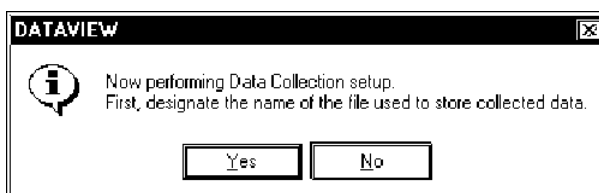

3. The [Save As] dialog appears so that you can create the file to save sampled data. The file extension is (.DB). Designate the file name, and then click [Save].

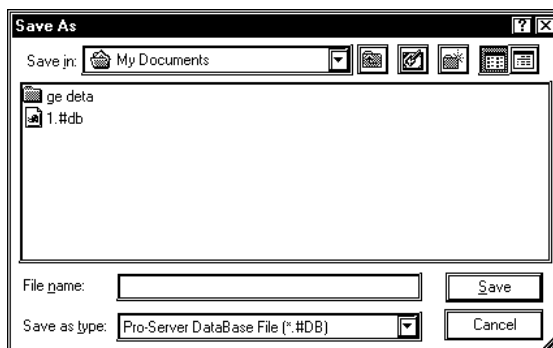

4. The [Sampling method] dialog appears.

Check the desired “Sampling Method”.

The contents of the “Condition” field differ depending on the “Sampling method” selected. You should perform the setting according to the contents displayed.

When You Selected “Regular Sampling” on “Sampling method”:

The setup contents are as the following. You should designate [Data Sampling in specified seconds] and [Sampling using cache] in the “Condition” field.

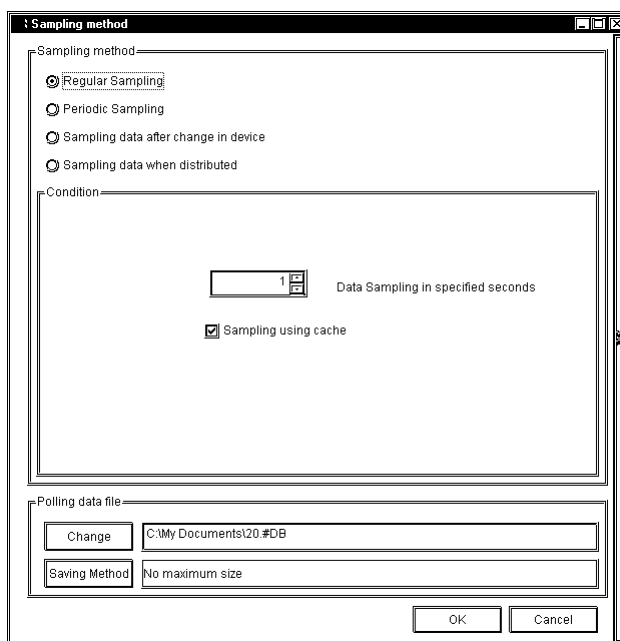

[Data Sampling in specified seconds]

Designate the device data capturing interval in second. This is defaulted to “1 second”.

[Sampling using cache]

Check this box to use the cache to sample device data.

When You Selected “Periodic Sampling” in “Sampling method” :

The setup contents are as the following. You should create the periodical sampling schedule using the [Append], the [Delete], and the [Edit] buttons in the “Condition” field.

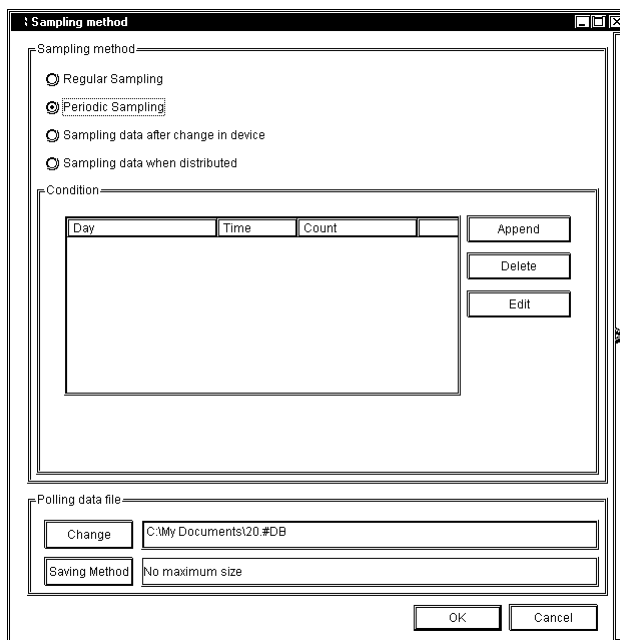

[Delete]

After selecting unnecessary schedules, click [Delete] to delete selected schedules.

[Append], [Edit]

Click these buttons to append or to edit the sampling schedule.

If you click either the [Append] button, or the [Edit] button after you selected the schedule that you wish to edit, the [Designate the data sampling date] dialog appears. Designate each item in the [Designate the data sampling date] dialog, and then click [Next].

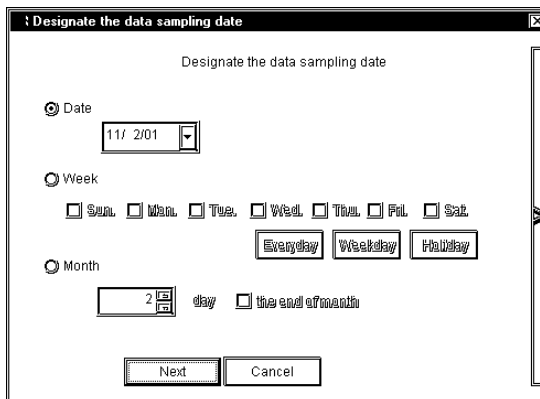

[Date]

Designate the date to sample device data. Device data are sampled on the day designated here.

[Week]

Designate a day of a week to sample device data. Check the day that you wish to sample device data. You can also click [Everyday] (Fri), [Weekday] (Mon, Tue, Wed, Thu, Fri) or [Weekend] (Sat, Sun) under the day check boxes.

[Month]

Designate a day of a month to sample device data. You can designate either a particular day (one day) or the last day every month. Device data are sampled on the day designated here every month.

If you click [Next], the [Designate the sampling time] dialog appears. Designate each item in the [Designate the sampling time] dialog, and then click [OK].

[Append] allows you to create the new sampling schedule and it will be displayed in the schedule field.

[Edit] allows you to change the contents of the selected schedule.

[Start Time]

Designate the time to start capturing device data. The sampling will start at the time designated here.

[Sampling count]

If you wish to sample device data once, check [One time only].

If you wish to repeat device data sampling, designate the sampling condition. You should designate the sampling interval and the number of sampling.

When You Selected “Sampling data after change in device” in “Sampling method” :

The contents of the “Condition” field are as the following. You should designate [Sampling Condition], [Interval Condition], and [Data sampling - from start to finish of data reception] in the “Condition” field.

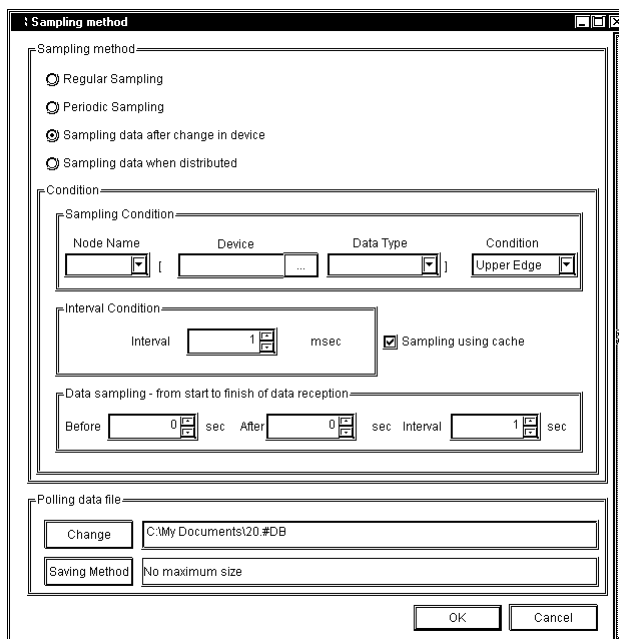

[Sampling Condition]

Designate the timing to sample device data. You should designate the node name that you wish to perform a sampling, the target device name, the device model, and the device change condition.

[Interval Condition]

Designate intervals to check the device change and to sample data when the status changed.

[Data sampling - from start to finish of data reception]

Designate the intervals to save data “before and after” the device change occurred and the sampling condition was satisfied. Intervals designated here should be longer than the sampling interval.

When You Selected “Sampling data when distributed” in “Sampling method” :

The contents of the “Condition” field are as the following. You should enter the Provider information setup name in [Provide Sheet] of the “Condition” field, and then click [Provider Data Registration] to designate the new Provider information setup. If you have already designated Provider information setups, you can select it from the pull-down list.

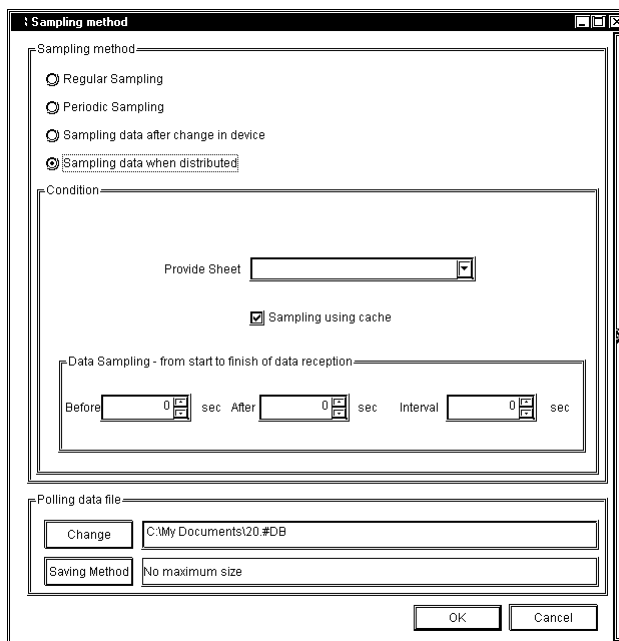

[Provide Sheet]

If pre-defined Provider information setups exist, select it from the pull-down list. If it does not exist, you should enter the name.

Be sure to set the [Provide Information] interval to 1000ms or longer.

[Sampling using cache]

Check this box to use the cache to sample device data.

[Data sampling - from start to finish of data reception]

Designate the sampling method “before and after” receiving the Provider information. You should designate sampling times “before” and “after” receiving (in second), and the sampling interval (in second).

5. Designate each item in the “Polling data file” field of the [Sampling method] dialog, and then click [OK].

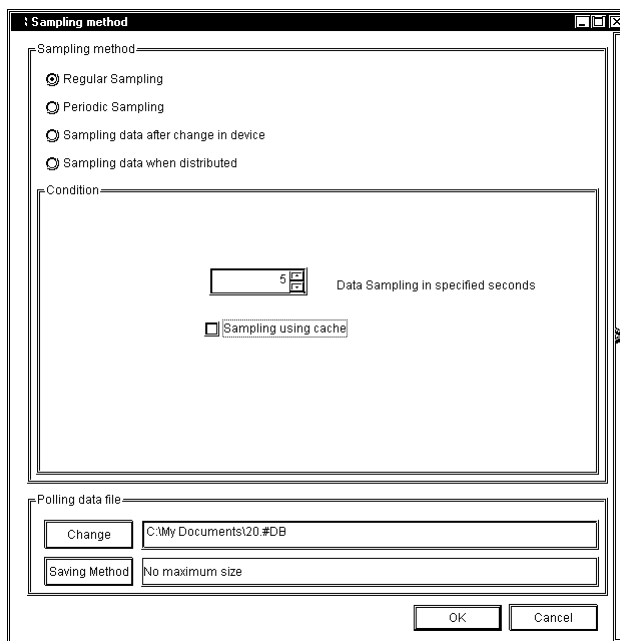

[Change]

Use this button to change the folder to save sampled data.

[Saving Method]

If you click this button, the [Saving Method] dialog appears. Designate each item in the [Saving Method] dialog, and then click [OK].

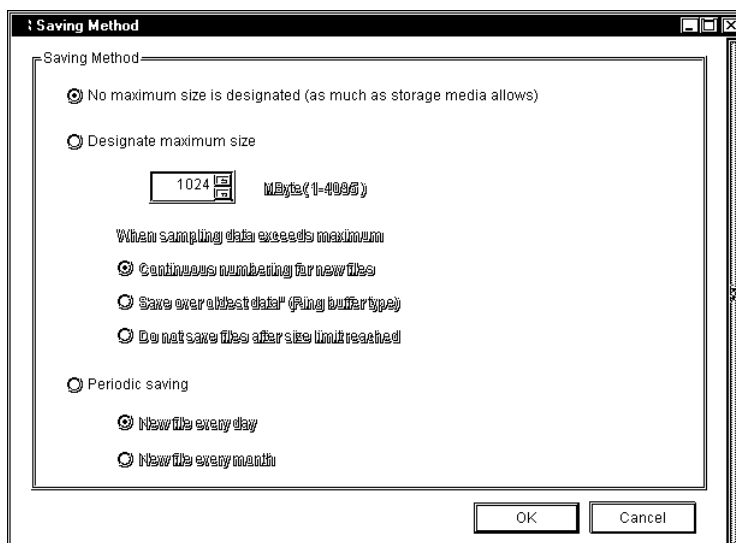

[Saving Method]

Designate the folder to save sampled data. You should designate the total volume (size) of data to save among “No maximum size is designated (as much as storage media allows)”, “Designate maximum size” and “Periodic saving”.

If you selected “Designate maximum size”, you should also designate the maximum data size (in MByte) and the sampling method.

- Selecting "Continuous numbering for new files"

When the maximum allowed size is exceeded, the following new file is created:

****.[Sequence number]. #DT ABCD.0.#DT -> ABCD.1.#DT

- Selecting "Save over oldest data"

The oldest Polling data is overwritten when the maximum allowed size is exceeded.

- Selecting "Do not save files after size limit reached"

When the maximum allowed size is exceeded, Polling is stopped and an error message appears.

If you selected “Periodic saving”, you should also designate the interval to upload the files.

6. Execute the device data sampling.

To perform sampling registration for GP display screens, click the  button.

To poll sample registered device data, click the  button.

If you wish to sample data according to the designated data sampling condition, click the  button. The data “Sample & Save” is executed according to the data sampling condition, and the contents are displayed on GP-Viewer. The display contents are updated according to the data change. When you start the device data sampling, various buttons for viewing sampled data are appended on GP-Viewer.

Refer to “7.3.5 Playback Feature” for the viewing method of sampled device data.

Reference → “7.3.5 Playback Feature”

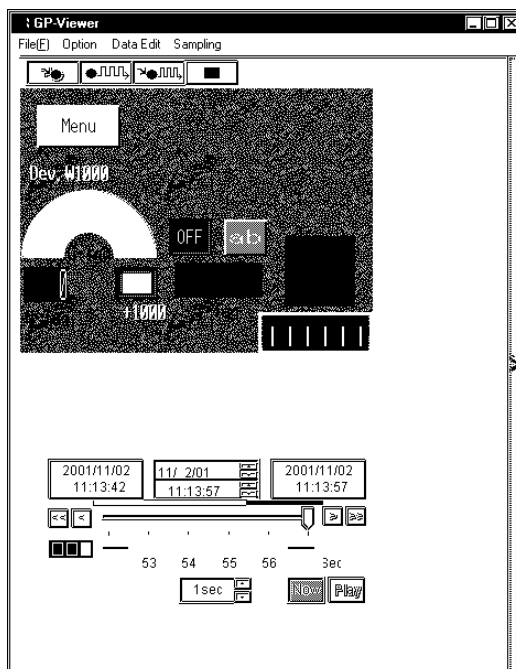

7.3.3 Editing Sampled Data

This feature allows you to edit sampled device data.

1. Click [Data Edit] of GP-Viewer.

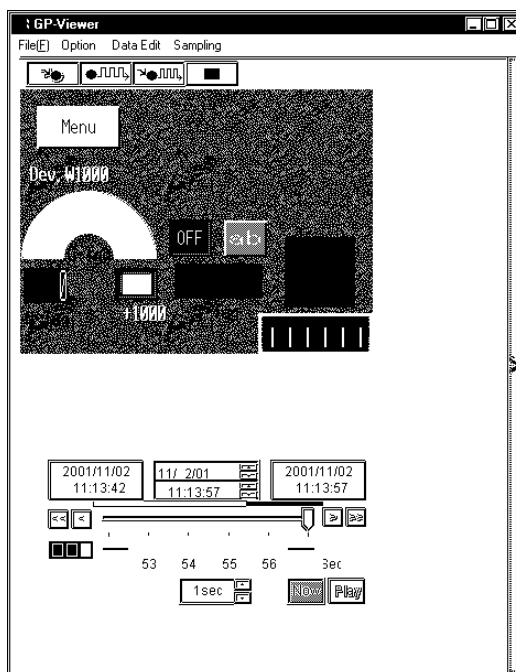

2. The [Data Edit] dialog appears. You can edit data in various methods. The following part describes the major operation method after the [Data Edit] dialog appeared.

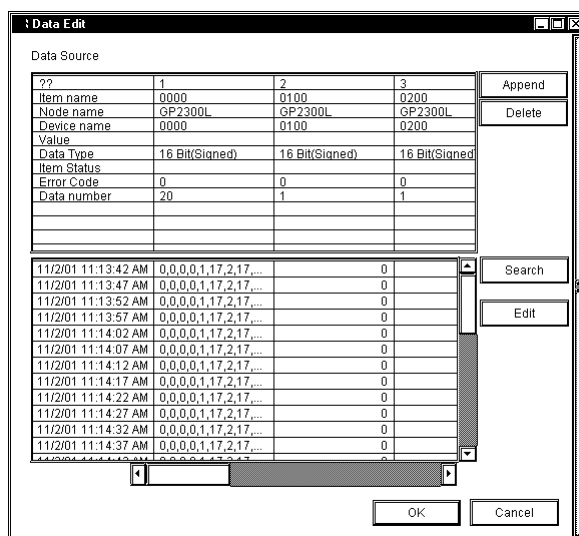

Appending Sampled Data

1. Click [Append] of the [Data Edit] dialog.
2. The next dialog appears. Designate each item about the device that you wish to append, and then click [OK]. Items are equal to those in the [Data sampling source] dialog.

Reference → “7.3.1 Setting the Sampling Target Device”

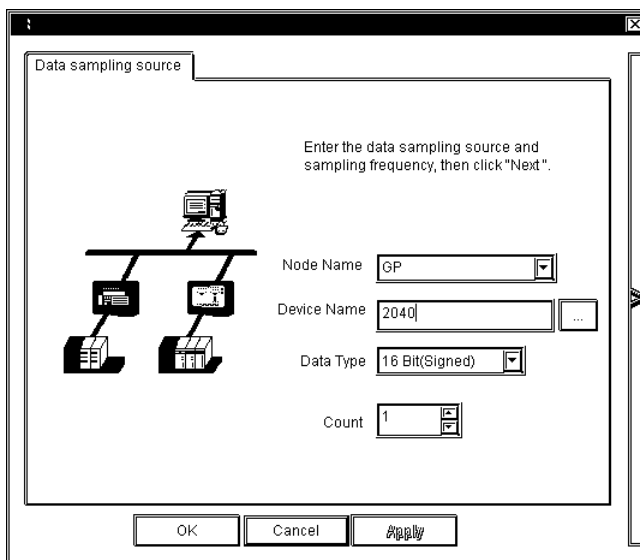

3. The device data that you wish to append are displayed in the [Data Edit] dialog.

Deleting Sampled Data

1. Select the data that you wish to delete in the [Data Edit] dialog.
2. Click [Delete]. The selected data will be deleted.

Searching Sampled Data

1. Click [Search] in the [Data Edit] dialog.
2. The [Search] dialog appears. Enter the date that you wish to search, and then click [OK].

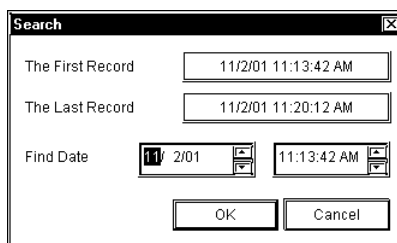

3. The display contents are updated and data are displayed showing one closest to the date entered in the middle.

Editing Data Source

1. Click the data source field that you wish to edit. The column including the selected field is highlighted so that you can enter data from the keyboard in the selected field. The pull-down list may appear depending on the selected item.

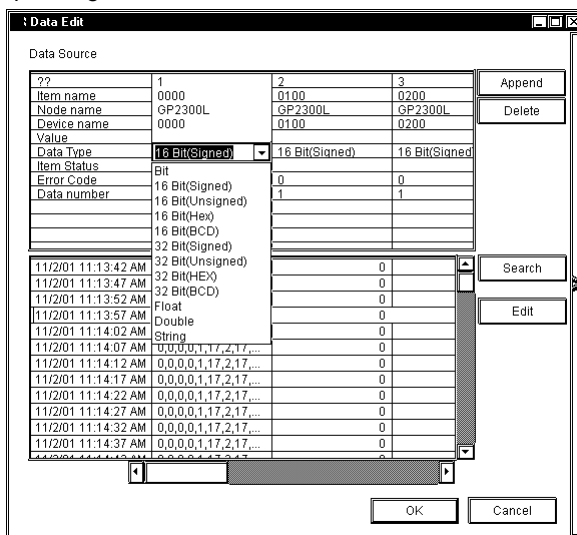

2. Enter the new contents from the keyboard. The contents of the selected field are updated.

MEMO

Data cannot be edited during Polling.

Editing Saved Data

1. Click [Edit] of the [Data Edit] dialog.
2. The [Edit] button in the [Data Edit] dialog is highlighted, and the [Delete Record] button appears.

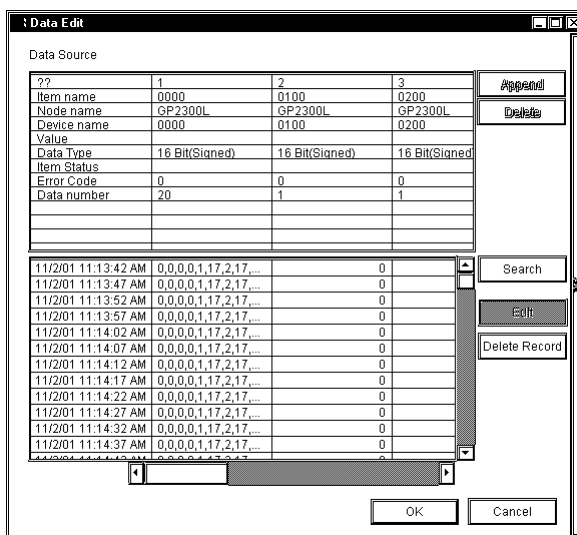

3. Select the data that you wish to delete, and then click [Delete Record]. The selected data will be deleted.

MEMO

Click on [OK] to set the selections made in [Edit] and/or [Delete Record].

Click on [Cancel] to delete all current selections.

7.3.4 Setting Drawing

This feature allows you to change the display format of the data display area in GP-Viewer.

1. Click [Option] of GP-Viewer.

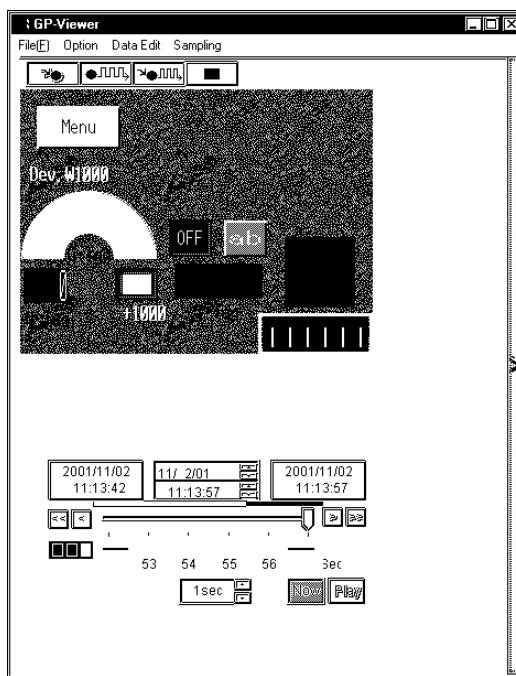

2. The [Wizard] dialog appears. Perform required settings, and then click [Option] of GP-Viewer to close the dialog.

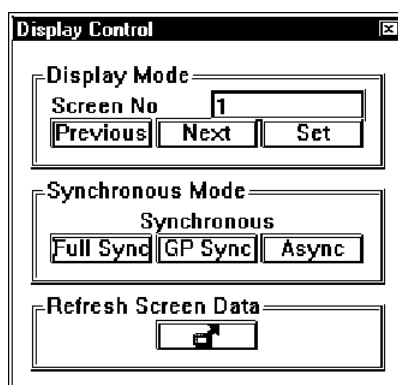

[Display Control]

You can designate the synchronization style between GP screens and GP-Viewer. There are 3 synchronous modes available, Full Synchronous, GP Synchronous and Asynchronous. The following describes the detail of each style.

Asynchronous	Screens can be switched on GP-Viewer. Switching a screen on GP-Viewer does not synchronize with a screen on the GP system.
GP Synchronous	Screens cannot be switched on GP-Viewer. Switching a screen on the GP system synchronizes with a screen on GP-Viewer. (This is the default setting.)
Full Synchronous	Screens can be switched on GP-Viewer. Switching a screen on GP-Viewer synchronizes with a screen on the GP system and vice versa.

[Screen No]

This feature allows you to change the displayed screen of GP-Viewer according to screen numbers pre-defined on the GP system.

If you click [Previous], the previous screen from the currently displayed screen is displayed and the value in the “Screen No” field is decreased by one.

If you click [Next], the next screen from the currently displayed screen is displayed and the value in the “Screen No” field is increased by one.

If you enter the screen number that you wish to display in the “Screen No” field and click [Set], the corresponding screen to the number entered is displayed.

MEMO

- The screen switching feature of GP-Viewer is effective only when the synchronous mode is either “Asynchronous” or “Full Synchronous”.
- You cannot normally switch screens by GP-Viewer from upper-level PCs. You should set the bit “4” of GP’s LS2076 to “ON (1)” to switch screens in the [Full Synchronous] mode from upper-level PCs.

[Refresh Screen Data]

If you changed the GP screen contents, click [Refresh Screen Data]. GP-Viewer re-captures the setup contents of the GP system.

7.3.5 Playback Feature

This feature allows you to playback sampled device data on GP-Viewer.

1. Select [Open Data View (O)] on [Data View (D)] of the menu bar.

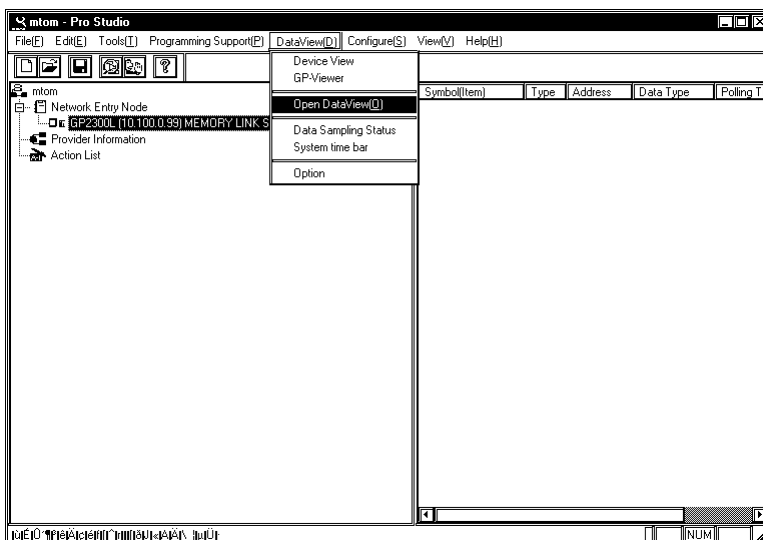

2. The [Open] dialog appears. Select the device data (.#DV) that you wish to playback, and then click [Open].

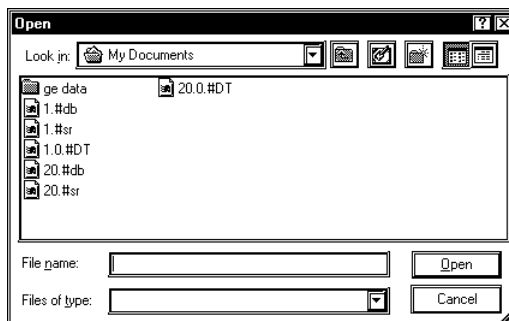

MEMO

You can also playback data in the saving process.

3. The contents of sampled data are displayed on GP-Viewer. You can playback saved data using various buttons on GP-Viewer.

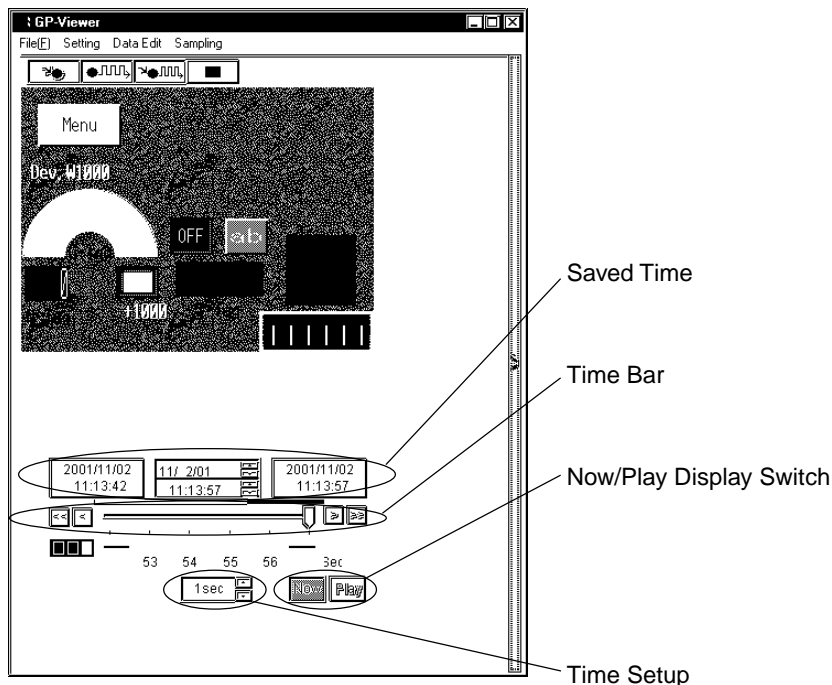

[Saved Time]

This field shows the saved time of the saved device data.

The field shows, from the left, the saving start time, the time for currently displayed data and the last saved time. When the current status is displayed, the time for currently displayed data is identical to the last saved time.

[Time Bar]

Saved data can be displayed by sliding the time bar control to either side. The data saving process continues even while you operate the control.

[Time Setup]

You can designate the time unit for one graduation of the time bar.

[Now/Play Display Switch]

[Now] and [Play] buttons are available. You can playback the saved data from the designated time either by sliding the time bar control to the time that you wish to start the playback or by clicking the [Play] button after clicking the time for currently displayed data (the center field of [Saved Time]) and then entering the time to start the playback.

7.3.6 Other Features

This section describes the File menu and options of GP-Viewer.

1. If you click [File (E)] of GP-Viewer, 8 options are available. The following describes the overview of each option.

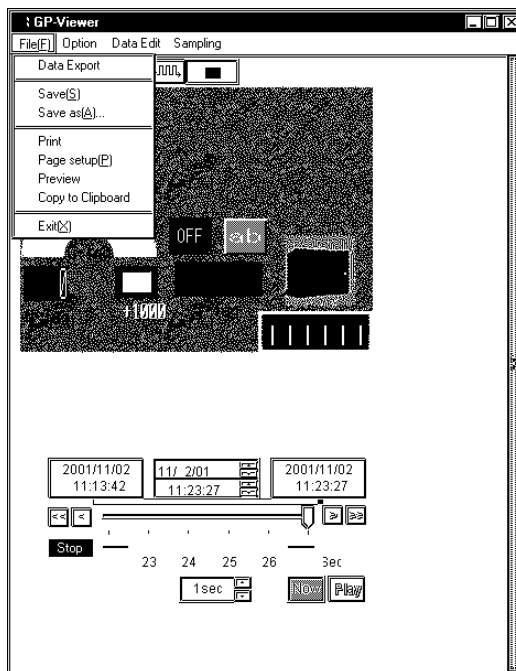

Exporting Data

1. Select [Data Export] on the [File (E)] menu.
2. The [Export] dialog appears. Designate each item, and then click [Export].

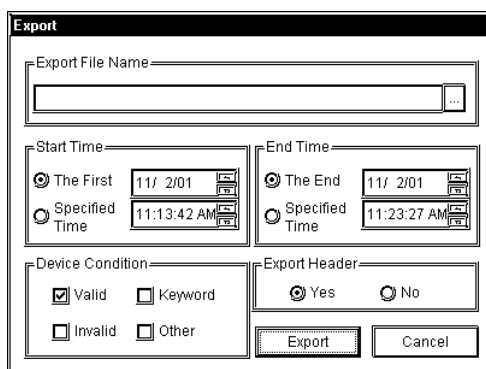

[Export File Name]

Designate the location and the file name to save exported data. The file extension is (.CSV).

[Start Time]

Designate the time to start exporting data. If you wish to start exporting immediately after you clicked [Export], check “The First”. If you wish to start exporting at the designated time, check “Specified Time”. If you checked “Specified Time”, you should also designate the start time to export.

[End Time]

Designate the time to end exporting data. If you wish to export the entire sampled data, check “The End”. If you wish to export until the designated time, check “Specified Time”. If you checked “Specified Time”, you should also designate the end time to export.

[Device Condition]

This is the reserved data. You should not change the designated value.

[Export Header]

If you wish to include the header information in exported data, check “Yes”. If not, check “No”.

[Export]

Executes the data export.

[Cancel]

The process is stopped and goes back to GP-Viewer.

MEMO

Although you can start multiple GP-Viewer programs, you cannot export data simultaneously.

Saving Data

1. If you wish to save displayed data to GP-Viewer, click [Save (S)] on the [File (E)] menu. Data are overwritten.

If you wish to save displayed data to GP-Viewer as a separate file name, click [Save As (A)] on the [File (E)] menu. The [Save As] dialog appears. Enter the file name, and then click [Save].

Print

1. Click [Print] on the [File (E)] menu. The printing process is executed.

Page Setup

1. Click [Page Setup(P)] on the [File (E)] menu.
2. The [Page Setup] dialog appears. Designate each item, and then click [OK].

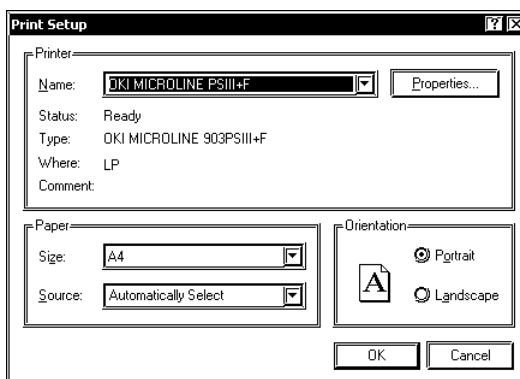

MEMO

The contents of the [Page Setup] dialog differ depending on your printer. Refer to the user manual of your printer for details.

Preview

1. Click [Preview] on the [File (E)] menu.
2. The print preview appears.

Copy to Clipboard

1. Click [Copy to Clipboard] on the [File (E)] menu.
2. The data value displayed on GP-Viewer is copied into the clipboard.
3. Paste the data value onto the application used.

MEMO

You can only copy data in the data display area of GP-Viewer into the clipboard. You cannot copy data such as a title.

Exit

1. Click [Exit(X)] on the [File (E)] menu. Exits GP-Viewer.

Options

This is selected on [Data View (D)] of the menu bar.

1. Select [Option] on [Data View (D)] of the menu bar.

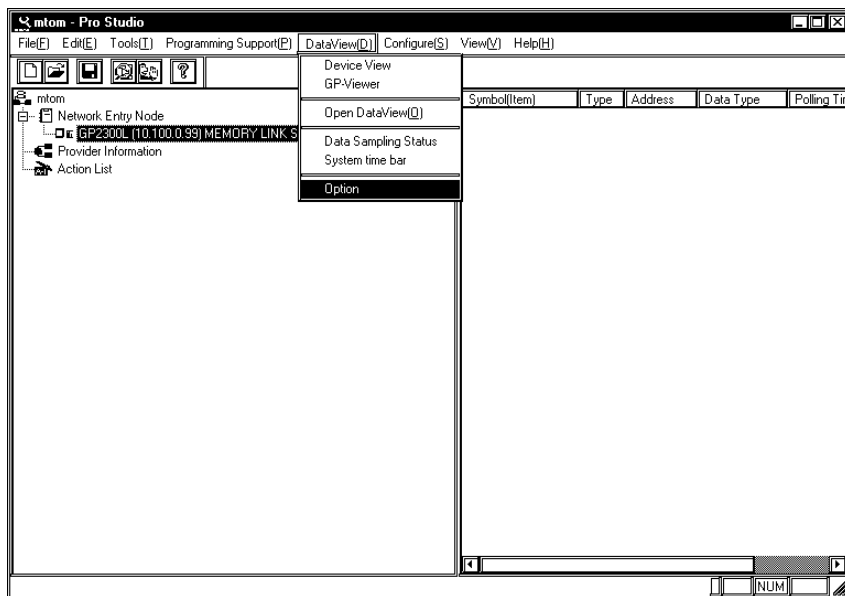

2. The [DataView Option] dialog appears.

You can select “Show/Hide” of the setup menu and the save button.

If you uncheck “Display menu”, the [Option], the [Data Edit], and the [Sampling] menus are hidden on GP-Viewer.

If you uncheck “Display button”, , , and  buttons are hidden on GP-Viewer.

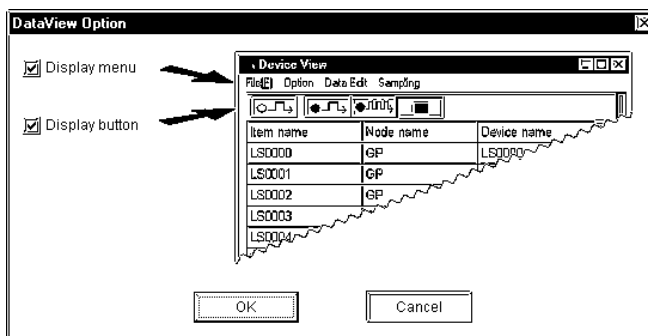

Supported Drawing Commands

Among GP-PRO/PBIII drawing commands, the following commands are supported by GP-Viewer.

Only the following drawing features are function properly.

- line/poly-line command
- rectangle command
- circle/ellipse command
- arc/sector command
- polygon fill command
- ruler command
- text string command
- mark call-up command

Among these drawing commands, there are some functions not available with GP-Viewer. Functions available and not available with GP-Viewer are listed below for each drawing command.

The display may differ between GP and GP-Viewer even if drawing commands are supported.

Line/Poly-line Command		
	specifying a display color	Yes
	blinking a display color	Yes
	specifying a background color	No
	blinking a background color	No
	drawing an arrow	Yes
	drawing a solid line	Yes
	drawing a dotted line	No
Rectangle Command		
	specifying a display color	Yes
	blinking a display color	Yes
	specifying a background color	No
	blinking a background color	No
	drawing a solid line	Yes
	drawing a dotted line	No
	chamfering	Yes
	specifying the number of dots in chamfering	Yes
	solid fill pattern	Yes
	fill patterns except for a solid fill	No

Circle/Ellipse Command		
	specifying a display color	Yes
	blinking a display color	Yes
	specifying a background color	No
	blinking a background color	No
	drawing a solid line	Yes
	drawing a dotted line	No
	solid fill pattern	Yes
	fill patterns except for a solid fill	No
Arc/Sector Command		
	specifying a display color	Yes
	blinking a display color	Yes
	specifying a background color	No
	blinking a background color	No
	drawing a solid line	Yes
	drawing a dotted line	No
Polygon Fill Command		
	specifying a display color	Yes
	blinking a display color	Yes
	specifying a background color	No
	blinking a background color	No
	drawing a solid line	Yes
	drawing a dotted line	No
	solid fill pattern	Yes
	fill patterns except for a solid fill	No
Ruler Command		
	specifying a display color	Yes
	blinking a display color	Yes
	specifying a background color	No
	blinking a background color	No
	drawing a solid line	Yes
	drawing a dotted line	No
	ruler type	Yes
	number of graduations to be divided	Yes

Text String Command		
	specifying a display color	Yes
	blinking a display color	Yes
	specifying a background color	Yes
	blinking a background color	Yes
	specifying a shade color of a carving style	Yes
	blinking a shade color of a carving style	Yes
	text direction	Yes
	text style	Yes
	text size	Yes
	text rotation angle	Yes
	text font	No
Mark Call-up Command		
	specifying a display color	Yes
	blinking a display color	Yes
	specifying a background color	Yes
	blinking a background color	Yes
	specifying a mark size	Yes

Supported Tag Commands

The following GP-PRO/PBIII tag commands are supported by GP-Web.

Only the following tags are supported.

- C tag
- E tag
- F tag
- G tag
- K tag
- L tag
- N tag
- S tag
- T tag
- U tag

Among these tag commands, there are some features not available with GP-Web. Refer to the following list for each tag command.

The display may differ for GP and for your Web browser even if drawing commands are supported.

C Tag				
	character size	–	Yes	Yes
	specifying a display color	–	Yes	Yes
	blinking a display color	–	Yes	Yes
	specifying display rotation	–	Yes	Yes
	specifying a tiling pattern	–	Yes	Yes
	specifying a background color	–	Yes	Yes
	character size (full/half)	–	Yes	Yes
	specifying a background color at tiling	–	Yes	Yes
E Tag				
	specifying data (absolute/relative)	–	Yes	Yes
	specifying a sign	–	Yes	Yes
	rounding off numbers	–	Yes	Yes
	specifying a display data form	–	Yes	Yes
	specifying display address (indirect)	–	No	No
	bit length when [relative] is selected	–	Yes	Yes
	input sign when [relative] is selected	–	Yes	Yes
	input display when [relative] is selected	–	Yes	Yes
	input range when [relative] is selected	–	Yes	Yes
	display range when [relative] is selected	–	Yes	Yes
	character size	–	Yes	Yes
	the number of digits to be displayed	–	Yes	Yes
	the number of decimals	–	Yes	Yes
	display style		Yes	Yes

E Tag				
	specifying a range	–	Yes	Yes
	the number of ranges	–	Yes	Yes
	setting a range	–	Yes	Yes
	specifying a number color	–	Yes	Yes
	blinking a number color	–	Yes	Yes
	specifying a background pattern	–	Yes	Yes
	specifying a background color	–	Yes	Yes
	blinking a background color	–	Yes	Yes
	operation	–	Yes	Yes
	specifying display rotation	–	Yes	Yes
F Tag				
	specifying a display (direct/indirect)	–	Yes	Yes
	type of screen (base screen/image screen)	–	Yes	Yes
	type of screen (CF card image screen)	–	No	No
	screen number	–	Yes	Yes
	specifying a word address	–	Yes	Yes
	specifying a display data form when [relative] is selected	–	Yes	Yes
	operation mode (area move/move between 2 points)	–	Yes	Yes
	displaying a display data form	–	Yes	Yes
G Tag				
	specifying data (absolute/relative)	Yes	Yes	Yes
	display mode	Yes	Yes	Yes
	display a data form when [absolute] is selected (BIN/BCD)	Yes	Yes	Yes
	input range when [relative] is selected	Yes	Yes	Yes
	chart type (bar chart/pie chart/half-pie chart)	Yes	Yes	Yes
	fill patterns for a bar chart	Yes	Yes	Yes
	chart fill patterns except for a bar chart	No	No	No
	indicating a starting point of a meter-type pie or half-pie chart	Yes	Yes	Yes
	specifying a display color	Yes	Yes	Yes
	specifying a background color	No	No	No
	blinking a background color	No	No	No
	displaying alarm	Yes	Yes	Yes
	specifying alarm background color	No	No	No
	blinking alarm background color	No	No	No
	specifying display rotation	No	Yes	Yes

K Tag				
	specifying a data (absolute/relative/character string)	–	Yes	Yes
	specifying a word address	–	Yes	Yes
	specifying a starting bit address	–	No	No
	specifying a display address (indirect)	–	No	No
	specifying a sign	–	Yes	Yes
	rounding off numbers	–	Yes	Yes
	specifying display/write data form	–	Yes	Yes
	bit length when [relative] is selected	–	Yes	Yes
	input sign when [relative] is selected	–	Yes	Yes
	input range when [relative] is selected	–	Yes	Yes
	display range when [relative] is selected	–	Yes	Yes
	the number of characters to be displayed when [character string] is selected	–	Yes	Yes
	character size	–	Yes	Yes
	the number of digits to be displayed	–	Yes	Yes
	the number of decimals (direct/indirect)	–	Yes	Yes
	specifying display style	–	Yes	Yes
	automatic clear	–	No	No
	checking the number of digits to be input	–	No	No
	bar code input	–	No	No
	alarm (direct/indirect/color change)	–	Yes	Yes
	specifying an alarm display color	–	Yes	Yes
	blinking an alarm display color	–	Yes	Yes
	specifying an alarm background color	–	Yes	Yes
	blinking an alarm background color	–	Yes	Yes
	operation	–	Yes	Yes
	specifying display rotation	–	Yes	Yes
L Tag				
	screen number (direct/indirect/state)	Yes	Yes	Yes
	starting method	Yes	Yes	Yes
	calling the base screen and the image screen	Yes	Yes	Yes
	delete action (enable/unable)	Yes	Yes	Yes
	display a data form when [indirect] is selected (BIN/BCD)	Yes	Yes	Yes
	calling image screens in the CF Card	No	No	No

N Tag				
	specifying data (absolute/relative)	Yes	Yes	Yes
	specifying if to show a negative number	Yes	Yes	Yes
	specifying a display data form	Yes	Yes	Yes
	access a data length	Yes	Yes	Yes
	input range when [relative] is selected	Yes	Yes	Yes
	text size	Yes	Yes	Yes
	text font	No	No	No
	number of digits to be displayed	Yes	Yes	Yes
	specifying a display color	Yes	Yes	Yes
	blinking a display color	Yes	Yes	Yes
	specifying a background color	Yes	Yes	Yes
	blinking a background color	No	No	No
	alarm process	Yes	Yes	Yes
	specifying an alarm color	Yes	Yes	Yes
	blinking an alarm color	Yes	Yes	Yes
	specifying an alarm background color	Yes	Yes	Yes
	blinking an alarm background color	No	No	No
	operator process	Yes	Yes	Yes
	specifying display rotation	No	Yes	Yes
S Tag				
	starting method	Yes	Yes	Yes
	post-start read	Yes	Yes	Yes
	text size	Yes	Yes	Yes
	text font	No	No	No
	number of texts to be displayed	Yes	Yes	Yes
	specifying a text color	Yes	Yes	Yes
	blinking a text color	Yes	Yes	Yes
	specifying a background color	Yes	Yes	Yes
	blinking a background color	Yes	Yes	Yes
	display location	Yes	Yes	Yes
	clearing display	Yes	Yes	Yes
	specifying display angle	Yes	Yes	Yes

T Tag				
	write action mode (bit/word/special)	Yes	Yes	Yes
	specifying an operator	Yes	Yes	Yes
	hierarchical screen switching	Yes	Yes	Yes
	special actions except for T tag extension	No	No	No
	Q tag extended action	No	No	No
	function key process	No	No	No
	interlock capability	Yes	Yes	Yes
	grouping with the automatic disable capability	Yes	Yes	Yes
	addition/subtraction on/from a specified digit	Yes	Yes	Yes
	GP reset	Yes	Yes	Yes
	AUX output	No	No	No
	buzzer sound	Yes	Yes	Yes
	reverse display	Yes	Yes	Yes
U Tag				
	specifying method of the window registration screen (direct/indirect)	Yes	Yes	Yes
	display a data form when [indirect] is selected (BIN/BCD)	Yes	Yes	Yes
	action mode	Yes	Yes	Yes
	reshuffling of overlapped screens	Yes	Yes	Yes

7.4 Checking the Data Sampling Status

This section describes the procedure to check the sampling status of device data.

1. Select [Data Sampling Status] on [Data View (D)] of the menu bar.

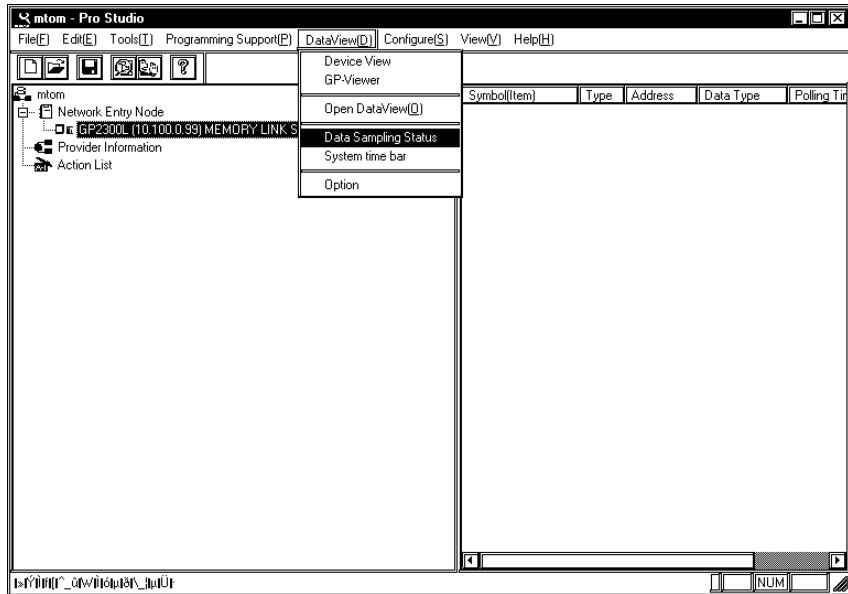

2. The [Data Sampling Status] dialog appears. The sampling status of each registered database is displayed so that you can check the contents.

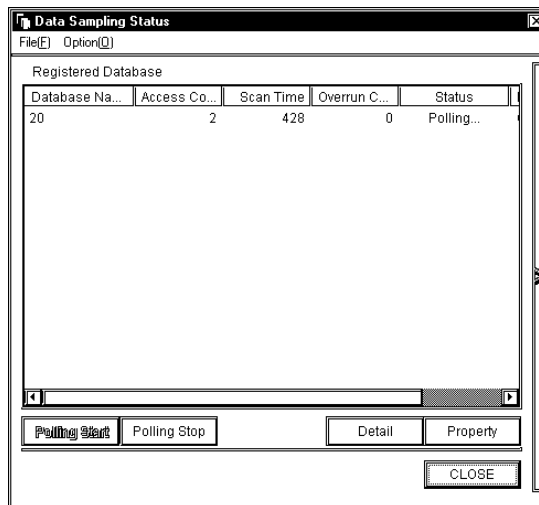

[File (F)]

You can open a database not displayed here, or close the [Data Sampling Status] dialog.

[Option (O)]

You can set the [Data Sampling Status] dialog to be “displayed on the front always”.

[Polling Start]

If you select a database that a sampling is not currently executed, this button becomes active.

If you click this button, the data save is started.

[Polling Stop]

If you select the database that a sampling is currently executed, this button becomes active.

If you click this button, the data save is stopped.

[Detail]

After selecting the database that you wish to check the detail, click the [Detail] button.

If you click it, the [Detail] dialog appears. The detailed contents of the selected database are displayed.

[Set]

After selecting the database that you wish to change the data sampling condition, click the [Set] button.

If you click it, the [Sampling method] dialog appears so that you can change the data sampling condition of the selected database. The operation procedure is equal to the procedure after Step 4 in “7.2.2 Setting the Data Sampling Condition” or in “7.3.2 Setting the Data Sampling Condition”

Reference → “7.2.2 Setting the Data Sampling Condition”, “7.3.2 Setting the Data Sampling Condition”

7.5 System Time Bar

This section describes the operation procedure of System Time Bar.

1. Select [System time bar] on [Data View (D)] of the menu bar.

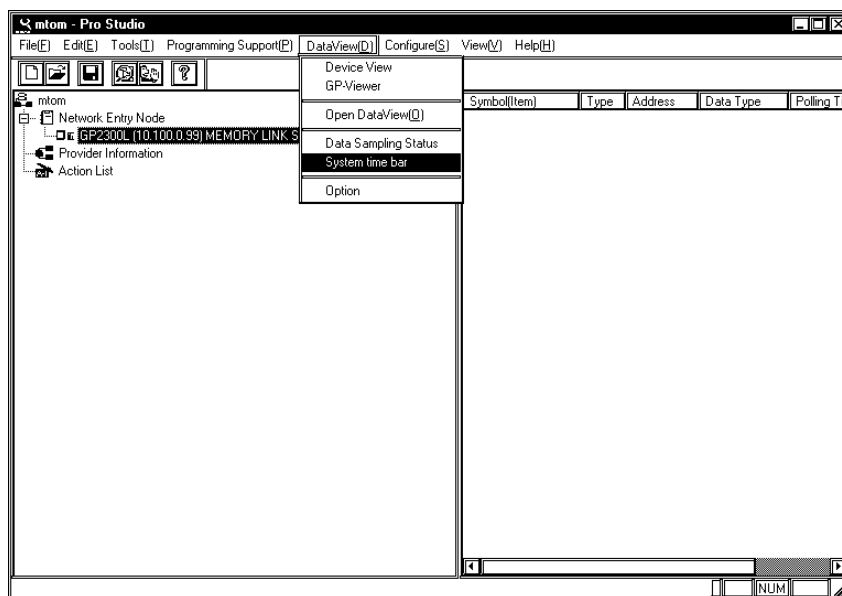

2. System Time Bar appears.

Click [Change Database] to open the database (file) that you wish to display.

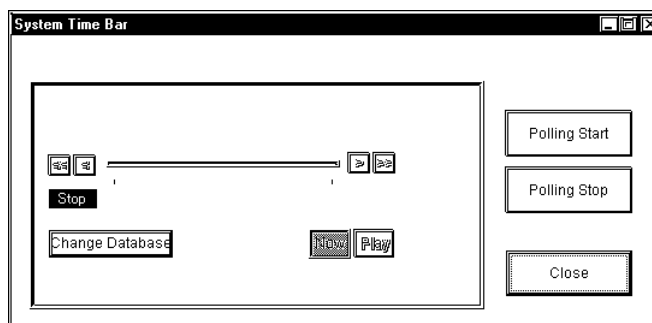

3. The contents of the selected database is displayed in System Time Bar.

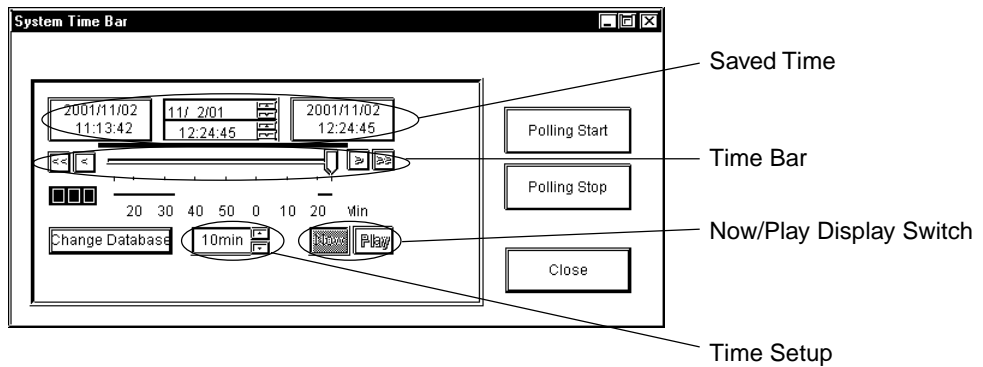

[Saved Time]

This field shows the saved time of the saved device data.

The field shows, from the left, the saving start time, the time for currently displayed data and the last saved time. When the current status is displayed, the time for currently displayed data is identical to the last saved time.

[Time Bar]

Saved data can be displayed by sliding the time bar control to either side. The data saving process continues even while you operate the control.

[Time Setup]

You can designate the time unit for one graduation of the time bar.

[Now/Play Display Switch]

[Now] and [Play] buttons are available. You can playback the saved data from the designated time either by sliding the time bar control to the time that you wish to start the playback or by clicking the [Play] button after clicking the time for currently displayed data (the center field of [Saved Time]) and then entering the time to start the playback.

[Polling Start]

If you click this button, the data save is started.

[Polling Stop]

If you click this button, the data save is stopped.

[Close]

If you click this button, you can exit the System Time Bar.

[Change Database]

If you click this button, the [Open] dialog appears. If you select the database that you wish to display and click [Open], it is displayed in System Time Bar.

Purpose of System Time Bar

System Time Bar has been developed for the purpose of using the Time Bar (data playback) feature on your own applications.

If you read the file used on your own application (e.g. application to display the database value in a bar graph format) that is equal to the Pro-Server Database File (*.#DB) into System Time Bar, you can synchronize the action of System Time Bar with the display contents of your application (e.g. length change of a bar graph) so that you can playback the database contents on various applications.

8 | Maintenance via Ethernet

This chapter explains the maintenance procedures you can perform via the Ethernet network.

- 8.1 Transferring Network Project Files
- 8.2 Transferring Only Updated Screen Data to GPs
- 8.3 Searching for a Network Node

8.1 Transferring Network Project Files

The following procedures explain how to transfer a modified network project file (*.npj) via the Ethernet network to a previously set up GP (i.e. that has had its system data file sent to it).

1. On the Network Entry Node list, click the destination GP.

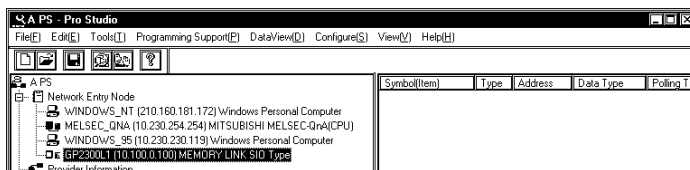

If you are currently editing a network project file, the file must be saved before it can be sent to a GP.

2. Click [Transfer Network Project] in the [Tools(T)] menu.

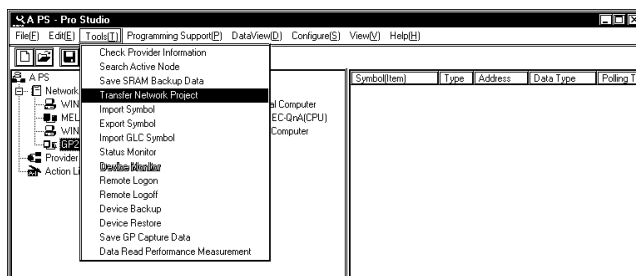

3. The [Transfer Network Project File] window appears and then the transfer of the network project file begins.

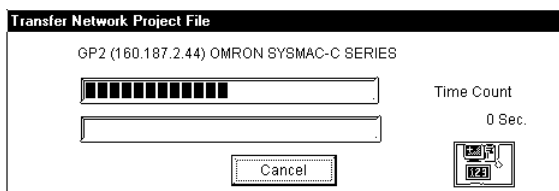

MEMO

You can transfer the file to multiple GPs at the same time by selecting [Network Entry Node List] and then entry nodes that you wish to transfer the file from the listed entry nodes on the right side.

8.2 Transferring Only Updated Screen Data to GPs

If you have modified screen data via the GP-PRO/PB III screen editor software, follow the procedure below to transfer only screen data to the GP. The following description assumes that GP-PRO/PB III's data transfer window is open.

1. Click [Transfer Settings] in the [Setup] menu.

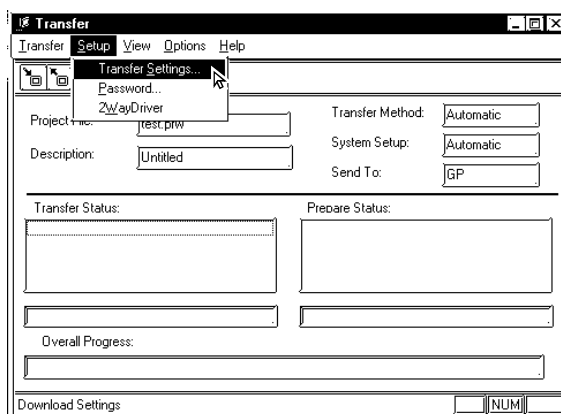

2. When the [Transfer Settings] window appears, click [Ethernet] in the [Send To] pull-down list and click [OK].

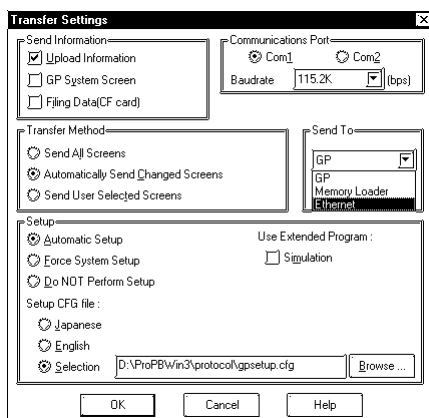

Ethernet can be used to transfer only the updated screen data to the GPs whose setup has been completed.

However, set-up via Ethernet is also possible with the GP2000 Series.

Reference → “GP-PRO/PBIII for Windows Help Files”

MEMO

Transferring your screen data in on-line mode temporarily causes the GP to display the transfer screen. The initial screen will be restored as soon as data transfer is completed.

- Click [Send] in the Transfer menu or on the Send Screen button to transfer the information to the GP.

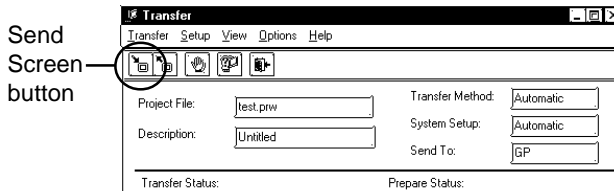
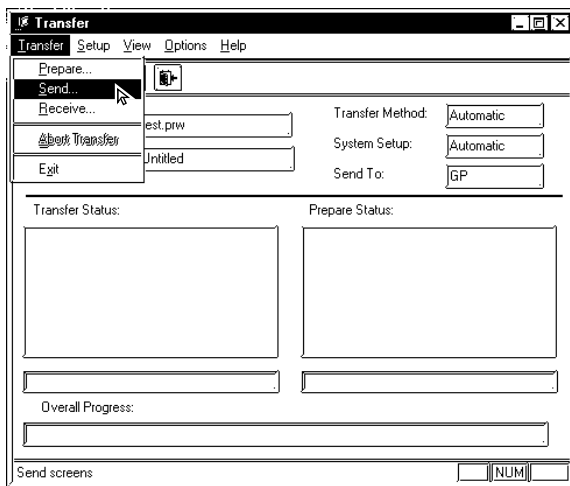

The GP displays the following information when the screen data is being transferred.

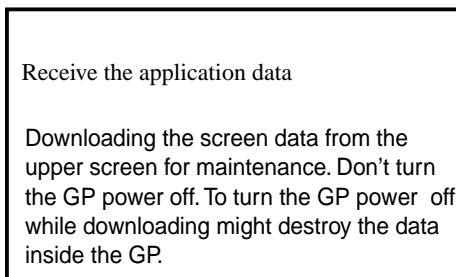

For how to setup a GP for Ethernet, refer to A.5 Setting Up a GP for Ethernet.

MEMO

From GP-PRO/PBIII for Windows Ver. 4.0, only screen data transfer is required. The Network Project file's data is not sent.

As a result, the sending of the same screen data to multiple GPs at the same time is possible. When the Network Project file is modified, use the Pro-Studio [Tool] menu's [Transfer Network Project] selection to send this updated data.

Reference → "8.1 Transferring a Network Project"

8.3 Searching for a Network Node

You can create a list of the GPs and PCs that are active in the network and immediately register any node that is not in the network project file (*.npj). (The following description assumes that Pro-Studio's main window is open)

1. Click [Search Active Node] in the [Tools(I)] menu.

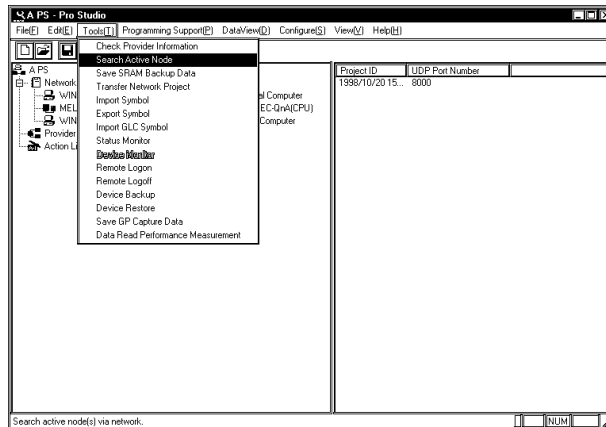

Use this function to automatically search for the nodes connected to the network. It allows you to register network nodes easily, since information such as the PLC type is retrieved and entered automatically by Pro-Studio.

2. The following dialog box will appear. To register any of the detected nodes, click first the [Node Status] "Non-Entry" text, then the [Entry] button.

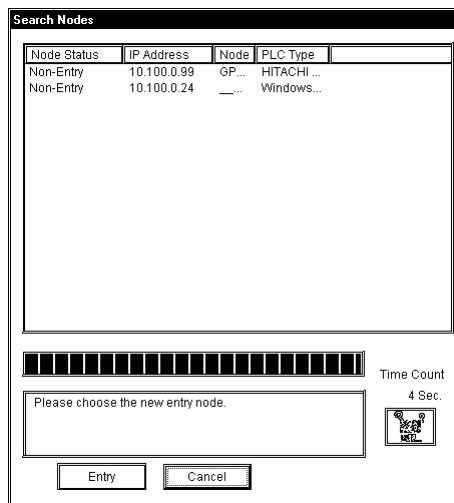

3. The following dialog box will appear to show that the node has been registered.

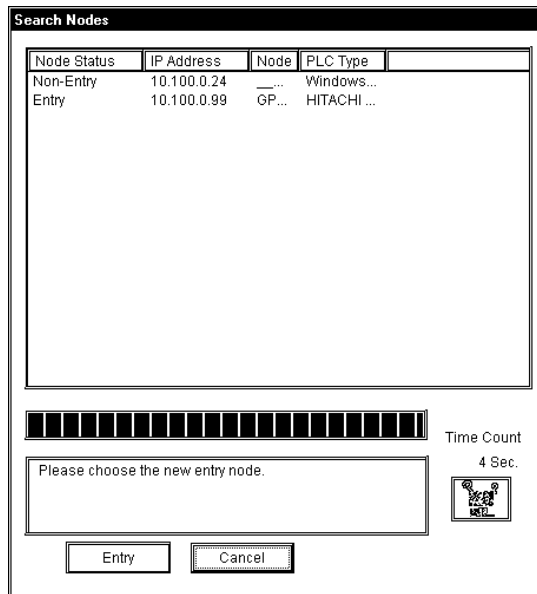

9 | Simple DLL Function

This chapter describes the Simple DLL function.

- 9.1 Simple DLL Function
- 9.2 Example of Simple DLL Function

9.1 Simple DLL (ProEasy.DLL) Function

This section explains functions used to read and write PLC data from applications created via Visual Basic and Visual C. These functions will be provided via the simple DLL

(ProEasy.DLL) and will be contained in “C:\Windows\System” at program installation.

Since GetMessage and DispatchMessage will be repeatedly sent until Pro-Server returns an acknowledge for the SendMessage, messages to the thread will be processed.

MEMO A sample Pro-Easy.DLL program is included in the Pro-Server with Pro-Studio for Windows CD-ROM.

9.1.1 Precautions When Using Functions

Precautions When Using the Read/WriteDeviceBIT Function

PwData stores the quantity of data specified by wCount in series, starting from D0 bit.

(Ex. When wCount is 20)

	F	E	D	C	B	A	9	8	7	6	5	4	3	2	1	0
PwData	16	15	14	13	12	11	10	9	8	7	6	5	4	3	2	1
PwData+1	*	*	*	*	*	*	*	*	*	*	*	*	20	19	18	17

For data consisting of two or more bits that continue in series, using Read/WriteDevice16 or Read/WriteDevice32 to read/write 16 or 32 bits at a time is more effective than using Read/WriteDevice.

Since the “*” character denotes data that is not fixed or defined, use the application program to mask it.

Precautions When Using the Read/WriteDeviceBCD16/32 Functions

These functions are used to treat data as BCD inside the PLC. However, the data (contents of pxxData) transferred to and from these functions is binary not BCD. (Pro-Server internally converts this data.)

Negative values cannot be used.

Function Name	Decimal	Hex.
Read/WriteDeviceBCD16	0 to 9999	0000 to 270F
Read/WriteDeviceBCD32	0 to 99999999	00000000 to 05F5E0FF

Precautions When Using String Data Functions

For variables to receive string data, be sure to keep data space large enough to receive the data.

Single-Thread Function and Multi-Thread Function

A single-thread function accesses to multiple GPs from a single application sequentially.

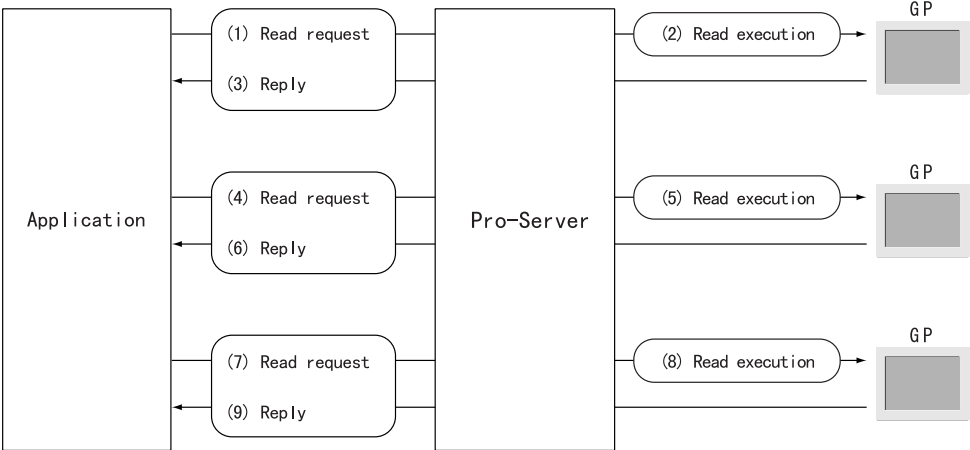

A multi-thread function accesses to multiple GPs from multiple applications. Multiple read requests can be realized simultaneously and an access speed to multiple GPs increases.

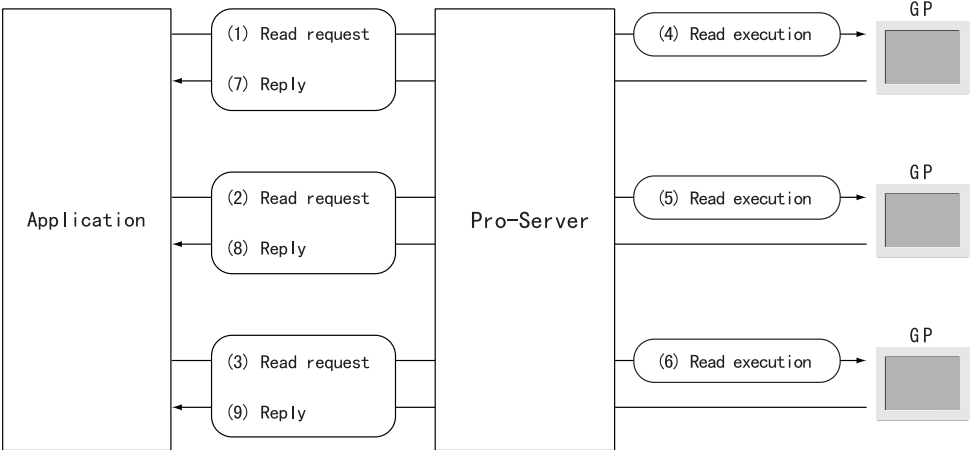

Precautions When Using Simple DLL from Multiple Threads in Function for Multi-Thread

Acquire the handle per thread (CreatProServerHandle), and then designate arguments.

Precautions When Threads Other Than the Main Thread Use Simple DLL in Function for Multi-Thread

If the thread that uses the simple DLL is not the application's main thread (which starts when the application is started and terminates when the application is terminated) but a thread generated in the main thread, the following procedures are needed:

- Before using the simple DLL, initialize it by executing EasyInit in the thread that uses the simple DLL.

- Before the thread that uses the simple DLL terminates, terminate the simple DLL by executing EasyTerm.

Unless the above procedures are followed, the resources used by the simple DLL may not be released for use by other programs.

Perform initialization and shutdown processing once for each application. If these are used multiple times, the system may not return from simple DLL.

Precautions When LPVARIANT Returns an Undefined Error at ProEasy.h Compilation by VC

When Visual C++ ver. 6 is used to compile Pro-SDK\VC\Public\ProEasy.h, or the header data copied to the clipboard via Pro-Studio's (Programming extension), [VC Text], the LPVARIANT may return an undefined error. Since the LPVARIANT is defined within afxdisp.h, if the data is not included, an error will occur. To avoid this error to occur, you should define "#include<afxdisp.h>" in stdafx.h in a normal case.

GLC 32 Bit Device Bit Access Method

The GLC unit's 32-bit addressing (integer variables, integer array variables) can access data in individual bit units. Adding a suffix (descriptor). Xm to a variable name allows this type of bit unit access. Also, adding the suffix<n> to a variable name allows you to designate individual array elements. Therefore, if you wish to access the Integer_Array's N+1 element's m+1 position bit, you would write Integer_Array<n>.Xm.

Ex. To access the Integer_Variable's 7th position bit, you would write Integer.X6.

Ex. To access the Integer_Array's 2nd element's 30th position bit, you would write Integer_Array<1>.X29.

9.1.2 Direct Read/Write Function

This is a Pro-Server synchronous function that, when a Read/Write request is issued by an application, accesses the designated PLC device via the GP unit, and then waits until the PLC returns the result to Pro-Server, via the GP.

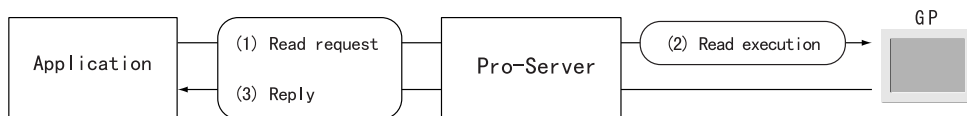

There are three types of functions and they are stored in the following order.

Read****D..... Read (in) function.

Write****.....Write (in) function. To check if the Write was performed correctly, a successive Read is performed.

Write****D.....Write (in) function. Read check is not performed. Used for Write Only devices.

Direct Read/Write Function for Single-Thread

Bit data

```
INT WINAPI ReadDeviceBitD(LPCTSTR bsNodeName,LPCTSTR bsDeviceName,WORD* pwData,
WORD wCount);
```

```
INT WINAPI WriteDeviceBit(LPCTSTR bsNodeName,LPCTSTR bsDeviceName,WORD* pwData,
WORD wCount);
```

```
INT WINAPI WriteDeviceBitD(LPCTSTR bsNodeName,LPCTSTR bsDeviceName,WORD* pwData,
WORD wCount);
```

16-bit data

```
INT WINAPI ReadDevice16D(LPCTSTR bsNodeName,LPCTSTR bsDeviceName,WORD* pwData,
WORD wCount);
```

```
INT WINAPI WriteDevice16(LPCTSTR bsNodeName,LPCTSTR bsDeviceName,WORD* pwData,
WORD wCount);
```

```
INT WINAPI WriteDevice16D(LPCTSTR bsNodeName,LPCTSTR bsDeviceName,WORD* pwData,
WORD wCount);
```

32-bit data

```
INT WINAPI ReadDevice32D(LPCTSTR bsNodeName,LPCTSTR bsDeviceName,DWORD* pdwData,
WORD wCount);
```

```
INT WINAPI WriteDevice32(LPCTSTR bsNodeName,LPCTSTR bsDeviceName,DWORD* pdwData,
WORD wCount);
```

```
INT WINAPI WriteDevice32D(LPCTSTR bsNodeName,LPCTSTR bsDeviceName,DWORD* pdwData,
WORD wCount);
```

16-bit BCD data

INT WINAPI ReadDeviceBCD16(LPCTSTR bsNodeName,LPCTSTR bsDeviceName,WORD* pwData,
WORD wCount);

INT WINAPI WriteDeviceBCD16(LPCTSTR bsNodeName,LPCTSTR bsDeviceName,WORD* pwData,
WORD wCount);

INT WINAPI WriteDeviceBCD16D(LPCTSTR bsNodeName,LPCTSTR bsDeviceName,WORD* pwData,
WORD wCount);

32-bit BCD data

INT WINAPI ReadDeviceBCD32D(LPCTSTR bsNodeName,LPCTSTR bsDeviceName,DWORD* pdwData,
WORD wCount);

INT WINAPI WriteDeviceBCD32(LPCTSTR bsNodeName,LPCTSTR bsDeviceName,DWORD* pdwData,
WORD wCount);

INT WINAPI WriteDeviceBCD32D(LPCTSTR bsNodeName,LPCTSTR bsDeviceName,DWORD* pdwData,
WORD wCount);

Single-precision floating-point data

INT WINAPI ReadDeviceFloatD(LPCTSTR bsNodeName,LPCTSTR bsDeviceName,FLOAT* pflData,
WORD wCount);

INT WINAPI WriteDeviceFloat(LPCTSTR bsNodeName,LPCTSTR bsDeviceName,FLOAT* pflData,WORD wCount);

INT WINAPI WriteDeviceFloatD(LPCTSTR bsNodeName,LPCTSTR bsDeviceName,FLOAT* pflData,
WORD wCount);

Double-precision floating-point data

INT WINAPI ReadDeviceDoubleD(LPCTSTR bsNodeName,LPCTSTR bsDeviceName,DOUBLE* pdbData,
WORD wCount);

INT WINAPI WriteDeviceDouble(LPCTSTR bsNodeName,LPCTSTR bsDeviceName,DOUBLE* pdbData,
WORD wCount);

INT WINAPI WriteDeviceDouble(LPCTSTR bsNodeName,LPCTSTR bsDeviceName,DOUBLE* pdbData,
WORD wCount);

String data

INT WINAPI ReadDeviceStrD(LPCTSTR bsNodeName,LPCTSTR bsDeviceName,LPTSTR psData,
WORD wCount);

INT WINAPI WriteDeviceStr(LPCTSTR bsNodeName,LPCTSTR bsDeviceName,LPCTSTR psData,
WORD wCount);

INT WINAPI WriteDeviceStr(LPCTSTR bsNodeName,LPCTSTR bsDeviceName,LPCTSTR psData,WORD wCount);

General-use data

INT WINAPI ReadDeviceD(LPCTSTR bsNodeName,LPCTSTR bsDeviceName,LPVOID pData,WORD wCount,
WORDwAppKind);

INT WINAPI WriteDevice(LPCTSTR bsNodeName,LPCTSTR bsDeviceName,LPVOID pData,WORD wCount,
WORDwAppKind);

INT WINAPI WriteDeviceD(LPCTSTR bsNodeName,LPCTSTR bsDeviceName,LPVOID pData,WORD wCount,
WORDwAppKind);

General-use data(for VB)

```
INT WINAPI ReadDeviceVariantD(LPCTSTR bsNodeName,LPCTSTR bsDeviceName,LPVARIANT pData,
WORDwCount,WORD wAppKind);
```

```
INT WINAPI WriteDeviceVariant(LPCTSTR bsNodeName,LPCTSTR bsDeviceName,LPVARIANT pData,
WORDwCount,WORD wAppKind);
```

```
INT WINAPI WriteDeviceVariantD(LPCTSTR bsNodeName,LPCTSTR bsDeviceName,LPVARIANT pData,
WORDwCount,WORD wAppKind);
```

Direct Read/Write Function for Multi-Thread

Bit data

```
INT WINAPI ReadDeviceBitDM(HANDLE hProServer,LPCTSTR bsNodeName,
LPCTSTRbsDeviceName,WORD* pwData,WORD wCount);
```

```
INT WINAPI WriteDeviceBitM(HANDLE hProServer,LPCTSTR bsNodeName,
LPCTSTRbsDeviceName,WORD* pwData,WORD wCount);
```

```
INT WINAPI WriteDeviceBitDM(HANDLE hProServer,LPCTSTR bsNodeName,
LPCTSTRbsDeviceName,WORD* pwData,WORD wCount);
```

16 bit data

```
INT WINAPI ReadDevice16DM(HANDLE hProServer,LPCTSTR bsNodeName,
LPCTSTRbsDeviceName,WORD* pwData,WORD wCount);
```

```
INT WINAPI WriteDevice16M(HANDLE hProServer,LPCTSTR bsNodeName,
LPCTSTRbsDeviceName,WORD* pwData,WORD wCount);
```

```
INT WINAPI WriteDevice16DM(HANDLE hProServer,LPCTSTR bsNodeName,
LPCTSTRbsDeviceName,WORD* pwData,WORD wCount);
```

32 bit data

```
INT WINAPI ReadDevice32DM(HANDLE hProServer,LPCTSTR bsNodeName,
LPCTSTRbsDeviceName,DWORD* pdwData,WORD wCount);
```

```
INT WINAPI WriteDevice32M(HANDLE hProServer,LPCTSTR bsNodeName,
LPCTSTRbsDeviceName,DWORD* pdwData,WORD wCount);
```

```
INT WINAPI WriteDevice32DM(HANDLE hProServer,LPCTSTR bsNodeName,
LPCTSTRbsDeviceName,DWORD* pdwData,WORD wCount);
```

16 bit BCD data

```
INT WINAPI ReadDeviceBCD16DM(HANDLE hProServer,LPCTSTR bsNodeName,
LPCTSTRbsDeviceName,WORD* pwData,WORD wCount);
```

```
INT WINAPI WriteDeviceBCD16M(HANDLE hProServer,LPCTSTR bsNodeName,
LPCTSTRbsDeviceName,WORD* pwData,WORD wCount);
```

```
INT WINAPI WriteDeviceBCD16DM(HANDLE hProServer,LPCTSTR bsNodeName,
LPCTSTRbsDeviceName,WORD* pwData,WORD wCount);
```

32 bit BCD data

```
INT WINAPI ReadDeviceBCD32DM(HANDLE hProServer,LPCTSTR bsNodeName,
LPCTSTRbsDeviceName,DWORD* pdwData,WORD wCount);
```

```
INT WINAPI WriteDeviceBCD32M(HANDLE hProServer,LPCTSTR bsNodeName,
LPCTSTRbsDeviceName,DWORD* pdwData,WORD wCount);
```

```
INT WINAPI WriteDeviceBCD32DM(HANDLE hProServer,LPCTSTR bsNodeName,
LPCTSTRbsDeviceName,DWORD* pdwData,WORD wCount);
```

Single precision floating-point data

```
INT WINAPI ReadDeviceFloatDM(HANDLE hProServer,LPCTSTR bsNodeName,
LPCTSTRbsDeviceName,FLOAT* pflData,WORD wCount);
```

```
INT WINAPI WriteDeviceFloatM(HANDLE hProServer,LPCTSTR bsNodeName,
LPCTSTRbsDeviceName,FLOAT* pflData,WORD wCount);
```

```
INT WINAPI WriteDeviceFloatDM(HANDLE hProServer,LPCTSTR bsNodeName,
LPCTSTRbsDeviceName,FLOAT* pflData,WORD wCount);
```

Double precision floating-point data

```
INT WINAPI ReadDeviceDoubleDM(HANDLE hProServer,LPCTSTR bsNodeName,
LPCTSTRbsDeviceName,DOUBLE* pdbData,WORD wCount);
```

```
INT WINAPI WriteDeviceDoubleM(HANDLE hProServer,LPCTSTR bsNodeName,
LPCTSTRbsDeviceName,DOUBLE* pdbData,WORD wCount);
```

```
INT WINAPI WriteDeviceDoubleDM(HANDLE hProServer,LPCTSTR bsNodeName,
LPCTSTRbsDeviceName,DOUBLE* pdbData,WORD wCount);
```

String data

```
INT WINAPI ReadDeviceStrDM(HANDLE hProServer,LPCTSTR bsNodeName,
LPCTSTRbsDeviceName,LPTSTR psData,WORD wCount);
```

```
INT WINAPI WriteDeviceStrM(HANDLE hProServer,LPCTSTR bsNodeName,
LPCTSTRbsDeviceName,LPCTSTR psData,WORD wCount);
```

```
INT WINAPI WriteDeviceStrDM(HANDLE hProServer,LPCTSTR bsNodeName,
LPCTSTRbsDeviceName,LPCTSTR psData,WORD wCount);
```

General-use data

```
INT WINAPI ReadDeviceDM(HANDLE hProServer,LPCTSTR bsNodeName,
LPCTSTR bsDeviceName,LPVOIDpData,WORD wCount,WORD wAppKind);
```

```
INT WINAPI WriteDeviceM(HANDLE hProServer,LPCTSTR bsNodeName,
LPCTSTR bsDeviceName,LPVOID pData,WORD wCount,WORD wAppKind);
```

```
INT WINAPI WriteDeviceDM(HANDLE hProServer,LPCTSTR bsNodeName,
LPCTSTRbsDeviceName,LPVOID pData,WORD wCount,WORD wAppKind);
```

General-use data(for VB)

```
INT WINAPI ReadDeviceVariantDM(HANDLE hProServer,LPCTSTR bsNodeName,  
LPCTSTRbsDeviceName,LPVARIANT pData,WORD wCount,WORD wAppKind);  
INT WINAPI WriteDeviceVariantM(HANDLE hProServer,LPCTSTR bsNodeName,  
LPCTSTRbsDeviceName,LPVARIANT pData,WORD wCount,WORD wAppKind);  
INT WINAPI WriteDeviceVariantDM(HANDLE hProServer,LPCTSTR bsNodeName,  
LPCTSTRbsDeviceName,LPVARIANT pData,WORD wCount,WORD wAppKind);
```

9.1.3 Cache Read Function

If a device has been once read using the cache read function, Pro-Server will subsequently perform automatic polling and save device data in the cache memory within Pro-Server, and the second and subsequent read-outs will be executed more rapidly from the cache memory. The polling interval is equal to the interval at the symbol registration. When designating the Device Address directly, the value set in the [Configure (S)] -> [System] -> [DDE Polling Time] dialog box is used. (Default: 1000ms)

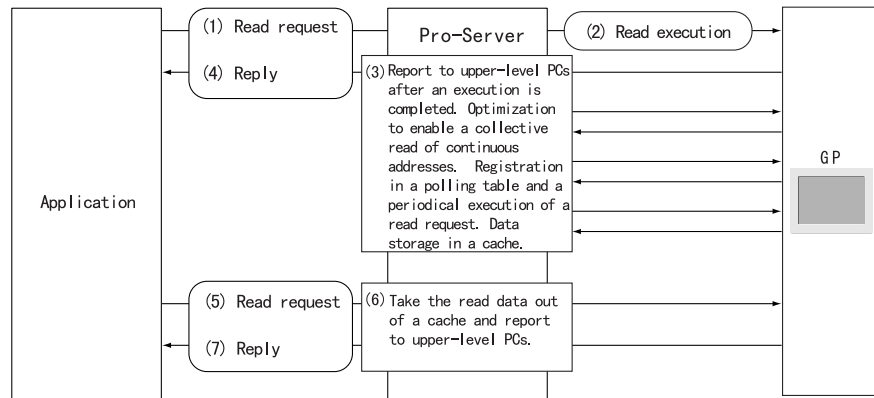

MEMO

- Because the second and subsequent read-outs are performed from the cache memory, the address value may be different from the real device address value.
- When the cache read function is used, once a device is read, an automatic polling is executed on Pro-Server. If you execute a wrong device address read, a communication error may occur repeatedly because of this automatic polling.

Cache Read Function for Single-Thread

Bit data

```
INT WINAPI ReadDeviceBit(LPCTSTR bsNodeName,LPCTSTR bsDeviceName,WORD* pwData,WORDwCount);
```

16 bit data

```
INT WINAPI ReadDevice16(LPCTSTR bsNodeName,LPCTSTR bsDeviceName,WORD* pwData,WORD wCount);
```

32 bit data

```
INT WINAPI ReadDevice32(LPCTSTR bsNodeName,LPCTSTR bsDeviceName,DWORD* pdwData,WORDwCount);
```

16 bit BCD data

```
INT WINAPI ReadDeviceBCD16(LPCTSTR bsNodeName,LPCTSTR bsDeviceName,WORD* pwData,WORD wCount);
```

32 bit BCD data

```
INT WINAPI ReadDeviceBCD32(LPCTSTR bsNodeName,LPCTSTR bsDeviceName,DWORD* pdwData,
WORD wCount);
```

Single precision floating-point data

```
INT WINAPI ReadDeviceFloat(LPCTSTR bsNodeName,LPCTSTR bsDeviceName,FLOAT* pfData,
WORD wCount);
```

Double precision floating-point data

```
INT WINAPI ReadDeviceDouble(LPCTSTR bsNodeName,LPCTSTR bsDeviceName,DOUBLE* pdbData,
WORD wCount);
```

String data

```
INT WINAPI ReadDeviceStr(LPCTSTR bsNodeName,LPCTSTR bsDeviceName,LPTSTR psData,
WORD wCount);
```

General-use data

```
INT WINAPI ReadDevice(LPCTSTR bsNodeName,LPCTSTR bsDeviceName,LPVOID pData,
WORD wCount,WORD wAppKind);
```

Cache Read Function for Multi-Thread

A device whose data has once been read via the Cache Read function will then be polled by Pro-Server automatically. Therefore, data read from the second time will be performed at high speeds. The polling time to be used will be the one that has been used when the symbol is registered. The polling time to be used when a device address is directly designated will be one second. Polling for a device whose data has not been read for a certain period of time will automatically end.

Bit data

```
INT WINAPI ReadDeviceBitM(HANDLE hProServer,LPCTSTR bsNodeName,LPCTSTR
bsDeviceName,WORD* pwData,WORD wCount);
```

16 bit data

```
INT WINAPI ReadDevice16M(HANDLE hProServer,LPCTSTR bsNodeName,LPCTSTR
bsDeviceName,WORD* pwData,WORD wCount);
```

32 bit data

```
INT WINAPI ReadDevice32M(HANDLE hProServer,LPCTSTR bsNodeName,LPCTSTR
bsDeviceName,DWORD* pdwData,WORD wCount);
```

16 bit BCD data

```
INT WINAPI ReadDeviceBCD16M(HANDLE hProServer,LPCTSTR bsNodeName,LPCTSTR
bsDeviceName,WORD* pwData,WORD wCount);
```

32 bit BCD data

```
INT WINAPI ReadDeviceBCD32M(HANDLE hProServer,LPCTSTR bsNodeName,LPCTSTR
bsDeviceName,DWORD* pdwData,WORD wCount);
```

Single precision floating-point data

```
INT WINAPI ReadDeviceFloatM(HANDLE hProServer,LPCTSTR bsNodeName,LPCTSTR
bsDeviceName,FLOAT* pflData,WORD wCount);
```

Double precision floating-point data

```
INT WINAPI ReadDeviceDoubleM(HANDLE hProServer,LPCTSTR bsNodeName,LPCTSTR
bsDeviceName,DOUBLE* pdbData,WORD wCount);
```

String data

```
INT WINAPI ReadDeviceStrM(HANDLE hProServer,LPCTSTR bsNodeName,LPCTSTR
bsDeviceName,LPTSTR psData,WORD wCount);
```

General-use data

```
INT WINAPI ReadDeviceM(HANDLE hProServer,LPCTSTR bsNodeName,LPCTSTR
bsDeviceName,LPVOID pData,WORD wCount,WORD wAppKind);
```

General-use data (for VB)

```
INT WINAPI ReadDeviceVariantM(HANDLE hProServer,LPCTSTR bsNodeName,LPCTSTR
bsDeviceName,LPVARIANT pData,WORD wCount,WORD wAppKind);
```

<Return value>

Normal termination: 0

Abnormal termination: Error code

<Arguments>

bsNodeName.....Pointer to the node name (char.string)

Specify directly the network node name registered with Pro-Studio or the IP address.

Ex.1) To specify the node name: "GP2

Ex.2) To specify directly the IP address: "92.9.201.1"

bsDeviceName....Pointer to the symbol (char. string) to perform Read/Write

Specify directly the symbol name or the device address.

Ex.1) To specify the symbol: "SWITCH1"

Ex.2) To specify directly the device: "M100"

Function	Symbol Data Type							
	Bit	16Bit		32Bit		Float	Double	String
		S/U/HEX	BCD	S/U/HEX	BCD			
XXXDeviceBit	O	-	-	-	-	-	-	-
XXXDevice16	-	O	-	-	-	-	-	-
XXXDevice32	-	-	-	O	-	-	-	-
XXXDeviceBCD16	-	-	O	-	-	-	-	-
XXXDeviceBCD32	-	-	-	-	O	-	-	-
XXXDeviceFloat	-	-	-	-	-	O	-	-
XXXDeviceDouble	-	-	-	-	-	-	O	-
XXXDeviceStr	-	-	-	-	-	-	-	O
XXXDevice	O	O	O	O	O	O	O	O

pxxData.....Pointer to the Read/Write Data

wCount.....Read/Write data quantity (1 to 255)

With the Read/WriteDeviceStr function, the quantity of string data is counted as the number of bytes. Always specify the data quantity as a multiple of 2 for devices with 16-bit data, and a multiple of 4 for devices with 32-bit data.

wAppKindData type specification

Value	Data Type	Value	Data Type
1	Bit	7	Unsigned 32 Bit
2	Signed 16 Bit	8	HEX 32 Bit
3	Unsigned 16 Bit	9	BCD 32 Bit
4	HEX 16 Bit	10	Float
5	BCD 16 Bit	11	Double
6	Signed 32 Bit	12	String

The Read/WriteDevice function allows the data type to be changed dynamically because it is specified as a parameter.

9.1.4 Additional Functions

Multi-Thread Handle Acquisition

```
HANDLE WINAPI CreateProServerHandle ();
```

<Return value>

Normal termination: Other than 0 (handle code)

Illegal termination: 0

Multi-Thread Handle Release

```
INT WINAPI DeleteProServerHandle (HANDLE hProServer);
```

<Return value>

Normal termination: 0

Illegal termination: Error code

Loading the Network Project File

Single

```
INT WINAPI EasyLoadNetworkProject(LPCTSTR sDBName,DWORD dwSetOrAdd = TRUE);
```

Multi

```
INT WINAPI EasyLoadNetworkProjectM(HANDLE hProServer,LPCTSTR sDBName,DWORD
dwSetOrAdd = TRUE);
```

<Function>

Pro-Server is started under the network project designated by the argument.

<Return value>

Normal termination: 0

Illegal termination: Error code

<Arguments>

sDBName.....Pointer to the path name and file name (string) of the network project file

dwSetOrAdd.....Reserved (Fixed to 1)

Conversion of Error Codes to Strings

```
BOOL WINAPI EasyLoadErrorMessage(INT iErrorCode, LPTSTR osErrorMessage);
```

<Return value>

Other than 0: Normal termination

0: Failed in string conversion(Unused error codes, etc.)

<Arguments>

iErrorCode.....Simple DLL error code

osErrorMessage..Pointer to the storage area for the converted string

(Secure storage area of 512 bytes or more)

Reference → "A.2.1 Pro-Server with Pro-Studio for Windows Error Messages"

Reading SRAM Backup Data

Single

```
INT WINAPI EasyBackupDataRead(LPCTSTR sSaveFileName,LPCTSTR sNodeName,
INT BackupDataType,INT SaveMode);
```

Multi

```
INT WINAPI EasyBackupDataReadM(HANDLE hProServer,LPCTSTR sSaveFileName,
LPCTSTR sNodeName,INT BackupDataType,INT SaveMode);
```

<Return value>

Normal termination: 0
 Illegal termination: Error code

<Arguments>

sSaveFileName.....Pointer to the path name and file name(string)of the estination storage file
 sNodeName.....Pointer to the node name(string)
 BackupDataType.....Types of Readout Data

No.	Type
0	Reserved
1	Filing Data
2	Logging data
3	Line data
4	Sampling data
5	Alarm block 1
6	Alarm history data, Alarm block 2
7	Alarm log data, Alarm block 3
8 or above	Reserved

SaveMode.....Saving Method

No.	Mode	Note
0	Stores data as a new file.	If the file exists, deletes the existing contents and overwrites data.
1	Appends data to an existing file.	If the file does not exist, creates a new file.

Backup Data's Write Function

Single

```
INT WINAPI EasyBackupDataWrite(LPCTSTR sSourceFileName,LPCTSTR sNodeName,
INT BackupDataType);
```

Multi

```
INT WINAPI EasyBackupDataWriteM(HANDLE hProServer,LPCTSTR sSourceFileName,
LPCTSTR sNodeName,INT BackupDataType);
```

<Function>

Writes the designated Binary file to the GP's internal SRAM.

<Argument>

HProServer..... Pro-Server handle

sSourceFileName...File path for the value to be written to the GP's SRAM

sNodeName..... Node name of GP to be written to.(Node must be previously registered as a Pro-Server Network Project.)

BackupDataType....Designates the type of write file.(Must be the EasyBackupDataType_FILING type[filig data]supported by Ver. 2.0)

<Return value>

Normal Completion: 0

Write Error: Error Code

Entry Node Status Read Function

Single

```
INT WINAPI GetNodeProperty (LPCTSTR sNodeName, DWORD dwTimeLimit, LPCTSTR GPType,
LPCTSTR SystemVersion, LPCTSTR ComVersion, LPCTSTR ECOMVersion)
```

Multi

```
INT WINAPI GetNodePropertyM (HANDLE hProServer, LPCTSTR sNodeName, DWORD dwTimeLimit,
LPCTSTR GPType, LPCTSTR SystemVersion, LPCTSTR ComVersion, LPCTSTR ECOMVersion)
```

<Function>

The connected GP status can be acquired. This can also be used to check a connection since the response timeout value can be a variable.

<Argument>

hProServer Pro-Server handle

sNodeName Node name of GP to be read from. (Node name must be previously registered as a Pro-Server network project.)

dwTimeLimit Response timeout setup value (If you designate 0, this will be defaulted to 3000 msec.)
The setup range is from 1 through 2,147,483,647. (unit:msec)

Secure the area more than 32 bytes for each of followings.

GpType: GP model code

SystemVersion: GP system version

ComVersion: PLC protocol driver version

ECOMVersion: 2-Way Driver version

<Return value>

Normal Completion: 0

Error: Error codes (refer to the separate table)

GpType: Character string data of the GP device code

SystemVersion: Character string data of the GP system version

ComVersion: Character string data of the PLC protocol driver version

ECOMVersion: Character string data of the 2-Way Driver version

CF Card Status Read Function**Single**

INT WINAPI EasyIsCFCard (LPCTSTR sNodeName)

Multi

INT WINAPI EasyIsCFCardM (HANDLE hProServer, LPCTSTR sNodeName)

<Function>

The CF Card connection status of the connect GP can be acquired.

<Argument>

hProServer Pro-Server handle

sNodeName Node name of GP to be read from. (Node name must be previously registered as a Pro-Server network project.)

<Return value>

0: CF Card is not inserted.

1: CF Card is inserted.

2: reserved

3: CF Card is write-protected.

other Error codes (refer to the separate table)

Simple DLL Initialization

```
INT WINAPI EasyInit();
```

<Return value>

Normal termination: 0

Illegal termination: Error code(Refer to the attached table.)

When using multi-thread type applications, always call the simple DLL from the thread in which it is used.

Reference → “9.1.1 Precautions When Using Functions”

Simple DLL Termination

```
INT WINAPI EasyTerm();
```

<Return value>

Normal termination: 0

Illegal termination: Error code(Refer to the attached table.)

For multi-thread type applications, call ProEasy.DLL from the thread where it is used.

Reference → “9.1.1 Precautions When Using Functions”

9.2 Examples of Simple DLL Function

Using read/write functions provided by Pro-Server allows you to read/write data from VB or VC applications.

This section describes the procedure to read/write designated symbols using the programming help feature.

Procedures are different between VP and VC applications. They're described separately.

9.2.1 VG Feature Help

VBA: Declaration

1. Click [VBA: Declare Function] on [Programming Support].

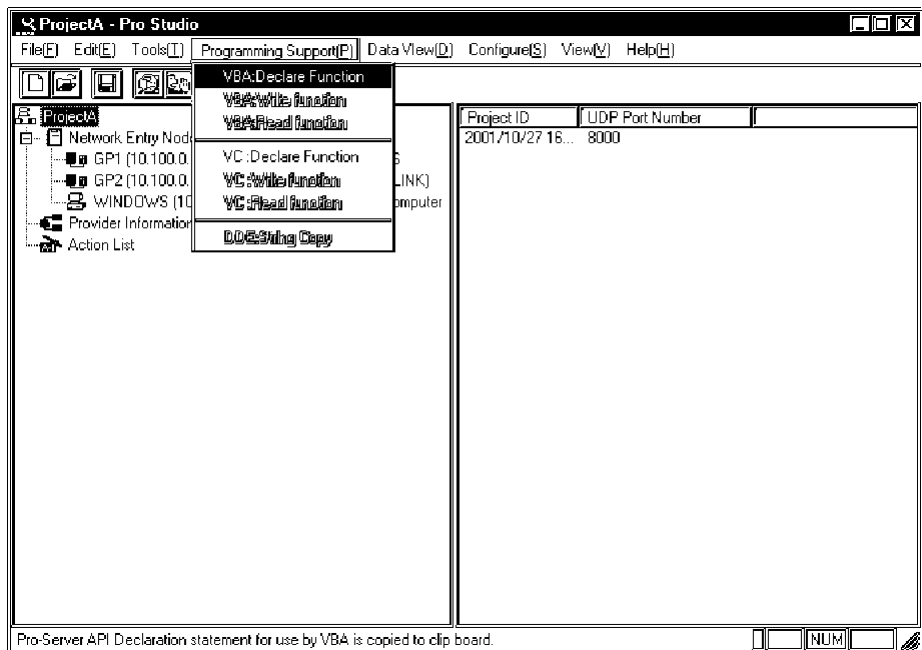

2. The declaration is copied to the Clipboard.

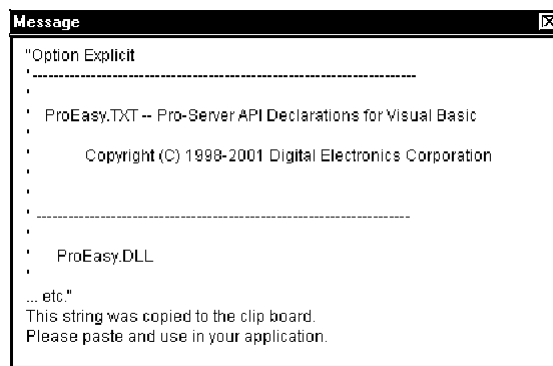

3. Start-up Microsoft Visual Basic, and then click [New Project] on [File] from the menu.

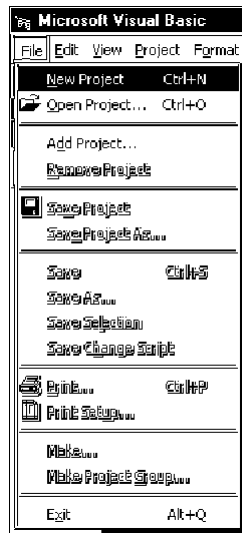

4. Select [Standard EXE], and then click [OK].

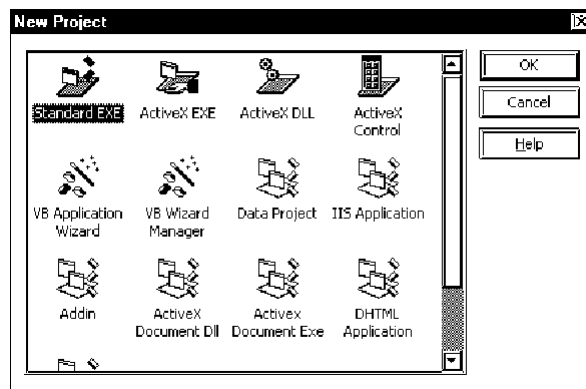

5. Click [Add Module] on [Project] of the Microsoft Visual Basic menu.

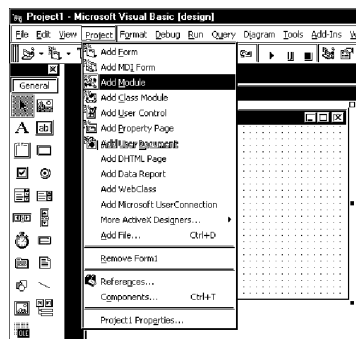

6. Select [Standard Module] on the [New] tab, and then click [Open].

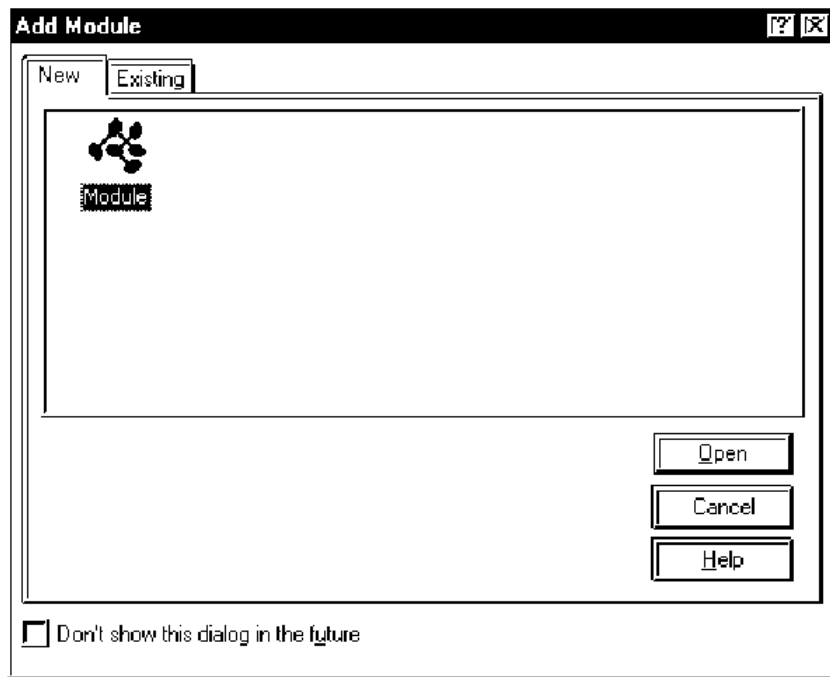

7. Click [Paste] on [Edit] of the Microsoft Visual Basic menu to paste the declaration (the contents in the Clipboard) to the added standard module.

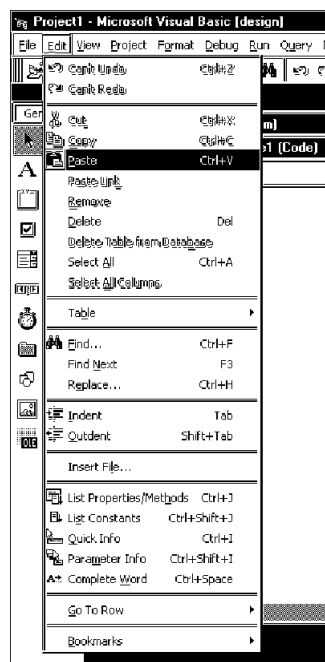

8. The declaration will be pasted.

This completes function (read/write functions) declaration.

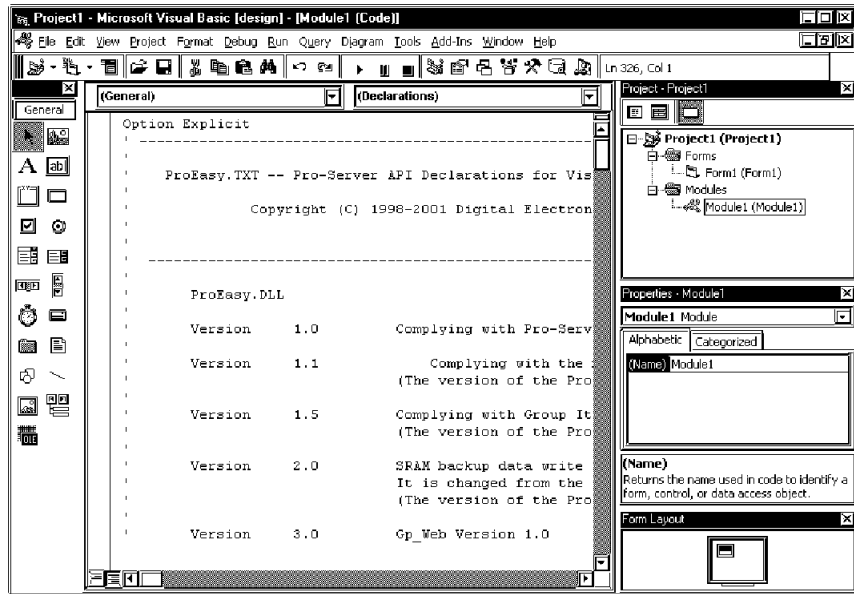

Operations from Step 1 through 8 mentioned above are common to both read and write.

For the subsequent part, each procedure is described separately because procedures are different between read and write.

Refer to Step 9 through 21 to create the [Read] application.

Refer to Step 22 through 33 to create the [Write] application.

Creating [Read] Application

- This section describes the application to read and display three data (16 bits signed) when clicking [Command1].

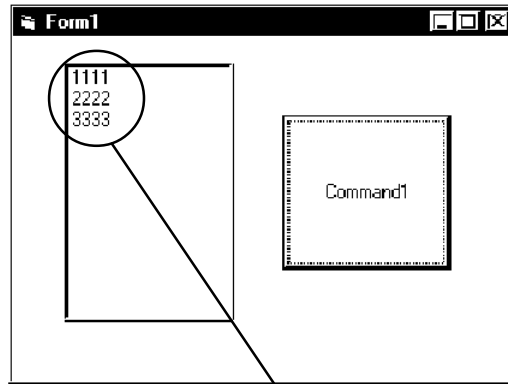

Displays three read data.

- Click [Toolbox] on [View] of the Microsoft Visual Basic menu.

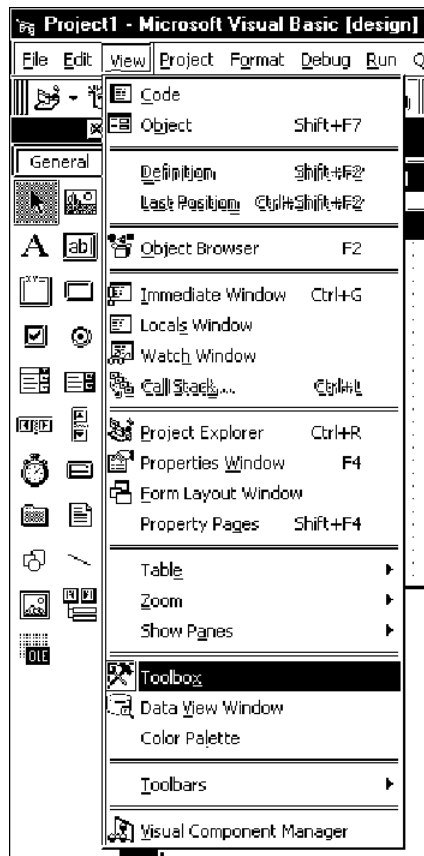

11. Select [ListBox], and then paste to [Form1].

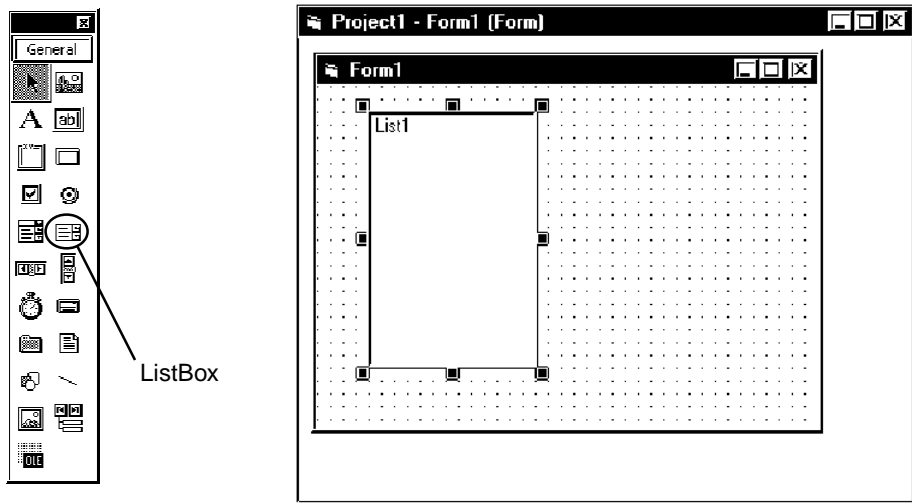

12. Select [CommandButton], and then paste to [Form1].

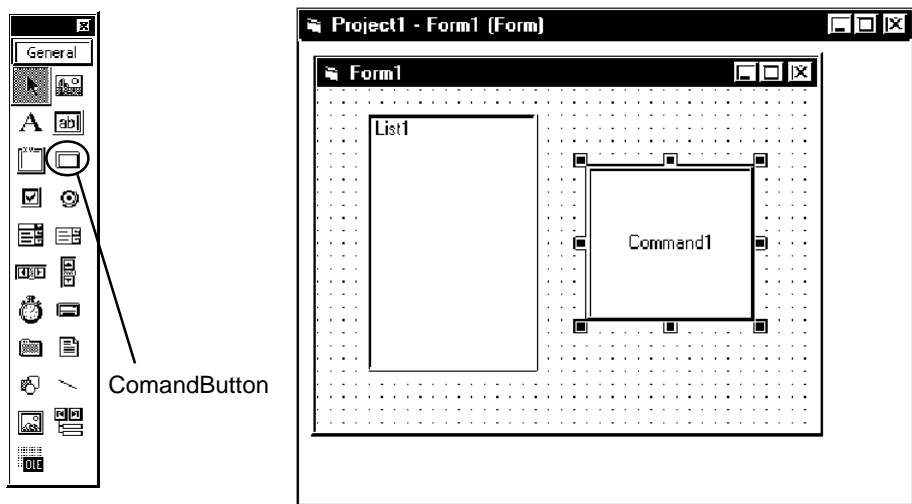

13. Select the symbol name that you wish to read among symbols registered on Pro-Studio
(Select the heading symbol to read from.).

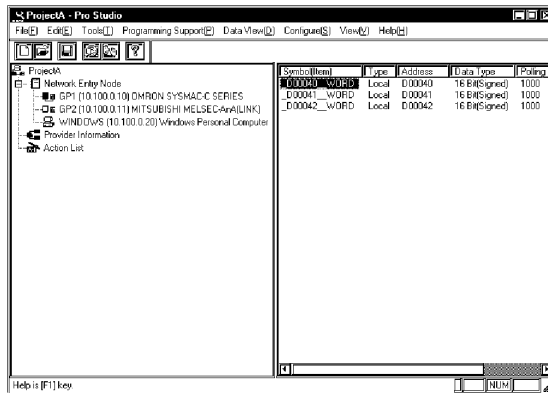

14. Click [VBA: Read function] on [Programming Support] of the menu.

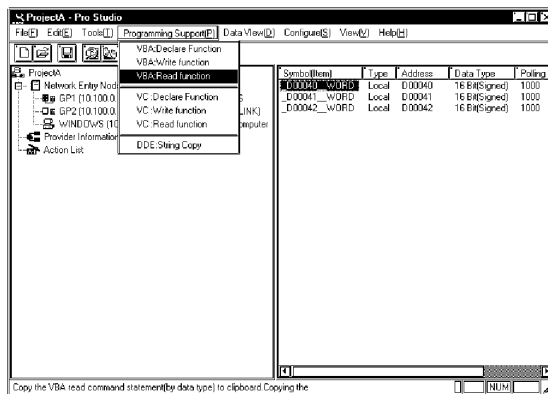

15. The read function will be copied into the Clipboard.

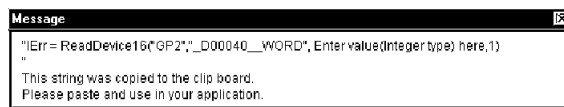

16. Double click [Command1] on [Form1] to paste the contents (read function) in the Clipboard between the Sub and the EndSub statements.

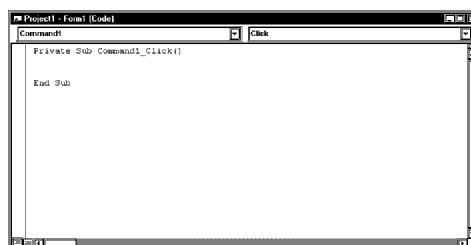

17. Declare the area to store read data. You should designate three or more area elements if the number of read data is three (The number of area elements is from 0 to 2 in this example). However, the area type (Integer in this example) needs to be matched to the symbol data type to use.



```

Private Sub Command1_Click()
    Dim wData(2) As Integer

    End Sub
  
```

18. Designate the header area to store read data (wData(0)), and also designate 3 as the number of read data.



```

Private Sub Command1_Click()
    Dim wData(2) As Integer

    !Dir = ReadDevice16("GP2", "D00040_00RD", wData(0), 3)

    End Sub
  
```

19. Set three data read (wData(0), wData(1), wData(2)) in the ListBox one after another.

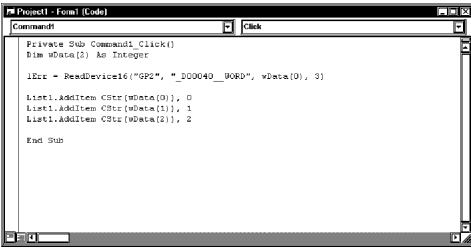

```

Private Sub Command1_Click()
    Dim wData(2) As Integer

    !Dir = ReadDevice16("GP2", "D00040_00RD", wData(0), 3)

    List1.AddItem CStr(wData(0)), 0
    List1.AddItem CStr(wData(1)), 1
    List1.AddItem CStr(wData(2)), 2

    End Sub
  
```

20. Click [Start] on [Run] of the Microsoft Visual Basic menu.



21. Click [Command1] to display three data form the symbol “_D40_WORD” in the ListBox.

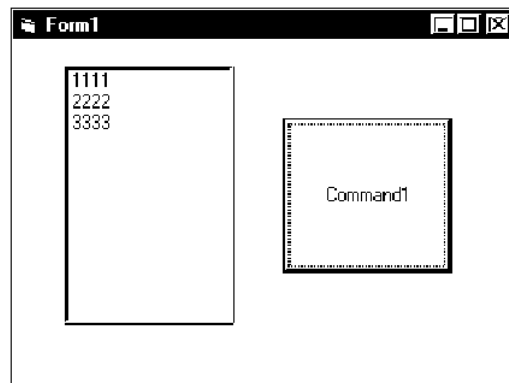

Creating [Write] Application

22. This section describes the application to write three data (16 bits signed) read when clicking [Command1].

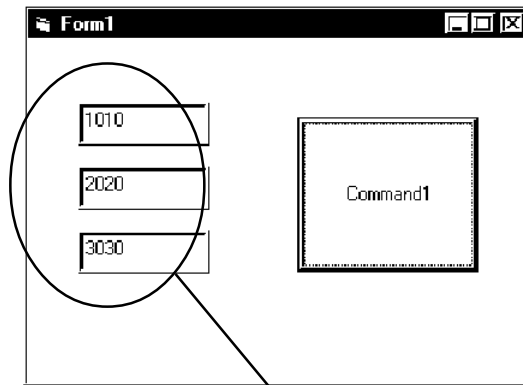

Writes three data.

23. Select [TextBox], and then paste in [Form1]. Paste three [TextBox]s.

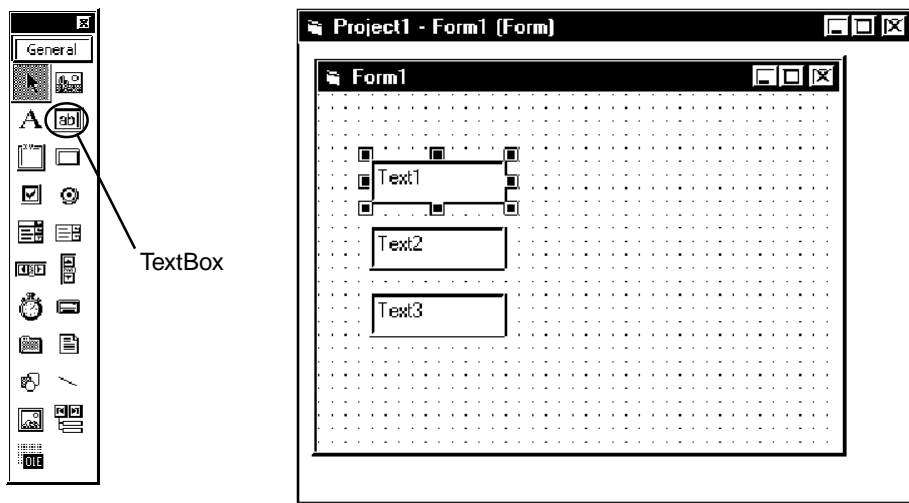

24. Select [CommandButton], and then paste to [Form1].

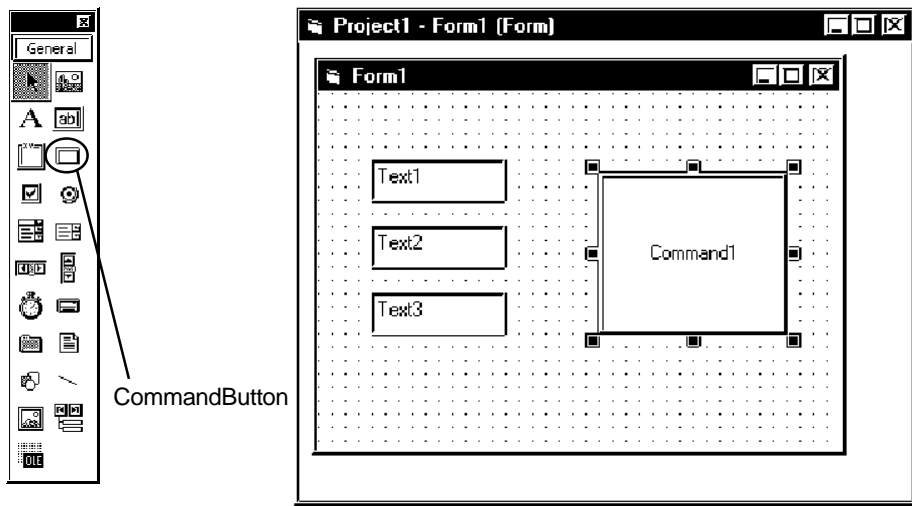

25. Select the symbol name that you wish to write to among symbols registered on Pro-Studio
(Select the heading symbol to write to).

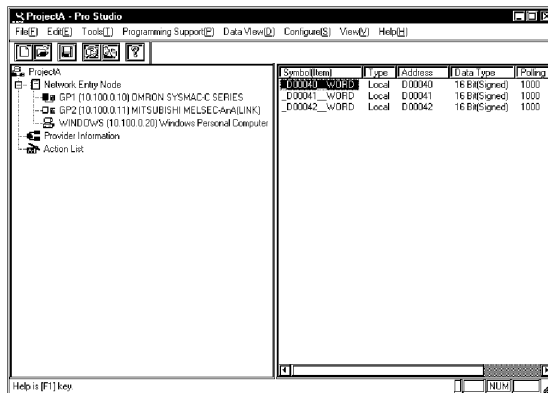

26. Click [VBA: Write function] on [Programming Support] of the menu.

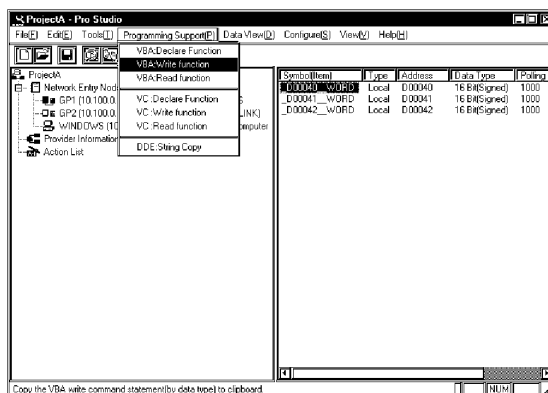

27. The write function will be copied into the Clipboard.

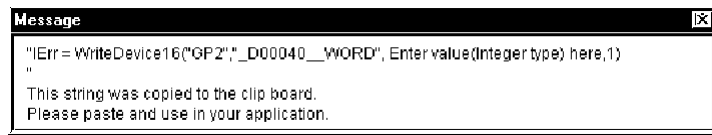

28. Double click [Command1] on [Form1] to paste the contents (write function) in the Clipboard between the Sub and the EndSub statements.

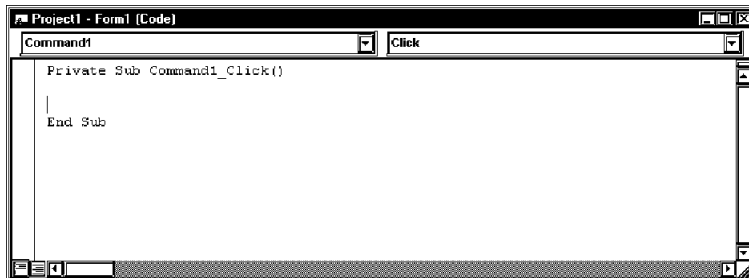

29. Declare the area to store data to write. You should designate three or more area elements if the number of write data is three (The number of area elements is from 0 to 2 in this example). However, the area type (Integer in this example) needs to be matched to the symbol data type to use.

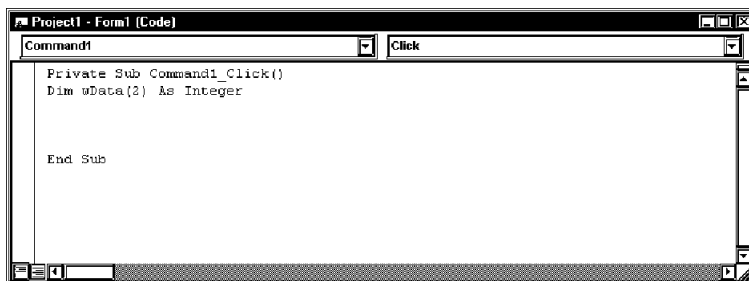

30. Set entered data in [TextBox] to the area.

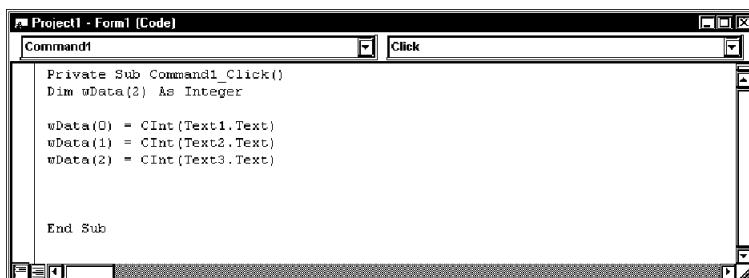

31. Designate the header area (wData (0)) where written data have been set. Also designate three as the number of write data.

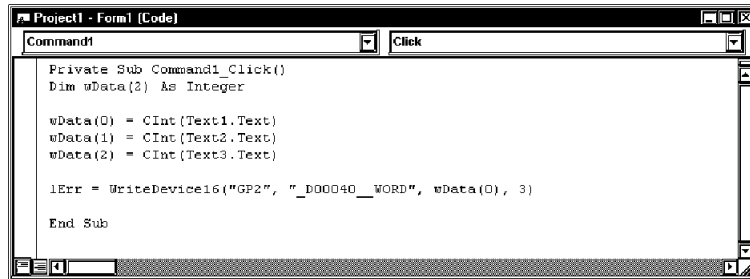

```

Private Sub Command1_Click()
    Dim wData(2) As Integer

    wData(0) = CInt(Text1.Text)
    wData(1) = CInt(Text2.Text)
    wData(2) = CInt(Text3.Text)

    !Err = WriteDevice16("GP2", "_D00040_WORD", wData(0), 3)

End Sub

```

32. Click [Start] on [Run] of the Microsoft Visual Basic menu.

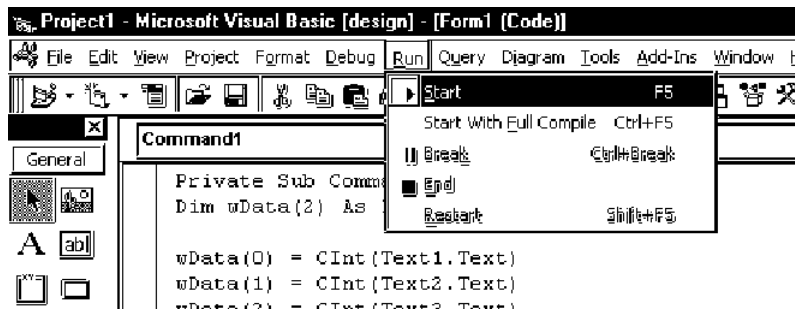

33. After entering three data to write in [TextBox], click [Command1] to write three data form the symbol, "_D40_WORD".

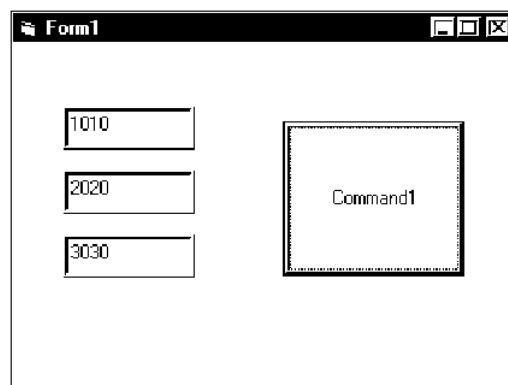

9.2.2 VC Function Help

This section describes how to create the dialog-based application example using MFC (Microsoft Foundation Class).

VC: Declaration

1. Start Microsoft Visual C++, and then click [New] on [File].

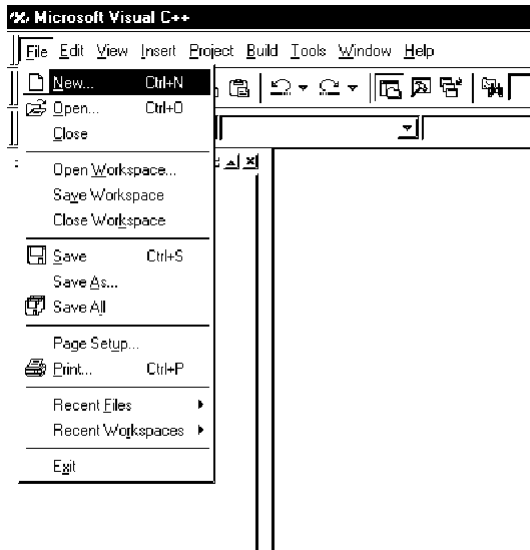

2. Select [MFCAppWizard (exe)] in the [Projects] tab, enter [Project name] and [Location], and then click [OK].

This example uses “Sample” for [Project name] and “C:\Program Files\Pro-Server with Studio\Pro-SDK\VC” for [Location].

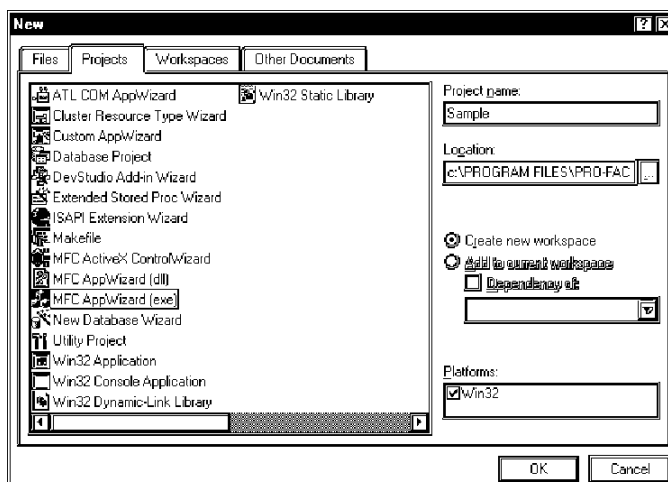

3. Select [Dialog based] in the “What type of application would you like to create?” field, and then click [Finish].

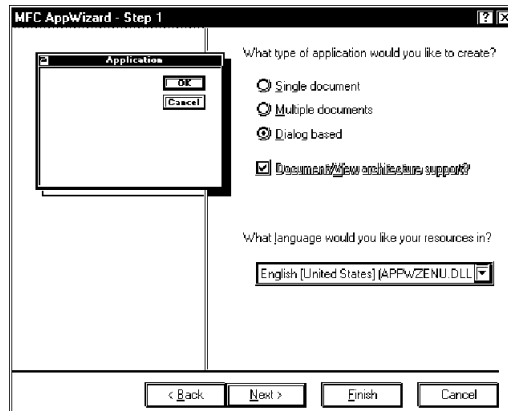

4. Click [OK] to complete the project.

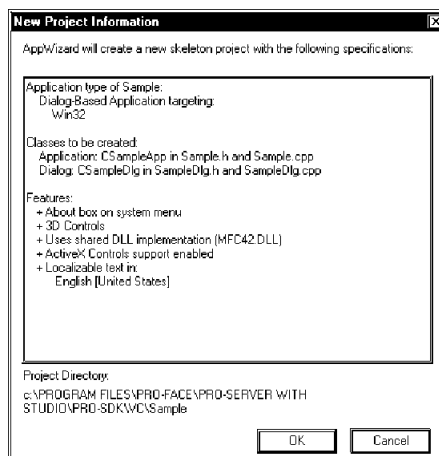

5. Pro-Server provides read/write functions as DLLs. You should designate the LIB file to use those DLLs.

Click [Setting] on [Project] of the Microsoft Visual C++ menu.

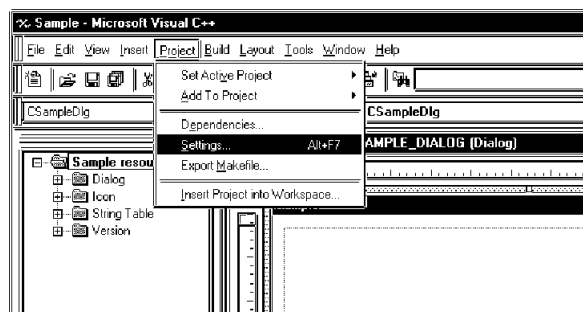

- Designate the LIB file using [Object/library modules] in the [Link] tab, and then click [OK].
 “Pro-SDK\Public\ProEasy.lib” is designated in this example because the LIB file (ProEasy.lib) exists in “Pro-SDK\Public” under the folder where Pro-Server has been installed.

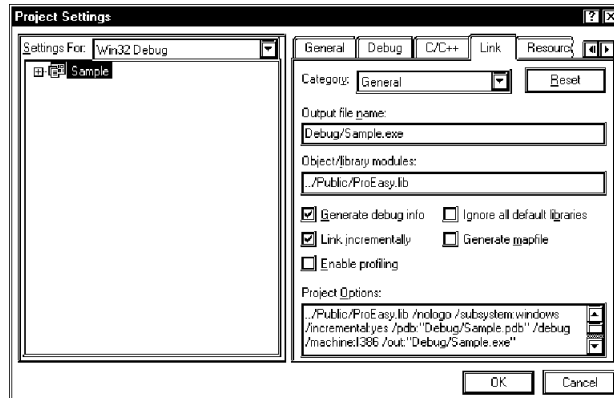

- You should install the header file (ProEasy.h) to use read/write functions provided by Pro-Server. Click the [FileView] tab in the Microsoft Visual C++ [Workspace] window, and then double click the SampleDig.cpp file.

In this example, read/write functions are used in the SampleDig.cpp file.

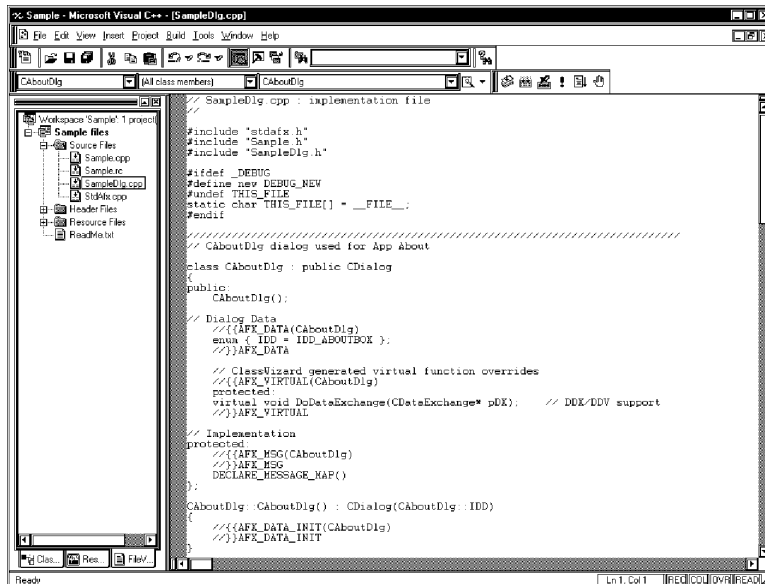

8. Add #include "Pro-SDK\Public\ProEasy.h" in the SampleDlg.cpp file to complete the read/write function declaration.

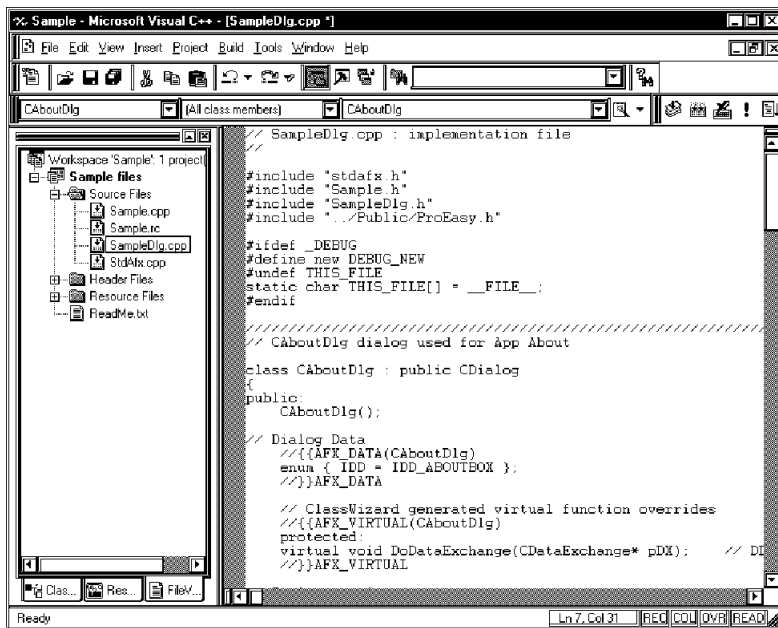

Operations from step 1 through 8 mentioned above are common to both read and write.

For the subsequent part, each procedure is described separately because procedures are different between read and write.

Refer to step 9 through 32 to create the [Read] application.

Refer to step 33 through 51 to create the [Write] application.

Creating [Read] Application

- This section describes the application to read and display three data (16 bits signed) when clicking [Button1].

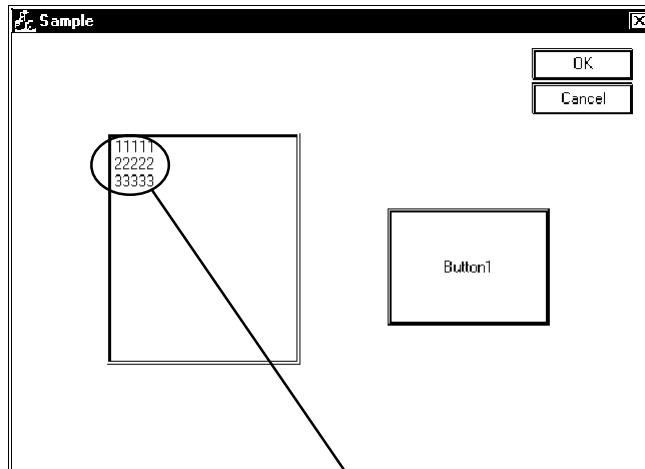

Displays three read data.

- Click the [ResourceView] tab in the Microsoft Visual C++ [Workspace] window, and then double click [IDD_SAMPLE_DIALOG].
Select and delete [Static Text] in the center of the dialog.

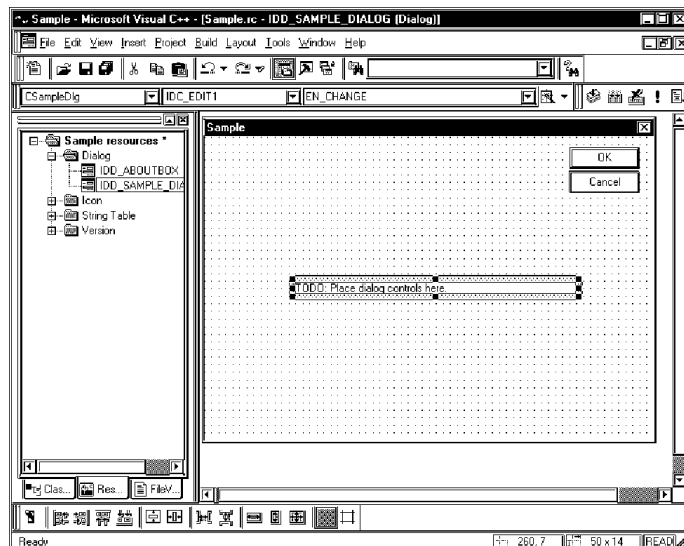

11. Click [Customize] on [Tools] of the Microsoft Visual C++ menu.

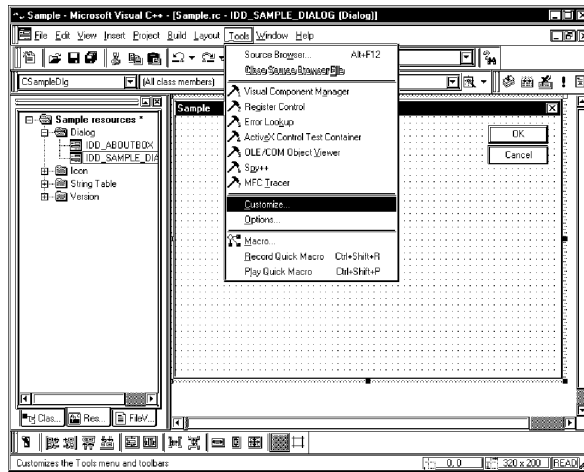

12. Check [Controls] in the [Toolbars] tab, and then click [Close].

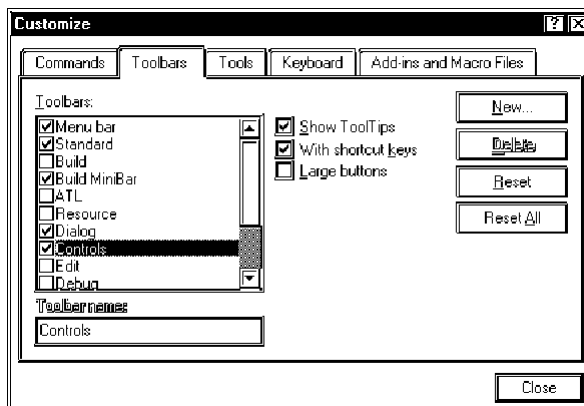

13. Select [ListBox], and then paste it in the dialog.

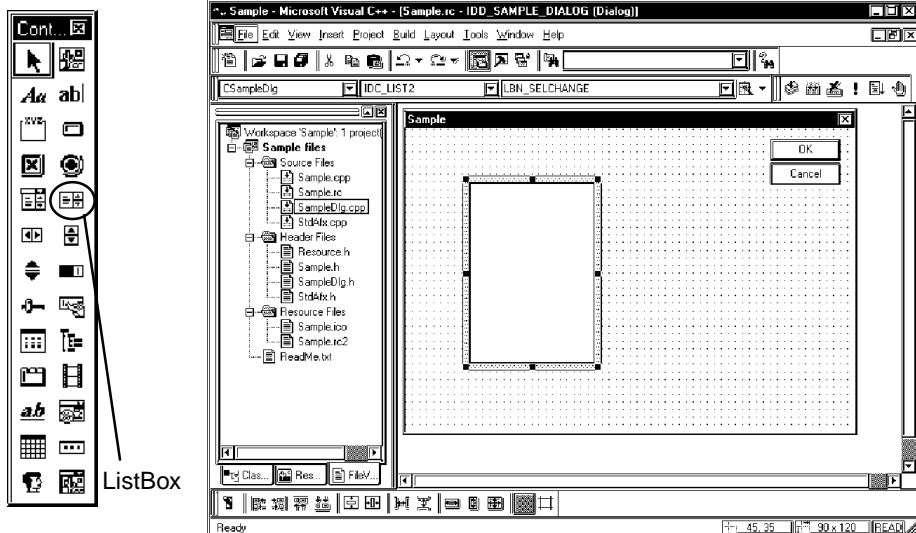

- Right-click the pasted [ListBox], and then select [Property]. After the [ListBox Properties] window appears, uncheck [Sort].

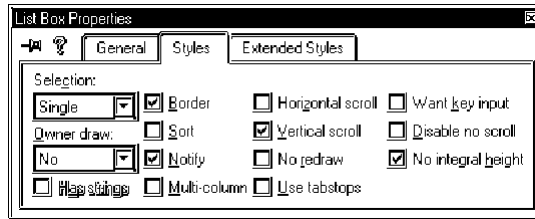

- Click [ClassWizard] on [View] of the Microsoft Visual C++ menu.

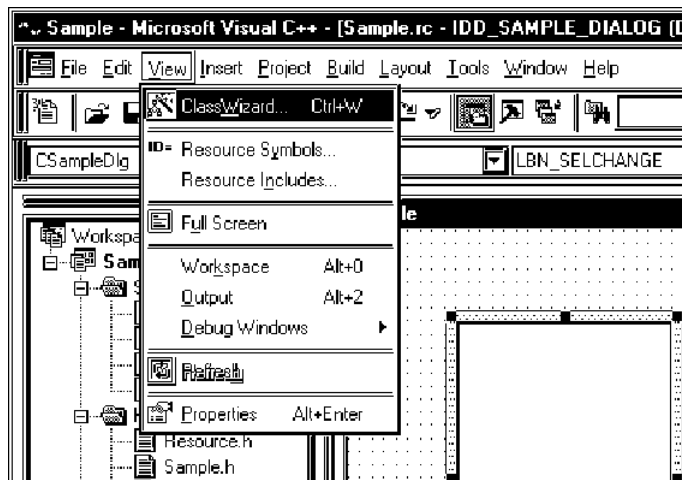

- Select the [Member Variables] tab, and then select "IDC_LIST1" in [Control ID].

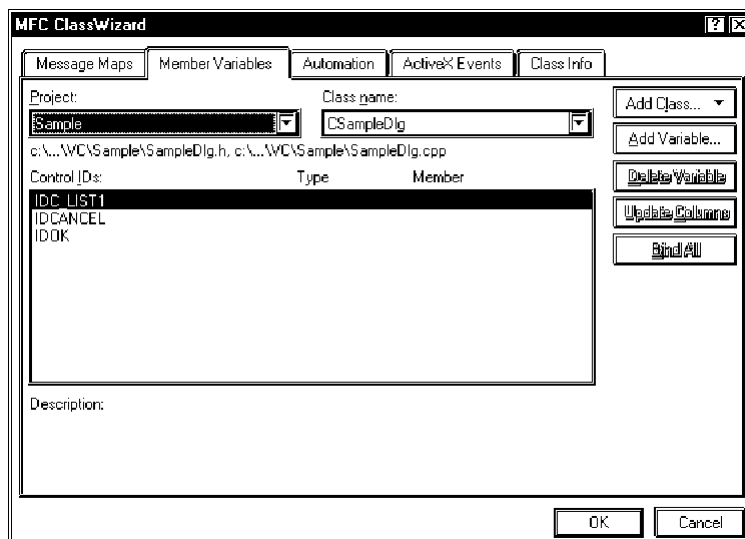

17. Click [Add Variable...], and then enter “m_List” in [Member Variable name]. Select “Control” in [Category], and then click [OK].

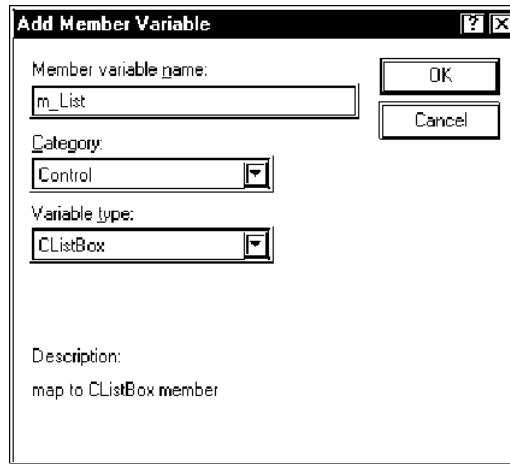

18. Make sure if the member variable has been added, and then click [OK].

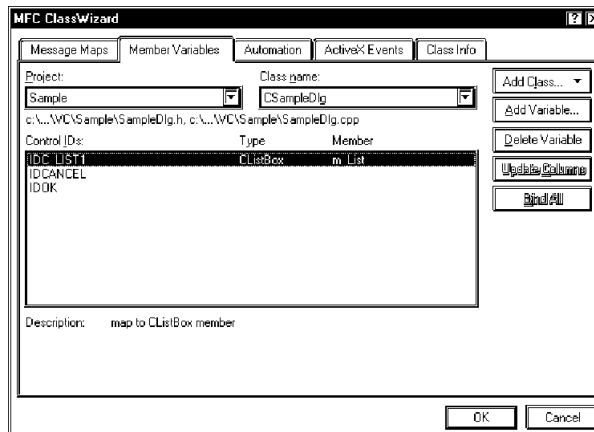

19. Select [Button], and then paste it in the dialog.

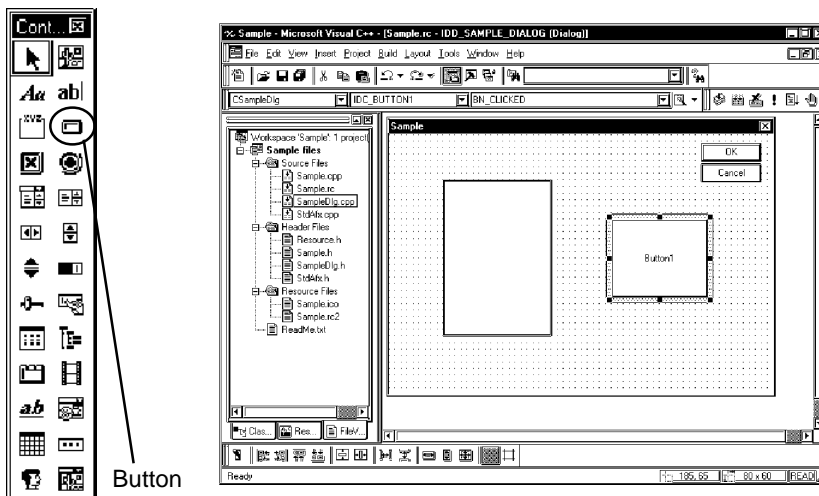

20. Select the symbol name that you wish to read among symbols registered on Pro-Server
(Select the heading symbol to read from.).

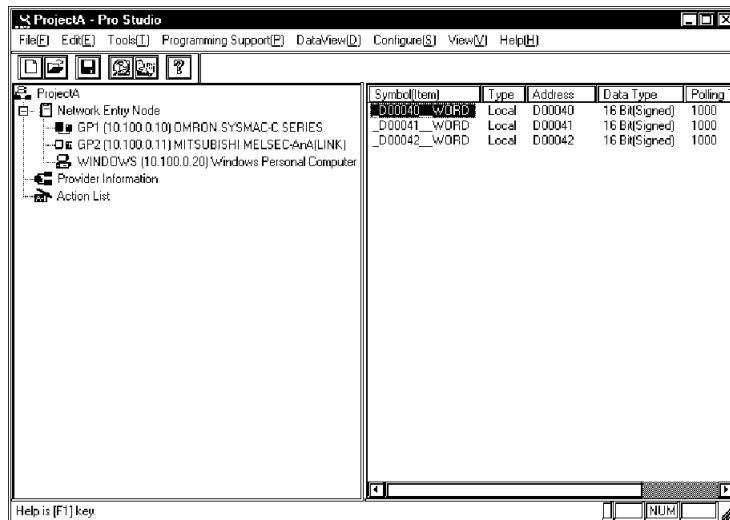

21. Click [VC: Read Function] on [Programming Support] of the menu.

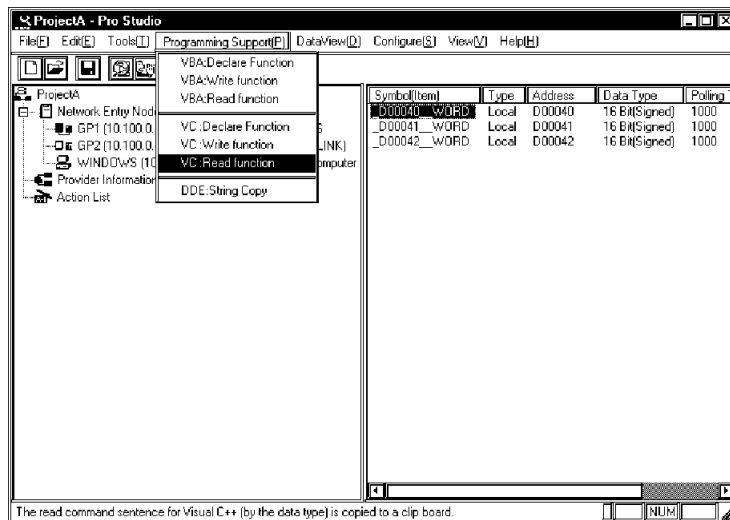

22. The read function will be copied into the Clipboard.

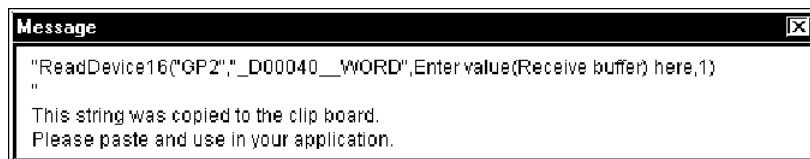

23. Double click [Button1] pasted to [Dialog] of the Microsoft Visual C++ menu.

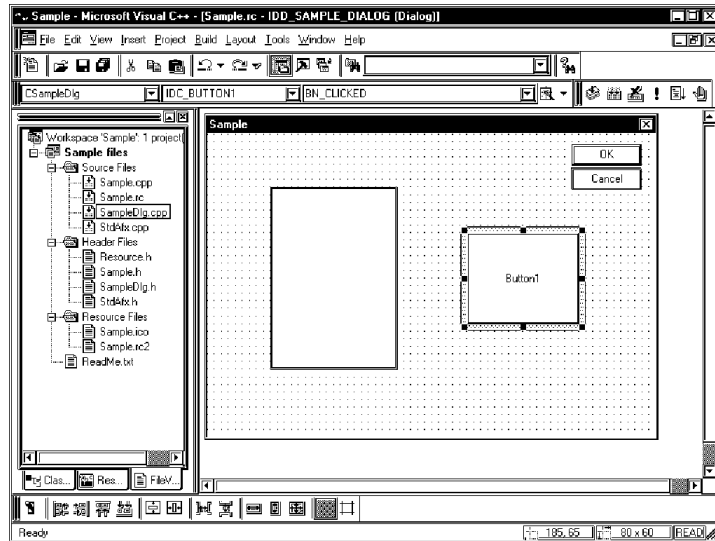

24. Click [OK].

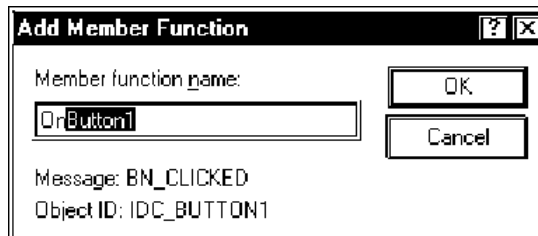

25. Paste the contents of the Clipboard (read function) into the OnButton1 member function.

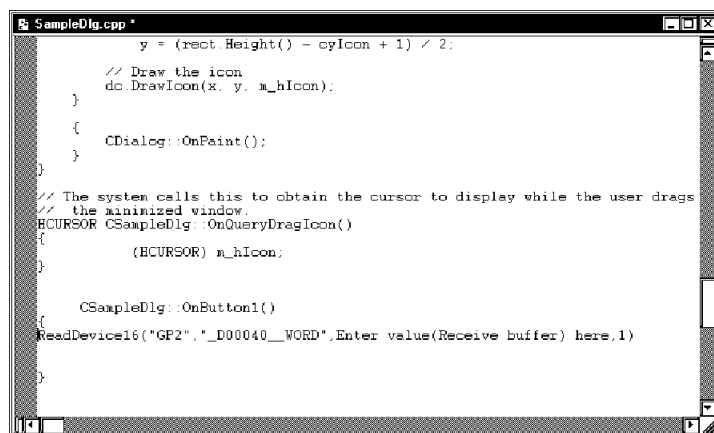

26. Declare the area to store read data. You should designate three or more area elements if the number of read data is three.

```

SampleDlg.cpp
y = (rect.Height() - cyIcon + 1) / 2;
// Draw the icon
dc.DrawIcon(x, y, m_hIcon);
}
{
  CDialog::OnPaint();
}
}
// The system calls this to obtain the cursor to display while the user drags
// the minimized window.
HCURSOR CSampleDlg::OnQueryDragIcon()
{
  (HCURSOR) m_hIcon;
}
}
CSampleDlg::OnButton1()
{
  WORD wData[3];
  ReadDevice16("GP2", "_D00040__WORD", Enter value(Receive buffer) here, 1)
}
}

```

27. Designate the header area to store read data (wData(0)), and 3 as the number of read data. You should also add a semicolon (;) at the end of the read function.

```

SampleDlg.cpp
y = (rect.Height() - cyIcon + 1) / 2;
// Draw the icon
dc.DrawIcon(x, y, m_hIcon);
}
{
  CDialog::OnPaint();
}
}
// The system calls this to obtain the cursor to display while the user drags
// the minimized window.
HCURSOR CSampleDlg::OnQueryDragIcon()
{
  (HCURSOR) m_hIcon;
}
}
CSampleDlg::OnButton1()
{
  WORD wData[3];
  ReadDevice16("GP2", "_D00040__WORD", wData, 3);
}
}

```

28. Convert read data to CString type characters once to display three read data (wData(0), wData(1), wData(2)) in the ListBox.

```

SampleDlg.cpp
{
  CDialog::OnPaint();
}
}
// The system calls this to obtain the cursor to display while the user drags
// the minimized window.
HCURSOR CSampleDlg::OnQueryDragIcon()
{
  (HCURSOR) m_hIcon;
}
}
CSampleDlg::OnButton1()
{
  WORD wData[3];
  ReadDevice16("GP2", "_D00040__WORD", wData, 3);
  CString str[3];
  str[0].Format("%d", wData[0]);
  str[1].Format("%d", wData[1]);
  str[2].Format("%d", wData[2]);
}
}

```

29. Set three data read (wData(0), wData(1), wData(2)) in the ListBox one after another.

```

}
}
// The system calls this to obtain the cursor to display while the user drags
// the minimized window
HCURSOR CSampleDlg::OnQueryDragIcon()
{
    (HCURSOR) m_hIcon;
}

CSampleDlg::OnButton1()
{
    WORD wData[3];
    ReadDevice16("GP2", "_D00040__WORD", wData, 3);

    CString str[3];
    str[0].Format("%d", wData[0]);
    str[1].Format("%d", wData[1]);
    str[2].Format("%d", wData[2]);

    mList.InsertString(0, str[0]);
    mList.InsertString(0, str[1]);
    mList.InsertString(0, str[2]);
}
}

```

30. Click [Execute Sample.exe] on [Build] of the Microsoft Visual C++ menu.

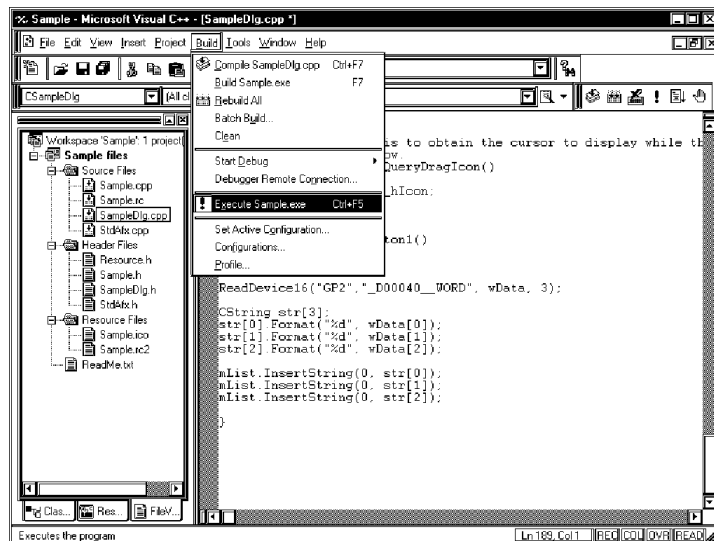

31. Click [Yes].

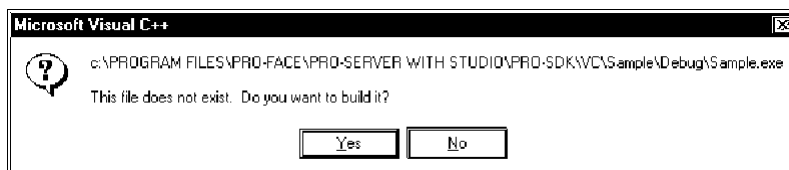

32. Click [Button1] to display three data from the symbol “_D40_WORD” in the ListBox.

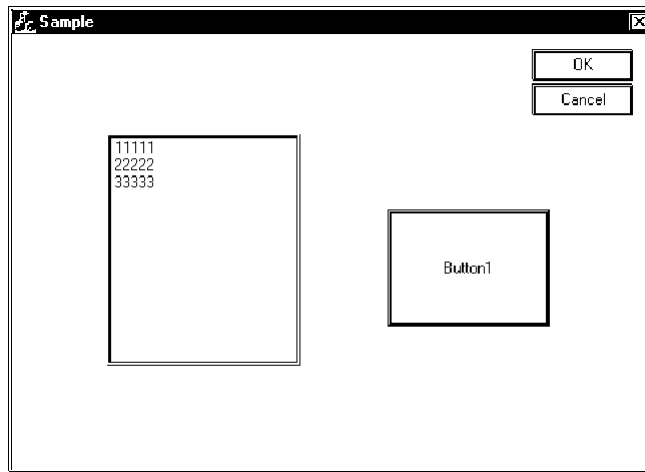

Creating Write Application

33. This section describes the application to write three read data when clicking [Button1].
Execute the same operations, step 10 through 12, as in “Creating Read Application”.

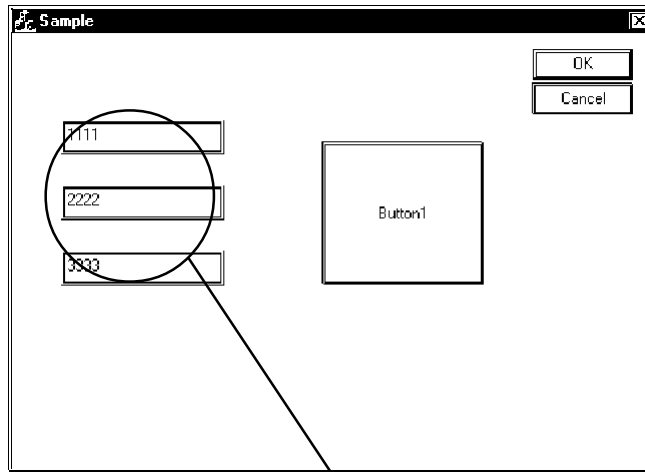

Write three read data.

34. Select [EditBox], and then paste it in [Dialog]. You should paste three [EditBox]s.

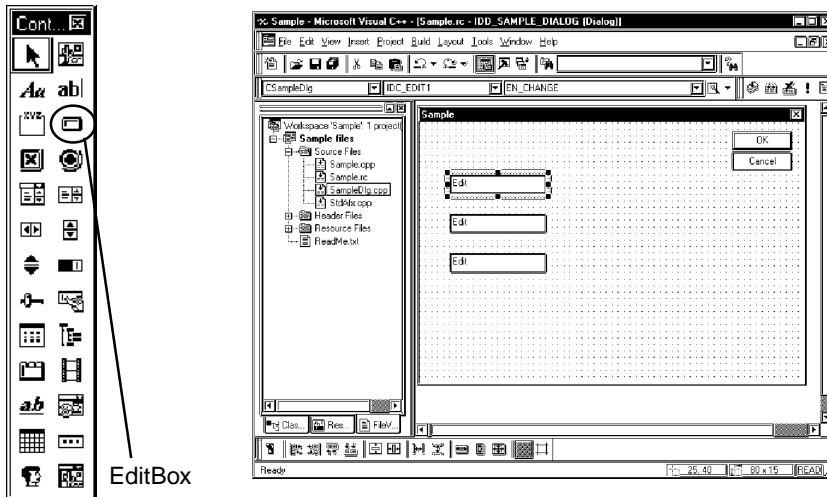

EditBox

35. Click [Class Wizard] on [View] of the Microsoft Visual C++ menu.

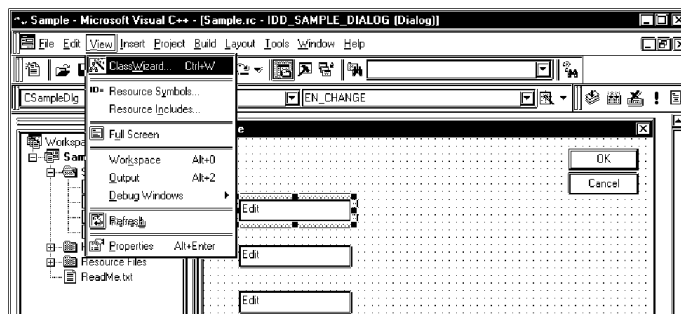

36. Select “IDC_EDIT1” in [Control IDs] of the [Member Variables] tab, and then click [Add Variable...].

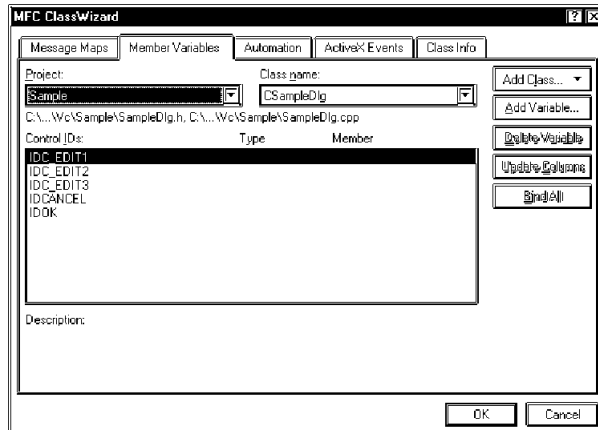

37. Enter “m_Edit1” in [Member variable name], select “short” in [Variable type], and then click [OK]. Repeat step 36 and 37 for other two [EditBox]s. However, you should designate their member variables as “m_Edit2” and “m_Edit3” respectively.

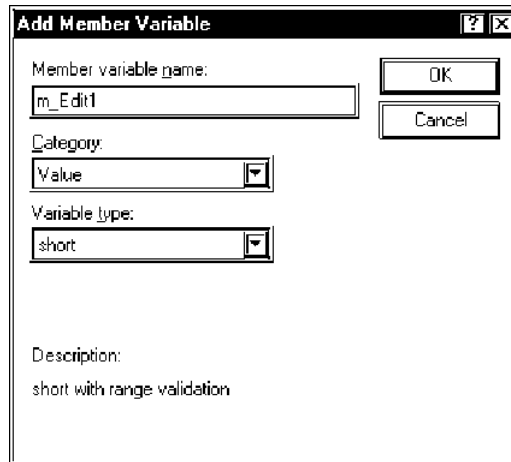

38. Click [OK].

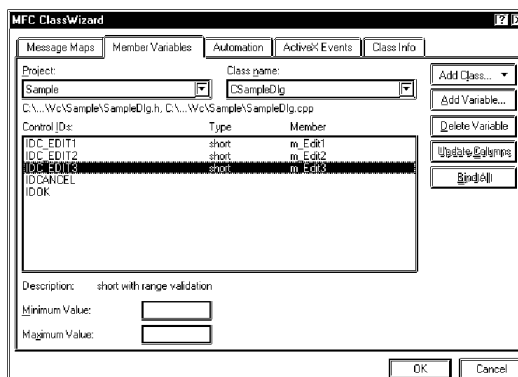

39. Select [Button] and paste it to [Dialog].

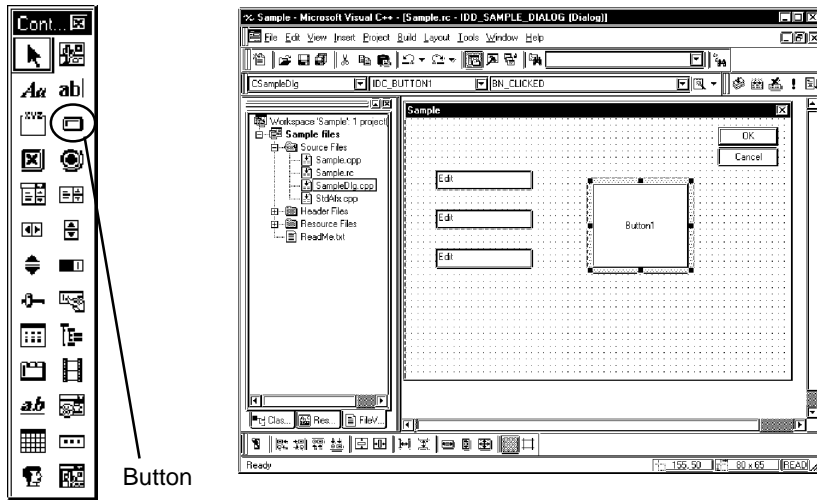

40. Select the symbol name to write to among symbols registered on Pro-Server (Select the heading symbol)

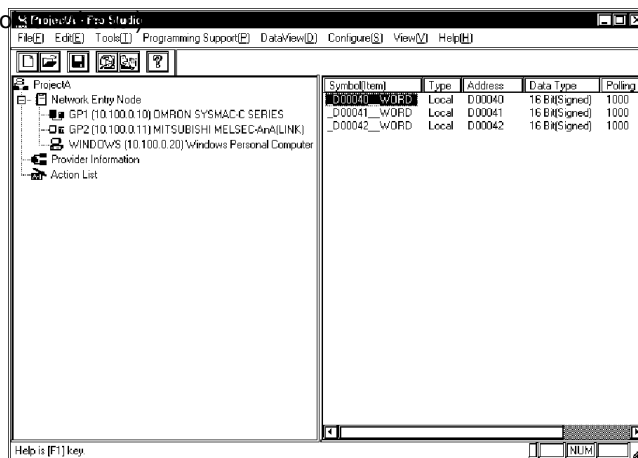

41. Click [VC: Write Function] on [Programming Support] of the menu.

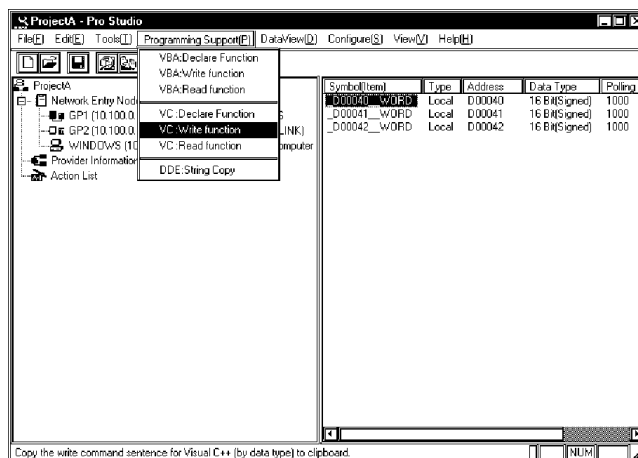

42. The write function will be copied into the Clipboard.

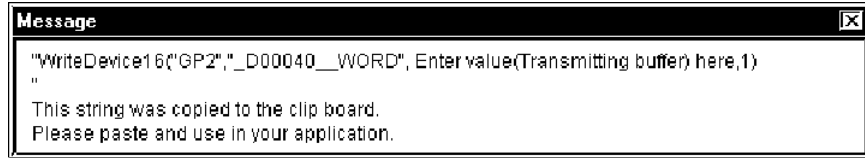

43. Double click [Button1] pasted on [Dialog] of the Microsoft Visual C++ menu.

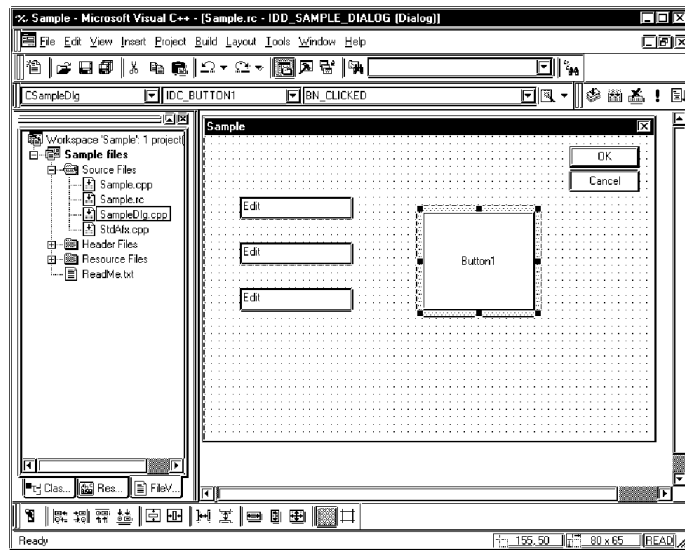

44. Click [OK].

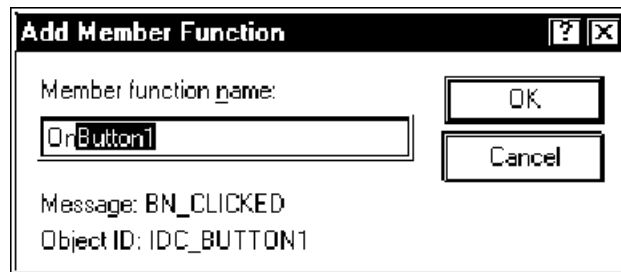

45. Paste the contents of the Clipboard (write function) into the OnButton1 member function.

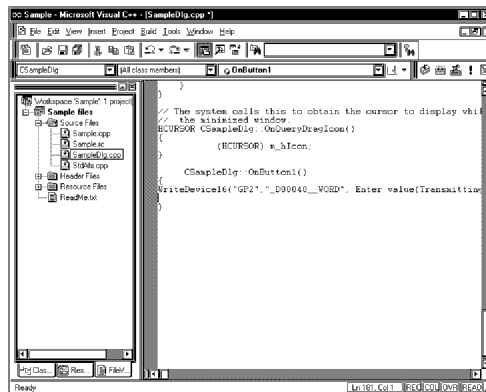

```

class CSampleDlg {
public:
    CSampleDlg(CWnd* pParent = NULL);
    ~CSampleDlg();

    // The system calls this to obtain the cursor to display when
    // the minimized window
    HCURSOR CSampleDlg::OnQueryDragIcon()
    {
        return (HCURSOR) m_hIcon;
    }

    CSampleDlg::OnButton1()
    {
        WriteDevice16("GP2", "_D00040__WORD", Enter value[Transmittin
    }
}

```

46. Declare the area to store write data. You should designate three or more area elements if the number of write data is three.

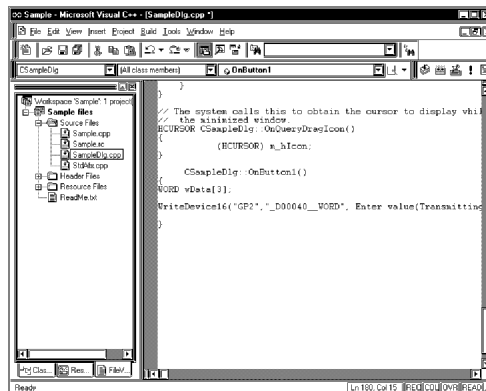

```

class CSampleDlg {
public:
    CSampleDlg(CWnd* pParent = NULL);
    ~CSampleDlg();

    // The system calls this to obtain the cursor to display when
    // the minimized window
    HCURSOR CSampleDlg::OnQueryDragIcon()
    {
        return (HCURSOR) m_hIcon;
    }

    CSampleDlg::OnButton1()
    {
        WORD vData[3];
        WriteDevice16("GP2", "_D00040__WORD", Enter value[Transmittin
    }
}

```

47. Set three write data entered into the EditBox to the area.

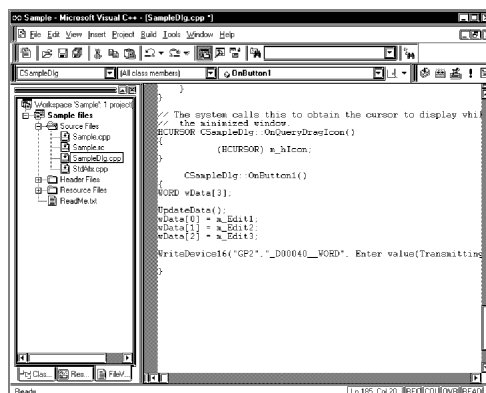

```

class CSampleDlg {
public:
    CSampleDlg(CWnd* pParent = NULL);
    ~CSampleDlg();

    // The system calls this to obtain the cursor to display when
    // the minimized window
    HCURSOR CSampleDlg::OnQueryDragIcon()
    {
        return (HCURSOR) m_hIcon;
    }

    CSampleDlg::OnButton1()
    {
        UpdateData();
        vData[0] = m_Edit1;
        vData[1] = m_Edit2;
        vData[2] = m_Edit3;
        WriteDevice16("GP2", "_D00040__WORD", Enter value[Transmittin
    }
}

```

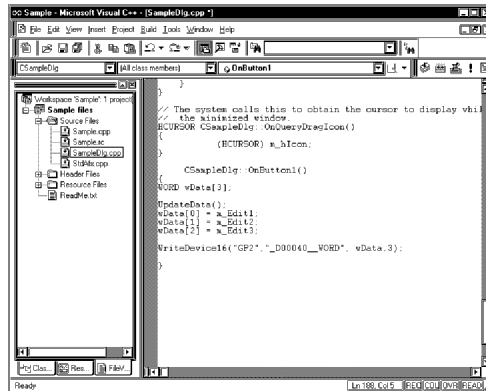

48. Designate the header area where write data have been set (wData(0)), and 3 as the number of read data. You should also add a semicolon (;) at the end of the write function.

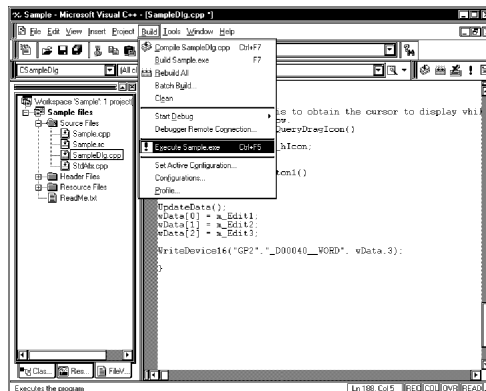

49. Click [Execute Sample.exe] on [Build] of the Microsoft Visual C++ menu.

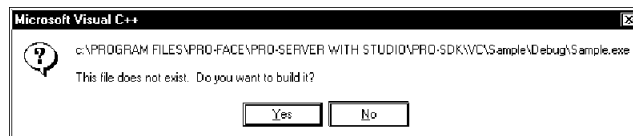

50. Click [Yes].



51. After entering three write data to [EditBox]s, click [Button1] to execute writing three data from the symbol “_D40_WORD”.

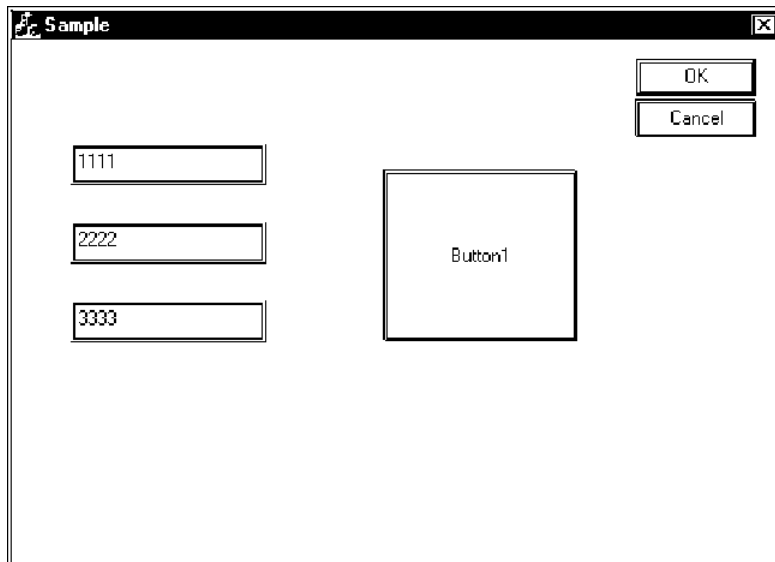

10 | OPC Server

This chapter describes OPC server for Pro-Server.

10.1 OPC Server

10.2 Example of Connection from the OPC Client (Collect-Pro)

10.1 OPC Server

Installing the Pro-Server OPC Server allows you to use applications which contain the OPC Client feature(ex. Intellution's iFIX, etc.).

- The OPC I/F functions like a DLL to the OPC Client(In-Process Server)
- EXE format is used for OPC I/F for an OPC Client existing in the same PC(Local Server)
- EXE format is used for the OPC I/F for an OPC Client existing in a remote PC(Remote Server)

Read/Write Functions

The Read/Write functions can be used either synchronously or asynchronously. The Read function can use either CACHE or DEVICE, and the Write function can use only DEVICE.

Synchronous

This method will require other processing to wait while the OPC Client is either reading or writing data to/from the OPC Server.

Asynchronous

This method utilizes a CALLBACK to acknowledge to the Client the reception and completion of a Client's read/write requests. This allows the OPC Client to perform other processing while waiting for the CALLBACK notice.

CACHE

CACHE means the storage and handling method used for processing requests (collected periodically from the Clients) in the OPC Server. With Pro-Server, this means the polling tool's internal data. This method, while it allows the returning of data at high speed to a Client, does not allow Real-Time processing.

DEVICE

Device data refers to handling of data from the final target (PLC). Current target data can be provided in real time, however, the response to that data is usually slower than the CACHE method.

OPC Server's Operating Environment

OS Requirement (Japanese or English)	Windows NT
Hard disk capacity	100MB or more
Required memory	64MB or more

MEMO

OPC cannot be used on the Windows 95, Windows 98, Windows 98 SE or Windows Me.

The following data explains the settings required when using the OPC Server. These settings should be entered in each of the OPC Clients used.

ItemID

The ItemID format is as follows:

ItemID = "XXX:DDDDD,SIG(NUMCHAR),SCL,SCH,EGUL,EGUH"

- XXX Node name to be accessed
- DDDDD Symbol name to be accessed or applicable PLC's device address
- SIG Signal condition (Can be omitted. When omitted, this becomes "NONE") Corresponding signal
condition type: LIN, BCD, and SQRT
- NUMCHAR When the Item's data type is set to VT_BSTR, the NUMCHAR value is used to place a character string in the position designated by the SCL value. Using VT_BSTR will automatically disable all options after SCL. Designate the character string using byte values. The default value is 40 bytes.
- SCL Lower limit value before scale conversion(Can be omitted. When omitted, this becomes "0")
- SCH Upper limit value before scale conversion(Can be omitted. When omitted, this becomes "65535")
- EGUL EGU's lower limit value(Can be omitted. When omitted, this becomes "0")
- EGUH EGU's upper limit value(Can be omitted. When omitted, this becomes "65535")

MEMO

When the data type is set to VT_BSTR, designate the number of characters(NUMCHAR)for SIG as the value of bytes. In that case, optional items(values)after SIG will become ineffective. The default value is 20 bytes.

Ex.)

When converting D100(from 0 to 4096)of PLC connected to GP1(node name)to LIN(0 to 100)and accessing:

ItemID = "GP1:D100,LIN,0,4096,0,100"

Program ID

The accompanying OPC server's Program ID is as follows:

"DIGITAL.OPCPRO.1"

Since CLSID is automatically registered to the registry at program installation, use this Program ID to perform the connection.

Initialization File

Editing the OPCIODRV. INI file allows you to change each initial value.

The items included in this file are as follows. The numbers shown are the initial (default) values.

[Server]

Server_MAX=10 (Number of servers)
Group_MAX=10 (Number of groups)
Item_MAX=100 (Number of items)
InproSvr_ScanRate=250 (In-Proc server's scanning cycle, Unit: ms)
LocalSvr_ScanRate=500 (Local server's scanning cycle, Unit: ms)

[Client]

CharacterStringCode=0 (Character string format 0: UNICODE, 1:Multibyte)
ItemID_Separator=.:! (Designates the ItemID separator)

Data Type

VARIANT data types that the accompanying OPC server has supported are as follows:

The I/O driver converts all analog data to 4-byte actual values and process them internally. Therefore, VT_I2, VT_I4, VT_UI2, VT_UI4, and VT_R8 will be all converted to VT_R4.

- EVT_I4 4-byte real number type
- EVT_I2 2-byte real number type
- EVT_UI2 2-byte no-code integer type
- EVT_UI4 4-byte no-code integer type
- EVT_R4 4-byte real number type
- EVT_R8 8-byte real number type
- EVT_BSTR String type
- EVT_BOOL BOOL type

Interface

Interfaces that this software's OPC server supports are as follows:

Object	Interface	Method	Status	Remaek
OPCServer	IOPCServer	AddGroup	○	
		GetErrorString	○	
		GetGroupByName	○	
		GetStatus	○	
		RemoveGroup	○	
		CreateGroupEnumerator	○	
	IOPCServerPublicGroups (Optional)	GetPublicGroupByName	×	
		RemovePublicGroup	×	
	IOPCBrowsServerAddressSpace (Optional)	QueryOrganization	○	Supports only Flat
		ChangeBrowsePosition	○	Always returns an error due to supporting only Flat
		BrowseOPCItemIDs	○	Supports only Flat
		GetItemID	×	
		BrowseAccessPaths	×	
	IPersistFile (Optional)	IsDirty	×	
		Load	×	
		Save	×	
		SaveComplated	×	
		GetCurFile	×	
	IOPCItemProperties	QueryAvailableItemProperties	○	
		GetItemProperties	○	
LookupItemID		○		
OPCGroup	IOPCGroupStateMgt	GetState	○	
		SetState	○	
		SetName	○	
		CloneGroup	○	
	IOPCPublicGroupsStateMgt (Optional)	GetState	×	
		MoveToPublic	×	
	IOPCSyncIO	Read	○	
		Write	○	
	IOPCAsyncIO (Optional)	Read	○	
		Write	○	
		Refresh	○	
		Cancel	○	
	IOPCAsyncIO2	Read	○	
		Write	○	
		Refresh	○	
		Cancel2	○	
		SetEnable	○	
		GetEnable	○	
	IOPCItemMgt	AddItems	○	
		ValidateItems	○	
		RemoveItems	○	
		SetActiveState	○	
		SetClientHandles	○	
		SetDatatypes	○	
		CreateEnumerator	○	
	IDataObject (Optional)	Dadvise	○	
		Dunadvise	○	
	IConnectionPointContainer	EnumConnectionPoints	○	
		FindConnectionPoints	○	
	IConnectionPoint	GetConnectionInterface	○	
GetConnectionPointContainer		○		
Advise		○		
Unadvise		○		
EnumConnections		○		
IEnumOPCItemAttributes	Next	○		
	Skip	○		
	Reset	○		
	Clone	○		
IEnumString	Next	○		
	Skip	○		
	Reset	○		
	Clone	○		
IEnumUnknown	Next	○		
	Skip	○		
	Reset	○		
	Clone	○		

○:Supported ×:Not supported

Appendices

- A.1 DDE Function Details
- A.2 Error Messages
- A.3 Scale Conversion using Excel
- A.4 GP Ethernet Settings

A.1 DDE Function Details

The Pro-Server software contains the DDE server function and can therefore exchange data with applications that support the DDE client function.

A.1.1 DDE Address

Sending/receiving data to/from the DDE server is accomplished by specifying an address that consists of three components; the application name, the topic name, and the item name.

Address components required for connecting to a DDE server

Application Name.....The name of the DDE server application. To have access to Pro-Server data, use the name "PROSERVER".

Topic Name.....The name of the data group in the DDE server. In Pro-Server, specify the node name of the GP on the network.

Item Name.....The actual data name used in the data group on the DDE server. In Pro-Server, specify the device address of the PLC connected to the GP. You can use the symbol name defined in Pro-Studio for this name.

Address example

=PROSERVER|GP's Node Name!Symbol Name

Example:

To read the data stored in address D100 of a Mitsubishi PLC, which is connected to a GP running the Mitsubishi protocol and with an IP address of 160.187.2.101, enter the following data:

=PROSERVER|' 160.187.2.101'!' D100'

MEMO

You may not use 2-bytes characters or single-byte "KATAKANA" characters to node names or symbol names because Microsoft Excel does not support those for topic or item names.

A.1.2 Device Address Options

If you use symbol names defined in Pro-Studio, the data type and the sampling frequency for the symbols will be set automatically. However, when the device address is specified directly, you can specify the data type and the sampling frequency as options.

Available Data Types

The available data types are as follows.

Data Type	Contents	
	Data Format	Value
Bit Data	.BIT	0 or 1
Unsigned Word(Default)	.WORD	0 to 65,535
Signed Word	+.WORD	-32,768 to 32,767
HEX Word	.HEX	0000 to FFFF
BCD Word	.BCD	0 to 9,999
Unsigned Long Word	.DWORD	0 to 4,294,967,295
Signed Long Word	+.DWORD	-2,147,483,648 to 2,147,483,647
HEX Long Word	.HEXDWORD	00000000 to FFFFFFFF
BCD Long Word	.BCDDWORD	0 to 99,999,999
Float	.FLOAT	-9.9E+16 to 9.9E+16
String	.STRING.*length*1	String(default length = 1)

*1 If the data type is "String", the data length is the maximum number of characters. If Null Data is included, the characters up to that point will be sent/received as data.

Concerning Data Types

.****:Polling Time is designated in ms units.

The default Polling Time is 1 second (1000ms)

Data Type/Polling Time

When designating the data type or polling time, be sure to put a comma (,) or a space () in front of the period (.).

MEMO

The polling time set for collecting or writing data for each symbol, distributing data and monitoring devices may not be able to be performed under certain conditions. These conditions include the currently registered number of GPs, number of Tags used on each screen sent, type of PLC connection, and number of other currently open Windows software. Entering "0" will allow the system to operate at its maximum speed. Please use this value as a benchmark when entering other values to "fine-tune" your system.

Device Designation Example

Here, the Device Address D100 is BCD data and the sampling frequency is 500 ms.

=PROSERVR|GP(Node Name!' D100)BCD .500'

D100_.BCD_.500

A.2 Error Messages

A.2.1 Pro-Server with Pro-Studio for Windows Error Messages

This section describes Pro-Server with Pro-Studio's error messages.

The error codes and error messages will be displayed on the personal computer where Pro-Server is currently operating. In addition, these error codes will be used when the simple DLL completes abnormally. “%s” indicates character strings, and “%??x” indicates hexadecimal values.

Error Code		Meaning
Decimal	Hex.	
9300	2454h	Cannot find network project file.
9301	2455h	Reserved
:	:	
9329	2471h	
9330	2472h	Cannot execute the command because resources are insufficient. Terminated program.
9331	2473h	The system resource was dead-locked. Terminated program.
9332	2474h	System error
9333	2475h	Cannot execute the command because program versions do not match.
9334	2476h	Reserved
:	:	
9339	247Bh	
9340	247Ch	An error occurred when accessing the <%s> file.
9341	247Dh	Pro-Server is being used by too many applications.
9342	247Eh	OS resources are insufficient (insufficient memory).
9343	247Fh	The set connector is used by another application.
9344	2480h	Pro-Server has not been started. Could not reference data.
9345	2481h	Pro-Server has been terminated. Could not reference data.
9346	2482h	Cannot continue - Pro-Server has been terminated.
9347	2483h	Cannot continue - Pro-Server has been terminated.
9348	2484h	Could not start Pro-Server.
9349	2485h	Could not start Pro-Studio.
9350	2486h	Unsupported command. Cannot continue.
9351	2487h	Failed in loading the network project file.
9352	2488h	The entered node name has already been registered.
9353	2489h	The entered node name has not been registered.
9354	248Ah	Backup data type specified is not supported.
9355	248Bh	Failed to writing to the file.
9356	248Ch	Could not create a file to store the SRAM backup data.
9357	248Dh	The node name entered has not been registered.
9358	248Eh	Pro-Server is already operating. Cannot start two copies.
9359	248Fh	Reserved
9360	2490h	'%s'has not been entered.
9361	2491h	0 cannot be entered in '%s'.
9362	2492h	'%s'should be: "xxx.xxx.xxx.xxx" format; where xxx is a value between 0 and 255.
9363	2493h	An invalid value has been entered in '%s'.
9364	2494h	A character unavailable for '%s' is involved.
9365	2495h	'%s'has not been entered yet.
9366	2496h	Cannot start a new process until the process result is returned from the server.
9367	2497h	Cannot terminate the application while waiting for the process result.
9368	2498h	Read permission required to execute this command. Log on to the network again.
9369	2499h	Write permission required to execute this command. Log on to the network again.
9370	249Ah	Administrator permission required to execute this command. Log on to the network again.

Reserved		Meaning
Decimal	Hex.	
9371	249Bh	The specified number is not registered.
9372	249Ch	Reserved
9373	249Dh	
9374	249Eh	Cannot find the file (Core.ID).
9375	249Fh	Does not support the designated GP.
9376	24A0h	Cannot read the file (Core.ID)
9377	24A1h	Reserved
:	:	
9399	24D7h	
9400	24B8h	The function of Pro-Easy.DLL was doubly called up.
9401	24B9h	The specified access handle for Pro-Server is not effective.
9402	24BAh	Pro-Server has stopped and can not perform processing.
9403	24BBh	The error occurred in the function of OLE. Data cannot be converted.
9404	24BCCh	The effective data for the specified data-type variant does not exist in the original data, or is not enough.
9405	24BDh	Original data and destination data types cannot be converted by data-type variant.
9406	24BEh	The specified argument is not enabled.
9407	24BFh	Can not create the time bar.
9408	24C0h	Public memory of provide sheet could not open.
9409	24C1h	The symbol name is not registered.
9410	24C2h	The specified time bar has already been locked.
9411	24C3h	The specified handle has already been linked.
9412	24C4h	The specified handle is not linked.
9413	24C5h	The specified handle is not linked to the database
9414	24C6h	Specified handle is locked or played, Please excute after clearing to its status.
9415	24C7h	Designate the internal format of the argument's Variant as either "date" type, or comatible with "date".
9416	24C8h	The specified time is out of the valid range.
9417	24C9h	The invalid argument has been set.
9418	24CAh	Database of appinted handle is closed.
9419	24CBh	Database access error.
9420	24CCh	INI file ('%s') in the action contents cannot be opened.
9421	24CDh	'%s' of INI file ('%s') in the action contents cannot be analyzed.
9422	24CEh	Action '%s' uses action contents not yet installed in the network project.
9423	24CFh	There are too many actions to register.
9424	24D0h	The specified action has already been registered.
9425	24D1h	The action contents which action '%s' uses cannot be started.
9426	24D2h	The designated action is not registered.
9427	24D3h	An error occurred on the Active-X IF.
9428	24D4h	The designated action has been registered in the registry.
9429	24D5h	Reserved
:	:	
9449	24E9h	
9450	24EAh	The node name or symbol name is not specified.
9451	24EBh	The node name is not specified.
9452	24ECh	The data type setting is not valid.
9453	24EDh	The node name and symbol is not delimited with '!'.
9454	24EEh	The symbol name has not been registered or it is not a valid device address.
9455	24EFh	Cannot continue the process - no valid device is specified.
9456	24F0h	Cannot make word-access to 32-bit devices.
9457	24F1h	The address is out of the valid range.
9458	24F2h	The No. of points setting is invalid.
9459	24F3h	The No. of points setting is 0 or exceeds the setting range.
9460	24F4h	Cannot convert the set symbol into a device address.
9461	24F5h	A value input error occurred. Enter a correct value.

Error Code		Meaning
Decimal	Hex.	
9462	24F6h	The specified lifetime is invalid.
9463	24F7h	The designated bit location is incorrect.
9464	24F8h	Reserved
:	:	
9499	251Bh	
9500	251Ch	Pro-Server schedule management thread initialization error
9501	251Dh	Pro-Server LAN management thread initialization error
9502	251Eh	Pro-Server timer management thread initialization error
9503	251Fh	Pro-Server DDE control thread initialization error
9504	2520h	Pro-Server API control thread initialization error
9505	2521h	Pro-Server API parameter error
9506	2522h	Response time out
9507	2523h	Pro-Server failed in initializing the LAN.
9508	2524h	No data
9509	2525h	Invalid device
9510	2526h	Invalid address
9511	2527h	The address is out of the valid range.
9512	2528h	Data type error
9513	2529h	Transmission message error
9514	252Ah	Cannot initialize Pro-Server cache function.
9515	252Bh	Cannot load the network project because the database is used.
9516	252Ch	Reserved
:	:	
9519	252Fh	
9520	2530h	PS item handle is incorrect.
9521	2531h	PS item read/write were not executed. (The process was stopped on the way.)
9522	2532h	Polling View output failed.
9523	2533h	Reserved
:	:	
9529	2539h	
9530	253Ah	PL RAS initialization error.
9531	253Bh	Unsupported Command.
9532	253Ch	Unsupoorted Access Type.
9533	253Dh	Unsupoorted Read/Write Type.
9534	253Eh	Rejected to access to the device.
9535	253Fh	Failed to set/get the value to the device.
9536	2540h	Reserved
:	:	
9559	2557h	
9560	2558h	DLL load error.
9561	2559h	Cannot find a function in DLL.
9562	255Ah	System error can be considered if this occurs.
9563	255Bh	The designated property ID is not defined.
9564	255Ch	Value conversion error. Incorrect characters as numbers are designated.
9565	255Dh	Too many characters.
9566	255Eh	The number is too large.
9567	255Fh	Cannot start COMM.
9568	2560h	Cannot start GJ.
9569	2561h	Cannot open the %s file.
9570	2562h	File read error.
9571	2563h	File write error.
9572	2564h	No tags exist. (No parameter class declarations exist.)
9573	2565h	No end tags exist. (No parameter class declarations exist.)
9574	2566h	Found the unexpected end tag.

Error Code		Meaning
Decimal	Hex.	
9575	2567h	Signatures do not match.
9576	2568h	Unsupported parameter.
9577	2569h	Reached the file end.
9578	256Ah	The incorrect structure.
9579	256Bh	Cannot continue the process due to a memory lack.
9580	256Ch	Cannot analyze the device name.
9581	256Dh	DB name is not designated.
9582	256Eh	Cannot access to DB.
9583	256Fh	Cannot edit DB because it is locked (edited) by another program (e.g. Data View).
9584	2570h	Either the node name or the device name is not designated.
9585	2571h	Cannot use DB because it has been closed. (DB in use is automatically closed once when NPJ is saved/loaded.)
9586	2572h	The database may be broken.
9587	2573h	Data not saved.
9588	2574h	Cannot find data at the designated time.
9589	2575h	No polling setups exist.
9590	2576h	The database has not been opened. (Or it has already been closed.)
9591	2577h	Already polling start.
9592	2578h	Old data will be overwritten, instead of newest data.
9593	2579h	Delete recode.
9594	258Ah	Reserved
:	:	
9599	257Fh	
9600	2580h	Cannot continue the process due to a resource lack in GP.
9601	2581h	Reserved
:	:	
9619	2593h	
9620	2594h	The network project item has been registered redundantly. (The network project file has been broken.)
9621	2595h	Reserved
:	:	
9639	25A7h	
9640	25A8h	The Provider information data that is not registered in the network project file were sent from other node. (Network projects differ between the Provider and the Receiver nodes.)
9641	25A9h	Either that the device write failed at the Receiver node or that no partner nodes exist while providing data.
9642	25AAh	Reserved
:	:	
9659	25BBh	
9660	25BCh	Data Read failed.
9661	25BDh	Invalid access range of the read device.
9662	25BEh	Reserved
:	:	
9699	25E3h	
9700	25E4h	Received the first trigger establish command for non-existing provider information.
9701	25E5h	Reserved
:	:	
9709	25EDh	
9710	25EEh	Received the second trigger establish command for non-existing provider information.
9711	25EFh	Reserved
:	:	
9729	2601h	
9730	2602h	The GP is busy sending screen data or saving SRAM backup data to another PC.
9731	2603h	An error occurred in reading the SRAM backup data. (The item ID differs from the previous ID.)
9732	2604h	An error occurred in reading the SRAM backup data. (The data type differs from the previous type.)
9733	2605h	An error occurred in reading the SRAM backup data. (The block No. differs from the previous No.)
9734	2606h	SRAM backup data read error. (The requested data amount is 0 or differs from the previous amount.)

Error Code		Meaning
Decimal	Hex.	
9735 : 9739	2607h : 260Bh	Reserved
9740	260Ch	The GP is busy sending screen data or saving SRAM backup data to another PC.
9741	260Dh	An error occurred in reading the SRAM backup data. (The item ID differs from the previous ID.)
9742	260Eh	An error occurred in reading the SRAM backup data. (The data type differs from the previous type.)
9743	260Fh	An error occurred in reading the SRAM backup data. (The block No. differs from the previous No.)
9744	2610h	SRAM backup data read error. (The requested data amount is 0 or differs from the previous amount.)
9745 : 9749	2611h : 2615h	Reserved
9750	2616h	CF command error.
9751	2617h	CF Access error
9752	2618h	No CF card unit.
9753 : 9779	2619h : 2633h	Reserved
9780	2634h	Transmission error occurred with PLC during data write. (Code:%02x:%04x)
9781	2635h	The designated SRAM backup data is not in the GP.
9782	2636h	The GP's SRAM backup data is incorrect. (Code:%04x)
9783 : 9789	2637h : 263Dh	Reserved
9790	263Eh	No remote access right (not connected remotely)

For information about 2580h, 25A8h, 25A9h, refer to “2-Way Driver Error Messages and Syslog Features”.

A.2.2 2-Way Driver Error Messages and Syslog Features

Error Display

The ECOM task displays the following error information on the lower left of the screen.

Screen Display	Meaning
SYSTEM ERROR	System call error
2Way ERROR	2-Way Driver error

System Errors

A system error is a fatal error.

2-Way Errors

A 2-Way error is an error that has occurred due to the 2-Way Driver.

When a 2-Way error occurs, the [2-Way Transfer Error Code] is saved to the GP unit's LS2075 address.

Syntax: 2Way ERROR(<Cause No.>:<Error No. 1>:<Error No. 2>:<Error No. 3>)

Reason Code	Error Type	Error No.			Reason	2Way Error Code
		1	2	3		
30	Fatal	Unused	Unused	Unused	Insufficient GP resources.	FF30
31	Fatal	Unused	Unused	Unused	Cannot release GP resources	FF31
32	Fatal	Unused	Unused	Unused	Cannot release GP resources	FF32
40	Fatal	Unused	Unused	Unused	IP address & Port number are not registered.	FF40
41	Fatal	Unused	Unused	Unused	The symbol state is different than GLC control.	FF41
51	Fatal	Unused	Unused	Refer to protocol stack error codes	Protocol Stack Call up error.	FF51
F0	Warn- ing	0	Unused	2580	After transmit command was sent, Device Read was ignored due to insufficient Receiver memory.	2580
		0	Unused	25A8	After transmit command was sent, Receiver unable to find data.	25A8
		0	Unused	25A9	After transmit command (with reply) was sent, no reply was received from Receiver.	25A9
		0	Refer to each PLC's error code list		After transmit command was sent, Receiver was unable to write to device. (Refer to each PLC's Manual)	FFF0

Protocol Stack Error Codes

The following protocol stack error codes are displayed on the GP screen.

Error Code	Meaning
1000	Current node IP Address entry failed during initialization
1005	Initialization failed
1006	Transmit Halt processing failed
1007	Initialization is performed again, without previous initialization being completely terminated
1008	Provider Node Port number error.
1009	Receiver Node port number error.
100A	Receiver Node IP Address error.
100B	UDP was used to register this port number.
100C	TCP was used to connect an adjacent port with a port having the same number.
100D	Protocol Stack establishment refused
100E	Protocol Stack Open Failure(value)was returned
100F	The(communication)connection has been cut.
1010	All connections are currently in use.
1013	Receiver has aborted(communication).
1030	No response from the protocol stack.
1032	No response from the Receiver.

MEMO

- When the error type is fatal, the 2-Way Driver cannot be restored.
- When the error type is Warning, the 2-Way Driver continues to operate. Once the cause of the error is removed, the error display will disappear when the GP's screen changes.
- When the Reason Code is "F0" the "Alarm Issued Time" and "Receiver IP Address" will also be displayed.

SYSLOG

If the SYSLOG file(SYSLOG.EXE), located inside the Pro-Server's system folder, is started, the following data can be checked. The 2-Way Driver downloaded to the GP can perform a variety of tasks, among them being the output of SYSLOG data.

You can select the type of SYSLOG data output via the GP OFFLINE mode's[SYSLOG Information Settings]. The correspondence of the Output Level and the output producing SYSLOG Priority level is shown below.

Output Level	SYSLOG Output Priority Level
0	No correspondence
1	INFO,
2	INFO,NOTICE
3	INFO,NOTICE,WARNING
4	INFO,NOTICE,WARNING,DEBUG

SYSLOG Output Information

SYSLOG Level	ECOM Response	SYSLOG Text
INFO	Starts ONLINE	gp[17]: start online
INFO	Starts OFFLINE	gp[17]: start offline
WARNING	Processing Failed	gp[17]: bel: fail, <Processing Failed Text> <Argument1>
DEBUG	Device Read	gp[17]: rdev: <Argument2>
DEBUG	Device Write	gp[17]: wdev: <Argument2>
DEBUG	Command Received	gp[17]: bel: <Command Text1>, recv from <IP address><port><Argument3>
DEBUG	Command Sent	gp[17]: bel: <Command Text2>, send to <IP address><port><Argument3>
DEBUG	s201 File Read	gp[17]: bel: <Command Text3> <Argument4> send to <IP address>

Failed Processing String	Meaning
read device	Failed in reading from the device
write device	Failed in writing to the device.
sync provide, response timeout	No return data received from the receiver node after providing data.
sync provide, fail to read device	Failed in reading from the device when providing data.
lack memory	Command ignored due to insufficient 2-Way driver memory.
first trigger on	The command to enable the first trigger failed.
second trigger on	The command to enable the second trigger failed.
backup data read	Failed in reading the backup data.

Command String 1	Contents
response	Receives the response.
sync provide	Provides the data.
read device	Reads from the device.
write device	Writes to the device.
get node property	Reads the node property.
first trigger on	Enables the first trigger.
second trigger on	Enables the second trigger.
backup data read	Reads the backup data.

Command String 2	Contents
sync provide, broadcast	Provides the data(Broadcast, no response).
sync provide, send each	Provides the data(Peer to Peer, no response).
sync provide, broadcast and wait for response	Provides the data(Broadcast, with response).
sync provide, send each and wait for response	Provides the data(Peer to Peer, with response).
sync provide, response	Provide data response.
read device, response	Device read response.
write device, response	Device write response.
write device, response(retry)	Write to device(Retry)response.
get node property, response	Read node property response.
first trigger on, response	First trigger enable response.
second trigger on, response	Second trigger enable response.
backup data read, response	Read backup data response.

Command String 3	Contents
register as sender	Registers provide data command as sender(provider).
register as receiver	Registers provide data command as receiver.

Argument1(<String>=<Value>)

String	Value	Value display format
err	Error No.	Hex.
pr	ProjectID	Hex.
ow	OwnerApp	Hex.
ma	MajorNo	Hex.
mi	MinorNo	Hex.

Argument2(<String>=<Value>)

String	Value	Value display format
code	Device code	Hex.
addr	Device address	Hex.
pack	DataPack	Hex.
kind	DataKind	Hex.
count	Data count by word	Hex.
d0	First data (1WORD)	Hex.

Argument3(<String>=<Value>)

String	Value	Value display format
pr	ProjectID	Hex.
ow	OwnerApp	Hex.
ma	MajorNo	Hex.
mi	MinorNo	Hex.
dl	DataLen	Hex.
va	Validity	Hex.

Argument4(<String>=<Value>)

String	Value	Value display format
rn	ResourceNo	Hex.
pack	DataPack	Hex.
kind	DataKind	Hex.
count	ProvidCount	Hex.
howto	HowTo	Hex.
ext	ExtDevType	Hex.
code	Device code	Hex.
addr	Device address	Hex.
retry	RetryCount	Hex.
wait	RetryWaitTime	Hex.

A.3 Scale Conversion using Excel

This section explains the use of Microsoft Excel's scale conversion feature for input data.

The following example converts a range of 1 to 1000 to a range of 1 to 100.

	A	B	C	D	E	F	G	H	I
1									
2			1	1000	1	100			
3									
4				500				50	
5									
6									
7									

C2: Minimum input value

D2: Maximum input value

E2: Minimum conversion value

F2: Maximum conversion value

D4: Input value

H4: Conversion value

The formula for H4 is as follows:

=IF(((D4/(D2/F2))<1),1,QUOTIENT(D4/(D2/F2),1))

MEMO

To use the abovementioned formula, you must first install Excel's [Analysis ToolPack]. To do this, us Excel's [Tools] -> [Add-Ins] dialog to add the [Analysis ToolPack].

A.4 GP Ethernet Settings

Prior to sending data to the GP, the proper settings must be entered. After data transfer or setup are finished, the GP's OFFLINE menu will appear. Select [INITIALIZE], [SETUP OPERATION SURROUNDINGS], and then [EXTENDED SETTINGS] and the following screen will appear.

MEMO

When using the 2-Way driver, perform self-diagnosis of the Ethernet unit from the following Expanded Settings screen, not from the OFFLINE mode's Main Menu screen.

Expanded Settings

The screens shown here are setup examples.

The image shows two screenshots of the GP's setup interface. The top screenshot is a main menu with four options: 1. ETHERNET SETUP, 2. SYSLOG SETUP, 3. OTHERS SETUP, and 4. SELF-DIAGNOSIS. A vertical line connects the 'ETHERNET SETUP' option to a larger screenshot below. This larger screenshot shows the '[1]ETHERNET SETUP' screen. It has a title bar with 'ETHERNET SETUP' and 'PREVIOUS' and 'NEXT' buttons. Below the title bar are four fields for configuration: 'MY IP ADDRESS' with a prompt '[] [] [] [] [] []', 'SUBNET MASK' with a prompt '[] [] [] [] [] []', 'MY PORT NO.' with a prompt '[]', and 'GATEWAY' with a prompt '[] [] [] [] [] []'.

• MY IP ADDRESS

The IP addresses 32 bits used are divided into 4 groups of 8. Use Base 10 numbers only.

• SUBNET MASK

If unused, enter all zeroes here.

• MY PORT NO.

Port number range is from 1024 to 65535. Sequential ten ports from MY PORT NO. are used.

• GATEWAY

If unused, enter all zeroes here. There is only one GATEWAY setting.

[2]SYSLOG SETUP

SYSLOG SETUP		PREVIOUS	NEXT
HOST IP ADDRESS	[] [] [] [] [] []		
FACILITY	[]		
OUTPUT LEVEL	[]		

- **HOST IP ADDRESS**

IP Address for the SYSLOG destination output. (Where GPSYSLOG.EXE is running.)

- **FACILITY**

(Default value:1) reserved

You may not change the default value.

- **OUTPUT LEVEL**

Designate the output level.

(Setting range: 0 to 4, Default value: 0)

[3]OTHERS SETUP

OTHERS SETUP			PREVIOUS	NEXT
BUZZER ON ERROR	ON	OFF		
DISPLAY WARNING	ON	OFF		

- **BUZZER ON ERROR**

Buzzer sounds when a 2-Way Driver error occurs.

(Default value: ON)

- **DISPLAY WARNING**

This screen designates if warning messages are displayed on the GP's screen.