



KOSTAC/DL Series CCM SIO Driver

1	System Configuration.....	3
2	Selection of External Device	10
3	Example of Communication Setting.....	11
4	Setup Items	62
5	Cable Diagram	67
6	Supported Device.....	94
7	Device Code and Address Code.....	107
8	Error Messages	110

Introduction

This manual describes how to connect the Display and the External Device.

In this manual, the connection procedure will be described by following the sections below:

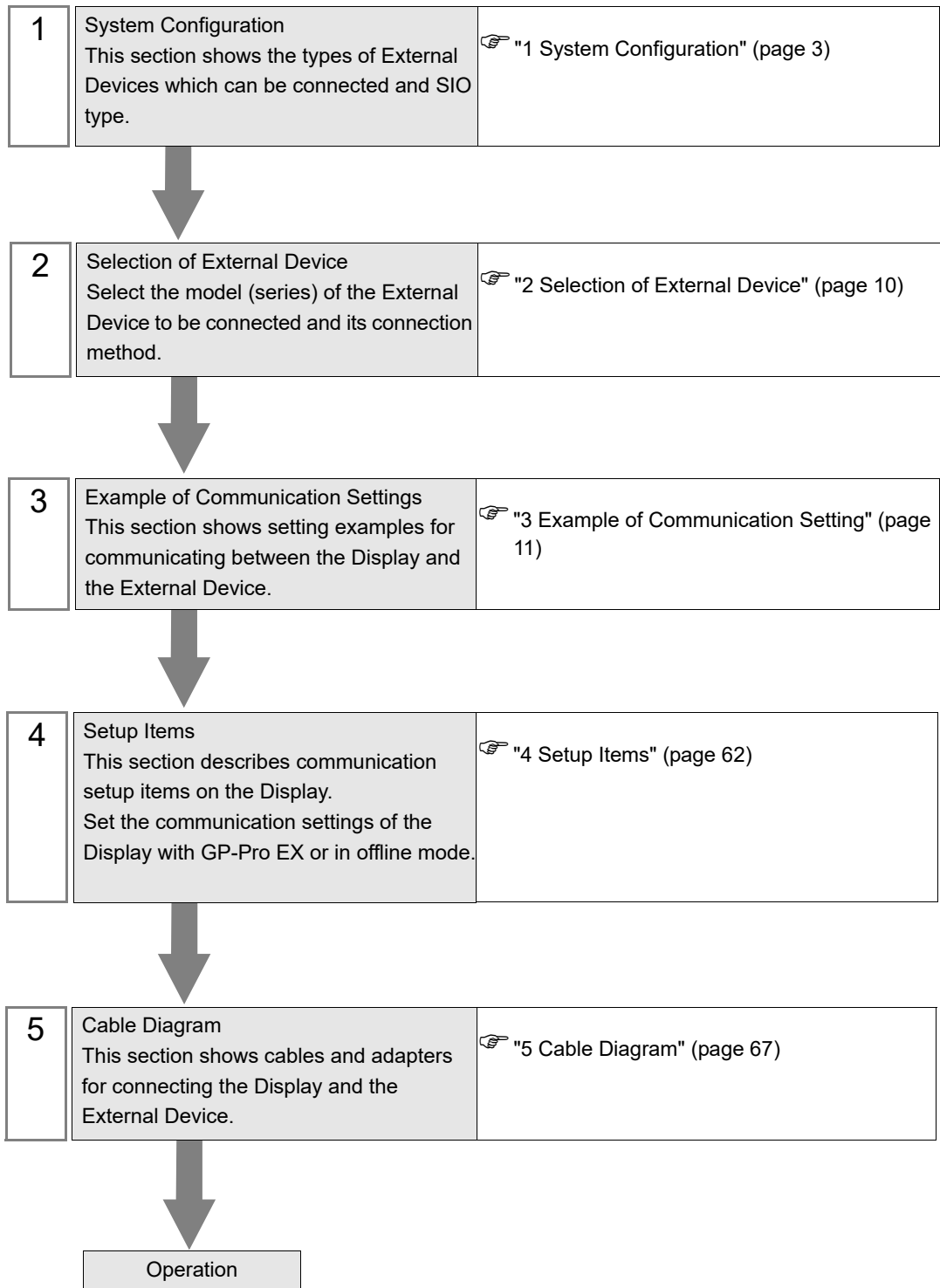

1 System Configuration

The following shows the system configuration where the External Device of KOYO ELECTRONICS INDUSTRIES CO., LTD. and the Display are connected.

Series	CPU	Link I/F	SIO Type	Setting Example	Cable Diagram
KOSTAC SG	SG-8	CN1 on G-01DM	RS422/485 (4wire)	Setting Example 2 (page 13)	Cable Diagram 2 (page 69)
		CN2 on G-01DM	RS232C	Setting Example 1 (page 11)	Cable Diagram 1 (page 67)
		General-purpose communication port on CPU*1	RS232C	Setting Example 3 (page 15)	Cable Diagram 1 (page 67)
			RS422/485 (4wire)	Setting Example 4 (page 17)	Cable Diagram 3 (page 77)
KOSTAC SU	SU-5	U-01DM	RS232C	Setting Example 5 (page 19)	Cable Diagram 1 (page 67)
			RS422/485 (4wire)	Setting Example 6 (page 21)	Cable Diagram 2 (page 69)
	SU-5E SU-6 SU-6B SU-6B-C	U-01DM	RS232C	Setting Example 5 (page 19)	Cable Diagram 1 (page 67)
			RS422/485 (4wire)	Setting Example 6 (page 21)	Cable Diagram 2 (page 69)
		General-purpose communication port on CPU	RS232C	Setting Example 7 (page 23)	Cable Diagram 1 (page 67)
			RS422/485 (4wire)	Setting Example 8 (page 25)	Cable Diagram 3 (page 77)

Series	CPU	Link I/F	SIO Type	Setting Example	Cable Diagram
KOSTAC SU	SU-5M SU-5M-C	U-01DM	RS232C	Setting Example 5 (page 19)	Cable Diagram 1 (page 67)
			RS422/485 (4wire)	Setting Example 6 (page 21)	Cable Diagram 2 (page 69)
		General-purpose communication port 1 on CPU	RS232C	Setting Example 9 (page 27)	Cable Diagram 1 (page 67)
			RS422/485 (4wire)	Setting Example 10 (page 29)	Cable Diagram 3 (page 77)
		General-purpose communication port 2 on CPU	RS232C	Setting Example 11 (page 31)	Cable Diagram 4 (page 82)
	SU-6M SU-6M-C	U-01DM	RS232C	Setting Example 5 (page 19)	Cable Diagram 1 (page 67)
			RS422/485 (4wire)	Setting Example 6 (page 21)	Cable Diagram 2 (page 69)
		General-purpose communication port 1 on CPU	RS232C	Setting Example 9 (page 27)	Cable Diagram 1 (page 67)
			RS422/485 (4wire)	Setting Example 10 (page 29)	Cable Diagram 3 (page 77)
		General-purpose communication port 2 on CPU	RS232C	Setting Example 11 (page 31)	Cable Diagram 4 (page 82)
KOSTAC SZ	SZ-4	General-purpose communication port on CPU	RS232C	Setting Example 12 (page 33)	Cable Diagram 4 (page 82)
KOSTAC PZ3	PZ3-16ND1-16TD1 PZ3-T PZ3M	General-purpose communication port 2 on CPU	RS232C	Setting Example 23 (page 54)	Cable Diagram 6 (page 86)
			RS422/485 (4wire)	Setting Example 24 (page 56)	Cable Diagram 7 (page 88)
KOSTAC SR	SR-21 SR-22	E-02DM-R1	RS422/485 (4wire)	Setting Example 13 (page 35)	Cable Diagram 2 (page 69)

Series	CPU	Link I/F	SIO Type	Setting Example	Cable Diagram
DL-205	D2-240	General-purpose communication port 2 on CPU	RS232C	Setting Example 14 (page 37)	Cable Diagram 4 (page 82)
	D2-250-1	General-purpose communication port 2 on CPU	RS232C	Setting Example 14 (page 37)	Cable Diagram 6 (page 86)
	D2-260	General-purpose communication port 2 on CPU	RS232C	Setting Example 14 (page 37)	Cable Diagram 6 (page 86)
			RS422/485 (4wire)	Setting Example 15 (page 39)	Cable Diagram 7 (page 88)
DL-405	D4-430	D4-DCM	RS232C	Setting Example 16 (page 41)	Cable Diagram 1 (page 67)
			RS422/485 (4wire)	Setting Example 17 (page 43)	Cable Diagram 2 (page 69)
	D4-440	D4-DCM	RS232C	Setting Example 16 (page 41)	Cable Diagram 1 (page 67)
			RS422/485 (4wire)	Setting Example 17 (page 43)	Cable Diagram 2 (page 69)
		General-purpose communication port on CPU	RS232C	Setting Example 18 (page 45)	Cable Diagram 1 (page 67)
			RS422/485 (4wire)	Setting Example 19 (page 47)	Cable Diagram 3 (page 77)
	D4-454*2	General-purpose communication port 1 on CPU	RS232C	Setting Example 25 (page 58)	Cable Diagram 1 (page 67)
			RS422/485 (4wire)	Setting Example 26 (page 60)	Cable Diagram 2 (page 69)
		General-purpose communication port 2 on CPU	RS232C	Setting Example 25 (page 58)	Cable Diagram 8 (page 93)
	DL-305	D3-330	D3-DCM	RS422/485 (4wire)	Setting Example 20 (page 49)

Series	CPU	Link I/F	SIO Type	Setting Example	Cable Diagram
DirectLogic 05	D0-05AA D0-05AD D0-05AR D0-05DA	General-purpose communication port 1 on CPU	RS232C	Setting Example 22 (page 53)	Cable Diagram 5 (page 84)
	D0-05DD D0-05DD-D D0-05DR D0-05DR-D	General-purpose communication port 2 on CPU	RS232C	Setting Example 21 (page 51)	Cable Diagram 5 (page 84)
DirectLogic 06	D0-06DD1 D0-06DD1-D D0-06DD2 D0-06DD2-D	General-purpose communication port 1 on CPU	RS232C	Setting Example 22 (page 53)	Cable Diagram 5 (page 84)
	D0-06DR D0-06DR-D D0-06DA D0-06AR D0-06AA	General-purpose communication port 2 on CPU	RS232C	Setting Example 21 (page 51)	Cable Diagram 5 (page 84)

*1 Remove the instruction word programmer from the programmer communication port during communication.

*2 Firmware version 8.05 or later is required. (For ADC in the United States, version 1.03 or later.)

NOTE • Set the execution time of the logic functions in the Display to "700 ms" or less. If the longer time is set, an error may occur in the communication with the external device.

■ Connection Configuration

- 1:1 Connection



- 1:n Connection

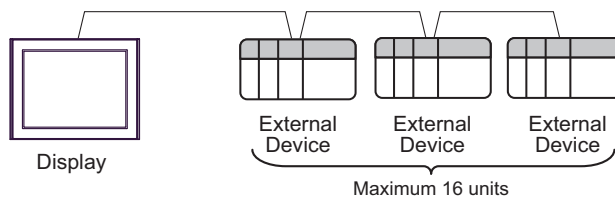

■ IPC COM Port

When connecting IPC with an External Device, the COM port used depends on the series and SIO type. Please refer to the IPC manual for details.

Usable port

Series	Usable Port		
	RS-232C	RS-422/485(4 wire)	RS-422/485(2 wire)
PS-2000B	COM1 ^{*1} , COM2, COM3 ^{*1} , COM4	-	-
PS-3450A, PS-3451A, PS3000-BA, PS3001-BD	COM1, COM2 ^{*1*2}	COM2 ^{*1*2}	COM2 ^{*1*2}
PS-3650A (T41 model), PS-3651A (T41 model)	COM1 ^{*1}	-	-
PS-3650A (T42 model), PS-3651A (T42 model)	COM1 ^{*1*2} , COM2	COM1 ^{*1*2}	COM1 ^{*1*2}
PS-3700A (Pentium®4-M) PS-3710A	COM1 ^{*1} , COM2 ^{*1} , COM3 ^{*2} , COM4	COM3 ^{*2}	COM3 ^{*2}
PS-3711A	COM1 ^{*1} , COM2 ^{*2}	COM2 ^{*2}	COM2 ^{*2}
PS4000 ^{*3}	COM1, COM2	-	-
PL3000	COM1 ^{*1*2} , COM2 ^{*1} , COM3, COM4	COM1 ^{*1*2}	COM1 ^{*1*2}
PE-4000B Atom N270	COM1, COM2	-	-
PE-4000B Atom N2600	COM1, COM2	COM3 ^{*4} , COM4 ^{*4} , COM5 ^{*4} , COM6 ^{*4}	COM3 ^{*4} , COM4 ^{*4} , COM5 ^{*4} , COM6 ^{*4}
PS5000 (Slim Panel Type Core i3 Model) ^{*5*6}	COM1, COM2 ^{*4}	COM2 ^{*4}	COM2 ^{*4}
PS5000 (Slim Panel Type Atom Model) ^{*5*6}	COM1, COM2 ^{*7}	COM2 ^{*7}	COM2 ^{*7}
PS5000 (Enclosed Panel Type) ^{*8}	COM1	-	-
PS5000 (Modular Type PFXPU/PFXPP) ^{*5*6} PS5000 (Modular Type PFXPL2B5-6)	COM1 ^{*7}	COM1 ^{*7}	COM1 ^{*7}
PS5000 (Modular Type PFXPL2B1-4)	COM1, COM2 ^{*7}	COM2 ^{*7}	COM2 ^{*7}
PS6000	COM1 ^{*9}	^{*10}	^{*10}

*1 The RI/5V can be switched. Use the IPC's switch to change if necessary.

*2 Set up the SIO type with the DIP Switch. Please set up as follows according to SIO type to be used.

*3 When making communication between an External Device and COM port on the Expansion slot, only RS-232C is supported. However, ER (DTR/CTS) control cannot be executed because of the specification of COM port.

For connection with External Device, use user-created cables and disable Pin Nos. 1, 4, 6 and 9. Please refer to the IPC manual for details of pin layout.

*4 Set up the SIO type with the BIOS. Please refer to the IPC manual for details of BIOS.

- *5 When setting up communication between an External Device and the RS-232C/422/485 interface module, use the IPC (RS-232C) or PS5000 (RS-422/485) cable diagrams. However, when using PFXZPBMPR42P2 in a RS-422/485 (4-wire) configuration with no flow control, connect 7.RTS+ and 8.CTS+, and connect 6.RTS- and 9.CTS-.
When using RS-422/485 communication with External Devices, you may need to reduce the transmission speed and increase the TX Wait time.
- *6 To use RS-422/485 communication on the RS-232C/422/485 interface module, the DIP Switch setting is required. Please refer to "Knowledge Base" (FAQs) on the support site. (<http://www.pro-face.com/trans/en/manual/1001.html>)

Settings	FAQ ID
PFXZPBMPR42P2, RS422/485 change method	FA263858
PFXZPBMPR42P2 termination resistor setting	FA263974
PFXZPBMPR44P2, RS422/485 change method	FA264087
PFXZPBMPR44P2 termination resistor setting	FA264088

- *7 Set up the SIO type with the DIP Switch. Please refer to the IPC manual for details of DIP Switch. The BOX Atom has not a switch to set the RS-232C, RS-422/485 mode. Use the BIOS for the setting.
- *8 For the connection with the External Device, on the user-created cable read as if the connector on the Display-side is a M12 A-coding 8 pin socket. The pin assignment is the same as described in the cable diagram. For the M12 A-coding connector, use PFXZPSCNM122.
- *9 In addition to COM1, you can also use the RS-232C COM port on the optional interface.
- *10 Install the optional interface in the expansion slot.

DIP Switch settings (PL3000 / PS3000 Series)

RS-232C

DIP Switch	Setting	Description
1	OFF*1	Reserved (always OFF)
2	OFF	SIO type: RS-232C
3	OFF	
4	OFF	Output mode of SD (TXD) data: Always output
5	OFF	Terminal resistance (220Ω) insertion to SD (TXD): None
6	OFF	Terminal resistance (220Ω) insertion to RD (RXD): None
7	OFF	Short-circuit of SDA (TXA) and RDA (RXA): Not available
8	OFF	Short-circuit of SDB (TXB) and RDB (RXB): Not available
9	OFF	RS (RTS) Auto control mode: Disabled
10	OFF	

*1 When using PS-3450A, PS-3451A, PS3000-BA and PS3001-BD, turn ON the set value.

RS-422/485 (4 wire)

DIP Switch	Setting	Description
1	OFF	Reserved (always OFF)
2	ON	SIO type: RS-422/485
3	ON	
4	OFF	Output mode of SD (TXD) data: Always output
5	OFF	Terminal resistance (220Ω) insertion to SD (TXD): None
6	OFF	Terminal resistance (220Ω) insertion to RD (RXD): None
7	OFF	Short-circuit of SDA (TXA) and RDA (RXA): Not available
8	OFF	Short-circuit of SDB (TXB) and RDB (RXB): Not available
9	OFF	RS (RTS) Auto control mode: Disabled
10	OFF	

RS-422/485 (2 wire)

DIP Switch	Setting	Description
1	OFF	Reserved (always OFF)
2	ON	SIO type: RS-422/485
3	ON	
4	OFF	Output mode of SD (TXD) data: Always output
5	OFF	Terminal resistance (220Ω) insertion to SD (TXD): None
6	OFF	Terminal resistance (220Ω) insertion to RD (RXD): None
7	ON	Short-circuit of SDA (TXA) and RDA (RXA): Available
8	ON	Short-circuit of SDB (TXB) and RDB (RXB): Available
9	ON	RS (RTS) Auto control mode: Enabled
10	ON	

2 Selection of External Device

Select the External Device to be connected to the Display.

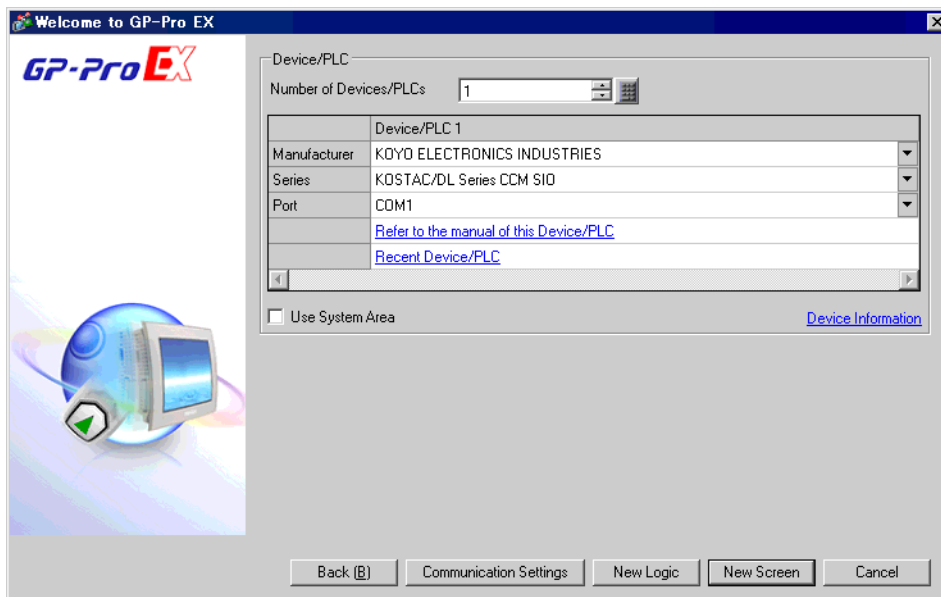

Setup Items	Setup Description
Number of Devices/ PLCs	Enter an integer from 1 to 4 to define the number of Devices/PLCs to connect to the display.
Manufacturer	Select the manufacturer of the External Device to connect. Select "KOYO ELECTRONICS INDUSTRIES".
Series	Select the External Device model (series) and the connection method. Select "KOSTAC/DL Series CCM SIO". In System configuration, make sure the External Device you are connecting is supported by "KOSTAC/DL Series CCM SIO". ☞ "1 System Configuration" (page 3)
Port	Select the Display port to connect to the External Device.
Use System Area	Check this option to synchronize the system data area of the Display and the device (memory) of the External Device. When synchronized, you can use the External Device's ladder program to switch the display or display the window on the Display. Cf. GP-Pro EX Reference Manual "LS Area (Direct Access Method Area)" This feature can also be set in GP-Pro EX or in the Display's offline mode. Cf. GP-Pro EX Reference Manual "System Settings [Display Unit] - [System Area] Settings Guide" Cf. Maintenance/Troubleshooting Guide "Main Unit - System Area Settings"

3 Example of Communication Setting

The following shows examples of communication settings of the Display and the External Device, which are recommended by Digital Electronics Corp.

3.1 Setting Example 1

■ Settings of GP-Pro EX

◆ Communication Settings

To display the setup screen, from the [Project] menu, point to [System Settings] and select [Device/PLC].

Device/PLC 1

Summary [Change Device/PLC](#)

Manufacturer: KOYD ELECTRONICS INDUSTRI Series: KOSTAC/DL Series CCM SIO Port: COM1

Text Data Mode: 1 [Change](#)

Communication Settings

SIO Type: RS232C RS422/485(2wire) RS422/485(4wire)

Speed: 19200

Data Length: 7 8

Parity: NONE EVEN ODD

Stop Bit: 1 2

Flow Control: NONE ER(DTR/CTS) XON/XOFF

Timeout: 3 (sec)

Retry: 2

Wait To Send: 0 (ms)

RI / VCC: RI VCC

In the case of RS232C, you can select the 9th pin to RI (Input) or VCC (5V Power Supply). If you use the Digital's RS232C Isolation Unit, please select it to VCC.

Default

Device-Specific Settings

Allowable Number of Devices/PLCs: 16 [Add Device](#)

No.	Device Name	Settings	Add Indirect Device
1	PLC1	Series=KOSTAC SG/SU/SZ Series, Station No=1	+

◆ Device Setting

To display the [Individual Device Settings] dialog box, from [Device-Specific Settings] in the [Device/PLC] window, select the external device and click [Settings] . To connect multiple External Devices, from [Device-Specific Settings] in the [Device/PLC] window, click [Add Device] to add another External Device.

Individual Device Settings

PLC1

Series: KOSTAC SG/SU/SZ Series

Please reconfirm all of address settings that you are using if you have changed the series.

Station No: 1

Default

OK (O) Cancel

■ Settings of External Device

For communication settings, use the DIP switches or the short plug on the side of the link I/F unit. After completing the settings, reboot the External Device to enable them. Please refer to the manual of the External Device for details.

◆ Configuration DIP Switch SW1

DIP Switch	Settings	Setup Description
1	ON	Child station No.: 1
2	OFF	
3	OFF	
4	OFF	
5	OFF	
6	OFF	
7	OFF	
8	OFF	Peer to Peer setting: 1:n mode
9	OFF	Master/Slave setting: Slave

◆ Configuration DIP Switch

DIP Switch	Settings	Setup Description
1	ON	Baud rate transmission speed: 19,200bps
2	ON	
3	ON	
4	ON	Parity enable/disable: Enabled (odd)
5	OFF	Self-diagnosis mode: OFF
6	OFF	Turnaround delay: None
7	OFF	Response delay time: 0 ms
8	OFF	
9	OFF	Transmission mode: HEX mode

◆ Short plug (2)

Short plug	Setup Description
232C ENABLE	SIO Type: RS232C

3.2 Setting Example 2

■ Settings of GP-Pro EX

◆ Communication Settings

To display the setup screen, from the [Project] menu, point to [System Settings] and select [Device/PLC].

Device/PLC 1

Summary [Change Device/PLC](#)

Manufacturer Series Port

Text Data Mode [Change](#)

Communication Settings

SIO Type RS232C RS422/485(2wire) RS422/485(4wire)

Speed

Data Length 7 8

Parity NONE EVEN ODD

Stop Bit 1 2

Flow Control NONE ER(DTR/CTS) XON/XOFF

Timeout (sec)

Retry

Wait To Send (ms)

RI / VCC RI VCC

In the case of RS232C, you can select the 9th pin to RI (Input) or VCC (5V Power Supply). If you use the Digital's RS232C Isolation Unit, please select it to VCC.

Device-Specific Settings

Allowable Number of Devices/PLCs [Add Device](#)

No.	Device Name	Settings	Add Indirect Device
<input type="button" value="1"/>	<input type="text" value="PLC1"/>	<input type="text" value="Series=KOSTAC SG/SU/SZ Series, Station No=1"/>	<input type="button" value="+"/>

◆ Device Setting

To display the [Individual Device Settings] dialog box, from [Device-Specific Settings] in the [Device/PLC] window, select the external device and click [Settings] . To connect multiple External Devices, from [Device-Specific Settings] in the [Device/PLC] window, click [Add Device] to add another External Device.

Individual Device Settings

PLC1

Series

Please reconfirm all of address settings that you are using if you have changed the series.

Station No

■ Settings of External Device

For communication settings, use the DIP switches or the short plug on the side of the link I/F unit. After completing the settings, reboot the External Device to enable them. Please refer to the manual of the External Device for details.

◆ Configuration DIP Switch SW1

DIP Switch	Settings	Setup Description
1	ON	Child station No.: 1
2	OFF	
3	OFF	
4	OFF	
5	OFF	
6	OFF	
7	OFF	
8	OFF	Peer to Peer setting: 1:n mode
9	OFF	Master/Slave setting: Slave

◆ Configuration DIP Switch

DIP Switch	Settings	Setup Description
1	ON	Baud rate transmission speed: 19,200bps
2	ON	
3	ON	
4	ON	Parity enable/disable: Enabled (odd)
5	OFF	Self-diagnosis mode: OFF
6	OFF	Turnaround delay: None
7	OFF	Response delay time: 0 ms
8	OFF	
9	OFF	Transmission mode: HEX mode

◆ Short plug (2)

Short plug	Setup Description
232C DISABLE	SIO Type: RS422

3.3 Setting Example 3

■ Settings of GP-Pro EX

◆ Communication Settings

To display the setup screen, from the [Project] menu, point to [System Settings] and select [Device/PLC].

Device/PLC 1

Summary [Change Device/PLC](#)

Manufacturer Series Port

Text Data Mode [Change](#)

Communication Settings

SIO Type RS232C RS422/485(2wire) RS422/485(4wire)

Speed

Data Length 7 8

Parity NONE EVEN ODD

Stop Bit 1 2

Flow Control NONE ER(DTR/CTS) XON/XOFF

Timeout (sec)

Retry

Wait To Send (ms)

RI / VCC RI VCC

In the case of RS232C, you can select the 9th pin to RI (Input) or VCC (5V Power Supply). If you use the Digital's RS232C Isolation Unit, please select it to VCC.

[Default](#)

Device-Specific Settings

Allowable Number of Devices/PLCs [Add Device](#)

No.	Device Name	Settings	Add Indirect Device
<input type="text" value="1"/>	<input type="text" value="PLC1"/>	<input type="text" value="Series=KOSTAC SG/SU/SZ Series, Station No=1"/>	<input type="button" value="+"/>

◆ Device Setting

To display the [Individual Device Settings] dialog box, from [Device-Specific Settings] in the [Device/PLC] window, select the external device and click [Settings] . To connect multiple External Devices, from [Device-Specific Settings] in the [Device/PLC] window, click [Add Device] to add another External Device.

Individual Device Settings

PLC1

Series

Please reconfirm all of address settings that you are using if you have changed the series.

Station No

[Default](#)

[OK \(O\)](#) [Cancel](#)

■ Settings of External Device

For communication settings, use the DIP switches on the CPU unit. To set the station No., use the instruction word programmer (S-01P). After completing the settings, reboot the External Device to enable them. Please refer to the manual of the External Device for details.

◆ Communication Setting Switch

DIP Switch	Settings	Setup Description
SW1	ON	SIO Type: RS232C
SW2	OFF	CCM station No. setting: Enabled
SW3	ON	Baud rate transmission speed: 19,200bps
SW4	ON	

NOTE

- Setting SW2 to ON switches the transmission mode to ASCII mode and thus disables communication. Make sure to set it to OFF and set the CCM station No. and transmission mode.

◆ CCM Station No. Setting

- 1 Select Menu 56. Press [Clear], [5], [6], [Menu], and then press the Enter key.
- 2 Enter the CCM station No. Press [0], [1], and then press the Enter key.

NOTE

- Enter the station No. set on the Display.

- 3 Set the transmission mode to "HEX", and then press the Enter key.

3.4 Setting Example 4

■ Settings of GP-Pro EX

◆ Communication Settings

To display the setup screen, from the [Project] menu, point to [System Settings] and select [Device/PLC].

Device/PLC 1

Summary [Change Device/PLC](#)

Manufacturer Series Port

Text Data Mode [Change](#)

Communication Settings

SIO Type RS232C RS422/485(2wire) RS422/485(4wire)

Speed

Data Length 7 8

Parity NONE EVEN ODD

Stop Bit 1 2

Flow Control NONE ER(DTR/CTS) XON/XOFF

Timeout (sec)

Retry

Wait To Send (ms)

RI / VCC RI VCC

In the case of RS232C, you can select the 9th pin to RI (Input) or VCC (5V Power Supply). If you use the Digital's RS232C Isolation Unit, please select it to VCC.

Device-Specific Settings

Allowable Number of Devices/PLCs [Add Device](#)

No.	Device Name	Settings	Add Indirect Device
<input type="button" value="1"/>	<input type="text" value="PLC1"/>	<input type="text" value="Series=KOSTAC SG/SU/SZ Series, Station No=1"/>	<input type="button" value="+"/>

◆ Device Setting

To display the [Individual Device Settings] dialog box, from [Device-Specific Settings] in the [Device/PLC] window, select the external device and click [Settings] . To connect multiple External Devices, from [Device-Specific Settings] in the [Device/PLC] window, click [Add Device] to add another External Device.

Individual Device Settings

PLC1

Series

Please reconfirm all of address settings that you are using if you have changed the series.

Station No

■ Settings of External Device

For communication settings, use the DIP switches on the CPU unit. To set the station No., use the instruction word programmer (S-01P). After completing the settings, reboot the External Device to enable them. Please refer to the manual of the External Device for details.

◆ Communication Setting Switch

DIP Switch	Settings	Setup Description
SW1	OFF	SIO Type: RS422
SW2	OFF	CCM station No. setting: Enabled
SW3	ON	Baud rate transmission speed: 19,200bps
SW4	ON	

NOTE

- Setting SW2 to ON switches the transmission mode to ASCII mode and thus disables communication. Make sure to set it to OFF and set the CCM station No. and transmission mode.

◆ CCM Station No. Setting

- 1 Select Menu 56. Press [Clear], [5], [6], [Menu], and then press the Enter key.
- 2 Enter the CCM station No. Press [0], [1], and then press the Enter key.

NOTE

- Enter the station No. set on the Display.

- 3 Set the transmission mode to "HEX", and then press the Enter key.

3.5 Setting Example 5

■ Settings of GP-Pro EX

◆ Communication Settings

To display the setup screen, from the [Project] menu, point to [System Settings] and select [Device/PLC].

◆ Device Setting

To display the [Individual Device Settings] dialog box, from [Device-Specific Settings] in the [Device/PLC] window, select the external device and click [Settings] . To connect multiple External Devices, from [Device-Specific Settings] in the [Device/PLC] window, click [Add Device] to add another External Device.

■ Settings of External Device

For communication settings, use the rotary switch on the front of the link I/F unit, or the DIP switches on its back. After completing the settings, reboot the External Device to enable them. Please refer to the manual of the External Device for details.

◆ Station No. Setting Rotary Switch

Rotary Switch	Settings	Setup Description
x10	0	Station No. of the External Device (tens digit)
x1	1	Station No. of the External Device (ones digit)

NOTE

- Enter the station No. set on the Display.

◆ Configuration DIP Switch SW4

DIP Switch	Settings	Setup Description
1	ON	Baud rate transmission speed: 19,200bps
2	ON	
3	ON	
4	ON	Parity enable/disable: Enabled (odd)
5	OFF	Self-diagnosis mode: OFF
6	OFF	Response delay time: 0 ms
7	OFF	
8	OFF	

◆ Configuration DIP Switch SW5

DIP Switch	Settings	Setup Description
1	OFF	Peer to Peer setting: 1:n mode
2	OFF	Master/Slave setting: Slave
3	OFF	Timeout enable/disable setting: Normal operation mode
4	OFF	Transmission mode: HEX mode

3.6 Setting Example 6

■ Settings of GP-Pro EX

◆ Communication Settings

To display the setup screen, from the [Project] menu, point to [System Settings] and select [Device/PLC].

Device/PLC 1

Summary [Change Device/PLC](#)

Manufacturer Series Port

Text Data Mode [Change](#)

Communication Settings

SID Type RS232C RS422/485(2wire) RS422/485(4wire)

Speed

Data Length 7 8

Parity NONE EVEN ODD

Stop Bit 1 2

Flow Control NONE ER(DTR/CTS) XON/XOFF

Timeout (sec)

Retry

Wait To Send (ms)

RI / VCC RI VCC

In the case of RS232C, you can select the 9th pin to RI (Input) or VCC (5V Power Supply). If you use the Digital's RS232C Isolation Unit, please select it to VCC.

Device-Specific Settings

Allowable Number of Devices/PLCs [Add Device](#)

No.	Device Name	Settings
<input type="button" value="1"/>	<input type="text" value="PLC1"/>	<input type="text" value="Series=KOSTAC SG/SU/SZ Series, Station No=1"/>

◆ Device Setting

To display the [Individual Device Settings] dialog box, from [Device-Specific Settings] in the [Device/PLC] window, select the external device and click [Settings] . To connect multiple External Devices, from [Device-Specific Settings] in the [Device/PLC] window, click [Add Device] to add another External Device.

Individual Device Settings

PLC1

Series

Please reconfirm all of address settings that you are using if you have changed the series.

Station No

■ Settings of External Device

For communication settings, use the rotary switch on the front of the link I/F unit, or the DIP switches on its back. After completing the settings, reboot the External Device to enable them. Please refer to the manual of the External Device for details.

◆ Station No. Setting Rotary Switch

Rotary Switch	Settings	Setup Description
x10	0	Station No. of the External Device (tens digit)
x1	1	Station No. of the External Device (ones digit)

NOTE

- Enter the station No. set on the Display.

◆ Configuration DIP Switch SW4

DIP Switch	Settings	Setup Description
1	ON	Baud rate transmission speed: 19,200bps
2	ON	
3	ON	
4	ON	Parity enable/disable: Enabled (odd)
5	OFF	Self-diagnosis mode: OFF
6	OFF	Response delay time: 0 ms
7	OFF	
8	OFF	

◆ Configuration DIP Switch SW5

DIP Switch	Settings	Setup Description
1	OFF	Peer to Peer setting: 1:n mode
2	OFF	Master/Slave setting: Slave
3	OFF	Timeout enable/disable setting: Normal operation mode
4	OFF	Transmission mode: HEX mode

3.7 Setting Example 7

■ Settings of GP-Pro EX

◆ Communication Settings

To display the setup screen, from the [Project] menu, point to [System Settings] and select [Device/PLC].

Device/PLC 1

Summary [Change Device/PLC](#)

Manufacturer Series Port

Text Data Mode [Change](#)

Communication Settings

SIO Type RS232C RS422/485(2wire) RS422/485(4wire)

Speed

Data Length 7 8

Parity NONE EVEN ODD

Stop Bit 1 2

Flow Control NONE ER(DTR/CTS) XON/XOFF

Timeout (sec)

Retry

Wait To Send (ms)

RI / VCC RI VCC

In the case of RS232C, you can select the 9th pin to RI (Input) or VCC (5V Power Supply). If you use the Digital's RS232C Isolation Unit, please select it to VCC.

[Default](#)

Device-Specific Settings

Allowable Number of Devices/PLCs [Add Device](#)

No.	Device Name	Settings	Add Indirect Device
<input type="text" value="1"/>	<input type="text" value="PLC1"/>	<input type="text" value="Series=KOSTAC SG/SU/SZ Series, Station No=1"/>	+

◆ Device Setting

To display the [Individual Device Settings] dialog box, from [Device-Specific Settings] in the [Device/PLC] window, select the external device and click [Settings] . To connect multiple External Devices, from [Device-Specific Settings] in the [Device/PLC] window, click [Add Device] to add another External Device.

Individual Device Settings

PLC1

Series

Please reconfirm all of address settings that you are using if you have changed the series.

Station No

[Default](#)

[OK \(O\)](#) [Cancel](#)

■ Settings of External Device

For communication settings, use the DIP switches on the CPU unit. To set the station No., use the instruction word programmer (S-01P). After completing the settings, reboot the External Device to enable them. Please refer to the manual of the External Device for details.

◆ Communication Setting Switch

DIP Switch	Settings	Setup Description
SW1	Optional	Battery mode: Adjust to the system.
SW2	OFF	CCM station No. setting: Enabled
SW3	ON	Baud rate transmission speed: 19,200bps
SW4	ON	

NOTE

- Setting SW2 to ON switches the transmission mode to ASCII mode and thus disables communication. Make sure to set it to OFF and set the CCM station No. and transmission mode.

◆ CCM Station No. Setting

- 1 Select Menu 56. Press [Clear], [5], [6], [Menu], and then press the Enter key.
- 2 Enter the CCM station No. Press [0], [1], and then press the Enter key.

NOTE

- Enter the station No. set on the Display.

- 3 Set the transmission mode to "HEX", and then press the Enter key.
- 4 Set the parity to "ODD", and then press the Enter key.

3.8 Setting Example 8

■ Settings of GP-Pro EX

◆ Communication Settings

To display the setup screen, from the [Project] menu, point to [System Settings] and select [Device/PLC].

Device/PLC 1

Summary [Change Device/PLC](#)

Manufacturer Series Port

Text Data Mode [Change](#)

Communication Settings

SIO Type RS232C RS422/485(2wire) RS422/485(4wire)

Speed

Data Length 7 8

Parity NONE EVEN ODD

Stop Bit 1 2

Flow Control NONE ER(DTR/CTS) XON/XOFF

Timeout (sec)

Retry

Wait To Send (ms)

RI / VCC RI VCC

In the case of RS232C, you can select the 9th pin to RI (Input) or VCC (5V Power Supply). If you use the Digital's RS232C Isolation Unit, please select it to VCC.

Device-Specific Settings

Allowable Number of Devices/PLCs [Add Device](#)

No.	Device Name	Settings	Add Indirect Device
<input type="button" value="1"/>	<input type="text" value="PLC1"/>	<input type="text" value="Series=KOSTAC SG/SU/SZ Series, Station No=1"/>	<input type="button" value="+"/>

◆ Device Setting

To display the [Individual Device Settings] dialog box, from [Device-Specific Settings] in the [Device/PLC] window, select the external device and click [Settings] . To connect multiple External Devices, from [Device-Specific Settings] in the [Device/PLC] window, click [Add Device] to add another External Device.

Individual Device Settings

PLC1

Series

Please reconfirm all of address settings that you are using if you have changed the series.

Station No

■ Settings of External Device

For communication settings, use the DIP switches on the CPU unit. To set the station No., use the instruction word programmer (S-01P). After completing the settings, reboot the External Device to enable them. Please refer to the manual of the External Device for details.

◆ Communication Setting Switch

DIP Switch	Settings	Setup Description
SW1	Optional	Battery mode: Adjust to the system.
SW2	OFF	CCM station No. setting: Enabled
SW3	ON	Baud rate transmission speed: 19,200bps
SW4	ON	

NOTE

- Setting SW2 to ON switches the transmission mode to ASCII mode and thus disables communication. Make sure to set it to OFF and set the CCM station No. and transmission mode.

◆ CCM Station No. Setting

- 1 Select Menu 56. Press [Clear], [5], [6], [Menu], and then press the Enter key.
- 2 Enter the CCM station No. Press [0], [1], and then press the Enter key.

NOTE

- Enter the station No. set on the Display.

- 3 Set the transmission mode to "HEX", and then press the Enter key.
- 4 Set the parity to "ODD", and then press the Enter key.

3.9 Setting Example 9

■ Settings of GP-Pro EX

◆ Communication Settings

To display the setup screen, from the [Project] menu, point to [System Settings] and select [Device/PLC].

Device/PLC 1

Summary [Change Device/PLC](#)

Manufacturer Series Port

Text Data Mode [Change](#)

Communication Settings

SID Type RS232C RS422/485(2wire) RS422/485(4wire)

Speed

Data Length 7 8

Parity NONE EVEN ODD

Stop Bit 1 2

Flow Control NONE ER(DTR/CTS) XON/XOFF

Timeout (sec)

Retry

Wait To Send (ms)

RI / VCC RI VCC

In the case of RS232C, you can select the 9th pin to RI (Input) or VCC (5V Power Supply). If you use the Digital's RS232C Isolation Unit, please select it to VCC.

Device-Specific Settings

Allowable Number of Devices/PLCs [Add Device](#)

No.	Device Name	Settings	Add Indirect Device
<input type="button" value="1"/>	<input type="text" value="PLC1"/>	<input type="text" value="Series=KOSTAC SG/SU/SZ Series, Station No=1"/>	<input type="button" value="+"/>

◆ Device Setting

To display the [Individual Device Settings] dialog box, from [Device-Specific Settings] in the [Device/PLC] window, select the external device and click [Settings] . To connect multiple External Devices, from [Device-Specific Settings] in the [Device/PLC] window, click [Add Device] to add another External Device.

Individual Device Settings

PLC1

Series

Please reconfirm all of address settings that you are using if you have changed the series.

Station No

■ Settings of External Device

For communication settings, use the programmable controller. After completing the settings, reboot the External Device to enable them. Please refer to the manual of the External Device for details.

Configure the settings for general-purpose communication port 1 in the following special register.

Special Register	Setup Items	Setting Value	Input Value
R772	Response delay time	0 ms	CCM: 0040 Auto-detect: 00E0
	Communication timeout	0 ms	
	Communication protocol	CCM or Auto-detect	
R773	Parity	Odd	8601
	Stop bit	1	
	Communication speed	19,200 bps	
	Communication station number	1	

- 1 On the External Device, set the mode switch to "TERM" and with the programmable controller connected to the programmer port, turn on the External Device.
- 2 Press the [Clear] key so that nothing is displayed in the message display area.
- 3 Press the [REG] key and enter "772". "R772" appears in the message display area.
- 4 Press the [R monitor] key. The current value of special register R772 appears in the message display area.
- 5 Press the [K(CON)] key, enter "0040" (CCM protocol) or "00E0" (auto-detect), and then press the [↵] key.
- 6 Repeat the operation to display the current value of special register R773.
- 7 Press the [K(CON)] key, enter "8601" and then press the [↵] key.
- 8 Repeat the operation to display the current value of the communication parameter in R767.
- 9 Press the [K(CON)] key, enter "AA5A" and then press the [↵] key. If the setting is completed successfully, the value changes to "AAAA".

3.10 Setting Example 10

■ Settings of GP-Pro EX

◆ Communication Settings

To display the setup screen, from the [Project] menu, point to [System Settings] and select [Device/PLC].

◆ Device Setting

To display the [Individual Device Settings] dialog box, from [Device-Specific Settings] in the [Device/PLC] window, select the external device and click [Settings] . To connect multiple External Devices, from [Device-Specific Settings] in the [Device/PLC] window, click [Add Device] to add another External Device.

■ Settings of External Device

For communication settings, use the programmable controller. After completing the settings, reboot the External Device to enable them. Please refer to the manual of the External Device for details.

Configure the settings for general-purpose communication port 1 in the following special register.

Special Register	Setup Items	Setting Value	Input Value
R772	Response delay time	0 ms	CCM: 0040 Auto-detect: 00E0
	Communication timeout	0 ms	
	Communication protocol	CCM or Auto-detect	
R773	Parity	Odd	8601
	Stop bit	1	
	Communication speed	19,200 bps	
	Communication station number	1	

- 1 On the External Device, set the mode switch to "TERM" and with the programmable controller connected to the programmer port, turn on the External Device.
- 2 Press the [Clear] key so that nothing is displayed in the message display area.
- 3 Press the [REG] key and enter "772". "R772" appears in the message display area.
- 4 Press the [R monitor] key. The current value of special register R772 appears in the message display area.
- 5 Press the [K(CON)] key, enter "0040" (CCM protocol) or "00E0" (auto-detect), and then press the [↵] key.
- 6 Repeat the operation to display the current value of special register R773.
- 7 Press the [K(CON)] key, enter "8601" and then press the [↵] key.
- 8 Repeat the operation to display the current value of the communication parameter in R767.
- 9 Press the [K(CON)] key, enter "AA5A" and then press the [↵] key. If the setting is completed successfully, the value changes to "AAAA".

3.11 Setting Example 11

■ Settings of GP-Pro EX

◆ Communication Settings

To display the setup screen, from the [Project] menu, point to [System Settings] and select [Device/PLC].

◆ Device Setting

To display the [Individual Device Settings] dialog box, from [Device-Specific Settings] in the [Device/PLC] window, select the external device and click [Settings] . To connect multiple External Devices, from [Device-Specific Settings] in the [Device/PLC] window, click [Add Device] to add another External Device.

■ Settings of External Device

For communication settings, use the programmable controller. After completing the settings, reboot the External Device to enable them. Please refer to the manual of the External Device for details.

Configure the settings for general-purpose communication port 2 in the following special register.

Special Register	Setup Items	Setting Value	Input Value
R774	Response delay time	0 ms	CCM: 0040 Auto-detect: 00E0
	Communication timeout	0 ms	
	Communication protocol	CCM or Auto-detect	
R775	Parity	Odd	8601
	Stop bit	1	
	Communication speed	19,200 bps	
	Communication station number	1	

- 1 On the External Device, set the mode switch to "TERM" and with the programmable controller connected to the programmer port, turn on the External Device.
- 2 Press the [Clear] key so that nothing is displayed in the message display area.
- 3 Press the [REG] key and enter "774". "R774" appears in the message display area.
- 4 Press the [R monitor] key. The current value of special register R774 appears in the message display area.
- 5 Press the [K(CON)] key, enter "0040" (CCM protocol) or "00E0" (auto-detect), and then press the [↵] key.
- 6 Repeat the operation to display the current value of special register R775.
- 7 Press the [K(CON)] key, enter "8601" and then press the [↵] key.
- 8 Repeat the operation to display the current value of the communication parameter in R767.
- 9 Press the [K(CON)] key, enter "A5AA" and then press the [↵] key. If the setting is completed successfully, the value changes to "AAAA".

3.12 Setting Example 12

■ Settings of GP-Pro EX

◆ Communication Settings

To display the setup screen, from the [Project] menu, point to [System Settings] and select [Device/PLC].

Device/PLC 1

Summary [Change Device/PLC](#)

Manufacturer Series Port

Text Data Mode [Change](#)

Communication Settings

SIO Type RS232C RS422/485(2wire) RS422/485(4wire)

Speed

Data Length 7 8

Parity NONE EVEN ODD

Stop Bit 1 2

Flow Control NONE ER(DTR/CTS) XON/XOFF

Timeout (sec)

Retry

Wait To Send (ms)

RI / VCC RI VCC

In the case of RS232C, you can select the 9th pin to RI (Input) or VCC (5V Power Supply). If you use the Digital's RS232C Isolation Unit, please select it to VCC.

[Default](#)

Device-Specific Settings

Allowable Number of Devices/PLCs [Add Device](#)

No.	Device Name	Settings	Add Indirect Device
<input type="text" value="1"/>	<input type="text" value="PLC1"/>	<input type="text" value="Series=KOSTAC SG/SU/SZ Series, Station No=1"/>	<input type="button" value="+"/>

◆ Device Setting

To display the [Individual Device Settings] dialog box, from [Device-Specific Settings] in the [Device/PLC] window, select the external device and click [Settings] . To connect multiple External Devices, from [Device-Specific Settings] in the [Device/PLC] window, click [Add Device] to add another External Device.

Individual Device Settings

PLC1

Series

Please reconfirm all of address settings that you are using if you have changed the series.

Station No

[Default](#)

[OK \(O\)](#) [Cancel](#)

■ Settings of External Device

For communication settings, use the instruction word programmer (S-01P). After completing the settings, reboot the External Device to enable them. Please refer to the manual of the External Device for details.

NOTE

- Set the mode selector switch to TERM in the setup process.
-

◆ CCM Station No. Setting

- 1 Select Menu 56. Press [Clear], [5], [6], [Menu], and then press the Enter key.
- 2 Enter the CCM station No. Press [0], [1], and then press the Enter key.

NOTE

- Enter the station No. set on the Display.
-

- 3 Set the transmission mode to "HEX", and then press the Enter key.
- 4 Set the parity to "ODD", and then press the Enter key.
- 5 Set the transmission speed to "19200", and then press the Enter key.

3.13 Setting Example 13

■ Settings of GP-Pro EX

◆ Communication Settings

To display the setup screen, from the [Project] menu, point to [System Settings] and select [Device/PLC].

Device/PLC 1

Summary [Change Device/PLC](#)

Manufacturer Series Port

Text Data Mode [Change](#)

Communication Settings

SID Type RS232C RS422/485(2wire) RS422/485(4wire)

Speed

Data Length 7 8

Parity NONE EVEN ODD

Stop Bit 1 2

Flow Control NONE ER(DTR/CTS) XON/XOFF

Timeout (sec)

Retry

Wait To Send (ms)

RI / VCC RI VCC

In the case of RS232C, you can select the 9th pin to RI (Input) or VCC (5V Power Supply). If you use the Digital's RS232C Isolation Unit, please select it to VCC.

Device-Specific Settings

Allowable Number of Devices/PLCs [Add Device](#)

No.	Device Name	Settings
<input type="button" value="1"/>	<input type="text" value="PLC1"/>	<input type="text" value="Series=KOSTAC SR Series, Station No=1"/>

◆ Device Setting

To display the [Individual Device Settings] dialog box, from [Device-Specific Settings] in the [Device/PLC] window, select the external device and click [Settings] . To connect multiple External Devices, from [Device-Specific Settings] in the [Device/PLC] window, click [Add Device] to add another External Device.

Individual Device Settings

PLC1

Series

Please reconfirm all of address settings that you are using if you have changed the series.

Station No

■ Settings of External Device

For communication settings, use the DIP switches on the side of the link I/F unit. After completing the settings, reboot the External Device to enable them. Please refer to the manual of the External Device for details.

◆ Configuration DIP Switch SW1

DIP Switch	Settings	Setup Description
1	ON	Baud rate transmission speed: 19,200bps
2	ON	
3	OFF	Parity enable/disable: Disabled
4	ON	Self-diagnosis mode: OFF
5	OFF	Turnaround delay: None
6	OFF	Power-on mode: Adjust to the system.
7	OFF	Always OFF
8	OFF	Transmission mode: HEX mode

◆ Configuration DIP Switch SW2

DIP Switch	Settings	Setup Description
1	ON	Child station No.: 1
2	OFF	
3	OFF	
4	OFF	
5	OFF	
6	OFF	
7	OFF	
8	OFF	Always OFF

3.14 Setting Example 14

■ Settings of GP-Pro EX

◆ Communication Settings

To display the setup screen, from the [Project] menu, point to [System Settings] and select [Device/PLC].

◆ Device Setting

To display the [Individual Device Settings] dialog box, from [Device-Specific Settings] in the [Device/PLC] window, select the external device and click [Settings] . To connect multiple External Devices, from [Device-Specific Settings] in the [Device/PLC] window, click [Add Device] to add another External Device.

■ Settings of External Device

For communication settings, use the instruction word programmer (S-01P). After completing the settings, reboot the External Device to enable them. Please refer to the manual of the External Device for details.

NOTE

- Set the mode selector switch to TERM in the setup process.
-

◆ CCM Station No. Setting

- 1 Select Menu 56. Press [Clear], [5], [6], [Menu], and then press the Enter key.
- 2 Enter the CCM station No. Press [0], [1], and then press the Enter key.

NOTE

- Enter the station No. set on the Display.
-

- 3 Set the transmission mode to "HEX", and then press the Enter key.
- 4 Set the parity to "ODD", and then press the Enter key.
- 5 Set the transmission speed to "19200", and then press the Enter key.

3.15 Setting Example 15

■ Settings of GP-Pro EX

◆ Communication Settings

To display the setup screen, from the [Project] menu, point to [System Settings] and select [Device/PLC].

Device/PLC 1

Summary [Change Device/PLC](#)

Manufacturer Series Port

Text Data Mode [Change](#)

Communication Settings

SIO Type RS232C RS422/485(2wire) RS422/485(4wire)

Speed

Data Length 7 8

Parity NONE EVEN ODD

Stop Bit 1 2

Flow Control NONE ER(DTR/CTS) XON/XOFF

Timeout (sec)

Retry

Wait To Send (ms)

RI / VCC RI VCC

In the case of RS232C, you can select the 9th pin to RI (Input) or VCC (5V Power Supply). If you use the Digital's RS232C Isolation Unit, please select it to VCC.

Device-Specific Settings

Allowable Number of Devices/PLCs 16 [Add Device](#)

No.	Device Name	Settings
1	PLC1	Series=DL-205/DL-405 Series, Station No=1

◆ Device Setting

To display the [Individual Device Settings] dialog box, from [Device-Specific Settings] in the [Device/PLC] window, select the external device and click [Settings] . To connect multiple External Devices, from [Device-Specific Settings] in the [Device/PLC] window, click [Add Device] to add another External Device.

Individual Device Settings

PLC1

Series

Please reconfirm all of address settings that you are using if you have changed the series.

Station No

■ Settings of External Device

For communication settings, use the instruction word programmer (S-01P). After completing the settings, reboot the External Device to enable them. Please refer to the manual of the External Device for details.

NOTE

- Set the mode selector switch to TERM in the setup process.
-

◆ CCM Station No. Setting

- 1 Select Menu 56. Press [Clear], [5], [6], [Menu], and then press the Enter key.
- 2 Enter the CCM station No. Press [0], [1], and then press the Enter key.

NOTE

- Enter the station No. set on the Display.
-

- 3 Set the transmission mode to "HEX", and then press the Enter key.
- 4 Set the parity to "ODD", and then press the Enter key.
- 5 Set the transmission speed to "19200", and then press the Enter key.

3.16 Setting Example 16

■ Settings of GP-Pro EX

◆ Communication Settings

To display the setup screen, from the [Project] menu, point to [System Settings] and select [Device/PLC].

Device/PLC 1

Summary [Change Device/PLC](#)

Manufacturer Series Port

Text Data Mode [Change](#)

Communication Settings

SIO Type RS232C RS422/485(2wire) RS422/485(4wire)

Speed

Data Length 7 8

Parity NONE EVEN ODD

Stop Bit 1 2

Flow Control NONE ER(DTR/CTS) XON/XOFF

Timeout (sec)

Retry

Wait To Send (ms)

RI / VCC RI VCC

In the case of RS232C, you can select the 9th pin to RI (Input) or VCC (5V Power Supply). If you use the Digital's RS232C Isolation Unit, please select it to VCC.

Device-Specific Settings

Allowable Number of Devices/PLCs [Add Device](#)

No.	Device Name	Settings
<input type="button" value="1"/>	<input type="text" value="PLC1"/>	<input type="text" value="Series=DL-205/DL-405 Series, Station No=1"/>

◆ Device Setting

To display the [Individual Device Settings] dialog box, from [Device-Specific Settings] in the [Device/PLC] window, select the external device and click [Settings] . To connect multiple External Devices, from [Device-Specific Settings] in the [Device/PLC] window, click [Add Device] to add another External Device.

Individual Device Settings

PLC1

Series

Please reconfirm all of address settings that you are using if you have changed the series.

Station No

■ Settings of External Device

For communication settings, use the rotary switch on the front of the link I/F unit, or the DIP switches on its back. After completing the settings, reboot the External Device to enable them. Please refer to the manual of the External Device for details.

◆ Station No. Setting Rotary Switch

Rotary Switch	Settings	Setup Description
x10	0	Station No. of the External Device (tens digit)
x1	1	Station No. of the External Device (ones digit)

NOTE

- Enter the station No. set on the Display.

◆ Configuration DIP Switch SW4

DIP Switch	Settings	Setup Description
1	ON	Baud rate transmission speed: 19,200bps
2	ON	
3	ON	
4	ON	Parity enable/disable: Enabled (odd)
5	OFF	Self-diagnosis mode: OFF
6	OFF	Response delay time: 0 ms
7	OFF	
8	OFF	

◆ Configuration DIP Switch SW5

DIP Switch	Settings	Setup Description
1	OFF	Peer to Peer setting: 1:n mode
2	OFF	Master/Slave setting: Slave
3	OFF	Timeout enable/disable setting: Normal operation mode
4	OFF	Transmission mode: HEX mode

3.17 Setting Example 17

■ Settings of GP-Pro EX

◆ Communication Settings

To display the setup screen, from the [Project] menu, point to [System Settings] and select [Device/PLC].

◆ Device Setting

To display the [Individual Device Settings] dialog box, from [Device-Specific Settings] in the [Device/PLC] window, select the external device and click [Settings] . To connect multiple External Devices, from [Device-Specific Settings] in the [Device/PLC] window, click [Add Device] to add another External Device.

■ Settings of External Device

For communication settings, use the rotary switch on the front of the link I/F unit, or the DIP switches on its back. After completing the settings, reboot the External Device to enable them. Please refer to the manual of the External Device for details.

◆ Station No. Setting Rotary Switch

Rotary Switch	Settings	Setup Description
x10	0	Station No. of the External Device (tens digit)
x1	1	Station No. of the External Device (ones digit)

NOTE

- Enter the station No. set on the Display.

◆ Configuration DIP Switch SW4

DIP Switch	Settings	Setup Description
1	ON	Baud rate transmission speed: 19,200bps
2	ON	
3	ON	
4	ON	Parity enable/disable: Enabled (odd)
5	OFF	Self-diagnosis mode: OFF
6	OFF	Response delay time: 0 ms
7	OFF	
8	OFF	

◆ Configuration DIP Switch SW5

DIP Switch	Settings	Setup Description
1	OFF	Peer to Peer setting: 1:n mode
2	OFF	Master/Slave setting: Slave
3	OFF	Timeout enable/disable setting: Normal operation mode
4	OFF	Transmission mode: HEX mode

3.18 Setting Example 18

■ Settings of GP-Pro EX

◆ Communication Settings

To display the setup screen, from the [Project] menu, point to [System Settings] and select [Device/PLC].

◆ Device Setting

To display the [Individual Device Settings] dialog box, from [Device-Specific Settings] in the [Device/PLC] window, select the external device and click [Settings] . To connect multiple External Devices, from [Device-Specific Settings] in the [Device/PLC] window, click [Add Device] to add another External Device.

■ Settings of External Device

For communication settings, use the DIP switches on the CPU unit. To set the station No., use the instruction word programmer (S-01P). After completing the settings, reboot the External Device to enable them. Please refer to the manual of the External Device for details.

◆ Communication Setting Switch

DIP Switch	Settings	Setup Description
SW1	Optional	Battery mode: Adjust to the system.
SW2	OFF	CCM station No. setting: Enabled
SW3	ON	Baud rate transmission speed: 19,200bps
SW4	ON	

NOTE

- Setting SW2 to ON switches the transmission mode to ASCII mode and thus disables communication. Make sure to set it to OFF and set the CCM station No. and transmission mode.

◆ CCM Station No. Setting

- 1 Select Menu 56. Press [Clear], [5], [6], [Menu], and then press the Enter key.
- 2 Enter the CCM station No. Press [0], [1], and then press the Enter key.

NOTE

- Enter the station No. set on the Display.

- 3 Set the transmission mode to "HEX", and then press the Enter key.
- 4 Set the parity to "ODD", and then press the Enter key.

3.19 Setting Example 19

■ Settings of GP-Pro EX

◆ Communication Settings

To display the setup screen, from the [Project] menu, point to [System Settings] and select [Device/PLC].

◆ Device Setting

To display the [Individual Device Settings] dialog box, from [Device-Specific Settings] in the [Device/PLC] window, select the external device and click [Settings] . To connect multiple External Devices, from [Device-Specific Settings] in the [Device/PLC] window, click [Add Device] to add another External Device.

■ Settings of External Device

For communication settings, use the DIP switches on the CPU unit. To set the station No., use the instruction word programmer (S-01P). After completing the settings, reboot the External Device to enable them. Please refer to the manual of the External Device for details.

◆ Communication Setting Switch

DIP Switch	Settings	Setup Description
SW1	Optional	Battery mode: Adjust to the system.
SW2	OFF	CCM station No. setting: Enabled
SW3	ON	Baud rate transmission speed: 19,200bps
SW4	ON	

NOTE

- Setting SW2 to ON switches the transmission mode to ASCII mode and thus disables communication. Make sure to set it to OFF and set the CCM station No. and transmission mode.

◆ CCM Station No. Setting

- 1 Select Menu 56. Press [Clear], [5], [6], [Menu], and then press the Enter key.
- 2 Enter the CCM station No. Press [0], [1], and then press the Enter key.

NOTE

- Enter the station No. set on the Display.

- 3 Set the transmission mode to "HEX", and then press the Enter key.
- 4 Set the parity to "ODD", and then press the Enter key.

3.20 Setting Example 20

■ Settings of GP-Pro EX

◆ Communication Settings

To display the setup screen, from the [Project] menu, point to [System Settings] and select [Device/PLC].

Device/PLC 1

Summary [Change Device/PLC](#)

Manufacturer Series Port

Text Data Mode [Change](#)

Communication Settings

SID Type RS232C RS422/485(2wire) RS422/485(4wire)

Speed

Data Length 7 8

Parity NONE EVEN ODD

Stop Bit 1 2

Flow Control NONE ER(DTR/CTS) XON/XOFF

Timeout (sec)

Retry

Wait To Send (ms)

RI / VCC RI VCC

In the case of RS232C, you can select the 9th pin to RI (Input) or VCC (5V Power Supply). If you use the Digital's RS232C Isolation Unit, please select it to VCC.

Device-Specific Settings

Allowable Number of Devices/PLCs [Add Device](#)

No.	Device Name	Settings
<input type="button" value="1"/>	<input type="text" value="PLC1"/>	<input type="text" value="Series=DL-305 Series, Station No=1"/>

◆ Device Setting

To display the [Individual Device Settings] dialog box, from [Device-Specific Settings] in the [Device/PLC] window, select the external device and click [Settings] . To connect multiple External Devices, from [Device-Specific Settings] in the [Device/PLC] window, click [Add Device] to add another External Device.

Individual Device Settings

PLC1

Series

Please reconfirm all of address settings that you are using if you have changed the series.

Station No

■ Settings of External Device

For communication settings, use the DIP switches on the side of the link I/F unit. After completing the settings, reboot the External Device to enable them. Please refer to the manual of the External Device for details.

◆ Configuration DIP Switch SW1

DIP Switch	Settings	Setup Description
1	ON	Baud rate transmission speed: 19,200bps
2	ON	
3	OFF	Parity enable/disable: Disabled
4	ON	Self-diagnosis mode: OFF
5	OFF	Turnaround delay: None
6	OFF	Power-on mode: Adjust to the system.
7	OFF	Always OFF
8	OFF	Transmission mode: HEX mode

◆ Configuration DIP Switch SW2

DIP Switch	Settings	Setup Description
1	ON	Child station No.: 1
2	OFF	
3	OFF	
4	OFF	
5	OFF	
6	OFF	
7	OFF	
8	OFF	Always OFF

3.21 Setting Example 21

■ Settings of GP-Pro EX

◆ Communication Settings

To display the setup screen, from the [Project] menu, point to [System Settings] and select [Device/PLC].

Device/PLC 1

Summary [Change Device/PLC](#)

Manufacturer Series Port

Text Data Mode [Change](#)

Communication Settings

SID Type RS232C RS422/485(2wire) RS422/485(4wire)

Speed

Data Length 7 8

Parity NONE EVEN ODD

Stop Bit 1 2

Flow Control NONE ER(DTR/CTS) XON/XOFF

Timeout (sec)

Retry

Wait To Send (ms)

RI / VCC RI VCC

In the case of RS232C, you can select the 9th pin to RI (Input) or VCC (5V Power Supply). If you use the Digital's RS232C Isolation Unit, please select it to VCC.

[Default](#)

Device-Specific Settings

Allowable Number of Devices/PLCs [Add Device](#)

No.	Device Name	Settings	Add Indirect Device
<input type="text" value="1"/>	<input type="text" value="PLC1"/>	<input type="text" value="Series=KOSTAC SG/SU/SZ Series, Station No=1"/>	+

◆ Device Setting

To display the [Individual Device Settings] dialog box, from [Device-Specific Settings] in the [Device/PLC] window, select the external device and click [Settings] . To connect multiple External Devices, from [Device-Specific Settings] in the [Device/PLC] window, click [Add Device] to add another External Device.

Individual Device Settings

PLC1

Series

Please reconfirm all of address settings that you are using if you have changed the series.

Station No

[Default](#)

[OK \(O\)](#) [Cancel](#)

■ Settings of External Device

For communication settings, use the instruction word programmer (Z-20JP). After completing the settings, reboot the External Device to enable them. Please refer to the manual of the External Device for details.

- 1 Select Menu 56. Press [Clear], [5], [6], [Menu], and then press the Enter key.
- 2 Set the protocol to "CCM2", and then press the Enter key.
- 3 Enter the CCM station No. Press [0], [1], and then press the Enter key.

NOTE

- Enter the station No. set on the Display.
-

- 4 Set the transmission mode to "HEX", and then press the Enter key.
- 5 Set the transmission speed to "19200", and then press the Enter key.
- 6 Set the stop bit to "1", and then press the Enter key.
- 7 Set the parity to "ODD", and then press the Enter key.

3.22 Setting Example 22

■ Settings of GP-Pro EX

◆ Communication Settings

To display the setup screen, from the [Project] menu, point to [System Settings] and select [Device/PLC].

◆ Device Setting

To display the [Individual Device Settings] dialog box, from [Device-Specific Settings] in the [Device/PLC] window, select the external device and click [Settings] . To connect multiple External Devices, from [Device-Specific Settings] in the [Device/PLC] window, click [Add Device] to add another External Device.

■ Settings of External Device

The communication device does not require any communication settings.

The baud rate transmission speed and the station address are fixed.

The parity, data length, and stop bit also cannot be changed.

3.23 Setting Example 23

■ Settings of GP-Pro EX

◆ Communication Settings

To display the setup screen, from the [Project] menu, point to [System Settings] and select [Device/PLC].

◆ Device Setting

To display the [Individual Device Settings] dialog box, from [Device-Specific Settings] in the [Device/PLC] window, select the external device and click [Settings] . To connect multiple External Devices, from [Device-Specific Settings] in the [Device/PLC] window, click [Add Device] to add another External Device.

■ Settings of External Device

Use the ladder software (DirectSOFT32 programming version 4.0) for communication settings. After completing the settings, reboot the External Device to enable them. Please refer to the manual of the External Device for details.

- 1 Start the ladder software (DirectSOFT32) and go online with the External Device.
- 2 From the [PLC] menu, select [Settings] - [General-purpose port settings].
- 3 In the [Communication port settings] dialog box, configure the following communication settings.

Item	Settings
Port	Port 2
Protocol	CCM Net (DirectNET)
Timeout	500 ms
RTS on Delay Time	20 ms
Station No.	1
Speed	19,200bps
Stop Bit	1
Parity	Odd
Data Format	Hex

- 4 When the settings are complete, click [Transfer] to transfer them to the External Device.

3.24 Setting Example 24

■ Settings of GP-Pro EX

◆ Communication Settings

To display the setup screen, from the [Project] menu, point to [System Settings] and select [Device/PLC].

Device/PLC 1

Summary [Change Device/PLC](#)

Manufacturer Series Port

Text Data Mode [Change](#)

Communication Settings

SIO Type RS232C RS422/485(2wire) RS422/485(4wire)

Speed

Data Length 7 8

Parity NONE EVEN ODD

Stop Bit 1 2

Flow Control NONE ER(DTR/CTS) XON/XOFF

Timeout (sec)

Retry

Wait To Send (ms)

RI / VCC RI VCC

In the case of RS232C, you can select the 9th pin to RI (Input) or VCC (5V Power Supply). If you use the Digital's RS232C Isolation Unit, please select it to VCC.

[Default](#)

Device-Specific Settings

Allowable Number of Devices/PLCs [Add Device](#)

No.	Device Name	Settings
<input type="text" value="1"/>	<input type="text" value="PLC1"/>	<input type="text" value="Series=KOSTAC SG/SU/SZ Series, Station No=1"/>

[Add Indirect Device](#)

◆ Device Setting

To display the [Individual Device Settings] dialog box, from [Device-Specific Settings] in the [Device/PLC] window, select the external device and click [Settings] . To connect multiple External Devices, from [Device-Specific Settings] in the [Device/PLC] window, click [Add Device] to add another External Device.

Individual Device Settings

PLC1

Series

Please reconfirm all of address settings that you are using if you have changed the series.

Station No

[Default](#)

[OK \(O\)](#) [Cancel](#)

■ Settings of External Device

Use the ladder software (DirectSOFT32 programming version 4.0) for communication settings. After completing the settings, reboot the External Device to enable them. Please refer to the manual of the External Device for details.

- 1 Start the ladder software (DirectSOFT32) and go online with the External Device.
- 2 From the [PLC] menu, select [Settings] - [General-purpose port settings].
- 3 In the [Communication port settings] dialog box, configure the following communication settings.

Item	Settings
Port	Port 2
Protocol	CCM Net (DirectNET)
Timeout	500 ms
RTS on Delay Time	20 ms
Station No.	1
Speed	19,200bps
Stop Bit	1
Parity	Odd
Data Format	Hex

- 4 When the settings are complete, click [Transfer] to transfer them to the External Device.

3.25 Setting Example 25

■ Settings of GP-Pro EX

◆ Communication Settings

To display the setup screen, from the [Project] menu, point to [System Settings] and select [Device/PLC].

◆ Device Setting

To display the [Individual Device Settings] dialog box, from [Device-Specific Settings] in the [Device/PLC] window, select the external device and click [Settings] . To connect multiple External Devices, from [Device-Specific Settings] in the [Device/PLC] window, click [Add Device] to add another External Device.

■ Settings of External Device

Use the KOYO PLC Programming Software for communication settings.

Please refer to the manual of the External Device for details.

- 1 Set the Keyswitch Mode of the External Device to "TERM".
- 2 Connect the PC to the general-purpose communication port of the External Device.
- 3 In the KOYO PLC Programming Software, select "New File" from the File menu.
- 4 Select the model of the External Device to use.
- 5 In the PLC View Window, select [PLC] → [PLC Setup] → [COM Port Setup].
- 6 Set the connection parameters between the PC and the External Device.
- 7 Click [Connection Test].
- 8 Select [PLC] → [PLC Setup] → [COM Port Setup].
- 9 Set the port parameters.
- 10 Click [Write PLC].

3.26 Setting Example 26

■ Settings of GP-Pro EX

◆ Communication Settings

To display the setup screen, from the [Project] menu, point to [System Settings] and select [Device/PLC].

◆ Device Setting

To display the [Individual Device Settings] dialog box, from [Device-Specific Settings] in the [Device/PLC] window, select the external device and click [Settings] . To connect multiple External Devices, from [Device-Specific Settings] in the [Device/PLC] window, click [Add Device] to add another External Device.

■ Settings of External Device

Use the KOYO PLC Programming Software for communication settings.

Please refer to the manual of the External Device for details.

- 1 Set the Keyswitch Mode of the External Device to "TERM".
- 2 Connect the PC to the general-purpose communication port of the External Device.
- 3 In the KOYO PLC Programming Software, select "New File" from the File menu.
- 4 Select the model of the External Device to use.
- 5 In the PLC View Window, select [PLC] → [PLC Setup] → [COM Port Setup].
- 6 Set the connection parameters between the PC and the External Device.
- 7 Click [Connection Test].
- 8 Select [PLC] → [PLC Setup] → [COM Port Setup].
- 9 Set the port parameters.
- 10 Click [Write PLC].

4 Setup Items

Set the communication settings of the Display with GP-Pro Ex or in offline mode of the Display.

The setting of each parameter must be identical to that of the External Device.

 "3 Example of Communication Setting" (page 11)

4.1 Setup Items in GP-Pro EX

■ Communication Settings

To display the setup screen, from the [Project] menu, point to [System Settings] and select [Device/PLC].

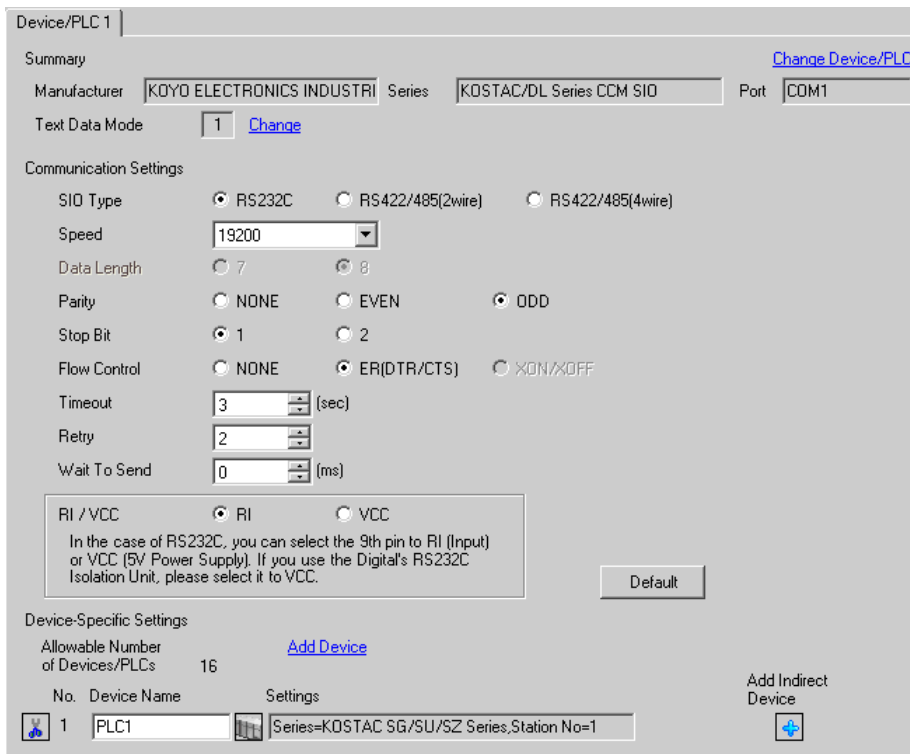

Device/PLC 1

Summary [Change Device/PLC](#)

Manufacturer: KOYD ELECTRONICS INDUSTRI Series: KOSTAC/DL Series CCM SIO Port: COM1

Text Data Mode: 1 [Change](#)

Communication Settings

SIO Type: RS232C RS422/485(2wire) RS422/485(4wire)

Speed: 19200

Data Length: 7 8

Parity: NONE EVEN ODD

Stop Bit: 1 2

Flow Control: NONE ER(DTR/CTS) XON/XOFF

Timeout: 3 (sec)

Retry: 2

Wait To Send: 0 (ms)

RI / VCC: RI VCC

In the case of RS232C, you can select the 9th pin to RI (Input) or VCC (5V Power Supply). If you use the Digital's RS232C Isolation Unit, please select it to VCC.

Default

Device-Specific Settings

Allowable Number of Devices/PLCs: 16 [Add Device](#)

No.	Device Name	Settings	Add Indirect Device
1	PLC1	Series=KOSTAC SG/SU/SZ Series, Station No=1	

Setup Items	Setup Description
SIO Type	Select the SIO type for communicating with the External Device.
Speed	Select the communication speed between the External Device and the Display.
Data Length	Select data length.
Parity	Select how to check parity.
Stop Bit	Select stop bit length.
Flow Control	Select the communication control method to prevent overflow of transmission and reception data.
Timeout	Use an integer from "1 to 127" to enter the time (s) for which the Display waits for the response from the External Device.

Continued to next page.

Setup Items	Setup Description
Retry	In case of no response from the External Device, use an integer from "0 to 255" to enter how many times the Display retransmits the command.
Wait To Send	Use an integer from "0 to 255" to enter the standby time (ms) from when the Display receives packets until it transmits the next command.
RI/VCC	You can switch RI/VCC of the 9th pin when you select RS232C for the SIO type. To connect to the IPC, you need to use the IPC selector switch to change RI/5V. Please refer to the manual of the IPC for details.

NOTE • Refer to the GP-Pro EX Reference Manual for Indirect Device.

Cf. GP-Pro EX Reference Manual "Changing the Device/PLC at Runtime (Indirect Device)"

■ Device Setting

To display the [Individual Device Settings] dialog box, from [Device-Specific Settings] in the [Device/PLC] window, select the external device and click [Settings] . To connect multiple External Devices, from [Device-Specific Settings] in the [Device/PLC] window, click [Add Device] to add another External Device.

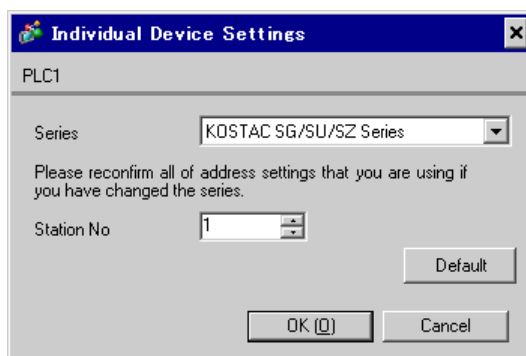

Setup Items	Setup Description
Series	Select the series of the External Device.
Station No.	Enter the station No. of the External Device, from "1 to 90".

4.2 Settings in Offline Mode

NOTE

- Refer to the Maintenance/Troubleshooting guide for information on how to enter offline mode or about the operation.

Cf. Maintenance/Troubleshooting Guide "Offline Mode"

- The number of the setup items to be displayed for 1 page in the offline mode depends on the Display in use. Please refer to the Reference manual for details.

■ Communication Settings

To display the setting screen, touch [Device/PLC Settings] from [Peripheral Equipment Settings] in offline mode. Touch the External Device you want to set from the list that appears.

Comm.	Device	Option		
KOSTAC/DL Series CCM SIO [COM1] Page 1/1				
SIO Type	RS232C			
Speed	19200			
Data Length	8			
Parity	<input type="radio"/> NONE <input type="radio"/> EVEN <input checked="" type="radio"/> ODD			
Stop Bit	<input checked="" type="radio"/> 1 <input type="radio"/> 2			
Flow Control	ER(DTR/CTS)			
Timeout(s)	3			
Retry	2			
Wait To Send(ms)	0			
Exit		Back		2007/06/14 16:00:19

Setup Items	Setup Description
SIO Type	Select the SIO type for communicating with the External Device. IMPORTANT In the communication settings, confirm the serial interface specifications of the Display and set [SIO Type] correctly. If you select an SIO type that the serial interface does not support, we cannot guarantee the operation. Please refer to the manual of the Display for more details on the serial interface specifications.
Speed	Select the communication speed between the External Device and the Display.
Data Length	Select data length.

Continues to the next page.

Setup Items	Setup Description
Parity	Select how to check parity.
Stop Bit	Select stop bit length.
Flow Control	Select the communication control method to prevent overflow of transmission and reception data.
Timeout	Use an integer from "1 to 127" to enter the time (s) for which the Display waits for the response from the External Device.
Retry	In case of no response from the External Device, use an integer from "0 to 255" to enter how many times the Display retransmits the command.
Wait To Send	Use an integer from "0 to 255" to enter the standby time (ms) from when the Display receives packets until it transmits the next command.

■ Device Setting

To display the setting screen, touch [Device/PLC Settings] from [Peripheral Equipment Settings]. Touch the External Device you want to set from the list that appears, and touch [Device Settings].

Comm.	Device	Option		
KOSTAC/DL Series CCM SIO		[COM1]	Page 1/1	
Device/PLC Name		PLC1		
Series		KOSTAC SG/SU/SZ Series		
Station No.		1		
Exit		Back		2007/06/14 16:00:27

Setup Items	Setup Description
Device/PLC Name	Select the External Device to set. Device name is the title of the External Device set with GP-Pro EX. (Initial value [PLC1])
Series	Displays the series of the External Device.
Station No.	Enter the station No. of the External Device, from "1 to 90".

■ Option Settings

To display the setting screen, touch [Device/PLC Settings] from [Peripheral Equipment Settings]. Touch the External Device you want to set from the list that appears, and touch [Option].

Comm.	Device	Option		
KOSTAC/DL Series CCM SIO			[COM1]	Page 1/1
RI / VCC <input checked="" type="radio"/> RI <input type="radio"/> VCC In the case of RS232C, you can select the 9th pin to RI(Input) or VCC(5V Power Supply). If you use the Digital's RS232C Isolation Unit, please select it to VCC.				
	Exit		Back	2007/06/14 16:00:37

Setup Items	Setup Description
RI/VCC	You can switch RI/VCC of the 9th pin when you select RS232C for the SIO type. To connect to the IPC, you need to use the IPC selector switch to change RI/5V. Please refer to the manual of the IPC for details.

NOTE

- GP-4100 series, GP-4*01TM, GP-Rear Module, LT-4*01TM and LT-Rear Module do not have the [Option] setting in the offline mode.

5 Cable Diagram

The following cable diagram may be different from the one recommended by KOYO ELECTRONICS INDUSTRIES CO., LTD. Please be assured, however, there is no operational problem in applying the cable diagram shown in this manual.

- The FG pin on the External Device must be D-class grounded. Please refer to the manual of the External Device for details.
- The SG and FG are connected inside the Display. If you connect the External Device to the SG, do not form any short-circuit loop in the system design.
- If the communication is not stable due to noise or other factors, connect an isolation unit.

Cable Diagram 1

Display (Connection Port)	Cable		Remarks
GP3000 (COM1) GP4000* ¹ (COM1) SP5000* ² (COM1/2) SP-5B00 (COM1) ST3000 (COM1) ST6000 (COM1) LT3000 (COM1) IPC* ³ PC/AT	1A	User-created cable	Cable length: 15m or less
GP-4105 (COM1) GP-4115T (COM1) GP-4115T3 (COM1)	1B	User-created cable	Cable length: 15m or less
LT-4*01TM (COM1) LT-Rear Module (COM1)	1C	RJ45 RS-232C Cable (5m) by Pro-face PFXZLMCBJR21	Cable length: 5m or less

*1 All GP4000 models except GP-4100 Series and GP-4203T

*2 Except SP-5B00

*3 Available only with the COM ports that support RS-232C.

 ■ IPC COM Port (page 7)

1A)

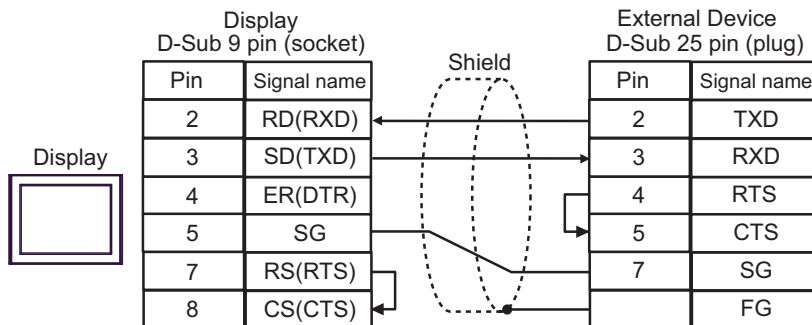

1B)

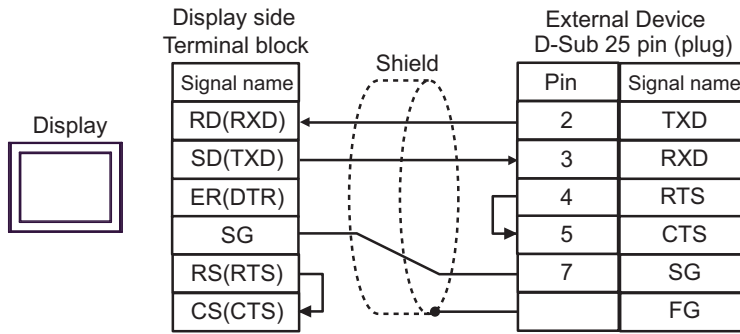

1C)

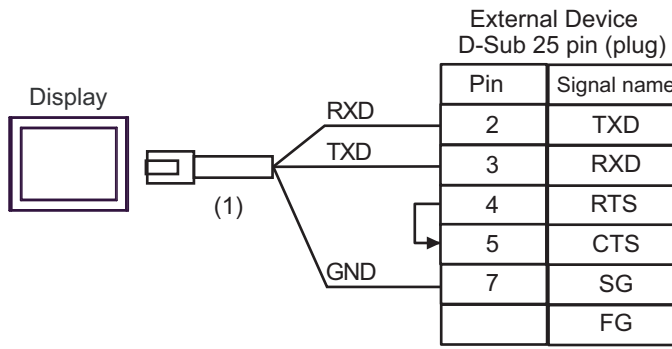

Number	Name	Notes
(1)	RJ45 RS-232C Cable (5m) by Pro-face PFXZLMCBRJ21	

Cable Diagram 2

Display (Connection Port)	Cable		Remarks
GP3000* ¹ (COM1) AGP3302B (COM2) GP-4*01TM (COM1) GP-Rear Module (COM1) ST3000* ² (COM2) LT3000 (COM1) IPC* ³	2A	COM port conversion adapter by Digital Electronics Corp. CA3-ADPCOM-01 + Connector terminal block conversion adapter by Digital Electronics Corp. CA3-ADPTRM-01 + User-created cable	Cable length: 600m or less
	2B	User-created cable	
GP3000* ⁴ (COM2)	2C	Online adapter by Digital Electronics Corp. CA4-ADPONL-01 + Connector terminal block conversion adapter by Digital Electronics Corp. CA3-ADPTRM-01 + User-created cable	Cable length: 600m or less
	2D	Online adapter by Digital Electronics Corp. CA4-ADPONL-01 + User-created cable	
GP-4106 (COM1) GP-4116T (COM1)	2E	User-created cable	Cable length: 600m or less
GP4000* ⁵ (COM2) GP-4201T (COM1) SP5000* ⁶ (COM1/2) SP-5B00 (COM2) ST6000* ⁷ (COM2) ST-6200 (COM1)	2F	RS-422 terminal block conversion adapter by Digital Electronics Corp. PFXZCBADTM1* ⁸ + User-created cable	Cable length: 600m or less
	2B	User-created cable	
PE-4000B* ⁹ PS5000* ⁹ PS6000* ⁹	2G	User-created cable	Cable length: 600m or less

*1 All GP3000 models except AGP-3302B

*2 Except AST-3211A and AST-3302B

*3 Available only with the COM ports that support RS-422/485 (4wire). (Except PE-4000B, PS5000, and PS6000)
 ■ IPC COM Port (page 7)

*4 All GP3000 models except GP-3200 series and AGP-3302B

*5 All GP4000 models except GP-4100 series, GP-4*01TM, GP-Rear Module, GP-4201T and GP-4*03T

*6 Except SP-5B00

*7 Except ST-6200

*8 When using a Terminal Block Conversion Adapter (CA3-ADPTRM-01) instead of the RS-422 Terminal Block Conversion Adapter, refer to Cable Diagram 2A.

*9 Available only with the COM ports that support RS-422/485 (4wire).
 ■ IPC COM Port (page 7)

2A)

- 1:1 Connection

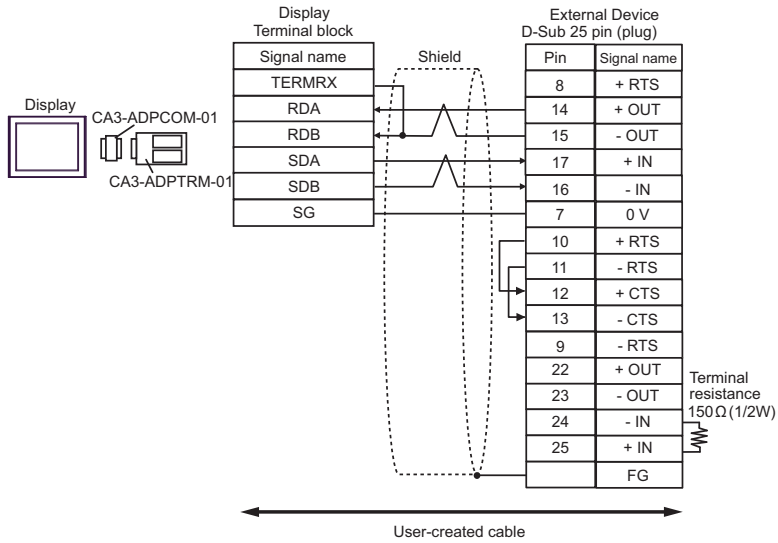

NOTE • Connect a 150Ω termination resistor to the +IN and -IN that are not used.

- 1:n Connection

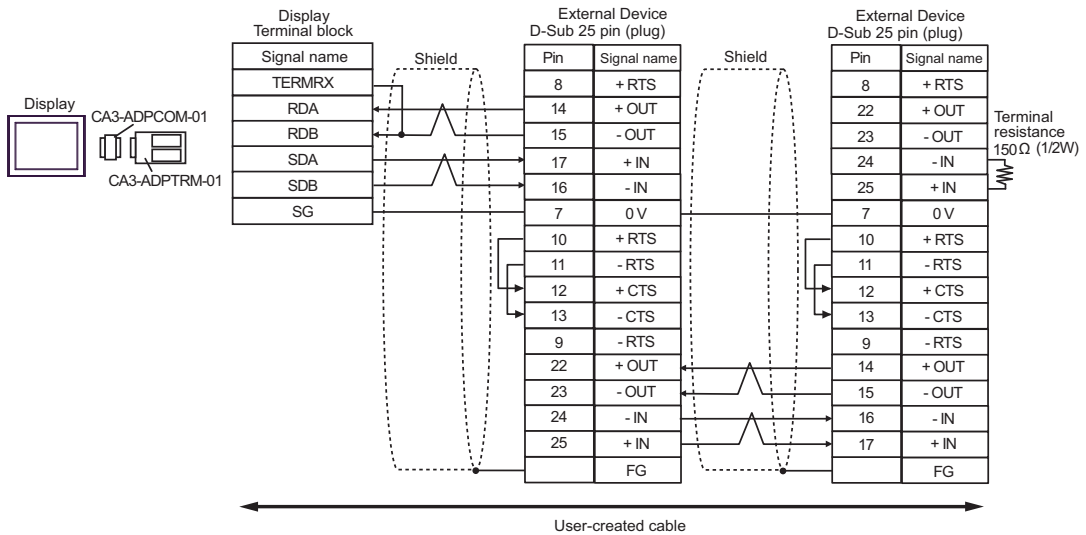

NOTE • Connect a 150Ω termination resistor to the +IN and -IN that are not used.

2B)

- 1:1 Connection

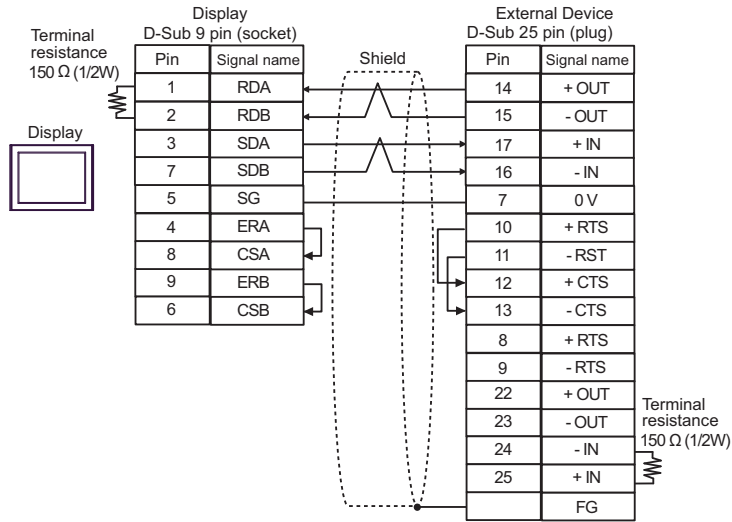

NOTE • Connect a 150Ω termination resistor to the +IN and -IN that are not used.

- 1:n Connection

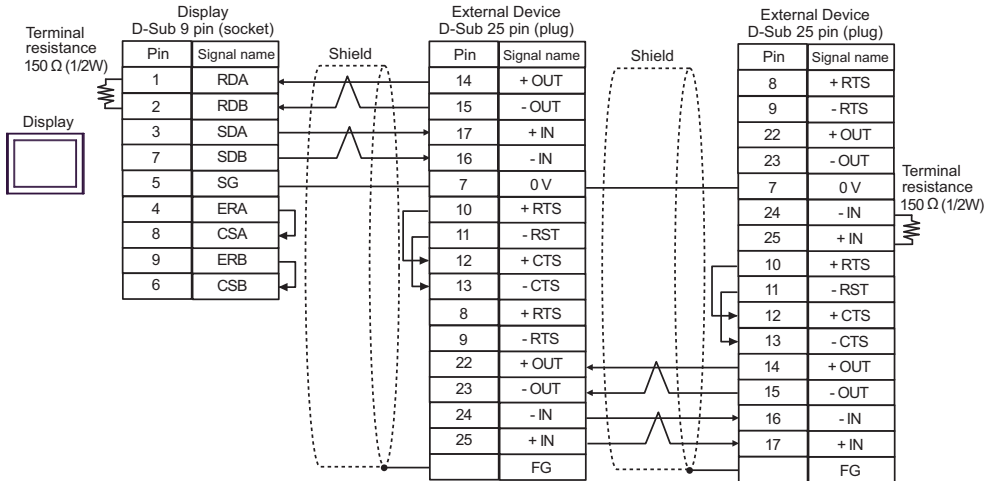

NOTE • Connect a 150Ω termination resistor to the +IN and -IN that are not used.

2C)

- 1:1 Connection

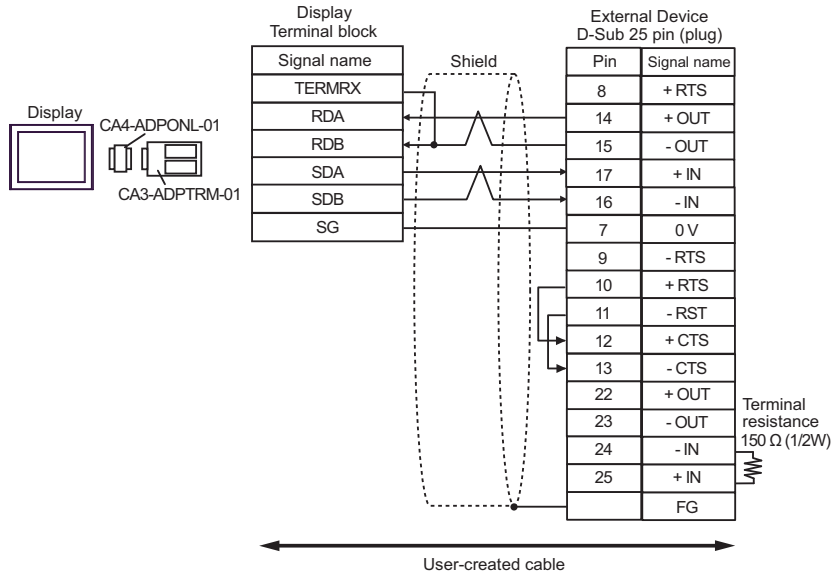

NOTE

- Connect a 150Ω termination resistor to the +IN and -IN that are not used.

- 1:n Connection

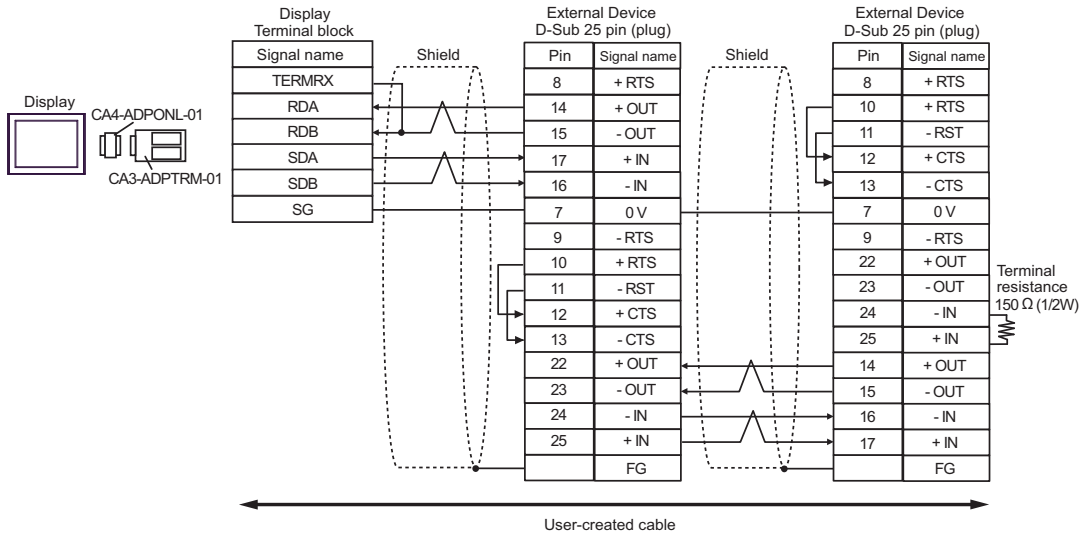

NOTE

- Connect a 150Ω termination resistor to the +IN and -IN that are not used.

2D)

- 1:1 Connection

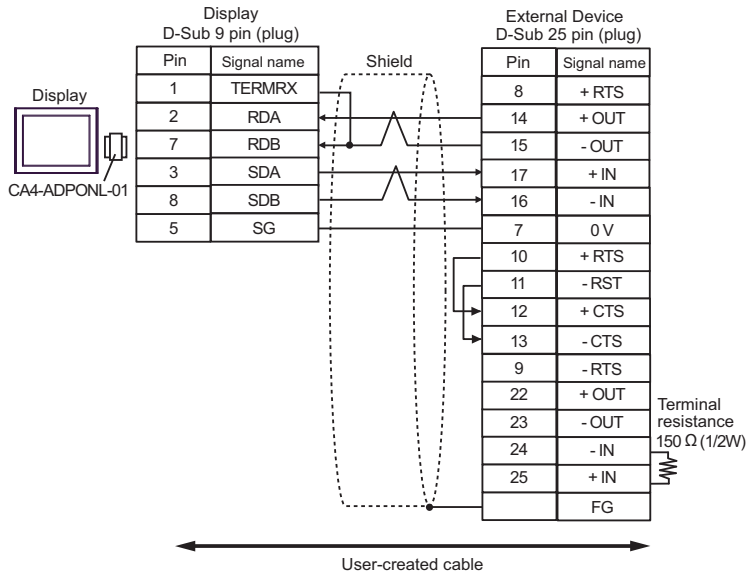

NOTE

- Connect a 150Ω termination resistor to the +IN and -IN that are not used.

- 1:n Connection

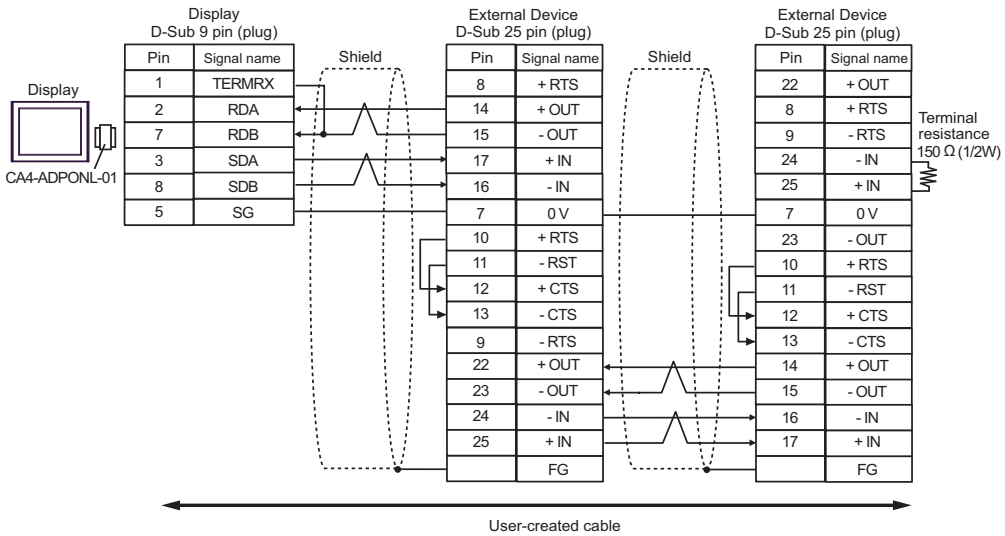

NOTE

- Connect a 150Ω termination resistor to the +IN and -IN that are not used.

2E)

- 1:1 Connection

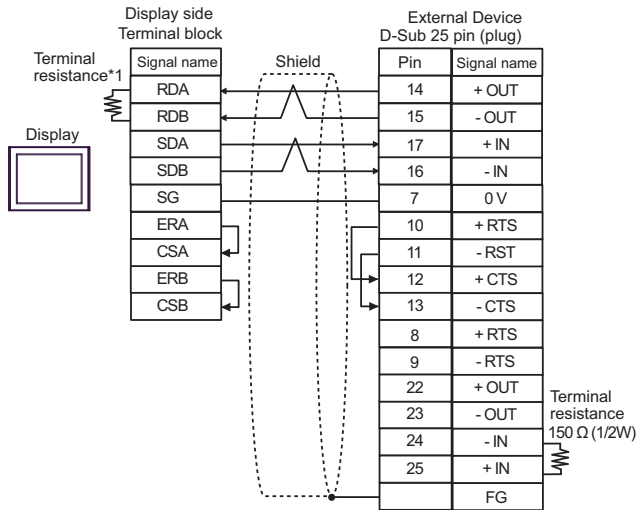

NOTE • Connect a 150Ω termination resistor to the +IN and -IN that are not used.

- 1:n Connection

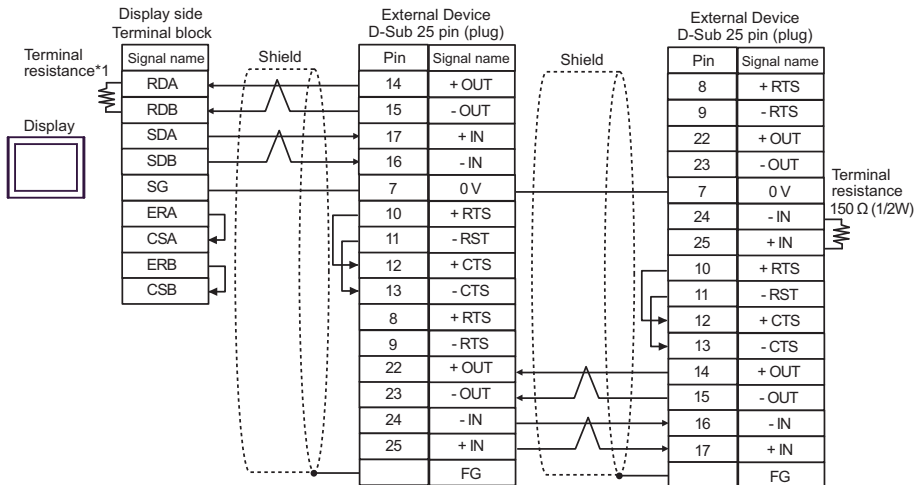

NOTE • Connect a 150Ω termination resistor to the +IN and -IN that are not used.

*1 The resistance in the Display is used as the termination resistance. Set the value of the DIP Switch on the rear of the Display as shown in the table below.

DIP Switch No.	Set Value
1	OFF
2	OFF
3	ON
4	ON

2F)

- 1:1 Connection

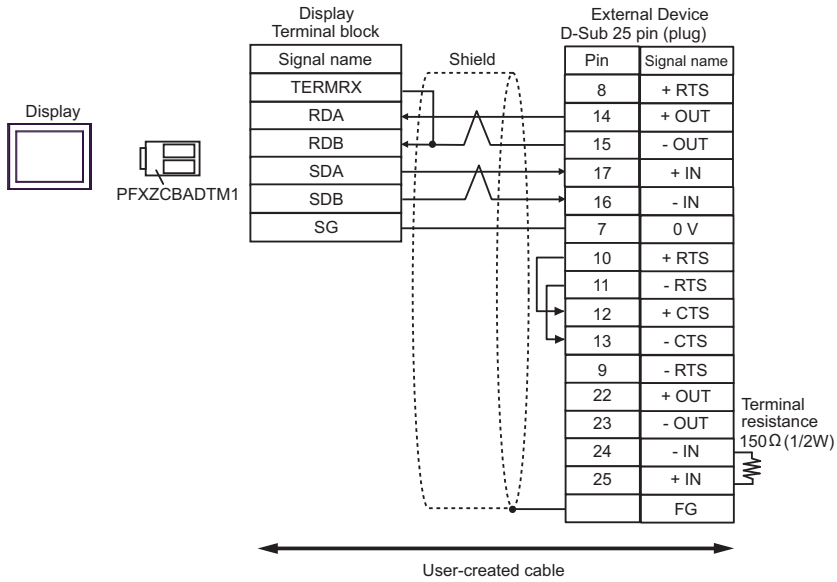

NOTE

- Connect a 150Ω termination resistor to the +IN and -IN that are not used.

- 1:n Connection

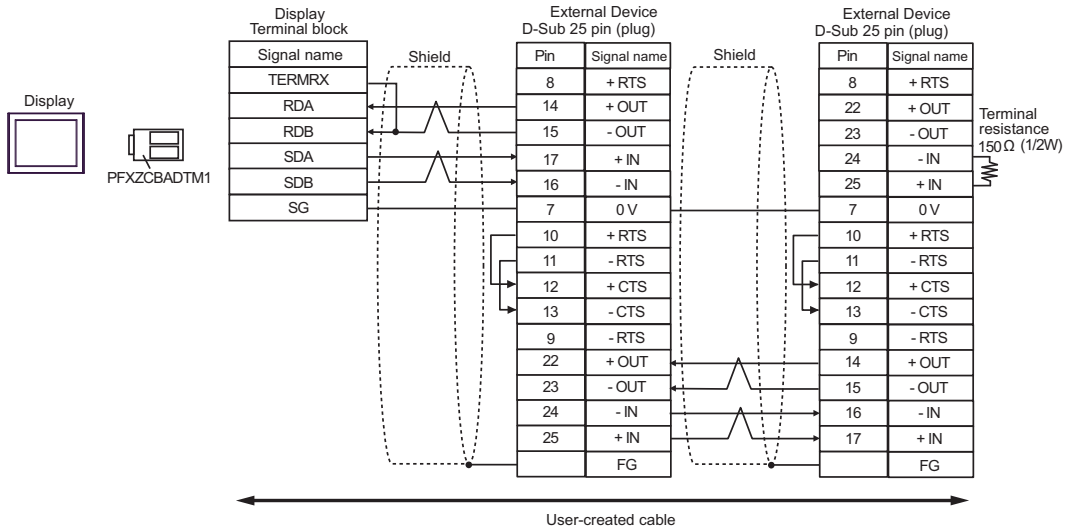

NOTE

- Connect a 150Ω termination resistor to the +IN and -IN that are not used.

2G)

- 1:1 Connection

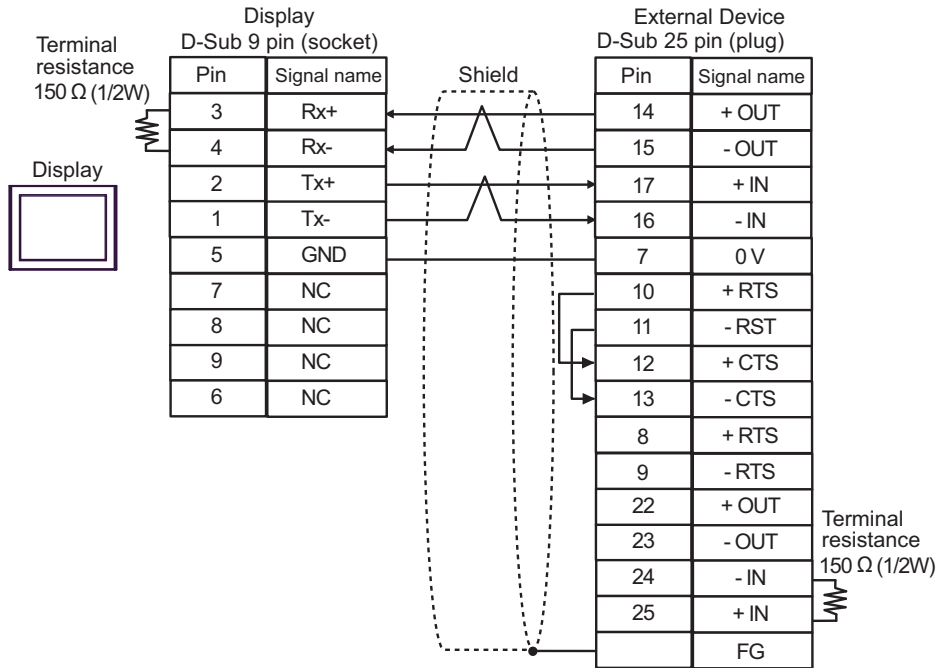

NOTE • Connect a 150Ω termination resistor to the +IN and -IN that are not used.

- 1:n Connection

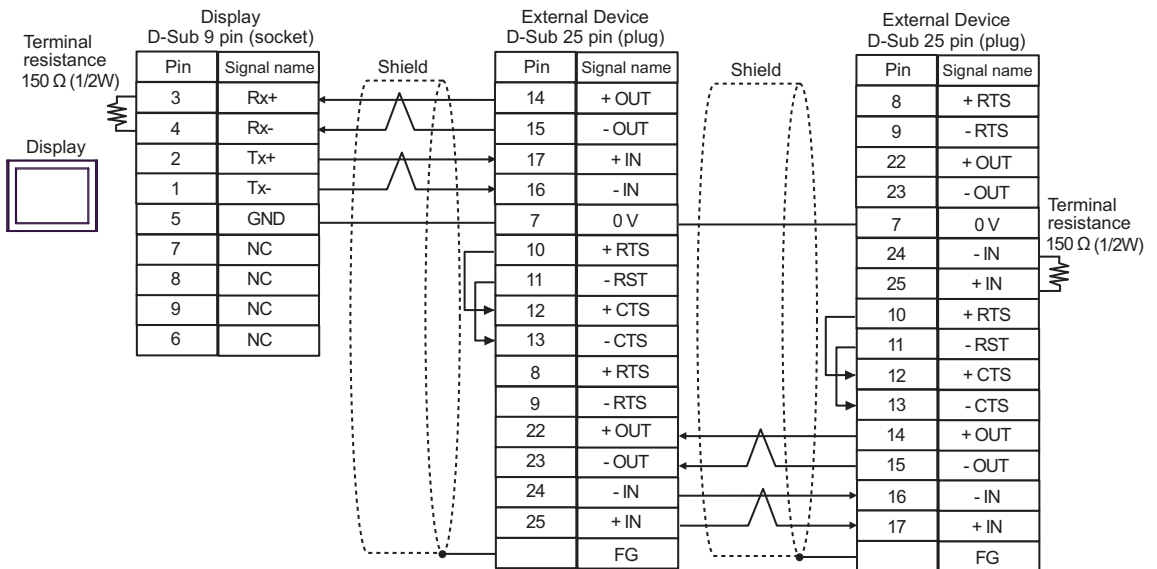

NOTE • Connect a 150Ω termination resistor to the +IN and -IN that are not used.

Cable Diagram 3

Display (Connection Port)	Cable		Remarks
GP3000* ¹ (COM1) AGP3302B (COM2) GP-4*01TM (COM1) GP-Rear Module (COM1) ST3000* ² (COM2) LT3000 (COM1) IPC* ³	3A	COM port conversion adapter by Digital Electronics Corp. CA3-ADPCOM-01 + Connector terminal block conversion adapter by Digital Electronics Corp. CA3-ADPTRM-01 + User-created cable	Cable length: 600m or less
	3B	User-created cable	
GP3000* ⁴ (COM2)	3C	Online adapter by Digital Electronics Corp. CA4-ADPONL-01 + Connector terminal block conversion adapter by Digital Electronics Corp. CA3-ADPTRM-01 + User-created cable	Cable length: 600m or less
	3D	Online adapter by Digital Electronics Corp. CA4-ADPONL-01 + User-created cable	
GP-4106 (COM1) GP-4116T (COM1)	3E	User-created cable	Cable length: 600m or less
GP4000* ⁵ (COM2) GP-4201T (COM1) SP5000* ⁶ (COM1/2) SP-5B00 (COM2) ST6000* ⁷ (COM2) ST-6200 (COM1)	3F	RS-422 terminal block conversion adapter by Digital Electronics Corp. PFXZCBADTM1* ⁸ + User-created cable	Cable length: 600m or less
	3B	User-created cable	
PE-4000B* ⁹ PS5000* ⁹ PS6000* ⁹	3G	User-created cable	Cable length: 600m or less

*1 All GP3000 models except AGP-3302B

*2 Except AST-3211A and AST-3302B

*3 Available only with the COM ports that support RS-422/485 (4wire). (Except PE-4000B, PS5000, and PS6000)
 ■ IPC COM Port (page 7)

*4 All GP3000 models except GP-3200 series and AGP-3302B

*5 All GP4000 models except GP-4100 series, GP-4*01TM, GP-Rear Module, GP-4201T and GP-4*03T

*6 Except SP-5B00

*7 Except ST-6200

*8 When using a Terminal Block Conversion Adapter (CA3-ADPTRM-01) instead of the RS-422 Terminal Block Conversion Adapter, refer to Cable Diagram 3A.

*9 Available only with the COM ports that support RS-422/485 (4wire).
 ■ IPC COM Port (page 7)

3A)

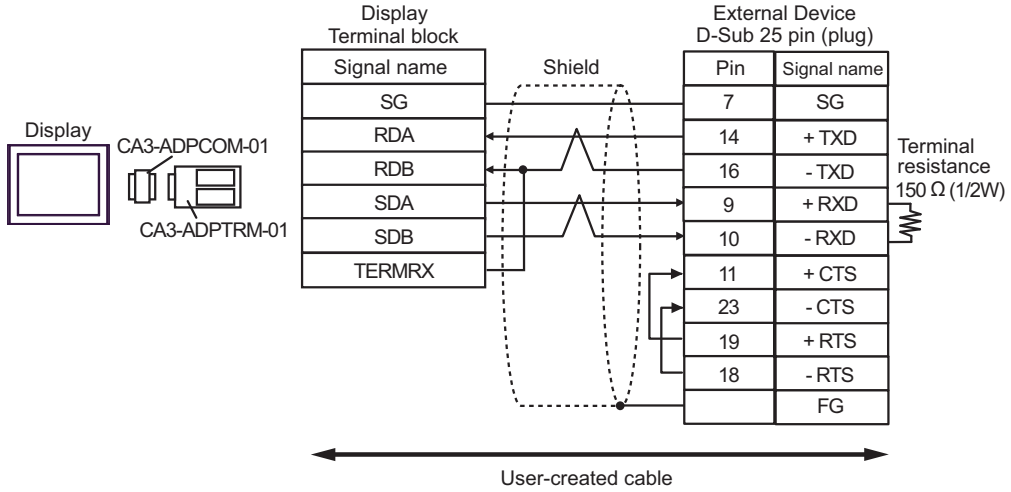

NOTE • Connect a 150Ω termination resistor to the +RXD and -RXD.

3B)

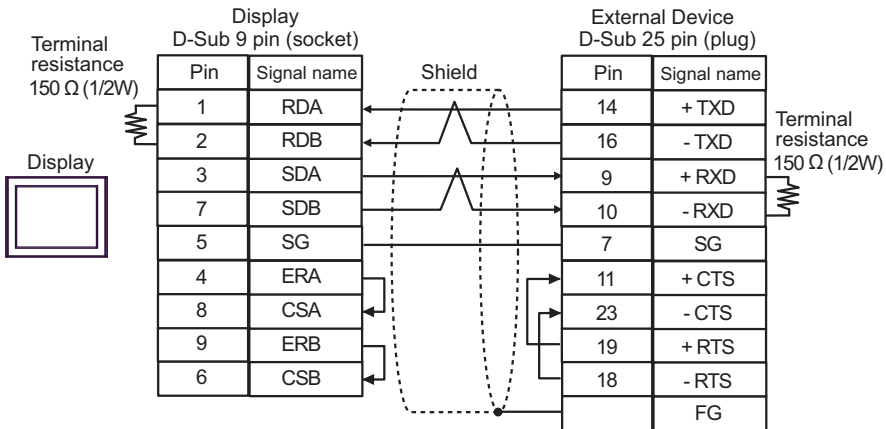

NOTE • Connect a 150Ω termination resistor to the +RXD and -RXD.

3C)

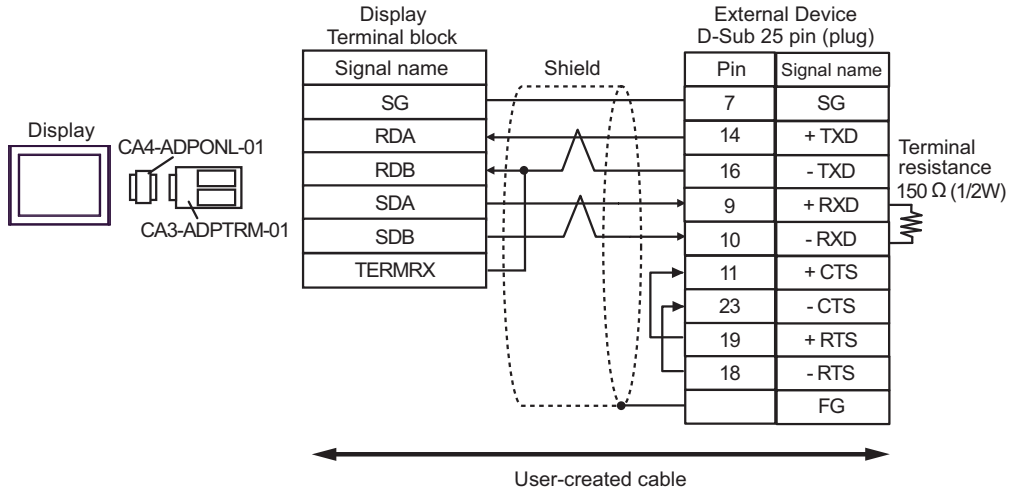

NOTE • Connect a 150Ω termination resistor to the +RXD and -RXD.

3D)

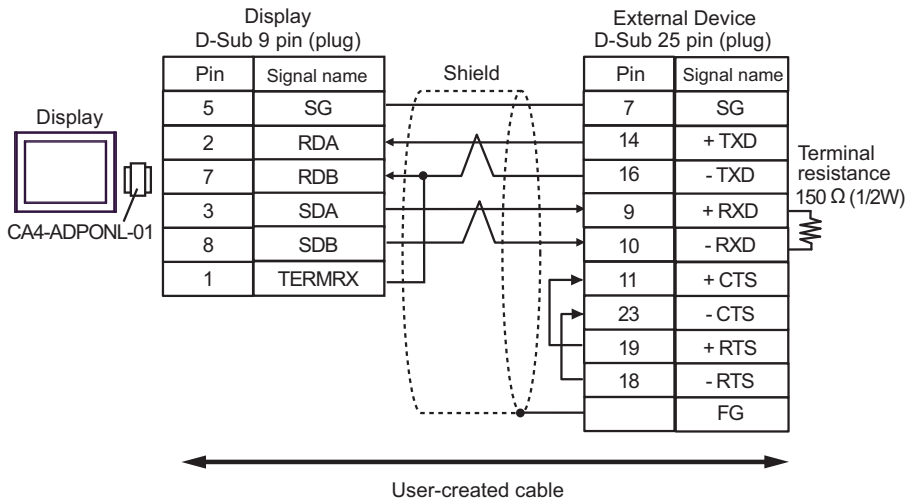

NOTE • Connect a 150Ω termination resistor to the +RXD and -RXD.

3E)

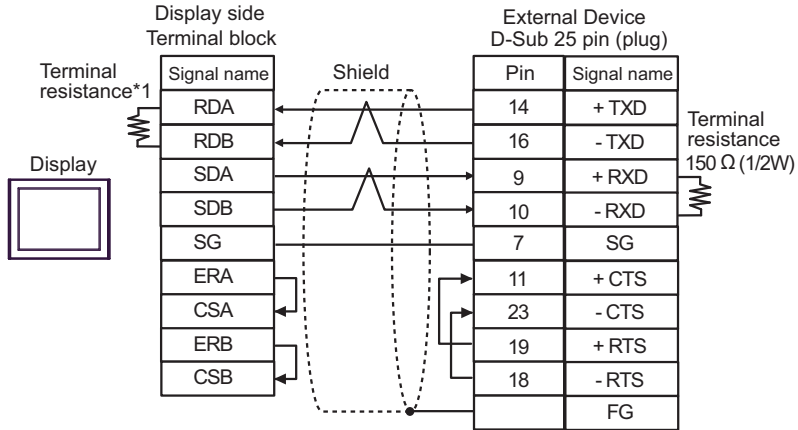

NOTE

- Connect a 150Ω termination resistor to the +RXD and -RXD.

*1 The resistance in the Display is used as the termination resistance. Set the value of the DIP Switch on the rear of the Display as shown in the table below.

DIP Switch No.	Set Value
1	OFF
2	OFF
3	ON
4	ON

3F)

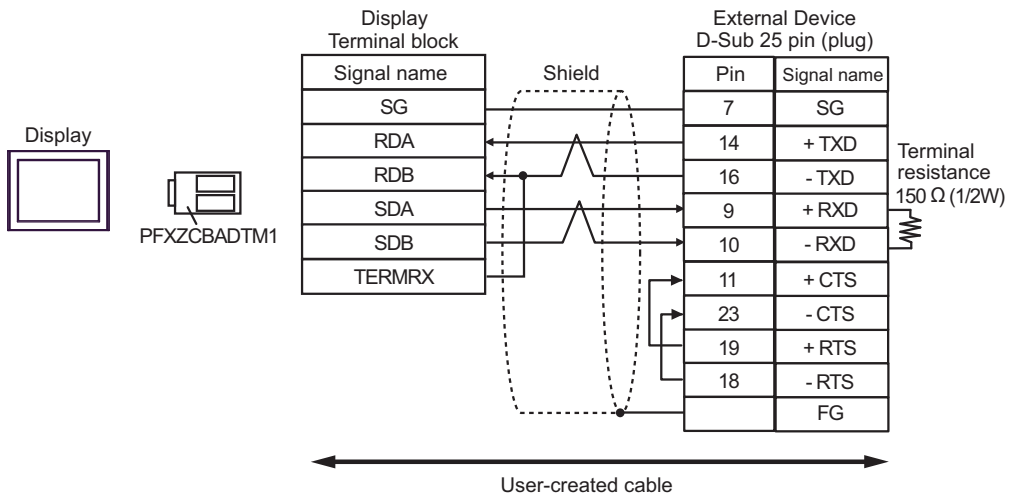

NOTE

- Connect a 150Ω termination resistor to the +RXD and -RXD.

3G)

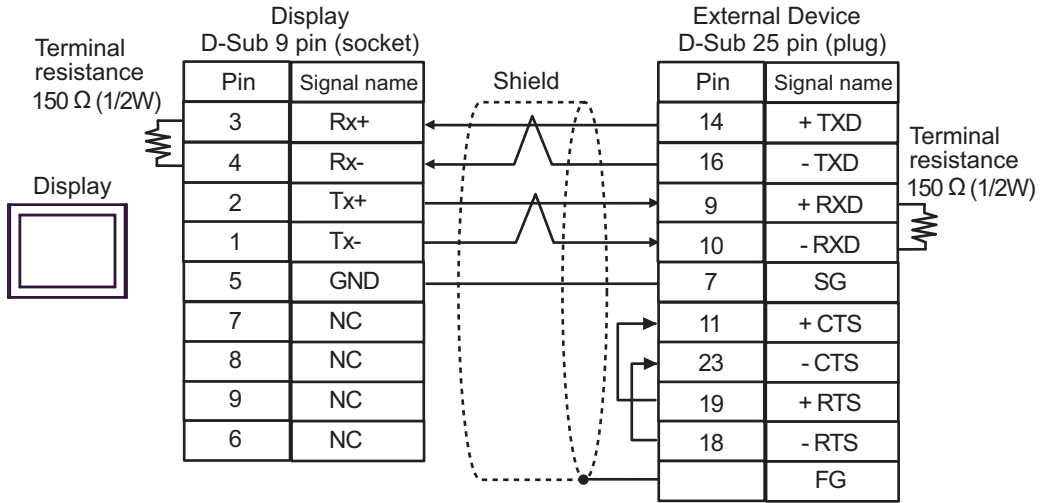

NOTE • Connect a 150Ω termination resistor to the +RXD and -RXD.

Cable Diagram 4

Display (Connection Port)	Cable		Remarks
GP3000 (COM1) GP4000* ¹ (COM1) SP5000* ² (COM1/2) SP-5B00 (COM1) ST3000 (COM1) ST6000 (COM1) LT3000 (COM1) IPC* ³ PC/AT	4A	User-created cable	Cable length: 15m or less
GP-4105 (COM1) GP-4115T (COM1) GP-4115T3 (COM1)	4B	User-created cable	Cable length: 15m or less
LT-4*01TM (COM1) LT-Rear Module (COM1)	4C	RJ45 RS-232C Cable (5m) by Pro-face PFXZLMCBRJ21	Cable length: 5m or less

*1 All GP4000 models except GP-4100 Series and GP-4203T

*2 Except SP-5B00

*3 Available only with the COM ports that support RS-232C.
 ■ IPC COM Port (page 7)

4A)

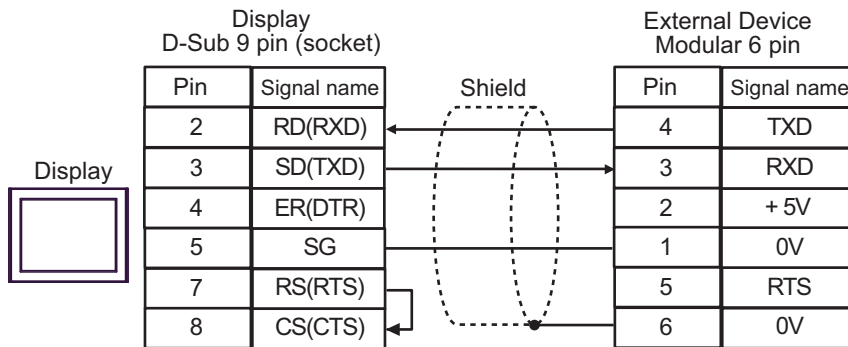

4B)

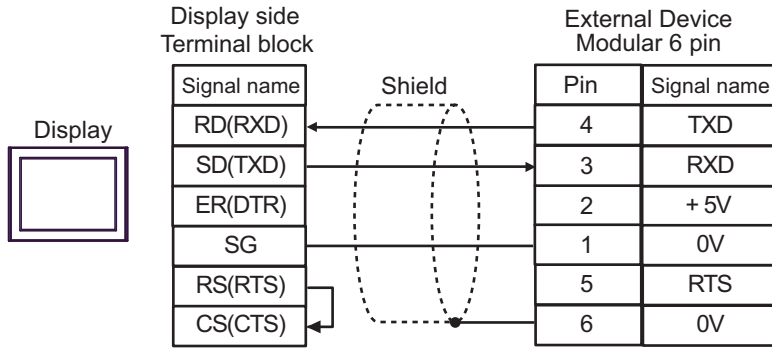

4C)

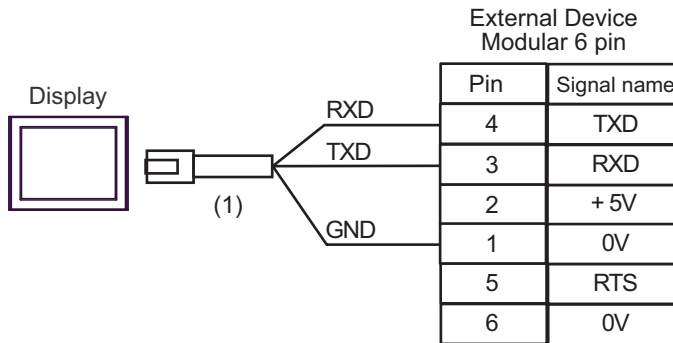

Number	Name	Notes
(1)	RJ45 RS-232C Cable (5m) by Pro-face PFXZLMCBRJ21	

Cable Diagram 5

Display (Connection Port)	Cable		Remarks
GP3000 (COM1) GP4000* ¹ (COM1) SP5000* ² (COM1/2) SP-5B00 (COM1) ST3000 (COM1) ST6000 (COM1) LT3000 (COM1) IPC* ³ PC/AT	5A	User-created cable	Cable length: 3m or less
GP-4105 (COM1) GP-4115T (COM1) GP-4115T3 (COM1)	5B	User-created cable	Cable length: 3m or less
LT-4*01TM (COM1) LT-Rear Module (COM1)	5C	RJ45 RS-232C Cable (5m) by Pro-face PFXZLMCBRJ21	Cable length: 5m or less

*1 All GP4000 models except GP-4100 Series and GP-4203T

*2 Except SP-5B00

*3 Available only with the COM ports that support RS-232C.

 ■ IPC COM Port (page 7)

5A)

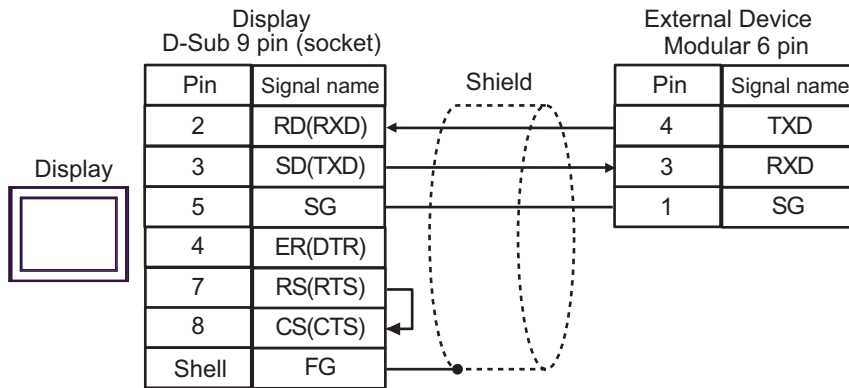

5B)

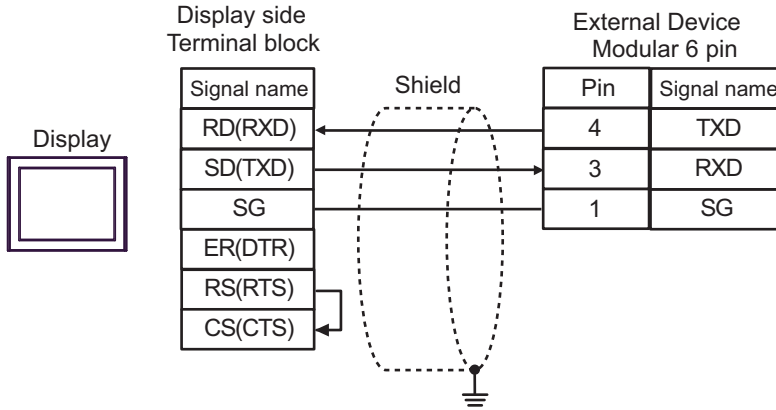

5C)

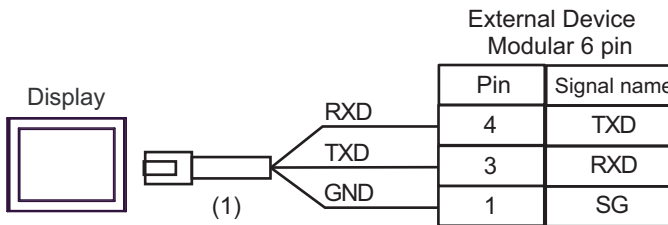

Number	Name	Notes
(1)	RJ45 RS-232C Cable (5m) by Pro-face PFXZLMCBRJ21	

Cable Diagram 6

Display (Connection Port)	Cable		Remarks
GP3000 (COM1) GP4000* ¹ (COM1) SP5000* ² (COM1/2) SP-5B00 (COM1) ST3000 (COM1) ST6000 (COM1) LT3000 (COM1) IPC* ³ PC/AT	6A	User-created cable	Cable length: 15m or less
GP-4105 (COM1) GP-4115T (COM1) GP-4115T3 (COM1)	6B	User-created cable	Cable length: 15m or less
LT-4*01TM (COM1) LT-Rear Module (COM1)	6C	RJ45 RS-232C Cable (5m) by Pro-face PFXZLMCBJR21	Cable length: 5m or less

*1 All GP4000 models except GP-4100 Series and GP-4203T

*2 Except SP-5B00

*3 Available only with the COM ports that support RS-232C.

☞ ■ IPC COM Port (page 7)

6A)

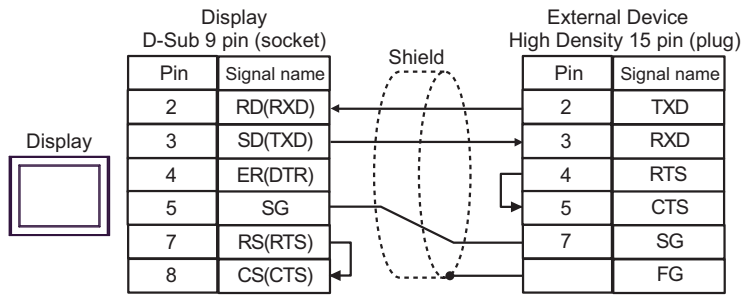

6B)

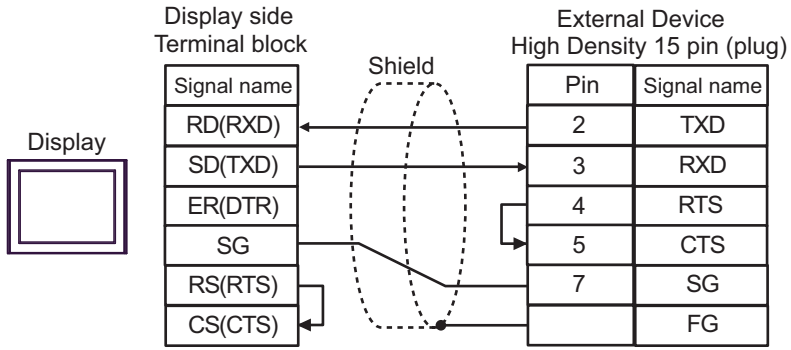

6C)

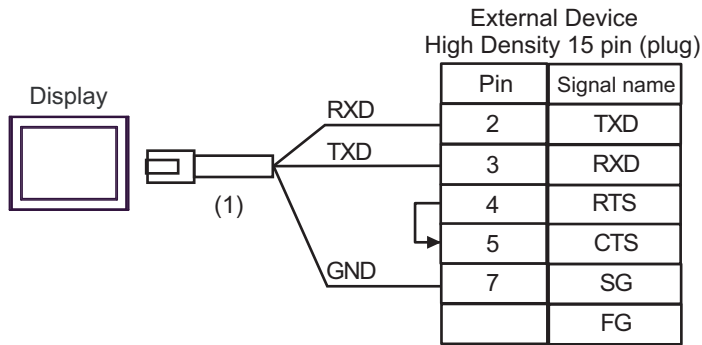

Number	Name	Notes
(1)	RJ45 RS-232C Cable (5m) by Pro-face PFXZLMCBRJR21	

Cable Diagram 7

Display (Connection Port)	Cable		Remarks
GP3000* ¹ (COM1) AGP-3302B (COM2) GP-4*01TM (COM1) GP-Rear Module (COM1) ST3000* ² (COM2) LT3000 (COM1) IPC* ³	7A	COM port conversion adapter by Digital Electronics Corp. CA3-ADPCOM-01 + Connector terminal block conversion adapter by Digital Electronics Corp. CA3-ADPTRM-01 + User-created cable	Cable length: 600m or less
	7B	User-created cable	
GP3000* ⁴ (COM2)	7C	Online adapter by Digital Electronics Corp. CA4-ADPONL-01 + Connector terminal block conversion adapter by Digital Electronics Corp. CA3-ADPTRM-01 + User-created cable	Cable length: 600m or less
	7D	Online adapter by Digital Electronics Corp. CA4-ADPONL-01 + User-created cable	
GP-4106 (COM1) GP-4116T (COM1)	7E	User-created cable	Cable length: 600m or less
GP4000* ⁵ (COM2) GP-4201T (COM1) SP5000* ⁶ (COM1/2) SP-5B00 (COM2) ST6000* ⁷ (COM2) ST-6200 (COM1)	7F	RS-422 terminal block conversion adapter by Digital Electronics Corp. PFXZCBADTM1* ⁸ + User-created cable	Cable length: 600m or less
	7B	User-created cable	
PE-4000B* ⁹ PS5000* ⁹ PS6000* ⁹	7G	User-created cable	Cable length: 600m or less

*1 All GP3000 models except AGP-3302B

*2 Except AST-3211A and AST-3302B

*3 Available only with the COM ports that support RS-422/485 (4wire). (Except PE-4000B, PS5000, and PS6000)

 ■ IPC COM Port (page 7)

*4 All GP3000 models except GP-3200 series and AGP-3302B

*5 All GP4000 models except GP-4100 series, GP-4*01TM, GP-Rear Module, GP-4201T and GP-4*03T

*6 Except SP-5B00

*7 Except ST-6200

*8 When using a Terminal Block Conversion Adapter (CA3-ADPTRM-01) instead of the RS-422 Terminal Block Conversion Adapter, refer to Cable Diagram 7A.

*9 Available only with the COM ports that support RS-422/485 (4wire).

 ■ IPC COM Port (page 7)

7A)

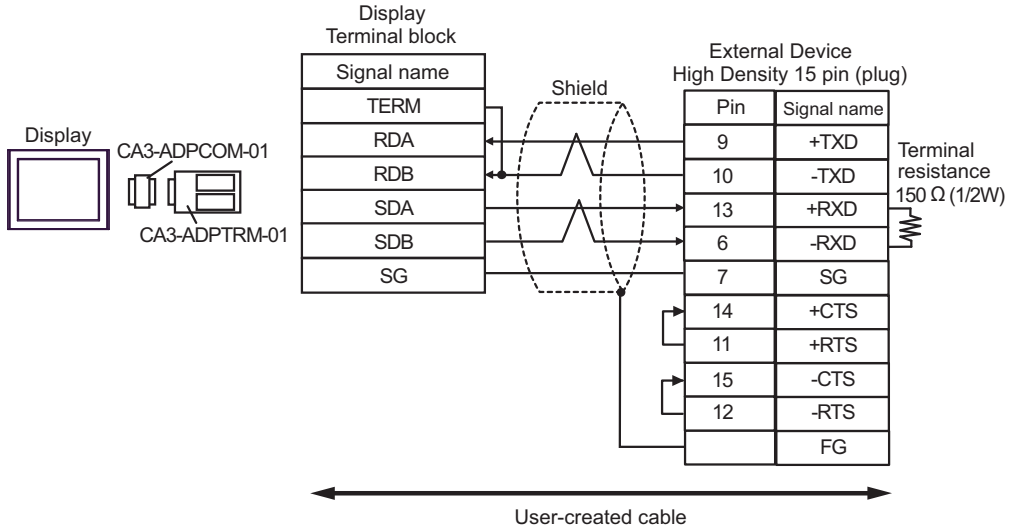

NOTE • Connect a 150Ω termination resistor to the +RXD and -RXD.

7B)

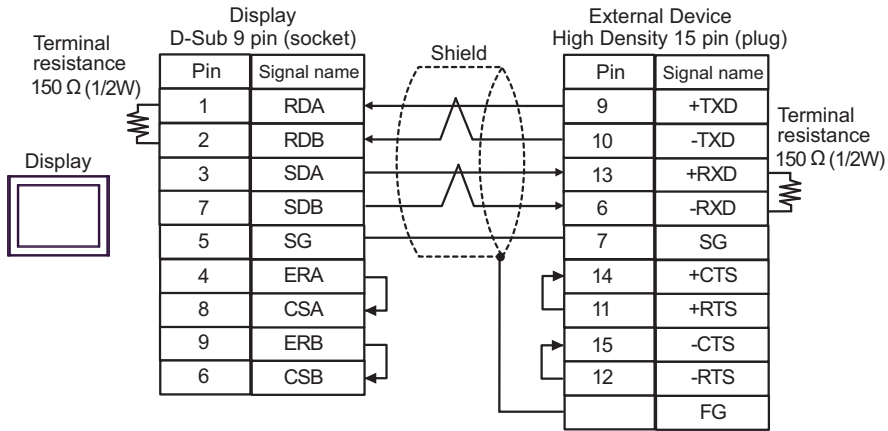

NOTE • Connect a 150Ω termination resistor to the +RXD and -RXD.

7C)

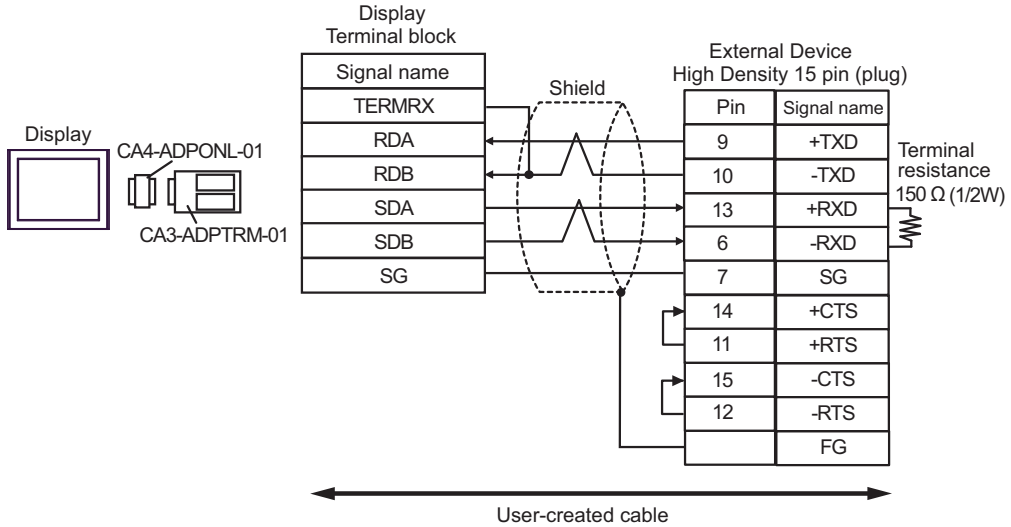

NOTE • Connect a 150Ω termination resistor to the +RXD and -RXD.

7D)

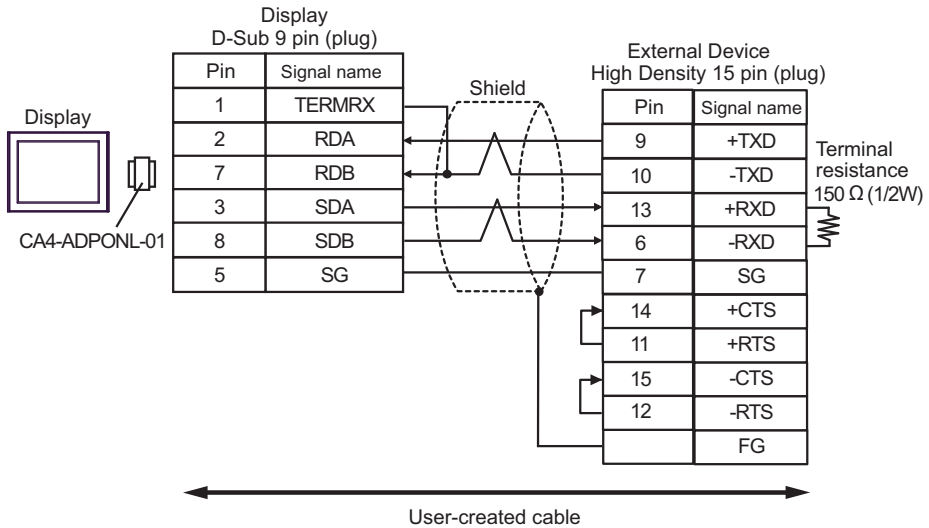

NOTE • Connect a 150Ω termination resistor to the +RXD and -RXD.

7E)

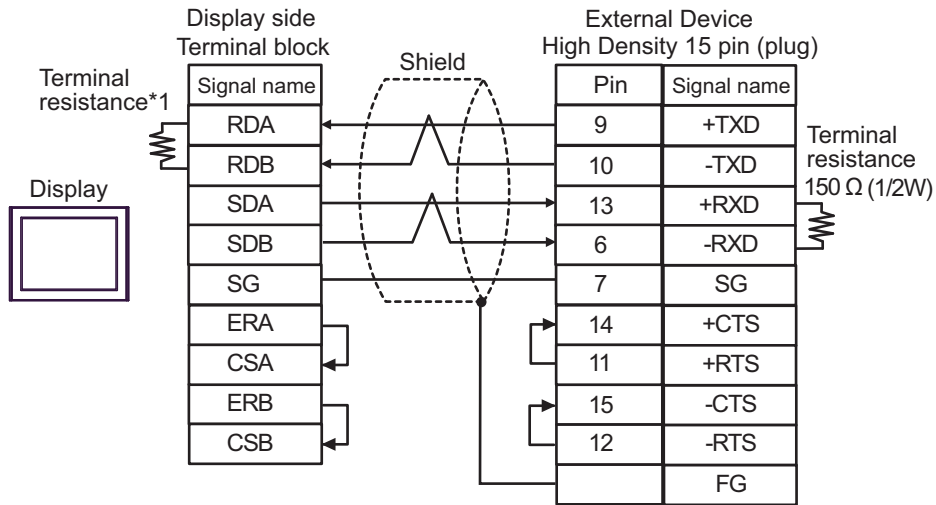
**NOTE**

- Connect a 150Ω termination resistor to the +RXD and -RXD.

*1 The resistance in the Display is used as the termination resistance. Set the value of the DIP Switch on the rear of the Display as shown in the table below.

DIP Switch No.	Set Value
1	OFF
2	OFF
3	ON
4	ON

7F)

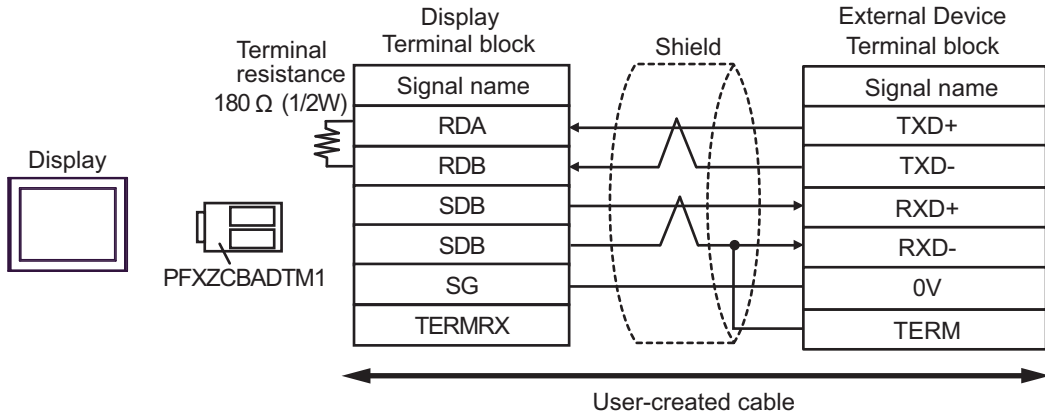

NOTE

- Connect a 150Ω termination resistor to the +RXD and -RXD.

7G)

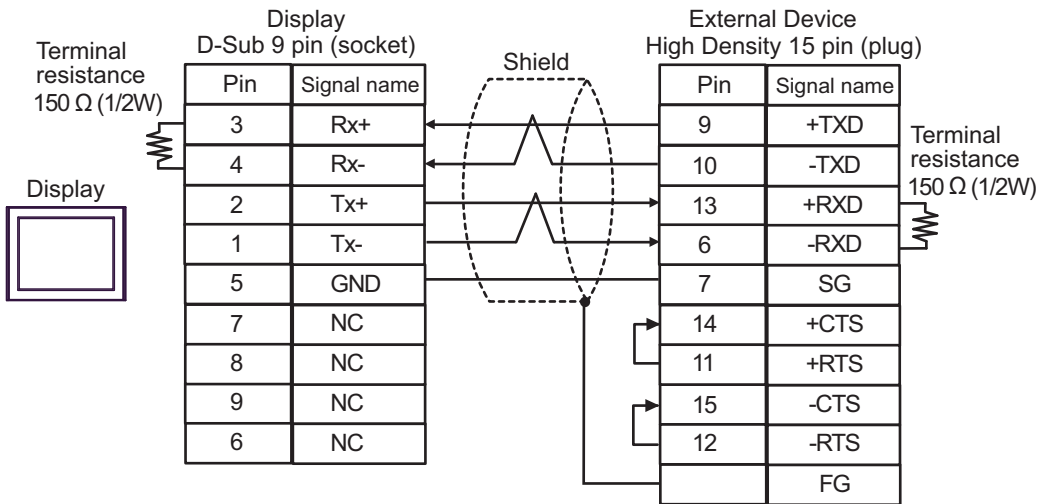

NOTE

- Connect a 150Ω termination resistor to the +RXD and -RXD.

Cable Diagram 8

Display (Connection Port)	Cable		Remarks
GP3000 (COM1) GP4000* ¹ (COM1) SP5000* ² (COM1/2) SP-5B00 (COM1) ST3000 (COM1) ST6000 (COM1) LT3000 (COM1) IPC* ³ PC/AT	8A	KOYO D2-DSCBL	Cable length: 15m or less

*1 All GP4000 models except GP-4100 Series and GP-4203T

*2 Except SP-5B00

*3 Available only with the COM ports that support RS-232C.

 ■ IPC COM Port (page 7)

8A)

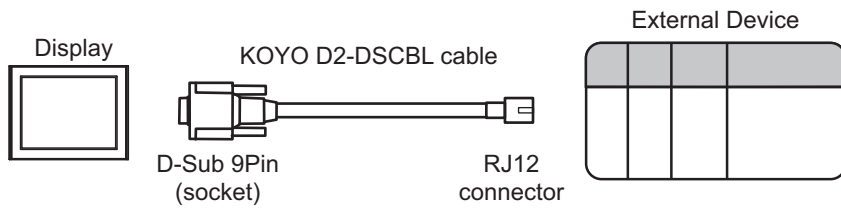

















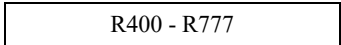

6 Supported Device

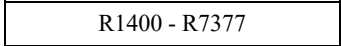
The following table shows the range of supported device addresses. Available type and range of device may vary depending on the CPU. Be sure to check them in each CPU manual before use.

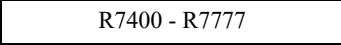
6.1 KOSTAC SG Series

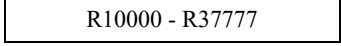
 : This address can be specified as system data area.

Device	Bit Address	Word Address	32 bit	Remarks
Input Relay	I0000 - I1777	R40400 - R40477	L / H	 *1
Output Relay	Q0000 - Q1777	R40500 - R40577		 *1
All Station Transmission Relay (Input)	GI0000 - GI3777	R40000 - R40177		 *1
Special Station Transmission Relay (Output)	GQ0000 - GQ3777	R40200 - R40377		 *1
Internal Relay	M0000 - M3777	R40600 - R40777		 *1
Special Relay	SP000 - SP777	R41200 - R41237		 *1
Timer (Contact)	T000 - T377	R41100 - R41117		 *1
Counter (Contact)	C000 - C377	R41140 - R41157		 *1
Stage	S0000 - S1777	R41000 - R41077		 *1
Timer (Elapsed Value)	-	R0000 - R0377		 *1
Counter (Elapsed Value)	-	R1000 - R1377		 *1
Data Register 1	-	 R400 - R777		 
Data Register 2	-	 R1400 - R7377		 
Special Register	-	 R7400 - R7777		 
Data Register 3	-	 R10000 - R37777		 

*1 When bits are written, the Display reads the corresponding word address from the External Device, sets particular bits of that word address to ON, and then returns the resulting address to the External Device. Note that the correct data may not be written if you change the word address using the ladder program while the Display reads data from the External Device and returns it.

NOTE

- Please refer to the GP-Pro EX Reference Manual for system data area.

Cf. GP-Pro EX Reference Manual "LS Area (Direct Access Method Area)"









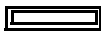





- Please refer to the precautions on manual notation for icons in the table.

 "Manual Symbols and Terminology"

6.2 KOSTAC SU Series

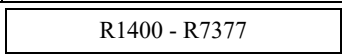
■ SU-5/5E/6 Series

 : This address can be specified as system data area.

Device	Bit Address	Word Address	32 bit	Remarks
Input Relay	I000 - I477	R40400 - R40423	L/H	 *1
Output Relay	Q000 - Q477	R40500 - R40523		 *1
Link Relay/Link Input	GI0000 - GI1777	R40000 - R40077		 *1
Internal Relay	M0000 - M0737	R40600 - R40635		 *1
Special Relay	SP000 - SP137 SP320 - SP617	R41200 - R41205 R41215 - R41230		 *1
Timer (Contact)	T000 - T177	R41100 - R41107		 *1
Counter (Contact)	C000 - C177	R41140 - R41147		 *1
Stage	S0000 - S0577	R41000 - R41027		 *1
Timer (Elapsed Value)	-	R0000 - R0177		 *1
Counter (Elapsed Value)	-	R1000 - R1177		 *1
Data Register	-	 R1400 - R7377		 
Special Register *2	-	R7400 - R7777		 

*1 When bits are written, the Display reads the corresponding word address from the External Device, sets particular bits of that word address to ON, and then returns the resulting address to the External Device. Note that the correct data may not be written if you change the word address using the ladder program while the Display reads data from the External Device and returns it.

*2 Data cannot be written.

NOTE

- Please refer to the GP-Pro EX Reference Manual for system data area.
Cf. GP-Pro EX Reference Manual "LS Area (Direct Access Method Area)"
- Please refer to the precautions on manual notation for icons in the table.
 "Manual Symbols and Terminology"

■ SU-6B/6B-C Series

 : This address can be specified as system data area.

Device	Bit Address	Word Address	32 bit	Remarks
Input Relay	I000 - I477	R40400 - R40423	L/H	OCT 8 *1
Output Relay	Q000 - Q477	R40500 - R40523		OCT 8 *1
Link Relay/Link Input	GI0000 - GI1777	R40000 - R40077		OCT 8 *1
Internal Relay	M0000 - M1777	R40600 - R40677		OCT 8 *1
Special Relay	SP000 - SP137 SP320 - SP717	R41200 - R41205 R41215 - R41234		OCT 8 *1
Timer (Contact)	T000 - T377	R41100 - R41117		OCT 8 *1
Counter (Contact)	C000 - C177	R41140 - R41147		OCT 8 *1
Stage	S0000 - S1777	R41000 - R41077		OCT 8 *1
Timer (Elapsed Value)	-	R0000 - R0377		OCT 8
Counter (Elapsed Value)	-	R1000 - R1177		OCT 8
Data Register	-	R1400 - R7377		OCT 8 BIT 15
Special Register *2	-	R700 - R737 R7400 - R7777		OCT 8 BIT 15
Extension Register	-	R10000 - R17777		OCT 8 BIT 15

*1 When bits are written, the Display reads the corresponding word address from the External Device, sets particular bits of that word address to ON, and then returns the resulting address to the External Device. Note that the correct data may not be written if you change the word address using the ladder program while the Display reads data from the External Device and returns it.

*2 Data cannot be written.

NOTE

- Please refer to the GP-Pro EX Reference Manual for system data area.

Cf. GP-Pro EX Reference Manual "LS Area (Direct Access Method Area)"

- Please refer to the precautions on manual notation for icons in the table.

 "Manual Symbols and Terminology"

■ SU-5M/5M-C/6M/6M-C Series

 : This address can be specified as system data area.

Device	Bit Address	Word Address	32 bit	Remarks
Input Relay	I0000 - I1777	R40400 - R40477	L/H	OCT 8 *1
Output Relay	Q0000 - Q1777	R40500 - R40577		OCT 8 *1
Link Relay/Link Input	GI0000 - GI3777	R40000 - R40177		OCT 8 *1
Special Station Transmission Relay (Output)	GQ0000 - GQ3777	R40200 - R40377		OCT 8 *1
Internal Relay	M0000 - M3777	R40600 - R40777		OCT 8 *1
Special Relay	SP000 - SP777	R41200 - R41237		OCT 8 *1
Timer (Contact)	T000 - T377	R41100 - R41117		OCT 8 *1
Counter (Contact)	C000 - C377	R41140 - R41157		OCT 8 *1
Stage	S0000 - S1777	R41000 - R41077		OCT 8 *1
Timer (Elapsed Value)	-	R0000 - R0377		OCT 8
Counter (Elapsed Value)	-	R1000 - R1377		OCT 8
Data Register	-	R1400 - R7377		OCT 8 BIT 15
Special Register *2	-	R700 - R777 R7400 - R7777		OCT 8 BIT 15
Extension Register	-	R10000 - R36777		OCT 8 BIT 15

*1 When bits are written, the Display reads the corresponding word address from the External Device, sets particular bits of that word address to ON, and then returns the resulting address to the External Device. Note that the correct data may not be written if you change the word address using the ladder program while the Display reads data from the External Device and returns it.















*2 Data cannot be written.

NOTE

- Please refer to the GP-Pro EX Reference Manual for system data area.
Cf. GP-Pro EX Reference Manual "LS Area (Direct Access Method Area)"
- Please refer to the precautions on manual notation for icons in the table.
☞ "Manual Symbols and Terminology"

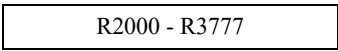
6.3 KOSTAC SZ Series

 : This address can be specified as system data area.

Device	Bit Address	Word Address	32 bit	Remarks
Input Relay	I0000 - I0477	R40400 - R40423		 *1
Output Relay	Q0000 - Q0477	R40500 - R40523		 *1
Internal Relay	M0000 - M0377	R40600 - R40617		 *1
Special Relay	SP000 - SP137 SP540 - SP617	R41200 - R41205 R41226 - R41230		 *1
Timer (Contact)	T000 - T177	R41100 - R41107		 *1
Counter (Contact)	C000 - C177	R41140 - R41147		 *1
Stage	S000 - S777	R41000 - R41037		 *1
Timer (Elapsed Value)	-	R000 - R177		
Counter (Elapsed Value)	-	R1000 - R1177		
Data Register	-	 R2000 - R3777		 
Special Register	-	R7746 - R7777		 

*1 When bits are written, the Display reads the corresponding word address from the External Device, sets particular bits of that word address to ON, and then returns the resulting address to the External Device. Note that the correct data may not be written if you change the word address using the ladder program while the Display reads data from the External Device and returns it.

NOTE

- Please refer to the GP-Pro EX Reference Manual for system data area.













Cf. GP-Pro EX Reference Manual "LS Area (Direct Access Method Area)"

- Please refer to the precautions on manual notation for icons in the table.

 "Manual Symbols and Terminology"

6.4 KOSTAC PZ3 Series

 : This address can be specified as system data area.

Device	Bit Address	Word Address	32 bit	Remarks
Input Relay	I0000 - I0777	R40400 - R40437	L/H	 *1
Output Relay	Q0000 - Q0777	R40500 - R40537		 *1
Internal Relay	M0000 - M1777	R40600 - R40677		 *1
Special Relay	SP000 - SP777	R41200 - R41237		 *1
Timer (Contact)	T000 - T377	R41100 - R41117		 *1
Counter (Contact)	C000 - C177	R41140 - R41147		 *1
Stage	S0000 - S1777	R41000 - R41037		 *1
Timer (Elapsed Value)	-	R00000 - R41177		 *1
Counter (Elapsed Value)	-	R01000 - R41147		 *1
Data Register	-	R1400 - R7377 R10000 - R17777		 
Special Register	-	R41200 - R41237	 	

*1 When bits are written, the Display reads the corresponding word address from the External Device, sets particular bits of that word address to ON, and then returns the resulting address to the External Device. Note that the correct data may not be written if you change the word address using the ladder program while the Display reads data from the External Device and returns it.

NOTE

- Please refer to the GP-Pro EX Reference Manual for system data area.













Cf. GP-Pro EX Reference Manual "LS Area (Direct Access Method Area)"

- Please refer to the precautions on manual notation for icons in the table.

 "Manual Symbols and Terminology"

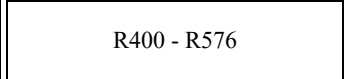
6.5 KOSTAC SR Series

 : This address can be specified as system data area.

Device	Bit Address	Word Address	32 bit	Remarks
I/O Relay	000 - 157 700 - 767	R000 - R014 R070 - R076 (first half 1 byte)	L/H	  *1
Internal Relay	160 - 377 770 - 777	R016 - R036 R076 (latter half 1 byte)		  *1
Shift Register	400 - 577	R040 - R056		  *1
Timer/Counter (Contact)	600 - 677	R060 - R066		  *1
Timer/Counter (Elapsed Value)	-	R600 - R677		
Data Register	-	 R400 - R576		  

*1 When bits are written, the Display reads the corresponding word address from the External Device, sets particular bits of that word address to ON, and then returns the resulting address to the External Device. Note that the correct data may not be written if you change the word address using the ladder program while the Display reads data from the External Device and returns it.

NOTE

- Please refer to the GP-Pro EX Reference Manual for system data area.















Cf. GP-Pro EX Reference Manual "LS Area (Direct Access Method Area)"

- Please refer to the precautions on manual notation for icons in the table.

 "Manual Symbols and Terminology"

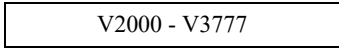
6.6 DL-205 Series

 : This address can be specified as system data area.

Device	Bit Address	Word Address	32 bit	Remarks
Input Relay	X0000 - X0477	V40400 - V40423		 *1
Output Relay	Y0000 - Y0477	V40500 - V40523		 *1
Control Relay	C0000 - C0377	V40600 - V40617		 *1
Special Relay	SP000 - SP137 SP320 - SP617	V41200 - V41205 V41215 - V41230		 *1
Timer (Contact)	T000 - T177	V41100 - V41107		 *1
Counter (Contact)	CT000 - CT177	V41140 - V41147		 *1
Stage	S000 - S777	V41000 - V41037		 *1
Timer (Elapsed Value)	-	V0000 - V0177		
Counter (Elapsed Value)	-	V1000 - V1177		
Data Register	-	 V2000 - V3777		 
Special Register	-	V7746 - V7777		 

*1 When bits are written, the Display reads the corresponding word address from the External Device, sets particular bits of that word address to ON, and then returns the resulting address to the External Device. Note that the correct data may not be written if you change the word address using the ladder program while the Display reads data from the External Device and returns it.

NOTE

- Please refer to the GP-Pro EX Reference Manual for system data area.















Cf. GP-Pro EX Reference Manual "LS Area (Direct Access Method Area)"

- Please refer to the precautions on manual notation for icons in the table.

 "Manual Symbols and Terminology"

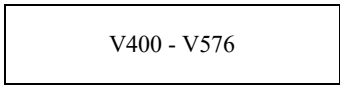
6.7 DL-305 Series

 : This address can be specified as system data area.

Device	Bit Address	Word Address	32 bit	Remarks
I/O Relay	000 - 157 700 - 767	V000 - V014 V070 - V076 (first half 1 byte)	L / H	  *1
Control Relay	160 - 377 770 - 777	V016 - V036 V076 (latter half 1 byte)		  *1
Shift Register	400 - 577	V040 - V056		  *1
Timer/Counter (Contact)	600 - 677	V060 - V066		  *1
Timer/Counter (Elapsed Value)	-	V600 - V677		 
Data Register	-	 V400 - V576		  

*1 When bits are written, the Display reads the corresponding word address from the External Device, sets particular bits of that word address to ON, and then returns the resulting address to the External Device. Note that the correct data may not be written if you change the word address using the ladder program while the Display reads data from the External Device and returns it.

NOTE

- Please refer to the GP-Pro EX Reference Manual for system data area.

















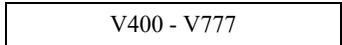

Cf. GP-Pro EX Reference Manual "LS Area (Direct Access Method Area)"

- Please refer to the precautions on manual notation for icons in the table.

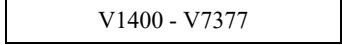
 "Manual Symbols and Terminology"

6.8 DL-405 Series (D4-430, D4-440)

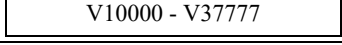
 : This address can be specified as system data area.

Device	Bit Address	Word Address	32 bit	Remarks
Input Relay	X000 - X477	V40400 - V40423	L / H	 *1
Output Relay	Y000 - Y477	V40500 - V40523		 *1
Link Relay	GX0000 - GX1777	V40000 - V40077		 *1
Link Output Relay	GY0000 - GY3777	V40200 - V40377		 *1
Control Relay	C0000 - C1777	V40600 - V40677		 *1
Special Relay	SP000 - SP137 SP320 - SP717	V41200 - V41205 V41215 - V41234		 *1
Timer (Contact)	T000 - T377	V41100 - V41117		 *1
Counter (Contact)	CT000 - CT177	V41140 - V41147		 *1
Stage	S0000 - S1777	V41000 - V41077		 *1
Timer (Elapsed Value)	-	V0000 - V0377		 *1
Counter (Elapsed Value)	-	V1000 - V1177		 *1
Data Register 1	-	 V400 - V777		 
Data Register 2	-	 V1400 - V7377		 
Special Register	-	V7400 - V7777		 
Data Register 3	-	 V10000 - V37777	 	























*1 When bits are written, the Display reads the corresponding word address from the External Device, sets particular bits of that word address to ON, and then returns the resulting address to the External Device. Note that the correct data may not be written if you change the word address using the ladder program while the Display reads data from the External Device and returns it.

NOTE

- Please refer to the GP-Pro EX Reference Manual for system data area.
Cf. GP-Pro EX Reference Manual "LS Area (Direct Access Method Area)"
- Please refer to the precautions on manual notation for icons in the table.
 "Manual Symbols and Terminology"

6.9 DL-405 Series (D4-454)

 : This address can be specified as system data area.

Device	Bit Address	Word Address	32 bit	Remarks
Input Relay	X0000 - X1777	V40400 - V40477	L/H	 *1
Output Relay	Y0000 - Y1777	V40500 - V40577		 *1
Remote Input	GX0000 - GX3777	V40000 - V40177		 *1
Remote Output	GY0000 - GY3777	V40200 - V40377		 *1
Control Relay	C0000 - C3777	V40600 - V40777		 *1
Special Relay	SP000 - SP777	V41200 - V41237		 *1
Timer	T000 - T377	V41100 - V41117		 *1
Counter	CT000 - CT377	V41140 - V41157		 *1
Stage	S0000 - S1777	V41000 - V41077		 *1
Timer (Current Value)	-	V0000 - V0377		 *1
Counter (Current Value)	-	V1000 - V1377		 *1
Data Register 1	V400.00 - V777.15	 V400 - V777		 
Data Register 2	V1400.00 - V7377.15	 V1400 - V7377		 
Special Register	V7400.00 - V7777.15	V7400 - V7777	 	
Data Register 3	V10000.00 - V37777.15	 V10000 - V37777	 	















*1 When bits are written, the Display reads the corresponding word address from the External Device, sets particular bits of that word address to ON, and then returns the resulting address to the External Device. Note that the correct data may not be written if you change the word address using the ladder program while the Display reads data from the External Device and returns it.

NOTE

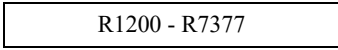
- Please refer to the GP-Pro EX Reference Manual for system data area.
 - Cf. GP-Pro EX Reference Manual "LS Area (Direct Access Method Area)"
 - Please refer to the precautions on manual notation for icons in the table.
-  "Manual Symbols and Terminology"

6.10 Direct Logic 05 Series

 : This address can be specified as system data area.

Device	Bit Address	Word Address	32 bit	Remarks
Input Relay	I0000 - I0377	R40400 - R40417	L / H	 *1
Output Relay	Q0000 - Q0377	R40500 - R40517		 *1
Internal Relay	M0000 - M0777	R40600 - R40637		 *1
Special Relay	SP000 - SP777	R41200 - R41237		 *1
Timer (Contact)	T000 - T177	R41100 - R41107		 *1
Counter (Contact)	C000 - C177	R41140 - R41147		 *1
Stage	S000 - S377	R41000 - R41017		 *1
Timer (Elapsed Value)	-	R000 - R177		 *1
Counter (Elapsed Value)	-	R1000 - R1177		 *1
V-Memory	-	 R1200 - R7377		  *2
V-Memory Nonvolatile	-	R7400 - R7577		 
System Parameter	-	R7600 - R7777		 

*1 When bits are written, the Display reads the corresponding word address from the External Device, sets particular bits of that word address to ON, and then returns the resulting address to the External Device. Note that the correct data may not be written if you change the word address using the ladder program while the Display reads data from the External Device and returns it.

*2 No bits can be set for R1200 to R1377.

NOTE

- Please refer to the GP-Pro EX Reference Manual for system data area.















Cf. GP-Pro EX Reference Manual "LS Area (Direct Access Method Area)"

- Please refer to the precautions on manual notation for icons in the table.

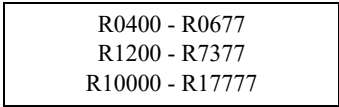
 "Manual Symbols and Terminology"

6.11 Direct Logic 06 Series

 : This address can be specified as system data area.

Device	Bit Address	Word Address	32 bit	Remarks
Input Relay	I0000 - I0777	R40400 - R40437	L / H	 *1
Output Relay	Q0000 - Q0777	R40500 - R40537		 *1
Internal Relay	M0000 - M1777	R40600 - R40677		 *1
Special Relay	SP000 - SP777	R41200 - R41237		 *1
Timer (Contact)	T000 - T377	R41100 - R41117		 *1
Counter (Contact)	C000 - C177	R41140 - R41147		 *1
Stage	S0000 - S1777	R41000 - R41077		 *1
Timer (Elapsed Value)	-	R000 - R377		 *1
Counter (Elapsed Value)	-	R1000 - R1177		 *1
V-Memory	-	 R0400 - R0677 R1200 - R7377 R10000 - R17777		  *2
V-Memory Nonvolatile	-	R7400 - R7577		 
System Parameter	-	R700 - R777 R7600 - R7777 R36000 - R37777		 

*1 When bits are written, the Display reads the corresponding word address from the External Device, sets particular bits of that word address to ON, and then returns the resulting address to the External Device. Note that the correct data may not be written if you change the word address using the ladder program while the Display reads data from the External Device and returns it.

*2 No bits can be set for R1200 to R1377.

NOTE

- Please refer to the GP-Pro EX Reference Manual for system data area.

Cf. GP-Pro EX Reference Manual "LS Area (Direct Access Method Area)"

- Please refer to the precautions on manual notation for icons in the table.

 "Manual Symbols and Terminology"

7 Device Code and Address Code

Use device code and address code when you select "Device Type & Address" for the address type of the data display or other devices.

■KOSTAC SG/KOSTAC SU/KOSTAC SZ/KOSTAC PZ3/Direct Logic 05/Direct Logic 06 Series

Device	Device Name	Device Code (HEX)	Address Code
Input Relay	I/R	0080	Word Address
Output Relay	Q/R	0081	Word Address
Link Relay	GI/R	0082	Word Address
Link Output Relay	GQ/R	0083	Word Address
Internal Relay	M/R	0084	Word Address
Special Relay	SP/R	0085	Word Address
Timer (Contact)	T/R	00E0	Word Address
Counter (Contact)	C/R	00E1	Word Address
Stage	S/R	0004	Word Address
Timer (Elapsed Value)	R	0060	Word Address
Counter (Elapsed Value)	R	0061	Word Address
Data Register 1	R	0000	Word Address
Data Register 2	R	0001	Word Address
Special Register	R	0002	Word Address
Data Register 3	R	0003	Word Address

■KOSTAC SR Series

Device	Device Name	Device Code (HEX)	Address Code
I/O Relay (R000 - R014)	.../R	0080	Value of word address divided by 2
I/O Relay (R070 - R076)			
Internal Relay (R016 - R036)			
Internal Relay (R076)			
Shift Register			
Timer/Counter (Contact)			
Timer/Counter (Elapsed Value)	R	0060	Word Address
Data Register	R	0000	Value of word address divided by 2

■DL-205/DL-405 Series

Device	Device Name	Device Code (HEX)	Address Code
Input Relay	X/V	0080	Word Address
Output Relay	Y/V	0081	Word Address
Link Relay	GX/V	0082	Word Address
Link Output Relay	GY/V	0083	Word Address
Control Relay	C/V	0084	Word Address
Special Relay	SP/V	0085	Word Address
Timer (Contact)	T/V	00E0	Word Address
Counter (Contact)	CT/V	00E1	Word Address
Stage	S/V	0004	Word Address
Timer (Elapsed Value)	V	0060	Word Address
Counter (Elapsed Value)	V	0061	Word Address
Data Register 1	V	0000	Word Address
Data Register 2	V	0001	Word Address
Special Register	V	0002	Word Address
Data Register 3	V	0003	Word Address

■DL-305 Series

Device	Device Name	Device Code (HEX)	Address Code
I/O Relay (V000 - V014)	.../V	0080	Value of word address divided by 2
I/O Relay (V070 - V076)			
Control Relay (V016 - V036)			
Control Relay (V076)			
Shift Register			
Timer/Counter (Contact)			
Timer/Counter (Elapsed Value)	V	0060	Word Address
Data Register	V	0000	Value of word address divided by 2

8 Error Messages

Error messages are displayed on the Display screen as follows: "No.: Device Name: Error Message (Error Occurrence Area)". Each description is shown below.

Item	Description
No.	Error No.
Device Name	Name of the External Device where an error has occurred. Device name is the title of the External Device set with GP-Pro EX. ((Initial value [PLC1]))
Error Message	Displays messages related to an error that has occurred.
Error Occurrence Area	<p>Displays the IP address or device address of the External Device where an error has occurred, or error codes received from the External Device.</p> <p>NOTE</p> <ul style="list-style-type: none"> • IP address is displayed as "IP address (Decimal): MAC address (Hex)". • Device address is displayed as "Address: Device address". • Received error codes are displayed as "Decimal [Hex]".

Display Examples of Error Messages

"RHAA035: PLC1: Error has been responded for device write command (Error Code: 1[01H])"

NOTE

- Refer to your External Device manual for details on received error codes.
- Refer to "Display-related errors" in "Maintenance/Troubleshooting Guide" for details on the error messages common to the driver.

■ Error Codes Specific to the External Device

Error codes specific to the External Device are shown below.

Error Code	Description
01	A timeout has occurred on the serial link.
04	Unavailable I/O data has been requested.
0C	During the header transfer, an error has occurred even after three retries.
0D	During the data transfer, an error has occurred even after three retries.
14	<p>During the data block transfer, one or more of the following errors have occurred:</p> <ul style="list-style-type: none"> - Invalid STX has been received. - Invalid ETB has been received. - Invalid ETX has been received. - Invalid LRC has been received. - A parity error, framing error, or overrun error has occurred.
15	EOT reception from the parent station has resulted in failure.
16	ACK/NAK reception has resulted in failure during the wait state.

Error Code	Description
1D	Except during the header/data transfer, one or more of the following errors have occurred: <ul style="list-style-type: none">- Invalid STX has been received.- Invalid ETB has been received.- Invalid ETX has been received.- Invalid LRC has been received.- A parity error, framing error, or overrun error has occurred.
1E	During the header transfer, one or more of the following errors have occurred: <ul style="list-style-type: none">- Invalid SOH has been received.- Invalid ETB has been received.- Invalid LRC has been received.- A parity error, framing error, or overrun error has occurred.

