

Pro-faceTM

by **Schneider** Electric

Pour plus d'information, visitez notre site internet :

[proface.fr](https://www.proface.fr)

Contact France

<https://www.proface.com/fr/assistance>

©2023 Schneider Electric Japan Holdings Ltd. All Rights Reserved.

Basic HMI

Advanced HMI

Industrial PC

Outdoor HMI

Catalogue Produits Pro-face 2023

Trouvez le meilleur IHM parmi une large gamme de produits

proface.fr

Pro-faceTM

by Schneider Electric

Le concept HMI Centric

L'IHM est l'interface qui connecte l'humain à la machine en lui permettant d'accéder aux données de production et de pilotage de son process.

Les solutions HMI Centric de Pro-face combinent le meilleur des technologies numériques afin de faciliter la centralisation et la contextualisation des données IT & OT.

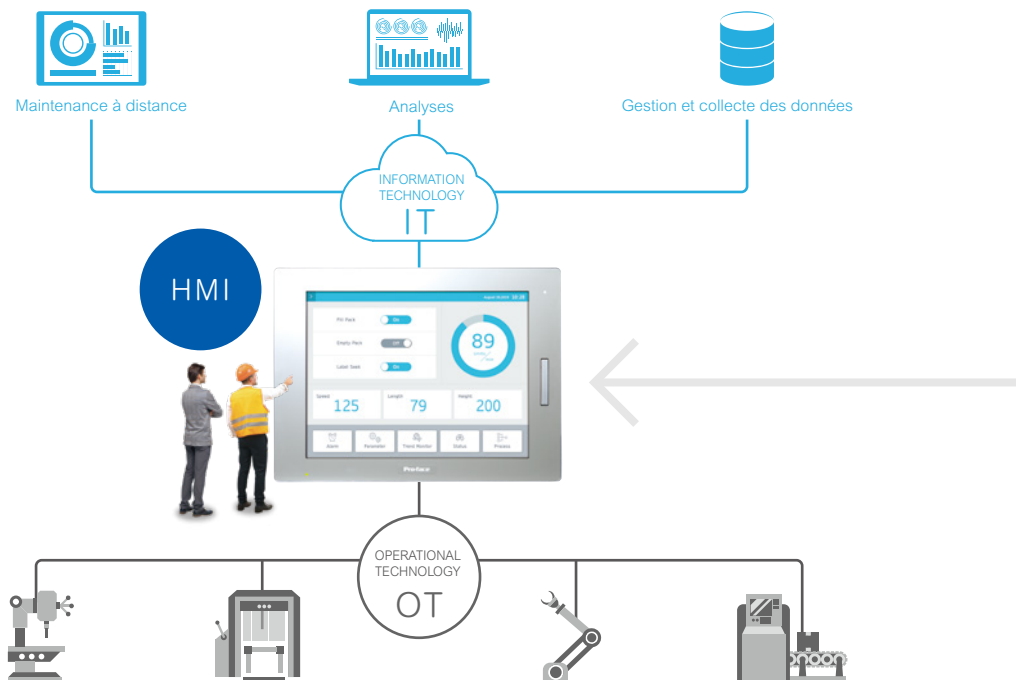

HMI Centric Customer Story

Pro-face au coeur des machines nouvelles générations. En particulier pour les applications mobiles.

Flexibilité
élevée

Temps de développement réduit

de **75%**

Le temps de développement habituel de trois ans a été réduit de 75 % pour atteindre environ un an.

Visualisation
efficace

Efficacité

+200%

L'utilisation d'un écran lumineux et d'une surveillance à distance a permis d'améliorer l'exploitation de 200 %.

Fiabilité
démontrée

Réduction de Maintenance

de **30%**

L'efficacité de la maintenance du site a augmenté de 30 % grâce au soutien de spécialistes de l'IHM.

En savoir plus



Flexibilité élevée

Une connectivité native et une largeur de gamme permettant d'adresser des besoins variés



Connectivité OT / IT

Connectez-vous directement à un large éventail d'équipements et de réseaux avec différents fournisseurs.



Offre évolutive et personnalisable

Une large gamme de produits avec capacité de personnalisation pour répondre aux besoins spécifiques des clients.



Système Collaboratif

Services intégrés et prêt à l'emploi pour accéder aux machines à distance, en mobilité et en toute sécurité.

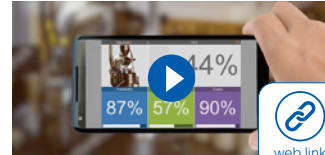

Visualisation Efficace

Des technologies de conception graphique gages de performances



Mise en page optimisée

Outils de conception intuitifs permettant d'optimiser la mise en page pour un accès rapide à l'information.

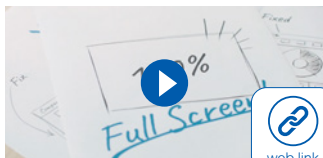

Augmenter la valeur des informations

Interfaces riches et expressives avec un fonctionnement intuitif qui permet d'utiliser facilement un grand nombre de données.



Expérience tactile moderne

Ecrans haute résolution et sensibilité tactile adaptée pour un affichage fluide et performant.



Fiabilité démontrée

Une gestion simple du parc installé



Solutions robustes et cybersécurisées

Basées sur les meilleures pratiques depuis que le premier IHM au monde (série GP) a été développé en 1989.

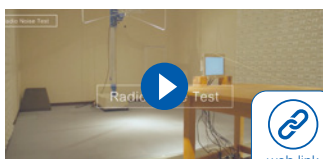

Commercialisation & Support Technique

Vente et Support Technique assurés par un réseau d'experts IHM présent dans le monde entier.

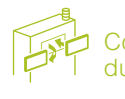

Comptabilité ascendante du matériel

Investissement permanent pour faire évoluer nos offres en intégrant de nouvelles innovations mais sans rupture technologique.



Architectures HMI Centric



Adoptez une architecture HMI Centric – centrée sur l'IHM – vous développerez plus rapidement vos projets IHM avec nos solutions testées et validées par nos experts.



Flexibilité élevée - Connectivité native permettant d'adresser des besoins variés -

Gestion des données simple et facile grâce à l'IHM STM6000 Box et une base de données SQL

L'IHM STM6000 Edge Box peut communiquer simultanément avec plusieurs contrôleurs et fournir des données à la base de données SQL. Il s'agit d'un transfert de données facile et à moindre coût entre la couche OT et la couche IT de l'entreprise. Gérez facilement vos données à l'aide de l'IHM STM6000 Edge Box.



Sécurisation de l'accès à distance avec un routeur 4G sans réseau local

Accédez en toute sécurité à votre IHM et aux appareils connectés sans avoir besoin d'un routeur VPN dédié. Pro-face Connect peut activer l'architecture cryptée et certifiée CEI 62443-3-3 et gérer les utilisateurs avec différents niveaux d'accès et ce de manière centralisée.

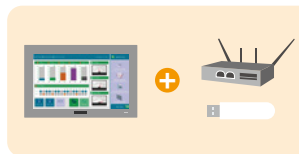

Connexion à distance avec votre smartphone

Vous pouvez facilement effectuer la maintenance à distance et de manière sécurisée sur 3G/4G en utilisant votre smartphone comme point d'accès, même dans des environnements où un réseau est inexistant ou bien le réseau de l'utilisateur final n'est pas disponible sur site.

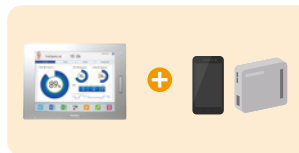

Service de surveillance à distance avec une application Cloud

Activez le service de surveillance à distance à travers une application Cloud. Vous pouvez démarrer rapidement de nouveaux services de surveillance à distance à l'aide d'un service cloud, comme par exemple Amazon AWS ou Microsoft Azure.

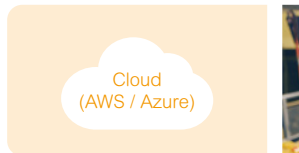

Visualisation efficace - Rendre vos collaborateurs performants -

Activez des services basés sur le Cloud avec la STM6000 Edge Box HMI & EcoStruxure Machine Advisor

L'IHM STM6000 Edge Box avec EcoStruxure Machine Advisor permet aux constructeurs de machines de fournir de nouveaux services aux opérateurs pour chaque machine installée sur n'importe quel site de production dans le monde. Activez de nouveaux services digitaux basés sur le cloud sur votre machine.

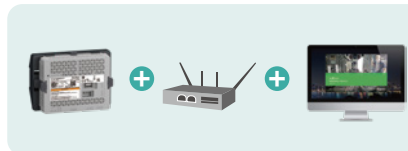

Maintenance moderne basée sur la réalité augmentée (AR) avec des solutions PC et logicielles industrielles

Vous pouvez mettre en place rapidement la technologie AR (réalité augmentée) dans votre usine et démarrer une maintenance intelligente pour améliorer facilement les opérations de maintenance.



Traçabilité basée sur l'identification au moyen de la RFID

Profitez d'applications de traçabilité développées facilement avec une communication sans programmation. L'IHM communique avec les lecteurs/enregistreurs RFID via Modbus. Cela vous permet une traçabilité efficace et la préparation de votre production numérisée.



Donnez aux opérateurs les moyens d'améliorer votre site avec une caméra réseau

Les caméras réseau attirent beaucoup l'attention en tant qu'outil d'amélioration de site, en particulier pour les gros équipements et les machines multifonctionnelles. En capturant des scènes qui ne sont pas perceptibles à l'oeil nu ou non détectables après une analyse des données, vous serez en mesure de découvrir de manière fiable des événements auparavant inconnus.

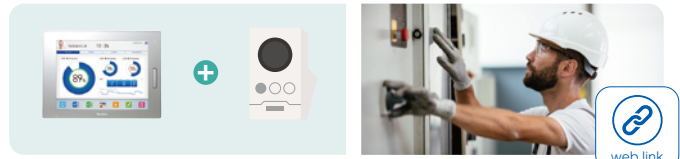

Des informations disponibles partout grâce à notre BOX IHM sans avoir besoin d'une IHM fixe

Exploitez toutes les performances de vos projets IHM en mobilité grâce à la BOX IHM sans écran dissimulable dans une armoire électrique. Grâce à la connectivité Pro-face, vous avez accès aux informations importantes de vos divers équipements depuis votre tablette ou smartphone avec toute les fonctionnalités qu'offre une IHM. Dans les grandes installations, les positions peuvent être identifiées par des QR codes garantissant la disponibilité des bonnes informations et que les bonnes opérations peuvent être effectuées.



Robot IHM

Dans le passé, un technicien de robot devait utiliser un pendentif d'apprentissage spécial pour déterminer l'état du robot et le restaurer lorsqu'une erreur se produisait. Avec le Robot IHM, Un exemple d'écran dédié est disponible avec le Robot IHM permettant à quiconque de vérifier l'état du robot sur l'IHM.



Fiabilité démontrée - Une gestion simple du parc installé -

Solution de sécurité digitale sur votre machine avec un IHM et la reconnaissance faciale

Réalisez un système sécurisé sans contact avec votre IHM. Connexion/déconnexion facile dans un environnement spécifique, tel qu'une salle blanche, un environnement poussiéreux, huileux ou dangereux dans lequel la machine fonctionne.

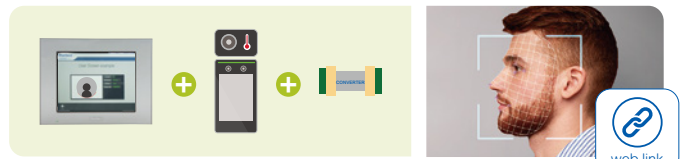

Gestion d'accès fiable avec lecteur de carte d'identité (NFC)

Les mesures de sécurité peuvent être facilement mises en oeuvre en utilisant l'IHM pour gérer les opérations des équipements et des installations qui sont exploités par plusieurs opérateurs ou qui ont des processus spéciaux.



Collaboration

Réduire le coût de la maintenance

IHM + Yaskawa

If Si vous êtes devant votre IHM, vous pouvez immédiatement vérifier et régler l'état du robot / servo/ contrôleur de machine. Réduisez le temps d'ouverture du panneau de commande et le temps de réglage avec un pendentif d'apprentissage ou un PC !

Robot



Servo



Contrôleur Machine

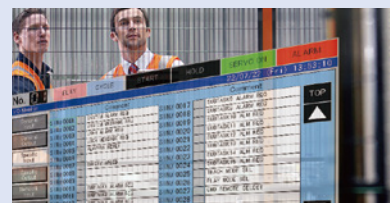

Efficacité opérationnelle

IHM + IAI ELECYLINDER

Surveillez et utilisez l'écran [Simple Data Setting] du pendentif d'enseignement depuis l'écran tactile de votre IHM Pro-face. L'IHM peut être utilisée comme pendentif d'apprentissage pour IAI ELECYLINDER. Les opérateurs peuvent surveiller non seulement l'état des appareils IAI sur l'IHM, mais également l'état de l'API et d'autres contrôleurs sur l'IHM.



Panorama des offres Pro-face

Données	Simple	Complexe	Gestion de ligne	Extérieur
++++			PC Industriel PS6000/PS5000	
+++		IHM Haute-performance SP5000	11 PC Industriel 12 Collecte Données 13 Écran Plat Industriel	Outdoor IHM 14 SP5000X
++	IHM Basique ST6000	IHM Standard GP4000		
+	IHM Compacte 15 GP4100			

ST6000 Series BLUE GP-Pro EX VERSION UP

- 1 IHM Basique (ST6000)
- 2 BIHM Basique Modulaire (STM6000)
- 3 Collecte Données Basique (STM6000 Gateway)
- 4 IHM Web Basique (STW6000)

PS6000/PS5000 Series BLUE Line Management Liv. SCADA Open Studio VERSION UP

- 11 PC Industriel PC (PS6000 / PS5000)
- 12 Collecte Données (PS6000 / PS5000)
- 13 Écran Plat Industriel (FP6000 / SP5000 + option / PS5000 + option)

GP4000 Series GP-Pro EX VERSION UP

- 5 IHM Standard (GP4000)
- 6 IHM + Contrôle (LT4000M)
- 7 Collecte Données (LT4000M)

SP5000X Series GP-Pro EX VERSION UP







- 14 Outdoor HMI (SP5000X)

SP5000 Series GP-Pro EX VERSION UP

- 8 IHM Avancée (SP5000)
- 9 IHM + Contrôle (SP5000+option)
- 10 Collecte Données (SP5000+option)

GP4100 Series GP-Pro EX VERSION UP

- 15 IHM Compacte (GP4100)

Spécifications		Simple			Complex	Line management	Outdoor
		 GP4100	 ST6000	 GP4000	 SP5000	 PS6000/PS5000	 SP5000X
Logiciel		GP-Pro EX	BLUE	GP-Pro EX	GP-Pro EX	BLUE Open Studio	GP-Pro EX
Logiciel / Licence annexe	Surveillance à distance	Pro-face Remote HMI	Web Viewer License	Pro-face Remote HMI	Pro-face Remote HMI	Licence Client Léger	Pro-face Remote HMI
	Service connexion à distance	Non	Pro-face Connect	Pro-face Connect	Pro-face Connect	Pro-face Connect	Pro-face Connect
Visualisation	Taille écran	4"w	4"w, 7"w, 10"w, 12"w, 15"w	3.5", 5.7", 7.5", 10.4", 12.1" 7"w	10", 12", 15" 7"w, 10"w, 12"w, 15"w, 19"w	12", 15" 10"w, 12"w, 15"w, 19"w, 22"w	7"w, 12"w, 15"w
	Qualité Affichage (Résolution, couleur)	++	++	+	++	+++	+++++ (Lisible au soleil)
	Performance	Standard	Standard	Standard	Haute	Haute	Haute
Opération	Opération Tactile	+	+	+	++	+++	+
Connectivité	IT (Ethernet)	0 or 1	2 (4"w:1)	1	2	2	2
	OT (En série, USB, Fieldbus)	+	++	++	+++	+++	+++
	I/O	Non	Non	Oui (avec LT4000M)	Oui (avec SP-5B10 + option)	Oui (Option)	Oui (Option)
	Opération Sauvegarde Données	+	+	++	++	+++	++
Gestion Données	Stockage	0	SD x 1(10.4") Stockage Local (avec BLUE)	0 ou SD x 1	SD x 1 ou SD x 2	HDD/SSD x 1	SD x 2
Environnement	Robustesse environnement	+	+	+	++	+	+++
	Certification (Haz Loc, ATEX, Marine)	+++	+	+++	+++	++	++
Fonctionnalités	Intégration Apps Windows	Non	Non	Non	Oui (avec SP-5B41)	Oui	Non
	Connexion IT (OPC, MQTT, Email, etc)	+	+++	++	++	++++	++



Industrial PC

PS6000 Series

BLUE Line Management Lite SCADA

Open Studio



Improve your productivity with the most reliable PC-based architecture experience.

New PS6000 from the HMI leader: Robust as a terminal, Open and High-performant as a PC, even more economical.

New Experience

01 New Experience for Automation Engineers

A rich modular catalog and a strong background of customization service.

To run any software, including pre-installed bundles.

Easily selected with new Product Configurator and with quick delivery.

Software

BLUE Line Management Lite SCADA
Open Studio

Pro-face Connect
Secure Remote Access over Internet

AVEVA

Java .NET C++ Raid
Thin client Security MS Office etc.



COST DOWN



TIME SAVE



QUICK DELIVERY

BOX

Core i7 Core i5
Celeron
Advanced Box
Standard Box
Core i3

Display

12" 15"
Resistive multi touch
4:3
wide
Capacitive multi touch
10" Wide 12" Wide 15" Wide
19" Wide 22" Wide

Options

HDD / SSD Slot-in design
Interfaces Slot-in design
PCI / PCIe² Slots module

*1 10" Wide is available with only Standard Box.
*2 PCI / PCIe is supported for only Advanced Box.

02 A new Experience for Operators and Production Managers

High-performance with the latest CPU and Innovative display for smart manufacturing.

To run securely, on most demanding industrial environments.

Standard mode
Glove mode
Water Detection mode

Quickly change display type for operators situation with configuration.



03 A new Experience for Maintenance Specialists

Smart maintenance to reduce downtime and improve productivity.

Long Term Peace of Mind thanks to long availability, global support and training.

Long Availability

Quick Response
Special Support
Quick Deliver

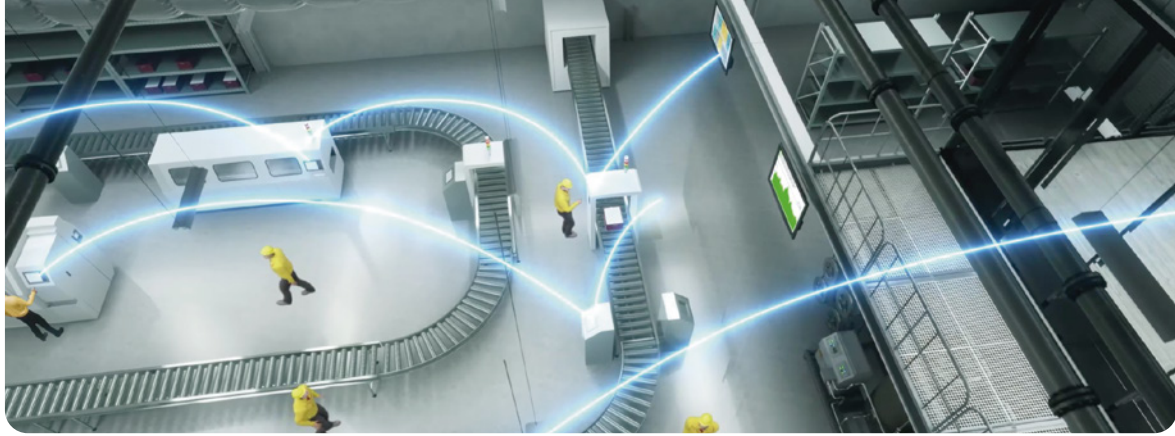

Selection guide

Associated software can run on Pro-face Industrial PCs to make the next stage of your digital transformation.

Combining with Pro-face Industrial PCs								
	Lite SCADA		Remote Visualization	Plant SCADA and Historian	Augmented Operator	IIoT solution	Secured Remote Connection	
Software name	 BLUE Open Studio		 Remote HMI Server	 AVEVA System Platform	 EcoStruxure Augmented Operator Advisor	 Node-RED	 Pro-face Connet	
Software runtime license for Industrial PC <Model No.>	1.5K tags <PFXBOSRT1KA>	32K tags <PFXBOSRT32KA>	Thin Client License <PFXBOSTCA>	Remote HMI Server Licisce <PFXEXRHLS>	License from AVEVA distributor	Server License	-	Pro-face Connect License 30 days Free Trial <PFXCONFREE30>
	4K tags <PFXBOSRT4KA>	64K tags <PFXBOSRT64KA>						
PS6000 Advanced Celeron Core i5 Core i7 	★★	★★★★	★★★★	★★★★	★★★★	★★★★	★★★★	★★★★
	Configured To Order with software license + software pre-installed*		User install	User install	User install	Installed by default	User install	
PS6000 Standard Core i3 	★★★★	★★	★★★★	★★	★★	★★	★★★★	★★★★
	Configured To Order with software license + software pre-installed*		User install	User install	User install	Installed by default	User install	
PS5000 Atom 	★★	★	★★★★	★	★	★	★★★★	★★★★
	User install	User install	User install	User install	User install	User install	User install	User install

* The installer of AVEVA System Platform can be found on the desktop. The selection of the software to be installed and related installation procedure is to be done by the user.

* The license needs to be purchased separately from AVEVA / AVEVA Distributor.

* For technical support related to AVEVA software, please contact AVEVA / AVEVA local Distributor.



Rich options to meet your needs, easily selected with a new Product Configurator with quick delivery.



PCI/PCIe*1 Slot module



Advanced box



Display

Front USB

Resistive Multi-touch



Capacitive +Glasstop Multi-touch with optimized noise filter

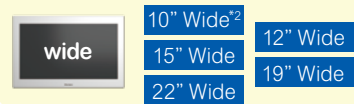

Touch Mode Configuration

HDD/SSD Slot-in design

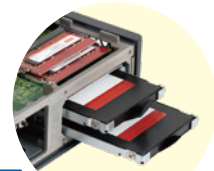

Interfaces Slot-in design



2 x RS-232C Isolated	
Product Name	Model No.
M.2 SSD 128GB (Standard Endurance)	PFXYP6M2128L
M.2 SSD 128GB (High Endurance)	PFXYP6M2128
M.2 SSD 256GB (High Endurance)	PFXYP6M2256
M.2 SSD 512GB (High Endurance)	PFXYP6M2512
SSD 128GB (High Endurance)	PFXYP6SSD128
SSD 256GB (High Endurance)	PFXYP6SSD256
SSD 512GB (High Endurance)	PFXYP6SSD512
HDD 1TB	PFXYP6HDD1T

Interfaces	
Product Name	Model No.
2 x RS-232C Isolated	PFXYP6MPR23P2
4 x RS-232C	PFXYP6MPR23P4
2 x RS422 / 485 Isolated	PFXYP6MPR42P2
16DI / 8DO	PFXYP6MPX16Y8
Ethernet (GbE IEEE1588)	PFXYP6MPETH
Audio	PFXYP6MPAU
4G Cellular for US	PFXYP6MP4GU
4G Cellular for EU / Asia / Japan	PFXYP6MP4GE
EtherCAT	PFXYP6MPECAT
WiFi / Bluetooth	PFXYP6MPWF



*1 10" Wide is available with only Standard Box, not supported for Advanced Box. *2 PCI / PCIe is supported for only Advanced Box.

Box module			
	Advanced Box *1		Standard Box
CPU	Core i7	Core i5	Celeron
Core	4		2
Thread	8		4
Graphics accelerator	Intel UHD Graphics 620		Intel UHD Graphics 610
DIMM	8 - 32GB		4 - 16GB
Storage	M.2 SSD x 1 2.5" HDD / SSD x 2		M.2 SSD x 1 2.5" HDD / SSD x 1
USB	USB TypeA : USB2.0 x 2, USB3.0 x 2 USB TypeC : USB3.0 x 1 (DP connection)		
Ethernet	IEEE1588 x 2 10 / 100 / 1000 Wake-on-LAN (WOL)		
Serial	RS-232C x 1 (not isolated)		
Display Port	DP x 1		
Slot-in Option I/F	2 slots		1 slot
Expansion slots	PCI x 1 + PCIe x 1 or PCIe x 2 or PCI x 2		
Operating System	Windows10 IoT Enterprise 2019 LTSC (64bit)		
Certification *2	CE, UL and cUL, UKCA, RMC, KC, EAC, ATEX / IECEX, DNV-GL, RoHS, WEEE		

Display module						
Display Size	12"	15"	10"W *3	12"W	15"W	19"W 22"W
Resolution	XGA (1,024 x 768)		WXGA (1,280 x 800)		FWXGA (1,366 x 768)	Full HD (1,920 x 1,080)
Display Type	TFT Color LCD					
Touch Panel Type	Resistive multi-touch (2 points)		Capacitive Multi-touch (2 points) with optimized noise filter			
Touch Mode Configuration	Not applicable, because of a resistive analog touch panel		Yes-Standard mode-Glove mode,-Water detection mode			
Front USB	USB (Type A) x 1 *4		-			

*1 PCI / PCIe is supported for only Advanced Box. *2 Please check the webpage for the latest certification

*3 10" Wide is available with only Standard Box, not supported for Advanced Box. *4 By default, the USB is disabled

Dimension: PFXDM6800WC + Advanced BOX + Expansion slot + Fan

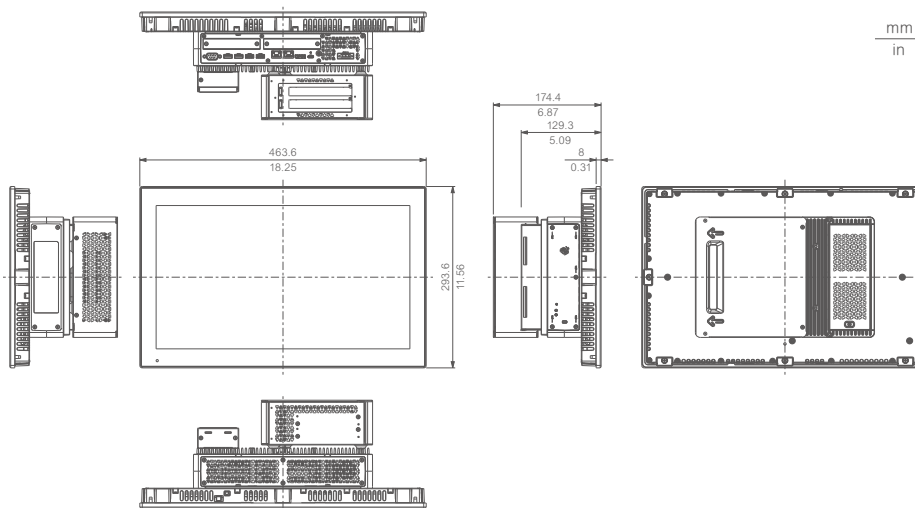

PS5000 Series



website

Combine the box type and the display in a range of sizes from 12 to the ultra-large 22 inches.

Flexibly change the functions and sizes. The box is a stand-alone component and can be connected to various displays.

Box Module			
	PS-5001B		
Model	Atom		Atom (Entry)
CPU	Atom E3930 1.3 GHz		
Storage memory	M.2 SSD (64GB / 128GB / 256GB)	M.2 SSD (64 GB / 128 GB / 256 GB) or HDD *1 (500 GB / 1 TB) SSD *2 (256 GB)	eMMC (64 GB / 128 GB)
Main Memory	4 GB or 8 GB, DDR3		4 GB, DDR3L
Rated Input Voltage	12...24 Vdc		
OS	Win10 IoT Enterprise (64bit)		
Interface	RS-232C x 1, RS-232C / 422 / 485 x 1, Ethernet x 2, USB (Type A) x 4, Display Port x 2		RS-232C x 1, RS-232C / 422 / 485 x 1, Ethernet x 2, USB (Type A) x 2, Display Port x 1
Optional interface	None	x 1	x 1
Expansion Slot	0 slot		

*1 For secondary storage only.

Display Module						
	PS-5900W	PS-5800W	PS-5700W	PS-5600W	PS-5700T	PS-5600T
Display Size	22" Wide	19" Wide	15" Wide	12" Wide	15"	12"
Rated Input Voltage	100...240Vac / 24 Vdc					
Resolution	1,920 x 1,080pixels (Full HD)	1,366 x 768pixels (FWXGA)	1,280 x 800pixels (WXGA)	1,024 x 768pixels (XGA)		
Touch Panel Type	Capacitive (5 simultaneous touch)			Resistive Film (single touch)		
Structure	IP66					



Advanced HMI

SP5000 Series GP-Pro EX



Flagship model achieving high performance and robust network security

The SP5000 series is an HMI that provides information quickly and efficiently, and promotes "smartification" of your factories.

Flagship

01 Manage more information in various forms

Fully compatible for direct use with Windows applications, the SP5000 can handle materials, such as manuals and error codes, without conversion.



No need to bring PC for debugging and JOB reprogramming.

MS Excel

PDFs

Movies

Ladder programming tools

Able to use ladder programming tools...



02 Simple activation by inserting cards

Display data is scalable to fit multiple sizes of monitors, which can be applied to new equipment for mass production. There is no need for on-site data transfer because SP5000 models are activated when the SD card is inserted.

15"

12"

10"

Auto-scaling



1GB

SP5000 works simply by replacing the card.

This is a time-efficient way to carry out on-site troubleshooting.



03 Network segmentation

All displays of SP5000 series have two Ethernet I/F ports as standard. The IP address is changed on the SP5000 at delivery.

Only the IP LAN2 address within the office network is changed.

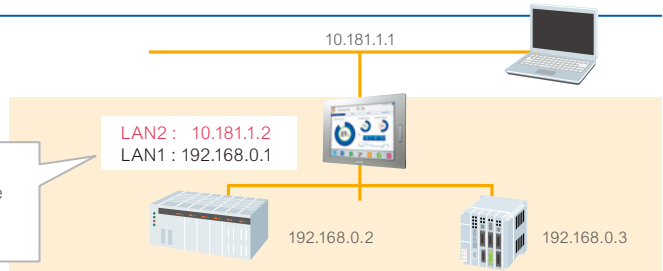

And more...

Cost Reduction and Equipment Improvement with I/O expansion

Using the option unit allows you to connect equipment that requires simple control + HMI, additional I/O expansion and remote I/O expansion.

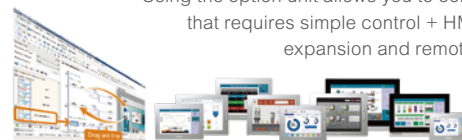

Premium Display						
	SP-5800WC	SP-5700WC	SP-5700TP	SP-5660TP	SP-5600TP	SP-5500TP
Model	PFXSP5800WCD	PFXSP5700WCD	PFXSP5700TPD	PFXSP5660TPD	PFXSP5600TPD	PFXSP5500TPD
Display Size	19" wide	15" wide	15"	12"		10"
Rated Input Voltage	12...24 Vdc					
Resolution	1,366 x 768 pixels (FWXGA)		1,024 x 768 pixels (XGA)			800 x 600 pixels (SVGA)
Touch Panel Type	Projected Capacitive (5 points multi-touch)			Resistive Film (analog, 2 points multi-touch)		
Interface	USB (Type A) x 1 USB (mini B) x 1					
Structure	IP65F, IP67F					
External Dimensions*1	W483 x H337 x D69mm (W19.02 x H13.27 x D2.72 in.)	W414 x H295 x D69mm (W16.30 x H11.61 x D2.72 in.)	W397 x H296 x D67mm (W15.6 x H11.7 x D2.64 in.)	W315 x H241 x D67mm (W12.4 x H9.49 x D2.64 in.)		W272.5 x H214.5 x D67mm (W10.73 x H8.44 x D2.64 in.)
Panel Cut Dimensions	W465 x H319mm (W18.31 x H12.56 in.)	W396 x H277mm (W15.59 x H10.91 in.)	W383.5 x H282.5mm (W15.1 x H11.12 in.)	W301.5 x H227.5mm (W11.87 x H8.96 in.)		W259 x H201mm (W10.2 x H7.91 in.)
Others	Brightness Sensor, Auto Scaling					
Custom (Coating)	-			Yes		
Custom (Front Color Bezel)	-			Yes		
Certification *2	CE, UL / cUL, UKCA, UL / cUL for Haz Loc, UKEX, RCM, KC, EAC, Marie, RoHS, WEEE					

*1 The depth is combined with Box Module *2 Please check the webpage for the latest certification

Advanced Display				
	SP-5600TA	SP-5600WA	SP-5500WA	SP-5400WA
Model	PFXSP5600TAD	PFXSP5600WAD	PFXSP5500WAD	PFXSP5400WAD
Display Size	12"	12" wide	10" wide	7" wide
Rated Input Voltage	12...24 Vdc			
Resolution	1,024 x 768 pixels (XGA)	1,280 x 800 pixels (WXGA)		800 x 480 pixels (WVGA)
Touch Panel Type	Resistive Film (analog)			
Interface	-			
Structure	IP66F, IP67F, TYPE 4X (Indoor Use Only) / 13			
External Dimensions*1	W315 x H241 x D67 mm (W12.4 x H9.49 x D2.64 in.)	W308.5 x H230.5 x D67mm (W12.15 x H9.07 x D2.64 in.)	W268.5 x H198.5 x D67mm (W10.57 x H7.81 x D2.64 in.)	W203.6 x H148.6 x D67mm (W8.02 x H5.85 x D1.42 in.)
Panel Cut Dimensions	W301.5 x H227.5mm (W11.87 x H8.96 in.)	W295 x H217mm (W11.61 x H8.54 in.)	W255 x H185mm (W10.04 x H7.28 in.)	W190 x H135mm (W7.48 x H5.31 in.)
Others	-			
Custom (Coating)	Yes			
Custom (Front Color Bezel)	Yes			

*1 The depth is combined with Box Module

3 types of Box Modules			
	SP-5B41	SP-5B10	SP-5B00
Model	PFXSP5B412*1 / PFXSP5B41	PFXSP5B10	PFXSP5B00
Application Memory	Screen Size: 64 MB		
Backup Memory	NVRAM 320KB		
Interface	RS-232C / 422 / 485 x 2 Ethernet x 2 USB (Type A) x 3, USB (mini B) x 1 SD Card Slot (Storage) x 1 CFast Card Slot (System) x 1 CFast Card Slot (Storage) x 1 DVI-D output x 1 Sound Input: MIC or LINE input x 1 Speaker Output x 1 Alarm Output or Buzzer Output x 1	RS-232C / 422 / 485 x 2 Ethernet x 2 USB (Type A) x 2, USB (mini B) x 1 SD Card Slot (System) x 1 SD Card Slot (Storage) x 1 Speaker Output x 1 Alarm Output or Buzzer Output x 1	RS-232Cx 1 RS-422 / 485 x 1 Ethernet x 2 USB (Type A) x 2, USB (mini B) x 1 SD Card Slot (Storage) x 1
Windows Application	Yes	-	-
Expansion Unit	-	Yes	-
Connectable Devices	4		
Custom (Coating)	Yes		

*1 PFXSP5B412 will be released in 2022.

Dimension: SP-5600TP + SP-5B00

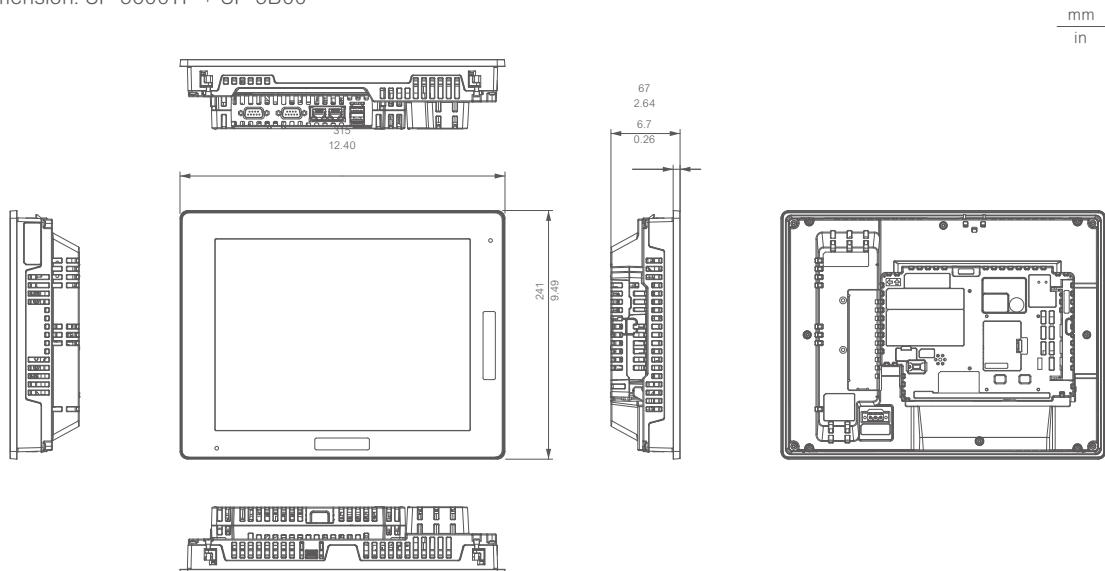



Outdoor HMI

SP5000X Series *GP-Pro EX*



An outdoor HMI that is visible under sunlight, and resists extreme environment

We have created a sunlight readable screen that is resistant to direct sunlight and extreme temperatures. With an enhanced information display unit and improved operability, this product is suitable for multiple applications under harsh environmental conditions including use in special purpose vehicles such as firetrucks and construction equipment; parking lots and gas stations; and the oil and gas industry.

Extreme

01 Sunlight Readable

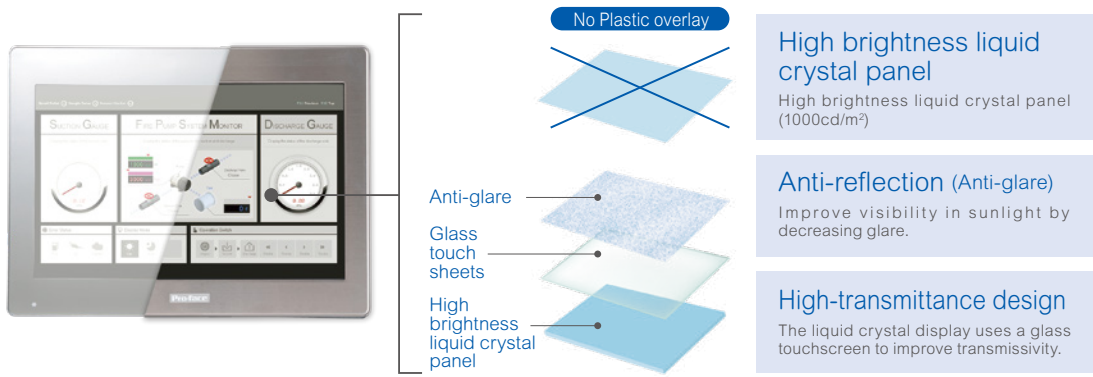

02 Robustness



UV Protection

Improve UV protection and prevent deterioration by replacing plastic components that are exposed to sunlight with metal or glass.



Full Coating

Improve the longevity of the product even when used in outdoor environments with dust and extreme temperatures by adding coating on the substrate, LCD, and power source components.

03 Environmental Resistance

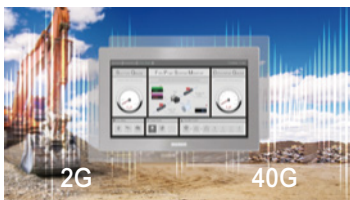

Sufficient against Vibration/Shock

We do apply IEC60068-2-6 or IEC60068-2-27 in stead of IEC61131-2 test which is typically used for factory automation devices. Because they are more suitable for earth moving machines, or generators or compressors which use engines to operate machines.

* Display Module : 7" w: 2G / 40G, 15" w: 1G / 15G
Box Module : follow the connected Display Module.



Operating temperature: -30°C to 70°C

Can be used in harsher environments without the need for anti-frost heaters or fans and cooling systems.

* Display Module : 7" w: -30 to 65°C, 12" w: -30 to 70°C, 15" w: -20 to 60°C
Box Module : follow the connected Display Module.



Dust and waterproof

Compatible with IP66F, IP67F, Type 4X (indoor and outdoor use) allowing for use in harsh outdoor conditions.

04 Maintainability

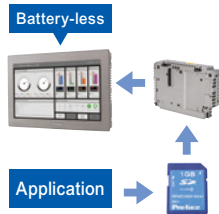

Modular structure that is easy to maintain

It is possible to replace the exposed display without changing the whole unit. The box is designed with the application pre-installed and can be used immediately upon changing components. Changes can be made quickly and easily without the need of a PC, optimizing time and resources.

05 IoT Solution



Data collection and remote maintenance

Collect data remotely from a PC such as error history and operation status, outcome, and history. It is also possible to access the HMI, verify the operation status, and conduct maintenance remotely via PC or tablet.

Display Module			
	SP-5790WA	SP-5690WA	SP-5490WA
Model	PFXSP5790WA / PFXSP5790WADF0H	PFXSP5690WA / PFXSP5690WADF0H	PFXSP5490WA / PFXSP5490WADF0H
Display type	TFT Color LCD (High brightness)		
Display size	15.6" wide	12.1" wide	7" wide
Resolution	1,366 x 768 pixels (FWXGA)	1,280 x 800 pixels (WXGA)	800 x 480 pixels (WVGA)
Display colors	262,144 colors		
Backlight	White LED (Not user replaceable. When replacement is required, contact customer support.)		
Touchpanel lifetime	1,000,000 times or more		
Rated input voltage	12...24 Vdc		
Power consumption	Max. 48 W	Max. 37 W	Max. 29 W
Ambient air temperature	-20 to 60 °C (-4 to 140 °F)	-30 to 70 °C (-22 to 158 °F)	-30 to 65 °C (-22 to 149 °F)
Dust	0.1 mg/m ³ (10 ⁻² oz/ft ³) or less (non-conductive levels)		
Pollution degree	3 for front face, 2 for other sides		
Corrosive gases	Free of corrosive gases Harsh environment model (Model numbers ending with "F0H") : IEC/EN 60721-3-3 Class 3C3		
Atmospheric pressure (operating altitude)	800 to 1,114 hPa (2,000 m [6,561 ft] or lower)		
UV resistance (front side)	Cutoff: 99% or more (380 nm)		
Vibration resistance	IEC 60068-2-6 compliant 5 to 9 Hz Single amplitude 3.5 mm (0.14 in) 9 to 150 Hz Fixed acceleration: 9.8 m/s ² X, Y, Z directions for 10 cycles (approximately 100 minutes) IEC 61373: 1999 (Category 1, Class B) 5 ≤ f ≤ 150 Hz (weight < 500 kg: f1=5 Hz, f2=150 Hz) acceleration: Up and down: 7.90 m/s ² , Right and left: 3.50 m/s ² , Back and forward: 5.50 m/s ²	IEC 60068-2-6 compliant 5 to 9 Hz Single amplitude 7 mm (0.28 in) 9 to 150 Hz Fixed acceleration: 19.6 m/s ² X, Y, Z directions for 10 cycles (approximately 100 minutes) IEC 61373: 1999 (Category 1, Class B) 5 ≤ f ≤ 150 Hz (weight < 500 kg: f1=5 Hz, f2=150 Hz) acceleration: Up and down: 7.90 m/s ² , Right and left: 3.50 m/s ² , Back and forward: 5.50 m/s ²	
Shock resistance	IEC 60068-2-27 compliant 147 m/s ² , 11 ms, X, Y, Z directions for 3 times	IEC 60068-2-27 compliant 392 m/s ² , 11 ms, X, Y, Z directions for 3 times	
Electronic fast / transient / burst immunity	IEC 61000-4-4 / 2 kV: Power port / 1 kV: Signal ports		
Electrostatic discharge immunity	Contact discharge method: 6 kV Air discharge method: 8 kV (IEC/EN 61000-4-2 Level 3)		
Structure	IP66F, IP67F, Type 4X (indoor and outdoor use), Type 12, Type13		
External dimensions	408 x 264 x 68 mm (16.06 x 10.39 x 2.68 in)	308.5 x 230.5 x 68 mm (12.15 x 9.07 x 2.68 in)	203.6 x 148.6 x 37 mm (8.02 x 5.85 x 1.45 in)
Front bezel materials	Aluminum die-cast / Stainless steel		
Certification	CE, UL/cUL, UKCA, UL/cUL for Haz Loc, UKEX, RCM, KC, EAC, IECEx / ATEX, RoHS, WEEE		

Box Module	
Model	SP-5B90
Application Memory	Screen Size: 64 MB
Backup Memory	NVRAM 320KB
Interface	RS-232C / 422 / 485 x 2, Ethernet x 2, USB (Type A) x 2, USB (mini B) x 1, SD Card Slot (System) x 1, SD Card Slot (Storage) x 1, Speaker Output x 1, Alarm Output or Buzzer Output x 1
Expansion unit	Fieldbus Unit x 1 (PROFIBUS / J1939 / CANopen / FLEX NETWORK)
Connectable Devices	4

Dimension: SP-5690WA + SP-5B90

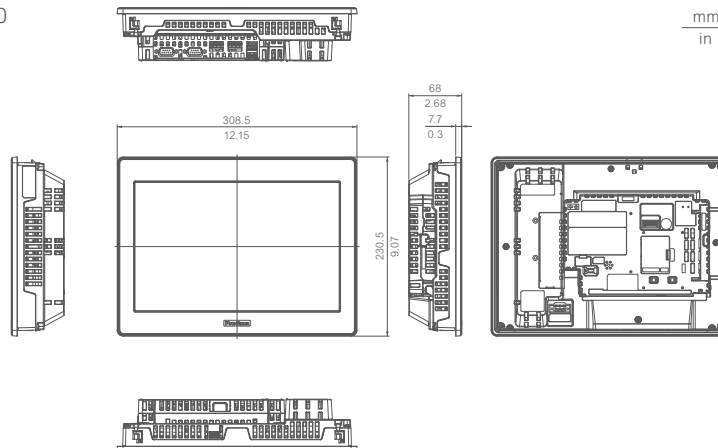



website



video



manual



datasheet



CAD



software (BLUE)



software (GP-Pro EX)

Basic HMI **NEW**

ST6000 Series

BLUE **GP-Pro EX**



Achieve a high level of visualization with the new basic HMI

The ST6000 series brings a new level of visualization to the Basic HMI market which no other basic product has accomplished.

New Visualization

01 Refined

An innovative HMI with a sophisticated design that transforms simple machines.



16 Million Colors

Achieve the previously unimaginable and bring displays to life with 16 million colors.



Better Graphics and Font

Display beautiful fonts with anti-aliasing. Customize gradation and transparency to meet your needs.

02 Simple & Easy

The simple design and interface help increase productivity and efficiency.

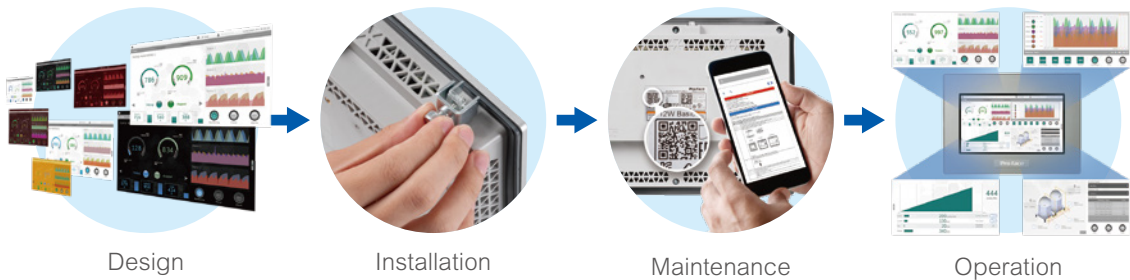

Easy Migration

GP-Pro EX

Panel cut-out compatibility

Utilize the current project data because of the same software(GP-Pro EX)

Minimum modification to install new HMI (Compatible Interface) same interface and almost the same interface location

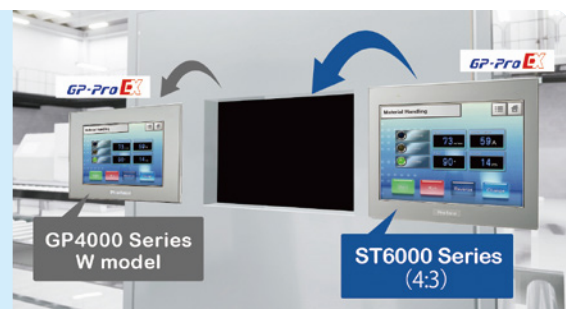

03 Connected & Secured

Seamless and secured connectivity with various devices to enhance their flexibility and increase value.

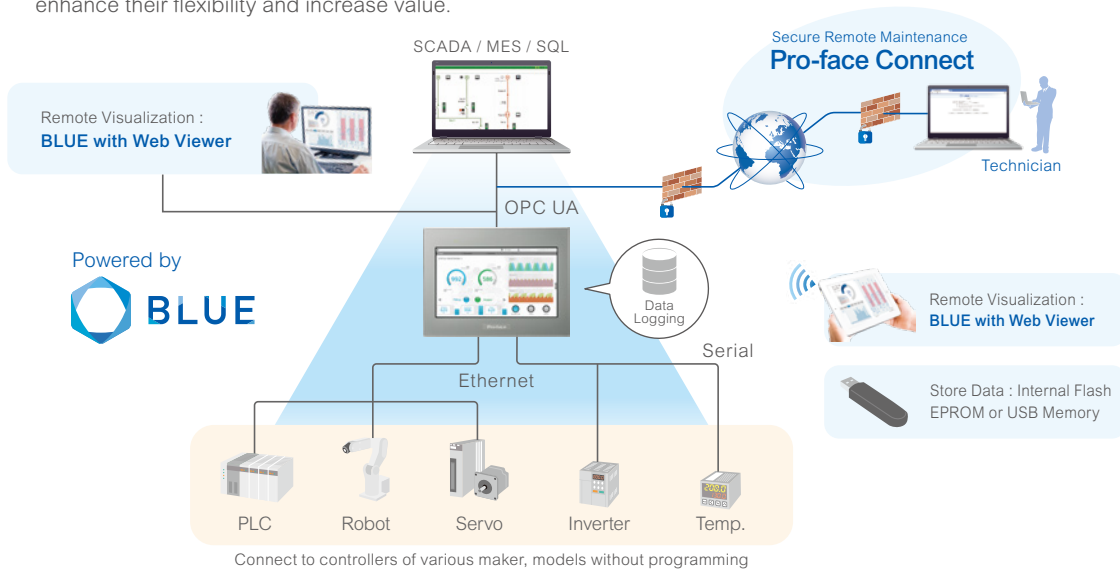

Dimension: ST-6400WA

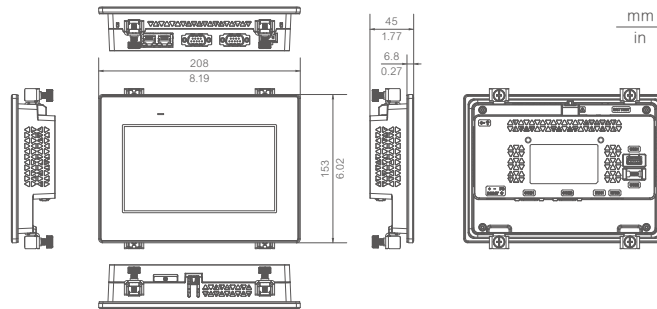

	ST-6700WA	ST-6600WA	ST-6500WA	ST-6400WA	ST-6200WA
Model No (BLUE)	PFXST6700WAD	PFXST6600WAD	PFXST6500WAD	PFXST6400WAD	PFXST6200WAD
Model No (GP-Pro EX)	PFXST6700WADE	PFXST6600WADE	PFXST6500WADE	PFXST6400WADE	PFXST6200WADE
Display	15.6" Wide (1,366 x 768)	12.1" Wide (1,280 x 800)	10.1" Wide (1,024 x 600)	7.0" Wide (800 x 480)	4.3" Wide (480 x 272)
Touch Panel	16M colors				
Interface	Type : Resistive film (analog), Service life : 1,000,000 times or more				
COM	RS-232C x 1, RS-422 / 485 x 1				RS-232C / 422 / 485 x 1
Ethernet	Ethernet x 2				Ethernet x 1
USB	Type A x 1 micro-B x 1				Type A x 1 micro-B x 1
Memory (BLUE)	Application memory : FLASH EPROM:128MB Backup memory : NVRAM 500KB Battery : Replaceable battery / Primary battery for clock data backup (5 years or more at room temperature)				
Memory (GP-Pro EX)	Application memory : Media : FLASH EPROM / Screen area: 64MB / User font area 8 MB / Logic program area: 132KB Backup memory : Screen Area: SRAM 320KB, Variable Area: SRAM 64KB Battery : Replaceable battery / Primary battery for clock data backup				
Input voltage	24 Vdc				
Structure	IP65F, Type 1, Type 4X (indoor use only), Type 13				
Certifications *1	CE, UL and cUL, UKCA, RCM, KC, EAC, RoHS, WEEE				

	NEW ST-6300T	NEW ST-6500T
Model No	PFXST6300TADE	PFXST6500TADE
Display	5.7"	10.4"
Resolution	262,144 colors 480 x 272	16M colors 800 x 600
Touch Panel	Type: Resistive film (analog), Serve life: 1,000,000 time or more	
Interface	RS-232 x 1, RS-422/485 x 1	
Ethernet	10BASE-T / 100BASE-TX x 1	
USB	Type A x 1, micro-B x 1	
SD	up to 32 GB	
Memory	Application memory : FLASH EPROM:64MB, Backup memory : Screen Area: MRAM 320KB, Variable Area: MRAM 64KB Battery : Replaceable battery / Primary battery for clock data backup (5 years or more at room temperature)	
Input voltage	19.2 to 28.8V DC	
Panel Cut Dimensions	301.5 x 227.5 mm(11.87 x 8.96 in)	156 x 123.5 mm(6.14 x 4.86 in)
Certifications *1	IP65F, Type 1, Type 4X (indoor use only), Type 13 (on the front panel when properly installed in an enclosure), CE, UL and cUL, UKCA, RMC, KC, EAC, RoHS, WEEE	
Structure	IP65F, Type 1, Type 4X (indoor use only), Type 13	

*1 Please check the webpage for the latest certification



website



video



manual



datasheet



CAD



software (BLUE)



software (GP-Pro EX)

Basic Modular HMI

STM6000 Series BLUE GP-Pro EX

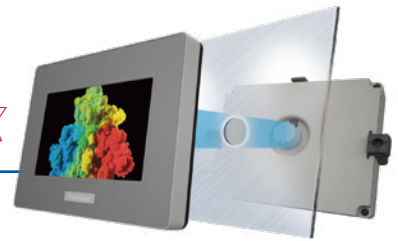

The STM6000 series in the complement of the ST6000 range brings a new level of visualization to the Basic HMI market which no other basic product has accomplished. Also, the product can be installed easily as no tools are necessary and very fast with the unique push-button mounting system through a $\phi 22$ mm circular hole.

01 Easy & Fast Installation

The product can be installed easily as no tools are necessary and very fast with the unique push-button mounting system through a $\phi 22$ mm circular hole.

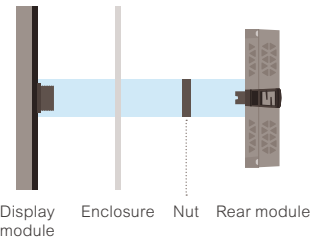

02 Flexible Installation

Thanks to modularity design, for specific applications (space, temperature, or vibration constraints) product can be separated with cable accessory 3m, 5m, 10m to install the Display module on the panel door and the rear module on DIN rail with dock station adapter.

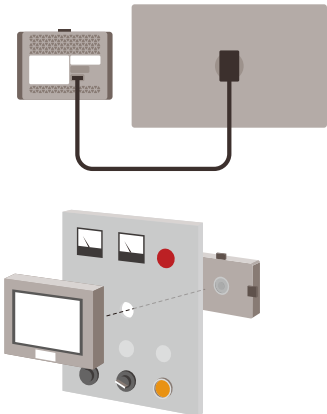

03 Easy Maintenance

Spare part front & rear modules are available to replace the faulty part.

	STM-6400WA	STM-6200WA
Model No(BLUE)	PFXSTM6400WAD	PFXSTM6200WAD
Model No(GP-Pro EX)	PFXSTM6400WADE	PFXSTM6200WADE
Display	7.0" Wide (800 x 480)	4.3" Wide (480 x 272)
	16M colors White LED 16 level brightness control	
Touch Panel	Type: Resistive film (analog) , Serve life: 1,000,000 time or more	
Interface	RS-232C / 485 / 422 x 1 Ethernet x 2 USB (Type A) x 1 USB (micro-B) x 1	
Memory	Application memory : FLASH EPROM:128MB, Backup memory : NVRAM 500KB Battery : internal battery / Primary battery for clock data backup (5 years or more at room temperature)	
Input voltage	19.2 to 28.8V DC	
Structure	IP65F , UL 50/50E , Type 1 , Type 4X (indoor use only), Type 12, Type 13,	
Certifications *1	CE, UL/cUL, RCM, KC, EAC, ATEX/IECEx*1, Marine (ABS, RINA), RoHS, WEEE	

*1 Please check the webpage for the latest certification

Dimension: STM-6400WA

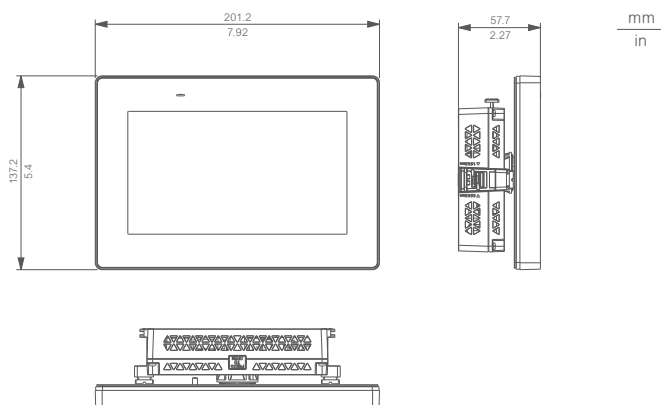

STW6000 Series

Many industrial automation devices support HTML5, which can be displayed on PCs, tablets, and smartphones. As a Web HMI, STW6000 can easily display HTML5 data from multiple devices. We are the HMI specialist, and the superior quality display, maintainability and robustness of our Web HMI meets the needs of simple machine applications for factory automation.

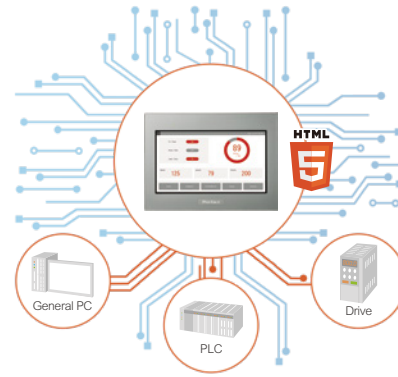

01 Main Display

Main display for simple machine is alternative to basic terminal.

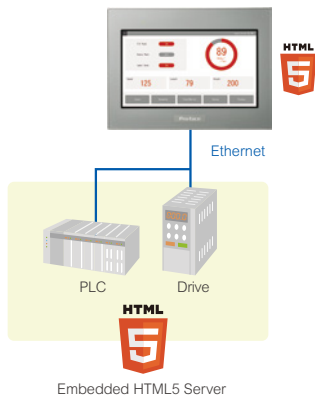

02 Secondary Display

Secondary cost effective display can also visualize small information for maintenance-diagnostic directly from PLC Servers or from the main display if it embeds its own server.

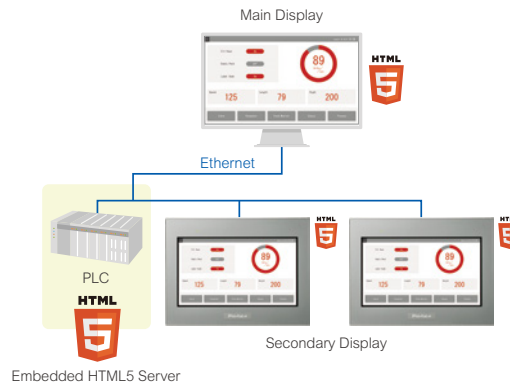

	STW-6700WA	STW-6600WA	STW-6500WA	STW-6400WA	STW-6200WA
Model No	PFXSTW6700WAD	PFXSTW6600WAD	PFXSTW6500WAD	PFXSTW6400WAD	PFXSTW6200WAD
Display	15.6" Wide (1,366 x 768)	12.1" Wide (1,280 x 800)	10.1" Wide (1,024 x 600)	7.0" Wide (800 x 480)	4.3" Wide (480 x 272)
Touch Panel	16M colors White LED 16 level brightness control Type:Resistive film (analog), Service life:1,000,000 times or more				
Related	Ethernet1 & Ethernet2 with switch function : IEEE802.3i / IEEE802.3u, 10BASE-T / 100BASE-TX USB : Type A x 1 (HOST)				Ethernet : IEEE802.3i / IEEE802.3u, 10BASE-T / 100BASE-TX x 1 USB : Type A x 1 (HOST)
Input voltage	24 Vdc				
Structure	IP65F, Type 1, Type 4X (indoor use only), Type 13				
Certifications *1	CE, UL and cUL, UKCA, RCM, KC, EAC, RoHS, WEEE				

*1 Please check the webpage for the latest certification

Dimension: STW-6400WA

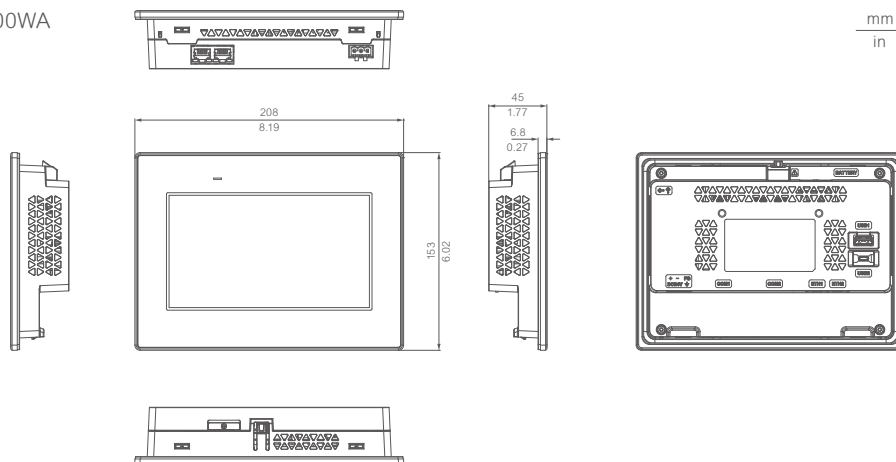



website



manual



datasheet



CAD



software

Standard HMI

GP4000 Series *GP-Pro EX*



Standard

Varied and flexible lineup satisfying customers needs

Combines abundant functions with a broad line-up of versatile models to meet the specific needs of every customer.

01 Widest line-up in the Pro-face brand

From classic to unique, we offer a wide range of choices to meet any application.



02 Compatible with our legacy models



Data in GP-PRO/PBIII for Windows or later is convertible using project converter. Smooth transition to the latest models.



USB expansion options unique to Pro-face

Reduce excess inventory of indicator lights

EZ Tower Light Model : PFXZCETWHA1 (tube mounting with fixing plate)
Model : PFXZCETWW1 (base mounting)

With this single model, multiple colors and sounds can be set. Capable of indicating the state of equipment.

- LED lamps adaptable to various types of setting
- Configuration from HMI
- 4 colors (red, green, blue, and yellow) and 3 modes (off, on, and blink)
- Number of lamps: 3
- Buzzer patterns: 4



Combining switch and lamp

EZ Illumination Switch Model : PFXZCCEUSG1

Improve visibility with 6-color illumination. Reduce man-hours for control panel installation and wiring

- LED light switches accept a wide range of settings
- Configuration by HMI design software
- 6 colors (red, green, blue, yellow, white, and orange) and 3 modes (off, on, and blink)
- Protection structure: IP65 (front face where panel is embedded)
- Mount: 22φ circular mounting hole

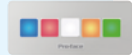

Work-saving for inputting repeated values

EZ Numpad Model : PFXZCCEUKB1

Reduces screens needed for value input

- Alphanumeric and customizable function keys (Set by HMI design software)
- Protection: IP65
- Mount: 22φ circular mounting hole



Adding second LAN port with independent IP address

EZ LAN Adapter Model : PFXZCGEUEE1

The GP4000 series also allows you to securely set up a network.

- Same functions as built-in LAN port
- 10BASE-T / 100BASE-TX
- Limited to GP4000 standard models



Also can be used with Pro-face products other than GP4000 series.



Standard models								
	GP-4601T	GP-4603T	GP-4501T	GP-4503T	GP-4401T	GP-4301T	GP-4303T	GP-4201T
Model	PFXGP4601T**	PFXGP4603TAD	PFXGP4501T**	PFXGP4503TAD	PFXGP4401TAD	PFXGP4301TAD	PFXGP4303TAD(isolation model)	PFXGP4201TAD
Display Size	12.1"		10.4"		7.5"	5.7"		3.5"
Rated Input Voltage	100...240 Vac / 24Vdc		100...240 Vac / 24Vdc		24Vdc			
Resolution	800 x 600pixels (SVGA)		640 x 480pixels (VGA)		320 x 240pixels (QVGA)			
Touch Panel Type	Resistive Film (analog)							
Application Memory	32MB				16MB			
Data Backup	SRAM 320KB							
Interface	RS-232C x 1,RS-422 / 485 x 1*,Ethernet x 1 USB (Type A) x 1,USB (mini B) x 1,SD Card Slot x 1							RS-232C / 422 / 485 x 1, Ethernet x 1,USB (Type A) x 1, USB (mini B) x 1,
Structure	IP65F							
External Dimensions	W315 x H241 x D56mm (W12.4 x H9.49 x D2.2 in.)		W272.5 x H214.5 x D57mm (W10.73 x H8.44 x D2.24 in.)		W218 x H173 x D60mm (W8.59 x H6.81 x D2.37 in.)	W169.5 x H137 x D59.5mm (W6.67 x H5.39 x D2.34 in.)		W132 x H106 x D42mm (W5.2 x H4.17 x D1.65 in.)
Panel Cut Dimensions	W301.5 x H227.5mm (W11.87 x H8.96 in.)		W259 x H201mm (W10.2 x H7.91 in.)		W204.5 x H159.5mm (W8.05 x H6.28 in.)	W156 x H123.5mm (W6.14 x H4.86 in.)		W118.5 x H92.5mm (W4.67 x H3.64 in.)
Connectable Devices	4							
Custom (Coating)	Yes							
Custom (Front Color Bezel)	Yes							
Rear Mount model (GP4000R)	Model:PFXGP4601TADR		Model:PFXGP4501TADR		Model:PFXGP4401TADR	Model:PFXGP4301TADR		-
External Video Unit-supporting Model	Product Name:GP-4621T Model:PFXGP4621TAA Model:PFXGP4621TAD (coating:Yes)		Product Name:GP-4521T Model:PFXGP4521TAA Model:PFXGP4521TAD (coating:Yes)		<div style="border: 1px solid black; padding: 5px; display: inline-block;"> Best choice for replacement! VM or RGB unit from GP3000 can be used without additional settings. </div> 			

** : [AA] Analog touchscreen & AC power supply; [MD] Matrix touchscreen & DC power supply; [AD] Analog touchscreen & DC power supply; [MA], Matrix touchscreen & DC power supply.
 * : GP-4*03T:RS-485 (isolation)

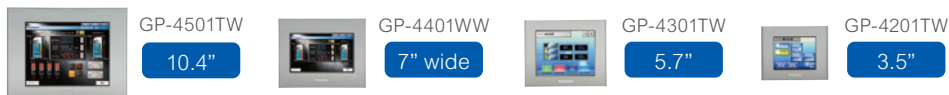

W models				
	GP-4501TW	GP-4401WW	GP-4301TW	GP-4201TW
Model	PFXGP4501TADW	PFXGP4401WADW	PFXGP4301TADW	PFXGP4201TADW
Display Size	10.4"	7"wide	5.7"	3.5"
Rated Input Voltage	24Vdc			
Resolution	640 x 480pixels (VGA)	800 x 480pixels (WVGA)	320 x 240pixels (QVGA)	
Touch Panel Type	Resistive Film (analog)			
Application Memory	16MB		8MB	
Data Backup	SRAM 128KB			
Interface	RS-232C x 1,RS-422 / 485 x 1,Ethernet x 1, USB (Type A) x 1,USB (mini B) x 1,SD Card Slot x 1,		RS-232C x 1,RS-422 / 485 x 1 Ethernet x 1*, USB (Type A) x 1,USB (mini B) x 1,	
Structure	IP65F			
External Dimensions	W315 x H241 x D56mm (W12.4 x H9.47 x D2.20 in.)	W218 x H173 x D60mm (W8.59 x H6.8 x D2.37 in.)	W169.5 x H137 x D59.5mm (W6.67 x H5.39 x D2.34 in.)	W132 x H106 x D42mm (W5.2 x H4.17 x D1.05 in.)
Panel Cut Dimensions	W301.5 x H227.5mm (W11.87 x H8.96 in.)	W204.5 x H159.5mm (W8.05 x H6.28 in.)	W156 x H123.5mm (W6.14 x H4.86 in.)	W118.5 x H92.5mm (W4.07 x H3.64 in.)
Connectable Devices	2			
Custom (Coating)	Yes			
Custom (Front Color Bezel)	Yes			

*:Excluding GP-4201W

GP4000R Rear mount model

Optimized for hygiene-oriented environments.

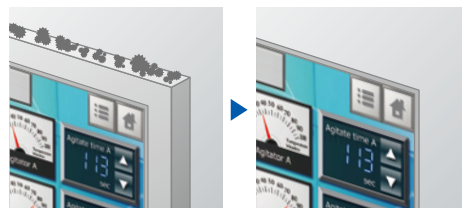

Flat design to protect from mounting surface from dust.
 Ideal for medical or food production equipment.



website

Hardware

GP4100 Compact model *GP-Pro EX* 4.3"



High resolution and full color in a small size

01 Small-sized HMI but no compromises visibility or operability

With a resolution of 480 x 272 pixels, information is finely displayed despite the limitations of space.

And more... **65,536** color display

Panel cut same as monochrome model

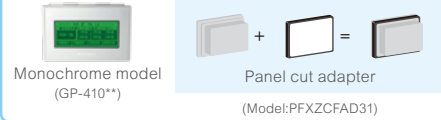

02 Connectivity with a range of devices

This product allows you to collect data and monitor everything remotely using a tablet.



	GP-4114T	GP-4115T	GP-4115T3	GP-4116T
Model	PFXGP4114T2D	PFXGP4115T2D	PFXGP4115T3D	PFXGP4116T2D
Display Size	4.3"			
Rated Input Voltage	12...24 Vdc			
Resolution	480 x 272 pixels			
Touch Panel Type	Analog			
Application Memory	8MB			
Backup Memory	FLASH EPROM 128KB		NVRAM 320KB	FLASH EPROM 128KB
Interface	Ethernet x 1 USB (Type A) x 1, USB (mini B) x 1	RS-232C x 1 USB (Type A) x 1, USB (mini B) x 1		RS-422/485 x 1 USB (Type A) x 1, USB (mini B) x 1
Structure	IP65F			
External Dimensions	W124.9 x H90.4 x D38.8mm (W4.92 x H3.56 x D1.53 in.)			
Panel Cut Dimensions	W112.5 x H77.5mm (W4.43 x H3.05 in.) With Panel cut adapter: W105 x H66mm (W4.13 x H2.6 in.)			
Connectable Devices	2			

GP4000H Handy model *GP-Pro EX* 5.7"



The latest handy display with high compatibility with the GP3000H models and reduced weight.

	GP-4311HT
Model	PFXGP4311HTAD
Display Size	5.7"
Rated Input Voltage	24Vdc
Resolution	640x480 pixels (VGA)
Touch Panel Type	Analog
Application Memory	32MB
Structure	IP65F
Connectable Devices	3
Interface	RS-232C / 422 / 485 x 1, Ethernet x 1, USB (Type A) x 1, USB (mini B) x 1, SD Card Slot x 1 Function Switch x 12, Switches: 1a2b 3-Position Enable Switch Output: 2a Key Switch Output: 1c <When using the conversion adapter> Operation Output x 1 External Buzzer Output x 1

Hard-type Direct-connect Cable	10m	GP3000H-CBLH-10M
	3m	GP3000H-CBLS-3M
Soft-type Direct-connect Cable	5m	GP3000H-CBLS-5M
	10m	GP3000H-CBLS-10M
Hard-type Direct-connect Cable (with connector)	10m	GP3000H-CBLHD-10M
	3m	GP3000H-CBLSD-3M
Soft-type Direct-connect Cable (with connector)	5m	GP3000H-CBLSD-5M
	10m	GP3000H-CBLSD-10M
Conversion Adapter	AGP3000H-ADPCOM-01	

LT4000M Series *GP-ProEX*

Hybrid display with control function

5.7" 3.5"

Since the release of the world's first controller with display (CGP model) in 1996, our products have gained a reputation for enabling customers to save space as well as equipment costs.



Flexible

- website
- video
- manual
- datasheet
- CAD
- software

01 Simple design without PLC

Connectivity with a range of devices.

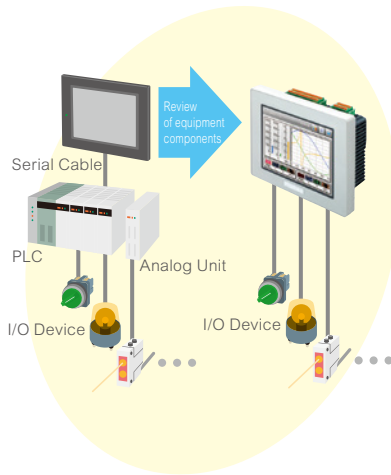

02 Easy to create control panels

Easily retrofittable, requiring only 22φ circular mounting holes

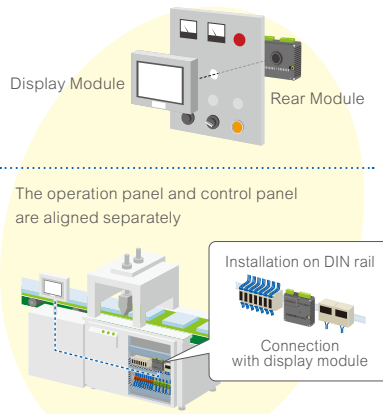

Product Name	Length	Model
Display module	3m	PFXZXMADSM31
Rear module separation cable	5m	PFXZXMADSM51

03 Create systems with reduced wiring using remote I/O.

Compatible with European standard CANopen. Communicate with CANopen compatible slave units with LT as master

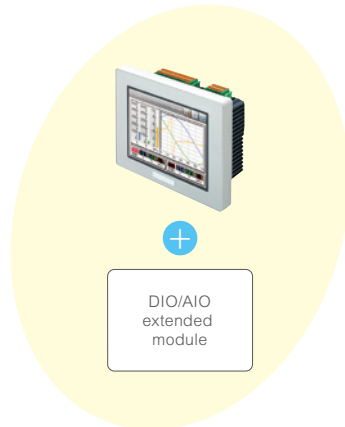

	LT-4301TM		LT-4201TM	
	PFXLM4301TADD*	PFXLM4301TADA*	PFXLM4201TADD*	PFXLM4201TADA*
Model	PFXLM4301TADD*	PFXLM4301TADA*	PFXLM4201TADD*	PFXLM4201TADA*
Display Size	5.7"		3.5"	
Rated Input Voltage	24Vdc			
Control	DIO	AIO+DIO	DIO	AIO+DIO
Resolution	320 x 240pixels (QVGA)			
Touch Panel Type	Resistive Film (analog)			
Application Memory	16MB			
Backup Memory	NVRAM 128KB			
Logic program area	FLASH EPROM 132KB			
Variable area	NVRAM 64KB			
Interface	RS-232C / 485 x 1 Ethernet x 1 USB (Type A) x 1 USB (mini B) x 1 CANopen (Master) x 1			
Structure	IP65F			
External Dimensions	Display Module:W163 x H129.4 x D17.5mm (W6.42 x H5.09 x D0.69 in.) Rear Module:W128 x H108 x D60.15mm (W5.03 x H4.25 x D2.36 in.)		Display Module:W97.6 x H80 x D16.2mm (W3.8 x H3.1 x D0.63 in.) Rear Module:W128 x H108 x D60.15mm (W5.03 x H4.25 x D2.36 in.)	
Panel Cut Dimensions	φ22.5mm			
Connectable Devices	4			
Built-in DIO (Input)	20 points (configurable 2 x High Speed counter / Pulse catch or 1 Up / Down High Speed Counter)	12 points (configurable 2 x High Speed counter / Pulse catch or 1 Up / Down High Speed Counter)	20 points (configurable 2 x High Speed counter / Pulse catch or 1 Up / Down High Speed Counter)	12 points (configurable 2 x High Speed counter / Pulse catch or 1 Up / Down High Speed Counter)
Built-in DIO (Output)	12 points (configurable 2 x PWM / Pulse)	8 points (configurable 2 x PWM / Pulse)	12 points (configurable 2 x PWM / Pulse)	8 points (configurable 2 x PWM / Pulse)
Built-in AIO (Input)	0 points	4 points (Voltage / Current x 2 - Temperature input x 2 included)	0 points	4 points (Voltage / Current x 2 - Temperature input x 2 included)
Built-in AIO (Output)	0 points	2 points (Voltage / Current x 2)	0 points	2 points (Voltage / Current x 2)

Pro-face Edge Box



Smart Gateway

Step Towards Smart Manufacturing

Pro-face Edge Box has industry-leading connectivity that enables collecting and utilizing data from various devices in various locations. Depending on your needs, you can choose the best-in-class data-collecting device from our wide range of lineups. Just add the Pro-face Edge Box; no need to change the current design. Let's start Smart Manufacturing with Pro-face Edge Box right now.

Edge Box PC

Application Integration

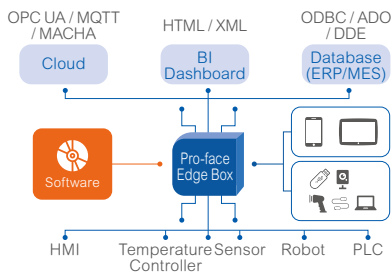

Production Monitor

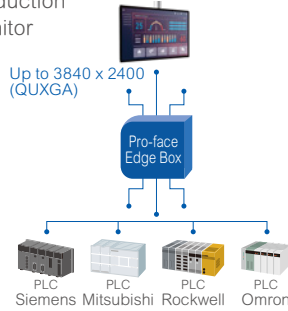

NEW

STM6000 Edge Box HMI

Get ready for Cloud service

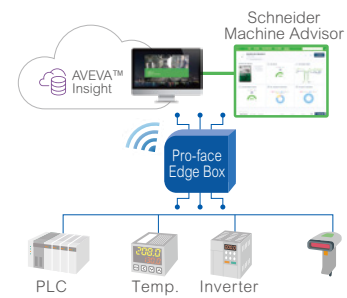

STM6000 Gateway Box

Protocol Converter

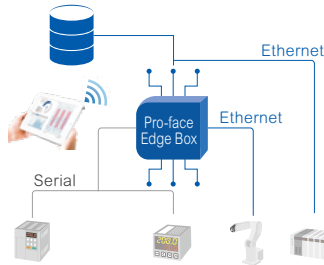

On-demand HMI



Affordable Access Point

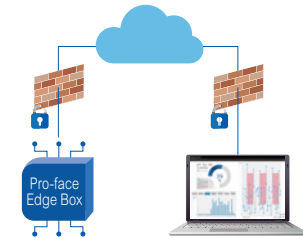

	Model No	Description	Software	Data management / Scheduler / Trend	Protocols OT	Software
Edge Box PC	PFXPL2BxxxxNxxx00	Box IPC (No pre-installed software) Windows	BLUE Open Studio V8.1 or later	Math task / Event logger / with database	158 available communication drivers	HTTPS, OPC-UA, MQTT, HTML, XML, ODBC, ADO, DDE, MACHA
	PFXPL2Bxxxx4xxx00				11 available communication drivers	
STM6000 Edge Box HMI	PFXSTM6B00DIOT	Edge Box HMI + Din Rail accessory, HMI Runtime 500 tags, One connection Mobile Access	BLUE Open Studio 2020 SP2 or later	-	76 available communication drivers	OPC-UA (Sever)
STM6000 Gateway Box	PFXSTM6B00D	Basic Gateway HMI Runtime Web Viewer License	BLUE 3.2 or later	-	76 available communication drivers	OPC-UA (Sever)

Multi-Converter

	SP5000 (Open BOX) Model	SP5000 (Power BOX) Model	SP5000 (Standard BOX) Model	LT4000M Model	STM6000 Model
Base module	PFXSP5B41	PFXSP5B10	PFXSP5B00	PFXLM4B01DAC PFXLM4B01DAK PFXLM4B01DDC PFXLM4B01DDK	PFXSTM6B00D
Adapter	PFXZCDAEXP1			PFXZXMADSA1	
Software	GP-Pro EX				BLUE

FANUC limited model(Model:PFXLM4B01DAKFF) is available. Data collection from CNC of old machines.

PC Monitors suitable for production sites



Flat Panel Monitors

Improve your machine's operativity

Pro-face Flat Panel Monitors are industrial PC monitors with a touch panel mounted and offered solutions for difficult installation due to a harsh production-work site environment or limitation of space.



Fits the most suitable place for machine operation by installing separately.



BOX PC

Industrial Flat Panel Monitors

Improve operation efficiency with a secondary display.



Panel PC

Industrial Flat Panel Monitors

Distance to connect (5m)

Host	Cable	Display Size	Display
PS6000 Series PS5000 Series (Only Windows 10) Windows OS-installed PC (Only Windows 10)	DVI (video), USB (touch)	22" Wide	FP-6900WC
		19" Wide	FP-6800WC
		15" Wide	FP-6700WC
		12" Wide	FP-6600WC
		10" Wide	FP-6500WC
		15"	FP-6700TM
		12"	FP-6600TM

Distance to connect (100m)

Host	Cable	Display Size	Display	Supported Touch Control	Expansion Adapter
PS5000 Series	Ethernet (video, touch)	22" Wide	PS-D5900WP	Max 4 Displays	 Display Adapter
		19" Wide	PS-D5800WP		
		15" Wide	PS-D5700WP		
		12" Wide	PS-D5600WP		
		15"	PS-D5700TA		
PS5000 Series (except PS-5700T / 5600T) SP5000 Series SP-5B41 Windows OS-installed PC		12"	PS-D5600TA	Max 3 Displays	 Multi Display Adapter
		19" Wide	SP-5800WC		
		15" Wide	SP-5700WC		
		15"	SP-5700TP		
		12"	SP-5600TP		
	10"	SP-5500TP			
	12"	SP-5600TA			
	12" Wide	SP-5600WA			
10" Wide	SP-5500WA				
	7" Wide	SP-5400WA			



BLUE Line Management Lite SCADA Open Studio



Flexible software for your need

Pro-face BLUE Open Studio is a development and runtime software that incorporates various tools users need to create SCADA HMI applications, dashboards and OEE interfaces.

Basic Features

- Scripting
- Security
- Symbols
- Tags Database
- Troubleshooting
- Gestures
- Alarms
- Animation
- Database
- Events
- Graphics and Design Tools
- Trends
- Multi-Language
- ActiveX and .NET
- Recipes
- Multi-touch
- Reports
- Scalable
- Scheduler
- OPC
- Intellectual Property Protection
- Email (SMTP)
- FTP
- Historical Performance
- PDF Export
- SSL Support for Emails
- DDE Client
- Custom Widgets

Connectivity

250+ available communication drivers for PLCs and many other devices.

Native OPC interfaces such as OPC UA/DA

Active X and .Net controls

Support upper connectivity to DB through MQTT.

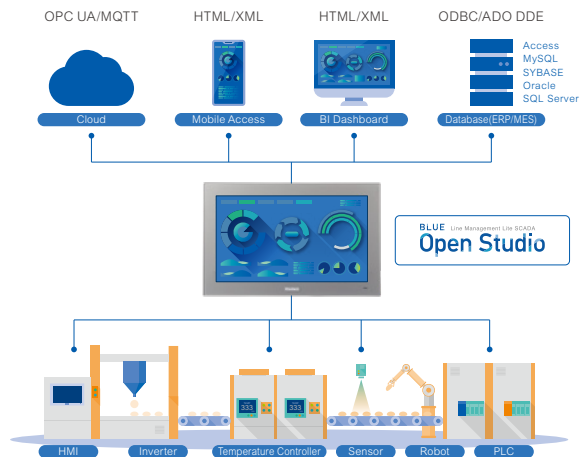

Database

Connect to any SQL database (Microsoft SQL, MySQL, Sybase, Oracle), or Microsoft Access or Excel, and ERP/MES systems (including SAP), even from Windows Embedded Compact Edition. BLUE Open Studio is flexible, offering a built in interface that doesn't require knowledge of SQL for trends, alarms/events, grid and other objects).

OPC

BLUE Open Studio provides native OPC interfaces, such as OPC DA (Server/Client), OPC HDA(Server), UA (Server/Client) and OPC .NET 3.0 (Client). BLUE Open Studio also supports OPC XML.

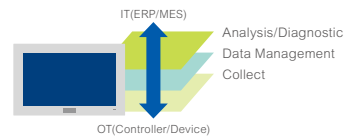

Trends

Real-time and Historical trends, and SPC functionality are supported. Log data in binary format, or to any local or remote SQL database. Color or fill trends with graphic elements to enhance clarity of data. Date/ Time based or numeric (X/Y plot) trends give you the flexibility to display information that best suits your application.

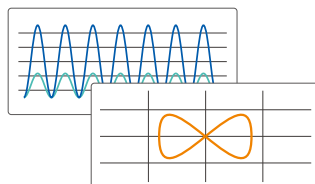

Custom Widget

Custom Widgets provides the ability to integrate third-party web-based controls into the HMI/SCADA project screens. Develop and share a library of controls that can be easily integrated into an application and accessible through multiple platforms.

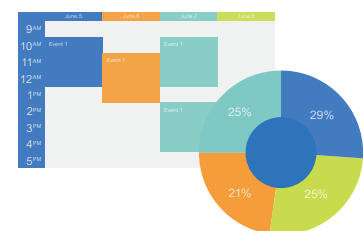

Historian

BLUE Open Studio includes support for saving historical data from some task worksheets to a Historian database or AVEVA Insight.

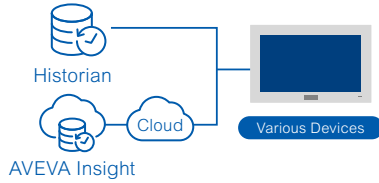

Import Wizard

PanelMate (Eaton and Cutler Hammer)
FactoryTalk View ME/SE (Rockwell)
PanelBuilder32SESE (Rockwell)

↓ Automatically converting

BLUE Line Management Lite SCADA
Open Studio



Remote Access

Access your BLUE Open Studio Screen from any device with a browser that supports HTML5, such as iPads, iPhones, Android devices, Windows devices, and others.



License Lineup

To version-up from Version 8.0 / 8.1 to 2020, version-up licenses are required. In addition, upgrade licenses are available to upgrade (ex, from Line management plus to Supervision)

Product Name	No.of Licenses	No.of Tags	Model
BLUE Open Studio for Supervision	1 License	64,000	PFXBOS*T64K*A
BLUE Open Studio for Line Management Plus	1 License	32,000	PFXBOS*T32K*A
BLUE Open Studio for Line Management	1 License	4,000	PFXBOS*T4K*A
BLUE Open Studio for Machine Control	1 License	1,500	PFXBOS*T1K*A
BLUE Open Studio Basic	1 License	-	PFXBOS*T500*A
BLUE Open Studio Thin Client	1 License	-	PFXBOSTC
BLUE Open Studio Import Wizard	-	-	PFXBOSTK
BLUE Open Studio USB Hard key	-	-	PFXBOSUSBL

PS6000 + BLUE Open Studio



Hardware and software association to improve your business

1 Full support & Integration on HW, SW and OS

Our dedicated support team ensures that you have a single contact window to resolve any issues

Integration is easy across our hardware, software and operating systems so commissioning is completed even faster

2 Save time & resources on validation and commissioning

PS6000 Series and BLUE Open Studio configured-to-order association is ready to use after our extensive testing and validation process, so you can save time, money and resources and have your application up and running

3 Sustainable supply & compatibility

Enjoy one supplier for your software and hardware requirements

Stress free replacement with ongoing development to meet industry requirements

Save Time



Save Money



website



video



manual



software



Versatile Software

Revolutionary new software, BLUE offers an alternative experience in HMI project design. Anyone can easily create and change dynamic screens.

Refined

High quality graphics

Clearer fonts and screen parts make an obvious difference. The clarity is not affected by zoom level



Stylish design

Customize gradation and transparency to meet your needs. Stylish expression including transparent effects.



Simple & Easy

One source, multiple ways to present

Support HMI project designer to adapt/customize projects and create easily situational awareness projects delivering more intuitive projects to the operators.



View all needed information at once

Simply display all necessary screens in one place. Multi-screen information gives rise to improvement in operation efficiency.



Responsive Behavior (Dock panel)

Several pages in one screen, and independent navigation in each section. Adapt the size of information to meet your needs with one click on the dynamic display.



Highly flexible graph features

Using data analyzing features, such as graph comparison, can produce more expressive insight than ever before



Change the value of a variable without programming

Use a converter to change the value of a variable from the defined unit, range, scale, and expression without programming.

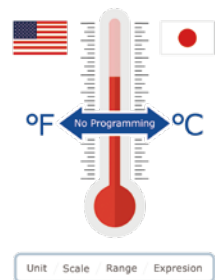



Connected & Secured

Pro-face connectivity

User-friendly protocols allowing you to connect your devices with ease via multiple interfaces and connect OT to IT with OPC-UA server.



Remote Access

Remote Visualization on PC or Tablet / Smartphone with new Web View features of BLUE.

See status of equipment or devices in the right place at the right time.



Simple steps to start to Remote Access

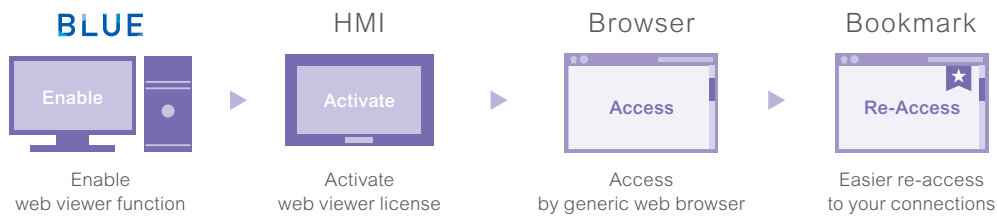

Secure remote access solution

"Pro-face Connect" is a ready-to-use solution for Remote Access Over Internet on ST6000 Series without programming or configuring each device. Start using the cloud based "Pro-face Connect" Smart Industry solution on your existing network without involving your IT department. No network or firewall configurations are required and still the highest level of security and encryption is in place from end to end, from any PC, tablet and smartphone to your machinery.

Enhanced cybersecurity against basic intentional attacks

- Need admin rights to download project to HMI target
- Auto user log out after predefined idle time
- Doing security checking during booting
- Secure Ethernet download supported by IPSec and password protected project file



Product Name	Model	Description		Supported models
BLUE Professional	PFXBLPCZLSPAZZ	Single license	Email	ST6000 Series, STM6000 Series, GP4100 Series Color model, SP5000 Series, PS6000 Series, PS5000 Series
	PFXBLPCZLSPMZZ		Paper	
	PFXBLPCZLSPA31	Group License	Virtual delivery	
	PFXBLPCZLSPM31		Printed delivery	
	PFXBLPCZLTPA31	Team License	Virtual delivery	
PFXBLPCZLTPM31	Printed delivery			
BLUE Basic*1	PFXBLECZLSPAZZ	Single license	Email	ST6000 Series, STM6000 Series, GP4100 Series Color model
	PFXBLECZLSPMZZ		Paper	
BLUE Runtime	PFXBLRCZLSPA31	Single license	Virtual delivery	PS5000 Series and PC / AT
	PFXBLRCZLSPM31		Printed delivery	
BLUE Web Viewer Runtime	PFXWRT001	Single license	License Keycode	ST6000 Series, STM6000 Series, SP5000 Series, PS5000 Series
	PFXWRT010	10 Licenses		
	PFXWRT100	100 Licenses		
BLUE USB Media Installer	PFXBTUSB32	USB Media with an installer		

*1 Basic License doesn't support for WEB API and OPC-UA. OPC-UA Server is not supported on GP4100 Series Color model



Screen editor software

GP-Pro EX



Standard screen editor software

Enables HMI screen and logic programming.
Screen customization can be performed with ease due to many functions that promote compatibility with legacy applications and reduce development time.

Connect directly to a wide range of devices

Largest number of drivers in the industry and many sample parts that enable connection with various manufacturers' equipment.

Leverage existing assets

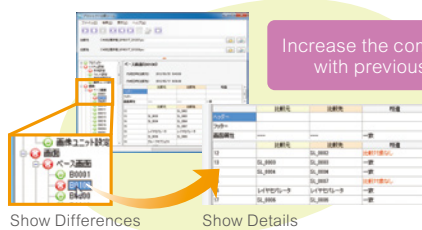

Able to display the difference between two similar files in detail.

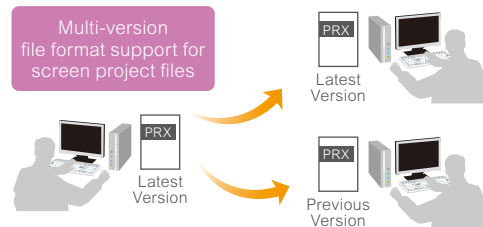

Screen project files edited in the latest version can also be saved in the previous version.

Screen and logic can be edited with one software

Controller addresses can be used directly in the editor via drag and drop, thus reducing the development time.

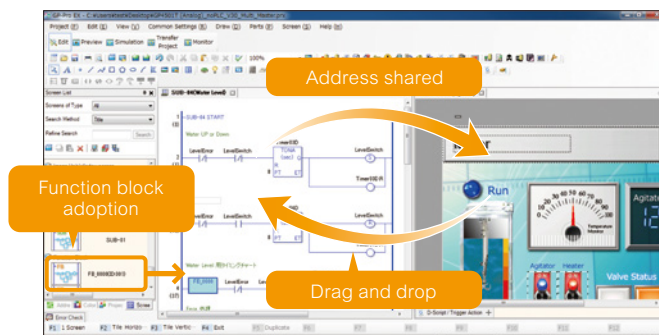

Runtime engine **WinGP**

Screens created by GP-Pro EX operate on a Windows OS-equipped machine using the Runtime engine.

Seamless communication with control equipment

No need to develop a driver to communicate with control equipment such as a PLC or temperature controller.

Cooperation with user database using dedicated API

Settings of WinGP are editable and device address read/write of the connected device can be done by the user application.

Model	Description	
PFEXEDV**	HMI screen editor & logic programming software (DVD)	
PFEXEDLS**	1 license	GP-Pro EX Editor License (license key code)
PFEXGRPLS**10	10 licenses	
PFEXGRPLS**25	25 licenses	
PFEXGRPLS**50	50 licenses	
EX-WINGP-IPC	1 license	License for using WinGP on WinGP-compatible IPC (license key code)
EX-WINGP-PCAT	1 license	License for using WinGP on PC / AT-compatible PC (license key code)

** is changed with the version of software.

Data management software

Pro-Server EX

A simple way to start networking to enhance the communication between the office and the manufacturing site.

Real-time visualization and analysis of data from production sites. Remote machine monitoring and transfer of work instructions to increase efficiency between the production site and the office.



- website
- manual
- software

Networking of the entire site to collect data collectively without programming

Collecting accurate information, and analyzing and utilizing all your data will lead to improvement in working processes!

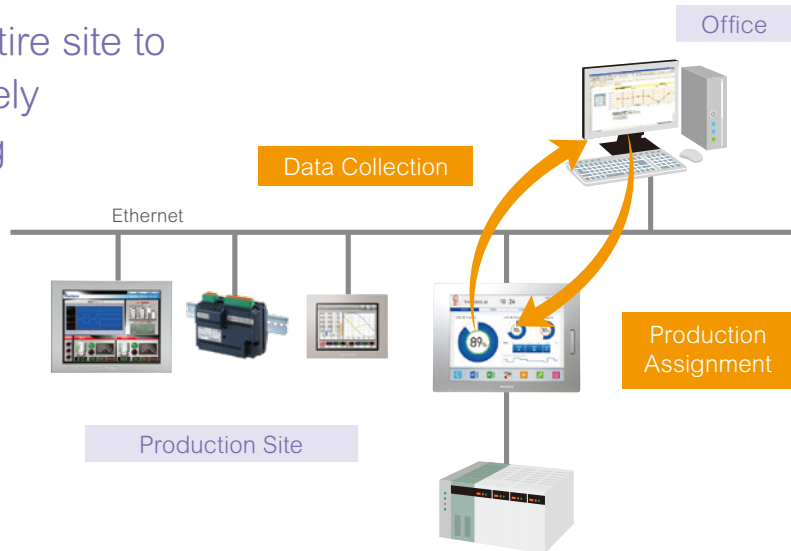

Remote Access

Pro-face Remote HMI

Software that enables tablets and smartphones to display and operate the exact same screen as the on-site HMI. Secure design with full-feature functions taking into consideration tablet operations.



Supported OS	Android OS, iOS (iPhone, iPad, iPod touch)	Download (purchase) from App Store / Google Play
--------------	--	--

Pro-face Remote HMI Server

Installing Pro-face Remote HMI Server on a Windows device allows users to monitor and operate Excel and PDF files from Pro-face Remote HMI, in addition to the terminal operator screens.

Model	Description
PFEXRHSLS	Software to operate and monitor Windows applications such as Excel or PDF besides Pro-face HMI screen

Pro-face Remote HMI Client for Win

More powerful Pro-face Remote HMI for Windows OS launched. While inheriting the functions of Pro-face Remote HMI, newly improved functions were added.

Model	Description
PFEXRHCLS	1 License
PFEXRHCLS10	10 Licenses
PFEXRHCLS30	30 Licenses

Software for remote viewing of Pro-face HMI from desktop PC (license key code)

Software



website



manual



software

Secure Remote Access over Internet

Pro-face Connect



Connect and Go

Pro-face Connect is a ready-to-use embedded HMI service to access machines remotely and securely.

Small initial cost

No need to locate VPN router in every branch.
Able to operate the system with only the license of running cost.

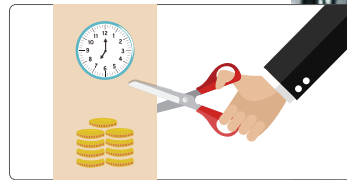

Able to use IP address with no change

Able to connect to the existing local IP address with no change.
No man-hours to change an IP address.

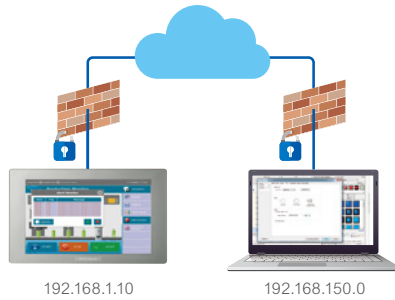

Connect securely

Conforms with industry level standards for security. Able to build a secure network.

- User access based on x.509 Cert.
- AES data encryption
- ISA99 and IEC 62443



Pro-face Connect

"Pro-face Connect" is a ready-to-use solution for Remote Access Over Internet on IPC, PS5000 Series and Smart Portal SP5000 Series without programming or configuring each device. Start using the cloud based "Pro-face Connect" Smart Industry solution on your existing network without involving your IT department. No network or firewall configurations are required and still the highest level of security and encryption is in place from end to end, from any PC, tablet and smartphone to your machinery.

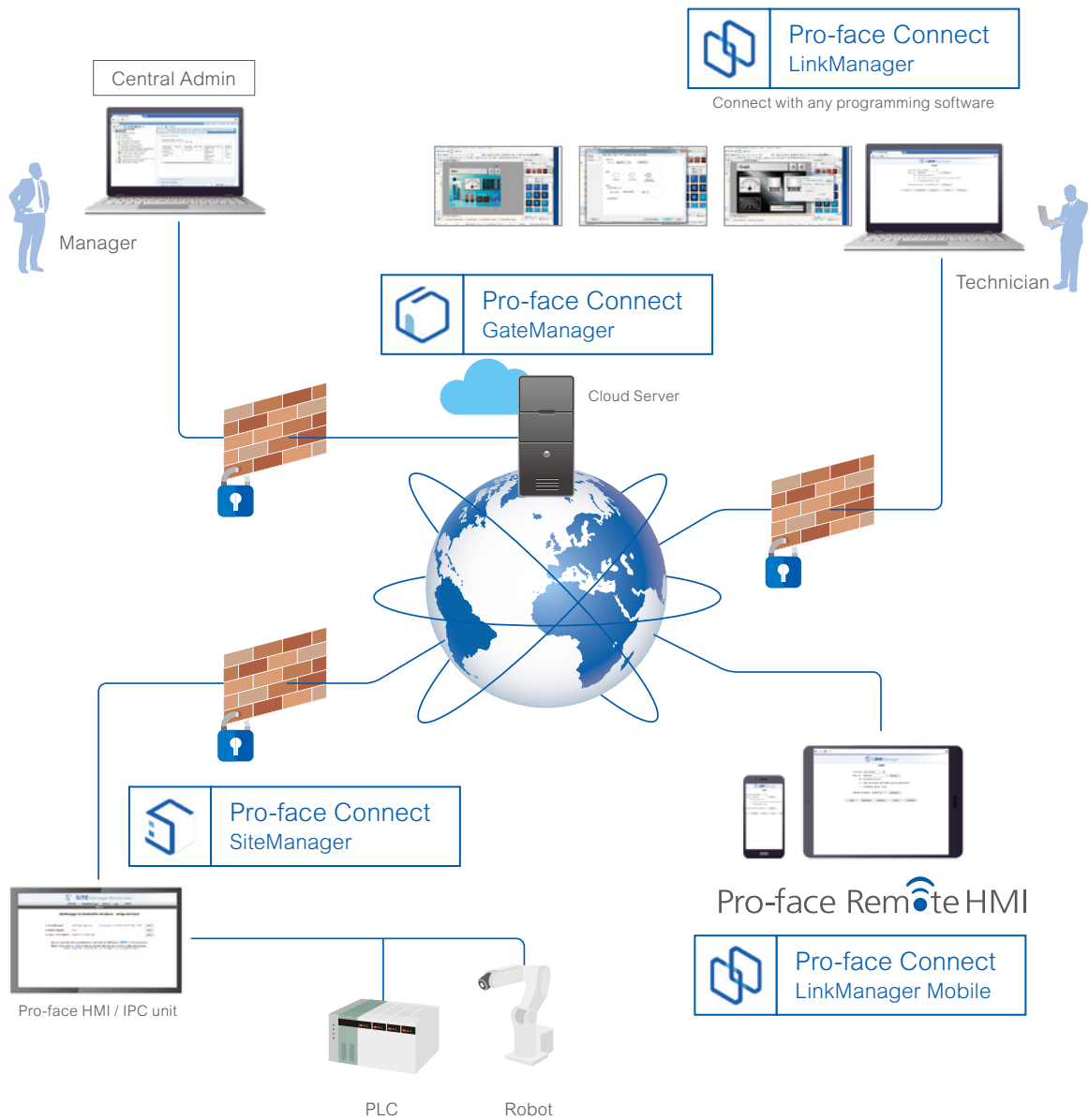

License Lineup

Product Name		Model No.	Description
Pro-face Connect 30 days Free Trial		PFXCONFREE30	Trial package running 30 days and including: 1 x Pro-face Connect GateManager License 1 x Pro-face Connect SiteManager Embedded Extended License, 5 device agents 1 x Pro-face Connect LinkManager License (floating license) 1 x Pro-face Connect LinkManagerMobile License
Basic Packs	Pro-face Connect Essential Pack	PFXCONPACKESS	1 x GateManager Customer Domain / 1 x LinkManager Floating License 1 x LinkManager Mobile License / 1 x SiteManager Extended 5 (Annual)
	Pro-face Connect Enterprise Pack	PFXCONPACKENT	1 x GateManager Customer Domain / 1 x LinkManager Floating License 1 x LinkManager Mobile License / 20 x SiteManager Extended 5 / 1 x GateManager Premium Access
Pro-face Connect LinkManager License		PFXCONLINK1	1 x Pro-face Connect LinkManager License
Pro-face Connect LinkManager Mobile License		PFXCONLINKM1	1 x Pro-face Connect LinkManager Mobile License
Pro-face Connect SiteManager Basic License		PFXCONSMBSCL	5 x Pro-face Connect SiteManager Embedded Basic License
Pro-face Connect SiteManager Extended 5 Licenses		PFXCONEXTD5	1 x Pro-face Connect SiteManager Embedded EXTENDED license, 5 device agents
Pro-face Connect SiteManager Extended 10 Licenses		PFXCONEXTD10	1 x Pro-face Connect SiteManager Embedded EXTENDED license, 10 device agents
Pro-face Connect GateManager Premium Access *1		PFXCONGMPREM	1 x GateManager Premium Access, Add-on option for Pro-face Connect Essential Pack license (PFXCONPACKESS)
User Statistics *1		PFXCONSTAT	Add-on option for Pro-face Connect Essential Pack license (PFXCONPACKESS) or Pro-face Connect / Enterprise Pack (PFXCONPACKENT)

*1 Not available in all areas, please contact your local office.



Web service

HMI Design Studio

Begin a new user experience with Pro-face HMI

HMI Design Studio is a creative yet easy-to-use website that helps you and your team to create HMI Applications

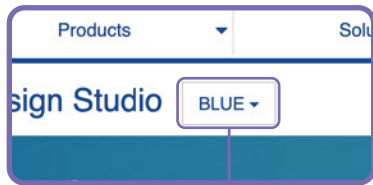

Software Selection

BLUE or BLUE Open Studio

Online Tutorial

Learn skills to make yourself the best interface. Join today to get access to various types of courses.

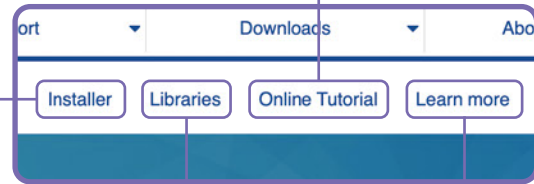
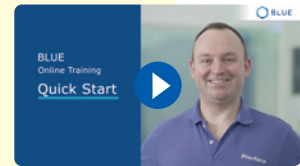

Installer

Download software (Full Installer / Trial Mode).

Libraries

Download over 300 kinds of ready-made template screens and parts or design it by yourself.

Learn more

Knowledge base and community.

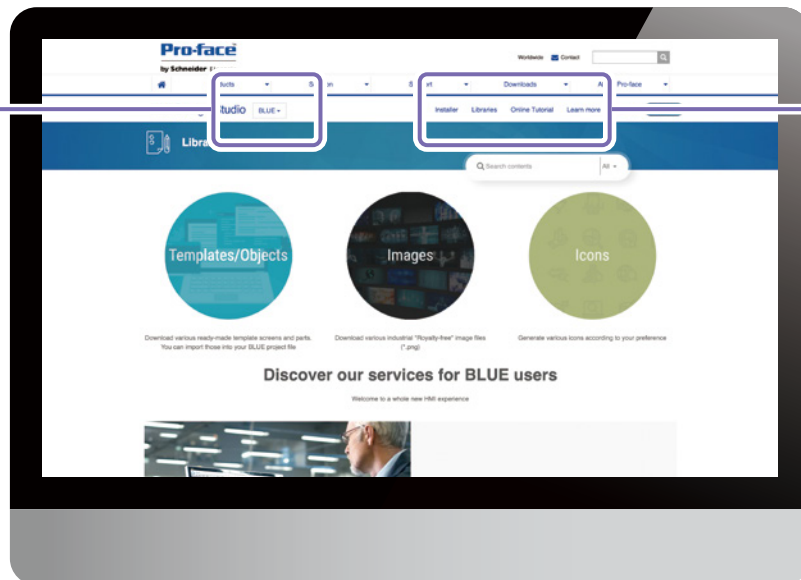

Template / Objects

Download various ready-made template screens and parts. You can import those into your BLUE and Blue Open Studio project files.

Intuitive layout template

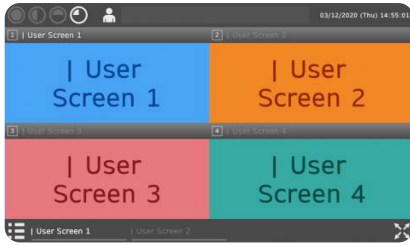

BLUE

Dock Panel (Bottom)



BLUE

Alarm Control

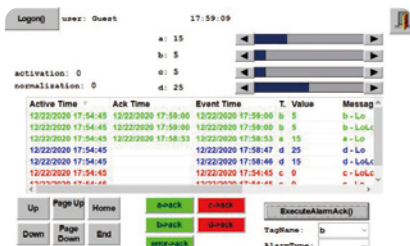

BLUE Open Studio

Database



BLUE Open Studio

Images

BLUE BLUE Open Studio

Download various industrial "Royalty-free" image files (*.png)

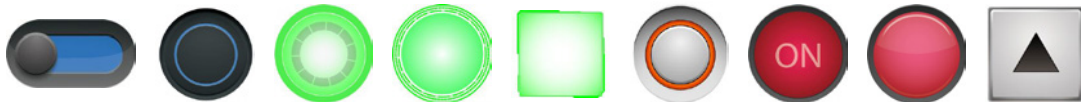

Icons

BLUE BLUE Open Studio

Generate various icons according to your preference

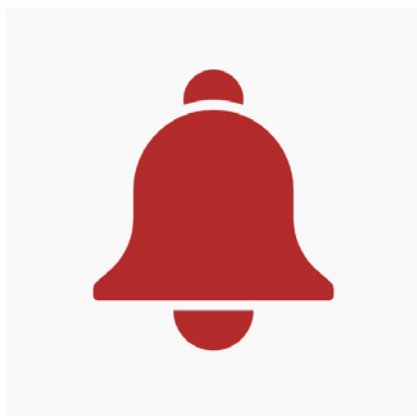

#Caution #Notification

Bell

Size: 16px, 256px, 512px

Color: #bc2c2c (Hex)

Format: PNG, JPG

Customization and Services

Pro-face is experienced in providing HMI customization services based on specific needs.

Basic menu

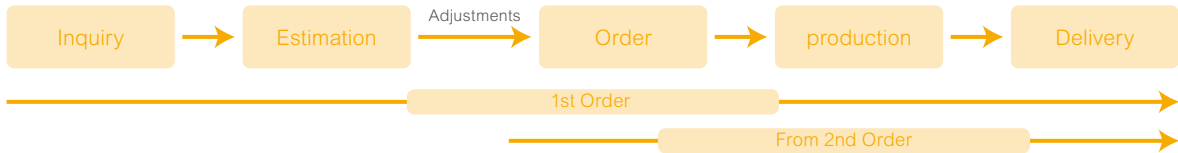

Kitting	Screen Protection Sheet / Environment Cover Enclose accessories in the package Screen data	GP-Viewer license keycode Customer's OS image Network address
Custom Overlays / Logos	Remove original logo Customer's logo (sticker type) Customer's logo (printed on overlay)	Change the color of overlay Add labels
Coating	Coat PCBAs	

Specific needs

We offer products outside the basic lineup to meet individual needs

Pro-face is experienced in providing HMI customization services based on specific needs

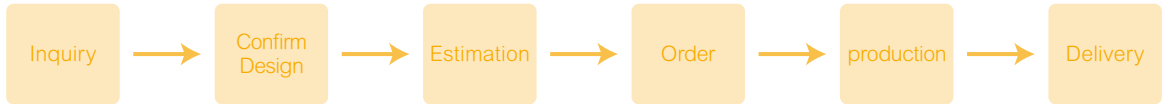

<p>Embedded Camera</p>	<p>Operation log with video and image.</p> <p style="background-color: #f4a460; color: white; padding: 2px;">Target</p> <p>Semiconductor / Electronics</p>	<p>SP5000 Series PFXSP5600TPD + SP5000 Series PFXSP5B41</p> <p>Snapshot or video recording by switches on the screen</p>
------------------------	--	--

<p>Rear Mount</p>	<p>Change the rear mount design to suit specific use or situation.</p> <p style="background-color: #f4a460; color: white; padding: 2px;">Target</p> <p>Food & Beverage Woodworking Machine</p>	<p>GP4100 Series PFXGP4116T2D</p> <p>Flat on the surface</p>
-------------------	--	--

Pro-face Worldwide offices



<p>01 Japan</p> <hr/> <p>Schneider Electric Japan Holdings Ltd. Pro-face Japan Tokyo, JAPAN www.proface.com/ja</p>	<p>02 Australia</p> <hr/> <p>Pro-face by Schneider Electric New South Wales, AUSTRALIA www.proface.com.au</p>	<p>03 China</p> <hr/> <p>Pro-face China International Trading Shanghai, P.R.CHINA www.proface.com.cn</p>
<p>04 India</p> <hr/> <p>Pro-face by Schneider Electric Bangalore, INDIA www.proface.co.in</p>	<p>05 South Korea</p> <hr/> <p>Pro-face by Schneider Electric Seoul, SOUTH KOREA www.proface.co.kr</p>	<p>06 Singapore</p> <hr/> <p>Pro-face by Schneider Electric SINGAPORE www.proface.sg</p>
<p>07 Taiwan</p> <hr/> <p>Pro-face by Schneider Electric Taipei, TAIWAN www.proface.com.tw</p>	<p>08 Thailand</p> <hr/> <p>Pro-face by Schneider Electric Bangkok, THAILAND www.proface.com/en</p>	<p>09 Vietnam</p> <hr/> <p>Pro-face by Schneider Electric HCMC, Vietnam www.proface.com/en</p>
<p>10 Indonesia</p> <hr/> <p>Pro-face by Schneider Electric Jakarta, Indonesia https://www.proface.com/en/</p>	<p>11 Philippines</p> <hr/> <p>Pro-face by Schneider Electric Taguig, Philippines https://www.proface.com/en/</p>	<p>12 Malaysia</p> <hr/> <p>Pro-face by Schneider Electric Selangor Darul Ehsan, Malaysia https://www.proface.com/en/</p>
<p>13 America Headquarters</p> <hr/> <p>Pro-face America LLC, USA www.profaceamerica.com</p>	<p>14 Brazil</p> <hr/> <p>Pro-face America (Brazil office) Sao Paulo, BRAZIL www.profaceamerica.com</p>	<p>15 Canada</p> <hr/> <p>Pro-face by Schneider Electric Mississauga, Ontario, CANADA www.profaceamerica.com</p>
<p>16 Mexico</p> <hr/> <p>Pro-face America (Mexico office) Nuevo Leon, MEXICO www.profaceamerica.com</p>	<p>17 Austria</p> <hr/> <p>Pro-face by Schneider Electric Ratingen, GERMANY www.proface.com/en</p>	<p>18 Belgium</p> <hr/> <p>Pro-face by Schneider Electric Brussels, BELGIUM www.proface.com/en</p>
<p>19 Denmark and Sweden</p> <hr/> <p>Pro-face by Schneider Electric Ballerup, DENMARK www.proface.com/en</p>	<p>20 France</p> <hr/> <p>Pro-face by Schneider Electric Rueil-Malmaison, FRANCE www.proface.fr</p>	<p>21 Germany</p> <hr/> <p>Pro-face by Schneider Electric Ratingen, GERMANY www.proface.com/en</p>
<p>22 Italy</p> <hr/> <p>Pro-face by Schneider Electric Milano, ITALY www.proface.com/en</p>	<p>23 The Netherlands</p> <hr/> <p>Pro-face by Schneider Electric Hoofddorp, THE NETHERLANDS www.proface.com/en</p>	<p>24 Poland</p> <hr/> <p>Pro-face by Schneider Electric Warsaw, POLAND www.proface.com/en</p>
<p>25 Spain and Portugal</p> <hr/> <p>Pro-face by Schneider Electric Barcelona, SPAIN www.proface.com/en</p>	<p>26 Switzerland</p> <hr/> <p>Pro-face by Schneider Electric Ratingen, GERMANY www.proface.com/en</p>	<p>27 United Kingdom</p> <hr/> <p>Pro-face by Schneider Electric Coventry, UNITED KINGDOM www.proface.com/en</p>