

Replacement Book

PFXSP5600WAD +
PFXSP5B41 (Advanced Display + Open Box)
→ PS6000 series 12-inch Wide Display +
Basic Box (Atom)

Preface

This guidebook introduces the procedures to replace PFXSP5600WAD + PFXSP5B41 with PS6000 series 12-inch Wide Display Module + Basic Box Module. The recommended replacement models are as shown below.

* The PS6000 series 12-inch Wide Display Module is hereinafter called PS6000 12”W and the PS6000 series Basic Box Module is called BasicBox.

Currently used device		Recommended replacement model
SP-5600WA (Advanced Display) + SP-5B41 (Open Box) PFXSP5600WAD + PFXSP5B41 or PFXSP5B411 or PFXSP5B412	⇒	PS6000 12”W + Basic Box (Atom) Model : PFXP6AExxxxxxxxx00 (Intel X6211E Atom 2 Cores DIMM-4GB)

Safety Information

To properly use the products described in this book, please follow the directions below.

- Be sure to read the manual and the other provided documents before use.
- Only persons with the expertise of electrical equipment construction method and related law and also the adequate skills should be allowed to install, connect, and maintain the products.

We are not responsible for death, serious injury or unintended equipment damage incurred as the result of failure to follow these instructions.

Trademarks

Microsoft® and Windows® are either registered trademarks or trademarks of Microsoft Corporation in the United States and/or other countries.
 Intel®, Celeron®, Atom®, Core™2 Duo and Core™ i3/5/7 are trademarks of Intel Corporation.
 Other product names used in this manual may be the registered trademarks owned by the respective proprietors.

Models of PS6000 series

PS6000 series are products of CTO (Configure To Order).

Please confirm CTO models on the Web site before placing orders at the time of purchase.

Generate CTO models.

<https://www.proface.com/en/product/ipc/ps6000/configurator>



Table of Contents

Preface	2
Models of PS6000 series	3
Chapter 1 Specifications Comparison	6
1.2 Comparison of performance specifications between SP-5600WA + SP-5B41 and PS6000 12"W + Basic Box	7
1.3 Comparison of general specifications between SP-5600WA + SP-5B41 and PS6000 12"W + Basic Box	8
1.4 Comparison of interface specifications between SP-5600WA + SP-5B41 and PS6000 12"W + Basic Box	9
Chapter 2 Hardware Compatibility	10
2.1 Cooling storage media	10
2.2 Settings of Serial Interfaces on Box Module	11
2.3 Video output interface	12
2.4 USB Type C	12
Chapter 3 Optional items	13
3.1 Options compatibility	13
3.2 Options Slot table	13
3.3 Option Interface of RS-422/485 isolated x2	14
3.4 Option Interface of RS-422/485 isolated PIN assign	15
Chapter 4 Compatibility of software	16
4.1 Supported OS and language	16
4.2 OS login password	17

4.3 Recovery media	17
4.4 Supported software and utilities	17
4.5 Supported features in Launcher compatibility	18
4.6 Details of touch operation for every series	18
4.7 GP-Pro EX project file	18
4.8 WinGP – Historical Data Retentive Settings	19
4.9 BLUE Runtime transfer	20
4.10 BLUE Project file	22
4.11 BLUE historical data location	23
4.12 Software notice when Writer Filter is enabled	24

Chapter 1 Specifications Comparison

1.1 Comparison of display specifications between SP-5600WA + SP-5B41 and PS6000 12"W + Basic Box

Display Specifications			
		SP-5600WA + SP-5B41	PS6000 12"W + Basic Box
			
Display Type		TFT Color LCD (12" Wide)	
Display Resolution		WXGA 1280 x 800	
Display Colors		262,144 colors	Approx. 16 million colors
Backlight		White LED (not user replaceable. When replacement is required, contact customer support.)	
Brightness control		101 levels (adjusted with touch panel or software)	
Backlight service life		50,000 hours or more (continuous operation at 25 °C [77 °F]-ambient temperature- before backlight brightness decreases to 50%)	
Touch panel	Type	Resistive Film (analog, single touch)	UP! Projected capacitive touch panel (multitouch, simultaneous touch number-2) with optimized noise filter
	Mode	None	UP! 3 modes (Changeable - Standard Mode, Water Detection Mode, and Glove Mode)

1.2 Comparison of performance specifications between SP-5600WA + SP-5B41 and PS6000 12”W + Basic Box

Performance Specifications		
	SP-5600WA + SP-5B41	PS6000 12”W + Basic Box
CPU		Atom E3825
	Base frequency	1.33 GHz
	Max turbo boost frequency	-
	L2 cache	1 MB
	Core number	2
	Thread number	2
Main memory	SP-5B41: DDR3L 1066 MHz - SDRAM 2 GB SP-5B411/412: DDR3L SDRAM 4 GB	UP! 260-pin SO-DIMM socket x 2, DDR4-3200 (Up to 32GB for 2 sockets) UP! Support In-band ECC
Graphics accelerator	Intel® HD Graphics for Intel Atom® Processor Z3700 Series	UP! Intel® UHD Graphics for 10th Gen Intel® Processors
Security chip	-	UP! TPM 2.0
BIOS	Legacy BIOS	UP! UEFI BIOS
Operating system	SP-5B41: Open Box (Windows® Embedded Standard 7 Service Pack 1) SP-5B411/412: Windows® 10 IoT Enterprise 2019 LTSC 32 bit	UP! Windows® 10 IoT Enterprise 2021 LTSC (64bit) *1
Watchdog timer	-	New! Timeout setting from either 1 to 255 seconds, or 1 to 255 minutes, is possible (set up using API)
Buzzer	Yes	Yes

*1 OS will be different between SP5000 and PS6000. Be aware that SP-5B411/412 windows 10 and PS6000 Basic Box is both Windows 10 but different version. Some software might have no compatibility.
 SP-5B411/412 : Windows® 10 IoT Enterprise **2019** LTSC (**32 bit**)
 PS6000 Basic Box : Windows® 10 IoT Enterprise **2021** LTSC (**64bit**)

1.3 Comparison of general specifications between SP-5600WA + SP-5B41 and PS6000 12"W +

Basic Box

General Specifications		
	SP-5600WA + SP-5B41	PS6000 12"W + Basic Box
Panel cut dimensions	W295.0 mm x H217.0 mm	
Panel thickness	1.6 mm to 5 mm	
External dimensions (including bezel)	W308.5 x H230.5 x D67 mm	
Front bezel material	Aluminum	
Weight	3.9 kg or less	4.3 kg or less
Cooling method	Natural air circulation (fanless) →See 2.1	
Power supply	DC power supply : 24V	DC power supply: 24V
Power consumption	DC	When backlight is off: 27.5 W or less Max: 45 W
	AC	-
UPS for battery backup	-	No exclusive option *please us third device recommend : APC SMT500J Smart-UPS500

1.4 Comparison of interface specifications between SP-5600WA + SP-5B41 and PS6000 12"W +

Basic Box

Interface Specifications		
	SP-5600WA + SP-5B41	PS6000 12"W + Basic Box
Serial (D-Sub 9-pin plug)	Main unit	COM1: RS-232C/422/485 (non-isolated) COM2: RS-232C/422/485 (non-isolated) <i>(default: RS-485, enable by launcher)</i>
	Option	- Select any of the following PFXYP6M2R23P2 : RS-232C isolated type x 2 PFXYP6M2R42P2 : RS-422/485 isolated type x2 * → See 3.3 <i>* No compatibility in case of RS-422 using RTS+/- or CTS+/- . But even in other case, if application or connected device is controlling send/receiving by monitoring RTS or CTS, it could not be communicated. If able to change to software flow control, it is avoidable.</i>
Disk	CFast Card 32 GB x 1 SDXC Card x1	UP! M.2 SSD 128GB as default, support up to 512GB x2* SDXC Card x1 <i>*2nd SSD could be use when no option interface or Wifi/Bluetooth interface module. With other option module, only single SSD can be use → See 3.2</i>
USB	USB Type-A x3 (2.0) USB Type-mini-B x1 (2.0) * <i>*for transporting project file</i>	UP! USB Type-A x2 (3.0) UP! USB Type-C x1 (3.2) <i>*Project transfer will be done by : Ethernet USB A transfer cable (PFXZC3CBUSA1) USB Memory SD Card</i>
Ethernet	EEE802.3, 10BASE-T/100BASE-TX/1000BASE-T x2	UP! IEEE1588, 10 BASE-T/ 100 BASE-TX/1000BASE-T, Wake on LAN (WOL) supported x2 <i>* When status is S4 (hybrid shutdown), Wake on LAN cannot be used.</i>
Sound	Line input/Line output/Microphone input	- <i>(Option will be release later)</i>
Video output	DVI-D Output Interface x 1	UP! Display port x1 (Dual mode supported) UP! USB 3.0 (Type C Displayport Alternate mode) x 1 → See 2.3
Option Interface Slot	-	1 slot <i>*For valid combination →See 3.2</i>

Chapter 2 Hardware Compatibility

2.1 Cooling storage media

When installing the M.2 SSD for second storage, the optional M.2 cooling kit is required. (PFXY6HSM2B)

	Storage media	M.2 cooling kit
Basic Box	M.2 SSD	-
	M.2 SSD (Second Storage)	✓
	CF Card	-

1. Remove 3 screws on the front side of the Box Module.

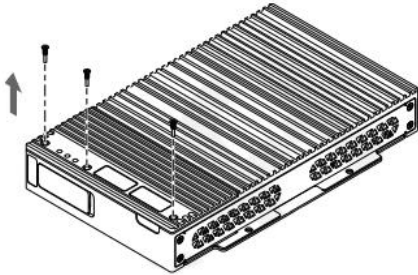

2. Remove the optional interface cover.

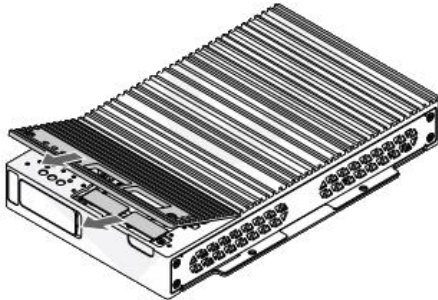

3. Peel off the protective film from the top surface and bottom surface of the heat sink pad.

Place the heat sink pad on the board

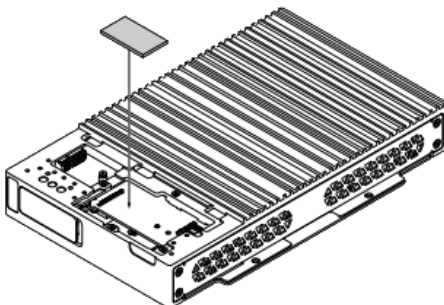

4. Insert the M.2 screw in the M.2 SSD card.

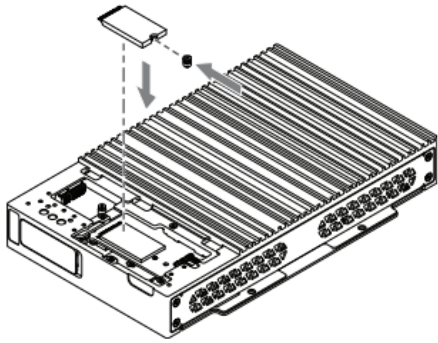

5. Insert the M.2 SSD card in the slot. Secure the M.2 SSD card with the M.2 screw

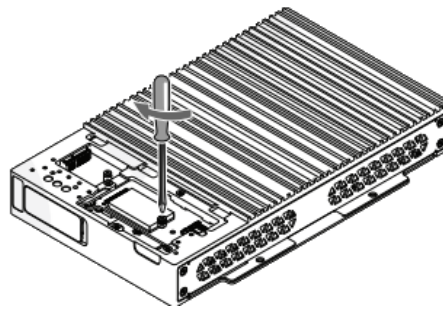
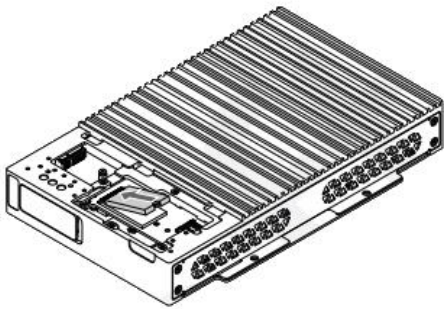

2.2 Settings of Serial Interfaces on Box Module

The following describes how to configure the serial interfaces on Box Module.

1. Turn on the product. While the boot screen is displayed, press either the **[DEL]** or **[ESC]** key. Enter the **password** (default password: Pw#12345). The BIOS screen will display.
2. Select **Advanced > Super IO Configuration > Serial Port 1 or Serial Port 2**
3. Select **Enabled** or **Disabled** in Serial Port (default: Enabled).
4. Select a **communication method** in Mode Selection (default: RS485).

2.3 Video output interface

PS6000 series supports 3 video output interfaces. Simultaneous output of all the interfaces is possible.

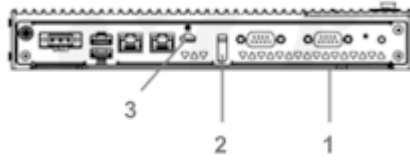

A: Display Module Interface

B: USB Type C

C: Display Port

Setting Tool	Duplicate	Extension	Scaling
Windows standard display setting	2 screens max	3 screens max	Scaling down only
Intel Graphics Command Center	3 screens max	3 screens max	Scaling up/down

Display Module Interface	USB Type C	Display Port	Details
Screen A	Screen B	Screen C	3 – extension display
A	B	B	1-extension display (Display Module), 2-duplication display
B	A	B	1-extension display (USB Type C), 2-duplication display
B	B	A	1-extension display (DisplayPort), 2-duplication display
A	A	A	3-duplication display (Intel Graphics Command Center is required)

2.4 USB Type C

The USB Type C of PS6000 series supports DP Alt Mode *1.

PS6000 Basic Box Type C does not support USB-PD *2

*1 DP Alt Mode (DisplayPort Alternative mode) is USB Type C port which could connect to display by convert adapter or cable of VGA, DVU, HDMI, DP.

*2 USB-PD (Power Delivery) is USB port which able to connect to display by 1 cable. By Sending video signal and power.

Chapter 3 Optional items

3.1 Options compatibility

Most of SP5000 series option are usable for PS6000 Atom Basic Box.

(Display option's reference are for 15inch)

SP5000 series		PS6000 series
Product Name	Model	Compatibility
COM Port Conversion Adapter	PFXZC3ADCM1	✓
Terminal Block Conversion Adapter	PFXZC3ADR41	✓
RS-232C Cable (5m)	PFXZC3CBR251	✓
RS-422 Cable (5m)	PFXZC3CBR451	✓
Mitsubishi PLC A-Series Connection Cable (5m)	PFXZC3CBA51	✓
9-pin-to-25-pin RS-232C Conversion Cable (0.2m)	PFXZC3CBCVR21	✓
Mitsubishi PLC FX-Series Connection Cable	PFXZC3CBFX11	✓
Mitsubishi PLC FX-Series Connection Cable	PFXZC3CBFX51	✓
Mitsubishi PLC Q-Series Link Cable(5m)	PFXZC3CBQL51	✓
Mitsubishi PLC Q-Series Connection Cable (5m)	PFXZC3CBQ51	✓
Omron PLC SYSMAC Link Cable(5m)	PFXZC3CBSYS51	✓
Screen Protection Sheet	PFXZC3DS151	✓
Connects a USB printer. (TYPE-B)	PFXZC0CBUS1	✓
RS-422 Terminal Block Conversion Adapter	PFXZCBADTM1	✓
RS-422 9/25-pin Conversion Cable (0.2m)	PFXZCBCBCVR41	✓
Multi-Link Cable (5m)	PFXZCBCBML1	✓
SD Memory Card (4 GB)	PFXZCBSD4GC41	✓
EZ Illuminated Switch	PFXZCCEUSG1	✓
Front USB cover for NEMA/ATEX	PFXZCDCVUS1	✓
SD Memory Card (1 GB) for System Card	PFXZCSD1GC61	✓
Auxiliary Output / Speaker Output Interface	PFXZCDCNAUX1	- *1
UV Protection Sheet	PFXZCFUV151	-
Environment Cover	PFXZCDOP151	-
Anti-Glare Sheet	PFXZCHAG152	- *2
Replacement Battery	PFXZCBBT1	-
Multi Display Adapter	PFXZCDADEXR1	- *3

*1 Audio option with 3.5 Audio interface will be available later

*2 New Anti-Glare Sheet available (PFXZCAG7W1)

*3 PS6000 can connect with 3 displays. Detail on 2.4 Video output interface

3.2 Options Slot table

Option Slot (except WiFi/Bluetooth) and 2nd M.2 SSD use same interface, so 2nd SSD could be only use with WiFi/Bluetooth option or no option module.

Option slot fit only one option module frame, so option module can be use only one at a time.

Option Slot	2 nd M.2 SSD
RS-232C x2	
RS422/485 x2	
Ethernet	
4G Cellular	
WiFi/Bluetooth	✓
No Option Module	✓

3.3 Option Interface of RS-422/485 isolated x2

This Option Interface has dip switch. Termination resistor setting is necessary. Set up by referring to the following table. Switching RS-485 and RS-422 is also configured with the dip switch.

DIP SW	OFF	ON	Description
1	Normal	Termination (120 ohm)	for COM3. Default: OFF
2	Normal	Termination (120 ohm)	for COM4. Default: OFF
3	RS-485	RS-422	Default: OFF
4	Unused (disabled)		Default: OFF

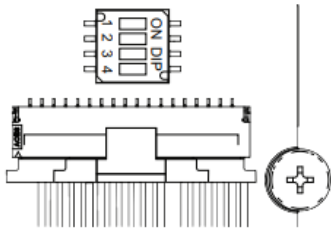

Along with DIP switch settings, both ports must be set in the Windows® Device Manager too.

NOTE: Auto direction control is automatically enabled with this setting.

1. Open the **Windows® Device Manager**.
2. Open **Ports**
3. Right-click the port to which RS-485 or RS-422 is assigned

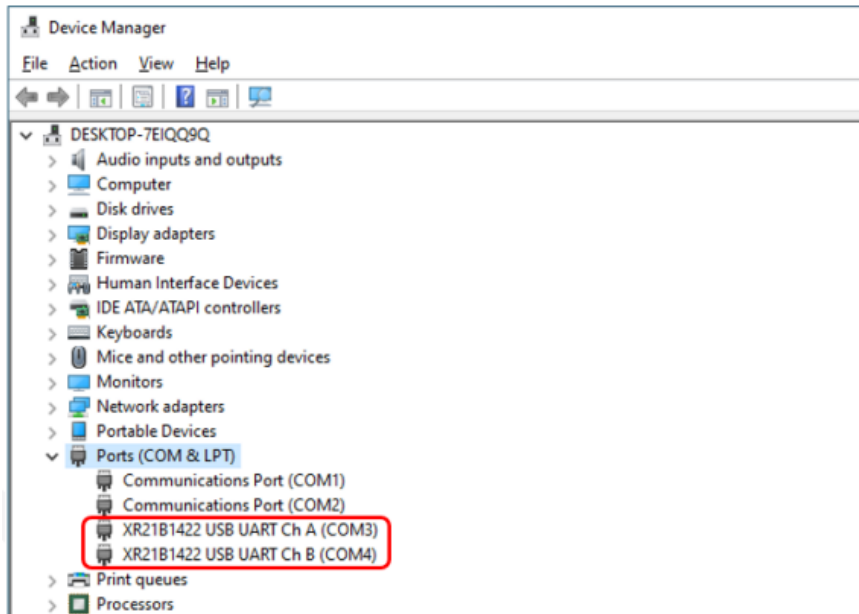

4. Select **Properties** and open the **Port Settings** tab.
5. Select the **RS-485** check box.

NOTE:

- Select the RS-485 check box even for RS-422.
- Do not change any settings other than RS-485.

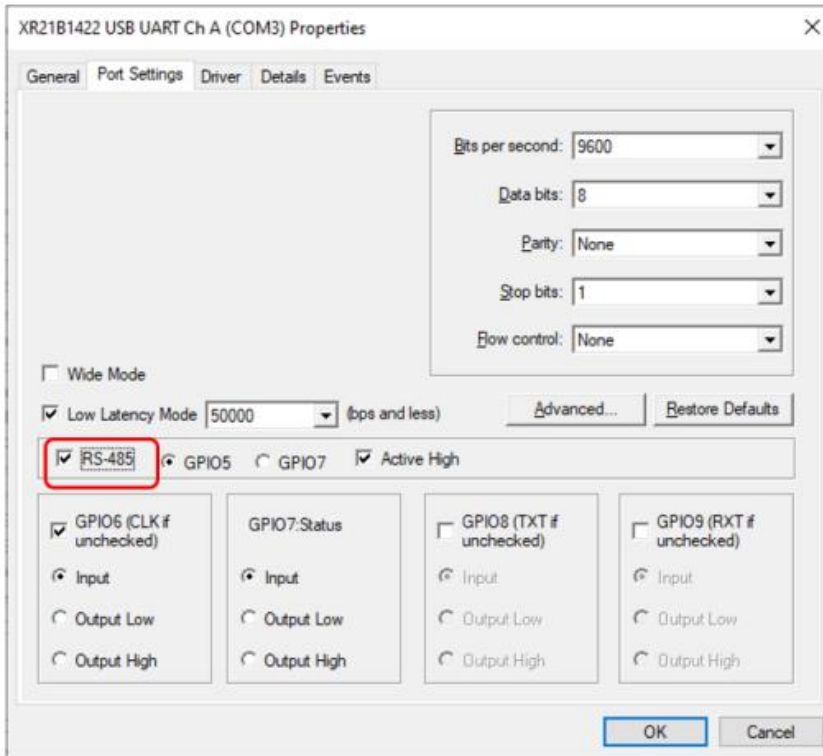

3.4 Option Interface of RS-422/485 isolated PIN assign

Option Interface of RS-422/485 isolated PIN assign is different with PS6000 Basic Box COM port and SP5000 Open Box COM port.

Pin#	PS6000 Basic Box COM port	SP5000 Open Box COM port	PS6000 Basic Box RS422/485 x2 isolation option
1	RDA	RDA	TxD-/Data-
2	RDB	RDB	TxD+/Data+
3	SDA	SDA	RxD+
4	ERA	ERA	RxD-
5	SG	SG	SG
6	CSB	CSB	NC
7	SDB	SDB	NC
8	CSA	CSA	NC
9	ERB	ERB	NC

Chapter 4 Compatibility of software

4.1 Supported OS and language

The supported OS and language differ between SP5000 series and PS6000 series.

OS	SP5000 series	PS6000 series
Windows Embedded Standard 7 Service Pack 1	Yes (PFXSP5B41)	No
Windows 10 IoT Enterprise 2019 LTSC	Yes (PFXSP5B411/412)	No
Windows 10 IoT Enterprise 2021 LTSC (64 bit)	No	Yes

Language	SP5000 series	PS6000 series
	Windows Embedded Standard 7 Service Pack 1 Win 10 IoT Enterprise 2019 LTSC	Windows® 10 IoT Enterprise 2021 LTSC (64 bit) *2
Chinese(Simplified)	Yes/No *1	Yes
Chinese(Traditional)	Yes/No *1	Yes
English	Yes	Yes
French	Yes	Yes
German	Yes	Yes
Italian	Yes	Yes
Japanese	Yes	Yes
Portuguese	Yes/No *1	Yes
Russian	Yes/No *1	Yes
Spanish	Yes	Yes
Swedish	Yes/No *1	Yes

*1: It's necessary to add and install a language from the language pack.

*2: Language that is not shown in the table can be downloaded from the Microsoft web site using the standard language feature of Windows.

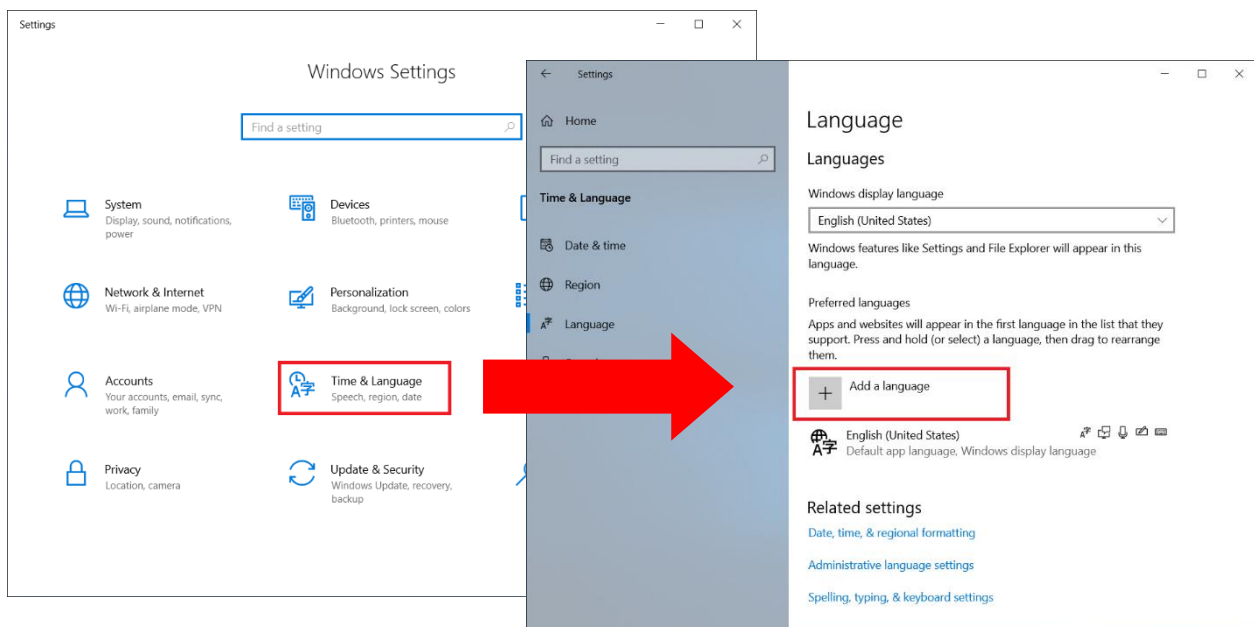

4.2 OS login password

For PS6000 series, it's necessary to set a login password at the first boot of the product to reduce the risk of intrusion and infection of malicious software and unauthorized access. Unlike SP5000 series, you cannot configure settings without a password. The conditions of login password are as follows;

The number of characters: 8 or more characters with 3 or more types included from the usable characters as shown below. The character strings used for the account name cannot be used.

Types of usable characters:

- Upper-case characters of European languages (A to Z, diacritical mark, Greek alphabet, Cyrillic alphabet)
- Lower-case characters of European languages (a to z, hash sign, Greek alphabet, Cyrillic alphabet)
- Numbers (0 to 9)
- Characters (special characters) except alphanumeric characters: (~!@#\$\$%^&* _-+=`|¥(){}[]:;'"<>,.?/) In this policy setting, the currency sign like Euro or British Pound is not counted as special characters
- Unicode characters that are neither upper-case nor lower-case characters though they are categorized in the order of alphabet. Unicode characters of Asian languages are included in this.

4.3 Recovery media

A recovery USB for OS recovery is attached to PS5000 series, but it's an optional item for PS6000 series. Please purchase a recovery USB for PS6000 Basic Box (PFXY6RUSW10B) for OS recovery.

Using the recovery tool *1 on our web site makes recovery possible with the backup file created in advance.

*1: https://www.proface.com/en/download/ps6000/application/restore_and_backup

4.4 Supported software and utilities

The software and utilities supported by PS6000 series are as follows;

Software	Version
GP-Pro EX (WinGP)	Ver. 4.09.500 or later
Pro-Server EX	Ver. 1.37.200 or later
Pro-face Remote HMI (iOS/Android)	Ver. 1.50 or later *1
Pro-face Remote HMI Server	Ver. 1.11.006 or later
Pro-face Remote HMI Client for Win	Ver. 1.42 or later
BLUE	3.4 Service Pack 1
BLUE Open Studio	2023
Pro-face Connect (Link Manager)	11.0
Pro-face Connect (Site Manager)	11.0

*1: For earlier than Ver.1.50, PS6000 series (WinGP) is not recognized as a connection destination server.

Utility	Descriptions
Buzzer	Enable or disable the buzzer sound at the time of touch panel operation.
Brightness	Sets the backlight brightness.
Calibration	Correct touch positions.
Front USB	Permit or do not permit use of Front USB on Display Module.
Write Filter	Enable or disable the Write Filter feature.
HORM	Enable or disable the HORM feature.
Shell	Hide the Windows® desktop. Using this custom shell feature allows you to restrain the Windows® features such as Control Panel.
Power	Used to operate power supply of this product in a state of custom shell.
System	Show the product's firmware, BIOS version, and OS version.
Touch Mode	Select from 3 modes (Normal, Water-detected, and Gloves) according to a use environment.
System Monitor	Monitor a state of the main unit, for example temperature or voltage, using a dashboard created with Node-RED.
Window Locker	Fix a window display position at the time of application boot when an external display is used.
Cellular	You can use the optional interface unit and a SIM card to data communication using 3G, 4G, and LTE radio waves. Double-click this icon will show the windows cellular option.

4.5 Supported features in Launcher compatibility

The difference of supported System features in Launcher is as shown below.

	PS6000 Atom Basic Box	SP5B411/412 (Windows 10)	SP5B41 (WES7)
Launcher	Supported	Supported	Supported
Buzzer	Supported	Not supported	Not supported
Brightness	Supported	Supported	Supported
Calibration	Supported	Supported	Supported
Front USB	Supported	Supported	Supported
Write Filter	Supported	Supported	Supported
HORM	Supported	Supported	Supported
Shell	Supported	Supported	Supported
Power	Supported	Supported	Supported
System	Supported	Supported	Supported
Touch Mode	Supported	Not supported	Not supported
System Monitor	Supported	Not supported	Not supported
Window Locker	Supported	Not supported	Not supported
Cellular	Supported	Not supported	Not supported
HMI Icon	Not supported	Supported	Supported
Task Changer / Task Switcher	Not supported	Supported	Supported
Eject	Not supported	Not supported	Supported
UART	Not supported	Supported	Supported

* Launcher similar with the SP5000 Open Box's launcher will be release later.

4.6 Details of touch operation for every series

Series	Touch Type	Driver	Touch Detection	Behavior when touch and hold	Supports two-point touch
PS5000	Resistive Film	PenMount Driver	Pen Up	Right Click (Default)	-
	Capacitive				✓
PS5000 + DA *1	Resistive Film	Windows Standard	Pen Down	Depend on the Host PC setting.	-
	Capacitive				✓
FP5000	Resistive Film	Windows Standard	Pen Down	Depend on the Host PC setting.	✓
SP5000 + MDA *2					
PS6000	Resistive Film	Windows Standard	Pen Down	Right Click (Default)	✓
	Capacitive				
FP6000	Resistive Film	Windows Standard	Pen Down	Depend on the Host PC setting.	✓
	Capacitive				

*1: Display Adapter

*2: Multi Display Adapter

Mouse Emulation Software (DMT-DD) is also available > <https://www.proface.com/en/node/50375>

Note when using on PS6000 Series

- The multi-touch function does not operate.
- It is not possible to use Calibration on the launcher.
- DMT-DD does not support the extend mode in multi monitor. Please use on single monitor or set to the duplicate mode.

- if you want to play the Touch Sound, please make the following settings

Play Type : Hardware

Sound Timing : At touch down

Beep setting

Frequency [Hz] : 2400

Sound Duration [ms] : 50

4.7 GP-Pro EX project file

Please follow below step in GP-Pro EX, to use SP5000 project file on PS6000.

1. Open the SP5000 project file.
2. Click **Project > System Settings > Display**.
3. Click **Change Display**.
4. Select as below for New Display fields.
 - **Series:** IPC Series (PC/AT) – PC/AT
 - **Model:** PC/AT
 - **Screen Size:** Select display size of PS6000 *1 e.g. 12.1" inch wide = 1280x800(WXGA)
 - **Orientation:** Landscape or Portrait *Usually same with current Display
5. Click **Change**.

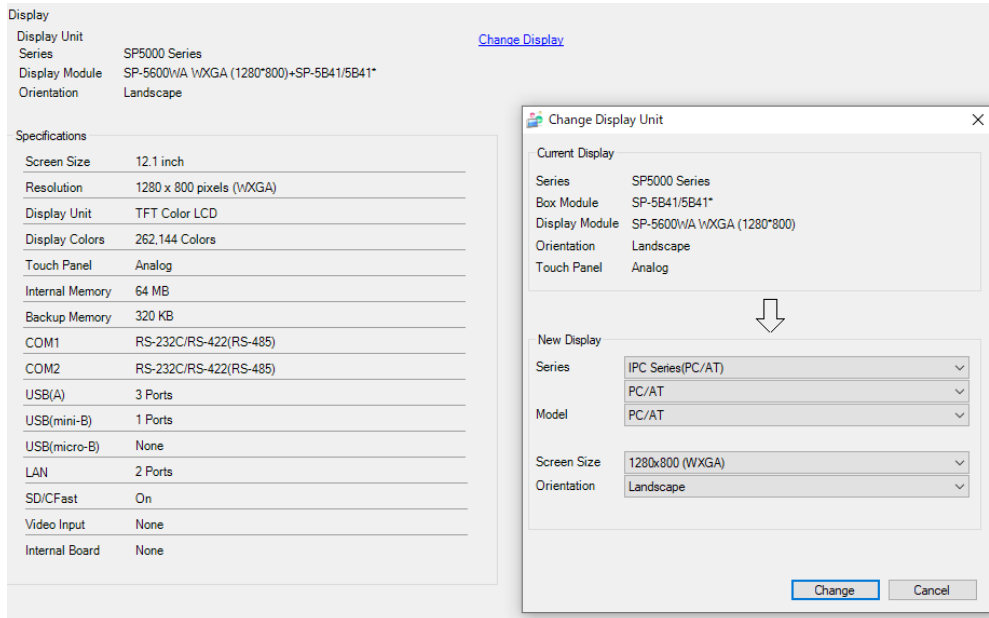

6. Two pop-ups will be shown in a row. Read the mention and click **Yes**.

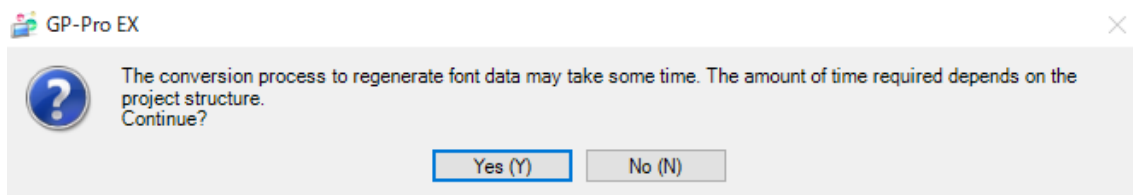
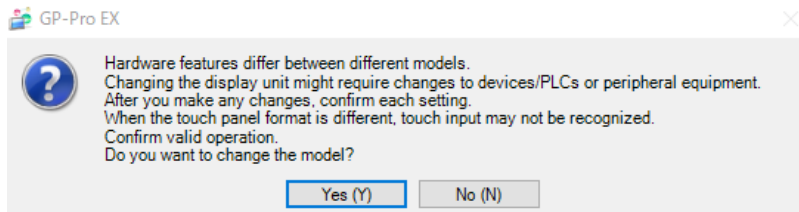

*When [Historical Data Retentive Settings] error has been shown, please follow **logging the data other than SRAM** [→4.8](#)

Error Check			
Level	Error Number	Screen-Location	Summary
Error	1085	Display Unit - IPC Settings	Unable to use [SRAM] in [Historical Data Retentive Settings] with this model. Please change it.

*1 if resolution is different from current display. Convert Resolution check box will be shown. When you want to convert to new resolution, put the check. After changing the resolution, ensure that the part and text sizes and positions are appropriate.

4.8 WinGP – Historical Data Retentive Settings

4.8.1 Logging to external device

When creating new project selecting IPC Series(PC/AT) – PC/AT, by enabling the logging, automatically logging data will be save to external drive.
 Minimum Historical Data Retentive Saving cycle will 1min. Saving enable size is bigger than SRAM.

4.8.2 logging the data other than SRAM

To setup D Drive for logging data, please follow below step in GP-Pro EX.

Select **Project > System settings > Display Unit**.

Select **WinGP** tab. Check the **Folder** and assign the **location** in Historical Data Storage Location

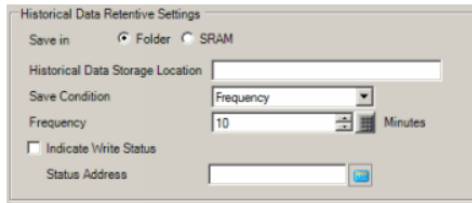

4.9 BLUE Runtime transfer

Please follow below step to transfer the RT license activation to PS6000 from SP5000 Open Box.

1. On SP5000 Open Box. Click Window Menu. Select Schneider Electric License Manager folder. Run License Manager.

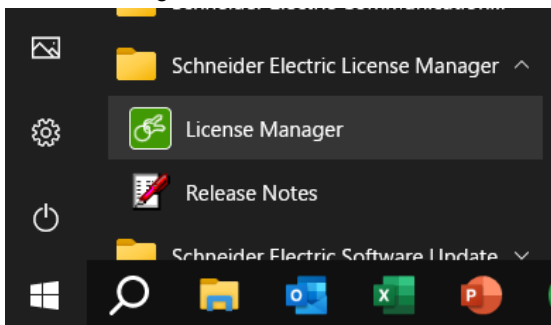

2. Click check box on the left of BLUE Runtime License (1). Don't forget to take a memo of Activation ID.
 Click Return (2).

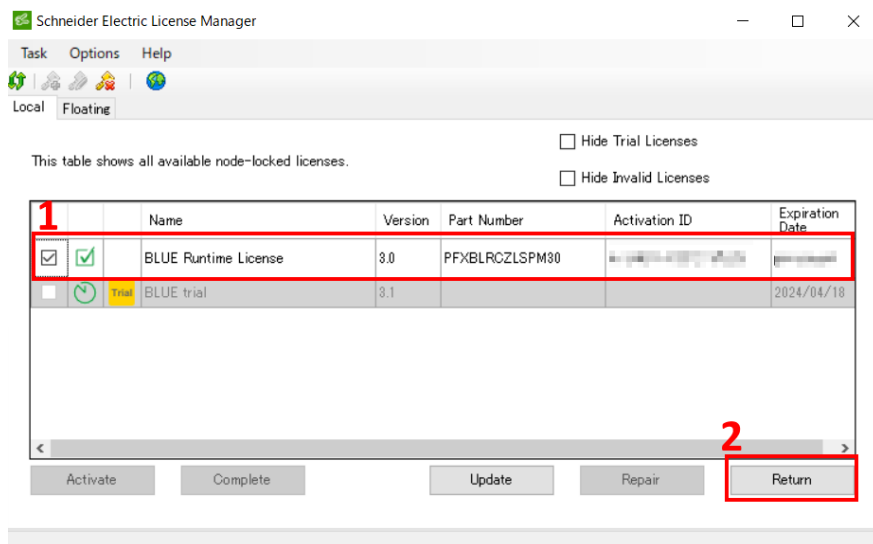

3. Pop up window explaining Returning License will be shown. Click Yes.

4. Pop up window explaining succeed of remove license will be shown. Click Finish.

5. On PS6000, Click Window Menu. Select Schneider Electric License Manager folder. Run License Manager.

6. Click Activate button.

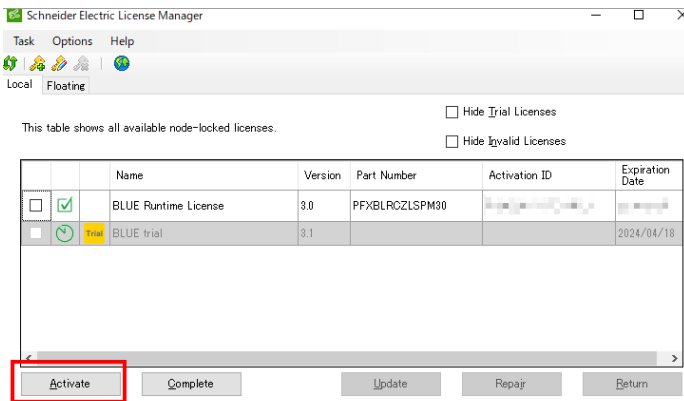

7. Enter Activation ID in step2 to text box (1)
Click Next > (2)

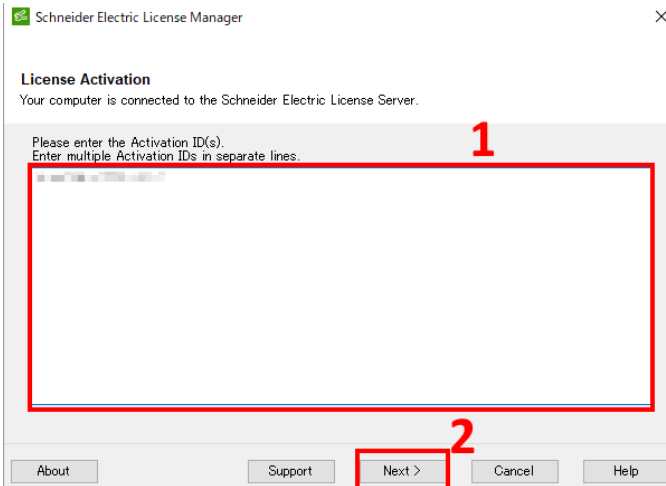

8. Pop up window explaining succeed of activating license will be shown. Click Finish.

*BLUE License has restriction of the number of deactivating and reactivating.
Please contact support center for further detail.

4.10 BLUE Project file

Please follow below step in BLUE, to use SP5000 project file on PS6000.

1. Open the SP5000 project file.
2. Click **System Architecture > Target01 (1) *1**.
3. Click **3 dots on the Series (2)**.

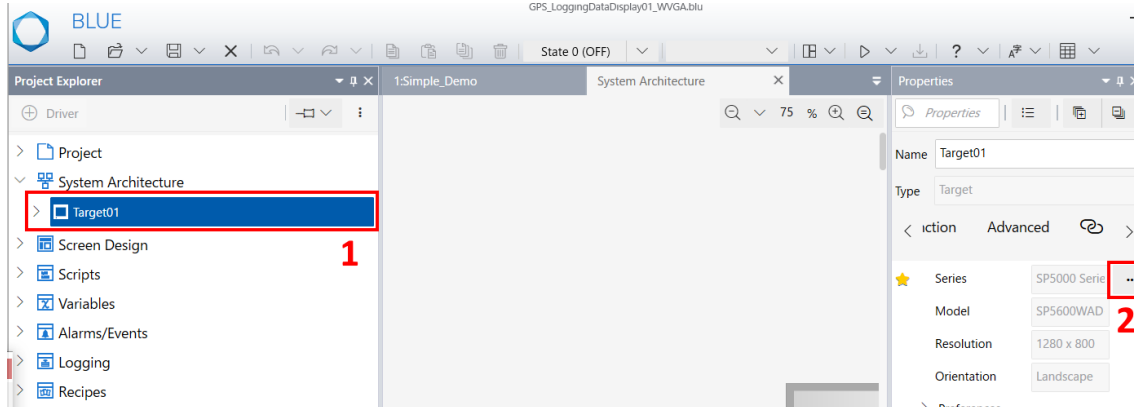

4. Select as below for New Display fields.
 - **Type:** IPC or PC/AT
 - **Resolution:** Select display size of PS6000 (e.g. 12.1" inch wide = 1280x800(WXGA))
 - **Orientation:** Landscape or Portrait *Usually same with current Display
5. Click **OK**.

4.11 BLUE historical data location

When select IPC or PC/AT, selection for logging data, for Logging and Alarm. will be Backup Memory or SD Card*1 or USB Storage*1.

Below is the location of logging data for each selection.

Please beware to re-assign the location when you change the project file to IPC or PC/AT from SP5000.



Backup Memory

Save to Folder will be automatically created in the C Drive.

SD Card

USB Storage

Location can assign in System Architecture > Target01 > Function > Options > Destination Folder.

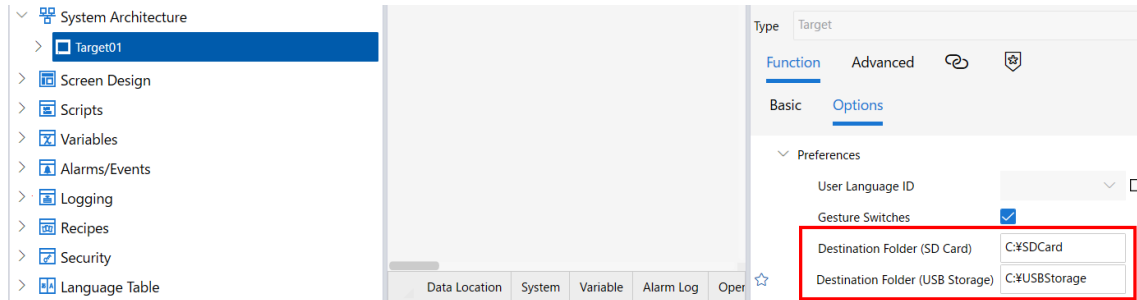

*1 simply selecting [SD Card] or [USB Storage] will NOT store the alarm history in the SD card or USB storage inserted in the display unit. To save the alarm history in the SD card or USB storage, specify the destination folder in the [Destination Folder (SD Card)] or [Destination Folder (USB Storage)]

4.12 Software notice when Writer Filter is enabled

When Write Filter(UWF) is enabled, data will be reset when restarting the product.

Software data such as variable data, will be also reset. If you need to avoid this, please create symbolic link of software folder to second device or external device

Default software folder :

BLUE : "C:\ProgramData\Pro-face\BLUE Runtime"

GP-Pro EX : "C:\ProgramData\Pro-face\WinGP"

Example of creating BLUE symbolic link folder D:\PS6000\BLUE DATA

1. Right Click Windows Start button > click Windows PowerShell (Administrator)

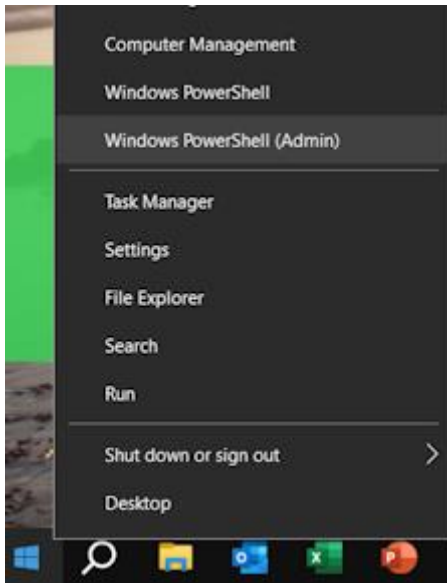

2. Input cmd and press Enter key.
3. Input < `mklink /D "D:\PS6000\BLUE DATA" "C:\ProgramData\Pro-face\BLUE Runtime"` > and press Enter key *1

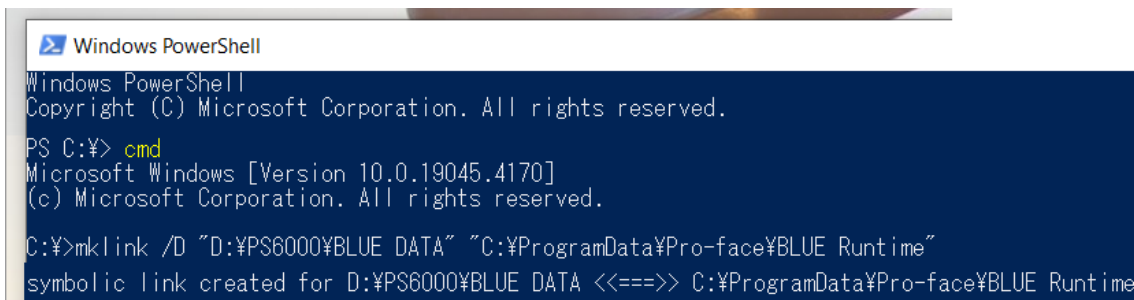

Only Alarm, logging, historical data need to be avoid the reset, changing the save folder to external device will be resolution. GP-Pro EX →[See 4.8](#) BLUE →[See 4.11](#)

But in also in this case, PS6000 need to be shut down by correctly from windows. If shut down from other case (e.g. Stop supplying the power to PS6000), data could be damage and could cause issue

*1 The symbolic link folder could not be exist before following this step. In this case "D:\PS6000\" need to be exist. But D:\PS6000\BLUE DATA should not be existing. It will be created as symbolic link folder after you follow the step.