

Digital
Human Machine Interface

Pro-face

GP2000H Series User Manual

Digital

Digital Electronics Corporation

Preface

Thank you for purchasing the Pro-face GP2000H Series programmable operator interface (hereby referred to as “GP unit”).

This GP unit, with its expanded functionality and improved overall performance, is an upgrade of Pro-face’s previous GP series panels. The GP2000H Series units are the “Handy” type GP units that are hand-held operable. The GP2000H Series units allow you to use the CF Card without attaching separately sold expansion units.

Please read this manual carefully as it explains, step by step, how to use the GP2000H correctly and safely.

Also, in this manual’s examples, the Mitsubishi MELSEC-AnA Series PLC is used whenever possible, connected in a one-to-one relationship with a GP2000H unit.

< Note >

1. It is forbidden to copy the contents of this manual, in whole or in part, except for the user’s personal use, without the express permission of Digital Electronics Corporation of Japan.
2. The information provided in this manual is subject to change without notice.
3. This manual has been written with care and attention to detail; however, should you find any errors or omissions, contact Digital Electronics Corporation and inform them of your findings.
4. Please be aware that Digital Electronics Corporation shall not be held liable by the user for any damages, losses, or third party claims arising from any uses of this product.

All Company/Manufacturer names used in this manual are the registered trademarks of those companies.

© Copyright 2002 Digital Electronics Corporation

Table of Contents

Preface	1
Essential Safety Precautions	7
General Safety Precautions	13
About GP2000H Series Models	15
UL/c-UL (CSA) Application Notes	15
CE Marking Notes	15
Package Contents	15
Revision Information	16
Documentation Conventions	16

Chapter 1 Introduction

1.1 Prior to Operating the GP2000H	1-1
1.2 System Design	1-3
1.2.1 GP2000H Series System Design	1-3
1.3 Accessories	1-5

Chapter 2 Specifications

2.1 General Specifications	2-1
2.1.1 Electrical	2-1
2.1.2 Environmental	2-2
2.1.3 Structural	2-2
2.2 Functional Specifications	2-3
2.2.1 Display	2-3
2.2.2 Memory	2-4
2.2.3 Clock	2-4
2.2.4 Touch Panel Switches	2-5
2.2.5 Interfaces	2-6
2.3 Interface Specifications	2-7
2.3.1 External Interfaces	2-7
2.4 Part Names and Functions	2-13
2.5 Dimensions	2-15
2.5.1 GP-2301H Series / GP-2401H Series External Dimensions	2-15
2.5.2 CF Card Interface Guard	2-16
2.5.3 Emergency Switch Guard	2-16

Chapter 3 Handling and Wiring

3.1 Handling the GP2000H	3-1
3.1.1 Wall Mount Adapter / Swivel Mount Arm	3-1
3.1.2 Hand Strap	3-3
3.1.3 Neck Strap	3-3
3.2 Interface / Switch Guards	3-5
3.2.1 CF Card Interface Guard	3-5
3.2.2 Emergency Switch Guard	3-5
3.3 Wiring	3-7
3.3.1 Wiring	3-7
3.3.2 Cable Installation	3-7
3.3.3 GP2000H Mode / GP-H70 Compatibility Mode	3-8
3.3.4 Switching DOUT/BUZZ Output Current Direction	3-11
3.4 Tool Connector	3-13
3.5 CF Card Installation and Removal	3-15
3.5.1 CF Card Handling	3-16
3.5.2 CF Card Access Switch	3-16

Chapter 4 Data Transfer

4.1 Serial Data Transfer	4-1
4.2 CF Memory Loader Tool	4-5
4.2.1 Data Upload and Download	4-5

Chapter 5 OFFLINE Mode

5.1 Entering OFFLINE Mode	5-3
5.1.1 After Plugging in the Power Cord	5-3
5.1.2 From the Menu Bar	5-3
5.2 OFFLINE Mode Main Menu	5-5
5.3 INITIALIZATION	5-5
5.4 SELF-DIAGNOSIS	5-7

Chapter 6 Initializing the GP-2301H

6.1 Initialization Screen	6-1
6.2 Initialization Items	6-3
6.3 SYSTEM ENVIRONMENT SETUP	6-3
6.3.1 SYSTEM SETUP	6-3
6.3.2 SYSTEM AREA SETUP	6-5
6.3.3 GLOBAL WINDOW SETUP	6-5
6.3.4 CHARACTER STRING DATA SETUP	6-7

Preface

6.4 SET UP I/O	6-9
6.4.1 SET UP SIO	6-9
6.4.2 COMMUNICATION SETUP	6-11
6.4.3 SET UP I/O	6-11
6.4.4 DISPLAY SETUP	6-15
6.4.5 PRINTER SETUP	6-15
6.4.6 EXPANSION SERIAL COMMUNICATION SETUP	6-16
6.4.7 EXPANSION SERIAL ENVIRONMENT SETUP	6-16
6.4.8 SET UP CAPTURE OPERATION	6-17
6.4.9 FUNCTION SETUP	6-18
6.4.10 COMMUNICATION PORT SETUP	6-18
6.5 PLC SETUP	6-19
6.5.1 SET UP OPERATION SURROUNDINGS (1:1 / n:1)	6-19
6.5.2 STATION SETUP (n:1)	6-20
6.5.3 CUSTOMIZE SETUP (n:1)	6-22
6.6 INITIALIZE INTERNAL MEMORY	6-24
6.6.1 INITIALIZE GP MEMORY	6-24
6.6.2 INITIALIZE CF CARD	6-24
6.6.3 CSV DATA INDEX	6-25
6.7 SET UP TIME	6-26
6.8 SET UP SCREEN	6-27
6.9 FONT SETTING	6-29

Chapter 7 Initializing the GP-2401H

7.1 Initialization Screen	7-1
7.2 Initialization Items	7-3
7.3 SYSTEM ENVIRONMENT SETUP	7-3
7.3.1 SYSTEM SETUP	7-3
7.3.2 SYSTEM AREA SETUP	7-5
7.3.3 GLOBAL WINDOW SETUP	7-5
7.3.4 CHARACTER STRING DATA SETUP	7-7
7.4 SET UP I/O	7-9
7.4.1 SET UP SIO	7-9
7.4.2 SET UP PRINTER	7-10
7.4.3 SET UP TOUCH PANEL	7-10
7.4.4 COMMUNICATION SETUP	7-13
7.4.5 SOUND SETTINGS	7-13
7.4.6 EXPANSION SERIAL COMMUNICATION SETUP	7-14
7.4.7 EXPANSION SERIAL ENVIRONMENT SETUP	7-14

7.4.10	FUNCTION SETUP	7-16
7.4.11	COMMUNICATION PORT SETUP	7-16
7.5	PLC SETUP	7-17
7.5.1	SET UP OPERATION SURROUNDINGS (1:1/n:1)	7-19
7.5.2	STATION SETUP (n:1)	7-19
7.5.3	CUSTOMIZE SETUP (n:1)	7-19
7.6	INITIALIZE INTERNAL MEMORY	7-23
7.6.1	INITIALIZE GP MEMORY	7-23
7.6.2	INITIALIZE CF CARD	7-23
7.6.3	CSV DATA INDEX	7-24
7.7	SET UP TIME	7-25
7.8	SET UP SCREEN	7-26
7.9	FONT SETTING	7-27

Chapter 8	RUN Mode and Errors
------------------	----------------------------

8.1	RUN Mode	8-1
8.1.1	After Connecting the Power Cord	8-1
8.1.2	Via OFFLINE Mode	8-3
8.2	SELF-DIAGNOSIS	8-3
8.2.1	SELF-DIAGNOSIS ITEM LIST	8-3
8.2.2	SELF-DIAGNOSIS – Details	8-5
8.3	Troubleshooting	8-9
8.3.1	Possible Types of Trouble	8-9
8.3.2	No Display	8-10
8.3.3	No GP / Host Communication	8-10
8.3.4	Touch Panel / Function Key Does Not Respond	8-15
8.3.5	Buzzer Sounds when GP Power is Turned ON	8-16
8.3.6	Clock Settings Cannot be Entered	8-17
8.3.7	Error Screen is Displayed	8-17
8.4	Error Messages	8-17
8.4.1	Error Message List	8-17
8.5	Error Message Details	8-19
8.5.1	System Errors	8-19
8.5.2	Illegal Address In Screen Data	8-19
8.5.3	PLC COM. Error	8-22
8.5.4	Clock Setup Errors	8-19
8.5.5	Screen Tag Limit Exceeded (384 max.)	8-24
8.5.6	OBJ. PLC Has Not Been Set Up	8-24
8.5.7	D-Script and Global D-Script Errors	8-24

Preface

8.5.8	Extended SIO Script Error	8-25
-------	---------------------------------	------

Chapter 9 Maintenance

9.1	Regular Cleaning	9-1
9.1.1	Cleaning the Display	9-1
9.2	Periodic Check Points	9-1
9.3	Replacing the Backlight	9-2

Index

Essential Safety Precautions

This manual includes procedures that must be followed to operate the GP correctly and safely. Be sure to read this manual and any related materials thoroughly to understand the correct operation and functions of the GP unit.

■ Safety Symbols

Throughout this manual, the following icons identify GP operation procedures that require special attention. These icons provide essential safety information for the following levels of danger:



Indicates situations that may result in major machine damage, severe bodily injury, or death if the instructions are not followed.



Indicates situations that may result in damage to the machinery, or minor bodily injury if the instructions are not followed.

WARNINGS

System Design

- **Do NOT make switches using the switches on the touch panels, which may cause operator injury and machine damage. To prevent major accidents caused by an output remaining either ON or OFF, set up circuits (such as limiters) that will monitor vital output signals. To prevent accidents caused by incorrect output or malfunction, design switches used by separate devices to perform important operations.**
- **Do NOT use GP touch panel switches to perform safety-related or important accident-prevention operations. These operations should be performed by separate hardware switches to prevent operator injury and machine damage.**
- **To prevent any possibility of bodily injury or material damage, design your system so that equipment will not malfunction due to a communication fault between the GP unit and its host controller.**



WARNINGS

- Do NOT use the GP as a warning device for critical warning alarms that can cause serious operator injury, machine damage, or production stoppage. Use stand-alone hardware and/or mechanical interlocks to design alarm indicators and their control/activator units.
- The GP is NOT appropriate for use with aircraft control devices, medical life-support equipment, central trunk data transmission (communication) devices, or nuclear power control devices, due to their inherent requirements of extremely high levels of safety and reliability.
- When using the GP with transportation vehicles (trains, cars, and ships), disaster and crime prevention devices, various types of safety equipment, and medical devices that are not life-support related, use redundant and/or failsafe system designs to ensure proper reliability and safety.
- The Emergency Switch and the 3-Position Enable Switch do NOT guarantee the operator's complete personal safety. Be sure to design your system so that it ensures the operator's complete personal safety.
- Unlike the GP unit's Standby Mode, after the GP unit's backlight burns out, the touch panel is still active. If the operator fails to notice that the backlight is burned out and touches the panel, a potentially dangerous machine misoperation can occur. Your backlight is burned out if:
 - your GP unit is not set to Standby Mode and the screen has gone blank
 - your GP unit is set to Standby Mode, but touching the screen does not cause the display to reappear

To prevent accidental machine misoperation, Pro-face recommends that you use the GP unit's **USE TOUCH PANEL AFTER BACKLIGHT BURNOUT** feature, to automatically detect a burnout and disable the touch screen.

Reference See 6.3.1 / 7.3.1 - "SYSTEM SETUP."



WARNINGS

Installation Warnings

- High voltage runs through the GP unit. To prevent an electrical shock, do NOT disassemble the GP for any reason other than to replace the backlight.
- Do NOT modify the GP unit. Doing so may cause a fire or an electrical shock.
- Do NOT use the GP in an environment where flammable gases are present, to prevent explosions from occurring.

Wiring Warnings

- To prevent electrical shock or equipment damage, unplug the GP unit's power cord from the power supply prior to installing or wiring the GP.
- Do NOT use power levels with the GP that are higher or lower than the GP unit's specified power range. Doing so may cause a fire or electrical shock.

Operation and Maintenance Warnings

- The GP uses a lithium battery to back up its internal clock and to control memory data. If the battery is incorrectly replaced (reversed positive [+] and negative [-] ends), the battery may explode. Therefore, Pro-face recommends that you contact your local GP distributor for instructions before replacing or changing the battery.



CAUTIONS

Installation Cautions

- To reduce the risk of incorrect input or output signals, be sure that any data cables attached to the GP unit's connector make full contact with the connector pins.

General Wiring Cautions

- To prevent electrical shocks or malfunctions, be sure the cable's FG (earth) wire is grounded as follows:
 - (1) maximum grounding resistance: 100 Ω
 - (2) minimum grounding wire diameter: 2 mm²
- The GP unit's wiring should be checked to confirm that both the operating voltage and wiring terminal locations are correct. If either the voltage or the wiring terminal location is incorrect, it can cause a fire or accident.
- Be sure that metal filings or wiring remnants do not fall inside the GP, since they can cause a fire, accident, or malfunction.

GP Operation and Maintenance Cautions

- The liquid crystal panel contains a powerful irritant. If, for any reason, the panel is damaged and this liquid enters your eyes, flush your eyes for 15 minutes with running water and contact a physician immediately.
- Prior to inserting or removing a CF Card, and to prevent damage to or loss of the CF Card's internal data, turn the GP unit's CF Card Access Switch OFF, and make sure that the ACCESS lamp is not lit.
- While a CF Card is being accessed, NEVER:
 - turn OFF the GP
 - reset the GP
 - insert a CF Card
 - remove a CF Card



CAUTIONS

Prior to performing these operations, create and use a special GP application screen that will prevent access to the CF Card.

Reference Refer to the *GP-PRO/PBIII for Windows Tag Reference Manual* (included in the GP screen creation software).

- **Use Pro-face's CF Cards. Other manufacturers' CF Cards are not compatible with the specifications.**

GP Unit Disposal Cautions

- **The GP unit should be disposed of in a manner appropriate to, and in accordance with, the user country's industrial machinery disposal standards.**

General Safety Precautions

■ About the Operation Environment

- Do NOT strike the touch panel with a hard or pointed object, or press on the touch panel with too much force, since it may damage the touch panel or the display.
- Do NOT install the GP where the ambient temperature can exceed the allowed range. Doing so may cause the GP to malfunction or shorten its operation life.
- Do NOT restrict or limit the GP unit's naturally-occurring, rear-face ventilation, and do NOT store or use the GP in overheated areas.
- Do NOT store or use the GP unit in areas where large, sudden temperature changes can occur. These changes can cause condensation to form inside the unit, which can cause possible unit malfunctions.
- Do NOT allow water, liquids, metals, or charged particles to enter inside the GP unit's outer casing, since they can cause either a GP malfunction or an electrical shock. The allowable pollution degree is 2.
- Do NOT store or use the GP in direct sunlight, or in excessively dusty or dirty environments.
- Do NOT store or use the GP in an environment where shaking or excessive vibration can occur.
- Do NOT store or use the GP where chemicals (such as organic solvents and acids) can evaporate, or in environments where chemicals and acids are present in the air.
 - Corrosive chemicals: acids, alkalines, liquids containing salt
 - Flammable chemicals: organic solvents
- Do NOT use paint thinner or organic solvents to clean the GP.
- Do NOT store or operate the LCD (Liquid Crystal Display) in areas that receive direct sunlight, since the sun's ultraviolet (UV) rays may cause the quality of the LCD to deteriorate.
- Storing this unit in areas at temperatures that are lower than is recommended in this manual's specifications may cause the LCD panel's liquid to congeal, which may damage the panel. Conversely, if the storage area's temperature becomes higher than the allowed level, the LCD panel's liquid will become isotropic, causing irreversible damage to the LCD. Therefore, be sure to store the panel only in areas where temperatures are within the ranges specified in this manual.



■ About the Screen Data

Due to the possibility of unexpected accidents, be sure to back up the GP unit's screen data regularly.

■ About the GP Unit's Display Panel

- The data that is currently displayed on the GP unit's screen, the screen's brightness, and the GP unit's voltage^{*1} affect the screen's intensity of *Contouring* — wavelike pattern that is created when some parts of the screen are brighter than others.
- The minute, dark and light grid-points on the display panel's surface are part of the GP unit's design and are not defects.
- Extended shadows, or “crosstalk,” may appear on the sides of screen images. This is normal for an LCD panel.
- Sometimes the display area may look as if the display colors have changed. This is a common attribute of LCDs and is not a defect.
- Displaying a single image for long periods of time can cause an afterimage to remain when the screen display is changed.

To prevent this effect:

Use the GP unit's Standby Mode, which automatically turns the screen OFF when no input is entered within a specified time period.

Reference See 6.3.1 / 7.3.1 – “SYSTEM SETUP.”

- Write “FFFh” to the System Area's DISPLAY OFF address^{*2} to turn the screen display OFF when the following actions are not performed within the user-specified period of time.
 - Change Screen
 - Touch Screen
 - Alarm Display

Do NOT display any single screen for a long period of time. Try to change the screen display periodically.

1. The backlight's brightness may vary or its lighting may be delayed if the voltage provided is low — even if still within the range of rated voltage listed in the specifications.

2. The following addresses assume all System Data Area settings are entered. If they are **not** all entered, the correct word address may be different from those given here since the following addresses are relative, not fixed.

- With the Direct Access Method — use System Data Area word address +9
- With the Memory Link Method — use System Data Area word address +12

Reference Refer to the GP-PRO/PBIII for Windows Device / PLC Connection Manual (included with the GP screen creation software).

About GP2000H Series Models

The GP2000H Series, in this manual, refers to the following GP unit model numbers:

Series Name		Model Name	Model Type	Comments	GP Type in Screen Creation Software
GP2000H Series	GP-2301H Series	GP-2301HL	GP2301H-LG41-24V	UL/c-UL (CSA) Approved, CE Marked	GP2301HL
		GP-2301HS	GP2301H-SC41-24V		GP2301HS
	GP-2401H Series	GP-2401HT	GP2401H-TC41-24V		GP2401H

UL/c-UL (CSA) Application Notes

The GP2301H-LG41-24V/GP2301H-SC41-24V/GP2401H-TC41-24V are UL/c-UL (CSA) listed products.

UL File No. E171486 (UL60950)

This unit conforms to the following product standards:

- **UL 60950** Third Edition (Standard for Safety of Information Technology Equipment)
- **CAN/CSA-C22.2 No. 60950-00** (Standard for Safety of Information Technology Equipment)
 - GP2301H-LG41-24V (UL Registration Model: 3080028-03)
 - GP2301H-SC41-24V (UL Registration Model: 3080028-02)
 - GP2401H-TC41-24V (UL Registration Model: 3080028-01)

CE Marking Notes

The GP2301H-LG41-24V/GP2301H-SC41-24V/GP2401H-TC41-24V are CE marked products that conform to EMC directives EN55011 Class A and EN61000-6-2.

* For detailed CE marking information, contact your local GP distributor.

Package Contents

Please verify that the GP unit's packing box contains all the items listed below.

■ **GP Unit (1)**

GP2301H-LG41-24V
GP2301H-SC41-24V
GP2401H-TC41-24V

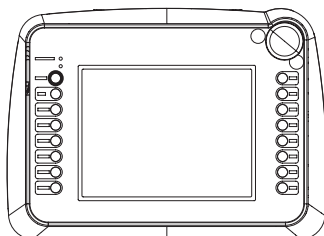

■ **Installation Guide (1)**

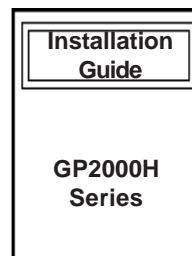

■ **Hand Strap**



■ **Emergency Switch Guard (1)**

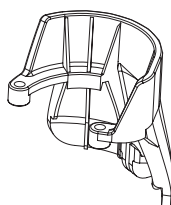

■ **CF Card Interface Guard (1)¹**

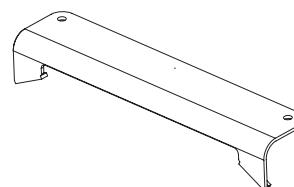

■ **Emergency Switch Guard Attachment Screws (2)**

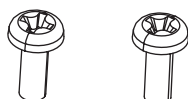

■ **CF Card Interface Guard Attachment Screws (2)**



Special care and attention have been given to the packaging of this GP unit. However, if any of the items are damaged or missing, contact your local GP distributor immediately for prompt service.

1. The CF Card Interface Guard is used in a NEMA#250 TYPE4X/12 environment. Units that are Revision A or later correspond to a NEMA#250 TYPE4X/12 rating. For a description of how to identify your unit's revision code, see Page 16.

Revision Information

Revision information can be found on your GP unit’s rear-face Pro-face label. The bottom-most [REV] row’s asterisk (*) mark indicates the Revision character.

In the example shown below, the asterisk indicates that this unit’s Revision character is “D”.

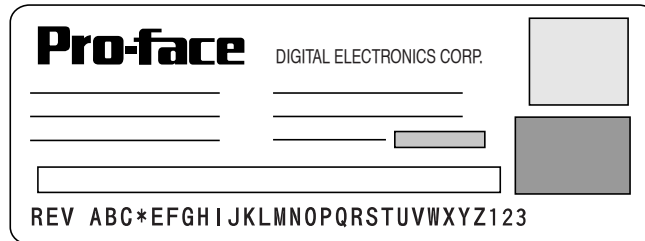

Documentation Conventions

The list below describes the documentation conventions used in this manual.

Symbol	Meaning
	Indicates important information or procedures that must be followed for correct and risk-free software/device operation.
GP Screen Creation Software	Indicates the GP-PRO/PBIII for Windows screen creation software (Ver. 6.10 or higher). ^{*1} For information on how to confirm the version, refer to the “GP-PRO/PBIII for Windows Operation Manual”, which is supplied with the GP screen editor software.
PLC	Indicates Programmable Logic Controller (or sequencer)
*1	Indicates useful or important supplemental information.
	Provides useful or important supplemental information.
	Cross-references to useful or important supplemental information.

Some differences between GP-2301H Series and GP-2401H Series units can be seen in the external appearance, OFFLINE Mode screens, and functions available.

In this manual, the explanation of one model’s interface (external appearance or OFFLINE Mode) rather than another is for the reader’s convenience only. All functional differences between the GP-2301H and the GP-2401H will be clearly noted.

In addition, be aware that OFFLINE Mode images for each GP unit’s initial settings will differ, depending on the model.

For Initialization information, please refer to the relevant chapter for the model you are using.

- *GP2301H Series – Chapter 6*
- *GP2401H Series – Chapter 7*

Chapter 1 Introduction

1. Prior to Operating the GP
2. System Design
3. Accessories

1.1 Prior to Operating the GP2000H

Use the following steps to create projects for the GP unit.

1. **Preparation** – Before using the GP, be sure that you have all the required hardware and have read all specification, wiring, and installation information.

Reference *See Chapter 2 – “Specifications” and Chapter 3 – “Handling and Wiring.”*

2. **Screen Design** – Create a sample screen and design a Tag layout with the Screen layout sheets and Tag lists provided in the screen creation software.

3. **Select GP and PLC types** – Using the input areas provided, select the GP and the PLC types to be used.

Reference *Refer to the GP-PRO/PBIII for Windows Operation Manual (included in the GP screen creation software).*

4. **Create Screen/Run Screen Setup** – Set up the screen and tags in your screen creation software according to your Screen Design.

Reference *Refer to the GP-PRO/PBIII for Windows Operation Manual and Tag Reference Manual (included in the GP screen creation software).*

5. **Transfer Screen Data** – Transfer the data from the screen creation software on your PC to the GP unit using the Data Transfer Cable.

Reference *Refer to the GP-PRO/PBIII for Windows Operation Manual (included in the GP screen creation software).*

6. **Initial Set Up** – Enter your GP unit’s Initial Settings, if necessary.

Reference *See Chapter 6 / 7 – “Initializing the (GP-2301H / GP-2401H).” Refer to the GP-PRO/PBIII for Windows Device / PLC Connection Manual (included in the GP screen creation software).*

7. **Operation** – Connect the GP unit with the host (PLC) using the appropriate connection cable (different cables may be necessary for different hosts), and then operate the unit.

Reference *Refer to the GP-PRO/PBIII for Windows Device / PLC Connection Manual (included in the GP screen creation software).*

1.2 System Design

1.2.1 GP2000H Series System Design

The following diagram represents the main selection of devices connectable to the GP.

■ GP RUN Mode Peripherals

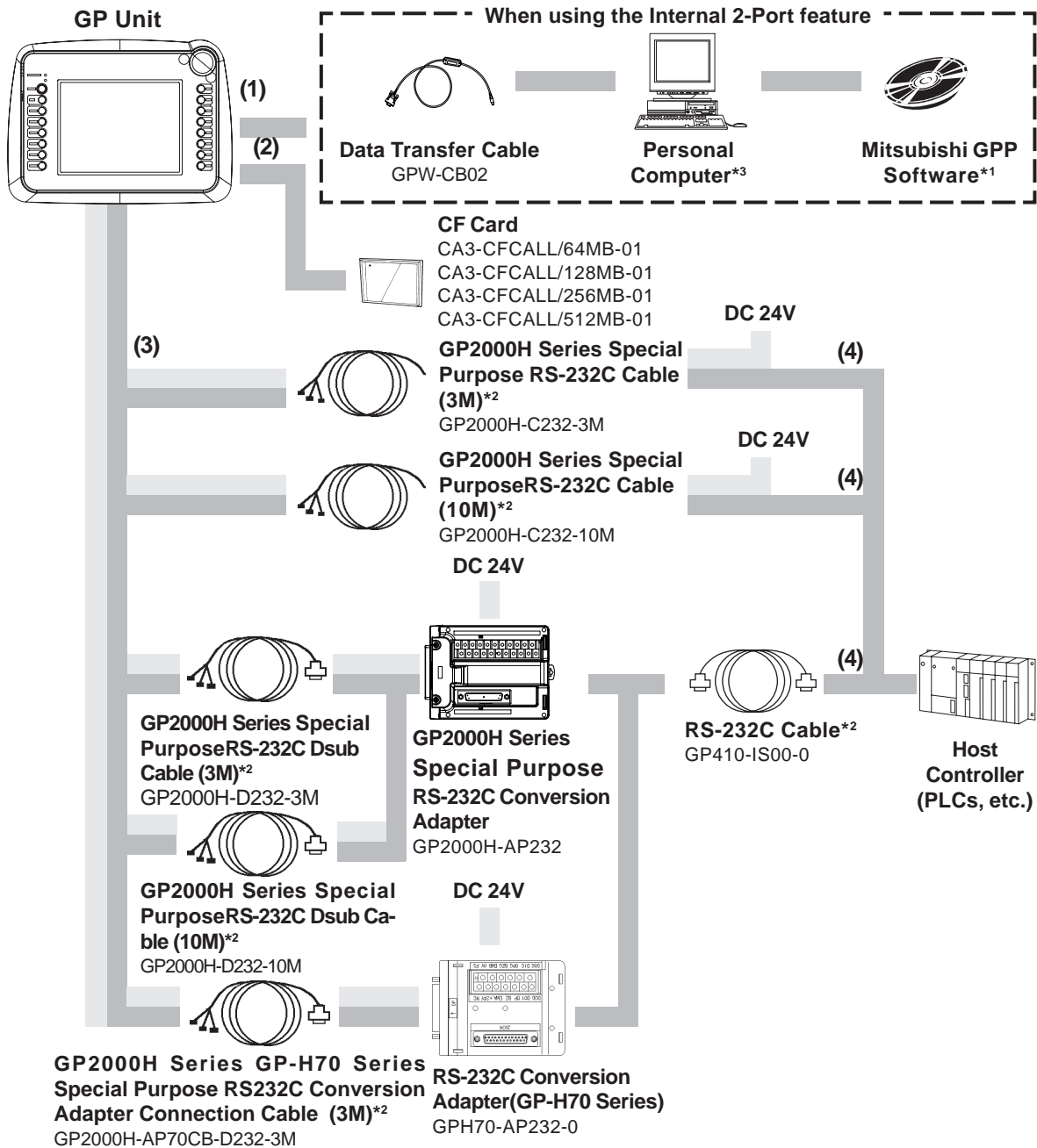

1. For details on compatible PLC types and software:

Reference Refer to the GP-PRO/PBIII for Windows Device / PLC Connection Manual (included in the GP screen creation software).

2. For details on connectable PLC types and model connections:

Reference Refer to the GP-PRO/PBIII for Windows Device / PLC Connection Manual (included in the GP screen creation software).

3. For information on the full range of compatible PLC types and software,

Reference Refer to the GP-PRO/PBIII for Windows Operation Manual (included in the GP screen creation software).

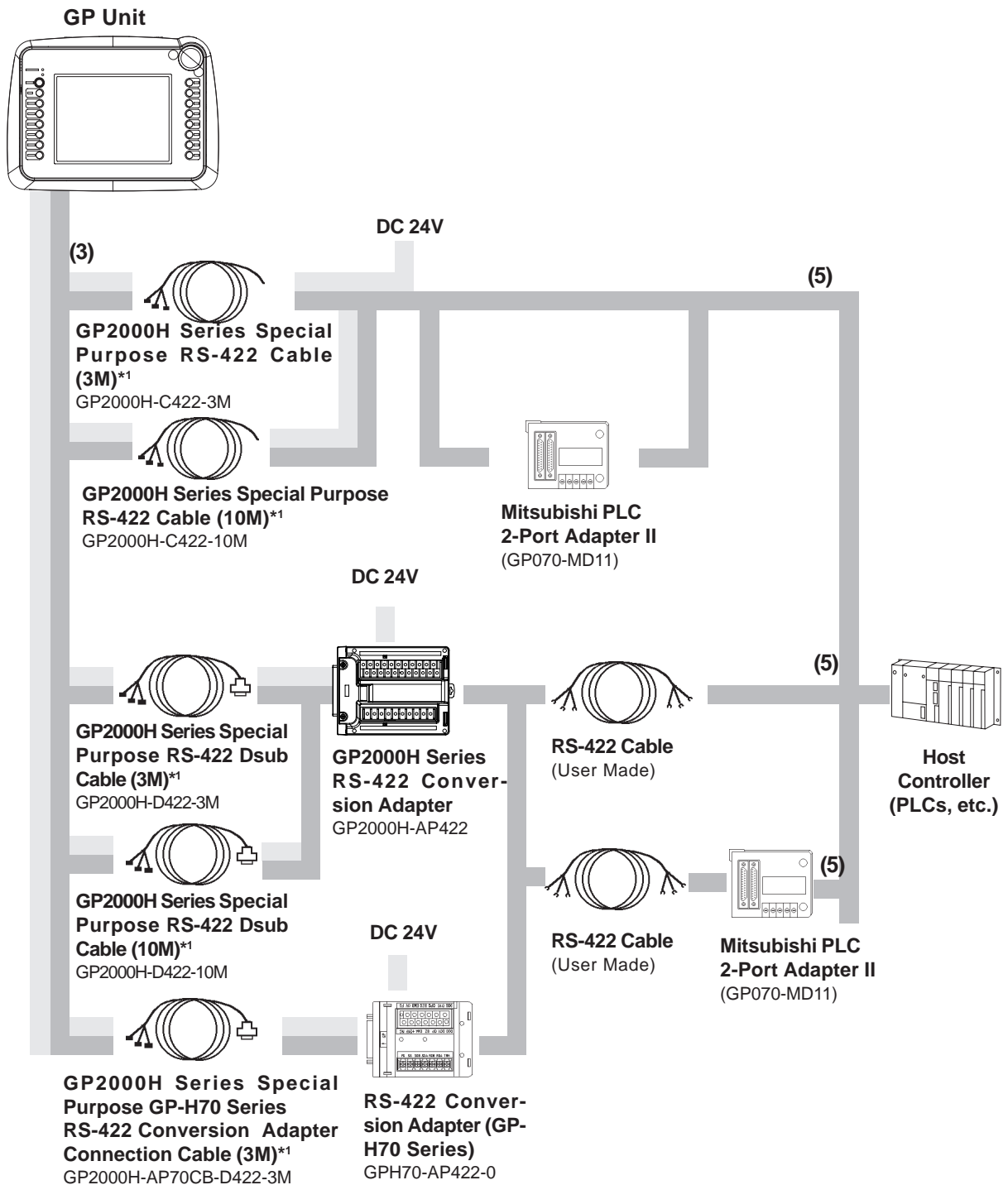

1. Certain PLC types and models cannot be connected.

Reference Refer to the *GP-PRO/PBIII for Windows Device / PLC Connection Manual* (included in the GP screen creation software).

Chapter 1 – Introduction

■ GP Edit Mode Peripherals

GP Unit

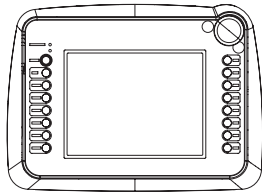

GP Interfaces

- (1) Tool Connector
- (2) CF Card Interface
- (3) External Interface
 - Serial Interface
 - DC 24V Interface
 - External Output Interface

PLC Interfaces

- (4) RS-232C Port
- (5) RS-422 Port

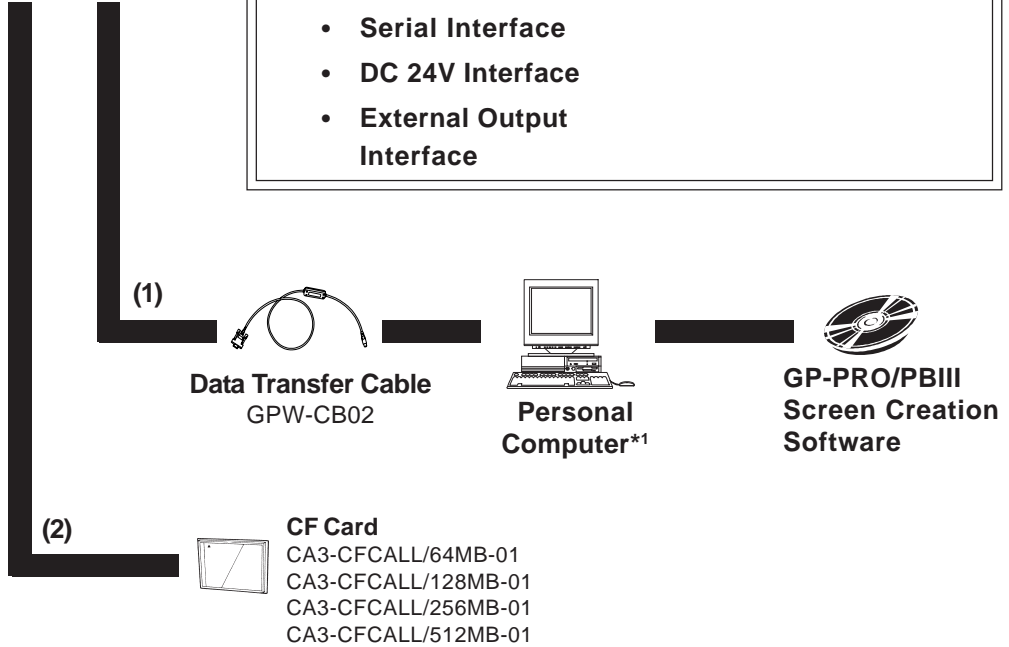

1. Certain PCs cannot be used in this system. For details:

▼Reference▲ Refer to the *GP-PRO/PBIII for Windows Operation Manual* (included in the GP screen creation software).

1.3 Accessories

All optional equipment listed here is produced by Digital Electronics Corporation.

■ Available Software

Product Name	Model No.	Description
GP-PRO/PBIII C-Package02 (GP-PRO/PBIII for Windows Ver. 6.10 or later)	GPPRO-CNT01W- P02	Software used with a personal computer to create the GP unit's screen data.

■ Tool Connector

Product Name	Model No.	Description
Data Transfer Cable	GPW-CB02	Connects the GP to a personal computer. Transfers screen data and user programs.

■ External Interfaces

Product Name	Model No.	Description
GP2000H Series Special Purpose RS-232C Cable (3M) ^{*1}	GP2000H-C232-3M	Interface cables between the host (PLC) and the GP unit.
GP2000H Series Special Purpose RS-422 Cable (3M) ^{*1}	GP2000H-C422-3M	
GP2000H Series Special Purpose RS-232C Cable (10M) ^{*1}	GP2000H-C232-10M	
GP2000H Series Special Purpose RS-422 Cable (10M) ^{*1}	GP2000H-C422-10M	
GP2000H Series Special Purpose RS-232C Dsub Cable (3M) ^{*1}	GP2000H-D232-3M	Connects the GP2000H Adapter and GP2000H
GP2000H Series Special Purpose RS-422 Dsub Cable (3M) ^{*1}	GP2000H-D422-3M	
GP2000H Series Special Purpose RS-232C Dsub Cable (10M) ^{*1}	GP2000H-D232-10M	
GP2000H Series Special Purpose RS-422 Dsub Cable (10M) ^{*1}	GP2000H-D422-10M	
GP2000H Series Special Purpose GP-H70 Series RS-232C Conversion Adapter Connection Cable (3M) ^{*1}	GP2000H-AP70CB-D232-3M	Connects the GP-H70 Adapter and GP2000H
GP2000H Series Special Purpose GP-H70 Series RS-422 Conversion Adapter Connection Cable (3M) ^{*1}	GP2000H-AP70CB-D422-3M	
RS-232C Cable ^{*1}	GP410-IS00-0	Connects the RS-232 Adapter and Host (PLC)

1. For details about the range of connectable PLCs:

Reference Refer to the GP-PRO/PBIII for Windows Device / PLC Connection Manual (included in the GP screen creation software).

Chapter 1 – Introduction

■ External Interfaces (cont.)

Product Name	Model No.	Description
Mitsubishi A Series Programming Port I/F Cable	GP430-IP10-0	Connects directly to Mitsubishi's PLC I/F Programming Console. Simultaneous use of program console, however, is not possible.
Mitsubishi FX Series Programming Port I/F Cable	GP430-IP11-0	
GP2000H Series RS-232C Conversion Adapter	GP2000H-AP232	Conversion adapter to convert serial data to RS-232C Dsub format.
GP2000H Series RS-422 Conversion Adapter	GP2000H-AP422	Conversion adapter to convert serial data to RS-422 Dsub format.

■ CF Card Items

Product Name	Model No.	Description
CF Cards	CA3-CFCALL/64MB-01	GP Series CF Card (64MB)
	CA3-CFCALL/128MB-01	GP Series CF Card (128MB)
	CA3-CFCALL/256MB-01	GP Series CF Card (256MB)
	CA3-CFCALL/512MB-01	GP Series CF Card (512MB)
CF Card Adapter	GP077-CFAD10	CF Card Adapter for standard PC Card Slot.

■ Optional Items

Product Name	Model No.	Description
Screen Protection Sheet (5 sheets/set)	GP2000H-DF10	Disposable protective, dirt-resistant sheet for the GP unit's screen. The GP unit's touch panel can be used with this cover sheet attached.
Neck Strap	GP2000H-STRAP11	Strap used to hang GP unit from neck while operating.
Wall Mount Adapter	CA1-WMALRG-01	Fasteners used to mount the GP2000H Series unit on a stand or wall

■ Maintenance Items

These are all original GP standard equipment items. They are also available separately as optional maintenance items.

Product Name	Model No.	Description
Hand Strap	H70-HS00-MS	Strap used to hold the GP unit.
Emergency Switch Guard	GP2000H-EMGD11	Cover used to prevent the Emergency Switch from be accidentally pushed.
CF Card Interface Guard	GP2000H-CFGD11	NEMA standard 1 type fasteners used to prevent the CF Card cover from being accidentally opened or closed.

1. The CF Card Interface Guard is used in a NEMA#250 TYPE4X/12 environment.

Units that are Revision A or later correspond to a NEMA#250 TYPE4X/12 rating. For a description of how to identify your unit's revision code, see the **Preface - Page 16**.

Chapter

2 Specifications

1. General Specifications
2. Functional Specifications
3. Interface Specifications
4. Part Names and Functions
5. Dimensions

2.1 General Specifications

2.1.1 Electrical

Rated Voltage	DC 24V
Rated Voltage Range	DC 19.2V to DC 28.8V
Allowable Voltage Drop	10ms max.
Power Consumption	15W max.
In-Rush Current	30A max.
Voltage Endurance	AC 500V 20mA for 1 minute (between charging and FG terminals)
Insulation Resistance	20M Ω or more at DC 500V (between charging and FG terminals)

Chapter 2 – Specifications

2.1.2 Environmental

Ambient Operating Temperature (Internal Panel and Display Screen)	0°C to +40°C
Storage Temperature	-20°C to +60°C
Ambient Humidity	10%RH to 90%RH (non-condensing, wet bulb temperature: 39°C max.)
Storage Humidity	10%RH to 90%RH (non-condensing, wet bulb temperature: 39°C max.)
Air Purity (Dust)	0.1mg/m ³ max. (non-conductive levels)
Pollution Degree	Level 2
Corrosive Gasses	Free of corrosive gasses
Atmospheric Endurance (GP Operation Altitude)	800hPa to 1,114hPa (2000 meters max.)
Vibration Resistance	IEC61131-2 (JIS B 3502) compliant When Vibration is NOT Continuous 10Hz to 57Hz 0.075mm, 57Hz to 150Hz 9.8m/s ² When Vibration is Continuous 10Hz to 57Hz 0.035mm, 57Hz to 150Hz 4.9m/s ² 10 times (80 min.) for each (X, Y, Z) direction
Shock Resistance	IEC61131-2 (JIS B 3502) compliant 147m/s ² Release Time: 11ms Twice for each (X,Y,Z) direction.
Drop Resistance	IEC61131-2 (JIS B 3502) compliant 1.0 meter drop - 2 times.
Noise Immunity (via noise simulator)	Noise Voltage: 1000Vp-p Pulse Duration: 1μs Rise Time: 1ns
Electrostatic Discharge Immunity	Contact Discharge Method 6kV (complies with EN 61000-4-2 Level 3)

2.1.3 Structural

Grounding	100Ω max., or your country's applicable standard
Ratings	Equivalent to IP65f (JEM 1030) NEMA#250 Type4X/12* ¹
External Dimensions	W253mm x H185mm x D58mm [9.96 in.x 7.28 in. x 2.28 in.] (excluding projections)
Weight	1.2 kg [2.65 lb] max.* ²
Cooling Method	Natural air circulation

1. When using the CF Card Interface Guard Attachment Screws (included in the package). The CF Card Interface Guard is used in a NEMA#250 TYPE4X/12 environment. Units that are Revision A or later correspond to a NEMA#250 TYPE4X/12 rating. For a description of how to identify your unit's revision code, see **Preface - Page 16**.
2. Not including the CF Card Interface Guard Attachment Screws or the Emergency Switch Guard.

2.2 Functional Specifications

2.2.1 Display

		GP2301H-LG41-24V	GP2301H-SC41-24V	GP2401H-TC41-24V
Type (LCD)		Monochrome	STN Color	TFT type Color
Resolution		320 x 240 pixels		640 x 480 pixels
Effective Display Area		W115.2mm x H86.4mm [4.54 in. x 3.40 in.]		W132.5mm x H99.4mm [5.22 in. x 3.91 in.]
Colors		Black and White, 2 levels of gray/ Black and White, 8 levels of gray ² (Color switching is done via the software.)	64 Colors	256 Colors: No Blink / 64 Colors: 3-speed Blink ¹ (Color switching is done via the software.)
Backlight		CCFL (Service Life: 50,000 hrs. min. at 25°C and 24-hour operation)		
Contrast Control		Eight (8) levels of adjustment available via touch panel.		
Brightness Control		Four (4) levels of adjustment available via touch panel.		
Language Fonts		ASCII: (Code page 850) Alphanumeric (incl. Eur. chars.) Chinese: (GB2312 – 80 codes) simplified Chinese fonts Japanese: ANK 158, Kanji: 6962 (JIS Standards 1 & 2) Korean (KSC5601 – 1992 codes): Hangeul fonts Taiwanese (Big 5 codes): traditional Chinese fonts		
Text	Display Sizes^{*3}	8X8 dot, 8X16 dot, 16X16 dot, and 32X32 dot fonts		
	Font Sizes^{*4}	Height can be expanded 1, 2, 4, or 8 times. Width can be expanded 1/2 ^{*5} , 1, 2, 4, or 8 times.		
Char. Resolution	8x8 dots	40 char. x 30 rows		80 char. x 60 rows
	8x16 dots	40 char. x 15 rows		80 char. x 30 rows
	16x16 dots	20 char. x 15 rows		40 char. x 30 rows
	32x32 dots	10 char. x 7 rows		20 char. x 15 rows

1. Changing the Colors setting to “256 Colors” will disable the blink feature on all screens in your project. If you wish to use the blink feature, select “64 Colors.”
2. In order to set the monochrome (eight levels of gray) mode, GP-PRO/PB III for Windows Ver. 6.2 or later is required. Depending on the color used, selecting MONOCHROME 8 HUES may cause the GP unit’s screen to flicker and make it difficult to distinguish colors. Confirm that all colors display as expected prior to using this mode.
3. The display font depends on the selected character (language) or size.
Reference See 6.9 / 7.9 – “FONT SETTING.”
4. When using screen editor versions 6.0 or earlier, fonts can be scaled only 1,2,4, or 8 times.
5. Only available when using “Half-2 Byte Character” settings via software.
(Only Chinese, Taiwanese, and Korean OS)

Chapter 2 – Specifications

2.2.2 Memory

	GP-2301H Series	GP-2401H Series
Application	1MB FLASH EPROM	2MB FLASH EPROM
	[Approx. 320 screens at 3.2KB/screen]	[Approx. 640 screens at 3.2KB/screen]
Data Backup	128KB SRAM	
	[uses a lithium battery] ¹	

1. A Lithium battery's lifetime is:

- 10 years when the battery's ambient temperature is 40° C max.
- 4.1 years when the battery's ambient temperature is 50° C max.
- 1.5 years when the battery's ambient temperature is 60° C max.

When used for backup:

- Approximately 60 days, with a fully charged battery
- Approximately six (6) days, with a half-charged battery

2.2.3 Clock

	GP-2301H Series	GP-2401H Series
Clock Accuracy	±65 seconds/month (at room temperature)	



Note:

The GP unit's internal clock has a slight error. At normal operating temperatures and conditions, with the GP unit operating from its lithium battery, the degree of error is 65 seconds per month. Variations in operating conditions and battery life can cause this error to vary from -380 to +90 seconds per month. For systems where this degree of error will be a problem, the user should be sure to monitor this error and make adjustments when required.

Reference See 6.7 / 7.7 – “SET UP TIME.”

2.2.4 Touch Panel Switches

	GP2301H Series	GP-2401H Series
Touch Panel	16 x 12 keys/screen 1- or 2-point push selectable	32 x 24 keys/screen 1- or 2-point push selectable
Function Switches	total of 11	total of 15
Operation Switch	Function Switch (OP.) key Push-type switch on front (top-left) of GP2000H unit	
Emergency Switch	Push-lock Switch Compliant Standard: ISO 13850, EN418, JIS B 9703 IEC 60947-5-1, EN60947-5-1, JIS C 8201-5-1 UL508 (Recognized) CSA C22.2 No.14 (Recognized) Applicable Standard ¹ : ISO 13849-1, EN954-1, JIS B 9705-1	
3-Position Enable Switch	GP2000H Rear-face Switch 3-Position Output Compliant Standard: IEC 60947-5-1, EN60947-5-1 JIS C 8201-5-1 ANSI/RIA R15.06-1999 UL508 (Recognized) CSA C22.2 No.14 (Recognized) Applicable Standard ¹ : ISO 13849-1, EN954-1, JIS B 9705-1	

1. Overall system may not meet these standards if implemented outside these parameters. Be sure to follow these standards when designing the system.

Chapter 2 – Specifications

2.2.5 Interfaces

■ GP-2301H / GP-2401H Series Units

Serial Interface	Asynchronous Transmission: RS-232C/RS-422 Data Length: 7 or 8 bits Stop Bit: 1 or 2 bits Parity: None, Odd or Even Data Transmission Speed: 2,400 bps to 187,500 bps	
Tool Connector	Asynchronous TTL level nonprocedural command interface During Screen File Development Used for transferring data between GP application software and the GP. Used for data transfer with the 2-Port feature.	
CF Card Interface	1 slot	
External Output I/F	DOUT Output	Open Collector Output: 2 points (F1, F2) Rated Voltage: DC 24V Rated Current: 300mA/point max.
	Operation Output	Open Collector Output: 1 point Rated Voltage: DC 24V Rated Current: 300mA max.
	External Buzzer Output	Open Collector Output 1 point Rated Voltage: DC 24V Rated Current: 300mA max.
	Emergency Switch Output	2 Contacts (NC) Rated Voltage: DC 30V Rated Current: 1A max. (Applicable Load: 1mA DC 5V min.) Open Collector Output: 1 point Rated Voltage: DC 24V Rated Current: 300mA max.
	3-Position Enable Switch Output	2 Contacts (NO)* ¹ Rated Voltage: DC 24V Rated Current: 300mA max. (Applicable Load: 4mA DC 24V min.)

1. When GP-H70 Compatibility mode is selected, 1 Contact (NO).

2.3 Interface Specifications

This section describes the specification of each GP2000H unit interface. The external interface is located on the board, at the rear of the GP unit, where the cable cover is opened.



- **Pin #7 (VCC) DC 5V Output is not protected. Use only the designated level of current.**
- **Use Digital's GP2000H Series connection cable to connect a serial interface.**

2.3.1 External Interfaces

■ Serial Interface

This interface can be either RS-232C or RS-422. Connects the GP unit to the host (PLC).

Pin Assignments	Pin #	Signal Name	Condition
	1	RS	Request to Send (RS-232C)
	2	SD	Send Data (RS-232C)
	3	CS	Clear to Send (RS-232C)
	4	RD	Receive Data (RS-232C)
	5	CD	Carrier Detect (RS-232C)
	6	ER	Enable to Receive (RS-232C)
	7	VCC	DC 5V \pm 5% Output 0.25A
	8	SG	Signal Ground
	9	NC	Not Connected (Reserved)
	10	NC	Not Connected (Reserved)
	11	NC	Not Connected (Reserved)
	12	NC	Not Connected (Reserved)
	13	RDA	Receive Data A (RS-422)
	14	RDB	Receive Data B (RS-422)
	15	SDA	Send Data A (RS-422)
	16	SDB	Send Data B (RS-422)
	17	CSA	Clear to Send A (RS-422)
	18	CSB	Clear to Send B (RS-422)
	19	ERA	Enable to Receive A (RS-422)
	20	ERB	Enable to Receive B (RS-422)



- **Pin #7 (VCC) DC 5V Output is not protected. Use only the designated level of current.**
- **Use Digital's GP2000H Series connection cable to connect a serial interface.**
- **The GP unit's serial port is not isolated. If the unit the GP will be connected to is also not isolated, be sure to connect the SG (#8) terminal. If this is not done, the RS-422 circuit could be damaged.**

Reference *To confirm your PLC unit's connection specifications, refer to the GP-PRO/PBIII for Windows Device / PLC Connection Manual (included in the GP screen creation software).*

Chapter 2 – Specifications

■ DC 24V Interface

This interface is used for DC 24V input.

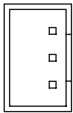
Pin Assignments	Pin #	Signal Name	Condition
 1 2 3	1	DC 24V	Power Input: +24V
	2	0V	Power Input: 0V
	3	FG	Frame Ground



- **Be sure to connect the FG terminal to an earth. Otherwise, the cable may be influenced by noise.**
- **Use Digital's GP2000H Series connection cable to connect a DC 24V Interface.**

External Output Interface

Pin Assignments	Pin #	Signal Name	Condition
	1	NC	Not Connected (Reserved)
	2	DOUT0.C	DOUT0 Output Open Collector DC 24V 300mA
	3	NC	Not Connected (Reserved)
	4	DOUT1.C	DOUT1 Output Open Collector DC 24V 300mA
	5	OP.GND	OP. Ground
	6	OP.C	OP. Output Open Collector DC 24V 300mA
	7	DOUT.GND	DOUT Ground
	8	BUZZ OUT	External Buzzer Output
	9	EMG0B	Emergency Switch 0B (Operates like A Contact)
	10	EMG0A	Emergency Switch 0A (Operates like A Contact) (Open Collector: DC 24V 300mA)
	11	EMG1B	Emergency Switch 1B (B Contact)
	12	EMG1A	Emergency Switch 1A (B Contact) Rated Voltage: DC 30V 1A (Min. applicable load: DC 5V 1mA)
	13	EMG2B	Emergency Switch 2B (B Contact)
	14	EMG2A	Emergency Switch 2A (B Contact) Rated DC30V 1A (Min. applicable load: DC5V 1mA)
	15	ENB0B	3-Position Enable Switch 0B (A Contact)
	16	ENB0A	3-Position Enable Switch 0A (A Contact) Rated Voltage: DC 24V 300mA (Min. applicable load: DC 24V 4mA min.)
	17	ENB1B	3-Position Enable Switch 1B (A Contact)
	18	ENB1A	3-Position Enable Switch 1A (A Contact) Rated Voltage: DC 24V 300mA (Min. applicable load: DC 24V 4mA min.)

Chapter 2 – Specifications



- Pin #7 (DOUT.GND) is used as a common ground with #2 (DOUT0.C), #4 (DOUT1.C), and #8 (BUZZ OUT).
- When the GP unit is set to GP-H70 Compatibility mode, Pin #17 (ENB1B) and Pin #18 (ENB1A) are disabled.
- Use Digital's GP2000H Series connection cable to connect an external output interface.

■ Emergency Switch

When the Emergency Switch is pressed, the external output interface pin energized states are as follows. #9 (EMG0B) and #10 (EMG0A), #11 (EMG1B) and #12 (EMG1A), and #13 (EMG2B) and #14 (EMG2A) .

Pin #	Release	Lock
9-10 (EMG0)	0	1
11-12 (EMG1)	1	0
13-14 (EMG2)	1	0

■ 3-Position Enable Switch

The 3-Position Enable Switch has three positions: a raised position, a mid-level position, and a depressed position.

When the 3-Position Enable Switch is pressed, the external output interface pins' energized states are as follows. #15 (ENB0B) and #16 (ENB0A), and #17 (ENB1B) and #18(ENB1A).

Pin #	Raised	Mid-level	Depressed
15-16 (ENB0)	0	1	0
17-18 (ENB1)	0	1	0



Pin #17 (ENB1B) and Pin #18 (ENB1A) cannot be used when the GP-H70 Compatible mode is selected.

External Output I/F Circuit

- ◆ Pin #2 (DOUT0. C), Pin #4 (DOUT1. C), Pin #7 (DOUT. GND), Pin #8 (BUZZ.OUT) Circuit

SINK Type

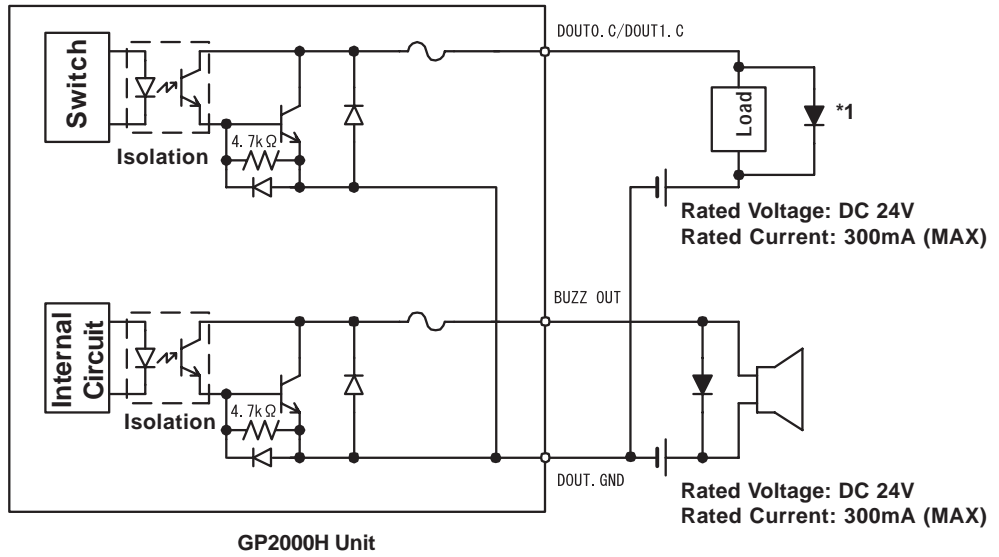

SOURCE Type

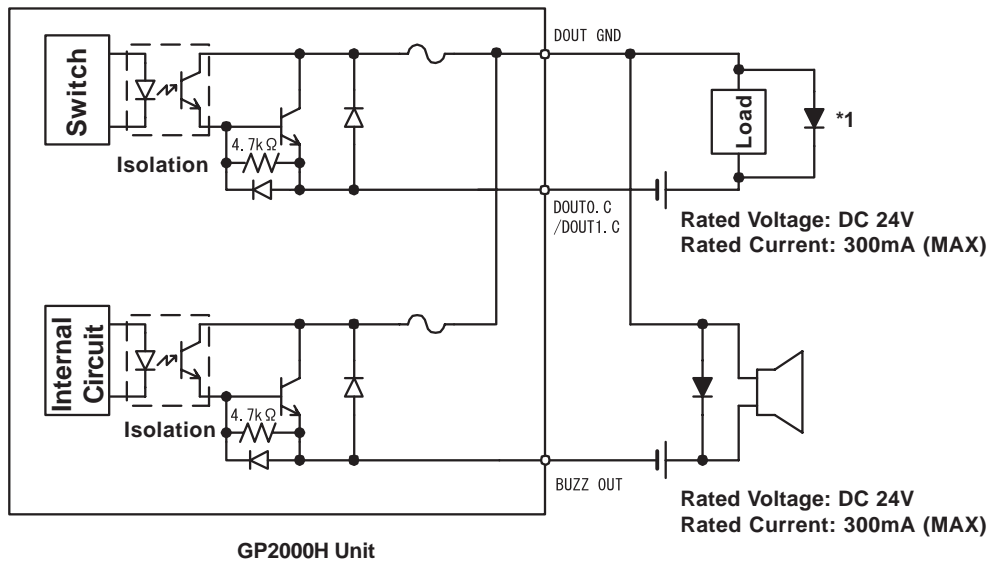

1. When the load changes to induced load, install a surge protector on the load side.

Chapter 2 – Specifications

◆ Pin #5 (OP. GND) and Pin #6 (OP. C) Circuit

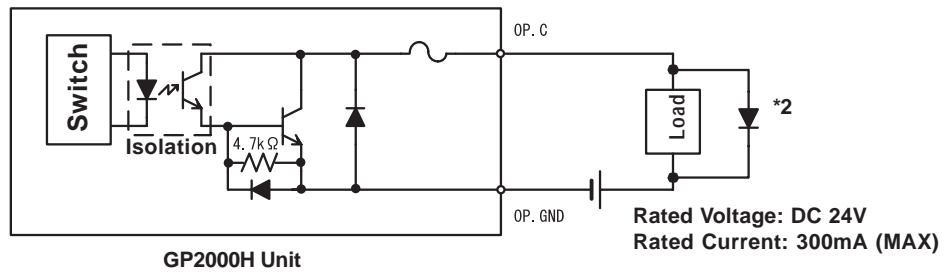

◆ Pin #15 (ENB0B), Pin #16 (ENB0A), Pin #17 (ENB1B), and Pin #18 (ENB1A) Circuit

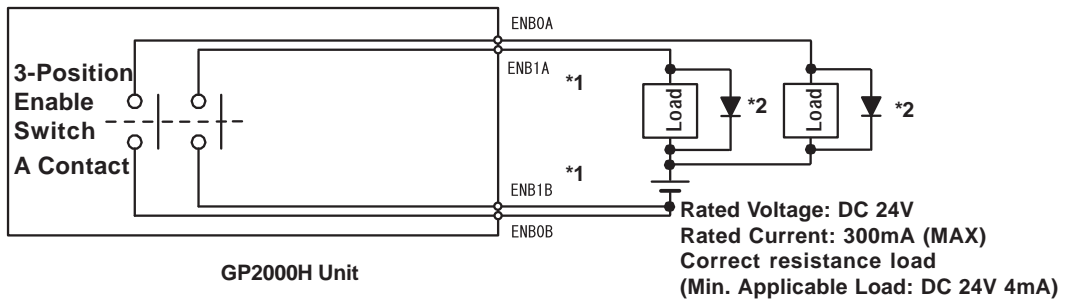

◆ Pin #9 (EMG0B), Pin #10 (EMG0A), Pin #11 (EMG1B), Pin #12 (EMG1A), Pin #13 (EMG2B), and Pin #14 (EMG2A) Circuit

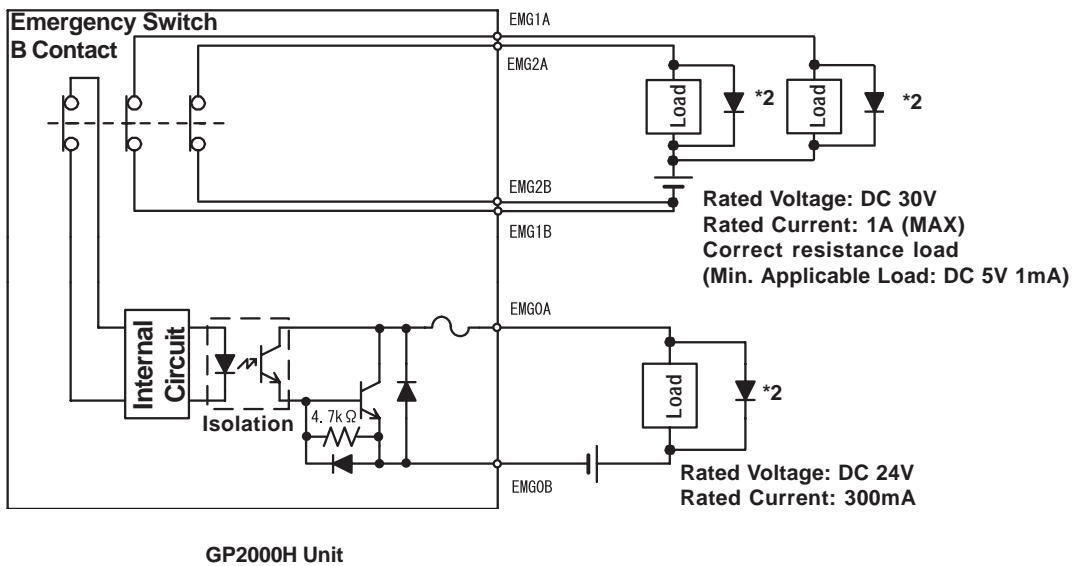

1. When the GP-H70 mode is selected, ENB1A and ENB1B cannot be used.
2. When the load changes to induced load, install a surge protector on the load side.

2.4 Part Names and Functions

This section describes the name and function of each part of the GP unit. (The GP-2401H is used for the Front diagram. This unit's display panel size and number of function switches differ from those of the GP-2401H unit.)

A: Display Panel

Displays user-created screens and corresponding host (PLC) data.

GP-2301HL Monochrome LCD

GP-2301HS STN type color LCD

GP-2401HT TFT type color LCD

B: Touch Panel

Enables the user to perform screen change operations or input data.

C: Status LED

LED	GP Status
Not Lit	Power is OFF
Green	Normal operation
Orange	Backlight is burned out. See 9.3 – Reference <i>"Replacing the Backlight."</i>

D: Operation LED

LED	GP Status
Green	Indicates the Operation Switch or the 3-Point Enable Switch ^{*1} is ON.
Not Lit	If the unit status is different from the above conditions and GP-H70 Compatibility mode is selected, this indicates the Operation and the 3-Position Enable Switch are being operated at the same time.

1. Only when GP-H70 Compatibility Mode is selected.

E: Operation Switch

F: Emergency Switch

G: Emergency Switch Guard Hole Covers

H: Function Switches

GP-2301H: 11 switches

GP-2401H: 15 switches

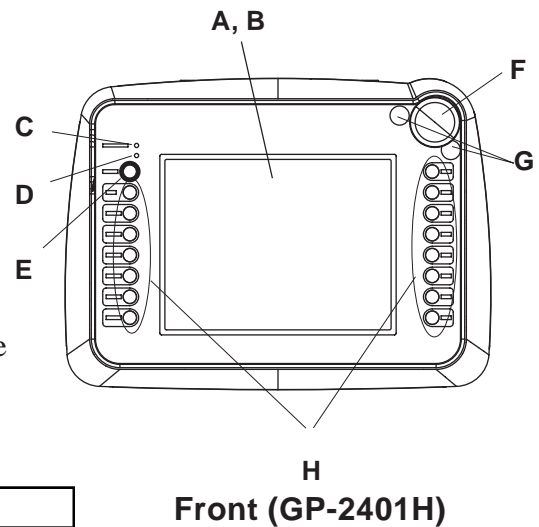

Chapter 2 – Specifications

I: CF Card Access LED

When the CF Card Access Switch is turned ON, the LED lamp turns ON.

When the CF Card Access Switch is turned OFF, the LED lamp turns OFF. However, the lamp is ON while the GP unit is accessing the CF Card.

J: CF Card Cover

K: Cable Cover

L: 3-Position Enable Switch

M: Hand Strap Attachment Slot

N: CF Card Access Switch

The CF Card can be accessed when it is turned ON.

O: CF Card Interface

Insert the CF Card in this slot.

P: CF Card Start Switch

When this is turned ON, the tool program in the CF Card will run when the GP unit is started.

Q: Tool Connector

Connect the data transfer cable here.

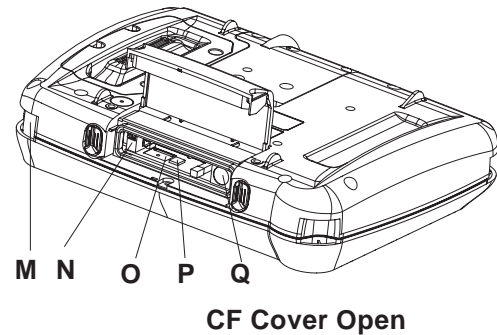
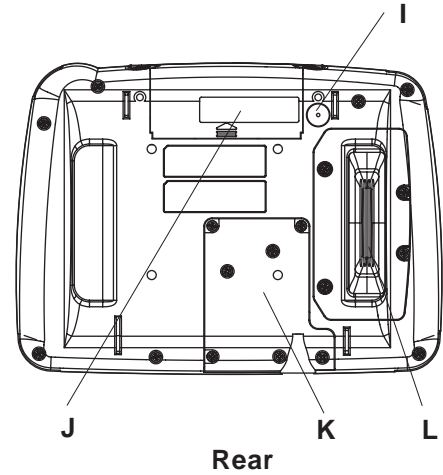

2.5 Dimensions

2.5.1 GP-2301H Series / GP-2401H Series External Dimensions

Even though only the GP2401H-TC41-24V is shown below, the dimensions of the GP2301H-LG41-24V and the GP2301H-SC41-24V are the same.

Unit: mm [in.]

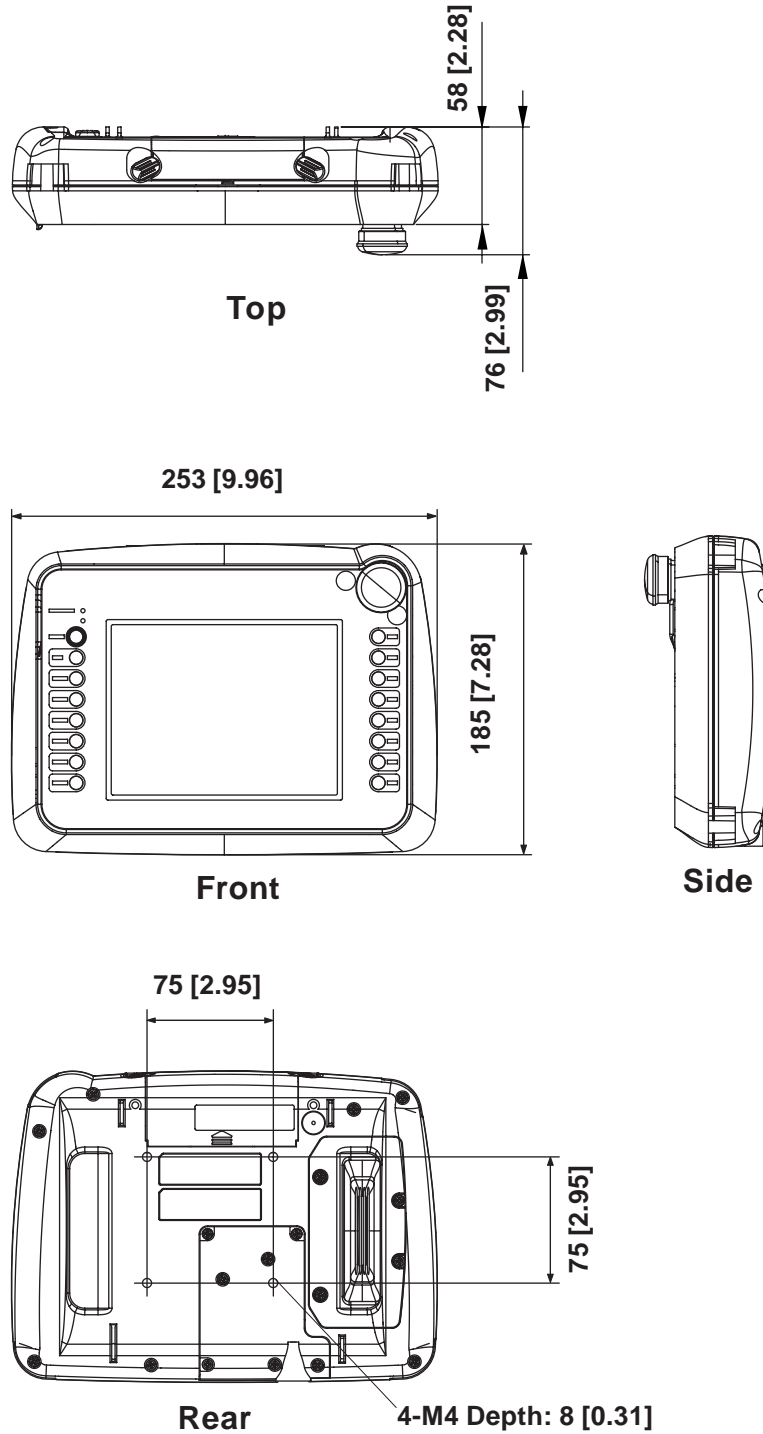

Chapter 2 – Specifications

2.5.2 CF Card Interface Guard

Unit: mm [in.]

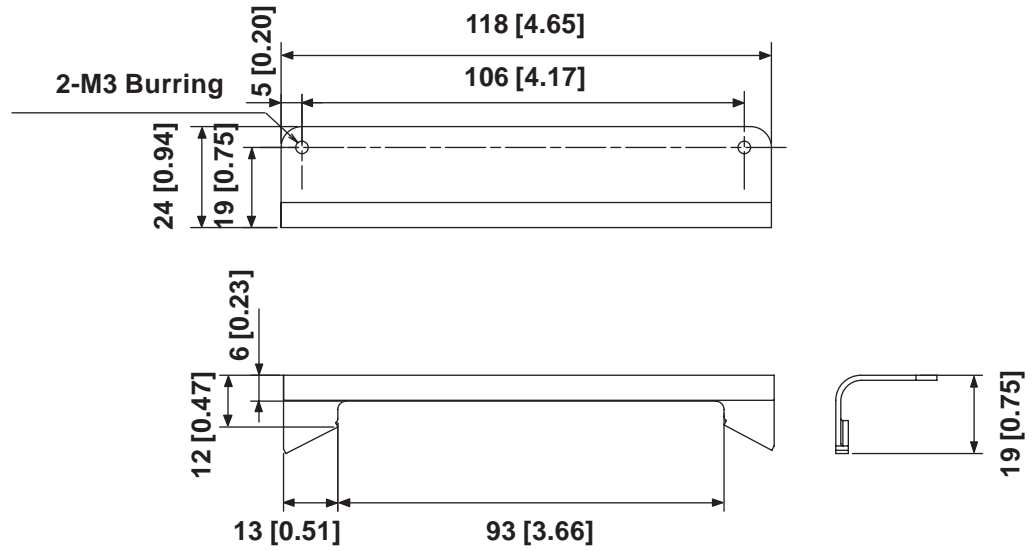

2.5.3 Emergency Switch Guard

Unit: mm [in.]

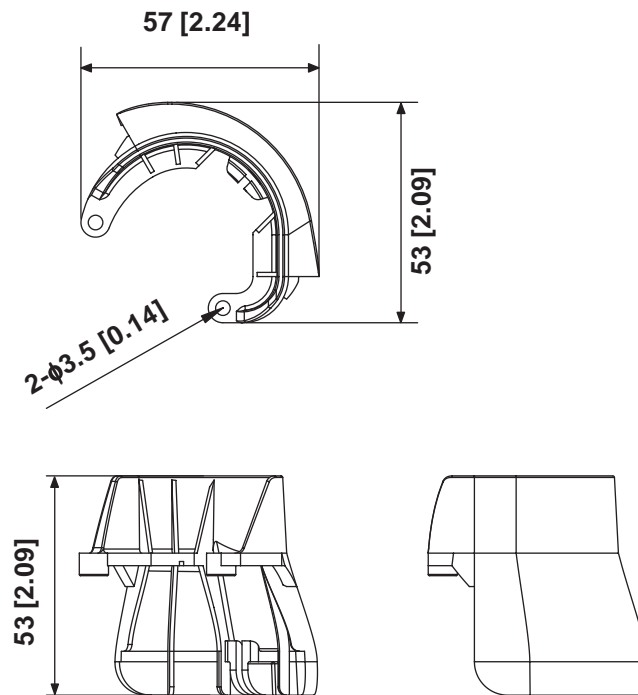

Chapter

3 Handling and Wiring

1. Handling the GP2000H
2. Interface / Switch Guards
3. Wiring

4. Connecting the Tool Connector
5. CF Card Insertion and Removal

3.1 Handling the GP2000H

This section explains cautions involved with handling the GP2000H Series units. Be sure to operate the GP unit only after securing it, using any of the following three methods.



CAUTIONS

Be sure to use the hand strap or neck strap, or attach the GP unit to a wall with the Wall Mount Adapter. Dropping the unit may result in injury to the user or damage to the unit.

3.1.1 Wall Mount Adapter / Swivel Mount Arm

The GP2000H Series unit can be attached to either a Wall Mount Adapter or a commercial arm, as follows:

■ **Attaching the GP2000H to the Wall Mount Adapter**

GP + Wall Mount Adapter (CA1-WMALRG-01)

■ **Attaching the GP2000H to a Swivel Mount Arm or Similar Device**

GP + commercial VESA compliant arm

The GP2000H unit can be attached to either a commercial, VESA FPM PMI-approved (75mm) swivel mount arm, or a similar wall-mount device.



VESA: Video Electronics Standards Association

FPM PMI: Flat Panel Monitor Physical Mounting Interface – physical standard specification (set by VESA) for attaching the liquid crystal display (LCD) to the arm or stand.

Chapter 3 – Attaching and Wiring

3.1.2 Hand Strap

■ Attaching the Hand Strap

The hand strap that attaches to the GP2000H Series unit is used to hold the GP unit by hand, and to prevent it from dropping during use. Attach the hand strap using the following procedure (images of the GP-2301H are used, but the procedure is the same for the GP-2401H):

1. Insert the hand strap into the strap anchors on the sides of the GP unit, and fold back both ends.
2. Adjust the length of the hand strap, and secure the strap with the velcro strip.

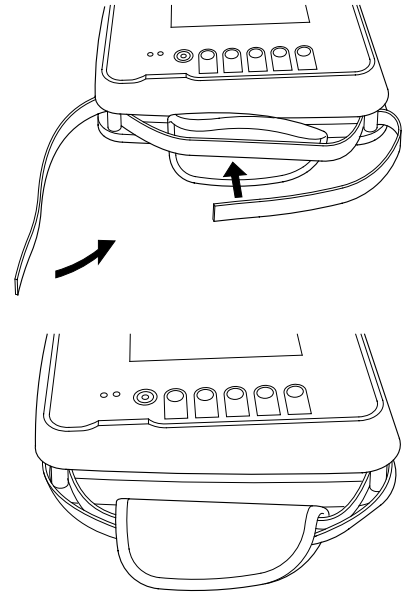

Be sure to keep your left hand through the hand strap when operating the GP unit.

3.1.3 Neck Strap

■ Attaching the Neck Strap

The neck strap that attaches to the GP2000H Series unit is used to hang the GP unit from the user's neck, and to prevent it from dropping during use. Attach the neck strap using the following procedure (images of the GP-2301H are used, but the procedure is the same for the GP-2401H):

1. Insert the neck strap into the strap anchors on the sides of the GP unit.

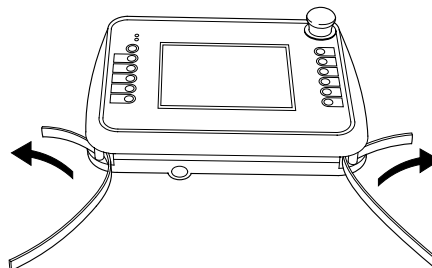

2. Adjust the length of the neck strap and secure the strap with the velcro strip.

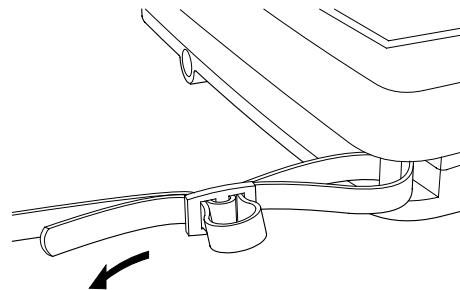

Important

Be sure to keep the neck strap around your neck when operating the GP unit.

3.2 Interface / Switch Guards

This section explains how to install the CF Card Interface Guard and Emergency Switch Guard included in the GP2000H Series unit's packing box.

3.2.1 CF Card Interface Guard

■ Attaching the CF Card Interface Guard

Attach the guard as follows, to meet the NEMA#250 TYPE4X/12*1 environment requirements. (Even if the CF Card Interface Guard is not attached, the protection level of the gasket will not deteriorate as long as the CF Card Cover is closed.)

1. Locate the two CF Card Interface Guard Attachment Screws (2 “Binding type” screws - M3 x 8).



Do not confuse these screws with the Emergency Switch Attachment Screws.

2. Secure the CF Card Cover onto the rear of the GP unit. Position the CF Card Interface Guard with the two screw holes on the side of the CF Card Cover, then insert and tighten the screws. (The screws can be tightened or loosened with a screwdriver or the side of a coin.)

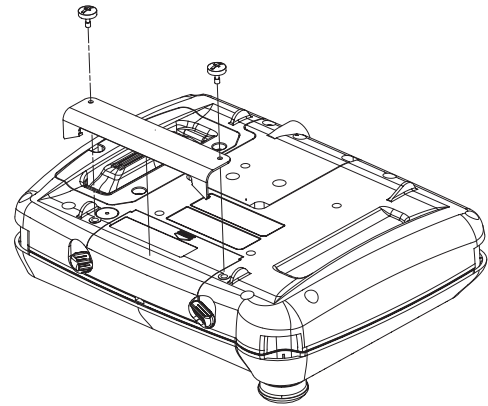

Do not use excessive force, which may damage the GP unit. Use a torque of only 0.5 N•m to tighten the screws.

The GP2000H unit with the CF Card Interface Guard attached will look like the diagram on the right.

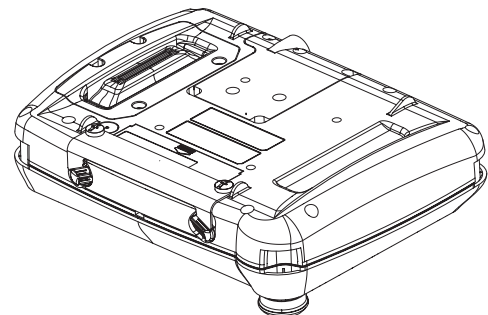

-
1. Units that are Revision A or later correspond to a NEMA#250 TYPE4X/12 rating. For a description of how to identify your unit's revision code, see **Page 16**.
-

3.2.2 Emergency Switch Guard

■ Attaching the Emergency Switch Guard

Prevent the Emergency Switch from accidentally turning ON (for example, if the GP is dropped or placed upside down on a desk) by installing the Emergency Switch Guard, as follows:

1. Locate the two Emergency Switch Attachment Screws (2 “Binding type” screws - M3 x 8).



Note:

Do not confuse these screws with the CF Card Interface Guard Attachment Screws.

2. Peel off the two Emergency Switch Guard hole covers, located next to the Emergency Switch.

3. Align the screw holes of the Emergency Switch Guard with the two Emergency Switch holes.

4. Insert and tighten the attachment screws to attach the Emergency Switch Guard to the GP unit.

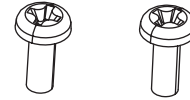

Emergency Switch Guard Hole Covers

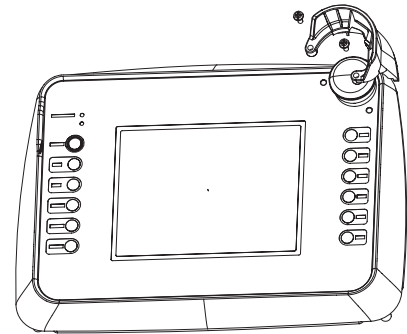
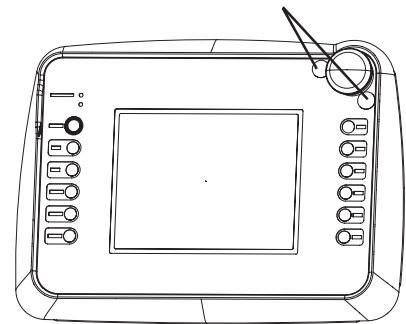

Important

Do NOT use excessive force, which may damage the GP unit. Use a torque of only 0.5 N•m to tighten the screws.

The GP2000H unit with the Emergency Switch Guard attached will look like the diagram on the right.

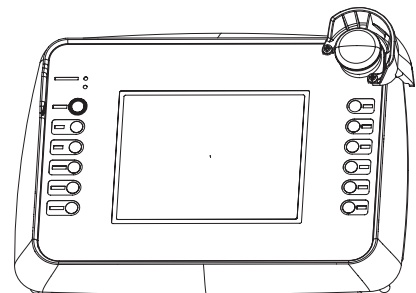

3.3 Wiring

3.3.1 Wiring



WARNINGS

- **To avoid an electric shock, be sure the power cord is unplugged from the power supply when connecting the power terminals to the GP unit.**
- **The GP2000H Series units use a DC 24V power supply. If the power supply is outside of the rated voltage range, both the power supply and the GP unit can be damaged.**
- **The GP2000H is not equipped with a power switch. Therefore, be sure to connect a breaker-type power switch to the GP unit's power cord.**

Use the GP2000H Series connection cable to connect to serial interface, DC 24V interface, external output interface.

The connectable cables (sold separately) are listed below.

Cable Name	Model
GP2000H Series Special Purpose RS-232C Dsub Cable (3M)	GP2000H-D232-3M
GP2000H Series Special Purpose RS-232C Dsub Cable (10M)	GP2000H-D232-10M
GP2000H Series Special Purpose RS-232C Cable (3M)	GP2000H-C232-3M
GP2000H Series Special Purpose RS-232C Cable (10M)	GP2000H-C232-10M
GP2000H Series Special Purpose RS-422 Dsub Cable (3M)	GP2000H-D422-3M
GP2000H Series Special Purpose RS-422 Dsub Cable (10M)	GP2000H-D422-10M
GP2000H Series Special Purpose RS-422 Cable (3M)	GP2000H-C422-3M
GP2000H Series Special Purpose RS-422 Cable (10M)	GP2000H-C422-10M
GP2000H Series Special Purpose GP-H70 Series RS-232C Conversion Adapter Connection Cable (3M)	GP2000H-AP70CB-D232-3M
GP2000H Series Special Purpose GP-H70 Series RS-422 Conversion Adapter Connection Cable (3M)	GP2000H-AP70CB-D422-3M

When the termination resistance needs to be set up, turn ON the dip switch beside the serial interface. The termination resistance of 100Ω enters between RDA and RDB. The default setting is OFF.

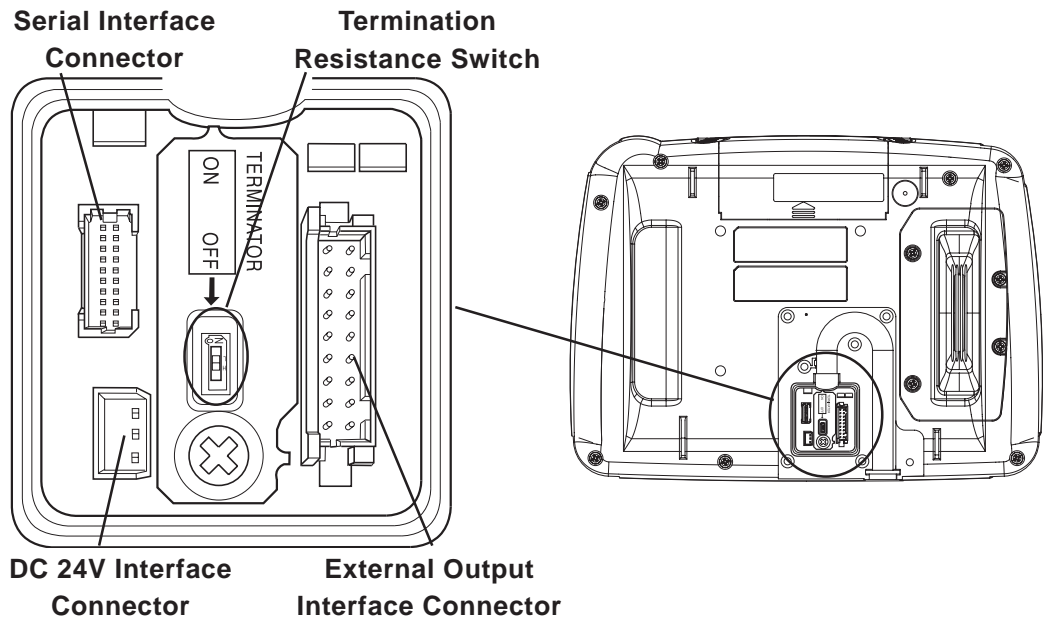

3.3.2 Cable Installation

1. Loosen the seven (7) cable cover attachment screws* on the rear of the GP unit.

* These screws cannot be removed.

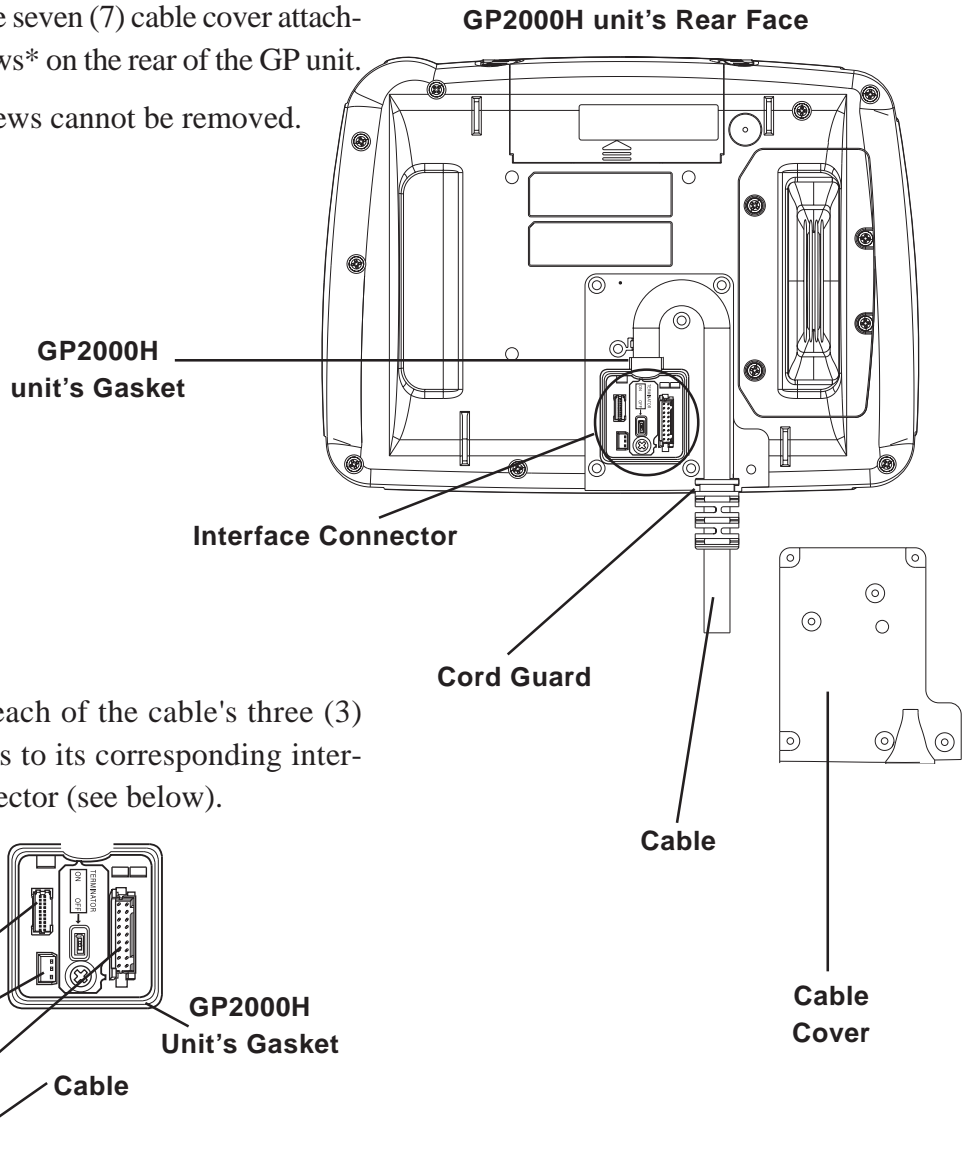

Chapter 3 – Attaching and Wiring

- Securely attach the GP unit's installation gasket.

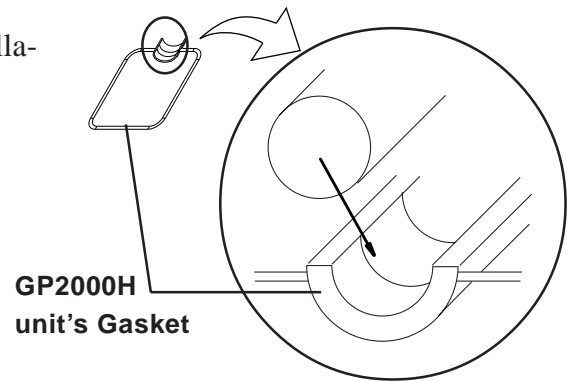

- Bend the cable to fit inside the GP unit's cable channel, and adjust the cord guard to fit securely into the GP unit's plastic casing.
- Replace the cable cover and securely tighten all seven (7) attachment screws. A torque of only 0.5 N•m is sufficient to tighten these screws.

To reattach the cable cover, securely fit the installation gasket around the cable, and fasten the cable cover to the GP unit (see diagram, right).

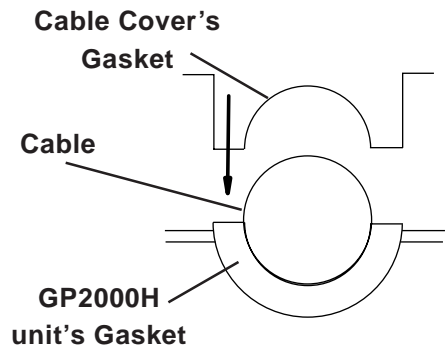

Be sure that the installation gasket and the cable cover are securely fastened. Incorrect alignment of these parts can lead to water leakage and may result in damage of the GP unit.

3.3.3 GP2000H Mode / GP-H70 Compatibility Mode

GP2000H Series units and GP-H70 Series units operate the front-face Operation Switch and the rear 3-Position Enable Switch differently. However, when GP-H70 Compatibility mode is used, the GP2000H Series unit's rear 3-Position Enable Switch operates like a GP-H70 Series unit. Both modes are explained in the following sections.

■ GP2000H Mode

GP-PRO/PBIII for Windows includes, in the GP Setup screen, a setting that enables or disables the Operation Switch. The touch panel's input method depends on whether this switch is set to ON or OFF.

When the Operation Switch setting is set to ON, touch input is available when the front Operation Switch is pressed — but is NOT available when the rear 3-Position Enable Switch is pressed. The factory setting is GP2000H mode.

Reference *For information about GP-PRO/PBIII setup, refer to the GP-PRO/PBIII for Windows Operation Manual, 2.9 – “Handy Type GP Screen Creation.”*

Operation Switch Setting	Front Operation Switch is not Pressed	Front Operation Switch is Pressed	Rear 3-Position Enable Switch* ¹ is in the Mid-level Position* ²	Front Operation Switch and the Rear 3-Position Enable Switch* ¹ are Pressed
Enabled	Touch Input Not Available	Touch Input Available	Touch Input Not Available	Touch Input Available
Disabled	Touch Input Available	Touch Input Available	Touch Input Available	Touch Input Available

1. The rear 3-Position Enable Switch includes three positions: a mid-level position, a depressed position, and a raised position.
2. The rear 3-Position Enable Switch's position and the front Operation Enable Switch settings are NOT related. Only the front face Operation Switch will function.

■ GP-H70 Compatibility Mode

GP-PRO/PBIII for Windows includes, in the GP Setup screen, a setting that enables or disables the Operation Switch. The touch panel's input method depends on whether this switch is set to ON or OFF.

When the Operation Switch setting is set to ON, touch input is available when either the front Operation Switch or the rear 3-Position Enable Switch is pressed.

Reference *For information about the GP-PRO/PBIII setup, refer to the GP-PRO/PBIII for Windows Operation Manual, 2.9 – “Handy Type GP Screen Creation.”*

Operation Switch Setting	Front Operation Switch is not Pressed	Front Operation Switch is Pressed	Rear 3-Position Enable Switch* ¹ is in the Mid-level Position* ²	Front Operation Switch and the Rear 3-Position Enable Switch* ¹ are Pressed
Enabled	Touch Input Not Available	Touch Input Available	Touch Input Available	Touch Input Not Available
Disabled	Touch Input Available	Touch Input Available	Touch Input Available	Touch Input Available

1. The rear 3-Position Enable Switch includes three positions: a mid-level position, a depressed position, and a raised position.
2. The rear 3-Position Enable Switch's position and the front Operation Enable Switch settings are NOT related. Only the front-face Operation Switch will function.

Chapter 3 – Attaching and Wiring

■ Changing to GP-H70 Compatibility Mode



WARNING

- To prevent an electrical shock, be sure to unplug the GP unit's power cord from the main power supply prior to attaching or detaching any connectors to or from the GP unit.
- Be sure to attach the cable to the correct mode connector position. The 3-Position Enable Switch will not function if the connector is attached to the wrong position.

1. Loosen the four (4) 3-Position Enable Switch Cover screws* on the rear of the GP unit.

* These are non-removable type screws.

* To preserve this unit's airtight seal an installation gasket is used. To release the cover from the gasket, use a flat-bladed screwdriver or similar tool and insert the blade between the cover and the gasket to free the cover.

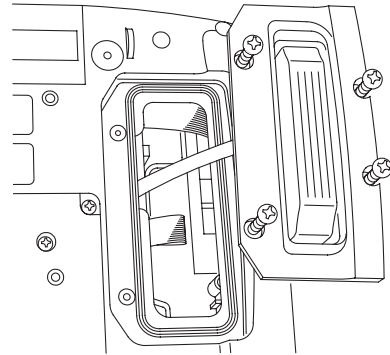

To prevent scratching the unit's case, wrap the driver's blade with cloth.

2. Remove the cable from the GP2000H Mode Connector (default setting).

GP-H70 Compatibility
Mode Connector
GP2000H
Mode Connector

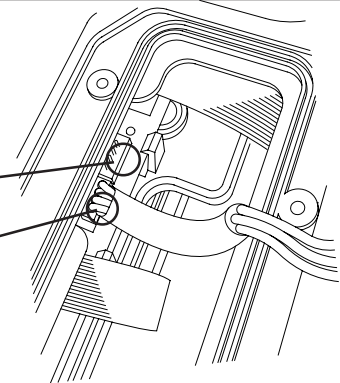

3. Attach the removed cable to the GP-H70 Compatibility Mode Connector.
4. Attach the 3-Position Enable Switch cover to the rear of the GP unit with the attachment screws. A torque of only 0.5 N•m is sufficient to tighten these screws.

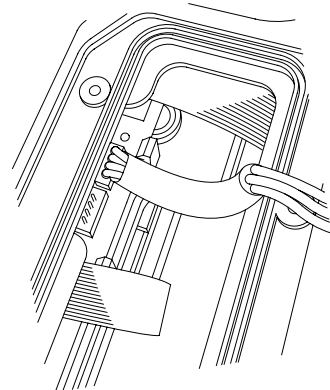



Be sure that the 3-Position Enable Switch cover is securely fastened. Incorrect attachment of this cover can lead to water leakage and may result in damage of the GP unit.

3.3.4 Switching DOUT/BUZZ Output Current Direction

GP2000H Series units can switch the direction of the DOUT/BUZZ output current. As shown below, each direction corresponds to either Sink output or Source output. The factory setting is for Sink type output.

GP 2000H Series units that can switch the current direction includes all units with Revision 2 marking (2A, 2B, 2C, etc.). For a description of how to identify your unit's revision code, see *Preface - Page 16*.

For Circuit drawings for the Output Sink type and Output Source type units,

Reference *2.3 Interfaces ■External Output I/F Circuit*

Output Sink Type

Provides current from pin 2 (DOUT0.C)/ pin 4 (DOUT1.C)/ and pin 8 (BUZZ OUT) to pin 7 (DOUT.GND)

Pin No.	Signal Name	GP Internal Current Direction	Pin No.	Signal Name
2	DOUT0.C		7	DOUT.GND
4	DOUT1.C			
8	BUZZ OUT			

Output Source Type

Provides current from pin 7 (DOUT.GND) to pin 2 (DOUT0.C)/ pin 4 (DOUT1.C)/ and pin 8 (BUZZ OUT)

Pin No.	Signal Name	GP Internal Current Direction	Pin No.	Signal Name
2	DOUT0.C		7	DOUT.GND
4	DOUT1.C			
8	BUZZ OUT			

Chapter 3 – Attaching and Wiring

■ Changing the Current Direction

- 1) Loosen the seven (7) Cable Cover Attachment Screws, and remove the cover.
- * These screws are the non-removable type.

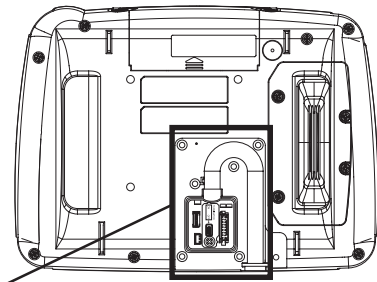

Cable Cover

- 2) Loosen the Stopper's screw (1) and remove the Stopper.
- *This screw is the non-removable type.

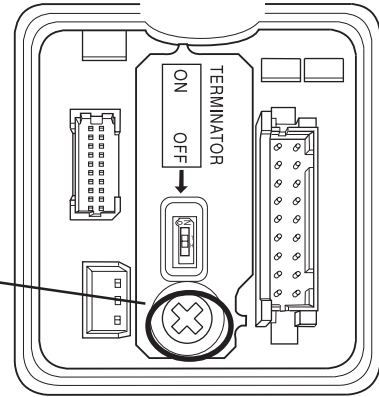

Stopper Screw

Sink/Source Circuit Board

- 3) Remove the Output Sink/Source Switchover Circuit Board. Grasp the sponge section and pull the board directly up off the GP's circuit board.

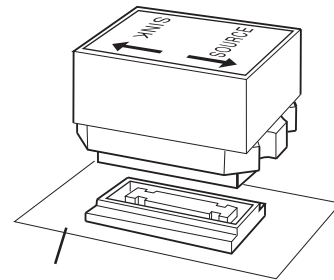

GP Circuit Board

Output Sink/Source Circuit Board

Front

Rear

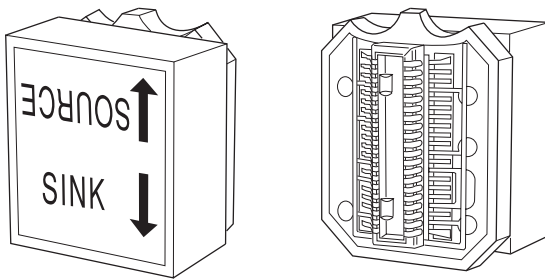

Output Sink Setting

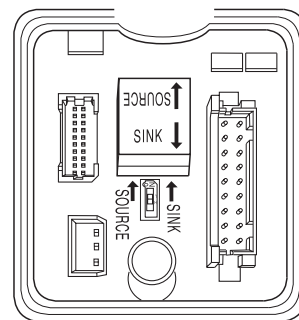

Output Source Setting

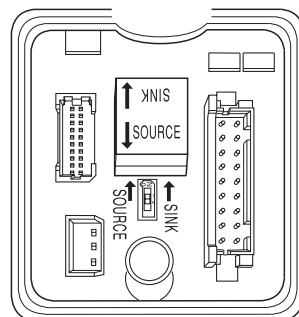

- 4) As shown in the drawings on the right, the direction of the Output Sink/Source unit determines the direction of the current.
- * You can use the words “SINK” and “SOURCE” on the main circuit board to orient/ check the Output Sink/Source unit.
- 5) Re-attach the Stopper and re-attach the Cable Cover.

3.4 Tool Connector

A data transfer cable can be attached to the GP unit's tool connector. The GP unit's tool connector is located on the right side, inside the CF Card Cover.



WARNING

To prevent an electrical shock, be sure to unplug the GP unit's power cord from the main power supply prior to attaching or detaching any connectors to or from the GP unit.

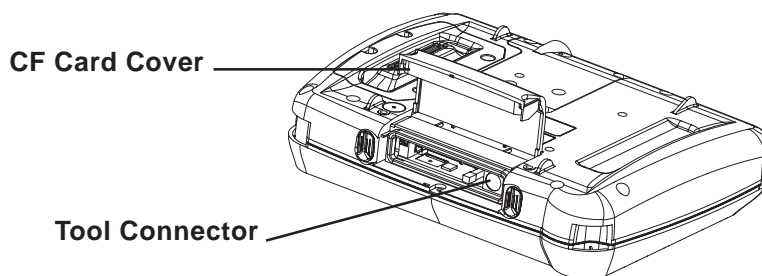

3.5 CF Card Installation and Removal



CAUTIONS

When using the GP2000H unit and a CF Card, use the following precautions:

- Prior to inserting or removing a CF Card, turn the GP unit's CF Card Access Switch OFF, and confirm that the Access lamp is not lit, to prevent damage to or loss of the CF Card's internal data.
- When a CF Card is being accessed, NEVER:
 - turn OFF or reset the GP2000H unit
 - insert or remove the CF Card

Prior to performing these operations, create and use a special GP application screen that will prevent access to the CF Card.

Reference Refer to the GP-PRO/PBIII for Windows Tag Reference Manual (included with the screen creation software package).

- Prior to inserting a CF Card, familiarize yourself with the CF Card's front-face and rear-face orientation, as well as with the CF Card connector's position. To prevent damage to either the CF Card's internal data or the GP unit, the CF Card must be correctly positioned when it is inserted into the multi-unit.
- Use only CF Cards manufactured by Digital Electronics Corporation. Otherwise, the CF Card data may be damaged.
- Lost GP data cannot be recovered. Since accidental data loss can occur at any time, be sure to back up all GP screen and CF Card data regularly.
- Be sure to follow the instructions given below to prevent the CF Card's internal data from being destroyed or a CF Card malfunction from occurring:
 - Do NOT bend the CF Card.
 - Do NOT drop or strike the CF Card against other objects.
 - Keep the CF Card dry.
 - Do NOT touch the CF Card connectors.
 - Do NOT disassemble or modify the CF Card.

■ Inserting the CF Card

Use the following steps to insert the CF Card in the GP2000H unit.

1. Unlock the CF Card Cover Lock on both sides, and then slide the CF Card Cover in the specified direction, and upwards, to open the cover.
2. Turn OFF the CF Card Access Switch and make sure the CF Card Access LED is turned OFF.
3. Insert the CF Card in the CF Card Slot, until the ejector button is pushed forward.
4. Turn ON the CF Card Access Switch.

Reference See 3.5.2 – “CF Card Access Switch.”

5. Confirm that the CF Card Access LED turns ON.
6. Close the CF Card Cover in the direction opposite to that of the opening procedure.

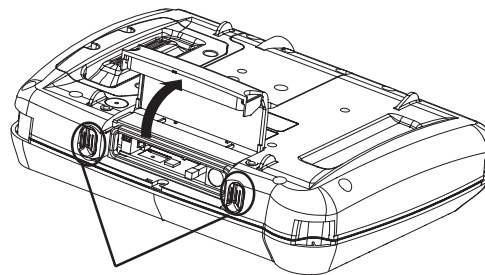

CF Card Cover Lock

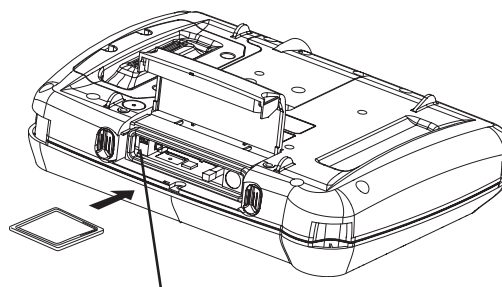

CF Card Access Switch

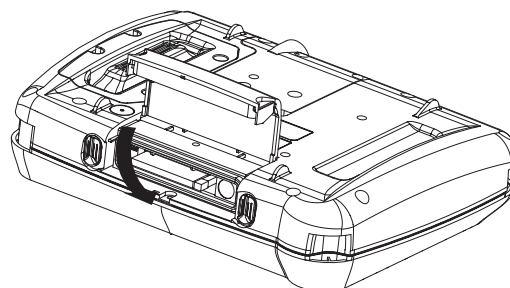

■ Removing the CF Card

To remove the CF Card, retrace the previous “Inserting the CF Card” steps.

1. Open the CF Card Cover.
2. Turn OFF the CF Card Access Switch, and make sure that the CF Card Access LED is turned OFF.
3. Press the ejector button to remove the CF Card.

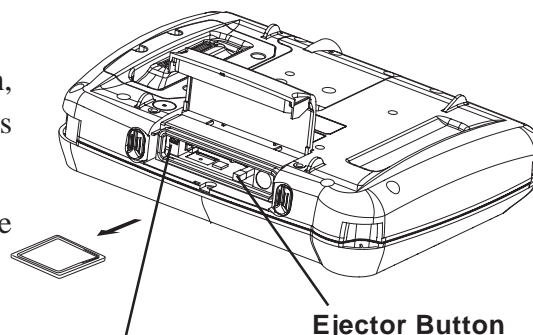

CF Card Access Switch

Ejector Button

Chapter 3 – Attaching and Wiring

3.5.1 CF Card Handling

The CF Card has a data overwrite limit of approximately 100,000 times. Therefore, be sure to back up all CF Card data regularly to another storage media. (100,000 times assumes the overwriting of 500KB of data in DOS format.)

To view CF Card data on a personal computer, insert the CF Card into a CF Card Adapter, and then insert the adapter into your personal computer's PC card slot. In some cases, and depending on the model of personal computer you are using, the CF Card's data may not be read correctly.

Reference Contact your local GP distributor for a list of the latest CF Card and personal computer operation test results.

If your personal computer is not equipped with a PC card slot, please use a standard type PC Card or CF Card reader.

3.5.2 CF Card Access Switch

The CF Card Access Switch is a switch that the GP unit can use to access the CF Card. Because the factory setting is OFF, the GP unit cannot access the CF Card simply by inserting the CF Card.

When using the CF Card, set the CF Card Access Switch 1 to ON.



Prior to inserting or removing a CF Card, turn the GP unit's CF Card Access Switch OFF, then confirm that the Access lamp is not lit, to prevent damage to or loss of the CF Card's internal data.

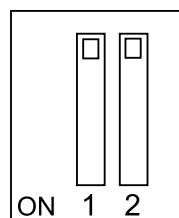

**CF Card Access Switch
(Default Settings)**

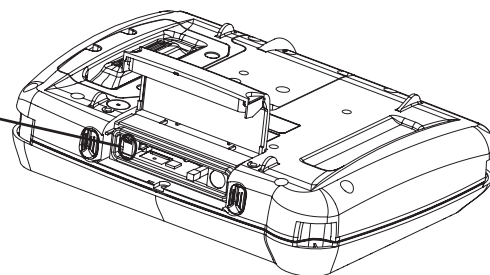

Dip Switch	1	2
Description	CF Card Access Setting	Reserved (Fixed to OFF)
OFF	CF Card Access Prohibited	-
ON	CF Card Access Permitted	-

Chapter 4 Data Transfer

1. Serial Data Transfer
2. CF Memory Loader Tool

This chapter explains how to transfer data created with the GP screen creation software using one of the following two methods:

- Transfer data between the GP and your PC via the data transfer cable.
- Transfer data between the GP and your PC with the CF Card, using the CF Memory Loader Tool.

4.1 Serial Data Transfer

The following diagram illustrates the data transfer cable connection between your PC and the GP unit.

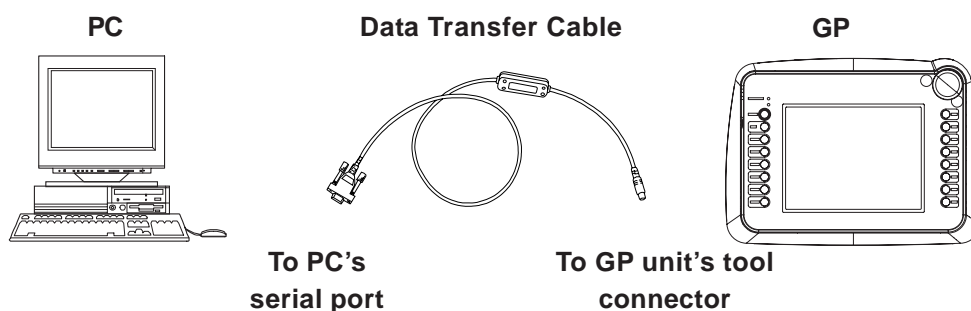

Note:

- Pro-face's data transfer cable (GPW-CB02) is sold separately.
- When using the PC with the Dsub 25-pin socket (female) interface, a connector conversion adapter is required. Use the straight-line type of conversion adapter.

Recommended Adapters:

Arvel AA833
SANWA SUPPLY INC. D09-9F25F

- When using a PC equipped with a half-pitch, 14-pin socket interface, a conversion adapter is required.

Recommended Adapter:

LOAS Co. Ltd. ZR01-024

Transfer screen data from your PC via the GP screen creation software.

Reference For details about the GP screen creation software, refer to the GP-PRO/PBIII for Windows Operation Manual (included in the GP screen creation software).

Chapter 4 – Data Transfer

Transfer the logic program data from your PC via the Logic Program Development software.

Reference For details about the Logic Program Development software, refer to the Pro-Control Editor Operation Manual (included in the GP screen creation software).

■ Transferring Data to a New GP2000H Unit

Connect the GP to your PC via the data transfer cable, and then turn the GP unit ON. The Initial Start Mode screen appears on the GP, and you can transfer logic program data from your PC to the GP. The screen will change to the Transfer screen.

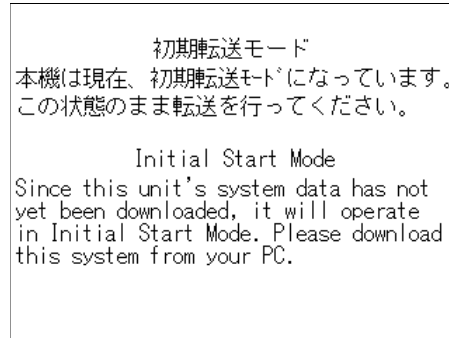

■ Completing Data Transfer Using GP Setup*1

When transferring screen data from the GP screen creation software, the screen automatically switches to SCREEN DATA TRANSFER. If the screen does not switch to SCREEN DATA TRANSFER, select the SCREEN DATA TRANSFER mode.

Reference See 5.1 – “Entering OFFLINE Mode.”

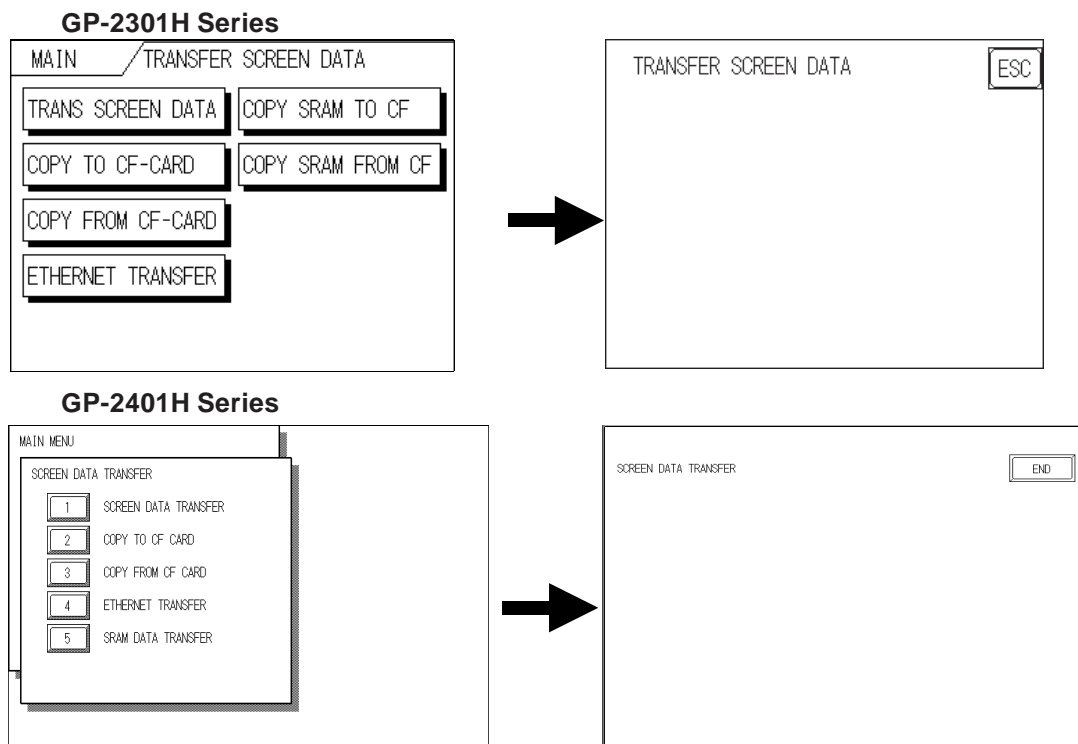

1. To “Set up the GP” means to download both the system program and the user-specified protocol program, from the GP screen creation software to the GP unit.

During data transfer, the SET UP TRANSFER and NOW TRANSFERRING – PLEASE WAIT messages appear. When these messages disappear, the screen data transfer is completed.

You can cancel data transfer at any time using the GP screen creation software.

When the screen data transfer is completed, and if you do not need to set up the GP unit, the screen designated in the INITIAL SCREEN FILE NO. setting of the INITIALIZE menu's SET UP SCREEN will appear, and the GP screen will change to operation (RUN) mode.



Interrupting the screen data transfer can lead to a GP startup error.

During screen data transfer, do NOT:

- **disconnect the GP unit's power supply**
 - **turn off the PC**
 - **disconnect the GP unit's transfer cable**
-



If the GP screen creation software's GP SYSTEM SETTINGS data is transferred to the GP, the OFFLINE Mode's INITIAL SETTINGS data will be overwritten.

4.2 CF Memory Loader Tool

The GP unit allows you to transfer screen data between your PC and the GP, and to upload internal GP data to its CF Card using the CF Memory Loader Tool.

When using a CF Card, be sure to turn ON the CF Card Access Switch No. 1.

Reference See 3.5.2 – “CF Card Access Switch.”



Note:

- You need to transfer the CF Memory Loader Tool to the CF Card prior to using the CF Memory Loader Tool.

Reference Refer to the GP-PRO/PBIII for Windows Operation Manual (included in the GP screen creation software).

- The CF Memory Loader Tool and Backup Data combination usually requires at least 7MB of CF Card memory for the GP-2401H Series unit, and at least 5MB of CF Card memory for the GP-2301H Series unit.

■ Starting the CF Memory Loader Tool

Both methods for starting the CF Memory Loader Tool program via the CF Card are described below.

◆ Menu Bar – Using the GP2000H Unit’s CF BOOT Menu

Insert the CF Card with the saved CF Memory Loader Tool into the GP unit, and turn ON the CF Card Access Switch No. 1.

Reference See 3.5.2 – “CF Card Access Switch.”

Touch the OFFLINE menu screen’s CF BOOT selection. The GP will be reset, and after it restarts, the CF Card’s CF Memory Loader Tool will start.

Reference For information about displaying the menu bar; see 6.4.3 – “SET UP I/O (GP2301H)” or 7.4.3 – “SET UP TOUCH PANEL (GP2401H).”

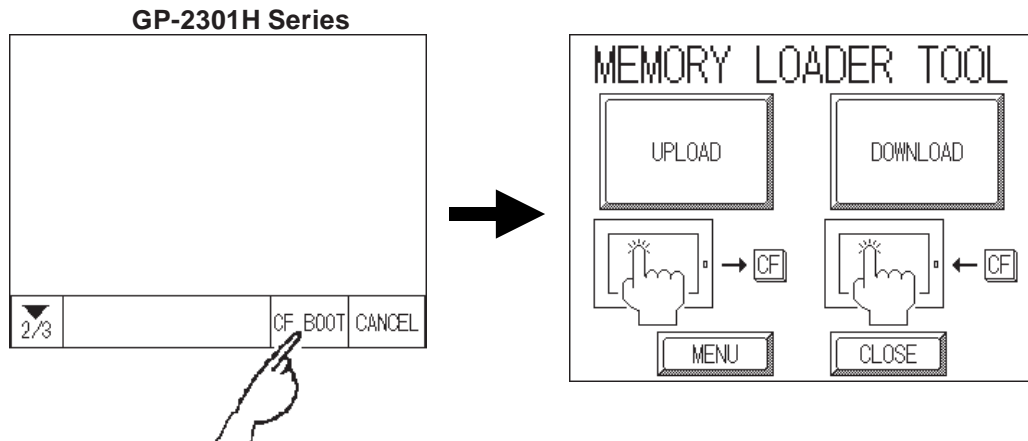

◆ Using the GP2000H Unit's CF Card Startup Switches

You can also use the CF Card Startup Switches on the bottom of the CF Card Slot. Turn ON (raise) Switch No. 1, and insert the CF Card with the saved CF Memory Loader Tool into the GP's CF Card slot. Next, turn ON CF Card Access Switch No. 1, and connect the GP unit's power cord. The CF Memory Loader Tool will then start up.

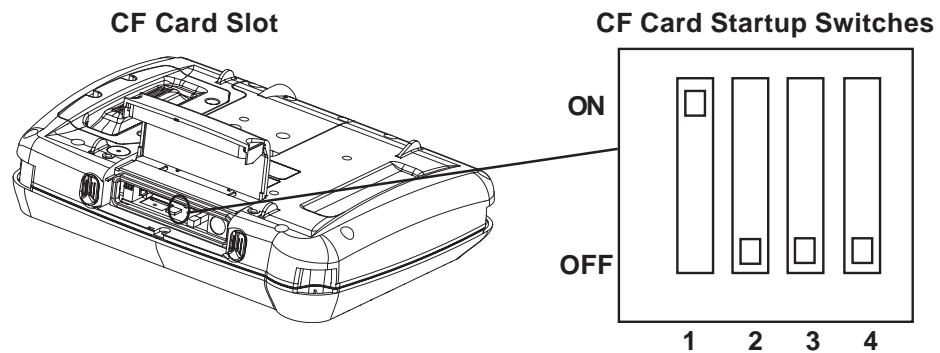

Note:

When you finish using the CF Memory Loader Tool, turn OFF (lower) CF Card Startup Switch #1.

4.2.1 Data Upload and Download

When the CF Memory Loader Tool program starts, the following screen will appear.

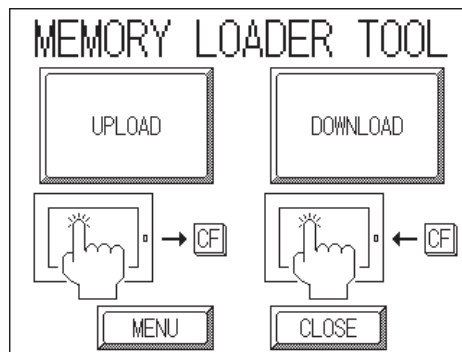

Chapter 4 – Data Transfer

■ UPLOAD (from GP2000H to CF Card)

This feature saves all GP internal data (such as system program, communication protocol, expansion program, screen data, and Backup SRAM data) in the CF Card as backup data.

To start data upload, enter the password you designated in the screen creation software's Transfer screen, and then touch the START key. If you have not designated a password, touch the START key.

Reference See 6.3.1 / 7.3.1 – “SYSTEM SETUP (Password Setup),” and 5.3 – “INITIALIZATION.”



When UPLOAD is performed, the CF Card's current Backup Data will be completely overwritten.

GP-2301H Series Unit

GP-2401H Series Unit

■ DOWNLOAD (from CF Card to GP)

This feature writes CF Card backup data to the GP unit's Internal SRAM Memory.

To start data download, enter the password you designated in the screen creation software's Transfer screen, and touch the START key. If you have not designated a password, touch the START key.



When DOWNLOAD is performed, the GP unit's Internal Memory data (such as system program, communication protocol, expansion program, screen data and Backup SRAM data) will be completely overwritten.

GP-2301H Series Unit

GP-2401H Series Unit

Chapter

5 OFFLINE Mode

1. Entering OFFLINE Mode
2. OFFLINE Mode Main Menu
3. INITIALIZATION
4. SELF-DIAGNOSIS

OFFLINE Mode provides access to the GP unit's INITIALIZE menu, SELF-DIAGNOSIS menu, and other GP features. You will need to change the GP to OFFLINE Mode before you can use any of these features.

In addition, and for the reader's convenience, this chapter uses the GP-2301H Series unit in its explanations of the OFFLINE Mode. There is no difference in functionality with GP-2401H Series unit, unless otherwise noted.



OFFLINE Mode is not available in a new GP until the necessary system data has been transferred from the GP screen creation software on your PC. To transfer system data, the GP unit's power cord must be plugged in.

Reference *For information about transferring data to the GP, see **Chapter 4 – “Data Transfer,”** or refer to the GP-PRO/PBIII for Windows Operation Manual (included in the GP screen creation software).*

5.1 Entering OFFLINE Mode

To initialize your GP unit, or to perform SELF-DIAGNOSIS, you must first switch the GP unit to OFFLINE Mode. This can be done using either of the following two (2) methods.

5.1.1 After Plugging in the Power Cord

To enter OFFLINE Mode, touch the top-left corner of the screen within 10 seconds after connecting the GP unit's power cord.

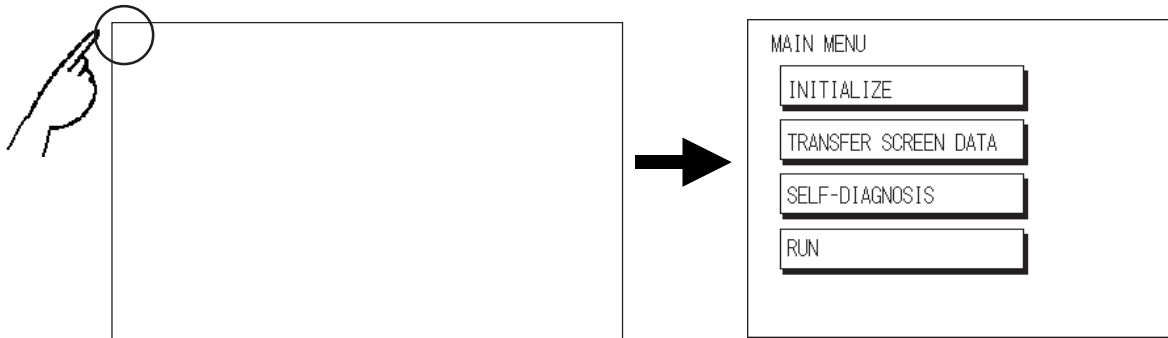

5.1.2 From the Menu Bar

From the GP unit's menu bar, touch OFFLINE, and the MAIN MENU screen appears.

Reference To call up the menu bar, see 6.4.3 – “SET UP I/O (GP2301H)” or 7.4.3 – “SET UP TOUCH PANEL (GP2401H).”

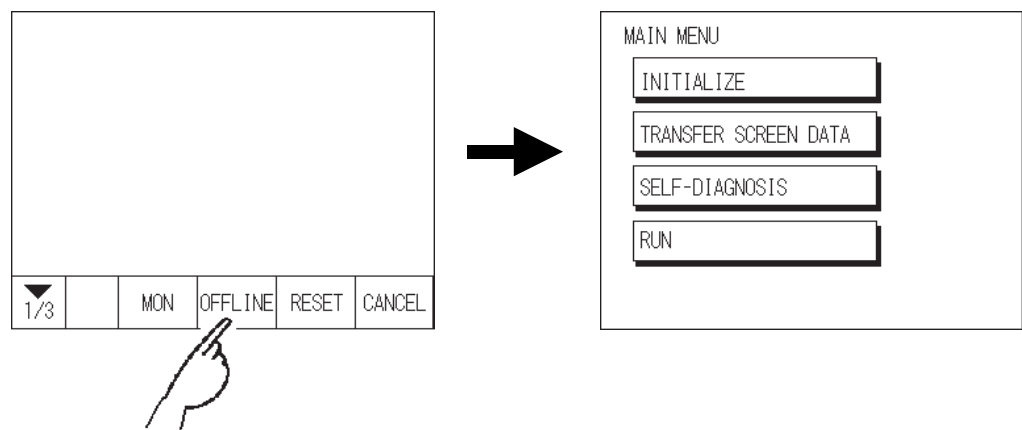

Note: If your GP unit includes the Device Monitor feature, the MONITOR button will be included on the menu bar.

Reference Refer to the GP-PRO/PBIII for Windows Device / PLC Connection Manual (included in the GP screen creation software).

Chapter 5 – OFFLINE Mode

If a password is set in the INITIALIZE menu's SYSTEM SETUP screen, the following screen appears before entering OFFLINE Mode. Enter the password, and then touch SET to enter OFFLINE Mode.

Enter the default password, **1101**, or the password specified in the system setup.

▼Reference▲ For information about entering password numbers, see 5.3 – “INITIALIZATION.”

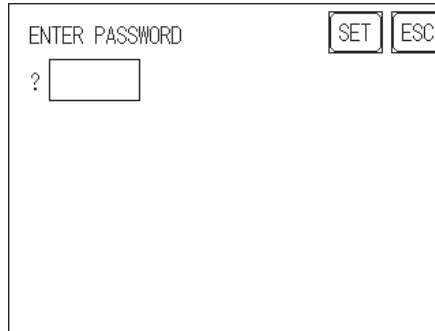

The screenshot shows a rectangular window with a white background. At the top left, the text "ENTER PASSWORD" is displayed. Below this text is a small rectangular input field with a question mark "?" to its left. In the top right corner of the window, there are two small rectangular buttons labeled "SET" and "ESC".

5.2 OFFLINE Mode Main Menu

The OFFLINE Mode's MAIN MENU screen contains the following menu items: INITIALIZE, TRANSFER SCREEN DATA, SELF-DIAGNOSIS, and RUN.

The settings for each of the following menu items must match the corresponding PLC for the GP to communicate properly.

Entering OFFLINE Mode calls up the following screen.

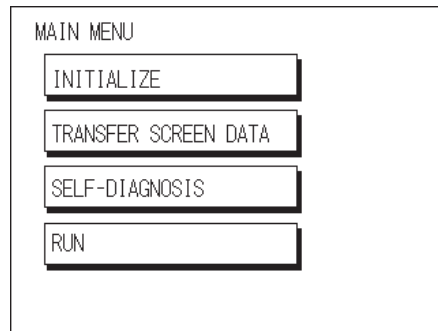

Select the desired option by touching the corresponding menu item.

Each MAIN MENU item is used as follows:

INITIALIZE

Setup items control the GP unit.

▼Reference▲ For more information about initialization, see **Chapter 6 / 7 – “Initializing the (GP-2301H / GP-2401H).”**

TRANSFER SCREEN DATA

Transfers screen data between the screen creation software and the GP unit.

▼Reference▲ For more information about TRANSFER SCREEN DATA, see **Chapter 4 – “Data Transfer”** or refer to the GP-PRO/PBIII for Windows Operation Manual (included in the GP screen creation software).

SELF-DIAGNOSIS

Runs a check for any problems with the GP System or Interface.

RUN

Starts GP operation.

▼Reference▲ For more information about the SELF-DIAGNOSIS and RUN features, see **Chapter 8 – “RUN Mode and Errors.”**

5.3 INITIALIZATION

■ Selecting a Menu

Touch the menu item or input field to select.

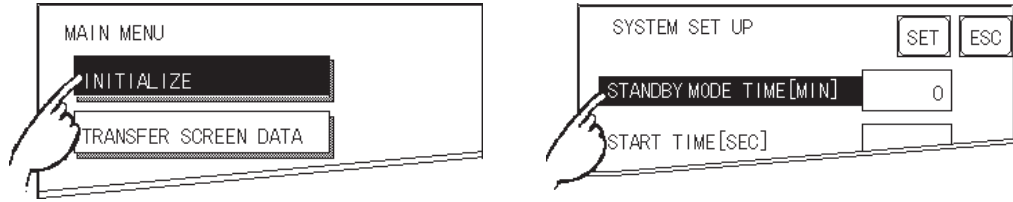

■ Entering Numbers

After selecting an input field, touch the numeric touch keys located at the bottom of the screen to enter the value of the selected item. After entering each input field's numeric value, touch the SET key to register the value.

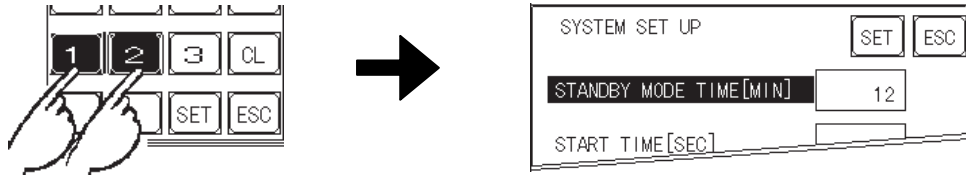

■ Selecting Setup Conditions

After selecting a menu item, touch the setting option to highlight the item, then touch the setting area to set the condition for that item.

In this example, touching the ON/OFF area toggles the TOUCH BUZZER SOUND setting, which is set to OFF, and then switched to ON.

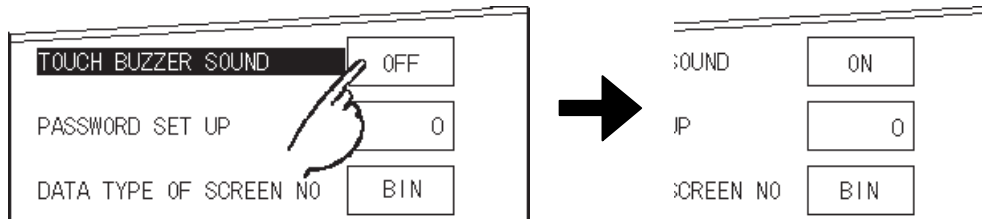

Chapter 5 – OFFLINE Mode

■ After Entering All Setting Data

Touch the SET key to write the setup data to the Internal FEPRM.

Touch CANCEL to cancel the setup, exit the screen without saving the changes, and return to the previous menu.



- Press the SET key to write the Setup conditions onto the Internal FEPRM.
- Since the Setup conditions are written onto the Internal FEPRM by pressing the SET key, it may take some time to return to the previous menu. Until it returns to the previous menu, do not touch the screen.
- Press the CANCEL key to cancel the writing of the Setup conditions onto the Internal FEPRM, and return to the previous menu.

■ Returning to a Previous Screen

Touch the tab to call up the desired menu.

For example, to return to the MAIN MENU from the SYS. ENVIRONMENT screen, touch the MAIN MENU tab.

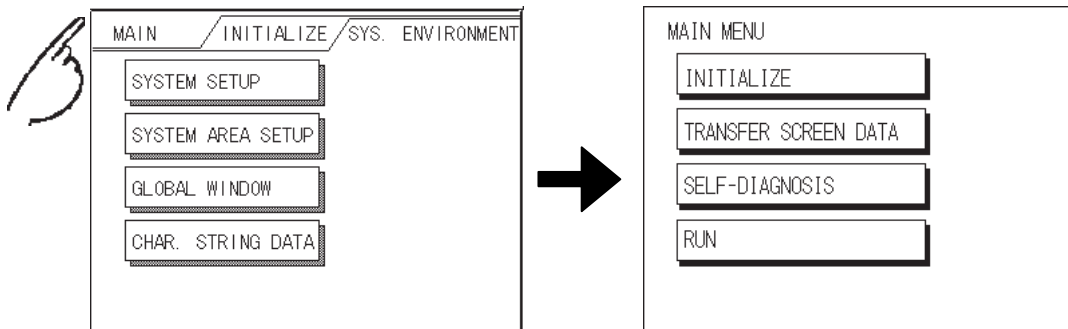

5.4 SELF-DIAGNOSIS

■ Selecting a Sub-Menu

Touch the desired menu item and the corresponding sub-menu will appear.

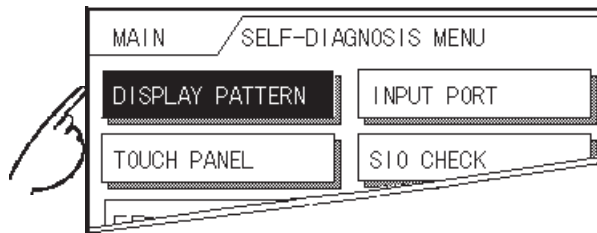

■ Using the SET and ESC Keys

After selecting the Self-Diagnosis item, the SET and ESCAPE keys may appear at different times at the top of the screen.

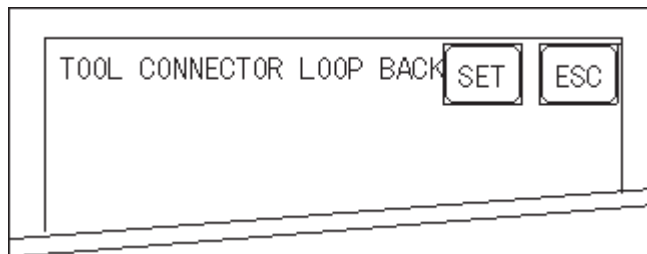

SET Key

Touch the SET key to start the SELF-DIAGNOSIS test.

ESC Key

Touch the ESC key to cancel the SELF-DIAGNOSIS test and return to the SELF-DIAGNOSIS menu.

■ Returning to the SELF-DIAGNOSIS Menu

After performing the SELF-DIAGNOSIS check, OK is displayed. Touch once anywhere on the display screen to return to the SELF-DIAGNOSIS menu.

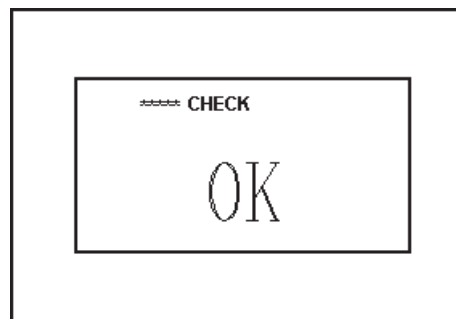

Chapter 5 – OFFLINE Mode

If an Error Message displays, press the bottom-left corner [1] of the panel, and then touch the bottom-right corner [2] of the panel to return to the SELF-DIAGNOSIS menu.

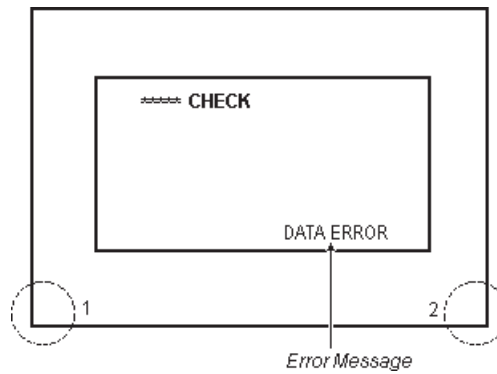

■ Returning to the MAIN MENU

Touch the MAIN tab to return to the MAIN MENU screen.

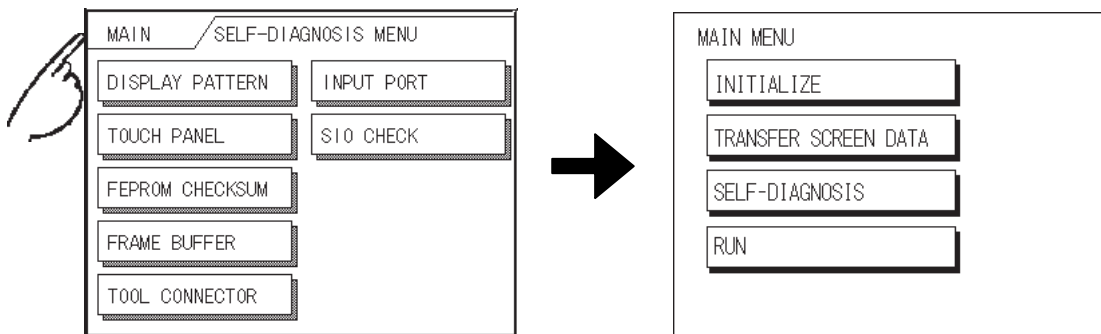

Chapter

6 Initializing the GP-2301H

- | | |
|-----------------------------|-------------------------------|
| 1. Initialization Screen | 5. PLC SETUP |
| 2. Initialization Items | 6. INITIALIZE INTERNAL MEMORY |
| 3. SYSTEM ENVIRONMENT SETUP | 7. SET UP TIME |
| 4. SET UP I/O | 8. SET UP SCREEN |
| | 9. FONT SETTING |

The GP-2301H and GP-2401H have different Setup screens. This chapter explains initial setting items contained in the GP-2301H Series unit's OFFLINE Mode screens.

6.1 Initialization Screen

To change your GP unit's general operation settings, use the GP unit's OFFLINE Mode to access the items in the MAIN MENU's INITIALIZE option.

This chapter explains each of the OFFLINE Mode's INITIALIZE items. However, there are two (2) types of INITIALIZE settings; those for the **1:1** connection and those for the **n:1** (multi-link) connection*¹.

The **n:1** mark appears on original menu items related to **n:1** multi-link connection items. If there is no mark, the menu item is common to both **1:1** and **n:1** connections.

1:1 A single (1) GP is connected with a single (1) PLC.

n:1 Multiple GPs are connected with a single PLC. The GP units successively pass a PLC Access Token (exclusive PLC interaction key) among themselves to designate which unit can communicate with the PLC.



Note:

If you transfer the GP unit's system file data to the GP via your screen creation software², the GP operates using that data. If the GP System file has been correctly set up and transferred, then setting up the following INITIALIZE items is unnecessary.

Reference *For more information about GP System files, refer to the GP-PRO/PBIII for Windows Operation Manual (included with the GP screen creation software).*

1. PLCs that support the **n:1** (multi-link) connection are limited.

Reference *Refer to the PLC Connection Manual (included with the GP screen creation software).*

2. Refer to the GP screen creation software's SYSTEM SETTINGS area.

6.2 Initialization Items

This chapter explains the contents of the INITIALIZE setup items listed below.

Reference For information about screen operations and numeric input, see Chapter 5 – “OFFLINE Mode.”

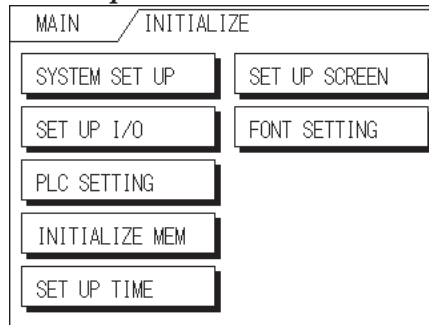

The INITIALIZE menu includes the following items:

SYSTEM ENVIRONMENT SETUP

- SYSTEM SETUP
- SYSTEM AREA SETUP
- GLOBAL WINDOW SETUP
- CHARACTER STRING DATA SETUP

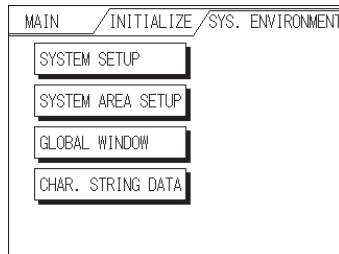

SET UP I/O

- SET UP SIO
- COMMUNICATION SETUP
- SET UP I/O
- DISPLAY SETUP
- PRINTER SETUP
- EXP. SERIAL SETUP
- EXP. SERIAL ENVIRONMENT SETUP
- SET UP CAPTURE OPERATION
- FUNCTION SETUP
- COMMUNICATION PORT SETUP

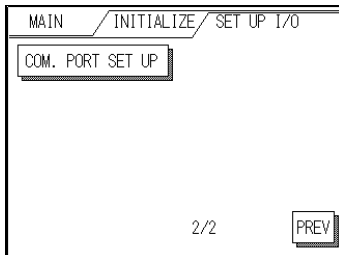
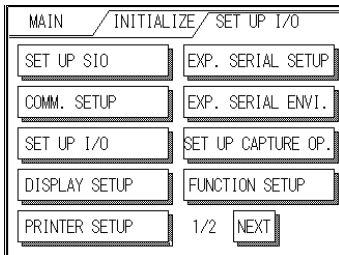

PLC SETUP¹

- PLC SETUP
- STATION SETUP
- CUSTOMIZE SETUP

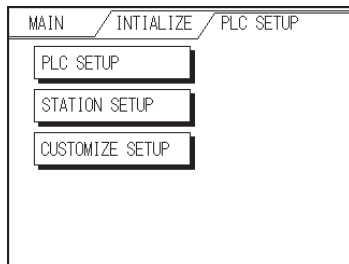

INITIALIZE MEMORY

- INITIALIZE MEMORY
- INITIALIZE CF CARD
- CSV DATA INDEX

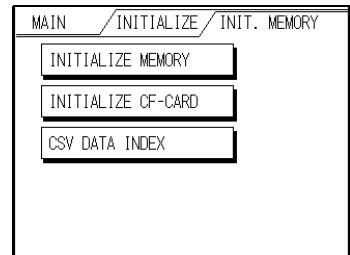

SET UP TIME

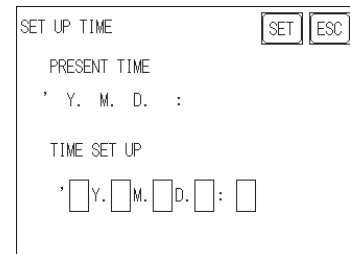

SET UP SCREEN

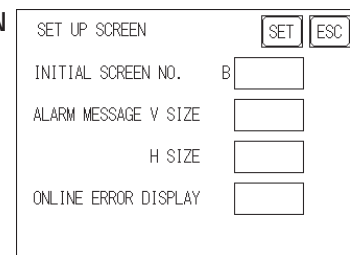

FONT SETTING

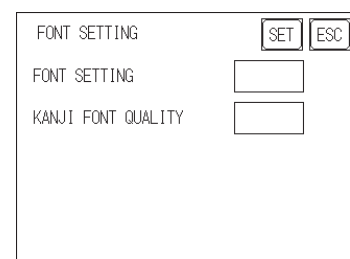

1. Depending on the PLC type selected, the screens that appear in your GP unit's screen creation software will vary.

6.3 SYSTEM ENVIRONMENT SETUP

Adjustments to the GP operation environment are made within the setup screens contained in the SYSTEM ENVIRONMENT SETUP menu. This menu includes the SYSTEM SETUP, SYSTEM AREA SETUP, GLOBAL WINDOW SETUP, and CHARACTER STRING DATA SETUP screens.

6.3.1 SYSTEM SETUP

SYSTEM SET UP		SET	ESC
STANDBY MODE TIME [MIN]	<input type="text" value="0"/>		
START TIME [SEC]	<input type="text" value="0"/>		
TOUCH BUZZER SOUND	<input type="text" value="ON"/>		
PASSWORD SET UP	<input type="text" value="0"/>		
DATA TYPE OF SCREEN NO	<input type="text" value="B I N"/>		

STANDBY MODE TIME [MIN]

To protect the GP unit's display screen, a screen saver function automatically turns the unit's backlight(s) OFF when no operations have occurred within a specified period of time. No screen saver will be used when **0** is entered in this field.

When the SYSTEM DATA AREA's SCREEN DISPLAY OFF*¹ data is set to **0000h**, the GP unit's current display data will clear if the following operations are not performed within the user-specified period of time:

- Change Screen
- Touch Screen
- Alarm Display (Scrolling display)
- Menu Bar (Forced Reset screen)
- Japanese FEP System Window

START TIME [SEC]

Use this setting item to specify the GP unit's startup time — or to adjust the powering-up sequence — so that the GP starts up *after* the PLCs start.

TOUCH BUZZER SOUND

This setting item indicates, with a buzzing sound, that the GP has been touched.

1. When using the Direct Access format, the object address becomes LS0009. When using the Memory Link format, the object address becomes +12. (Only when all items are set within the System Data Area.)

Reference Refer to the GP-PRO/PBIII for Windows Device / PLC Connection Manual (included with the GP screen creation software).

Chapter 6 – Initializing the GP-2301H

PASSWORD SETUP

The password setting item is used when the GP unit switches to the INITIALIZE MEMORY or INITIALIZE (OFFLINE Mode) screens. The password — a number between **0** and **9999** — is a security feature within the OFFLINE Mode, to protect the GP unit settings. The default password is **1101**. When no password has been set, the value is **0**.

Reference For details about entering numerical password values, see 5.3 – “INITIALIZATION.”

DATA TYPE OF SCREEN NO.

This setting specifies whether BIN or BCD format numbers are used when making screen changes.

6.3.2 SYSTEM AREA SETUP

The System Data Area is the LS Area inside the GP, and the PLC uses the System Data Area to control its GP-related data. The Data Register (D) or Data Memory (DM) area is set up in the PLC.

When the GP uses Memory Link format, this setting is unnecessary.

Reference Refer to the GP-PRO/PBIII for Windows Device / PLC Connection Manual (included with the GP screen creation software).

Touch the number for the item desired. The selected item’s display will be reversed.

When you press the CONFIRM key, the SYSTEM AREA CONTENTS screen is displayed to confirm the selected items.

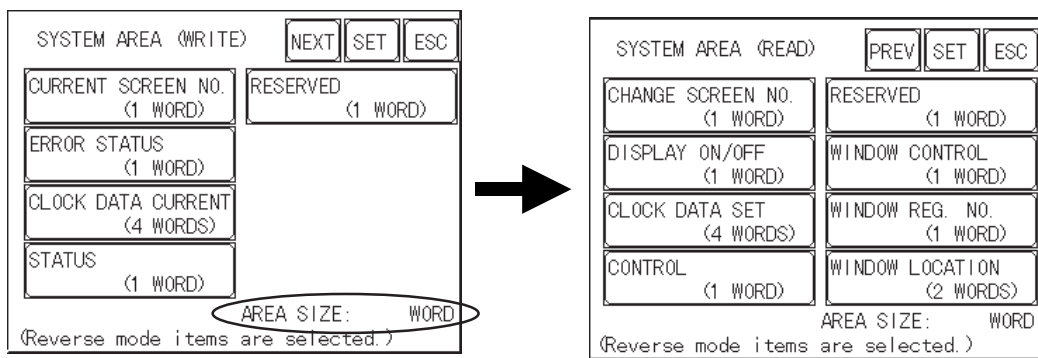

◆ System Area Size

This field displays the total number of words used for the items selected from the SYSTEM AREA SETUP (**Write:** from to and **Read:** from to).



Note:

- The System Area settings are enabled only when using Direct Access format.
- The selected System Area items, as displayed on the screen, become the System Data Area.

Chapter 6 – Initializing the GP-2301H

When the CURRENT SCREEN NUMBER, ERROR STATUS, CLOCK DATA CURRENT, CHANGE SCREEN NUMBER, and DISPLAY ON/OFF setting items have been selected, a word address is assigned to each item, in order, as shown.

SYSTEM AREA CONTENTS		SET	ESC
WORD		WORD	
+0	CURRENT SCREEN NO.	+10	
+1	ERROR STATUS	+11	
+2	CLOCK DATA CURRENT	+12	
+3	CLOCK DATA CURRENT	+13	
+4	CLOCK DATA CURRENT	+14	
+5	CLOCK DATA CURRENT	+15	
+6	CHANGE SCREEN NO.	+16	
+7	DISPLAY ON/OFF	+17	
+8		+18	
+9		+19	

In the above screen, the device address used for the SET UP OPERATION SURROUNDINGS screen's SYSTEM AREA START DEV / START ADR setting is **+0**.

Therefore, when the SYSTEM AREA START DEV / START ADR is **D00200**, and the CHANGE SCREEN NO. setting has been designated, the address shown is **+6**, and you will then need to enter **D00206** ($D00200 + 6$) to use this address.

Reference For details about setting the SYSTEM AREA START DEV / START ADR., see 6.5.1 – “SET UP OPERATION SURROUNDINGS.”

6.3.3 GLOBAL WINDOW SETUP

A GP2000H Series unit can display one Global Window and two Local Windows simultaneously (a total of three windows). Global Windows are independent of the display screens, whereas each Local Window is specific to its designated base screen. This section describes the GLOBAL WINDOW SETUP.

GLOBAL WINDOW SETUP		NEXT	SET	ESC
GLOBAL WINDOW		USE		

➔

GLOBAL WINDOW SETUP		PREV	SET	ESC
GLOBAL WINDOW ACCESS		DIRECT		
DATA FORMAT		B I N		
REGISTRATION NO. (1-256)		1		
LOCATION	X (0-319)	160		
	Y (0-239)	120		

Chapter 6 – Initializing the GP-2301H

GLOBAL WINDOW

Two options are available: USE and DO NOT USE. If you select DO NOT USE, ignore the items described below. Selecting USE enables the following options.

GLOBAL WINDOW ACCESS

Use this feature to designate whether values used by the GP (such as the REGISTRATION NO. and the LOCATION values) are DIRECT or INDIRECT. When set as DIRECT, the REGISTRATION NO. and LOCATION selections are fixed to the values entered here. When set to INDIRECT, the WINDOW REG. NO.'s word address is used by the SYSTEM AREA as a variable. This means the REGISTRATION NO. written to it changes and, as a result, can call up multiple window screens as Global windows. You can also use this method to adjust the Global Window's position by writing the desired (X,Y) coordinates to the SYSTEM AREA's LOCATION word addresses.

DATA FORMAT

Set up the REGISTRATION NO. and the LOCATION values as either BIN or BCD values. This field is related only to INDIRECT values.

REGISTRATION NO. (1-256)

Enter the Window Screen Number used by the Global Window. This field is enabled only when GLOBAL WINDOW ACCESS is set to DIRECT.

LOCATION

Enter the value used for the (Global Window) LOCATION. This field is enabled only when GLOBAL WINDOW ACCESS is set to DIRECT.

6.3.4 CHARACTER STRING DATA SETUP

Character String Data ordering varies from manufacturer to manufacturer. Set up the Character String Data order to match that of the corresponding PLC.

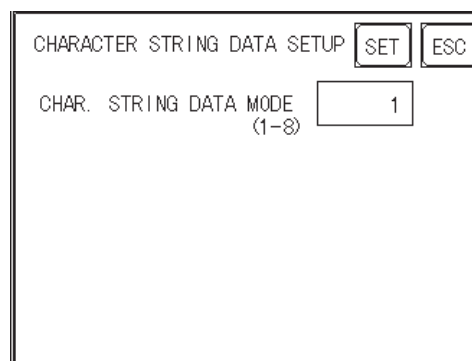

CHARACTER STRING DATA SETUP [SET] [ESC]

CHAR. STRING DATA MODE (1-8) [1]



Set up the CHARACTER STRING DATA MODE to match that of the corresponding PLC. Device type and Tag settings are not available for setup.

Chapter 6 – Initializing the GP-2301H

CHARACTER STRING DATA MODE (1-8)

Set up the CHARACTER STRING DATA MODE that corresponds to that of your PLC, as specified in the following table.

- (I) Data Device Storage Order
- (II) Byte Storage Order (LH/HL), using single words
- (III) Word Storage Order (LH/HL), using double words

CHARACTER STRING DATA MODE (1-8) List

(I) Data Device Storage Order	(II) Byte Storage Order (LH/HL), using single word	(III) Word Storage Order (LH/HL), using double words	Character String Data Mode
Storage from Start Data	LH order	LH order	4
		HL order	2
	HL order	LH order	5
		HL order	1
Storage from End Data	LH order	LH order	6
		HL order	7
	HL order	LH order	8
		HL order	3

I. Data Device Storage Order

Example characters: A B C D E F G H
① ② ③ ④

• Storage from Start Data

①	D100
②	D101
③	D102
④	D103

• Storage from End Data

④	D100
③	D101
②	D102
①	D103

II. Byte Storage Order (LH/HL), using Single Words

Example characters: A B C D
① ② ③ ④

• 16-bit Device LH Order

②	①	D100
④	③	D101

• 16-bit Device HL Order

①	②	D100
③	④	D101

• 32-bit Device LH Order

②	①	④	③	D100
---	---	---	---	------

• 32-bit Device HL Order

①	②	③	④	D100
---	---	---	---	------

Chapter 6 – Initializing the GP-2301H

III. Word Storage Order (LH/HL), using Double Words

Example characters: A B C D E F G H I J
 ① ② ③ ④ ⑤

- **16-bit Device LH Order**

②	D100
①	D101
④	D102
③	D103
⑤	D104

- **16-bit Device HL Order**

①	D100
②	D101
③	D102
④	D103
⑤	D104

Example characters: A B C D E F G H I J K L M N O P Q R S T
 ① ② ③ ④ ⑤ ⑥ ⑦ ⑧ ⑨ ⑩

- **32-bit Device LH Order**

②	①	D100
④	③	D101
⑥	⑤	D102
⑧	⑦	D103
⑩	⑨	D104

- **32-bit Device HL Order**

①	②	D100
③	④	D101
⑤	⑥	D102
⑦	⑧	D103
⑨	⑩	D104

Relationship between K-tag Write Character Value and the PLC Device

- ◆ **16-bit Devices**

The GP stores the character string in one internal device, in groups of two, starting with the first pair of characters.

When nine characters make up a string, they are arranged as follows:

1 2 3 4 5 6 7 8 9 NULL
 └─┘ └─┘ └─┘ └─┘



Note: When the characters do not divide evenly by two, NULL is added to the last character to make up the final pair and complete the string.

- ◆ **32-bit Devices**

The GP stores the character string in one internal device address, in groups of four, starting with the first group of characters.

When there are nine characters, they are arranged as follows:

1 2 3 4 5 6 7 8 9 NULL
 └─┘ └─┘ └─┘



Note: When the characters do not divide evenly by four, NULL is added to the last character to make up the final group and complete the string.

6.4 SET UP I/O

This section describes the communication setup with the Host (PLC) and the configuration for any peripheral equipment. Following are the SET UP I/O menu screens.

6.4.1 SET UP SIO

This screen controls the settings related to communication with the PLCs.

Be sure to match the settings listed below with the SIO setup on the host (PLC). Otherwise, an error may occur.

Reference *Refer to the GP-PRO/PBIII for Windows Device / PLC Connection Manual (included with the GP screen creation software).*

SET UP SIO	SET	ESC
COMMUNICATION RATE	19200	
DATA LENGTH	7/2	
PARITY	EVEN	
CONTROL	ER-CNTRL	
COMMUNICATION INTERFACE	RS232C	



Note:

If you have selected "YES" for the [SERIAL I/F CHANGE] on the [COMMUNICATION PORT SETUP] screen, or "Yes" for the [Serial I/F Switch] settings in the [Change Extend SIO Type] command, in the GP Screen Editor's [Project] menu, do not enter all of the settings related to device communication using the Extended SIO Script Protocol here. ([SET UP SIO] screen) These settings are required to set using the [EXPANSION SERIAL COMMUNICATION SETUP] screen.

COMMUNICATION RATE

The COMMUNICATION RATE (baud rate) is the data communication speed, measured in bits per second (bps), between the GP and the PLC. Match both the PLC and the GP units' COMMUNICATION RATE values. Depending on the rate selected, you may not be able to use certain PLCs.

Reference *Refer to the GP-PRO/PBIII for Windows Device / PLC Connection Manual (included with the GP screen creation software).*

DATA LENGTH / STOP BIT

For data communication, use the following settings:

- DATA LENGTH: 7 or 8 bits
- STOP BIT: 1 or 2 bits

PARITY

Use this setting to specify whether an ODD or EVEN number parity check, or none at all (OFF), will take place during communication.

CONTROL

The CONTROL setting prevents the overflow of data transmitted and received. Select either the XON/XOFF or the ER (DTR) control.

Chapter 6 – Initializing the GP-2301H

COMMUNICATION INTERFACE

Select one of the following options for the COMMUNICATION INTERFACE setting:

- RS-232C
- RS-422 (4-line)
- RS-422 (2-line)



Note: When using an RS-422 cable and the Memory Link format, be sure to select the 4-line option.

Reference Refer to the *GP-PRO/PBIII for Windows Device / PLC Connection Manual* (included with the GP screen creation software).

6.4.2 COMMUNICATION SETUP

This section explains how to use the RETRY command to deal with errors, including those that occur during GP and PLC communication.

COMMUNICATION SETUP	SET	ESC
RECEIVE TIMEOUT (1-127)	10	SEC
RETRY COUNT (0-255)	2	

RECEIVE TIMEOUT (1-127)

Use a numeric value to set a period of time in which the GP receives data from the PLC. If the cable is not connected, data communication will Timeout after one second, regardless of this setting's value.

The default value for the RECEIVE TIMEOUT setting is 10 seconds.



Note: An error message may appear on your personal computer if:

- You transfer screens from your PC to the GP after a PLC communication error has occurred and the error is not yet cleared.
- Your GP unit's RECEIVE TIMEOUT value is set to 30 seconds or more.

RETRY COUNT (0-255)

Use this setting item to designate the number of times the GP tries to send data to the PLC when a PLC communication error occurs. After the GP unit's specified number of attempts has failed to send data to the PLC, an error message will appear on the GP.

The default value for the RETRY COUNT setting is **2**.

6.4.3 SET UP I/O

Set up the touch panel's TOUCH OPERATION and SYSTEM RESET modes, and adjust the Display Device settings in this screen. Depending on the GP type, these settings may vary.

GP2301HL (Monochrome LCD) Setup Screen

SET UP I/O	NEXT	SET	ESC
TOUCH OPERATION MODE	2 POINTS		
SYSTEM RESET MODE	ON		
CONTRAST SETTING	ON		
BRIGHTNESS SETTING	ON		
SET UP LCD	NORMAL		



SET UP I/O	PREV	SET	ESC
USE TOUCH PANEL AFTER BACKLIGHT BURNOUT	<input type="checkbox"/>		

GP2301HS (STN Color) Setup Screen

SET UP I/O	SET	ESC
TOUCH OPERATION MODE	2 POINTS	
SYSTEM RESET MODE	ON	
CONTRAST SETTING	ON	
BRIGHTNESS SETTING	ON	
USE TOUCH PANEL AFTER BACKLIGHT BURNOUT	YES	

TOUCH OPERATION MODE

Designates ONE POINT, TWO POINTS, or NO SLIDE. When NO SLIDE is selected, the screen will NOT respond to one's finger dragging across the touch screen. Only individually-selected points will register.

Chapter 6 – Initializing the GP-2301H

SYSTEM RESET MODE

Enables or disables the display of the SYSTEM RESET screen's menu bar. When set to ON, the menu bar will display.

◆ To Perform SYSTEM RESET

To enter the SYSTEM RESET mode, press the bottom-right corner of the screen (position 1, below), and then touch the top-right and bottom-left corners (positions 2 and 3).

To activate RESET, touch the RESET button; to change to OFFLINE Mode, touch OFFLINE.

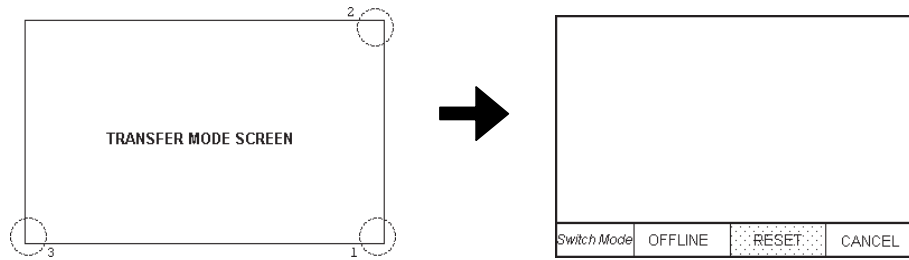

You can perform SYSTEM RESET in either RUN mode or OFFLINE Mode.



- The menu bar will not display when the GP unit is starting up.
- Entering SYSTEM RESET is possible even when the PLC and the GP unit are not communicating.

CONTRAST SETTING

When this option is set to ON, you can adjust the contrast by touching the screen.



Be sure to press the GP unit's corners in the order shown. If only corner (2) is pressed, OFFLINE Mode will start.

While holding down the top-right corner (1) of the screen, press the top-left corner (2) to enter the CONTRAST SETTING mode. Press the desired setting, and the screen's contrast will adjust accordingly.

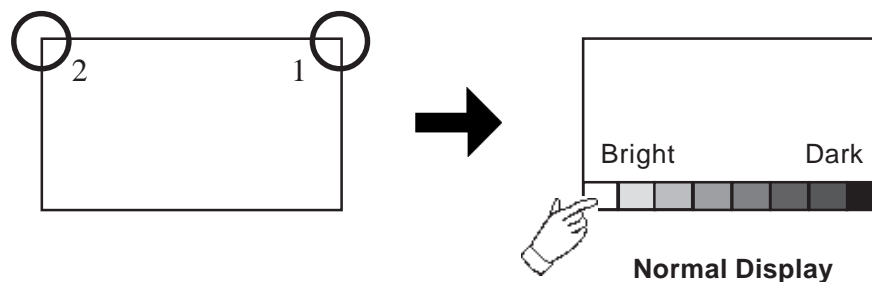



Note:

- To exit the CONTRAST SETTING mode, touch anywhere on the screen, except the bottom section.
- CONTRAST SETTING mode cannot be entered while waiting for the GP unit to start up.
- CONTRAST SETTING mode can be made during RUN mode (PLC ↔ GP communication).
- Regardless of the display (normal or reversed), the left side of the CONTRAST SETTING menu bar, displayed at the bottom area of the screen, is always Bright.

BRIGHTNESS SETTING

When the BRIGHTNESS SETTING is set to ON, you can adjust the brightness by touching the GP unit's screen. To enter BRIGHTNESS SETTING mode, press the bottom-right corner (position 1) of the screen (A), and then touch the bottom-left corner (2). When the BRIGHTNESS SETTING screen (B) appears, touch the left side of the bar to brighten the display, and touch the right side of the bar to darken the display. Four levels of adjustment are available with this unit.

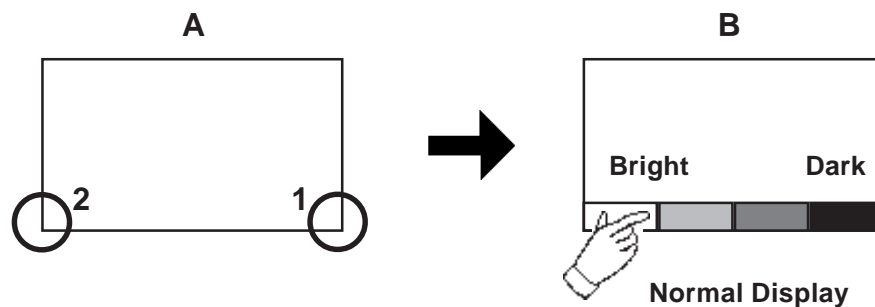

Note:

- When the brightness is set to Dark, flickering may occur, and the DISPLAY SETUP will need to be adjusted.

Reference See 6.4.4 – “DISPLAY SETUP.”

- To exit the BRIGHTNESS SETTING mode, touch anywhere above the BRIGHTNESS SETTING menu bar.
- You cannot enter the BRIGHTNESS SETTING mode while the GP unit is starting up.
- BRIGHTNESS SETTING can be made during RUN mode (PLC ↔ GP communication).
- Regardless of the display (normal or reversed), the left side of the BRIGHTNESS SETTING menu bar, displayed at the bottom area of the screen, is always Bright.
- One of the characteristics of the display device is that, once it is plugged into the power source, it takes some time to reach the maximum practical brightness. At room temperature, the display device takes about 10 minutes to reach 70% of its maximum brightness.

Chapter 6 – Initializing the GP-2301H

SET UP LCD (GP-2301HL ONLY)

To reverse the screen display colors, touch SET UP LCD on the SET UP I/O screen to change the setting from NORMAL to REVERSE, and then touch the SET key. The display color will be reversed and the previous screen will reappear.

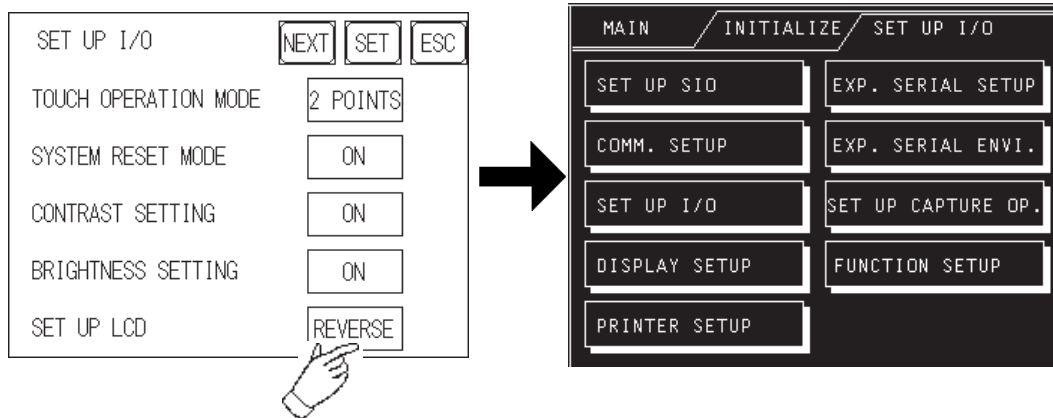

USE TOUCH PANEL AFTER BACKLIGHT BURNOUT

This item allows the user to enable [ON] or disable [OFF] the touch operation when the backlight burns out. Setting this item to OFF prevents the GP from sending input signals to the PLC.



When the Backlight Burns Out:

- The Status LED's orange light will turn ON.
- The System Data Area's Status bit 10*1 will turn ON.
- If the SYSTEM RESET item is set to ON, only SYSTEM RESET can still be performed by touch operation. (Although the screen is pitch-black and cannot be seen, touch-panel operation can be performed in the SYSTEM RESET screen.)
- If the GP is in OFFLINE Mode, the touch-panel operation will become enabled, regardless of the settings.



Normally, the unit detects backlight burnout by monitoring the current. However, depending on the problem with the backlight, the unit may fail to detect this condition, or the unit may detect this condition before backlight burnout.

1. Bit +6 (when using the Direct Access method), and bit +11 (when using the Memory Link method), will turn ON.

Reference Refer to the GP-PRO/PBIII for Windows Device / PLC Connection Manual (included in the GP screen creation software).

6.4.4 DISPLAY SETUP

Depending on the GP unit's BRIGHTNESS settings and its environment, the screen's display may flicker. The BRIGHTNESS setting may be set too low, or the GP unit's surrounding environment may be either too hot or too cold. This problem does not usually occur; however, in order to correct this problem, please use the following settings.

GP-2301HL (Monochrome LCD)

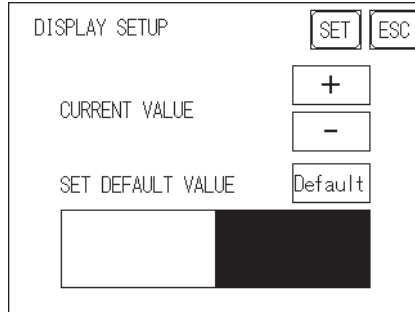

<When using Black and White>

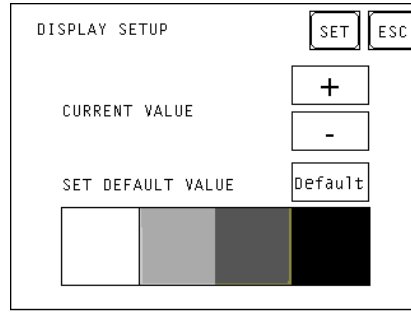

<When using 8 levels of gray>

GP-2301HS (STN Color LCD)

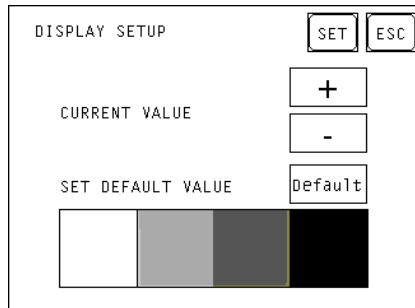

CURRENT VALUE

Use the displays on the bottom of the screen to gauge whether the + or – adjustments help to correct the problem. While the normal setting value is **0**, there are two levels below [–] the **0**, and 18 levels above [+] the **0**.

SET DEFAULT VALUE

Touch **Default** to return the set value to a default value.

6.4.5 PRINTER SETUP

These functions are NOT supported by the GP-2301H Series units. Return to the previous screen by touch ESC.



Chapter 6 – Initializing the GP-2301H

6.4.6 EXPANSION SERIAL COMMUNICATION SETUP

Since GP-2301H Series unit is not equipped with an expansion serial I/F. If you have selected the [NO] for the [SERIAL I/F CHANGE] on the [COMMUNICATION PORT SETUP] screen, or "No" for the [Serial I/F Switch] settings in the GP Screen Editor (when not using the Extended SIO Script Protocol for communication), the expansion serial communication setup is not required.



- If you have selected "YES" for the [SERIAL I/F CHANGE] on the [COMMUNICATION PORT SETUP] screen, or "Yes" for the [Serial I/F Switch] settings [Change Extend SIO Type] command, in the GP Screen Editor' [Project] menu, enter all of the settings related to device communication using the Extended SIO Script Protocol here, [EXPANSION SERIAL COMMUNICATION SETUP] screen. Then, the settings on the [SET UP SIO] screen will be disabled.

EXP. SERIAL SETUP	SET	ESC
COMMUNICATION RATE	9600	
DATA LENGTH	8/1	
PARITY	OFF	
RI/VCC (COM2)	RI	
COMMUNICATION FORMAT	RS232C	

COMMUNICATION RATE

The COMMUNICATION RATE (baud rate) is the data communication speed, measured in bits per second (bps), between the GP and the Devices.

Reference *GP-PRO/PBIII for Windows Device/PLC Connection Manual*

DATA LENGTH/STOP BIT

For data communication, the DATA LENGTH must be set up as 7-bit or 8-bit data. Also, the STOP BIT must be designated as either a 1-bit or 2-bit value.

PARITY

Set up whether no parity check, or an odd or even number parity check will be performed during communication.

RI/VCC (COM2)

GP-2301H Series unit has no expansion interface. This setting will be disabled.

COMMUNICATION FORMAT

Select one of the following options for the communication format: RS-232C, RS-422 (4 line), or RS-422 (2 line).

6.4.7 EXPANSION SERIAL ENVIRONMENT SETUP

Since GP-2301H Series unit is not equipped with an expansion serial I/F, the expansion serial environment setup is not required.

6.4.8 SET UP CAPTURE OPERATION

Save the captured image of the GP unit's screen as a JPEG file in the CF Card.

Reference Refer to the *GP-PRO/PBIII for Windows Tag Reference Manual*, 4.7.10 – “Screen Capture,” (included in the GP screen creation software).

SET UP CAPTURE OPERATION	<input type="button" value="SET"/>	<input type="button" value="ESC"/>
QUALITY(1-100)	<input type="text" value="80"/>	
B/W REVERSE	<input type="text" value="YES"/>	

QUALITY (1-100)

Sets the captured image quality. The image quality can be set from 1 to 100. 100 is the highest quality.

B/W REVERSE

The white portion of the image that is created in the screen creation program is reversed to black, and the black portion is reversed to white. This reversed white-and-black image can be captured and saved.



Note: Only black and white colors are reversed.

◆ GP-2301HL (Monochrome LCD)

- When B/W REVERSE is YES:
The displayed image data is saved as black, and the non-displayed portion is saved as white.
- When B/W REVERSE is NO:
The displayed image data is saved as white, and the non-displayed portion is saved as black.



Note: The Monochrome LCD GP (GP-2301HL) saves the image data as black in the CF Card, regardless of the GP unit's reverse display setting.

◆ GP2301HS (STN Color LCD)

The Color LCD GP captures a B/W reverse image and saves it to the CF Card. The white portion of the image is converted to black, and the black portion of the image is converted to white. Only black and white colors are converted.

Chapter 6 – Initializing the GP-2301H

6.4.9 FUNCTION SETUP

This setting allows the user to enable (YES) or disable (NO) the operation switch. Activate the OPERATION SWITCH function by touching the OPERATION SWITCH setting or the YES/NO display area, and touch SET to confirm. The default value is set to NO.

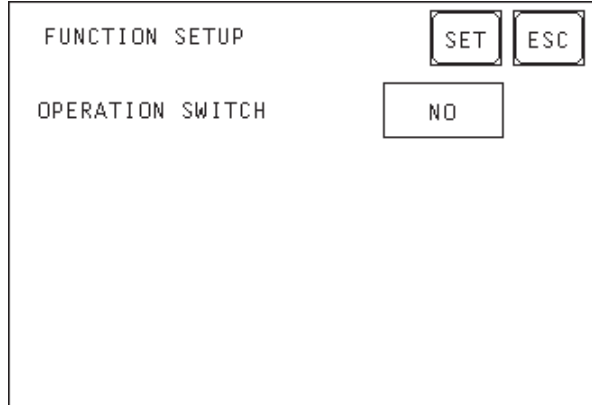

6.4.10 COMMUNICATION PORT SETUP

This screen allows you to set up the connection environment of the GP's communication port (COM1).

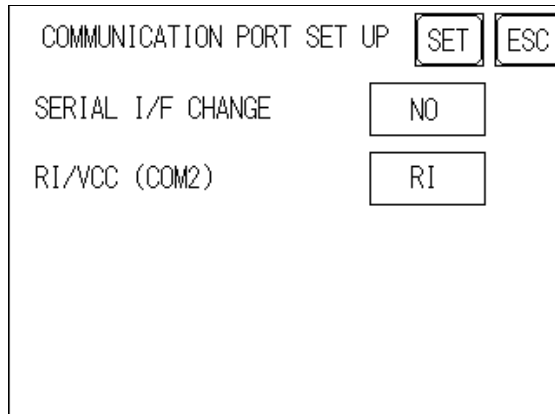

SERIAL I/F CHANGE

Selecting "YES (COM1 <->COM2)" designates that the communication used for the Extended SIO Script Protocol starts at the Serial I/F (COM1).

In OFFLINE mode, the SERIAL I/F CHANGE setting is set to "NO".



Note:

After selecting "YES (COM1 <->COM2)", enter all of the settings related to device communication using the Extended SIO Script Protocol, [EXPANSION SERIAL COMMUNICATION SETUP] screen. The settings on the [SET UP SIO] screen will be disabled. **Reference** 6.4.6 EXPANSION SERIAL COMMUNICATION SETUP

RI/VCC (COM2)

Since GP-2301H Series units have no expansion interface, this setting will be disabled.

6.5 PLC SETUP

Set up the GP unit's SYSTEM AREA and the UNIT NUMBER in this screen. Because **1:1** and **n:1** GP connections use different settings, confirm your connection requirements before using any settings. The following assumes that the Direct Access format is used.



Note:

- The screens that appear depend on the PLC type you selected in the GP screen creation software.

Reference Refer to the *GP-PRO/PBIII for Windows Device / PLC Connection Manual* (included in the GP screen creation software).

- When the GP-PRO/PBIII for Windows Simulation feature is used, the OPERATION SURROUNDINGS menu cannot be used.

6.5.1 SET UP OPERATION SURROUNDINGS (1:1 / n:1)

Enter the PLC SYSTEM DATA AREA and UNIT NUMBER settings in this screen. The same options are available for both **1:1** and **n:1** (multi-link) connections. For an **n:1** (multi-link) connection, SYSTEM DATA AREA settings must be set up for each GP unit connected to the PLC.

Reference Refer to the *GP-PRO/PBIII for Windows Device / PLC Connection Manual* (included in the GP screen creation software).

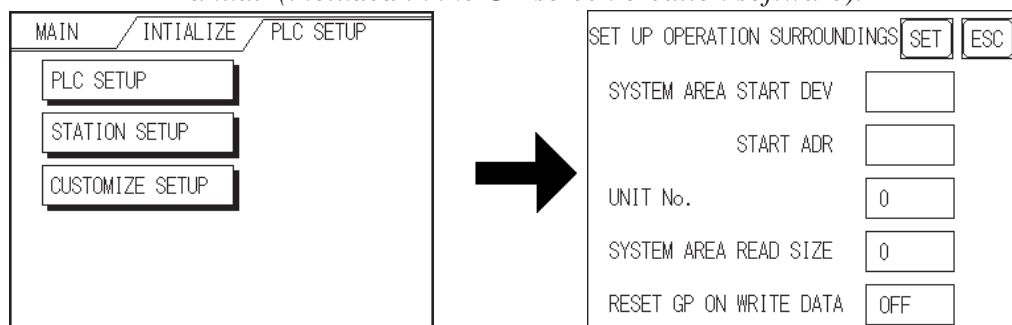

SYSTEM AREA START ADDRESS

Set up the SYSTEM DATA AREA's START ADDRESS. The DEVICE ADDRESS(es) that can be allocated will differ, depending on the type of PLC used.

Reference Refer to the *GP-PRO/PBIII for Windows Device / PLC Connection Manual* (included in the GP screen creation software).

UNIT NO.

Enter the PLC UNIT NUMBER in this setting. Make sure that it matches the PLC's unit number setting.

SYSTEM AREA READ SIZE

When using a Block Display Trend Graph, set up the READING AREA SIZE (in word units) to match the Trend Graph's data size. Use this feature to allocate the READING AREA in the PLC Data Register (D), or Data Memory (DM).



Note:

If you are not using the READING AREA, leave the default values that are set to **0** intact, to allow high-speed data communication performance.

Chapter 6 – Initializing the GP-2301H

RESET GP ON WRITE ERROR

Designates the mode that enables you to cancel the error from the error display when the Write error occurs.

6.5.2 STATION SETUP (n:1)

STATION SETUP, required with an **n:1** (multi-link) setup, checks whether data communication is being performed correctly between the GP unit and the PLC.

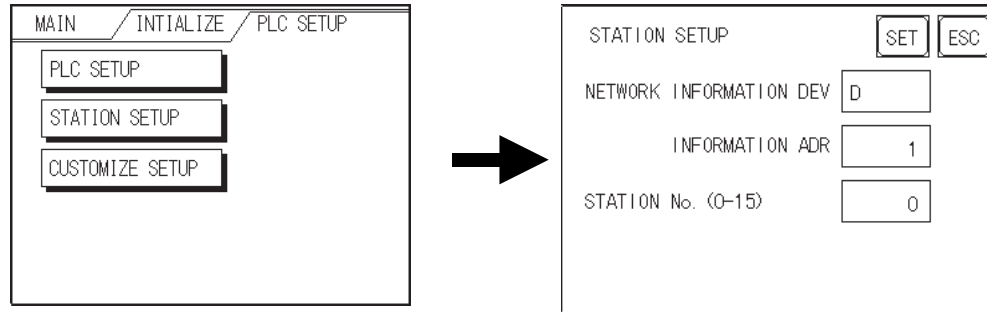

NETWORK INFORMATION ADDRESS

With an **n:1** (multi-link) connection, the NETWORK INFORMATION setting uses two (2) words — a Connection List and a Validation List (described in this section) — for its data. These areas are allocated in the PLC unit’s Data Register (D) or Data Memory (DM). Addresses that can be allocated will differ, depending on the PLC type.

Reference Refer to the GP-PRO/PBIII for Windows Device / PLC Connection Manual (included in the GP screen creation software).

PLC Data Register

+0	Connection List	PLC→GP
+1	Validation List	GP→PLC



In the NETWORK INFORMATION ADDRESS setting, set up the same address to all the GPs connected to the same link unit. Also, when the link unit has two ports, be sure they do NOT use the same address.

◆ Connection List

The word address for the Connection List sets the number of GP units connected to the PLC, which must have been entered previously in the PLC. When these GP units are connected to the PLC, the corresponding PLC bit number for each GP Station turns ON (see below).



Note: When the GP is connected to the PLC, and the option of GP-only correspondence ends and OFFLINE Mode is entered, the GP Station Number then turns the corresponding PLC bit OFF.



Chapter 6 – Initializing the GP-2301H

For example, when four GP units — bits 0, 2, 3, and 5 — are connected, **002D (h)** is written.

Bit 15															Bit 0			
0	0	0	0	0	0	0	0	0	0	0	0	1	0	1	1	0	1	002D (h)



- **Be sure to set up this data before running.**
- **Turn OFF all bits not related to the GP unit.**

◆ Validation List

This area responds to the communication from each connected GP unit. In the Validation List, when the same bit numbers as the Connection List turn ON, the communication is accepted. The Station Numbers of the communicating GP units turn their corresponding PLC bit number ON.

Bit 15															Bit 0	
15	14	13	12	11	10	9	8	7	6	5	4	3	2	1	0	unit unit unit unit unit unit unit unit unit unit unit unit unit unit unit unit

If the communication between the GP unit and PLC is correct, the same value in the Connection List will be written to the Validation List.

For example, the value **002D (h)**, set up in the Connection List as Bit 0, Bit 2, Bit 3, and Bit 5, will be written to the Validation List.

	Bit 15															Bit 0				
Connection List	0	0	0	0	0	0	0	0	0	0	0	0	0	1	0	1	1	0	1	002D (h)
Validation List	0	0	0	0	0	0	0	0	0	0	0	0	0	1	0	1	1	0	1	002D (h)



- **When the Connection List and Validation List do not match, a COMMUNICATION ERROR occurs. Check the setup again.**
- **Before changing the connection, turn all the bits OFF.**

STATION NO. (0–15)

This is the setup for the GP Station Number mentioned above. The setup range is 0 to 15, and the only other restriction is that the GP STATION NO. must be unique in the system. If the same STATION NO. is used on multiple GP units, a COMMUNICATION ERROR will occur.



The STATION NO. is the number allocated to a particular GP unit. This number is not related to the Link Unit Machine number.

Chapter 6 – Initializing the GP-2301H

6.5.3 CUSTOMIZE SETUP (n:1)

The CUSTOMIZE function modifies the **n:1** (multi-link) connection's communication method to maximize its efficiency. To perform GP ↔ PLC communication efficiently, the user should first determine whether OPERATION or DISPLAY will be the priority set for the GP unit. Based on this, the communication response speed can be upgraded. (However, this also depends on the complexity of the screen information displayed.)

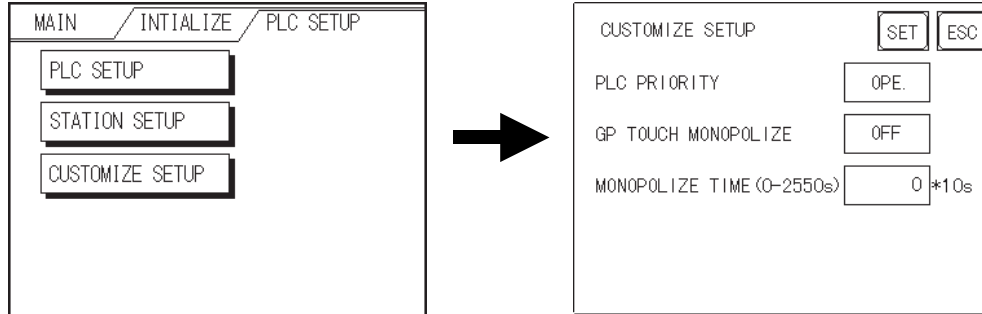

PLC PRIORITY

Depending on how the GP2000H unit is used, select either OPERATION priority (OPE.) or DISPLAY priority (DISPLAY).

◆ DISPLAY

Set up the GP unit to this option when using the GP mainly as a monitor screen. The GP will command a higher display speed as a result. However, the response time for the touch panel's operations will slow.

◆ OPERATION

Set up the GP unit to this option when using the GP mainly as a monitor screen. The touch panel's numeric value input or switch function response speed will become higher as a result.

When OPE. is selected, the response time for the touch panel's operation is not likely to be affected by the number of GP units. However, the display refresh cycle time will be slower.



- **In a standard network setup, use the same settings for all connected GP units.**
- **To increase the display speed, be sure the addresses used are consecutive addresses. When bit addresses are used, use addresses that are consecutive to word units.**

◆ Speed Difference between DISPLAY Priority and OPERATION Priority

When using the Mitsubishi Electric Corporation A3A PLC with consecutive addresses (80 words, not including the SYSTEM AREA) at a 20ms Scan Time, the difference in reading speed is as shown in the following graphs.

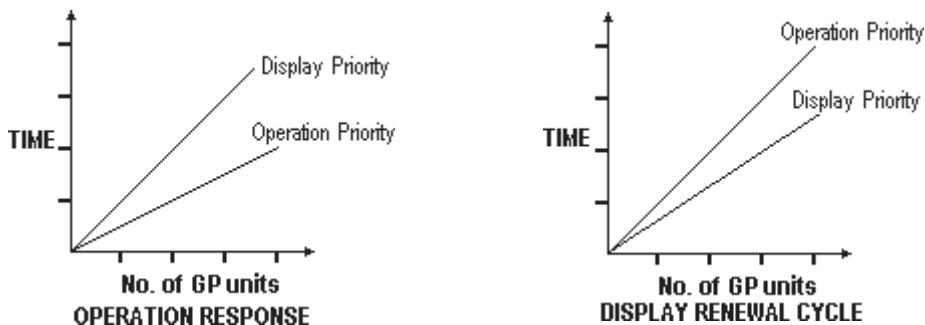

GP TOUCH MONOPOLIZE

Touch panel monopolization can be turned ON or OFF via this screen. For example, when you want to use the PLC exclusively with a momentary-type switch from the touch panel, set the GP TOUCH MONOPOLIZE setting to ON.

When this setting is ON, the touch panel uses the PLC exclusively whenever the momentary switch is pressed. This allows you to use a touch panel switch for unit inching operations. Exclusive use ends when you stop pressing the panel.

Reference Refer to the *GP-PRO/PBIII for Windows Device / PLC Connection Manual* (included in the GP screen creation software).

MONOPOLIZE TIME (0–2550s)

Set Bit 7 of the System Data Area LS14 to ON, to set monopolizing time.

This field controls the length of time for the monopolization process when no other touch panel operations are performed. The monopolization process ends when the time set here elapses, and the Bit 7 of word address LS14 turns OFF.

After cancelling GP TOUCH MONOPOLIZE, it will return to **n:1** (multi-link) communication.



Note:

- Pressing the touch panel in the middle of the monopolize process interrupts the MONOPOLIZE TIME function, and ends exclusive use.
- When MONOPOLIZE TIME is set to 0, the monopolize function does not end automatically.

Reference For further information about the contents of System Data Area LS6 (status) and LS14 (control), refer to the *GP-PRO/PBIII for Windows Device / PLC Connection Manual* (included with the GP screen creation software).

6.6 INITIALIZE INTERNAL MEMORY

This section explains how to initialize the GP unit’s internal memory (screen data), or how to initialize a CF Card inserted in the GP. Select one of the menu items, [INITIALIZE MEMORY], [INITIALIZE CF CARD] and [CSV DATA INDEX] selections in the [INITIALIZE MEMORY] menu.

6.6.1 INITIALIZE GP MEMORY

This will erase all GP screen data (internal memory). Backup SRAM will also be initialized.

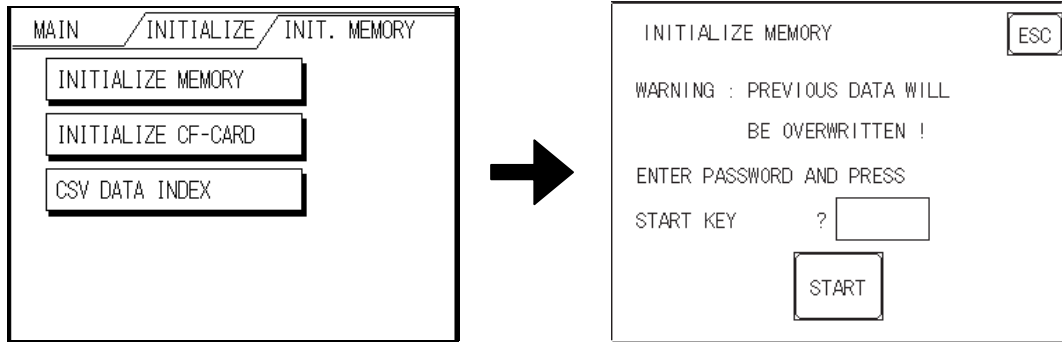

- You cannot cancel the initialization procedure after pressing **START**. Do **NOT** turn the power off when initializing.
- All data in SRAM will be erased.
- Initialization does not erase the **SYSTEM SETUP**, the **SIO protocol**, or the **internal clock settings**.

To initialize the GP unit’s internal memory, enter the default password, **1101**, or the password entered in the SYSTEM SETUP screen.

Reference See 5.3 – “INITIALIZATION.”



The time required for initialization is between 10 and 20 seconds.

6.6.2 INITIALIZE CF CARD

CF Card initialization deletes all CF Card data installed in the GP unit.



Initialization cannot be cancelled once the START switch is touched.

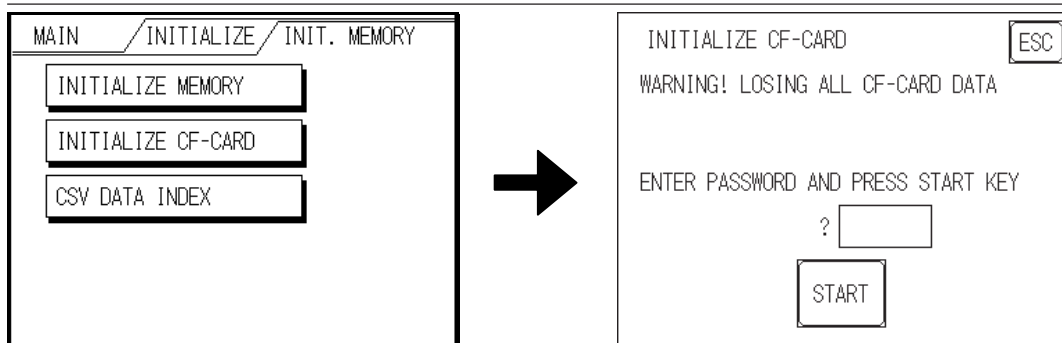

To initialize the CF Card, enter the default password, **1101**, or the password entered in the SYSTEM SETUP screen. **Reference** For details about entering the password’s numeric values, see 5.3 – “INITIALIZATION.”

6.6.3 CSV DATA INDEX

Specific data-transfer CSV files (ZR*****.CSV) on the CF Card can be transferred from the CF Card directly to the PLC (filing) or from the PLC directly to the CF Card (logging). For the details about the CSV Data Transfer Function, [Reference GP-PRO/PB III for Windows Tag Reference Manual](#).

Here creates the index file of the CSV files that are saved into the CF card with the CSV data transfer function.

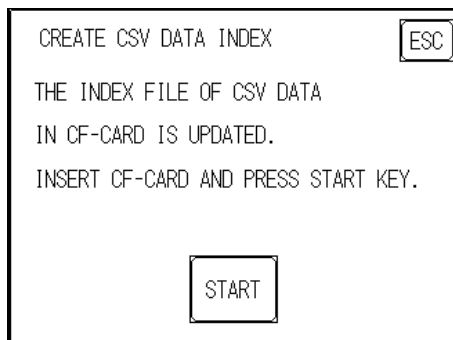

Touch the [START] key, then the operation to create the index file will start.



Do not open the CF card cover during the operation to create the index file. The data may be damaged.



Too many number of CSV files may cause a time loss for creating the index file. It will take about 10 minutes for creating an index file of the 4,000 CSV files.

If you touch the [CANCEL] key during the operation to create the index file, the operation will stop, then the following screen will appear.

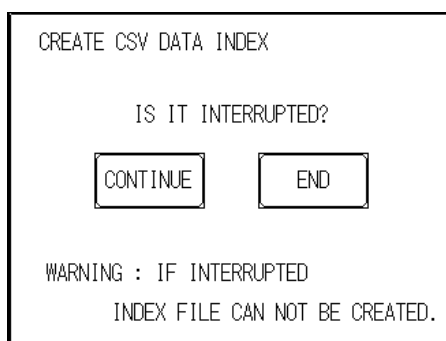

CONTINUE

The operation restarts. When the message "CREATED INDEX FILE. PLEASE PRESS END KEY" appears, finish the program.

END

Deletes the creating index file, then the [INITIALIZE MEMORY] screen will reappear.

6.7 SET UP TIME

Set the GP unit's internal clock in the SET UP TIME screen.

The screenshot shows a menu titled "SET UP TIME" with two buttons, "SET" and "ESC", in the top right corner. Below the title, there are two main options: "PRESENT TIME" and "TIME SET UP". Under "PRESENT TIME", the text "Y. M. D. :" is displayed. Under "TIME SET UP", there are five input fields: the first is followed by "Y.", the second by "M.", the third by "D.", and the fourth and fifth are followed by ":" and a space respectively.

SET UP TIME

Adjust the date and time display settings in the PRESENT TIME setting item.



Note:

- The GP unit's internal clock has a slight error in accuracy. At normal operating temperatures and conditions, with the GP unit operating from its lithium battery, the degree of error is ± 65 seconds per month. Variations in operating conditions and battery life can cause this error to vary from -380 to +90 seconds per month. For systems where this degree of error will be a problem, the user should monitor this error and make adjustments as necessary.
- The screen displays the Hour and Minute settings, but not the Seconds.
- Enter the last two digits of the Western calendar year.

6.8 SET UP SCREEN

Use this screen to enter the number of the screen that is initially displayed after startup, the character size when the GP2000H is in RUN mode, and other general screen items.

SET UP SCREEN		SET	ESC
INITIAL SCREEN NO.	B	1	
ALARM MESSAGE V SIZE		1	
H SIZE		1	
ONLINE ERROR DISPLAY		ON	

INITIAL SCREEN NO.

This setting item specifies the file number of the screen that initially displays on startup. If the BIN option was selected for DATA TYPE OF SCREEN NO. in the SYSTEM SETUP screen, enter a number between 1 and 8999. If BCD was the setup option, enter a number between 1 and 1999.

ALARM MESSAGE

Use this setting item to set the character size for the ALARM MESSAGE, when activated by the Alarm Bulletin.

1

2

4

When using single-byte characters:

V size=1

V size=2

V size=4

H size=1

H size=2

H size=4

16×8 pixels

32×16 pixels

64×32 pixels

When using double-byte characters:

V size=1

V size=2

V size=4

H size=1

H size=2

H size=4

16×16 pixels

32×32 pixels

64×64 pixels

ONLINE ERROR DISPLAY

Use this item to set up the display of error messages during RUN mode.

6.9 FONT SETTING

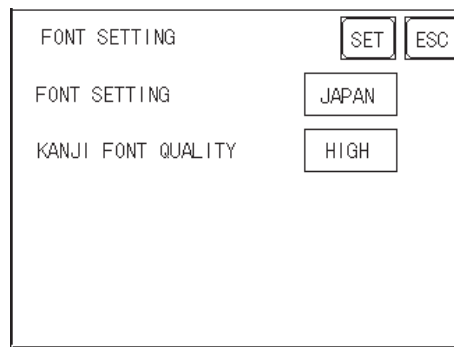

FONT SETTING

Selects the font type displayed on the GP unit's screen during operation.

KANJI FONT QUALITY

Designates the font display quality for enlarged characters.

Differences in FONT SETTINGS

◆ When FONT SETTING is set to [JAPAN]

Single-byte characters will remain 8x16-dot characters when they are enlarged.

Double-byte characters are displayed as:

Standard Characters are displayed using 16x16-dot "blocks." When enlarged, this font will remain a 16x16-dot character (compatible with GP-*30 Series units).

HIGH When enlarged to double size, Level 1 JIS Kanji Code characters display as 32x32-dot characters. Level 2 JIS Kanji Code characters will remain 16x16-dot characters (compatible with GP-*50, GP70 Series units).

HIGH (1, 2) When enlarged to double size, both Level 1 and Level 2 JIS Kanji Code characters display as 32x32-dot characters.

◆ When FONT SETTING is set to any other type, such as [CHINA], [I-ASCII], [KOREA], or [TAIWAN]

Standard Half-sized (single-byte) characters display as 16x8-dot characters. Full-size characters, regardless of the display size used, always display as 16x16-dot characters. When enlarged, this font will remain a 16x16-dot character (compatible with GP-*30 Series units).

HIGH (1) All half-sized (single-byte) characters — ASCII code: 21h to 7Dh, or alphanumeric characters (except the ^ and ' characters) — display as high-quality characters.

- 16x16-dot characters or larger display as high-quality 16x16 fonts.
- 32x32-dot characters or larger display as high-quality 32x32 fonts.

Full-sized (double-byte) characters display as 16x16-dot characters, and remain 16x16-dot characters when enlarged (compatible with GP-*30 Series units).

Chapter 6 – Initializing the GP-2301H

HIGH (1, 2) All single-byte characters — ASCII code: 21h to 7Dh, or alphanumeric characters (except the ^ and ‘ characters) — display as high-quality characters.

- When 16x16 dots are used, the characters display as high-quality 16x16-dot characters.
- When 32x32 or larger-sized dots are used, the characters display as high-quality 32x32-dot characters.

Full-sized (double-byte) characters — [KOREA], [TAIWAN], and [CHINA] — display as 32x32-dot characters when enlarged to 32x32-dot characters or larger.

Memo

Chapter

7 Initializing the GP-2401H

1. Initialization Screen
2. Initialization Items
3. SYSTEM ENVIRONMENT SETUP
4. SET UP I/O
5. PLC SETUP
6. INITIALIZE INTERNAL MEMORY
7. SET UP TIME
8. SET UP SCREEN
9. FONT SETTING

The GP-2301H and GP-2401H have different Setup screens. This chapter explains initialization items performed on the OFFLINE Mode of the GP-2401H Series unit.

7.1 Initialization Screen

To change your GP2000H unit's general operation settings, use the OFFLINE Mode to access the items in the MAIN MENU's INITIALIZE option.

This chapter explains each of the OFFLINE Mode's INITIALIZE items. There are two (2) types of INITIALIZE settings: those for the **1:1** connection, and those for the **n:1** (multi-link) connection.*¹

The **n:1** mark appears on original menu items related to **n:1** multi-link connection items. If there is no mark, the menu item is common to both **1:1** and **n:1** connections.

1:1 A single (1) GP unit is connected with a single (1) PLC.

n:1 Multiple GP units are connected with a single PLC. The GP units successively pass a PLC Access Token (exclusive PLC interaction key) among themselves to designate which unit can communicate with the PLC.



Note: If you transfer the GP unit's system file data to the GP unit via your screen creation software², the GP unit operates using that data. If the GP unit's System file has been correctly set up and transferred, then setting up the following INITIALIZE items is unnecessary.

Reference *For more information about GP System files, refer to the GP-PRO/PBIII for Windows Operation Manual (included with the GP screen creation software).*

1. PLCs that support the **n:1** (multi-link) connection are limited.

Reference *Refer to the PLC Connection Manual (included with the GP screen creation software).*

2. Refer to the GP screen creation software's SYSTEM SETTINGS area.

7.2 Initialization Items

This chapter explains the contents of the INITIALIZE setup items listed below.

Reference For information about screen operations and numeric input, see Chapter 5 – “OFFLINE Mode.”

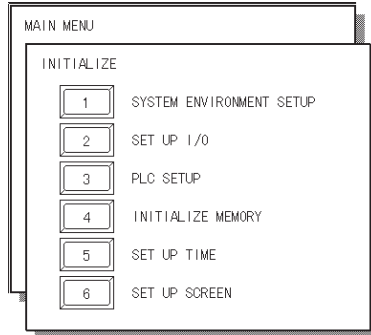

SYSTEM ENVIRONMENT SETUP

- SYSTEM SETUP
- SYSTEM AREA SETUP
- GLOBAL WINDOW SETUP
- CHARACTER STRING DATA SETUP

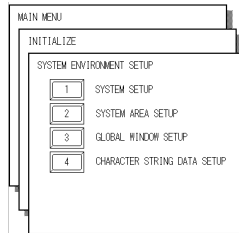

SET UP I/O 1/3

- SET UP SIO
- SET UP PRINTER
- SET UP TOUCH PANEL
- COMMUNICATION SETUP
- SOUND SETTINGS

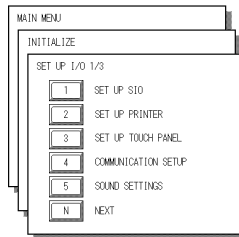

SET UP I/O 2/3

- EXP. SERIAL SETUP
- EXP. SERIAL ENVIRONMENT SETUP
- SET UP CAPTURE OPERATION
- DISPLAY DEVICE SETTINGS
- FUNCTION SETUP

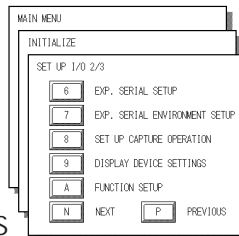

SET UP I/O 3/3

- COMMUNICATION PORT SETUP

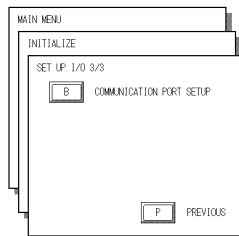

SETUP OPERATION SURROUNDINGS¹

- SETUP OPERATION SURROUNDINGS
- STATION SETUP
- CUSTOMIZE SETUP

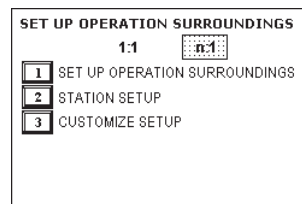

INITIALIZE MEMORY

- INITIALIZE MEMORY
- INITIALIZE CF CARD
- CSV DATA INDEX

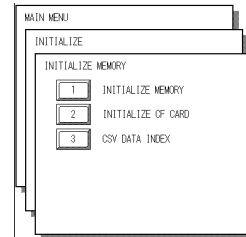

SET UP TIME

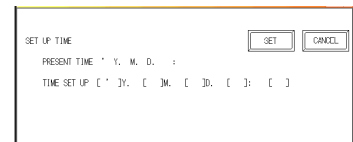

SET UP SCREEN

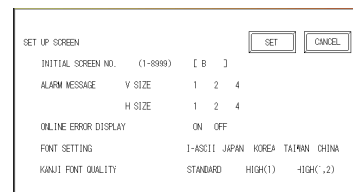

1. Depending on the Device/PLC type selected, the screens that appear in your GP unit's screen creation software will vary.

7.3 SYSTEM ENVIRONMENT SETUP

Adjustments to the GP2000H Series unit operation environment are made within the setup screens contained in the SYSTEM ENVIRONMENT SETUP menu. This menu includes the SYSTEM SETUP, SYSTEM AREA SETUP, GLOBAL WINDOW SETUP, and CHARACTER STRING DATA SETUP screens.

7.3.1 SYSTEM SETUP

SYSTEM SETUP		SET	CANCEL
STANDBY MODE TIME (0-255)	[]	MINUTE	
START TIME (0-255)	[]	SECOND	
TOUCH BUZZER SOUND	ON	OFF	
BUZZER TERMINAL OUTPUT	ON	OFF	
PASSWORD (0-9999)	[]		
DATA TYPE OF SCREEN NO.	BIN	BCD	

STANDBY MODE TIME (0–255)

To protect the GP unit's display screen, a screen saver function automatically turns the unit's backlight(s) OFF when no operations have occurred within a specified period of time. No screen saver will be used when **0** is entered in this field.

When the SYSTEM AREA SETUP screen's SCREEN DISPLAY OFF*¹ data is set to **0000h**, the GP unit's current display data will clear if the following operations are not performed within the user-specified period of time:

- Change Screen
- Touch Screen
- Alarm Display (Scrolling display)
- Menu Bar (Forced Reset screen)
- Japanese FEP System Window

START TIME (0–255)

Use this setting item to specify the GP unit's startup time — or to adjust the powering-up sequence — so that the GP unit starts up *after* the PLCs start.

TOUCH BUZZER SOUND

This setting item indicates, with a buzzing sound, that the GP unit has been touched.

BUZZER TERMINAL OUTPUT

The GP-2401HT (TFT Color) unit does not support this feature.

1. When using the Direct Access format, the object address becomes LS0009. When using the Memory Link format, the object address becomes +12. (Only when all items are set within the System Data Area.)

Reference Refer to the GP-PRO/PBIII for Windows Device / PLC Connection Manual (included with the GP screen creation software).

Chapter 7 – Initializing the GP-2401H

PASSWORD SETUP

The password setting item is used when the GP unit switches to the INITIALIZE MEMORY or INITIALIZE (OFFLINE Mode) screens. The password — a number between **0** and **9999** — is a security feature within the OFFLINE Mode, to protect the GP unit settings. The default password is **1101**. When no password has been set, the value is **0**.

Reference For details about entering numerical password values, see 5.3 – “INITIALIZATION.”

DATA TYPE OF SCREEN NO.

This setting specifies whether BIN or BCD format numbers are used when making screen changes.

7.3.2 SYSTEM AREA SETUP

The System Data Area is the LS Area inside the GP unit, and the PLC uses the System Data Area to control its GP-related data. The Data Register (D) or Data Memory (DM) area is set up in the PLC.

When the GP uses Memory Link format, this setting is unnecessary.

Reference Refer to the GP-PRO/PBIII for Windows Device / PLC Connection Manual (included with the GP screen creation software)

Touch the number of the desired item. The selected item’s display will be reversed.

When you press the CONFIRM key, the SYSTEM AREA CONTENTS screen is displayed to confirm the selected items.

SYSTEM AREA SETUP		CONFIRM	CANCEL
1	CURRENT SCREEN NO. (1 WORD)	8	CLOCK DATA (SET) (4 WORDS)
2	ERROR STATUS (1 WORD)	9	CONTROL (1 WORD)
3	CLOCK DATA (CURRENT) (4 WORDS)	A	RESERVED (1 WORD)
4	STATUS (1 WORD)	B	WINDOW CONTROL (1 WORD)
5	RESERVED (1 WORD)	C	WINDOW REG. NO. (1 WORD)
6	CHANGE SCREEN NO. (1 WORD)	D	WINDOW LOCATION (2 WORDS)
7	DISPLAY ON/OFF (1 WORD)	SYSTEM AREA SIZE: WORD(S)	

(Item numbers displayed in reverse mode are selected.)

System Area Size _____

◆ System Area Size

This field displays the total number of words used for the items selected from the SYSTEM AREA SETUP (**Write:** from 1 to 5 and **Read:** from 6 to D).



Note:

- The System Area settings are enabled only when using Direct Access format.
- The selected System Area items, as displayed on the screen, become the System Data Area.

Chapter 7 – Initializing the GP-2401H

GLOBAL WINDOW

Two options are available: USE and DO NOT USE. If you select DO NOT USE, ignore the items described below. Selecting USE enables the following options.

GLOBAL WINDOW ACCESS

Use this feature to designate whether values used by the GP unit (such as the REGISTRATION NO. and the LOCATION values) are DIRECT or INDIRECT. When set as DIRECT, the REGISTRATION NO. and LOCATION selections are fixed to the values entered here. When set to INDIRECT, the WINDOW REG. NO.'s word address is used by the SYSTEM AREA as a variable. This means the REGISTRATION NO. written to it changes and, as a result, can call up multiple window screens as Global windows. You can also use this method to adjust the Global Window's position by writing the desired (X,Y) coordinates to the SYSTEM AREA's LOCATION word addresses.

DATA FORMAT

Set up the REGISTRATION NO. and the LOCATION values as either BIN or BCD values. This field is related only to INDIRECT values.

REGISTRATION NO. (1-256)

Enter the Window Screen Number used by the Global Window. This field is enabled only when GLOBAL WINDOW ACCESS is set to DIRECT.

WINDOW LOCATION

Enter the value used for the (Global Window) LOCATION. This field is enabled only when GLOBAL WINDOW ACCESS is set to DIRECT.

7.3.4 CHARACTER STRING DATA SETUP

Character String Data ordering varies from manufacturer to manufacturer. Set up the Character String Data order to match that of the corresponding PLC.

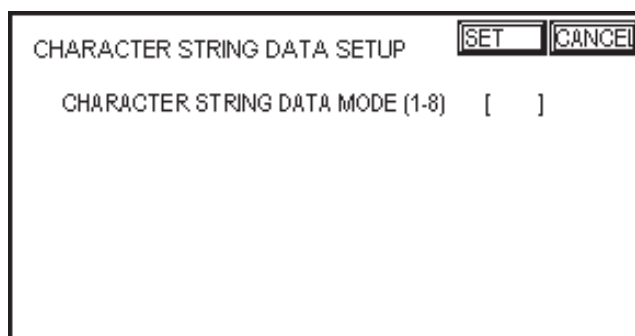

CHARACTER STRING DATA SETUP [SET] [CANCEL]

CHARACTER STRING DATA MODE (1-8) []



Set up the CHARACTER STRING DATA MODE to match that of the corresponding PLC. Device type and Tag settings are not available for setup.

Chapter 7 – Initializing the GP-2401H

CHARACTER STRING DATA MODE (1-8)

Set up the CHARACTER STRING DATA MODE that corresponds to that of your PLC, as specified in the following table.

- (I) Data Device Storage Order
- (II) Byte Storage Order (LH/HL), using single words
- (III) Word Storage Order (LH/HL), using double words

CHARACTER STRING DATA MODE (1-8) List

(I) Data Device Storage Order	(II) Byte Storage Order (LH/HL), using single word	(III) Word Storage Order (LH/HL), using double words	Character String Data Mode
Storage from Start Data	LH order	LH order	4
		HL order	2
	HL order	LH order	5
		HL order	1
Storage from End Data	LH order	LH order	6
		HL order	7
	HL order	LH order	8
		HL order	3

I. Data Device Storage Order

Example characters: A B C D E F G H
 ① ② ③ ④

• Storage from Start Data

①	D100
②	D101
③	D102
④	D103

• Storage from End Data

④	D100
③	D101
②	D102
①	D103

II. Byte Storage Order (LH/HL), using Single Words

Example characters: A B C D
 ① ② ③ ④

• 16-bit Device LH Order

②	①	D100
④	③	D101

• 16-bit Device HL Order

①	②	D100
③	④	D101

• 32-bit Device LH Order

②	①	④	③	D100
---	---	---	---	------

• 32-bit Device HL Order

①	②	③	④	D100
---	---	---	---	------

Chapter 7 – Initializing the GP-2401H

III. Word Storage Order (LH/HL), using Double Words

Example characters: A B C D E F G H I J
 └─┘ └─┘ └─┘ └─┘ └─┘
 ① ② ③ ④ ⑤

- **16-bit Device LH Order**

②	D100
①	D101
④	D102
③	D103
⑤	D104

- **16-bit Device HL Order**

①	D100
②	D101
③	D102
④	D103
⑤	D104

Example characters: A B C D E F G H I J K L M N O P Q R S T
 └─┘ └─┘ └─┘ └─┘ └─┘ └─┘ └─┘ └─┘ └─┘ └─┘
 ① ② ③ ④ ⑤ ⑥ ⑦ ⑧ ⑨ ⑩

- **32-bit Device LH Order**

②	①	D100
④	③	D101
⑥	⑤	D102
⑧	⑦	D103
⑩	⑨	D104

- **32-bit Device HL Order**

①	②	D100
③	④	D101
⑤	⑥	D102
⑦	⑧	D103
⑨	⑩	D104

Relationship between K-tag Write Character Value and the PLC Device

- ◆ **16-bit Devices**

The GP unit stores the character string in one internal device, in groups of two, starting with the first pair of characters.

When nine characters make up a string, they are arranged as follows:

1 2 3 4 5 6 7 8 9 NULL
 └─┘ └─┘ └─┘ └─┘ └─┘



Note: When the characters do not divide evenly by two, NULL is added to the last character to make up the final pair and complete the string.

- ◆ **32-bit Devices**

The GP unit stores the character string in one internal device address, in groups of four, starting with the first group of characters.

When there are nine characters, they are arranged as follows:

1 2 3 4 5 6 7 8 9 NULL
 └─┘ └─┘ └─┘



Note: When the characters do not divide evenly by four, NULL is added to the last character to make up the final group and complete the string.

7.4 SET UP I/O

This section describes the communication setup with the host (PLC) and the configuration for any peripheral equipment. Following are the SET UP I/O menu screens.

7.4.1 SET UP SIO

This screen controls the settings related to communication with the PLCs.

Be sure to match the settings listed below with the SIO setup on the host (PLC). Otherwise, an error may occur.

Reference  Refer to the *GP-PRO/PBIII for Windows Device / PLC Connection Manual* (included with the GP screen creation software).

SET UP SIO		SET	CANCEL
COMMUNICATION RATE	2400 4800 9600 19200 38400 57600 115200		
DATA LENGTH	7 8		
STOP BIT	1 2		
PARITY	OFF ODD EVEN		
CONTROL	X-CNTRL ER-CNTRL		
COMMUNICATION FORMAT	RS232C 4 LINE 2 LINE		

(Some PLCs may not be able to communicate at 57600 or 115200bps.)



If you have selected "YES" for the [SERIAL I/F CHANGE] on the [COMMUNICATION PORT SETUP] screen, or "Yes" for the [Serial I/F Switch] settings in the [Change Extend SIO Type] command, in the GP Screen Editor's [Project] menu, do not enter all of the settings related to device communication using the Extended SIO Script Protocol here. ([SET UP SIO] screen) These settings are required to set using the [EXPANSION SERIAL COMMUNICATION SETUP] screen.

COMMUNICATION RATE

The COMMUNICATION RATE (baud rate) is the data communication speed, measured in bits per second (bps), between the GP unit and the PLC. Match both the PLC and the GP units' COMMUNICATION RATE values. Depending on the rate selected, you may not be able to use certain PLCs.

Reference  Refer to the *GP-PRO/PBIII for Windows Device / PLC Connection Manual* (included with the GP screen creation software).

DATA LENGTH / STOP BIT

For data communication, use the following settings:

- DATA LENGTH: 7 or 8 bits
- STOP BIT: 1 or 2 bits

PARITY

Use this setting to specify whether an ODD or EVEN number parity check, or none at all (OFF), will take place during communication.

CONTROL

The CONTROL setting prevents the overflow of data transmitted and received. Select either the XON/XOFF or the ER (DTR) control.

Chapter 7 – Initializing the GP-2401H

COMMUNICATION FORMAT

Select one of the following options for the COMMUNICATION FORMAT setting:

- RS-232C
- RS-422 (4-line)
- RS-422 (2-line)



Note: When using an RS-422 cable and the Memory Link format, be sure to select the 4-line option.

Reference Refer to the *GP-PRO/PBIII for Windows Device / PLC Connection Manual* (included with the GP screen creation software).

7.4.2 SET UP PRINTER

This function is not supported by the GP-2401H Series units. Return to the previous screen by touching the CANCEL key.

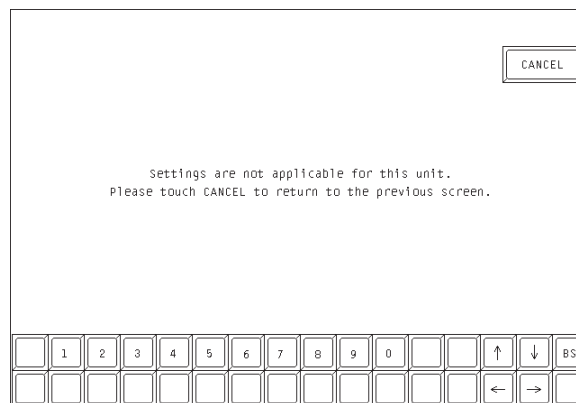

7.4.3 SET UP TOUCH PANEL

Set up the touch panel's TOUCH OPERATION and FORCE RESET modes, and adjust the Display Device settings in this screen. Depending on the GP type, these settings may vary.

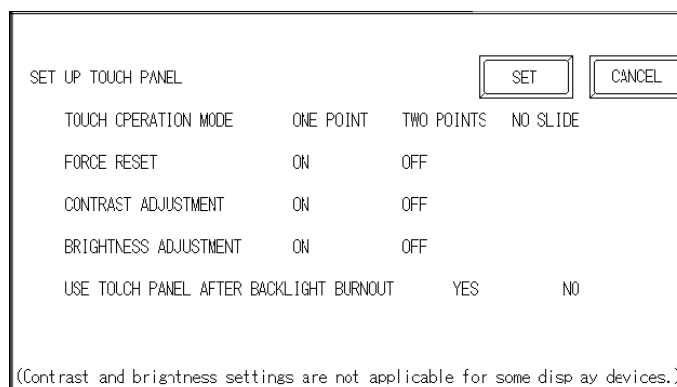

TOUCH OPERATION MODE

Designates ONE POINT, TWO POINTS, or NO SLIDE. When NO SLIDE is selected, the screen will NOT respond to one's finger dragging across the touch screen. Only individually-selected points will register.

Chapter 7 – Initializing the GP-2401H

FORCE RESET MODE

Enables or disables the display of the FORCE RESET screen's menu bar. When set to ON, the menu bar will display.

◆ To Perform FORCE RESET

To enter the FORCE RESET mode (see following image), press the bottom-right corner of the screen (position 1), and then touch the top-right and bottom-left corners (positions 2 and 3).

To activate RESET, touch the RESET button. To change to OFFLINE Mode, touch OFFLINE.

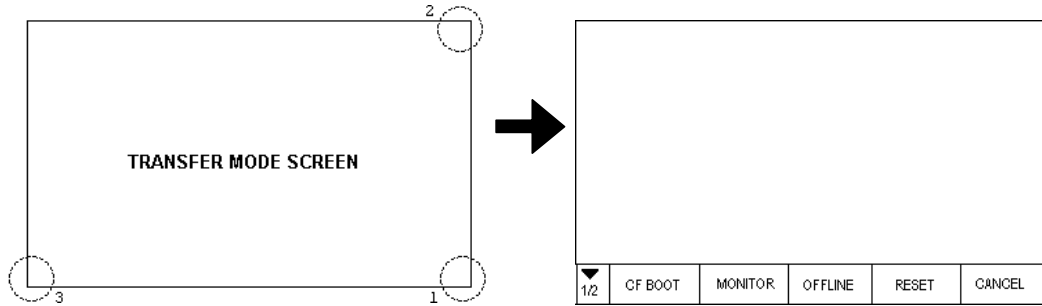

You can perform FORCE RESET in either RUN mode or OFFLINE Mode.



- The menu bar will not display when the GP unit is starting up.
- Entering FORCE RESET is possible even when the PLC and the GP unit are not communicating.

CONTRAST ADJUSTMENT

This setting is not supported by the GP-2401HT (TFT color) unit.

BRIGHTNESS ADJUSTMENT

When BRIGHTNESS ADJUSTMENT is set to ON, you can adjust the brightness by touching the GP unit's screen. To enter BRIGHTNESS ADJUSTMENT mode, press the bottom-right corner (position 1) of the screen (A), and then touch the bottom-left corner (2). When the BRIGHTNESS ADJUSTMENT screen (B) appears, touch the left side of the bar to brighten the display, and touch the right side to darken the display. Four levels of adjustment are available with this unit.

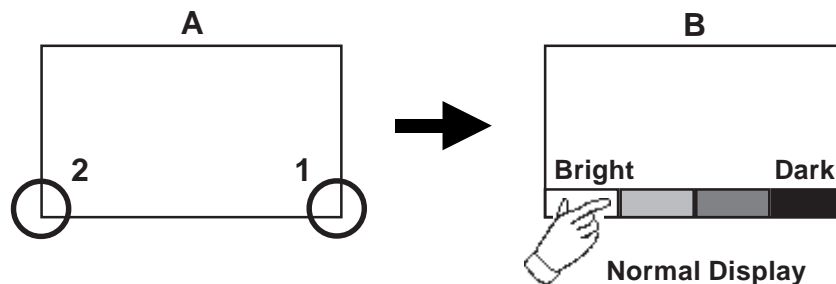

Chapter 7 – Initializing the GP-2401H



Note:

- To exit the BRIGHTNESS ADJUSTMENT mode, touch anywhere above the BRIGHTNESS ADJUSTMENT bar.
- You cannot enter the BRIGHTNESS ADJUSTMENT mode while the GP unit is starting up.
- BRIGHTNESS ADJUSTMENT can be made during RUN mode (PLC \longleftrightarrow GP unit communication).
- Regardless of the display (normal or reversed), the left side of the BRIGHTNESS ADJUSTMENT menu bar, displayed at the bottom area of the screen, is always Bright.
- One of the characteristics of the display device is that, once it is plugged into the power source, it takes some time to reach the maximum practical brightness. At room temperature, the display device takes about 10 minutes to reach 70% of its maximum brightness.

SET UP LCD

This setting is not supported by the GP-2401HT (TFT Color) unit.

USE TOUCH PANEL AFTER BACKLIGHT BURNOUT

This item allows the user to enable [ON] or disable [OFF] the touch operation when the backlight burns out. Setting this item to OFF prevents the GP unit from sending input signals to the PLC.



Note:

When the Backlight Burns Out:

- The Status LED's orange light will turn ON.
- The System Data Area's Status bit 10*1 will turn ON.
- If the FORCE RESET item is set to ON, only FORCE RESET can still be performed by touch operation. (Although the screen is pitch-black and cannot be seen, touch-panel operation can be performed in the FORCE RESET screen.)
- If the GP unit is in OFFLINE Mode, the touch-panel operation will become enabled, regardless of the settings.



Normally, the unit detects backlight burnout by monitoring the current. However, depending on the problem with the backlight, the unit may fail to detect this condition, or the unit may detect this condition before backlight burnout.

-
1. Bit +6 (when using the Direct Access method), and bit +11 (when using the Memory Link method), will turn ON.

Reference  Refer to the GP-PRO/PBIII for Windows Device / PLC Connection Manual (included in the GP screen creation software).

7.4.4 COMMUNICATION SETUP

This section explains how to use the REPLY command to deal with errors, including those that occur during GP and PLC communication.

COMMUNICATION SETUP		SET	CANCEL
RECEIVE TIMEOUT (1-127)	[]	SECOND	
RETRY COUNT (0-255)	[]		

RECEIVE TIMEOUT (1–127)

Use a numeric value to set a period of time in which the GP unit receives data from the PLC. If the cable is not connected, data communication will Timeout after one second, regardless of this setting's value.

The default value for the RECEIVE TIMEOUT setting is 10 seconds.



An error message may appear on your personal computer if:

- You transfer screens from your PC to the GP unit after a PLC communication error has occurred and the error is not yet cleared.
- Your GP unit's RECEIVE TIMEOUT value is set to 30 seconds or more.

RETRY COUNT (0–255)

Use this setting item to designate the number of times the GP unit tries to send data to the PLC when a PLC communication error occurs. After the GP unit's specified number of attempts has failed to send data to the PLC, an error message will appear on the GP.

The default value for the RETRY COUNT setting is **2**.

7.4.5 SOUND SETTINGS

These settings are not supported by the GP2401HT unit. Return to the previous screen by touching CANCEL.

Settings are not applicable for this unit.
Please touch CANCEL to return to the previous screen.

Chapter 7 – Initializing the GP-2401H

7.4.6 EXPANSION SERIAL COMMUNICATION SETUP

Since GP-2401H Series unit is not equipped with an expansion serial I/F. If you have selected the [NO] for the [SERIAL I/F CHANGE] on the [COMMUNICATION PORT SETUP] screen, or "No" for the [Serial I/F Switch] settings in the GP Screen Editor (when not using the Extended SIO Script Protocol for communication), the expansion serial communication setup is not required.



- If you have selected "YES" for the [SERIAL I/F CHANGE] on the [COMMUNICATION PORT SETUP] screen, or "Yes" for the [Serial I/F Switch] settings [Change Extend SIO Type] command, in the GP Screen Editor' [Project] menu, enter all of the settings related to device communication using the Extended SIO Script Protocol here, [EXPANSION SERIAL COMMUNICATION SETUP] screen. Then, the settings on the [SET UP SIO] screen will be disabled.

EXP. SERIAL SETUP

COMMUNICATION RATE 2400 4800 **9600** 19200 38400

DATA LENGTH 7 **8**

STOP BIT **1** 2

PARITY **OFF** ODD EVEN

RI/VCC (COM2) **X1** VCC

COMMUNICATION FORMAT **RS232C** 4 LINE 2 LINE

([RI/VCC (COM2)] is not related to setup of [SERIAL I/F CHANGE].)

1 2 3 4 5 6 7 8 9 0 ↑ ↓ BS

← →

COMMUNICATION RATE

The COMMUNICATION RATE (baud rate) is the data communication speed, measured in bits per second (bps), between the GP and the Devices.

Reference *GP-PRO/PBIII for Windows Device/PLC Connection Manual*

DATA LENGTH/STOP BIT

For data communication, the DATA LENGTH must be set up as 7-bit or 8-bit data. Also, the STOP BIT must be designated as either a 1-bit or 2-bit value.

PARITY

Set up whether no parity check, or an odd or even number parity check will be performed during communication.

RI/VCC (COM2)

GP-2401H Series unit has no expansion interface. This setting will be disabled.

COMMUNICATION FORMAT

Select one of the following options for the communication format: RS-232C, RS-422 (4 line), or RS-422 (2 line).

7.4.7 EXPANSION SERIAL ENVIRONMENT SETUP

Since GP-2401H Series unit is not equipped with an expansion serial I/F, the expansion serial environment setup is not required.

7.4.8 SET UP CAPTURE OPERATION

Save the captured image of the GP unit's screen as a JPEG file in the CF Card.

Reference Refer to the GP-PRO/PBIII for Windows Tag Reference Manual, 4.7.10 – “Screen Capture” (included in the GP screen creation software).

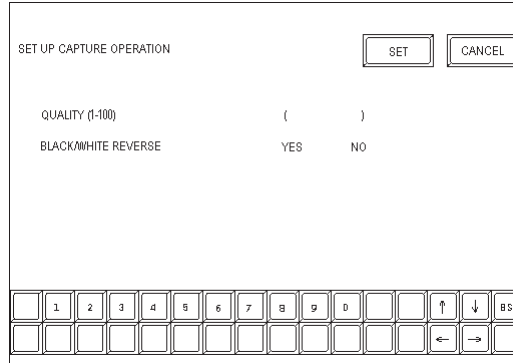

QUALITY (1–100)

Sets the captured image quality. The image quality can be set from 1 to 100. 100 is the highest quality.

BLACK/WHITE REVERSE

The white portion of the image that is created in the screen creation program is reversed to black, and the black portion is reversed to white. This reversed white-and-black image can be captured and saved.



Note: Only black and white colors are reversed.

◆ GP2401-HT (TFT Color LCD)

The Color LCD GP captures a B/W reverse image and saves it to the CF Card. The white portion of the image is converted to black, and the black portion of the image is converted to white. Only black and white colors are converted.

7.4.9 SET UP DISPLAY DEVICE

This setting is not supported by the GP-2401HT unit. Return to the previous screen by touching the CANCEL button.

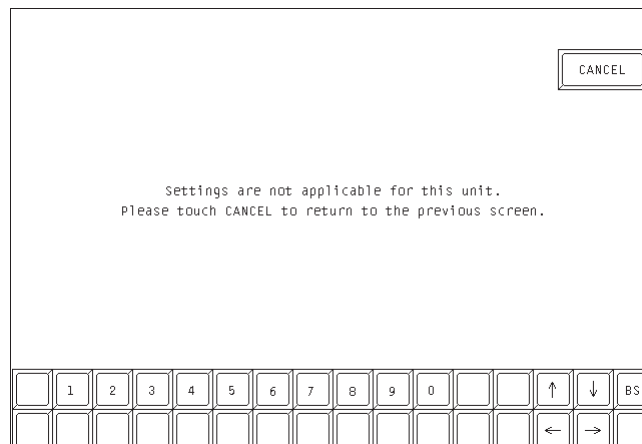

Chapter 7 – Initializing the GP-2401H

7.4.10 FUNCTION SETUP

This setting allows the user to ENABLE or DISABLE the operation switch. Activate the OPERATION SWITCH function by touching the OPERATION SWITCH setting or the ENABLE/DISABLE display area, and touch SET to confirm. The default value is set to DISABLE.

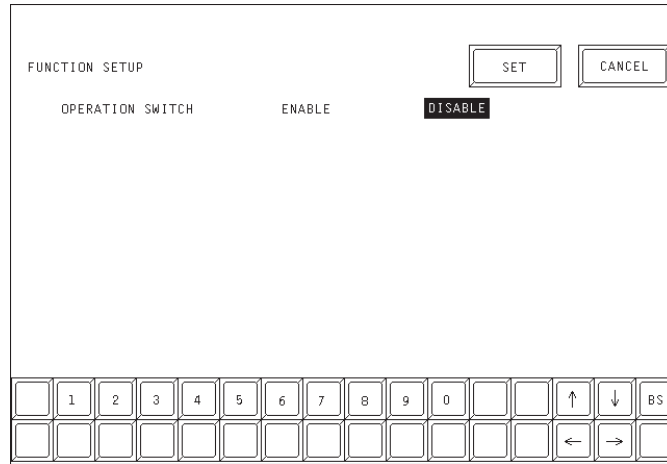

7.4.11 COMMUNICATION PORT SETUP

This screen allows you to set up the connection environment of the GP's communication port (COM1).

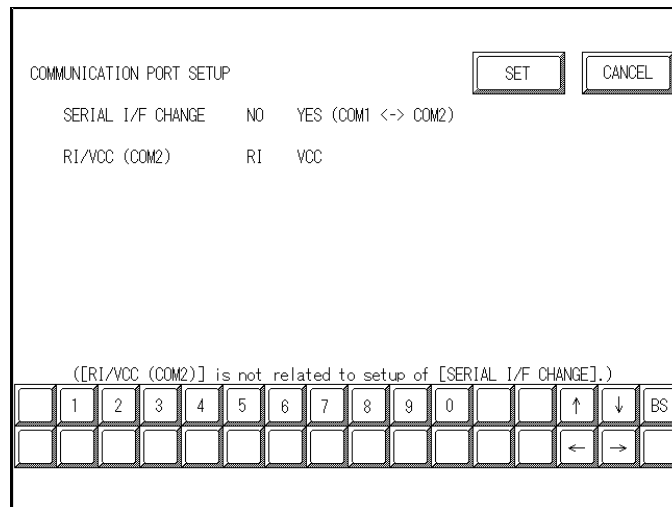

SERIAL I/F CHANGE

Selecting "YES (COM1 <->COM2)" designates that the communication used for the Extended SIO Script Protocol starts at the Serial I/F (COM1).

In OFFLINE mode, the SERIAL I/F CHANGE setting is set to "NO".



After selecting "YES (COM1 <->COM2)", enter all of the settings related to device communication using the Extended SIO Script Protocol, [EXPANSION SERIAL COMMUNICATION SETUP] screen. The settings on the [SET UP SIO] screen will be disabled. **Reference** 7.4.6 EXPANSION SERIAL COMMUNICATION SETUP

RI/VCC (COM2)

Since GP-2401H Series units have no expansion interface, this setting will be disabled.

7.5 PLC SETUP

Set up the GP unit's SYSTEM AREA and the UNIT NUMBER in this screen. Because **1:1** and **n:1** GP connections use different settings, confirm your connection requirements before using any settings. The following assumes that the Direct Access format is used.



Note:

- The screens that appear depend on the PLC type you selected in the GP screen creation software.

Reference *Refer to the GP-PRO/PBIII for Windows Device / PLC Connection Manual (included in the GP screen creation software).*

- When the GP-PRO/PBIII for Windows Simulation feature is used, the OPERATION SURROUNDINGS menu cannot be used.

Chapter 7 – Initializing the GP-2401H

7.5.1 SET UP OPERATION SURROUNDINGS (1:1/n:1)

Enter the PLC SYSTEM DATA AREA and the UNIT NUMBER settings in this screen. The same options are available for both **1:1** and **n:1** (multi-link) connections.

For an **n:1** (multi-link) connection, SYSTEM DATA AREA settings must be set up for each GP unit connected to the PLC.

Reference Refer to the *GP-PRO/PBIII for Windows Device / PLC Connection Manual* (included in the GP screen creation software).

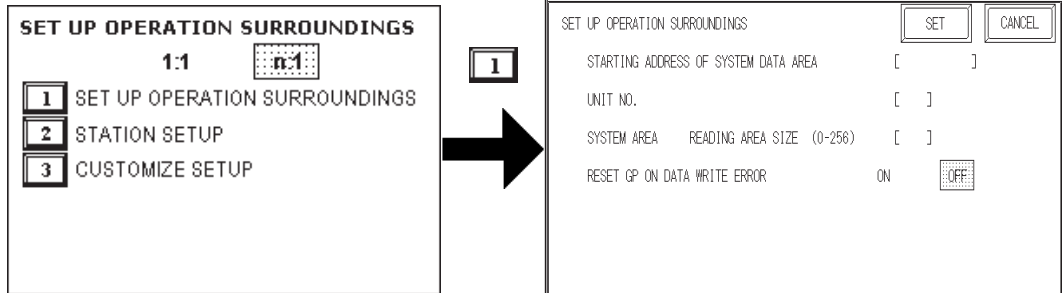

STARTING ADDRESS OF SYSTEM DATA AREA

Set up the SYSTEM DATA AREA's START ADDRESS. The DEVICE ADDRESS(es) that can be allocated will differ depending on the type of PLC used.

Refer to the GP-PRO/PBIII for Windows Device / PLC Connection Manual (included in the GP screen creation software).

UNIT NO.

Enter the PLC UNIT NUMBER in this setting. Make sure that it matches the PLC's unit number setting.

SYSTEM AREA – READING AREA SIZE

When using a Block Display Trend Graph, set up the READING AREA SIZE (in word units) to match the Trend Graph's data size. Use this feature when you wish to allocate the READING AREA in the PLC Data Register (D), or Data Memory (DM).



Note:

If you are not using the READING AREA, leave the default values that are set to **0** intact, to allow high-speed data communication performance.

RESET GP ON DATA WRITE ERROR

Designates the mode that enables you to cancel the error from the error display when the Write error occurs.

7.5.2 STATION SETUP (n:1)

STATION SETUP, required with an **n:1** (multi-link) setup, checks whether data communication is being performed correctly between the GP unit and the PLC.

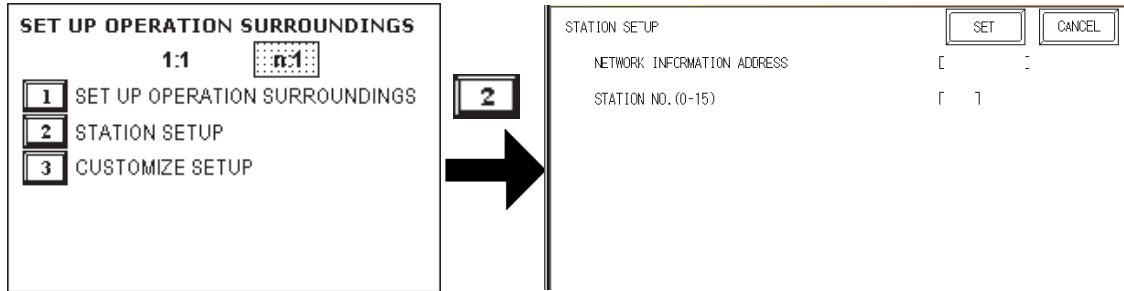

NETWORK INFORMATION ADDRESS

With an **n:1** (multi-link) connection, the NETWORK INFORMATION setting uses two (2) words — a Connection List and a Validation List (described in this section) — for its data. These areas are allocated in the PLC unit’s Data Register (D) or Data Memory (DM). Addresses that can be allocated will differ, depending on the PLC type.

Reference Refer to the *GP-PRO/PBIII for Windows Device / PLC Connection Manual* (included in the GP screen creation software).

PLC Data Register

+0	Connection List	PLC→GP
+1	Validation List	GP→PLC



In the NETWORK INFORMATION ADDRESS settings, set up the same address to all the GP units connected to the same link unit. Also, when the link unit has two ports, be sure they do NOT use the same address.

◆ Connection List

The word address for the Connection List sets the number of GP units connected to the PLC, which must have been entered previously in the PLC. When these GP units are connected to the PLC, the corresponding PLC bit number for each GP Station turns ON (see below).



When the GP unit is connected to the PLC, and the option of GP-only correspondence ends and OFFLINE Mode is entered, the GP Station Number then turns the corresponding PLC bit OFF.



Chapter 7 – Initializing the GP-2401H

For example, when four GP units — bits 0, 2, 3, and 5 — are connected, **002D (h)** is written.

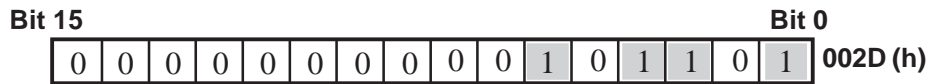

- **Be certain to set up this data before running.**
- **Turn OFF all bits that are not related to the GP unit.**

◆ Validation List

This area responds to communication from each connected GP unit. In the Validation List, when the same bit numbers as the Connection List turn ON, the communication is accepted. The Station Numbers of the communicating GP units turn their corresponding PLC bit number ON.

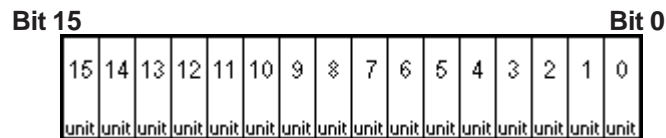

If the communication between the GP unit and the PLC is correct, the same value in the Connection List is written to the Validation List.

For example, the value **002D (h)**, set up in the Connection List as Bit 0, Bit 2, Bit 3, and Bit 5, will be written to the Validation List.

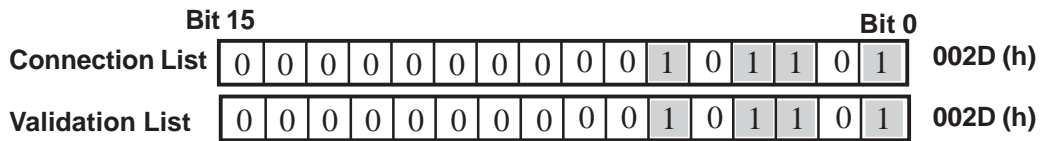

- **When the Connection List and Validation List do not match, a COMMUNICATION ERROR occurs. Check the setup again.**
- **When changing the connection, first turn all the bits OFF.**

STATION NO. (0–15)

This is the setup for the GP Station Number mentioned above. The setup range is 0 to 15, and the only other restriction is that the GP STATION NO. must be unique in the system. If the same STATION NO. is used on multiple GP units, a COMMUNICATION ERROR will occur.



The STATION NO. is the number allocated to a particular GP unit. This number is not related to the Link Unit Machine number.

7.5.3 CUSTOMIZE SETUP (n:1)

The CUSTOMIZE function modifies the n:1 (multi-link) connection's communication method to maximize its efficiency. To perform GP ↔ PLC communication efficiently, the user should first determine whether OPERATION or DISPLAY will be the priority set for the GP unit. Based on this, the communication response speed can be upgraded. (However, this also depends on the complexity of the screen information displayed.)

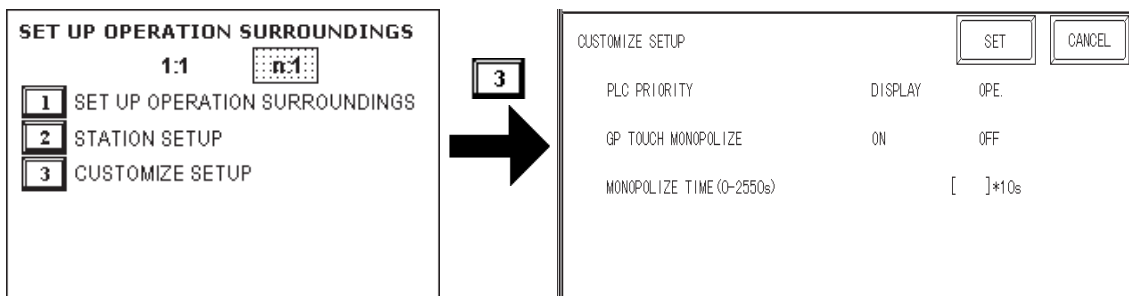

PLC PRIORITY

Depending on how the GP2000H unit is used, select either OPERATION priority (OPE.) or DISPLAY priority (DISPLAY).

◆ DISPLAY

Set up the GP unit to this option when using the GP mainly as a monitor screen. The GP will command a higher display speed as a result. However, the response time for the touch panel's operations will slow.

◆ OPERATION

Set up the GP unit to this option when using the GP mainly as a monitor screen. The touch panel's numeric value input or switch function response speed will become higher as a result.

When OPE. is selected, the response time for the touch panel's operation is not likely to be affected by the number of GP units. However, the display refresh cycle time will be slower.



- In a standard network setup, use the same settings for all connected GP units.
- To increase the display speed, be sure the addresses used are consecutive addresses. When bit addresses are used, use addresses that are consecutive to word units.

Chapter 7 – Initializing the GP-2401H

◆ Speed Difference between DISPLAY Priority and OPERATION Priority

When using the Mitsubishi Electric Corporation A3A PLC, with consecutive addresses (80 words, not including the SYSTEM AREA), the difference in reading speed is as shown in the following graphs.

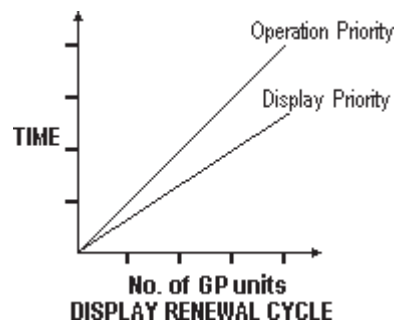
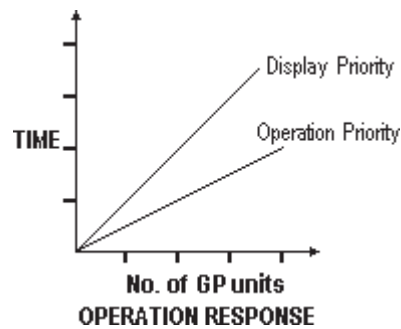

GP TOUCH MONOPOLIZE

Touch panel monopolization can be turned ON or OFF via this screen. For example, when you want to use the PLC exclusively with a momentary-type switch from the touch panel, set the GP TOUCH MONOPOLIZE setting to ON.

When this setting is ON, the touch panel uses the PLC exclusively whenever the momentary switch is pressed. This allows you to use a touch panel switch for unit inching operations. Exclusive use ends when you stop pressing the panel.

Reference Refer to the *GP-PRO/PBIII for Windows Device / PLC Connection Manual* (included in the GP screen creation software).

MONOPOLIZE TIME (0–2550s)

Set Bit 7 of the System Data Area LS14 to ON, to set monopolizing time.

This field controls the length of time for the monopolize process when no other touch panel operations are performed. The monopolization process ends when the time set here elapses, and Bit 7 of word address LS14 turns OFF.

After cancelling GP TOUCH MONOPOLIZE, it will return to **n:1** (multi-link) communication.



Note:

- Pressing the touch panel in the middle of the monopolize process interrupts the MONOPOLIZE TIME function, and ends exclusive use.
- When MONOPOLIZE TIME is set to 0, the monopolize function does not end automatically.

Reference For further information about the contents of System Data Area LS6 (status) and LS14 (control), refer to the *GP-PRO/PBIII for Windows Device / PLC Connection Manual* (included with the GP screen creation software).

7.6 INITIALIZE INTERNAL MEMORY

This section explains how to initialize the GP unit’s internal memory (screen data), or how to initialize a CF Card inserted in the GP. Select either the INITIALIZE MEMORY item or the INITIALIZE CF CARD item in the INITIALIZE MEMORY menu.

7.6.1 INITIALIZE GP MEMORY

This will erase all GP screen data (internal memory). Backup SRAM will also be initialized.

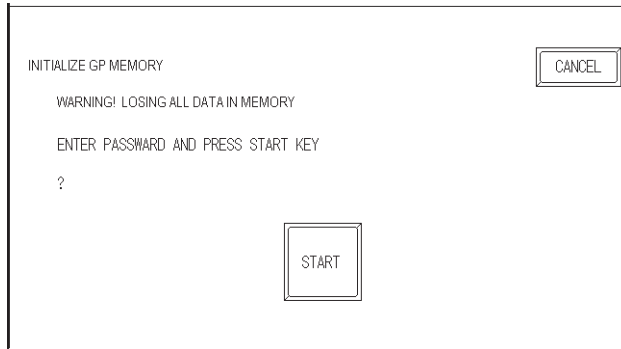

- **You cannot cancel the initialization procedure after pressing START. Do NOT turn the power off when initializing.**
- **All data in SRAM will be erased.**
- **Initialization does not erase the SYSTEM SETUP, the SIO protocol, or the internal clock settings.**

To initialize the GP unit’s internal memory, enter the default password, **1101**, or the password entered in the SYSTEM SETUP screen.

Reference See 5.3 – “INITIALIZATION.”



The time required for initialization is between 10 and 20 seconds.

7.6.2 INITIALIZE CF CARD

CF Card initialization deletes all CF Card data installed in the GP unit.



Initialization cannot be cancelled once the START switch is touched.

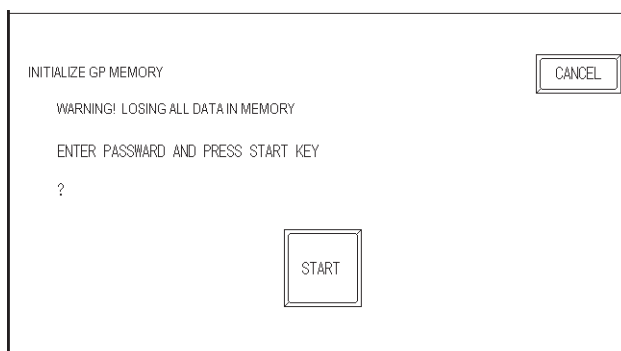

To initialize the CF Card, enter the default password, **1101**, or the password entered in the SYSTEM SETUP menu.

Reference For details about entering the password’s numeric values, see 5.3 – “INITIALIZATION.”

Chapter 7 – Initializing the GP-2401H

7.6.3 CSV DATA INDEX

Specific data-transfer CSV files (ZR*****.CSV) on the CF Card can be transferred from the CF Card directly to the PLC (filing) or from the PLC directly to the CF Card (logging). For the details about the CSV Data Transfer Function, [Reference GP-PRO/PB III for Windows Tag Reference Manual](#).

Here creates the index file of the CSV files that are saved into the CF card with the CSV data transfer function.

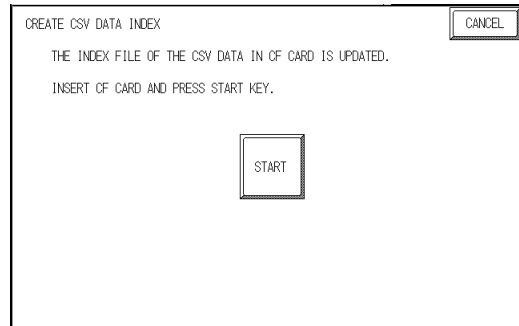

Touch the [START] key, then the operation to create the index file will start.



Do not open the CF card cover during the operation to create the index file. The data may be damaged.



Too many number of CSV files may cause a time loss for creating the index file. It will take about 10 minutes for creating an index file of the 4,000 CSV files.

If you touch the [CANCEL] key during the operation to create the index file, the operation will stop, then the following screen will appear.

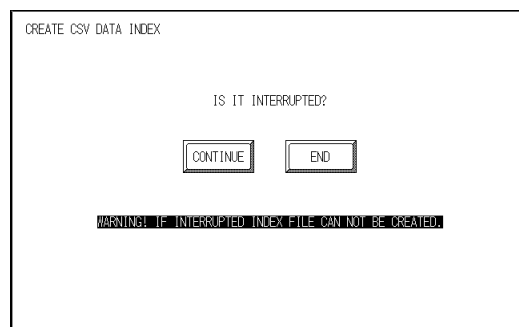

CONTINUE

The operation restarts. When the message "CREATED INDEX FILE. PLEASE PRESS END KEY" appears, finish the program.

END

Deletes the creating index file, then the [INITIALIZE MEMORY] screen will reappear.

7.7 SET UP TIME

Set the GP unit's internal clock in the SET UP TIME screen.

```

SET UP TIME
PRESENT TIME  Y. M. D.
TIME SET UP  [ ] Y. [ ] M. [ ] S.
SET CANCEL
  
```

SET UP TIME

Adjust the date and time display settings in the PRESENT TIME setting item.



- The GP unit's internal clock has a slight error in accuracy. At normal operating temperatures and conditions, with the GP unit operating from its lithium battery, the degree of error is ± 65 seconds per month. Variations in operating conditions and battery life can cause this error to vary from -380 to +90 seconds per month. For systems where this degree of error will be a problem, the user should monitor this error and make adjustments as necessary.
- The screen displays the Hour and Minute settings, but not the Seconds.
- Enter the last two digits of the Western calendar year.

7.8 SET UP SCREEN

Use this screen to enter the number of the screen that is initially displayed after startup, the character size when the GP2000H is in RUN mode, and other general screen items.

SET UP SCREEN		SET	CANCEL
INITIAL SCREEN NO.	(1-8999) [B]		
ALARM MESSAGE	V SIZE	1	2 4
	H SIZE	1	2 4
ONLINE ERROR DISPLAY	ON OFF		
FONT SETTING	I-ASCII JAPAN KOREA TAIWAN CHINA		
KANJI FONT QUALITY	STANDARD HIGH(1) HIGH(1,2)		

INITIAL SCREEN NO.

This setting item specifies the file number of the screen that initially displays on startup. If the BIN option was selected for DATA TYPE OF SCREEN NO in the SYSTEM SETUP screen, enter a number between 1 and 8999. If BCD was the setup option, enter a number between 1 and 1999.

ALARM MESSAGE

Use this setting item to set the character size for the ALARM MESSAGE, when activated by the Alarm Bulletin.

1

2

4

When using single-byte characters:

V size=1

H size=1

16×8 pixels

V size=2

H size=2

32×16 pixels

V size=4

H size=4

64×32 pixels

When using double-byte characters:

V size=1

H size=1

16×16 pixels

V size=2

H size=2

32×32 pixels

V size=4

H size=4

64×64 pixels

ONLINE ERROR DISPLAY

Use this item to set up the display of error messages during RUN mode.

7.9 FONT SETTING

FONT SETTING

Selects the font type displayed on the GP unit's screen during operation.

KANJI FONT QUALITY

Designates the font display quality for enlarged characters.

Differences in FONT SETTINGS

◆ When FONT SETTING is set to [JAPAN]

Single-byte characters will remain 8x16-dot characters when they are enlarged.

Double-byte characters are displayed as:

Standard Characters are displayed using 16x16-dot "blocks." When enlarged, this font will remain a 16x16-dot character.

HIGH When enlarged to double size, Level 1 JIS Kanji Code characters display as 32x32-dot characters. Level 2 JIS Kanji Code characters will remain 16x16-dot characters.

HIGH (1, 2) When enlarged to double size, both Level 1 and Level 2 JIS Kanji Code characters display as 32x32-dot characters.

◆ When FONT SETTING is set to any other type, such as [CHINA], [I-ASCII], [KOREA], or [TAIWAN]

Standard Half-sized (single-byte) characters display as 16x8-dot characters. Full-size characters, regardless of the display size used, always display as 16x16-dot characters. When enlarged, this font will remain a 16x16-dot character. (Compatible with GP-*30 Series units)

HIGH (1) All half-sized (single-byte) characters — ASCII code: 21h to 7Dh, or alphanumeric characters (except the ^ and ' characters) — display as high-quality characters.

- 16x16-dot characters or larger display as high-quality 16x16 fonts.
- 32x32-dot characters or larger display as high-quality 32x32 fonts.

Full-sized (double-byte) characters display as 16x16-dot characters, and remain 16x16-dot characters when enlarged.

HIGH (1, 2) All single-byte characters — ASCII code: 21h to 7Dh, or alphanumeric characters (except the ^ and ' characters) — display as high-quality characters.

- When 16x16 dots are used, the characters display as high-quality 16x16-dot characters.
- When 32x32 or larger-sized dots are used, the characters display as high-quality 32x32-dot characters.

Full-sized (double-byte) characters — [KOREA], [TAIWAN], and [CHINA] — display as 32x32-dot characters when enlarged to 32x32-dot characters or larger.

Memo

Chapter

8 RUN Mode and Errors

1. RUN Mode
2. SELF-DIAGNOSIS
3. Troubleshooting
4. Error Messages
5. Error Message Details

In this chapter, the GP-2301H Series unit's OFFLINE Mode is used in explanations for the reader's convenience only. There is no difference in function between the GP-2301H and the GP-2401H, unless otherwise noted.

8.1 RUN Mode

The GP unit enters RUN mode in two instances: either immediately after plugging in the unit's power cord, or from the GP unit's OFFLINE Mode.

8.1.1 After Connecting the Power Cord

The GP2000H unit's startup method depends on which START TIME setting is specified in the INITIALIZE menu's SYSTEM SETUP screen.

■ When START TIME is Set to "0"

When the GP unit's power cord is connected, the version information screen appears (see diagram, below). The screen designated by the INITIAL FILE NO. setting (within the INITIALIZE menu's SETUP SCREEN) appears, and then the GP unit starts to communicate with the PLC.

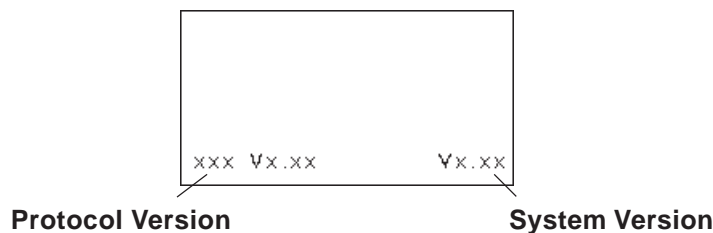

■ When START TIME is Set to Any Value Other than "0"

When the GP unit's power cord is connected, a value appears in the version information screen (below), which counts down the seconds designated by the START TIME setting. The screen designated by the INITIAL FILE NO. setting (within the INITIALIZE menu's SETUP SCREEN) appears, and then the GP unit starts to communicate with the PLC.

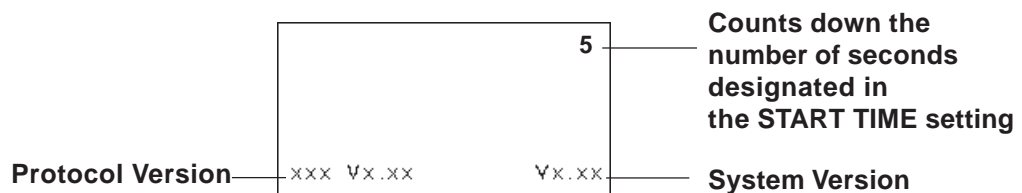

Chapter 8 – RUN Mode and Errors

If the initial screen's file number is not designated, or if a number that does not exist is designated, the version information screen remains displayed.



Note: Depending on the display device's startup time, it is possible that the screens (see diagrams, previous page) may not initially be displayed.

8.1.2 Via OFFLINE Mode

Touch the MAIN MENU's RUN option to start your downloaded project.

The INITIALIZE menu's SETUP SCREEN designates the screen that initially appears in RUN mode. After this first screen appears, communication with the PLC begins.

If, however, the initial screen has not been created, or does not exist, the version information screen (see diagram, previous page) remains displayed.

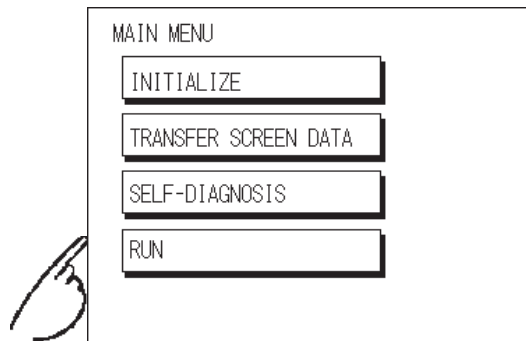

Note: To enter OFFLINE Mode, touch the top-left corner of the GP unit's screen within 10 seconds after connecting the GP unit's power cord.



- After powering up the GP unit, the initial screen appears. This screen is equipped with a built-in (invisible) switch in the top-left corner that, if touched within 10 seconds, can change the GP unit from RUN to OFFLINE Mode.
- The operation used to enter OFFLINE Mode can be disabled by removing the check mark from the OFFLINE Mode's top-left corner box in the GP Setup menu's I/O Settings screen — in the GP-PRO/PBIII for Windows screen creation software.

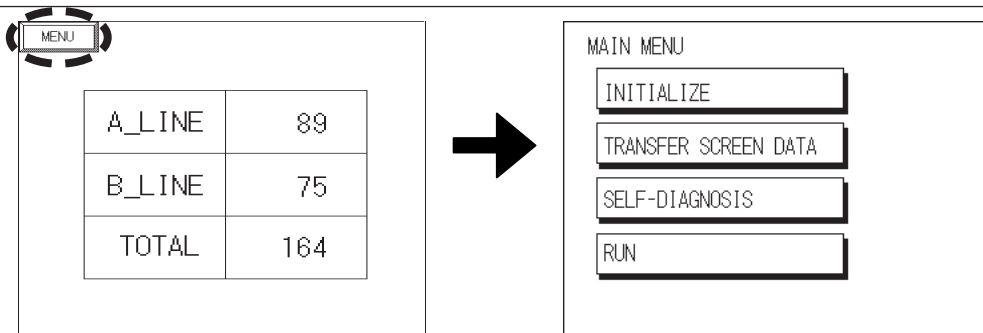

8.2 SELF-DIAGNOSIS

The GP2000H is equipped with a number of SELF-DIAGNOSIS features used to check its System and Interfaces for any problems.

8.2.1 SELF-DIAGNOSIS ITEM LIST

■ GP-2301H Series

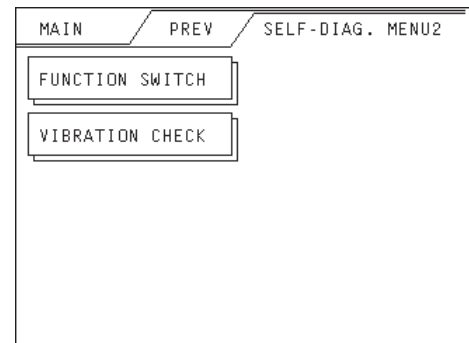
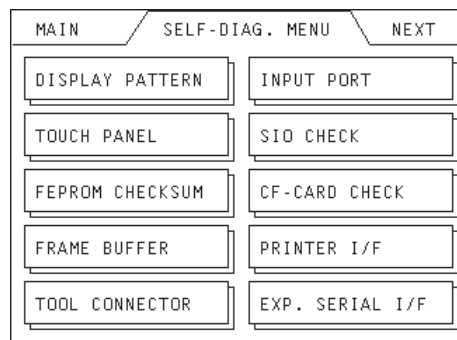
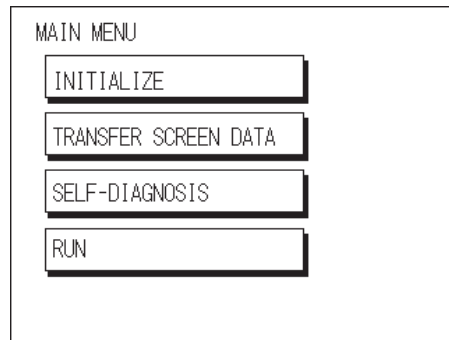

■ GP-2401H Series

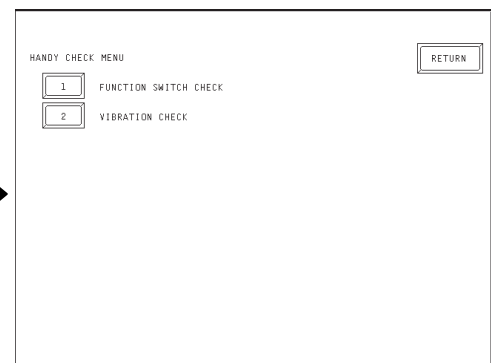
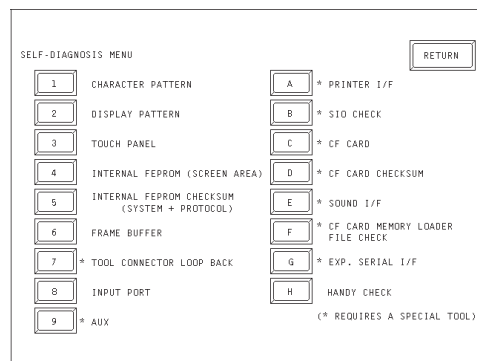

Chapter 8 – RUN Mode and Errors

1. **CHARACTER PATTERN**
Checks the characters inside the internal Character ROM.
2. **DISPLAY PATTERN**
Checks all the figures and tiling patterns.
3. **TOUCH PANEL**
Checks each GP touch panel square.
4. **INTERNAL FEPROM (SCREEN AREA)**
Checks the internal hard disk contents (FEPROM).
5. **INTERNAL FEPROM CHECKSUM (SYSTEM AND PROTOCOL)**
Checks the System and Protocol of the GP2000H unit's Internal Memory (FEPROM).
6. **FRAME BUFFER**
Checks the internal display memory.
7. **TOOL CONNECTOR LOOP BACK^{*1}**
Checks the Tool Connector control lines and send/receive lines.
8. **INPUT PORT**
Checks the Input Port (for Pro-face's maintenance use only).
9. **AUX^{*1}**
Checks the AUX control line.
- A. **PRINTER I/F^{*1}**
- B. **SIO CHECK^{*1}**
Checks the RS-232C and RS-422 send/receive lines.
- C. **CF CARD^{*1}**
Checks the status of the CF Card.
- D. **CF CARD CHECKSUM^{*1}**
- E. **SOUND I/F^{*1}**
Checks the status of the GP unit's Sound Output feature.
- F. **CF CARD MEMORY LOADER FILE CHECK^{*1}**
Checks the status of the CF Card Memory Loader File.
- G. **EXP. SERIAL I/F^{*1}**
Checks the status of the Expansion Serial Interface.
- H. **HANDY CHECK**
 - **FUNCTION SWITCH CHECK**
 - **VIBRATION CHECK**

1. This item requires that special equipment (cable, connector, etc.) be used.

8.2.2 SELF-DIAGNOSIS – Details

This section explains the contents of the SELF-DIAGNOSIS menu.

Reference *For information on how to operate the menu interface, see Chapter 5 – “OFFLINE Mode.”*

For information on how to set up the Special Tools, see Chapter 3 – “Handling and Wiring.”

1. CHARACTER PATTERN

Checks each font’s pattern and each Kanji character’s ROM. Used when Kanji characters do not display. If no error exists, the message **OK** appears. If an error exists, the message **NG** appears.

2. DISPLAY PATTERN

Checks the drawing function when the buzzer does not sound and when the device contents do not display correctly. Checks are performed on the various screen pattern displays (8 screens), DISPLAY ON/OFF, and the KANJIROM CHECKSUM. When DISPLAY ON/OFF is checked, the TOUCH BUZZER SOUND setting is checked simultaneously. If KANJIROM CHECKSUM is normal, **OK** displays. If a problem exists, **NG** displays.

3. TOUCH PANEL

Checks that each touch cell lights up when touched.

4. INTERNAL FEPROM (Screen Area)

Checks the internal FEPROM when a screen display error occurs. When using this check menu, you need to enter the password*¹.



- **When you run this check, all screen data that have been created will be deleted. Therefore, be sure to back up data prior to running this check.**
- **When this check menu is completed, you will need to initialize the internal memory (FEPROM).**

While checking, the following series of screens will display.

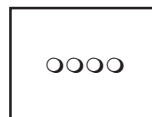

If no error exists, the message **OK** will appear. If an error exists, an error message will appear.

The number of symbol marks (such as **OOOO**) that display on the screen may vary, depending on the GP type.

- The symbol **O** indicates that the GP unit is operating the erase check.
- The symbol ***** indicates the the GP unit is operating the R/W check.

1. Enter either the password you have designated in the INITIALIZE screen, or the default password, **1101**.

Chapter 8 – RUN Mode and Errors

5. INTERNAL FEPRM CHECKSUM (System and Protocol)

The Internal FEPRM System and Protocol check searches for any problems that may occur during operation. When running the check, the screen changes as follows:

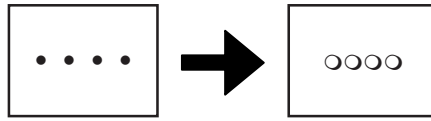

When the FEPRM is normal, **OK** displays. If a problem exists, the screen stops in the middle of operation. This check does not erase the System or Protocol.

6. FRAME BUFFER

The Frame Buffer (display memory) check searches for any display problems that may develop. When everything is normal, **OK** displays. When a problem exists, an error message displays.

7. TOOL CONNECTOR

Use the Tool Connector Control line and the Send/Receive line check when the GP unit cannot send or receive data from the PC. To run the check, it is necessary to connect the pin side of the Tool Connector Check Loop Back Cable (Dsub9pin) to the GP unit's Downloading Cable.

When everything is normal, **OK** displays. When a problem exists, an error message displays.

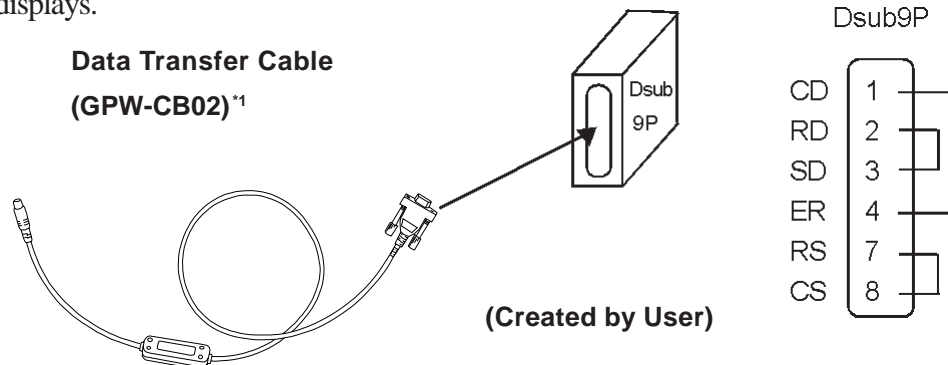

8. INPUT PORT

Used for Pro-face's maintenance checks only.

9. AUX

Because the AUX feature is not supported with the GP2000H Series unit, SELF-DIAGNOSIS cannot be performed.

Chapter 8 – RUN Mode and Errors

A. PRINTER I/F

SELF-DIAGNOSIS cannot be performed, since the GP2000H Series unit does not have the Printer Interface.

B. SIO CHECK

Checks the RS-232C and RS-422 SIO lines for areas where communication problems develop. In the menu, select which check to run. To run the check, connecting the SIO cable is necessary. If everything is normal, **OK** displays. If a problem exists, an error message appears.

The GP2000H Series Special Purpose Dsub Cable*¹ wiring is shown below.

SIO Cable Wiring (RS-232C, RS-422 common)

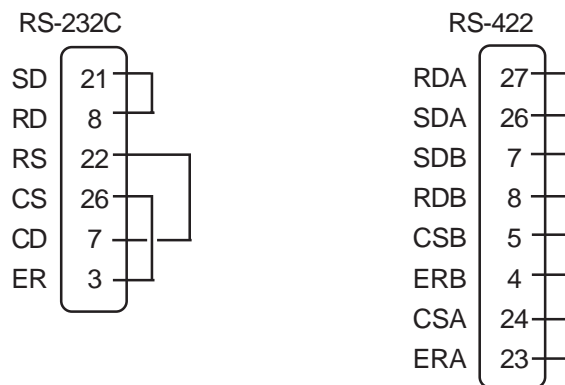

C. CF CARD

Checks the CF Card's Read/Write feature. Insert the CF Card in the GP prior to using this check menu. The CF Card needs to have more than 1kilobyte of usable space. If no error exists, the message **OK** will appear. If an error exists, an error message will appear.

D. CF CARD CHECKSUM

Takes the Checksum of the CF Card's files and operates the check. Insert the CF Card in the GP prior to using this check menu.

This menu checks the following files:

- Filing Data
- CF Card's Image Data
- CF Card's Sound Data

(The GP2000H Series unit does not support the Sound feature, but a Sound Data check will be performed.)

When the check is finished, the following items appear on the screen.

- number of checked files
- number of files that have an error
- file name where the most recent error occurred

1. When using GP2000H Series Special Purpose cables without Dsub:

Reference Refer to the installation guide included with each cable.

Chapter 8 – RUN Mode and Errors

E. SOUND I/F

SELF-DIAGNOSIS cannot be performed, since the GP2000H Series unit does not have the Sound Interface.

F. CF CARD MEMORY LOADER FILE CHECK

Checks the CF Card's Memory Loader Tool when it does not start. If no error exists, the message **OK** will appear. If an error exists, the message **NG** will appear.

G. EXP. SERIAL I/F

SELF-DIAGNOSIS cannot be performed, since the GP2000H Series unit does not have the Expansion Serial Interface.

H. HANDY CHECK

- **FUNCTION SWITCH CHECK**

Checks the Operation Switch, the Function Switch, and the 3-Position Enable Switch. Checks that the area/item that corresponds to each button turns on properly on the screen.



The 3-Position Enable Switch check cannot be performed when the GP unit is set to the GP2000H mode (default setting). This check can be performed only when the unit is set to the GP-H70 Compatibility mode.

- **VIBRATION CHECK**

Checks that the unit vibrates properly.

8.3 Troubleshooting

This section explains how to find and resolve the following problems, which may occur while using the GP unit. If a problem exists with the PLC, refer to the corresponding PLC manual.

8.3.1 Possible Types of Trouble

The following items are problems that may occur while using this unit.

(A) No Display

The screen will not display even when the unit is powered On. Also, during RUN mode, the screen disappears.

(B) No GP/HOST Communication

The GP unit cannot extract data from the host. An error message may appear on the screen as a result.

▼Reference▲ *8.4 Error Messages*

(C) Touch Panel Does Not Respond

The touch panel does not react when pressed, or the reaction time is very slow.

(D) Buzzer Sounds when GP power is turned ON

The GP's buzzer will sound intermittently after power is first turned ON.

(E) Clock Settings Cannot be Entered

Even after clock settings are entered, the GP unit's clock settings remain eg.) 00/01/01.

(F) OFFLINE displays During RUN Mode

The GP goes to the OFFLINE mode unexpectedly while operating, or the GP automatically goes to the OFFLINE mode when the power is turned ON.

For these first five problems, see the troubleshooting tables on the following pages.

For the last problem (F), a SYSTEM ERROR may have developed while displaying the OFFLINE mode screen.

▼Reference▲ *8.5 Error Message Details*

Be sure that no object has touched the screen accidentally if the GP goes to the OFFLINE mode without displaying an error message when the power turned ON. If any object may have possibly touched the top left corner of the screen within 10 seconds after the power turned ON, that may cause the GP to go OFFLINE.

Chapter 8 – RUN Mode and Errors

8.3.2 No Display

Follow the flowchart below when the screen does not display when powering up, or the screen turns OFF by itself during RUN mode, to find an appropriate solution.

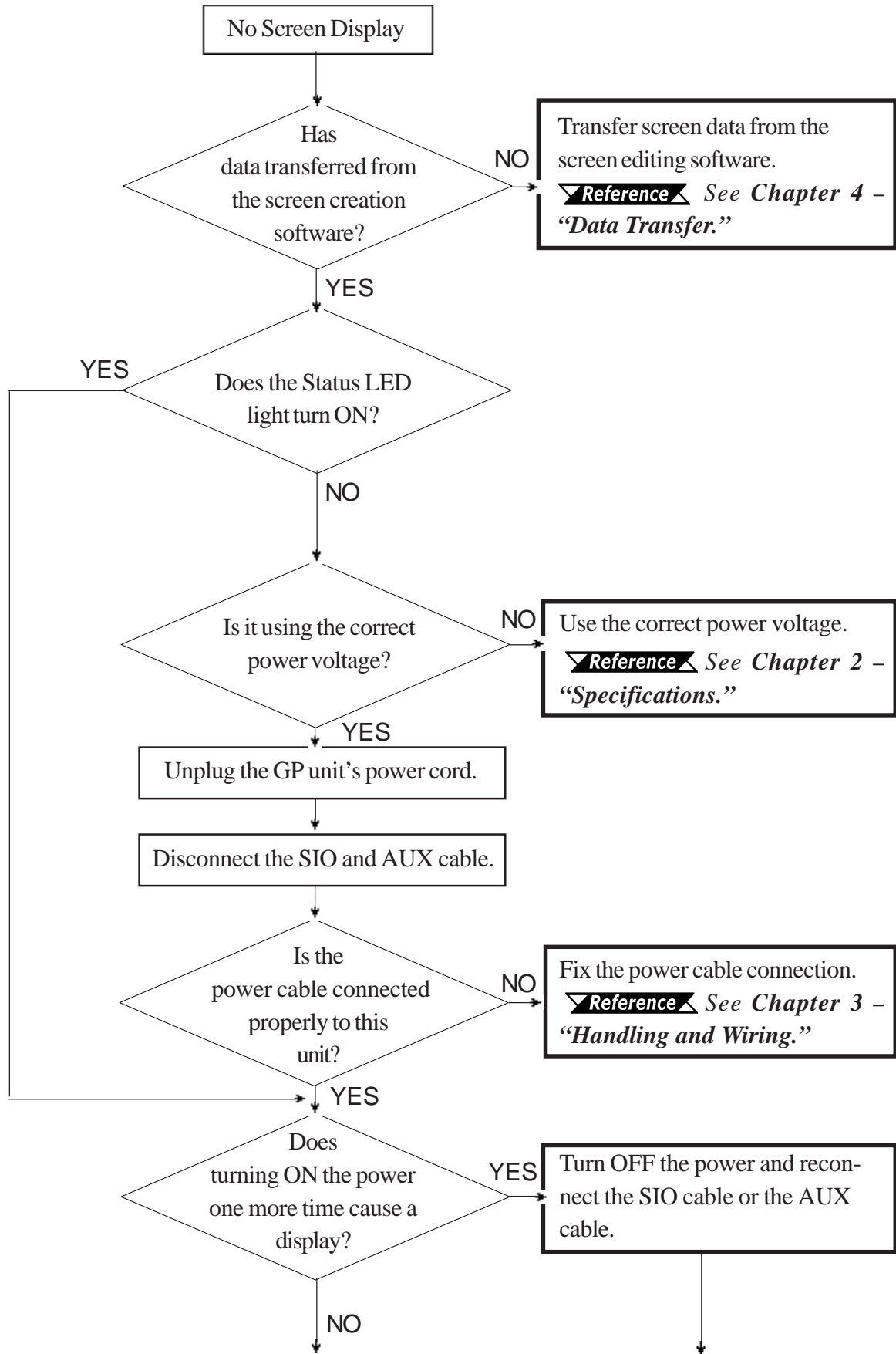

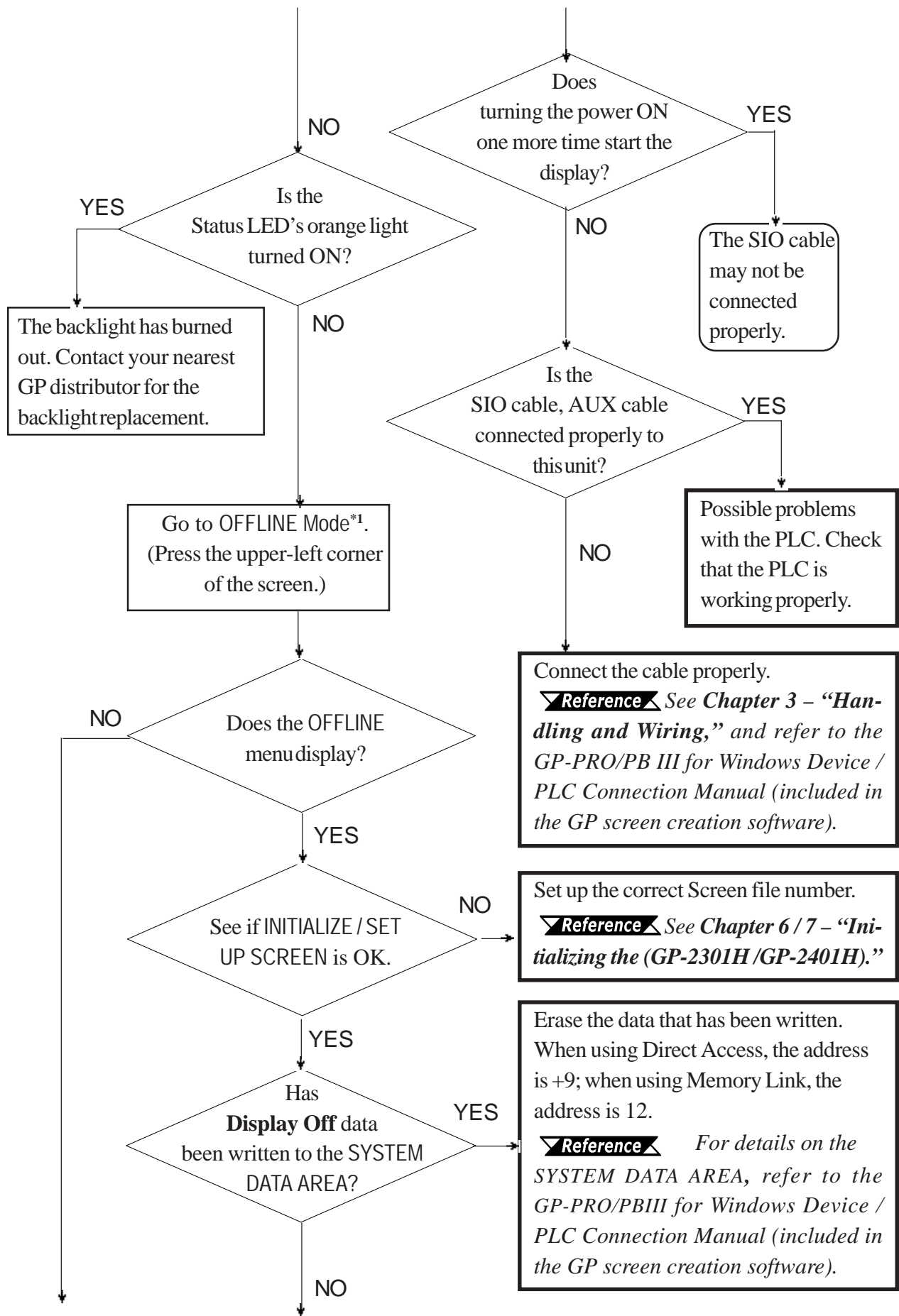

1. To make the OFFLINE screen appear, turn the power OFF, then ON, and press the top-left corner of the screen within 10 seconds.

Chapter 8 – RUN Mode and Errors

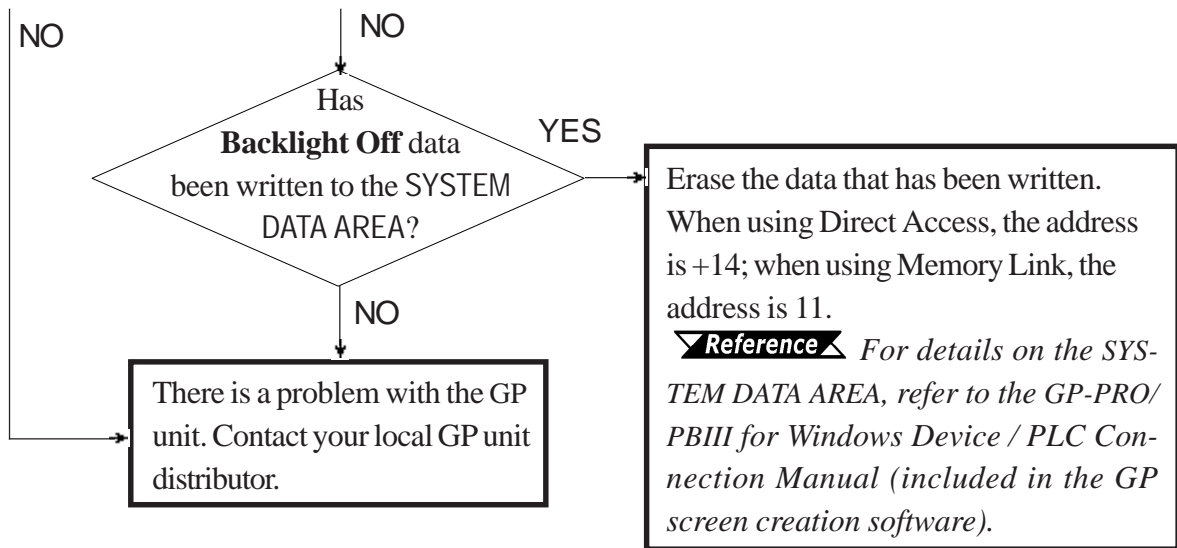

8.3.3 No GP / Host Communication

When the GP unit will not communicate with the host PLC, follow the flowchart below to find both the cause of the problem and a suitable response.

Or, if an error message displays on the screen, check the error code to find the appropriate solution.

Reference See 8.4 – “Error Messages.”

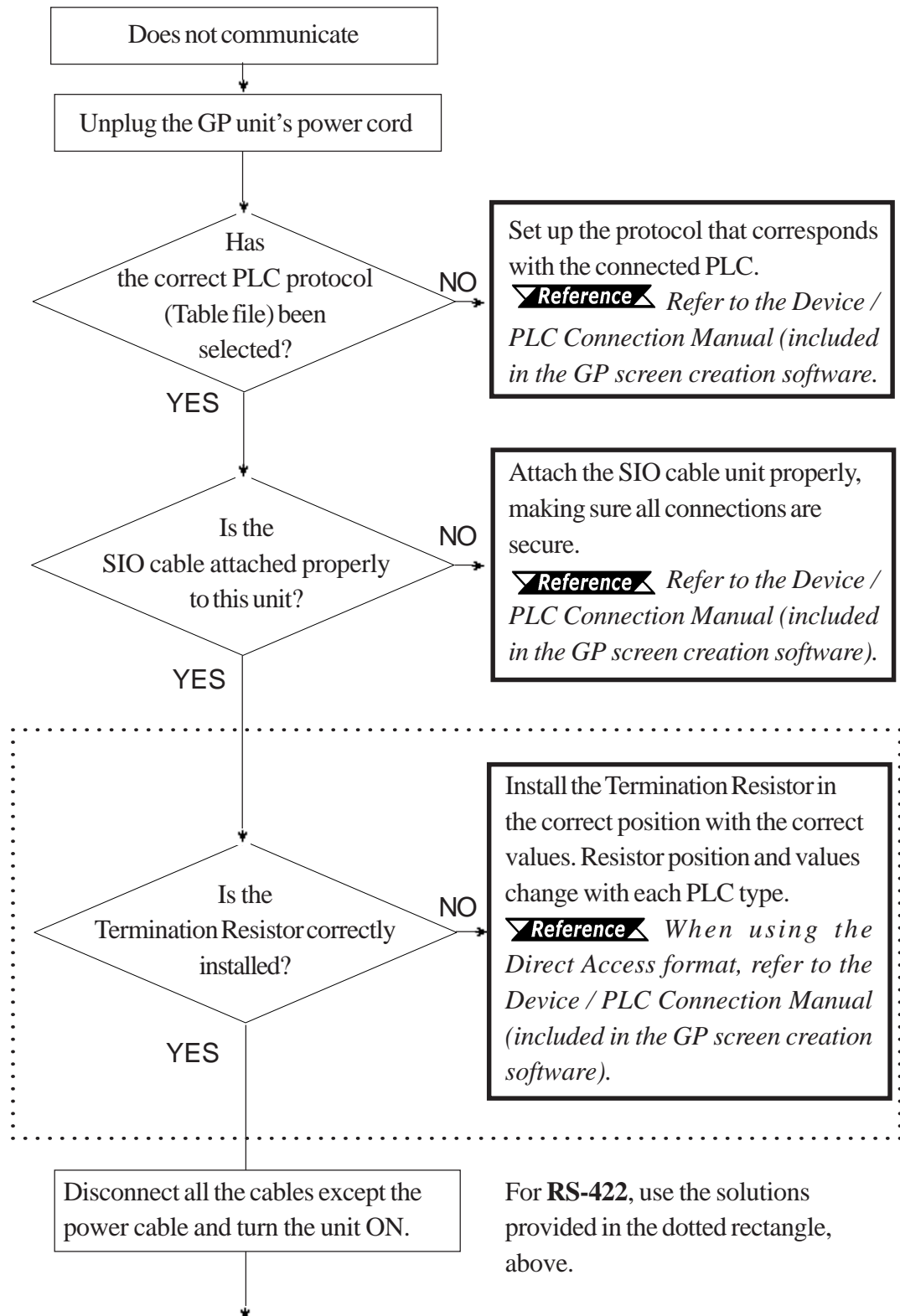

Chapter 8 – RUN Mode and Errors

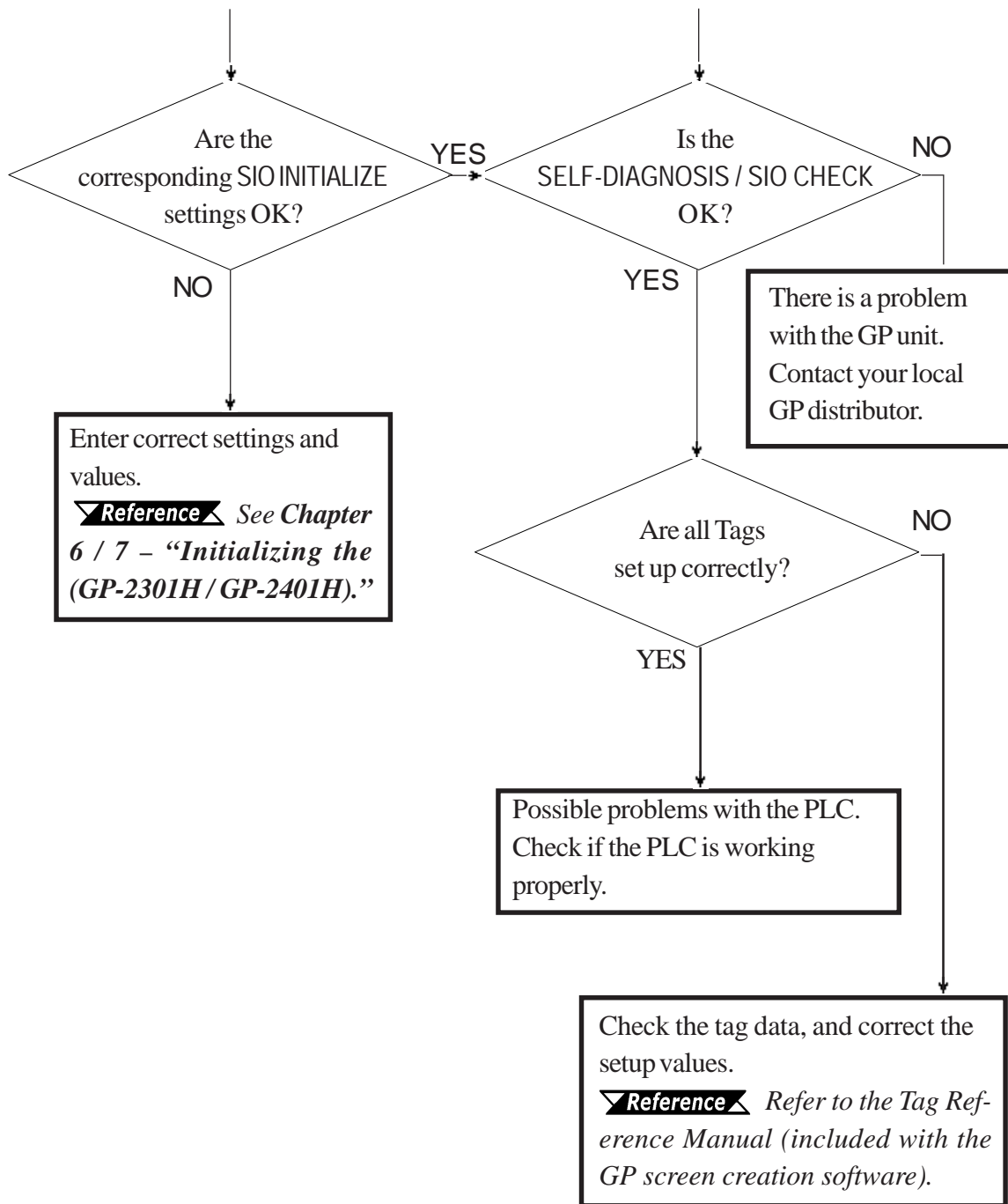

8.3.4 Touch Panel / Function Key Does Not Respond

When the touch panel does not respond, or its response time is very slow after it is pressed, use the flowchart below to find the origin of the problem and the appropriate solution.

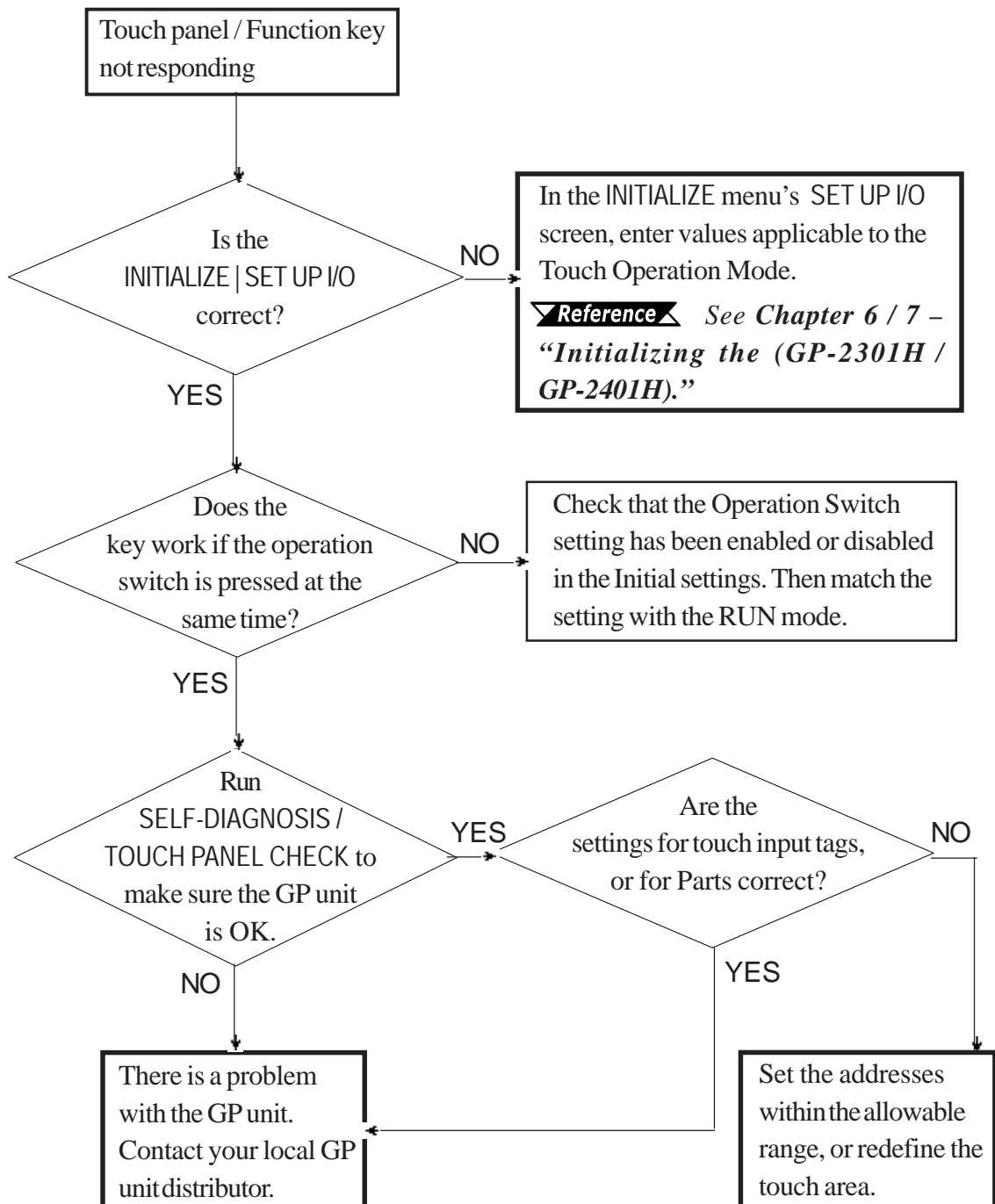

Chapter 8 – RUN Mode and Errors

8.3.5 Buzzer Sounds when GP Power is Turned ON

If the internal buzzer sounds when you start the GP unit, use the following chart to find the reason and the appropriate solution.

Buzzer Sound	Timing	Reason	Solution
Continous beep (approx. 1 sec. intervals)	When power to the GP is turned ON	The GP unit's system program is destroyed.	From the screen creation software, send the correct system program to the GP via the Transfer screen's "Forced Setup" feature. Turn ON the GP unit's dip switch #1 (next to CF Card slot) and use the CF Memory Loader Tool to set up the GP unit.
		A different GP unit's system program has been accidentally installed in this GP unit.	From the screen creation software, send the correct system program to the GP via the Transfer screen's "Forced Setup" feature. An error appears on the screen creation software's screen. Turn the GP unit's power supply OFF and then ON, and data transfer will start automatically. Turn ON the GP unit's dip switch #1 (next to CF Card slot) and use the CF Memory Loader Tool to set up the GP unit.
Three beeps – Repeating (approx. 1 sec. intervals)	When the GP unit's dip switch #1 (next to CF Card slot) is ON and power to the GP unit is ON.	The CF Card's Memory Loader Tool (MLD****.SYS) file is missing or destroyed.	Reformat the CF Card and replace the CF Card's Memory Loader Tool file.
	When the GP unit is started via the menu bar's CF BOOT key.	The CF Card's Memory Loader Tool (MLD****.SYS) file is missing.	
Three beeps – Repeating (approx. 1 sec. intervals)	When the GP unit is started via the menu bar's CF BOOT key.	The CF Card's internal boot program (IPL.SYS) is destroyed. ^{*1}	Reformat the CF Card and replace the CF Card's Memory Loader Tool file.

If the CF Card's BOOT program (IPL.SYS) or the Memory Loader Tool (MLD****.SYS) programs appear to be damaged or destroyed, use the GP unit's internal diagnostic program "CF Card Memory Loader File Check" utility to confirm the condition of these files.

▼ Reference ▲ See 8.2 – "SELF-DIAGNOSIS."

8.3.6 Clock Settings Cannot be Entered

This problem occurs when the lithium backup battery's voltage, used for the internal clock, runs out. To enter the clock settings, please read the CLOCK SET UP ERROR directions. [▼Reference▶ 8.5.4 CLOCK SET UP ERROR](#)

8.3.7 Error Screen is Displayed

If the error message below is displayed when the GP unit starts, the system has not been properly set up. Download the system data again (Force System Setup).

システムがインストールされていません。
画面の転送(強制セットアップ)を行ってください。
This unit's system data was not downloaded. Please download the system data again (Force System Setup)

8.4 Error Messages

This section explains the messages that appear when an error has occurred in the GP2000H unit during RUN mode. The problem causing the error message and its related countermeasure are explained in the table below.

After a problem has been solved, unplug the GP unit's power cord and then reattach it. *(Only the latest error message will appear on the GP2000H screen.)*

8.4.1 Error Message List

Error Message	Problem	Countermeasure
SYSTEM ERROR (03 : **)	During screen data transfer, an unrecoverable error occurred.	▼Reference▶ See 8.5 – "Error Message Details."
SYSTEM ERROR (** : ** : **)	During screen data transfer, an unrecoverable error occurred.	▼Reference▶ See 8.5 – "Error Message Details."
ILLEGAL ADDRESS IN SCREEN DATA (00B : ** : **)	Settings are used that overlap addresses.	Set the addresses correctly after checking the screen data.
UNSUPPORTED TAG IN SCREEN DATA	The GP unit currently in use does not support the desired Tag.	Set the Tag correctly after checking the screen data.
PLC NOT CONNECTED (02 : FF) and (02 : F7)	The communication cable is not connected correctly.	Re-connect the communication cable correctly.
PLC NOT RESPONDING (02 : FE)	The PLC's power is not turned ON.	Turn ON the PLC's power.
	The GP unit INITIALIZE settings (Setup I/O, PLC Setting) are incorrect.	Check the INITIALIZE settings and make any necessary corrections.
	The host and GP unit Powering up sequence was incorrect.	Turn ON the PLC's power and wait for 2-3 seconds, then turn ON the GP unit's power.
	The communication cable is not connected properly.	Check the communication cable and connect it correctly.

Chapter 8 – RUN Mode and Errors

Error Message List (cont.)

Error Message	Problem	Countermeasure
RECEIVE DATA ERROR (02 : F9)	The communication cable was disconnected while the GP unit was ON.	Turn the GP unit OFF and then ON again.
	The GP unit is powered OFF, then ON during communication with PLC.	Turn the GP unit OFF and then ON again.
	Noise occurred in the communication cable.	Check the communication cable and connect it correctly.
GP STATION NO. DUPLICATION ERROR (02 : F9)	This GP unit's station number is the same as another GP unit.	Check all GP unit station numbers, and set them so they are all unique.
	PLC is powered OFF, then ON during communication with the GP unit.	Turn the GP unit OFF and then ON again.
NETWORK ADDRESS ERROR (02 : F8)	The SIO address used for this GP unit is different from other GP units (multi-link connection only).	Check all GP units' SIO address settings, and correct any that are incorrect.
PLC COM. ERROR (02:**)	A PLC error has occurred, or the PLC displays an error code.	▼Reference▲ See 8.5 – "Error Message Details."
SCREEN MEMORY DATA IS CORRUPT (nnnn:mmmm)	ScreenData is corrupted. *nnnn indicates the Screen Number that has an error. *mmmm indicates the number of screens that have errors. (Decimal)	Check the screens that have errors, correct all errors, and then transfer the screen data again.
CLOCK SETUP ERROR	The backup battery for the internal clock is running low.	▼Reference▲ See 8.5 – "Error Message Details."
SCREEN TRANSFER ERROR	An error occurred in the data transmission, from the screen creation software to the GP panel.	Re-transfer the screen data.
SCREEN TAG LIMIT EXCEEDED	Tags are set up beyond the tag limit. (385 max.)	▼Reference▲ See 8.5 – "Error Message Details."
OBJ. PLC HAS NOT BEEN SET UP (**)	The host PLC set up in the screen creation software does not match the PLC in use.	▼Reference▲ See 8.5 – "Error Message Details."
CF CARD RECOGNITION ERROR	A CF Card that is not compliant with the GP unit is being used.	Use the optional CF Card provided by Digital Electronics Corporation.
	The CF Card is not recognized due to the timing of the CF Card Insertion and Removal.	Either reinsert the CF Card or turn the GP unit OFF and then ON again while the CF Card is still inserted.

Error Message List (cont.)

D-SCRIPT ERROR (***)	D-Script settings (data) are incorrect.	▼ Reference ▲ 8.5 Error Message Details
GLOBAL D-SCRIPT ERROR (***)	Global D-Script settings (data) are incorrect.	▼ Reference ▲ 8.5 Error Message Details
EXTENDED SIO SCRIPT ERROR (***)	Extended SIO script settings (data) are incorrect.	▼ Reference ▲ 8.5 Error Message Details

8.5 Error Message Details

8.5.1 System Errors

Indicates a fault in the basic operations of the GP unit.

Following the error message, an error code (see below) will appear. Report the error number and details on how the error developed to your local GP distributor.

■ SYSTEM ERROR (03 : x x)

An unrecoverable error occurred during screen data transfer.

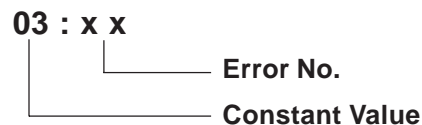

■ SYSTEM ERROR (x x x : x x x : x x x)

An unrecoverable error occurred during screen data transfer.

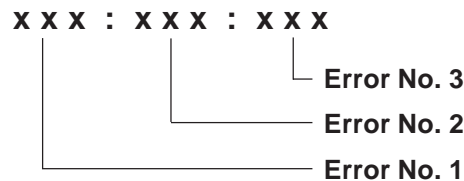

Possible Solutions

- Check that the GP unit's power cord and the Input signal line have been wired separately from each other.
- Check that the FG line has been grounded correctly, according to your country's standards.
- Re-send the screen data from the PC to the GP unit.

▼ Reference ▲ To correct other types of communication errors (such as *RECEIVE DATA ERROR* or *PLC COM. ERROR*), see 8.4.1 – “Error Message List.”

If the above-mentioned methods do not solve the problem, contact your local GP distributor.

Chapter 8 – RUN Mode and Errors

■ When the GP Changes to OFFLINE Mode during RUN Mode

When the GP unit changes to OFFLINE Mode without the user first pressing the screen, there is a possibility that the screen data has been damaged. In this case, after the SYSTEM ERROR displays, the screen automatically reverts to OFFLINE Mode after about 10 seconds. Run the INITIALIZE MEMORY command and transfer the GP screen data again from your PC.

In most cases, system errors are related to the problems mentioned below.

■ Factors that May Cause System Errors

Environment-Related Problems

An error that has no apparent relation to the GP unit's current operation may be related to its operating environment. This can include noise or electrostatic interference in the power cord or the communication line. In this case, you need to check that the power code and the communication line wiring and FG grounding are correct.

Screen Data- or Project Data-Related Problems

If a GP unit operation seems to cause a particular error, the error may be related to the screen or project data transferred to the GP unit. In this case, try sending screen data via the FORCE SYSTEM SETUP feature, which will transfer both the screen data and the project data to the GP unit.

Reference *For details about the FORCE SYSTEM SETUP feature, refer to the "Transfer Settings" section in the GP-PRO/PBIII for Windows Operation Manual.*

GP-Related Problems

If disconnecting and then reconnecting the power cord corrects an error, the problem may not be related to the GP unit itself. However, to identify any GP-related problems, run the OFFLINE Mode's SELF-DIAGNOSIS program.

Peripheral Equipment-Related Problems (when the GP is equipped with a printer interface)

An error that occurs only during printout may be a printer problem. Check the printer cable wiring and the FG line as well as the printer itself.

Communication Error Occurs Continuously (when using the Direct Access method)

A communication error that occurs continuously may be defined by the GP as a system error. In this case, you need to solve the problem causing the original communication error.

8.5.2 Illegal Address In Screen Data

Caused by an overlap of addresses.

Following the error message, error codes (see below) will appear. If the error cannot be fixed, report the error code and details on how the error developed to your local GP distributor.

ILLEGAL ADDRESS IN SCREEN AREA (00B:XXX:XXX)

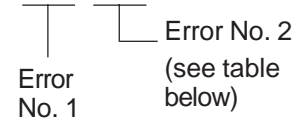

■ Overlapping Addresses

Error 1	Error 2	Meaning
0C1	191	Addresses set up in the SYSTEM DATA AREA overlap all or part of the Trend Screen ^{*1} addresses or S-tag addresses.
	192	
	193	
0C2	194	Addresses set up in the Trend Screen ^{*1} overlap all or part of the SYSTEM DATA AREA addresses, Alarm Message addresses, or S-tag addresses.
	195	
	196	
0C3	197	Addresses set up in the Alarm Message overlap all or part of the Trend Screen ^{*1} addresses, S-tag addresses, or K-tag addresses.
	198	
	199	
0C9	19B	Addresses set up in the Q-tag (Log alarm) overlap all or part of the Trend Screen ^{*1} addresses, S-tag addresses, or K-tag addresses.

1. For details about the Trend Screen and Alarm message,

Reference Refer to the GP-PRO/PB III for Windows Tag Reference Manual (included with the screen creation software).



Note: Overlapping addresses, other than the ones mentioned above, can also cause the Illegal Address message.

E.g. Overlapping addresses can occur when the starting address of the SYSTEM DATA AREA is set to 100, and the tag below is set up:

Tag Name / Part ID No.	Word Address	Tag Format
N1	99	BCD32

Starting from Address 99, two (2) words are used, which causes an overlap of Address 100.

Chapter 8 – RUN Mode and Errors

8.5.3 PLC COM. Error

Appears when the address setup for tags exceeds the address range used in the host (PLC). Check the Error Number that appears and use the following table to solve the problem.

PLC COM. ERROR (02 : x x)

└─ Error Code (see table below)

└─ Constant Value

Error #	Problem	Countermeasure
FC	There was a problem with the format of data received by the GP.	When using Memory Link, check the data or settings on the host. Check the communication speed with the PLC.
FB	Address range error or Device settings error	* When using Memory Link type: Set the addresses within the set range of the System Data Area (0 to 2047), and re-send correct data.
		* When using PLCs: Set up the address range in a usable device address range. Make sure that use of the device address range is possible.
FA	Address range error	Set up the address range in a usable device address range.
53	When using a Matsushita Electronics PLC, and there are too many tags on the screen, the PLC will not receive data.	Decrease the number of tags on the screen.
51	The tag addresses, Trend graph data storage address, Alarm message registry address, do not exist in the PLC's internal memory.	* When using a Fuji Electric PLC: Set up the addresses in a device range that exists.
Others	The Error code for the corresponding PLC will be displayed. Look up the Error Number in the specified PLC manual, or report the Error Number to the PLC manufacturer.	

Chapter 8 – RUN Mode and Errors



Note:

- With the Hitachi HIDIC H (HIZAC H) Series, the error code is divided into 2 bytes, whereas the GP Error Number is composed of 1-byte codes.

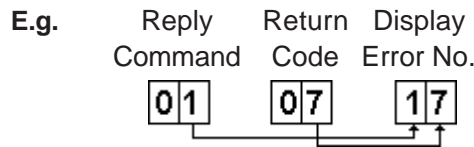

When the Display Error Number is 8* or 5*, use only the left column as the error number.

- With the Toshiba PROSEC T Series, the Error Code is 4 characters long. On the GP unit, Error Numbers are changed to and displayed in Hexadecimal.
- With the Allen-Bradley PLC-5 and SLC-500 Series, the EXT/STS error codes have been re-mapped to start at D0 HEX, so they will not conflict with other error codes. When looking up the error number in the PLC manual, subtract D0 h from the GP error code to find its error value.

E.g.:

GP Error Code	PLC Error Code
D1	01
EA	1A

8.5.4 Clock Setup Error

This message displays when the lithium backup battery's voltage for the internal clock runs out. To reset the error, you need to turn the GP unit's power OFF and then ON again. Leave the GP unit ON continuously and the battery's charge will become sufficient for backup after 24 hours, and will be fully charged in approximately 96 hours. If the battery is incorrectly replaced, the battery may explode. To avoid the danger, do NOT replace the battery yourself. When the battery needs a replacement, consult with your local GP distributor.

After changing the backup battery, set up the internal clock.

Reference See Chapter 6 / 7 – “Initializing the (GP-2301H / GP-2401H).”



Note:

The lifetime of the backup battery depends on the ambient temperature and the amount of current being charged and used. The table below gives a general indication of how long the battery will last.

Battery Temperature	40°C or lower	50°C or lower	60°C or lower
Expected Lifetime	10 years or longer	4.1 years or longer	1.5 years or longer

Chapter 8 – RUN Mode and Errors

8.5.5 Screen Tag Limit Exceeded (384 max.)

When tags are set up beyond the tag limit, all tags in excess of number 384 will be disabled. Also, when tags involve registered Windows and loaded screens, they are disabled in this order: Window Registry, Load Screen.

1. Disabled registered windows start from the last screen used.
2. Disabled loaded screens start from the last screen used.

To correct this problem, reduce the number of tags to within the allowed limit.

8.5.6 OBJ. PLC Has Not Been Set Up

The host (PLC) setup in the screen creation software program (the .prw file) does not match the PLC in use. Use the Error Code that follows the error message to select the proper PLC type, and correct the GP unit's INITIALIZE setup data to match this.

OBJ. PLC HAS NOT BEEN SET UP (x x)

|
The PLC number
(Hexadecimal)
written to the GP
unit's System File.

8.5.7 D-Script and Global D-Script Errors

The following error messages are displayed when D-Scripts and Global D-Scripts are not correctly set up. The GP-2301H/2401H Series unit displays the error message at the bottom of the GP screen.

	Error Message
D-Script	D-Script Error (***)
Global D-Script	Global D-Script Error (***)

The following table lists the numbers assigned to (***) in the above error messages. Error Nos. "001" and "002" are displayed at power-on, and Error Nos. "003" and "004" are displayed when an error occurs during the script processing.

No.	Description	Type Script
001	The total number of Global D-Scripts exceeds the limit. The maximum number of Global D-Scripts is 32. Note that functions are included in the counts.	Global D-Script
002	The total of all devices in the Global D-Script exceeds the limit of 255 devices.	Global D-Script
003	Either the function being called does not exist, or that function has caused an error.	D-Script Global D-Script
004	Function cannot be nested more than 10 levels.	D-Script Global D-Script

8.5.8 Extended SIO Script Error

The following error message is displayed when an Extended SIO Script is not correctly set up. The GP-2301H/2401H Series unit displays the error message at the bottom of the GP screen.

	Error Message
Extended SIO Script	EXTENDED SIO SCRIPT ERROR (***)

The following table lists the numbers assigned to (***) in the above error message. Error No. 001 is displayed at power-on, and Error Nos. 003 and 004 are displayed when an error occurs during the script processing.

No.	Description
001	The total number of the Functions of Extended SIO Scripts exceeds the limit. The maximum number of Extended SIO Scripts is 254.
002	Reserved
003	The function that is being called does not exist.
004	Functions cannot be nested more than 10 levels.
005	An old Extended SIO Script protocol is being used for the GP system. Extended SIO Script cannot be run when this error occurs. Be sure to install and run a new Extended SIO protocol (Version 1.12 or later).
006	An incompatible function was found in the screen data's Extended SIO Script. Be sure to install and run a new GP system.

Memo

Chapter 9 Maintenance

1. Regular Cleaning
2. Periodic Check Points
3. Changing the Backlight

9.1 Regular Cleaning

9.1.1 Cleaning the Display

When the surface or the frame of the display gets dirty, soak a soft cloth in water with a neutral detergent, wring the cloth tightly, and wipe the display.



- Do NOT use paint thinner, organic solvents, or strong acid compounds to clean the GP unit.
 - Do NOT use hard or pointed objects to operate the touch-screen panel, since they can damage the panel's surface.
-

9.2 Periodic Check Points

To keep your GP unit in its best condition, inspect the following points periodically.

GP Operation Environment

- Is the operating temperature within the allowable range (0° C to 40° C)?
- Is the operating humidity within the specified range (10%RH to 90%RH, wet bulb temperature of 39° C or less)?
- Is the operating atmosphere free of corrosive gasses?

Electrical Specifications

- Is the input voltage (DC 19.2V to DC 28.8V) appropriate?

Related Items

- Are all power cords and cables connected properly? Have any become loose?

9.3 Replacing the Backlight

The GP2000H Series unit backlights are **NOT** user replaceable.

If backlight replacement is required, please contact your local distributor.

When the unit's backlight burns out, the unit's status LED will turn orange. If the OFFLINE menu's USE TOUCH PANEL AFTER BACKLIGHT BURNS OUT feature is set to NO, the GP unit's touch panel will be disabled.*¹

▼Reference▲ See 6.4.3 – “SET UP I/O (GP2301H)” or 7.4.3 – “SET UP TOUCH PANEL (GP2401H).”

GP2000H Series units use a CFL, long-life type backlight. The actual life of the backlight, however, depends on the GP unit's operating conditions, and replacement may be required. A GP2000H Series backlight has a life of 50,000 hours (approx. 5.7 years at 25° C and 24-hour operation) when the backlight is lit continuously. (The “life” of the backlight is the time it takes for the brightness to fall to half its normal level.)

1. If the OFFLINE menu's FORCE RESET feature is set to NO, the touch panel operation is disabled.

▼Reference▲ See 6.4.3 – “SET UP I/O (GP2301H)” or 7.4.3 – “SET UP TOUCH PANEL (GP2401H).”

Index

Numeric

3-Position Enable Switch 2-10, 2-15

A

About the GP Unit's Display Panel 13
 Access Lamp 3-15, 3-16
 Access Token 6-1, 7-1
 Accessories 1-5, 1-6
 Address Overlap 8-22
 After Entering All Setting Data 5-7
 Alarm Indicators 8
 ALARM MESSAGE Setting 6-27, 7-26
 Ambient Operating Temperature 8-24
 Attaching the CF Card Interface Guard 3-5
 Attaching the Emergency Switch Guard 3-5
 Attaching the GP2000H to a Swivel Mount Arm or
 Sim 3-1
 Attaching the GP2000H to the Wall Mount Adapter
 3-1
 Attaching the Hand Strap 3-3
 Attaching the Neck Strap 3-3
 AUX Check 8-7
 Available Software 1-5

B

Back up SRAM 6-24, 7-23
 Backlight Burnout 8, 6-15, 7-13, 8-11, 9-2
 and Status LED 6-15, 7-13
 and SYSTEM RESET 6-15, 7-13
 Backlight Replacement 9-2
 BLACK/WHITE REVERSE Setting 6-18, 7-16
 Blink Feature and 256 Colors Setting 2-3
 Breaker-type Power Switch 3-7
 BRIGHTNESS Setting 6-13, 7-11
 Buzzer Problems 8-16
 Byte Storage Order (LH/HL) 6-7, 7-7

C

Cable Cover 2-15
 Cable Installation 3-7
 CAN/CSA-C22.2 15
 Cautions and Warnings 11, 3-15

CF Card 3-5
 Access LED 2-15
 Access Switch 2-15, 3-15
 BOOT Program 4-5, 8-16
 Cover 3-13
 Data Backup 3-16
 Data Overwrite Limit 3-16
 Handling 3-16
 Initialization 6-24, 7-23
 Installation 3-15
 Interface 2-15, 3-5
 Interface Guard 3-5
 Memory Loader File Check 8-10, 8-16
 Memory Requirements 4-5
 Operation Tests 3-16
 Reader 3-16
 Start Switch 2-15, 4-5
 CF Card Access LED 2-15
 CF Card Access Switch 2-15
 CF Card Cautions 3-15
 CFL Backlights 9-2
 CHANGE SCREEN NUMBER Setting 6-5, 7-5
 Changing to GP-H70 Compatibility Mode
 3-11, 3-12
 CHARACTER PATTERN Check 8-5
 CHARACTER STRING DATA Mode
 Byte Storage Order (LH/HL) 6-7
 Data Device Storage Order 6-7
 Tag Settings 6-7
 Check Points 9-1
 Cleaning and Maintenance 9-1
 CLOCK DATA CURRENT Setting 6-5, 7-5
 Clock Function Specifications 2-4
 Clock Settings Cannot be Entered 8-9, 8-17
 Clock Setup Errors 8-24
 Clock Specifications 2-4
 Clock Specifications (Functional) 2-4
 Communication Errors 6-22
 Communication Faults 7
 COMMUNICATION FORMAT Setting 6-11, 7-10
 COMMUNICATION INTERFACE Setting 6-11
 COMMUNICATION RATE 6-16, 7-14
 COMMUNICATION RATE Setting 6-9, 7-9
 CSV DATA INDEX 6-25, 7-24

Index

D

- Damages, Losses, or Third-Party Claims 1, 15
- Data Device Storage Order 6–7, 7–7
- DATA FORMAT Setting 6–7, 7–7
- DATA LENGTH 6–16, 7–14
- DATA LENGTH / STOP BIT Setting 6–9, 7–9
- Data Overwrite Limit, CF Card 3–16
- Data Transfer
 - Cable 3–13
 - CF Card 4–5
 - GLC system file transfer 6–1, 7–1
 - Serial 4–1
 - System 5–1
- DATA TYPE OF SCREEN NO. Setting 6–5, 7–5
- DC 24V Interface 2–8
- Default Password 5–3, 6–24, 7–23
- Device Monitor 5–3
- Dip Switches 4–5
- Direct Access 6–3, 6–15, 7–3, 7–13, 8–11
- Direct Access Communication Errors 8–20
- DOWNLOAD (from CF Card to GP) 4–6
- Downloading CF Card Data to the GP 4–6

E

- Edit Mode Peripherals 1–5
- Electrical Specifications 9–1, 2–1
- Electrical Specifications Check 9–1
- Emergency Switch 2–10, 2–13, 3–5
- Emergency Switch Guard 15, 3–5
- Emergency Switch Guard Attachment Screws 15
- Emergency Switch Specifications 2–10
- Emergency Switches 8
- EN55011 Class A 15
- EN61000-6-2 15
- Entering Numbers 5–5
- Environment-Related Problems 8–20
- Environment-Related System Errors 8–20
- Error Messages
 - Clock Setup Errors 8–24
 - OBJ. PLC Has Not Been Set Up Error 8–24
 - Screen Tag Limit Exceeded Error 8–24
 - System Errors 8–19
- ERROR STATUS Setting 6–5, 7–5
- Errors
 - Communication 6–22
 - Internal clock 2–4, 6–26

- EXP. SERIAL I/F Check 8–10
- EXPANSION SERIAL I/F Check 8–10
- Extended SIO Script Error 8–25
- External Interface Specifications 2–7
- External Interfaces 1–5
- External Interfaces (opt.) 1–5
- External Output I/F Circuit 2–11, 3–11
- External Output I/F Circuit Specifications 2–11, 3–11
- External Output Interface Specifications 2–10

F

- FEPROM 8–5
- FEPROM CHECKSUM 8–7
- FG Terminal 2–8
- Flat Panel Monitor Physical Mounting Interface 3–1
- FONT Setting 6–29, 7–27
- Font Settings 6–2, 6–29
- Force Reset 6–13
- FORCE RESET MODE Setting 7–11
- Force System Setup 8–17
- FRAME BUFFER Check 8–7
- Function Switch 8–10
- Function Switches 2–13

G

- Gasket Protection Level 3–5
- GLC-Related Problems 8–20
- Global D-Script Error 8–24
- GLOBAL WINDOW ACCESS Setting 6–7, 7–7
- GP-PRO/PBIII for Windows
 - GP Setup 8–3
 - IO Settings 8–3
- GP / PLC Communication Problems 8–14
- GP Tool Connector 3–13
- GP TOUCH MONOPOLIZE Setting 6–24, 7–23
- GP-H70 Compatibility Mode 3–8, 3–9

H

- Hand Strap 15
- hand strap 3–1
- Hand Strap Attachment Slot 2–15
- HANDY Check 8–10
- Handy” type GP units 1
- Hardware Switches 7

I

- I/O Setup 7–11
- I/O Setup Screens 6–9, 7–9
- INITIAL SCREEN NO. Setting 6–27, 7–26
- Initialization 5–5, 6–1, 6–24, 7–1
 - CF Card 6–24
- INITIALIZE Menu Screens 6–2, 7–3
- Initializing the GLC 7–23
- INPUT PORT Check 8–7
- Inserting the CF Card 3–15
- Installation
 - Cautions and Warnings 9, 11
 - Gasket 3–1
- Installation Cautions 11
- Installation Gasket 3–8
- Installation Guide 15
- Installation Warnings 9
- Interface Connectors 3–7
- Interface Diagnosis 8–3
- Interface Specifications 2–6, 2–8
- Interface Specifications (Functional) 2–6
- Interfaces
 - Expansion Unit 2–13
 - Serial 2–15
- Internal Buzzer Problems 8–16
- Internal Memory 6–24, 7–23, 8–5

K

- K-tag Write Character Value 6–9, 7–9
- KANJI FONT QUALITY Setting 6–29, 7–27

L

- Liability 1
- Limiters 7
- Liquid Crystal Display (LCD) Panel
 - Cautions 11, 13
 - Monochrome LCD 6–18
- Lithium Backup Battery 8–24
- Lithium Battery 9, 2–4, 6–26, 7–25, 8–24
- Lithium Battery Lifetime 2–4

M

- Maintenance and Cleaning 9–1
- Maintenance and Operation Cautions and Warnings 9, 11
- Maintenance Items 1–6
- Maintenance Items (opt.) 1–6

N

- neck strap 3–1
- Neck Strap (opt.) 1–6
- NETWORK INFORMATION ADDRESS
 - 6–20, 7–19
- NETWORK INFORMATION ADDRESS Setting
 - 6–20, 7–19
- No Display 8–9
- No GP/HOST Communication 8–9

O

- OFFLINE displays During RUN Mode 8–9
- OFFLINE Mode 5–1
- OFFLINE Mode Check 8–3
- OFFLINE Mode Settings 5–5

R

- RUN Mode 8–1
- RUN Mode Peripherals 1–3

S

- Safety Precautions
 - Essential 7
 - General 13
- Safety Symbols 7
- Starting the CF Memory Loader Tool 4–5
- STATION NO. Setting 6–22, 7–21
- STATION SETUP 7–19
- Status LED 2–13, 2–13
- System Setup Password 5–3
- System Version 8–1

T

- Three Position Enable Switch Specifications 2–10
- Three-Position Enable Switch 3–8, 3–11, 8–10
- Three-Position Enable Switches 8
- TIME Setup 7–25
- Tool Connector 1–5, 2–15, 3–13

U

- UL 60950 15
- UNIT NO. Setting 6–19, 7–19
- UPLOAD (from GP2000H to CF Card) 4–6
- Uploading GP2000H Data to the CF Card 4–6
- USE TOUCH PANEL AFTER BACKLIGHT BURN-OUT Setting 6–15, 7–13
- Using the GP2000H Unit's CF BOOT Menu 4–5

Index

Using the GP2000H Unit's CF Card Startup Switches

4–5

Using the SET and ESC Keys 5–7

V

Validation List 6–22, 7–21

Validation List Bit Numbers 6–22

Version Information Screen 8–1

VESA Compliance 3–1

VIBRATION Check 8–10

Video Electronics Standards Association 3–1

Video Electronics Standards Association (VESA)

3–1

W

Wall Mount Adapter 3–1

Wall Mount Adapter (opt.) 1–6

Warning 3–11

Warning Alarms 8

Warnings 3–7

Tool Connector 3–11, 3–13

Wiring 3–7

Warnings and Cautions

Installation Warnings 9

Operation and Maintenance 9

System Design 7

Wiring 9

Warnings, Cautions, and Dangers

3–7, 3–11, 3–13