

Preface

Thank you for purchasing Digital's Pro-face GP-377 Series Graphic Control Panel (hereafter referred to as the "GP unit").

This GP unit, with its expanded functionality and improved overall performance, is an upgrade of Digital's GP370 series panels. Also, instead of using the optional 2-Port Adapter, the Mitsubishi Electric Corporation's GPP software package and the GP's rear face tool connector can now be used to provide 2-Port feature communication.

Please read this manual carefully as it explains, step by step, how to use the GP correctly and safely.

Also, in this manual's examples, the Mitsubishi MELSEC-AnA Series PLC is used whenever possible, connected in a one-to-one relationship with a GP.

<Note>

- 1) It is forbidden to copy the contents of this manual, in whole or in part, except for the user's personal use, without the express permission of the Digital Electronics Corporation of Japan.
- 2) The information provided in this manual is subject to change without notice.
- 3) This manual has been written with care and attention to detail; however, should you find any errors or omissions, please contact the Digital Electronics Corporation and inform us of your findings.
- 4) Please be aware that the Digital Electronics Corporation is not responsible for any damages resulting from the use of our products, regardless of article 3.

All Company/Manufacturer names used in this manual are the registered trademarks of those companies.

© Copyright 2000, Digital Electronics Corporation

Table of Contents

PREFACE	I
TABLE OF CONTENTS	II
ESSENTIAL SAFETY PRECAUTIONS	V
WARNINGS	v
CAUTIONS	vii
GENERAL SAFETY PRECAUTIONS	VIII
ABOUT GP-377 SERIES MODELS	X
WHAT IS IP65F?	X
UL/C-UL(CSA) APPROVAL	XI
CE MARKING	XI
PACKAGE CONTENTS	XII
SEPARATELY SOLD MANUAL	XII
DOCUMENTATION CONVENTIONS	XIII

CHAPTER 1 INTRODUCTION

1.1 Prior to Operating the GP	1-1
1.2 System Design	1-2
1.3 Accessories	1-4
1.4 2-Port Feature Overview	1-6

CHAPTER 2 SPECIFICATIONS

2.1 General Specifications	2-1
2.1.1 Electrical	2-1
2.1.2 Structural	2-1
2.1.3 Environmental	2-2
2.2 Functional Specifications	2-3
2.2.1 Display	2-3
2.2.2 Memory and Clock	2-3
2.2.3 Interfaces	2-4
2.3 Interface Specifications	2-5
2.3.1 Serial Interface	2-5
2.4 Names and Functions of GP Parts	2-7
2.5 GP Dimensions	2-8
2.5.1 GP External Dimensions	2-8
2.5.2 GP Installation Fasteners	2-9
2.5.3 GP Panel Cut Dimensions	2-9

CHAPTER 3 INSTALLATION AND WIRING

3.1 Installation	3-1
3.1.1 Installation Procedure	3-1
3.2 Wiring Cautions	3-4
3.2.1 Connecting the GP's Power Cord	3-4
3.2.2 Grounding the GP	3-5
3.2.3 Placement of I/O Signal Lines	3-5
3.3 GP Tool Connector	3-6

CHAPTER 4 OFFLINE MODE

4.1 Entering OFFLINE Mode	4-1
4.1.1 When Turning the GP's Power ON	4-1
4.1.2 From Forced Reset	4-2
4.2 OFFLINE Mode Main Menu	4-3
4.3 INITIALIZATION.....	4-4
4.4 SELF-DIAGNOSIS	4-6
4.5 Transferring Screen Data	4-8

CHAPTER 5 INITIALIZING THE GP

5.1 Initialization Screen.....	5-1
5.2 Initialization Items.....	5-2
5.3 SYSTEM ENVIRONMENT SETUP	5-3
5.3.1 SYSTEM SETUP	5-3
5.3.2 SYSTEM AREA SETUP	5-4
5.3.3 GLOBAL WINDOW SETUP	5-6
5.3.4 CHARACTER STRING DATA SETUP	5-7
5.4 SET UP I/O	5-10
5.4.1 SET UP SIO	5-10
5.4.2 COMMUNICATION SETUP	5-11
5.4.3 SET UP TOUCH PANEL	5-12
5.4.4 DISPLAY SETUP	5-15
5.5 PLC SETUP	5-16
5.5.1 SET UP OPERATION SURROUNDINGS(1:1/n:1).....	5-16
5.5.2 STATION SETUP(n:1).....	5-17
5.5.3 CUSTOMIZE SETUP (n:1)	5-19

5.6 INITIALIZE INTERNAL MEMORY	5-21
5.7 SET UP TIME	5-21
5.8 SET UP SCREEN	5-22
5.9 FONT SETTING	5-23

CHAPTER 6 GP RUN MODE AND ERRORS

6.1 GP RUN Mode	6-1
6.1.1 After Powering Up the GP	6-1
6.1.2 Via OFFLINE Mode	6-1
6.2 Troubleshooting	6-3
6.2.1 Possible Types of Trouble	6-3
6.2.2 Troubleshooting Flow Chart	6-4
6.2.3 No GP/Host Communication	6-7
6.2.4 Touch Panel Does Not Respond	6-9
6.3 SELF-DIAGNOSIS	6-10
6.3.1 GP SELF-DIAGNOSIS Item List	6-10
6.3.2 SELF-DIAGNOSIS - Details	6-11
6.4 Error Messages	6-13
6.4.1 Error Message List	6-13
6.4.2 Error Message Details	6-15

CHAPTER 7 MAINTENANCE

7.1 Regular Cleaning	7-1
7.1.1 Cleaning the Display	7-1
7.1.2 Installation Gasket Check/Replacement	7-1
7.2 Periodic Check Points	7-3
7.3 Changing the Backlight	7-4

INDEX

Essential Safety Precautions

This manual includes procedures that must be followed to operate the GP correctly and safely. Be sure to read this manual and any related materials thoroughly to understand the correct operation and functions of this unit.

Usage of Icons

Throughout this manual the following icons are provided next to GP operation procedures requiring special attention, and provide essential safety information. The following is an example of these icons and their meanings:



Indicates situations where severe bodily injury, death or major equipment damage can occur.



Indicates situations where slight bodily injury or machine damage can occur.

WARNINGS

System Design

- **Do not create switches used to control machine safety operations, such as an emergency stop switch, as a GP touch screen icon. Be sure to install these switches as separate hardware switches, otherwise severe bodily injury or equipment damage can occur.**
- **Please design your system so that equipment will not malfunction due to a communication fault between the GP and its host controller. This is to prevent any possibility of bodily injury or material damage.**
- **The GP is not appropriate for use with aircraft control devices, aerospace equipment, central trunk data transmission (communication) devices, nuclear power control devices, or medical life support equipment, due to these devices' inherent requirements of extremely high levels of safety and reliability.**
- **When using the GP with transportation vehicles (trains, cars and ships), disaster and crime prevention devices, various types of safety equipment, non-life support related medical devices, etc. redundant and/or failsafe system designs should be used to ensure the proper degree of reliability and safety.**

GP Wiring

- **To prevent an electric shock, be sure to confirm that the GP's power cord is not connected to the main power when connecting any cords, cables or lines to the GP.**
- **Do not use power beyond the GP's specified voltage range. Doing so may cause a fire or an electric shock.**

GP Start-up and Maintenance

- **The GP uses a lithium battery for backing up its internal clock data. If the battery is incorrectly replaced, the battery may explode. To prevent this, please do not replace the battery yourself. When the battery needs to be replaced, please contact your local GP distributor.**

GP Installation

- **High voltage runs through the GP. Except for replacing the backlight, never disassemble the GP, otherwise an electric shock can occur.**
- **Do not modify the GP unit. Doing so may cause a fire or an electric shock.**
- **Do not use the GP in an environment where flammable gasses are present, since operating the GP may cause an explosion.**

CAUTIONS

GP Installation

- **Be sure to securely connect all cable connectors to the GP. A loose connection may cause incorrect input or output.**

GP Wiring

- **Ground the GP's FG line separately from other units' FG lines. Putting these FG lines too close may cause an electric shock or unit malfunction. Be sure to use a grounding resistance of 100Ω or less and a 2mm² or thicker wire, or your country's applicable standard.**
- **Correctly wire the GP, be sure that the rated voltage and terminal layout are within the designated range. If the voltage supplied differs from the rated voltage, or incorrect wiring or grounding is performed, it may cause a fire or unit malfunction.**
- **Use only the designated torque to tighten the GP's terminal block screws. If these screws are not tightened firmly, it may cause a short-circuit, fire, or GP malfunction.**
- **Be careful that metal filings and wiring debris do not fall inside the GP, since they can cause a fire, GP malfunction, or incorrect operation.**

GP Start-up and Maintenance

- **The liquid crystal panel contains a powerful irritant and if for any reason the panel is damaged and this liquid contacts any part of your body, be sure to wash that area with running water for 15 minutes. If any of this liquid enters your eye, flush your eye for 15 minutes with running water and contact a physician.**

GP Disposal

- **When this unit is disposed of, it should be done so according to your country's regulations for similar types of industrial waste.**

General Safety Precautions



■ To Prevent the GP From Being Damaged

- Never strike the touch panel with a hard, heavy or pointed object, or press on the touch panel too strongly, since it may damage the unit.
- If the GP is used in an environment with temperatures and humidity in excess of the allowed range, the GP may malfunction and/or its operation life may be shortened.
- Avoid restricting the GP's naturally occurring ventilation, or storing or using the GP in an environment that is too hot.
- Do not use this unit in areas where large, sudden temperature changes can occur. These changes can cause condensation to form inside the unit., possibly causing the unit to malfunction.
- Do not allow water, liquids, metal or charged particles to enter inside the GP's case, since they can cause either a GP malfunction or an electrical shock.
- Avoid using or storing the GP in direct sunlight, or in excessively dusty or dirty environments.
- Because the GP is a precision instrument, do not store or use the unit where large shocks or excessive vibration can occur.
- Do not store or use the GP where chemicals (such as organic solvents, etc.) and acids can evaporate, or where chemicals and acids are present in the air.
- Do not use paint thinner or organic solvents to clean the GP.
- Do not store or operate the LCD display in areas receiving direct sunlight, since the sun's UV rays may cause the LCD display's quality to deteriorate.
- Storing this unit in areas at a temperature lower than is recommended in this manual's specifications may cause the LCD display's liquid to congeal, which may damage the panel. Conversely, if the storage area's temperature becomes higher than the allowed level, the LCD's liquid will become isotropic, causing irreversible damage to the LCD. Therefore, be sure to store the panel only in areas where temperatures are within those specified in this manual.



Due to the possibility of unforeseen accidents, be sure to back up the GP's screen data regularly.

■ About the GP's Display Panel

- The GP's currently displayed data, its voltage^{*1} and brightness setting each affect the intensity of *Contouring*. (i.e, when some parts of the screen are brighter than others, creating a wavelike pattern)
- There are minute grid-points (dark and light) on the Display Panel's surface. This is part of the GP's design and not a defect.
- Shadows may appear at the top of the LCD. This is normal for an LCD display.
- Sometimes the display area may look as if the display colors have changed. This is a common attribute of LCD's and is not a defect.
- Displaying a single image for long periods can cause an afterimage to remain when the display is changed to another screen.

To prevent this effect:

- Use the GP's "Stand-by Mode", which automatically turns the screen OFF when there is no input for a specified period of time.

▼ **Reference** ▲ 5.3.1 System Setup

- Write “FFFFh” in the System Data Area’s “Screen Display Off” address^{*2} to turn the screen display OFF when there is no input for a specified period of time.
- Do not display any single screen for a long period of time. Try to periodically change the screen display.

**1 If the GP's voltage is at the very low end of its allowable range, it may effect the intensity of contouring.*

**2 The following addresses assume all System Data Area settings are entered. If they are not all entered, the correct word address may be different from those given here.*

When using the Direct Access Method ----- System Data Area's word address +9

About GP-377 Series Models

The GP-377 Series refers to the following GP model number:

Series	Model Name	Model Type	Comments
GP-377 Series	GP-377L	GP377-LG11-24V	Standard unit ^{*1}
		GP377-LG41-24V	CE Marked, UL/cUL (CSA) Approved unit
	GP-377S	GP377-SC11-24V	Standard unit ^{*1}
		GP377-SC41-24V	CE Marked, UL/cUL (CSA) Approved unit

**1 "Standard Unit" indicates a unit that is not approved by international safety standards.*

What is IP65f?

This unit's protection rating of IP65f is actually a composite code, consisting of the internationally recognized British "Ingress Protection" standard (BS EN 60529:1992) - "IP65", and the standard developed by the Japanese Electronics Manufacturer's Association (JEMA) - "f". This code is used in this manual to identify a given product's degree of structural resistance to a variety of environmental elements and thus, prevent problems or accidents related to the inappropriate use of a product.

The individual meaning of each character of this code is explained below. This code indicates the degree of ingress protection provided from the front face of the GP, and assumes that the GP is securely mounted into a metal panel.

IP	6	5	f
(1)	(2)	(3)	(4)

- (1) Designates the type of protection provided.
- (2) Indicates the degree of protection provided to the human body by the unit, and the degree of protection provided by the unit's front face from particles/dust intrusion into the interior of the unit.
Here, "6" indicates that the unit is completely protected from dust intrusion.
- (3) Indicates the degree of protection provided by the unit's front face from water intrusion into the interior of the unit.
Here, "5" indicates that the unit is protected from water intrusion from a direct water jet.
- (4) Indicates the degree of protection provided by the unit's front face from oil particle intrusion into the interior of the unit.
Here, "f" indicates that the unit is completely protected from oil intrusion via either oil particles or oil splashes from any direction (to the front panel).

UL/c-UL(CSA) Approval

The GP377-LG41-24V, and the GP377-SC41-24V units are UL/c-UL listed products. (UL file No.E182139)

This unit conforms to the following standards:

- **UL508**

Industrial Control Equipment

- **UL1604**

For use with Electrical Equipment in Class I and II, Division 2 and Class III Hazardous (Classified) Locations in industrial control applications.

CAN/CSA-C22.2, Nos. 142 and 213-M1987

Standard for Safety of Information Technology Equipment, including Electrical Business Equipment.

GP377-LG41-24V (UL Registration Model: 2880011-02)

GP377-SC41-24V (UL Registration Model: 2880011-01)

<Cautions>

- The GP must be used as a built-in component of an end-use product.
- This unit should be installed in the front face of a metal panel.
- If this unit is installed so as to cool itself naturally, be sure to install it in a vertical panel. Also, be sure that the GP is mounted at least 100 mm away from any adjacent structures or equipment. If these requirements are not met, the heat generated by the GP's internal components may cause the unit to fail to meet UL/cUL standard requirements.

UL1604 Conditions of Acceptability and Handling Cautions:

1. Power, input and output (I/O) wiring must be in accordance with Class I, Division 2 wiring methods - Article 501- 4(b) of the National Electrical Code, NFPA 70 within the United States, and in accordance with Section 18-152 of the Canadian Electrical Code for units installed within Canada.
2. Suitable for use in Class I, Division 2, Groups A, B, C and D, Hazardous Locations.
3. **WARNING:** Explosion hazard - substitution of components may impair suitability for Class I, Division 2.
4. **WARNING:** Explosion hazard - when in hazardous locations, turn power OFF before replacing or wiring modules.
5. **WARNING:** Explosion hazard - do not disconnect equipment unless power has been switched OFF, or the area is known to be non-hazardous.

CE Marking

The GP377-LG41-24V, and GP377-SC41-24V are CE marked products that conforms to EMC directives EN55011 class A and EN50082-2.

** For detailed CE marking information, please contact your local GP distributor.*

Package Contents

The GP's packing box contains the items listed below. Please check to confirm that all items shown below have been included.

■ **GP Units**

GP377-LG11-24V, GP377-LG41-24V
GP377-SC11-24V, GP377-SC41-24V

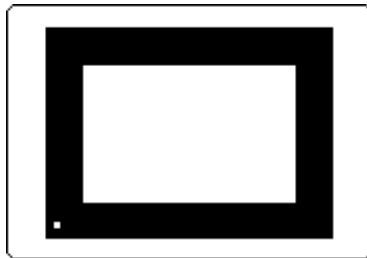

■ **Installation Guide (1)**

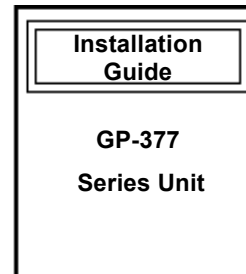

■ **Installation Fasteners (4/set)**

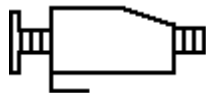

This unit has been carefully packed, with special attention to quality. However, should you find anything damaged or missing, please contact your local GP distributor immediately for prompt service.

Separately Sold Guide





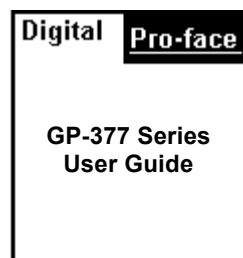

This guide (GP-377 Series User Guide) is sold separately.

■ **GP-377 Series User Guide (1)**



Documentation Conventions

The list below describes the documentation conventions used in this manual.

Symbol	Meaning
 <i>Warning</i>	Used to indicate situations where severe bodily injury, death or major machine damage can occur.
 <i>Caution</i>	Indicates situations where slight bodily injury or machine damage can occur.
 <i>Important</i>	Indicates important information or procedures that <u>must</u> be followed for correct and risk-free software/device operation.
 <i>Careful!</i>	Indicates information or procedures that must be followed to ensure proper software/device setup and operating conditions.
	Indicates actions/procedures the User should not attempt.
*1	Indicates useful or important supplemental information.
1) , 2)	Indicates steps in a procedure. Be sure to perform these steps in the order given.
 Reference	Refers to useful or important supplemental information.
 Note:	Provides useful or important supplemental information.
GP Screen Editor	Indicates the GP-PRO/PBIII for Windows screen editor software.
PLC	Abbreviation for Programmable Logic Controller.
n:1	Indicates a multi-link type connection is used.

Memo

Chapter

1 Introduction

1. Prior to Operating the GP
2. System Design
3. Accessories

1.1 Prior to Operating the GP

Be sure to follow these steps when creating projects for the GP unit.

- 1 Preparation** Before using the GP, check that all required hardware is present and read all specification, wiring, and installation information.
Reference Chapter 2, "Specifications", and Chapter 3, "Installation and Wiring"
- 2 Screen Design** Create a sample screen and design a Tag layout, with the Screen layout sheets and Tag lists provided in the Editor software.
Reference GP-PRO/PBIII for Windows Operation Manual (included with the screen creation software)
- 3 Select GP and PLC types** Using the input areas provided, select the GP and the PLC types to be used.
Reference GP-PRO/PBIII for Windows Operation Manual (included with the screen creation software)
- 4 Create Screen/ Run Screen Setup** Setup the screen and tags in your screen editing software according to your Screen Design.
Reference GP-PRO/PBIII for Windows Operation Manual and Tag Reference Manual (included with the screen creation software)
- 5 Transfer Screen Data** Transfer the data from the Screen design software on your PC to the GP unit using the Downloading Cable.
Reference GP-PRO/PBIII for Windows Operation Manual (included with the screen creation software)
- 6 GP/Host Connection** Set up the GP so that it can receive data from the Host (PLC).
Reference Chapter 4-3, "Initialize", and PLC Connection Manual
- 7 Connect the GP** Link the GP with the host (PLC) using the appropriate connection cable (different cables may be necessary for different hosts), and then run the unit.
Reference GP-PRO/PBIII for Windows PLC Connection Manual (included with the screen creation software)

1.2 System Design

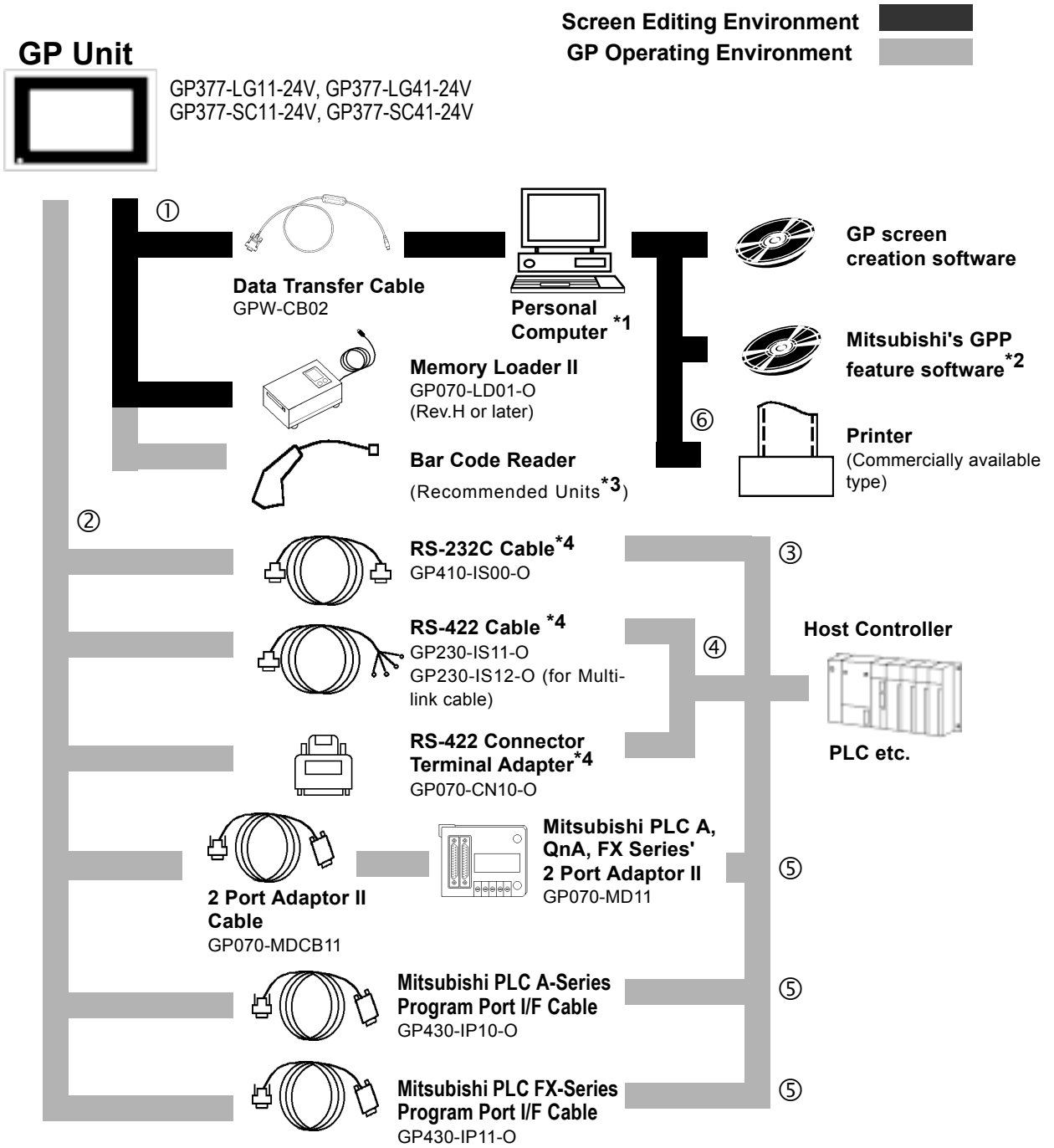

GP Interfaces

- ① Tool Connector
- ② Serial Interface

Personal Computer Interfaces

- ⑥ Printer Interface

PLC Interfaces

- ③ RS-232C Port
- ④ RS-422 Port
- ⑤ Programming Port

Chapter 1 - Introduction

*1 For range of compatible PCs refer to the following manual.

Reference *GP-PRO/PBIII for Windows Operation Manual* (included with the screen creation software)

*2 For information about compatible PLC types and software, please refer to

Reference *GP-PRO/PBIII for Windows PLC Connection Manual* (included with the screen creation software)

*3 Recommended Units:

Aimex Corporation	OPT Electronics			Tohken	
	Reading Width	Touch Scanner Type	Keyboard Connection Type	Reading Width	Touch Scanner Type
BR-331 PC2 (Pen type)	60mm	OPT-1125-WL 98	OPT-1125-WD 98	65mm	TCD-5510M
	80mm	OPT-5125-WL 98	OPT-5125-WD 98	82mm	TCD-5510L
	100mm	LT-2125-WL 98	LT-2125-WD 98	105mm	TCD-5510W

*4 Certain types and models of PLCs cannot be connected.

Reference *GP-PRO/PBIII for Windows PLC Connection Manual* (included with the screen creation software)

1.3 Accessories

All optional equipment listed below is produced by Digital.

■ Available Software

Product Name	Model No.	Description
GP-PRO/PB III for Windows Ver.4.0 or later	GPW-PB01M-V40 <CD-ROM>	Software to be used to create the GP's screen data using a personal computer.

■ Tool Connector

Product Name	Model No.	Description
Screen Data Transfer Cable	GPW-CB02	Connects the GP to a personal computer. It transfers screen data and user program(s).
Memory Loader II	GP070-LD01-O	Copies data (system and screen data) from one GP to another GP. Rev. H or later

■ Serial Interface



Product Name	Model No.	Description
RS-232C cable *1	GP410-IS00-O	Interface cable between the host (PLC) and GP.
RS-422 cable *1	GP230-IS11-O GP230-IS12-O(for Multi-link)	
RS-422 cable Connector terminal block conversion	GP070-CN10-O	Conversion adapter to convert serial data to RS-422 format.
2 Port Adapter II	GP070-MD11	Interface unit that allows use of both GP and Mitsubishi A,Q, C and FX series equipment in the same location.
2 Port Adapter II Cable	GP070-MDCB11	Connects the GP to 2 Port Adapter II.
Mitsubishi A Series Programming Port I/F cable	GP430-IP10-O	Connects directly to Mitsubishi's PLC I/F Programming Console. Simultaneous use of program console, however, is not possible.
Mitsubishi FX Series Programming Port I/F cable	GP430-IP11-O	

*1 For detailed information about range of connectable PLCs.

Reference *GP-PRO/PBIII for Windows PLC Connection Manual (included with the screen creation software)*



Chapter 1 - Introduction

■ Options

Product Name	Model No.	Description
Screen Protection Sheet 	Soft type: GP370-COVER-20P Hard type: GP370-DF10-0	Disposable protective and dirt-resistant sheet for the GP's screen. The GP's touch panel can be used with this cover sheet attached.
Screen Protection Cover 	GP370-DC11	A silicon gum cover which protects GP's screen from condensation and chemicals.

■ Optional Maintenance Items

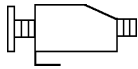
These optional items were included in either the GP itself or in its packing box. These items are sold separately as optional maintenance items.

Product Name	Model No.	Description
Backlight 	GP377L/S-BL00-MS	Spare Backlight
Installation fastener 	GP070-AT00-MS	Fasteners to attach the GP to a panel.
Moisture resistant gasket 	GP370-WP10-MS	Provides a moisture resistant seal when installing the GP. Same as the seal included in the GP's original equipment package.

1.4 2-Port Feature Overview

You can now use Mitsubishi's GPP software (ladder programming software) on your PC while you connect the Mitsubishi PLC to the GP and the GP to your PC. You can send ladder logic data to and from the PLC, via the GP's Internal 2 port-feature. With the GP377 Series unit, you can use the 2-Port feature by simply connecting the GP and your PC via the data transfer cable (GPW-CB02) without using the external 2-Port Adapter.

For information about PLC types and GP compatibility with GP-377 Series units, refer to **Reference** *GP-PRO/PBIII for Windows PLC Connection Manual* (included with the GP screen creation software)

■ When Using GP-377 Series unit's Internal 2-Port feature ^{*1}

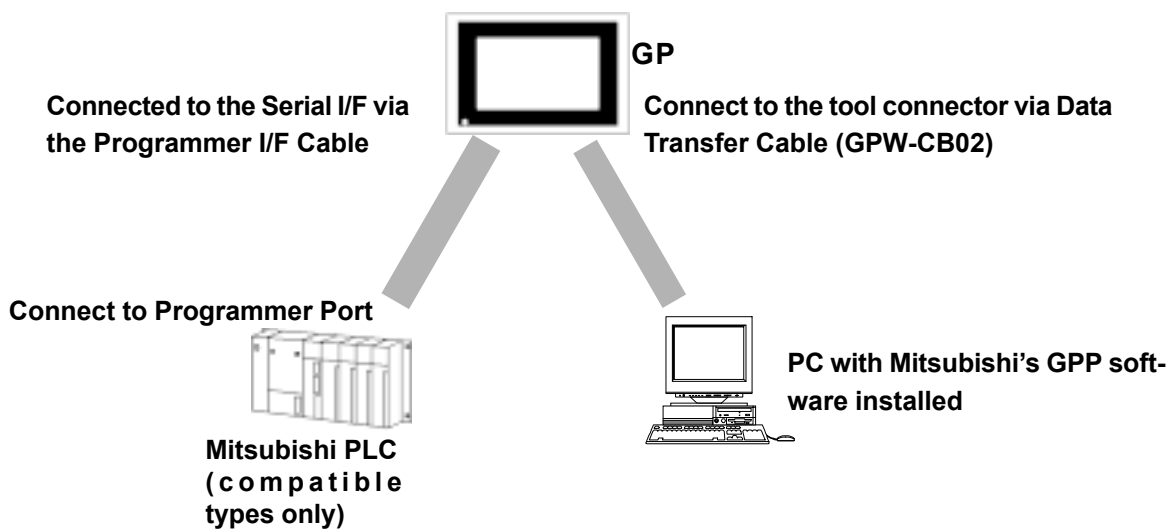

■ When Using the External 2-Port Adapter Cable ^{*2}

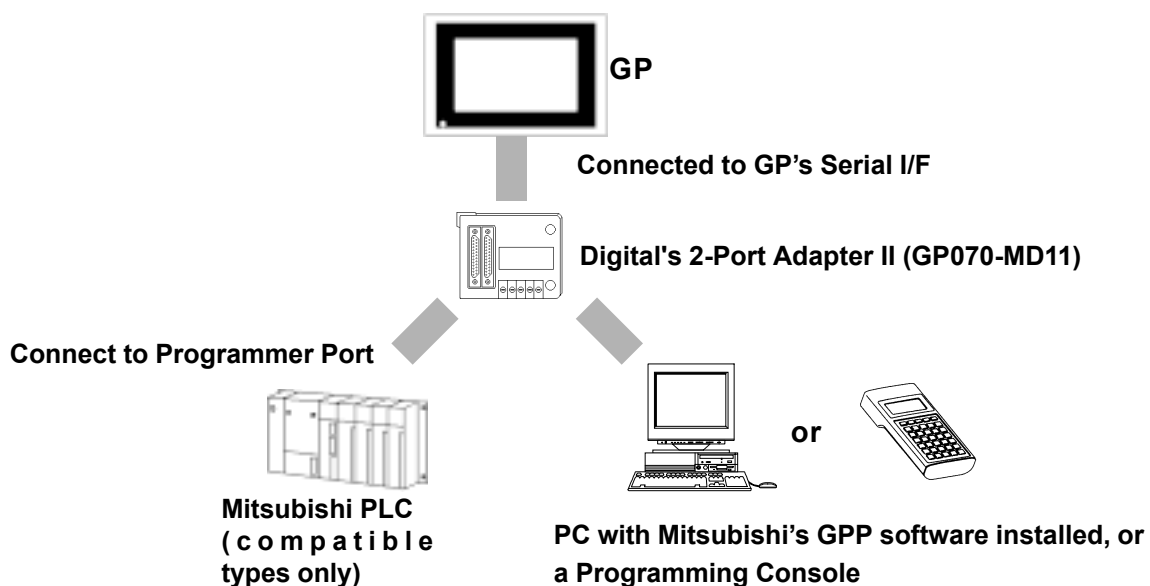

^{*1} The Device Monitor feature can also be used at the same time. For details about the device monitor function, refer to **Reference** *GP-PRO/PBIII for Windows PLC Connection Manual* (included with the GP screen creation software)

^{*2} GP-377 Series units can also use the 2-Port Adapter II.

■ Internal 2-Port Feature Usage Notes

- To use the Internal 2-Port feature, you will need to adjust your GP's settings. For information about these settings, refer to **▼Reference▲ GP-PRO/PBIII for Windows PLC Connection Manual** (included with the GP Screen creation software)
- This feature can be used only while the GP is in ONLINE mode.
- Since the internal 2-Port feature uses the GP's single tool connector, you will not be able to use optional equipment which requires the tool connector (i.e. a Barcode Reader, etc.)
- If you transfer screen data while the GP is in ONLINE mode, the screen will not change to the data transfer screen automatically. Thus, you will need to change the screen manually to the OFFLINE mode's [Main Menu/Transfer] screen. **▼Reference▲ 4.5 Transferring Screen Data**
- Peripheral equipment which cannot be connected to the GP's tool connector (such as a Programming Console) is not compatible with the GP's Internal 2-Port feature. To use this type of equipment, you will need to use the external 2-Port Adapter II.

Memo

Chapter

2 Specifications

1. General Specifications
2. Functional Specifications
3. Interface Specifications
4. Names and Functions of GP Parts
5. Graphic Panel Dimensions

2.1 General Specifications

2.1.1 Electrical

Input Voltage	DC24V \pm 15%
Power Consumption	20W or less
Allowable Voltage Drop	2ms or less
Voltage Endurance	AC1000V 10mA for 1 minute (between charging and FG terminals)
Insulation Resistance	20M Ω or higher at DC500V (between charging and FG terminals)

2.1.2 Structural

Ratings (For front face of installed unit)	Equivalent to IP65f (JEM1030) and NEMA #250 TYPE 4X/12
Weight	900g (2.0lb) or less (main unit only)
Cooling Method	Natural air circulation
External Dimensions	171mm (6.73in.) <W> x 138mm (5.43in.) <H> x 57mm (2.24in.) <D> (main unit only)
Panel Cut Dimensions	156 $\begin{smallmatrix} +1 \\ 0 \end{smallmatrix}$ 123.5 $\begin{smallmatrix} +1 \\ 0 \end{smallmatrix}$ mm (Panel thickness: 1.6 to 5mm)

*1 See note on following page.

(from previous page)

**1 The front face of the GP unit, installed in a solid panel, has been tested using conditions equivalent to the standard shown in the specification. Even though the GP unit's level of resistance is equivalent to the standard, oils that should have no effect on the GP can possibly harm the unit. This can occur in areas where either vaporized oils are present, or where low viscosity cutting oils are allowed to adhere to the unit for long periods of time. If the GP's front face protection sheet becomes peeled off, these conditions can lead to the ingress of oil into the GP and separate protection measures are suggested. Also, if non-approved oils are present, it may cause deformation or corrosion of the front panel's plastic cover. Therefore, prior to installing the GP be sure to confirm the type of conditions that will be present in the GP's operating environment.*

If the installation gasket is used for a long period of time, or if the unit and its gasket are removed from the panel, the original level of the protection cannot be guaranteed. To maintain the original protection level, you need to replace the installation gasket regularly.

2.1.3 Environmental

Ambient Operating Temperature	0°C to +50°C
Storage Temperature	-20°C to +60°C
Ambient Humidity	20%RH to 85%RH (No condensation)
Vibration Resistance	10Hz to 25Hz (19.6m/s ² in X, Y, Z directions for 30min.)
Noise Immunity (via noise simulator)	Noise Voltage: 1000Vp-p
	Pulse Duration: 1μs
	Arise Time: 1ns
Electrostatic Discharge Immunity	GP377-**11-24V: 4kV (complies with IEC 61000-4-2 Level 2)
	GP377-**41-24V: 6kV (complies with IEC 61000-4-2 Level 3)
Atmosphere	Less than 0.1mg/m ³ of conductive dust, free of corrosive gasses
Grounding	100Ω or less, or your country's applicable standard

2.2 Functional Specifications

2.2.1 Display

	GP-377L	GP-377S
Type	Monochrome LCD	STN type color LCD
Colors	Monochrome	64 colors (RGB-4 levels)
Backlight	CCFL (lifespan = more than 30,000 hours, when continuously lit)	
Resolution	320 x 240pixels	
Nominal Display Area	115.2mm (W) x 86.4mm (H)	
Brightness Control	4 levels of adjustment available via touch panel.	
Contrast Control	8 levels of adjustment available via touch panel.	
Language Fonts	ANK : 158 types, Kanji : 6962 types (including 607 non-kanji characters) Chinese, European, Korean, Taiwanese fonts are available	
Text	8x8 dot font	40 Char. per row, 30 rows
	8x16 dot font	40 Char. per row, 15 rows
	16x16 dot font	20 Char. per row, 15 rows
	32x32 dot font	10 Char. per row, 7 rows
Font Sizes	Both height and width can be expanded 1, 2, 4, or 8 times.	
Display Sizes ^{*1}	8X8 dot font, 8X16 dot font, 16X16 dot font and 32X32 dot font	
Touch Panel	16X12 Keys/Screen (1 or 2 point touch)	

2.2.2 Memory and Clock

Application	1MB FLASH EPROM (Approx. 320 screens at 3.2KB/screen)
Data Backup	96KB SRAM (uses lithium battery) ^{*2}
Internal Clock Accuracy	+ 65 seconds/month (at 25°C) ^{*3}

**1,2 and 3 See notes on the following page.*



- *1 The display font will differ depending on which (country's) character, or which size you select. For detailed information refer to **Reference** Chapter 5.9 *Font Setting*.
- *2 A Lithium battery's lifetime is:
 - 10 years when the battery's ambient temperature is under 40 °C
 - 4.1 years when the battery's ambient temperature is under 50 °C
 - 1.5 years when the battery's ambient temperature is under 60 °C

When used for backup:

 - Approximately 60 days, with a fully charged battery
 - Approximately 6 days, with a half-charged battery
- *3 The GP's internal clock has a slight error. At normal operating temperatures and with the GP's power turned OFF, i.e. in "backup mode", the degree of error is 65 seconds per month. Variations in operating conditions and battery life can cause this error to vary from +90 to -380 seconds per month. For systems where this degree of error will be a problem, the user should be sure to monitor this error and make adjustments when required.

2.2.3 Interfaces

Serial Interface	Asynchronous Transmission Method: RS232C/RS422 Data Length: 7 or 8 bits Stop Bit: 1 or 2 bits Parity: None, Odd or Even Data Transmission Speed: 2400 to 115.2kbps
Tool Connector	Asynchronous TTL level nonprocedure command I/F <During Program Development> For connecting the Data Transfer cable when downloading data from the GP-PRO/PBIII screen editor software. <During Standard Operation> When using the 2-Port function, and for connecting peripheral equipment, i.e. a bar code reader, etc.

2.3 Interface Specifications

2.3.1 Serial Interface

Pin Connection	Pin #	Signal Name	Condition
	1	FG	Frame ground
	2	SD	Send data (RS-232C)
	3	RD	Receive data (RS-232C)
	4	RS	Request send (RS-232C)
	5	CS	Clear send (RS-232C)
	6	NC	No connection
	7	SG	Signal ground
	8	CD	Carrier detect (RS-232C)
	9	TRMX	Termination (RS-422)
	10	RDA	Receive data A (RS-422)
	11	SDA	Send data A (RS-422)
	12 ^{*1}	RESERVE	Reserved
	13 ^{*1}	RESERVE	Reserved
	14	VCC	5V±5% output 0.25A
	15	SDB	Send data B (RS-422)
	16	RDB	Receive data B (RS-422)
	17	NC	No connection
	18	CSB	Clear send B (RS-422)
	19	ERB	Enable receive B (RS-422)
	20	ER	Enable receive (RS-232C)
	21	CSA	Clear send A (RS-422)
	22	ERA	Enable receive A (RS-422)
	23	BUZZ GND	External buzzer ground
	24	NC	No connection
	25	BUZZ OUT	External buzzer output

*1 #12 and #13 are RESERVED; do not connect to these pins.

Recommended Connector: Dsub25pin plug XM2A-2501<made by OMRON>

Recommended Cover: Dsub25pin cover XM2S-2511<made by OMRON>

Jack Screws: XM2Z-0071<made by OMRON>



- Use rough metric type M2.6x0.45 p threads used to secure the cable's set screws.

Recommended Cable: CO-MA-VV-SB5PX 28AWG <made by HITACHI Cable Ltd.>

- To confirm your PLC's connection specifications

▼ Reference ▲ PLC Connection Manual (included with the screen creation software)



When creating your own cable, follow the instructions listed below:

<With RS-422>

- The following pairs of pin #'s must be connected to each other.
 - #18 (CSB) <—> #19 (ERB)
 - #21 (CSA) <—> #22 (ERA)
- When connecting the RS-422 cable and the #9 (TRMX) and #10 (RDA) points, a termination resistance of 100Ω is added between RDA and RDB.
- When making a cable for a Memory Link system, be sure to use a 4-wire type.

<With RS-232C>

- Do not use the following pins: 9 (TRMX), 10 (RDA), 11 (SDA), 15 (SDB), 16 (RDB), 18 (CSB), 19 (ERB), 21 (CSA), 22 (ERA).
- The #1 (FG) terminal should only be connected if it is required by the device being connected to.

<Buzzer Output>

#23 (BUZZ GND) and #25 (BUZZ OUT) are used for Buzzer Output.

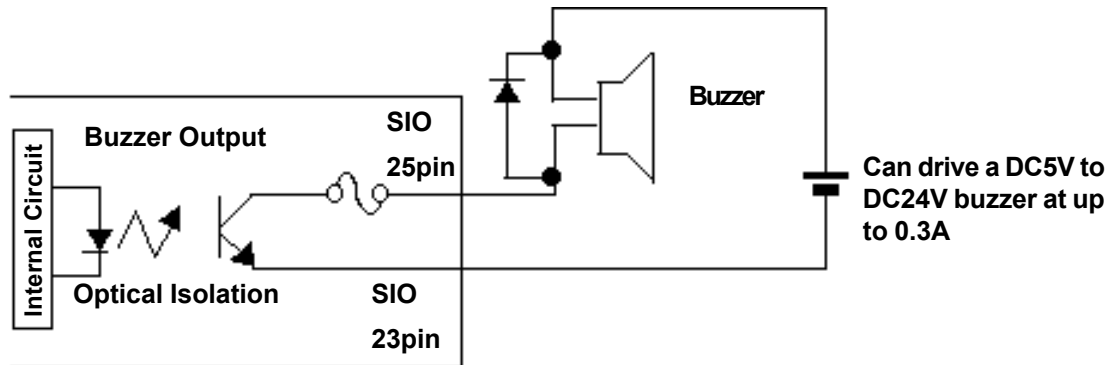

GP-377 unit (internal circuit)



Important

- *This unit's RS485(RS422) port is not isolated, therefore, it is important that you connect the SG/GND (Signal Ground) terminals. If this is not done, the RS485(RS422) circuit may be damaged.*
- *Pin 14 (VCC) DC5V output is not protected. To prevent damage or unit malfunction, be sure to use only the designated level of current.*

2.4 Names and Functions of GP Parts

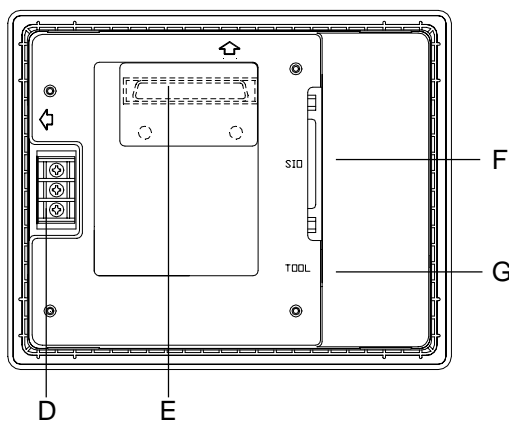
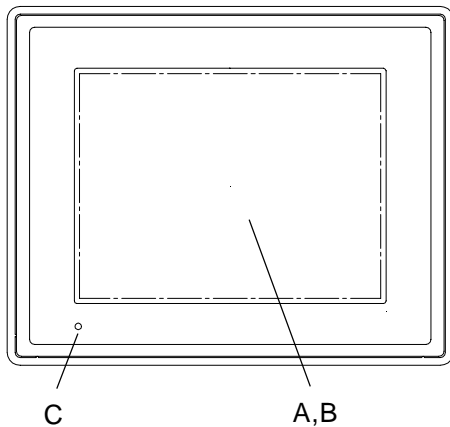

A: Display Panel

The GP monitor screen displays the screen setup and corresponding PLC host data.

GP-377L Monochrome LCD

GP-377S STN type Color LCD

B: Touch Panel

Performs any screen change operations and sends data to the PLC.

C: Status LED

This LED reflects the GP's condition.

LED	GP status
OFF	Power OFF
Green	Normal operation
Orange	Replace backlight

D: Power Input Terminal Block

The input and ground terminals for the power cable.

E: Expansion Interface

Used for expansion boards.

F: Serial Interface

Used for the RS-232C and RS-422 (Serial) cables. Is connected to the Host (PLC).

G: Tool Connector

The Data Transfer cable, Bar Code Reader or Memory Loader can be connected here.

2.5 GP Dimensions

2.5.1 GP External Dimensions



Note: For detailed dimension information, please contact your local GP distributor.

Unit: mm (in.)

Top View

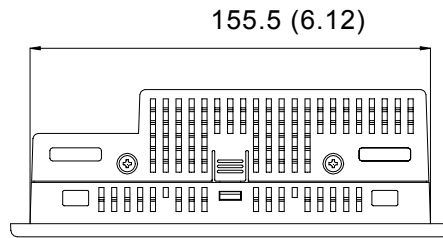

Front View

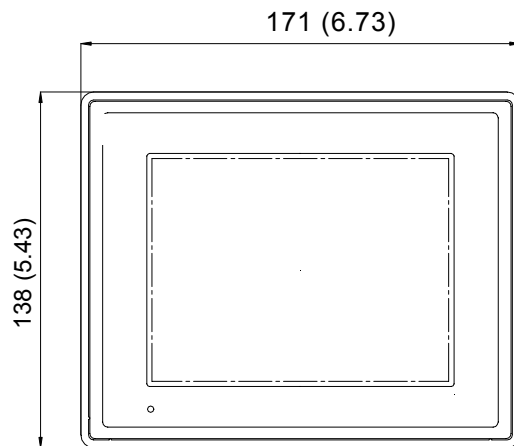

Side View

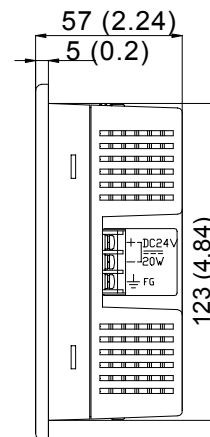

Rear View

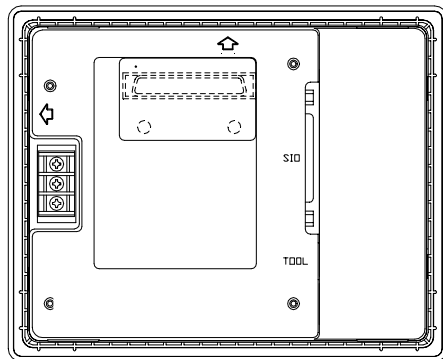

Chapter 2 - Specifications

2.5.2 GP Installation Fasteners

Unit: mm (in.)

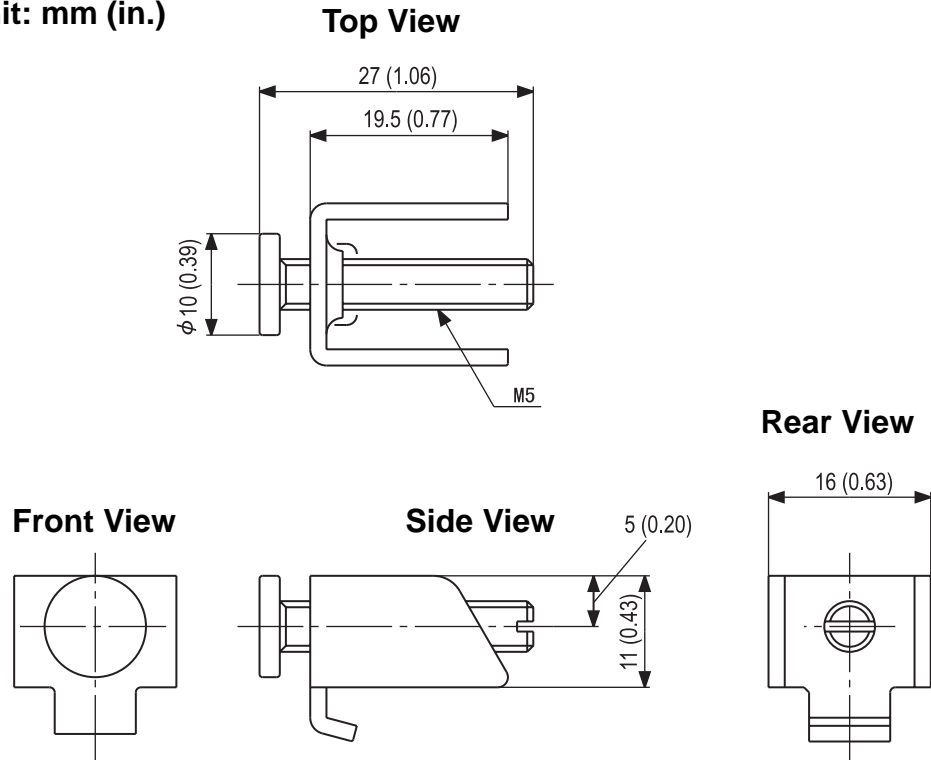

2.5.3 GP Panel-Cut Dimensions

Unit: mm (in.)

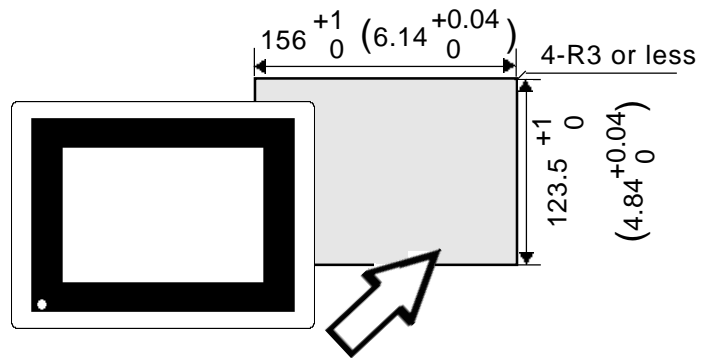

Memo

Chapter

3 Installation and Wiring

1. Installation
2. Wiring Cautions
3. GP Tool Connector

3.1 Installation

3.1.1 Installation Procedure



Before installing the GP into a cabinet or panel, check that the installation gasket is securely attached to the unit.

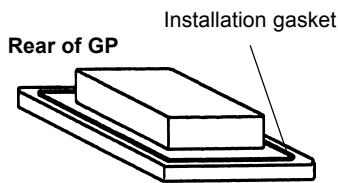

It is strongly recommended that you use the gasket since it absorbs vibration in addition to repelling water.

Place the PL on a level surface with the display panel facing downward. Check that the GP's installation gasket is seated securely into the gasket's groove, which runs around the perimeter of the panel's frame. For details about installing the gasket, refer to

Reference 7.1.2 *Installation Gasket Replacement*

■ Creating a Panel Cut Out

Create the correct sized opening required to install the GP, using the installation dimensions given.

Reference 2.5.3 *"GP Panel Cut Out Dimensions"*

The installation gasket, installation brackets and attachment screws are all required when installing the GP.

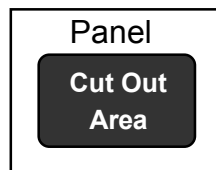

- Check that the installation panel or cabinet's surface is flat, in good condition and has no jagged edges.
- Panel thickness should be from 1.6mm (0.06in.) to 5.0mm (0.2in.).

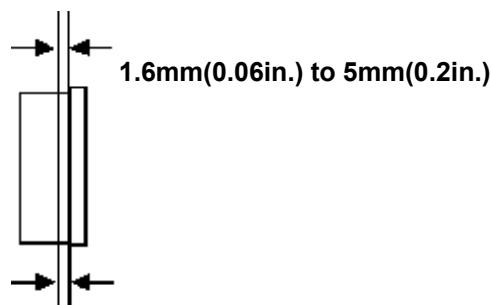

Decide the panel's thickness based on the level of panel strength required.



- For easier maintenance, operation, and better ventilation, be sure to install the GP-377 unit at least 100mm away from adjacent structures and other equipment.

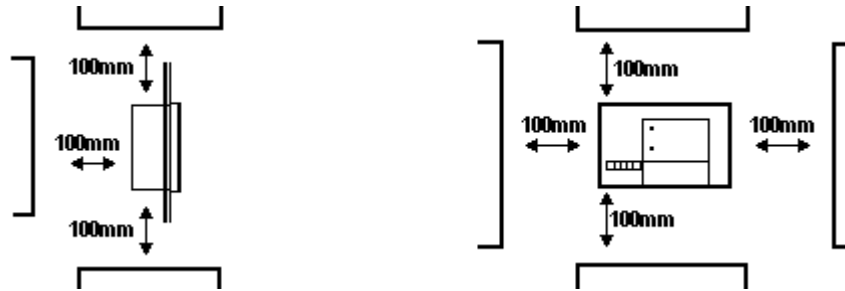

- Be sure that the ambient operation temperature and the ambient humidity are within their designated ranges.
- Be sure that heat from surrounding equipment does not cause the GP-377 to exceed its standard operating temperature.
- When installing the Gp unit in a slanted panel, the panel face should not incline more than 30°.

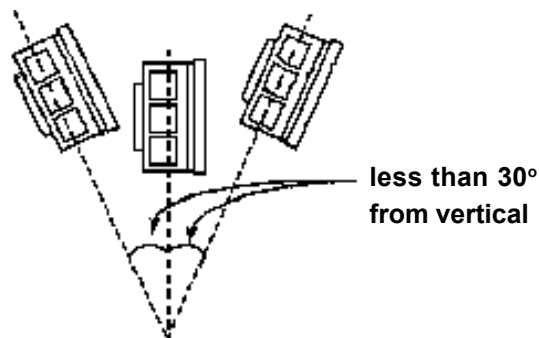

- When installing the GP unit in a slanted panel, and the panel face inclines more than 30°, the ambient temperature must not exceed 40 °C. You may need to use forced air cooling (fan, A/C) to ensure the ambient operating temperature is 40 °C or below.
- When installing the GP vertically, orient the unit so that the Power Terminal Block is vertical, not horizontal.

■ Installation Direction

Insert the GP into the panel from its front face.

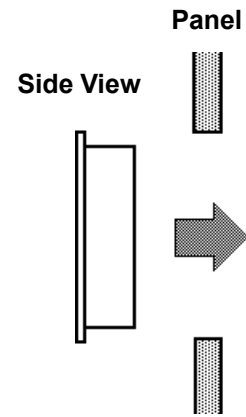
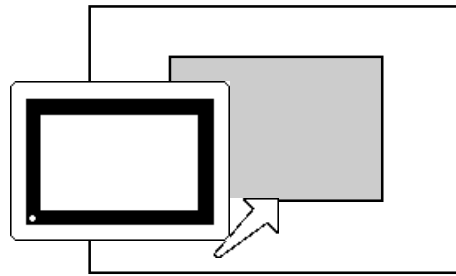

■ Securing the Installation Fasteners

1) There are four (4) insertion slots on the top and bottom of the GP, where the metal installation fasteners hook on.

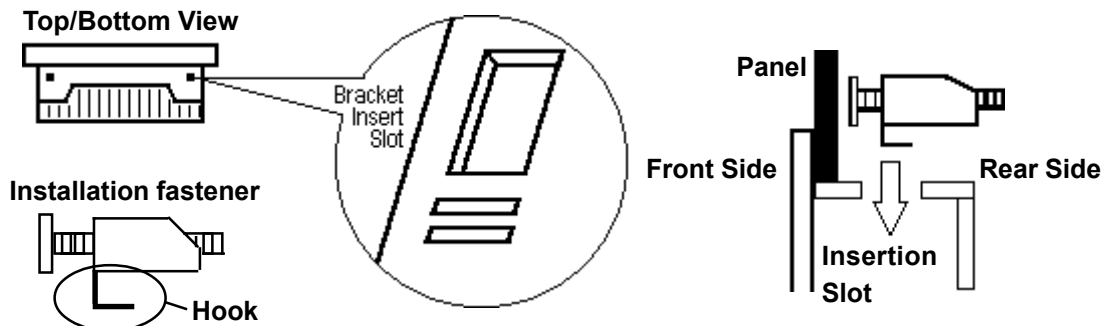

2) Insert each of the fasteners into its slot as shown below. Be sure to pull the fastener back until it is flush with the rear of the attachment hole.

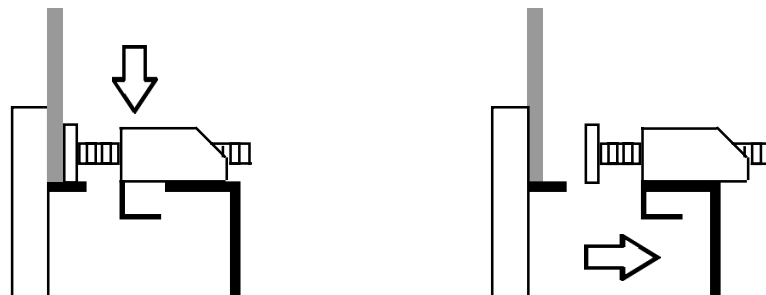

3) Use a screw driver to tighten the attachment screws and secure the GP unit in place.

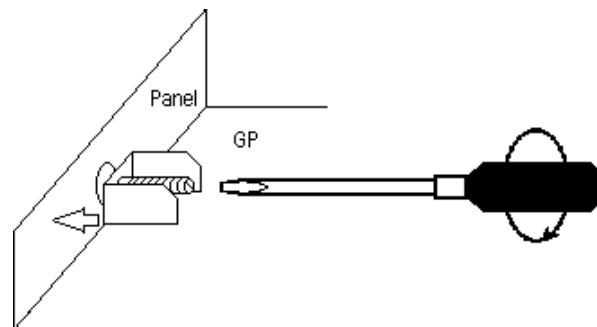

A torque of only 0.5 to 0.6 N·m is required to tighten an attachment screw. Do not use too much force, since it may damage the GP unit.

3.2 Wiring Cautions

3.2.1 Connecting the GP's Power Cord



WARNINGS

- To avoid electric shocks, be sure the Power Cord is unplugged from the power outlet when connecting the power terminals to the GP unit.
- GP-377 Series units accept DC 24V power input only. Using an incorrect power supply will result in damage to both the power supply and the GP.
- Re-attach the GP Terminal Strip's clear plastic cover after completing wiring. If the Cover is not installed, it may cause an electric shock.



When the FG terminal is connected, be sure the wire is grounded. Not grounding the GP unit will result in excessive noise.



- Wherever possible, use thick wires (max 2mm²) for power terminals, and twist the exposed wire ends when connecting the Ring Terminals.
- Please use the following size Ring Terminals.

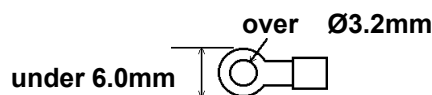

- To prevent the Ring Terminals from causing a short when the terminal block attachment screws are loosened, be sure to use sleeve-type Ring Terminals.

● Connect the GP Power Supply Terminals as follows:

- 1) Be sure that the GP's Power Cord is not plugged in to the power supply.
- 2) Remove the Terminal Strip's clear plastic cover.
- 3) Remove the screws from the three (3) middle terminals, position the Ring Terminals as shown above and re-attach the screws. (Check each wire to make sure the connections are correct)
- 4) Re-attach the Terminal Strip's clear plastic cover.



A torque of only 0.5 to 0.6 N·m is required to tighten an attachment screw.

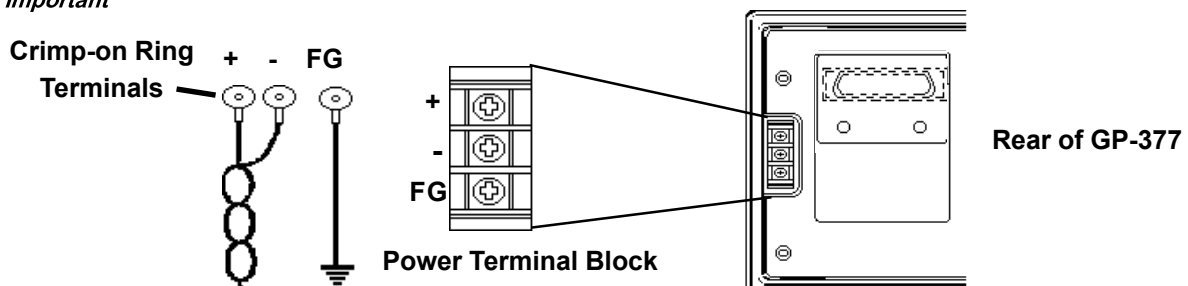

3.2.2 Grounding the GP

CAUTION

Do not use common grounding, since it can lead to an accident or machine malfunction.

(a) Exclusive Grounding (BEST) *1

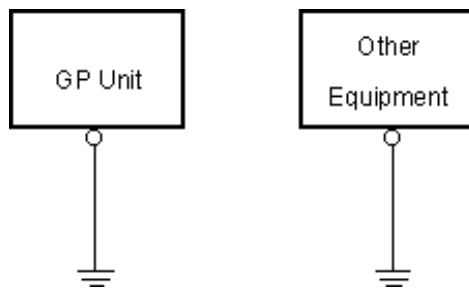

Connect the FG terminal found at the back of the unit to an exclusive ground. [diagram (a)].



- Check that the grounding resistance is less than 100Ω .
- The grounding wire should have a cross sectional area greater than 2mm^2 . Set the connection point as close to the GP unit, and make the wire as short, as possible. When using a long grounding wire, replace the thin wire with a thicker wire, placed in a duct.

(b) Common Grounding (OK) *1

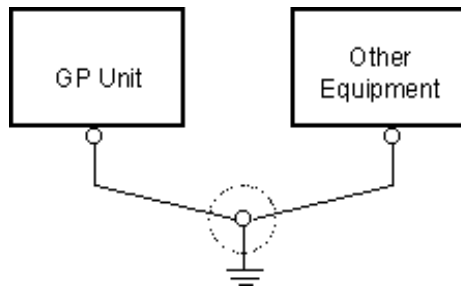

If exclusive grounding is not possible, use a common connection point. [diagram (b)]

(c) Common Grounding (Not OK)

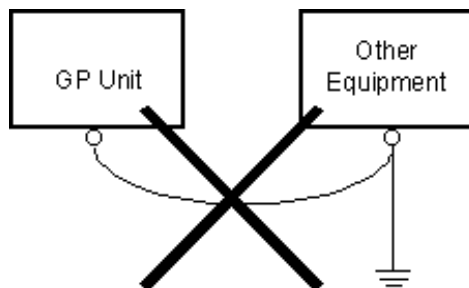

If the equipment does not function properly when grounded, disconnect the ground wire from the FG terminal.

3.2.3 Placement of I/O Signal Lines

- Input and output signal lines must be separated from the power control cables for operating circuits.
- If this is not possible, use a shielded cable and connect the shield to the GP's frame.

*1 Use a grounding resistance of less than 100Ω and a 2mm^2 or greater thickness wire, or your country's applicable standard. For details, contact your local GP distributor.

3.3 GP Tool Connector

The GP's Data Transfer Cable, Memory Loader, or the Bar Code Reader can be attached to the GP's side face Tool Connector.

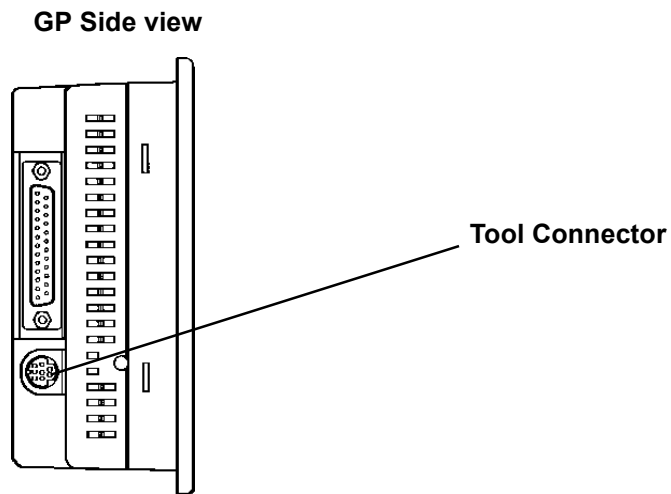

- ***Before unplugging any connector(s) from the GP, be sure the GP's power cord is unplugged from the main power supply.***
- ***Do not connect or disconnect any equipment to or from the GP's Tool Connector while the GP's Power cord is connected.***
- ***When the Bar Code Reader uses a separate power supply:***
 - ***Turn the Bar Code Reader ON before turning the GP ON.***
 - ***Turn the GP OFF before turning the Bar Code Reader OFF.***

Chapter

4 OFFLINE Mode

1. Entering OFFLINE Mode
2. OFFLINE Mode's Main Menu
3. INITIALIZATION
4. SELF-DIAGNOSIS
5. Transferring Screen Data

OFFLINE Mode provides access to the Initialize, Self-Diagnosis, and other features built into the GP. You will need to change the GP to OFFLINE mode before you can use any of these features.



OFFLINE mode is unavailable in a completely new GP until the necessary Screen Data has been transferred from the screen editor software. Be sure the GP's power cord is plugged in and no images are displayed on the GP screen. When data is transferred from your PC to the GP, the necessary System Data will be sent.

Reference For information about transferring data to the GP, refer to GP-PRO/PBIII for Windows Operation Manual (included with the screen creation software)

4.1 Entering OFFLINE Mode

To INITIALIZE the setup or run SELF-DIAGNOSIS in the GP unit, transferring to the OFFLINE mode becomes necessary. There are two ways to enter OFFLINE mode. First, immediately after plugging in the GP's power cord, and second, by using the Force Reset feature.

4.1.1 When Turning the GP's Power ON

Touch the upper left-hand corner of the GP screen within 10 seconds of plugging in the GP's power cord.

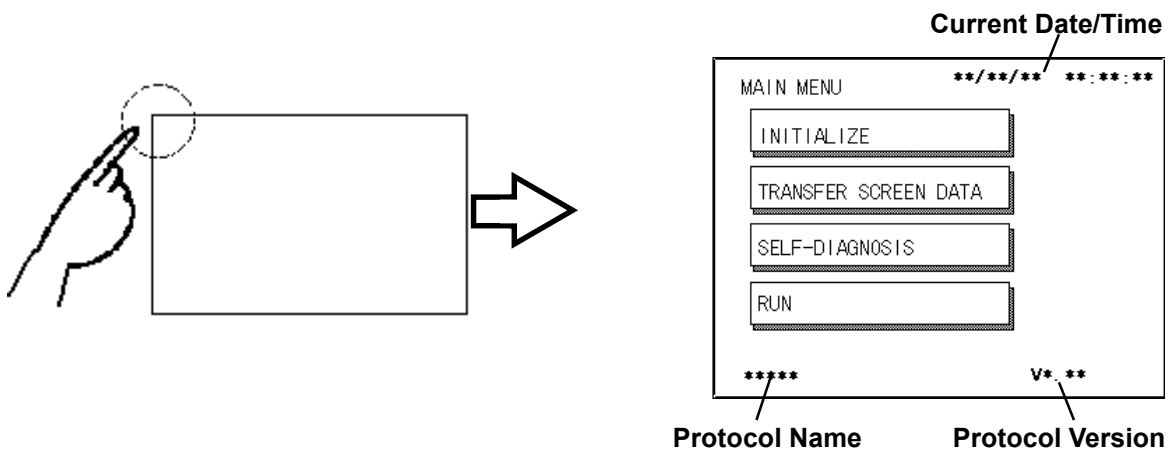

4.1.2 From Forced Reset

From the Forced Reset screen, touch the OFFLINE button and the Main Menu will appear.

For instructions on how to enter the Forced Reset Screen

Reference [5.4.3 “Set Up Touch Panel; FORCE RESET”](#)

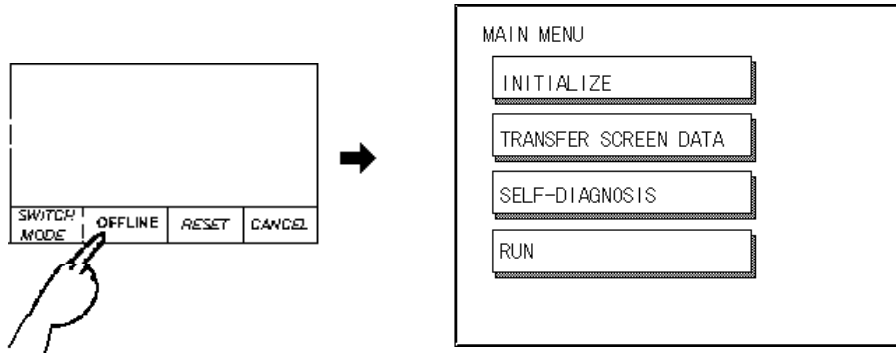

Note: When the GP unit has the Device Monitor function, the following display will appear.

Reference [GP-PRO/PBIII for Windows PLC Connection Manual \(included with the screen creation software\), Appendix 3 - Device Monitor](#)

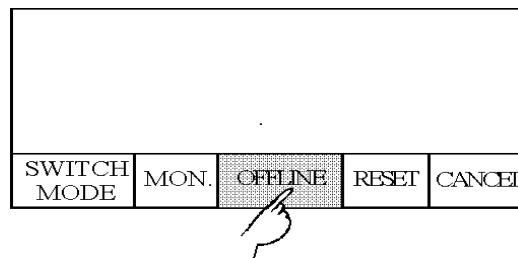

If a Password has been set in INITIALIZE/ SET UP SYSTEM, before entering the OFFLINE mode, the following screen appears.

Enter the password, then touch *Set* to enter OFFLINE mode.

Reference [For more information about Passwords, Chapter 5.3.1, “SYSTEM SETUP” and Chapter 4.3, “Initialize-Standard Operation”](#)

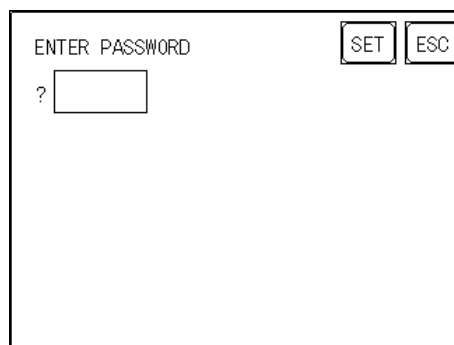

4.2 OFFLINE Mode Main Menu

Each menu item shown below has different settings that must be set to match the corresponding PLC in order for the GP to communicate properly. Entering OFFLINE mode calls up the following screen.

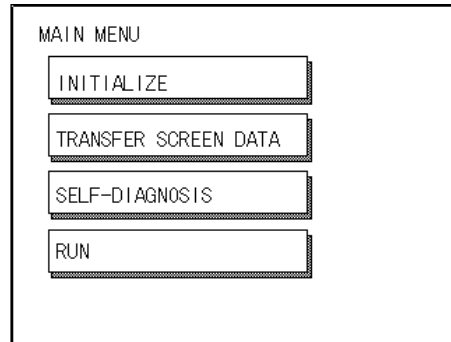

Select the desired menu item by touching the corresponding item bar on the screen selection.

Each Main Menu item is used as follows.

INITIALIZE

The setup items listed in this menu are necessary to run the GP unit.

TRANSFER SCREEN DATA

Select to transfer screen data to and from the screen editing software.

SELF-DIAGNOSIS

Checks to see if there are any problems with the GP System or Interface (I/F).

RUN

Starts GP operation.

Reference *For more information about INITIALIZE, refer to **Chapter 5, "Initialization"**; for more information about TRANSFER SCREEN DATA, refer to GP-PRO/PBIII for Windows Operation Manual (included with the screen creation software); for more information about SELF-DIAGNOSIS and RUN, refer to **Chapter 6, "GP Run Mode and Errors"**.*

4.3 INITIALIZATION

■ Selecting A Menu

Touch the menu item, or input field to select it.

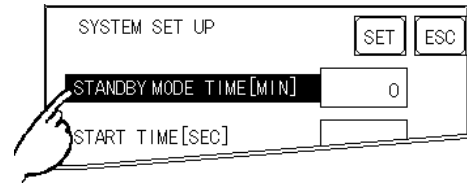
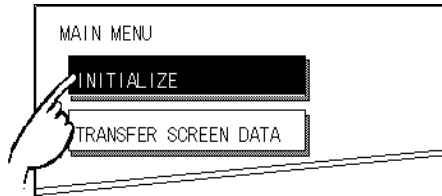

■ Entering Numbers

After selecting an input field by touching it, use the numeric touch keys located at the bottom of the screen to enter numeric values. After inputting each value, touch the [SET] key to define the value.

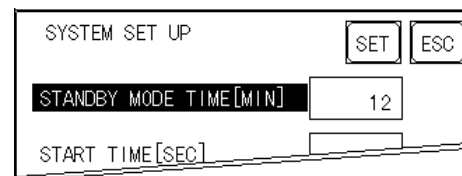
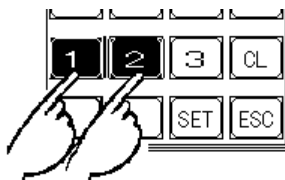

■ Selecting Setup Conditions

After selecting a menu item and entering that area, touch the option you would like to setup. The selected item becomes highlighted. In this example, the TOUCH BUZZER SOUND has been set Off.

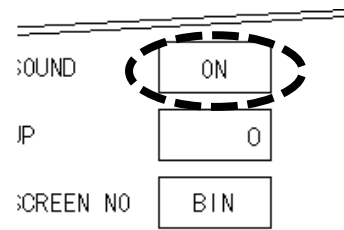
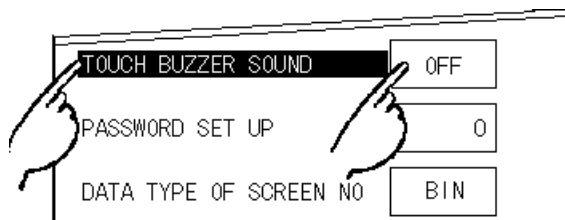

Chapter 4 - Installation and Wiring

■ After All Setting Data is Entered

Touch the top-right [SET] button.

If you wish to exit the screen without saving the changes, touch the CANCEL button.

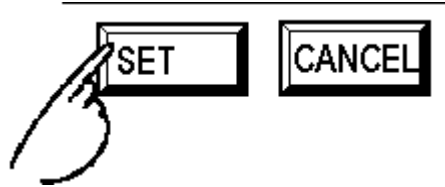

- Press the [SET] key to write the Setup conditions onto the Internal FEPRM, which may take some time, causing a delay in returning to the previous screen. Therefore, do not touch the screen until the previous menu display returns.
- Press the [SET] key to *write* the Setup conditions onto the Internal FEPRM, and Press the [CANCEL] key to *not write* the Setup conditions onto the Internal FEPRM and return to the previous menu.

■ Return To Previous Screen

Touch the title of the screen you would like to return to.

E.g. To return to the MAIN MENU from the SYS.ENVIRONMENT screen, simply touch the MAIN MENU title.

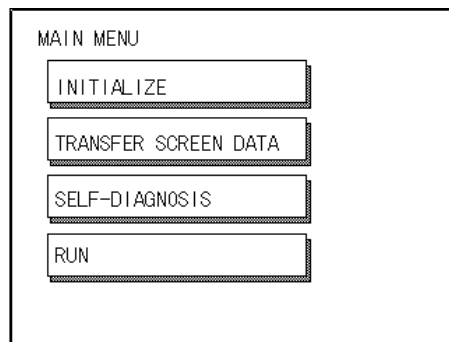
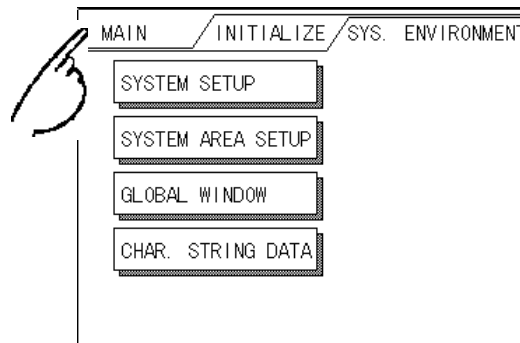

4.4 SELF-DIAGNOSIS

■ Selecting a Sub-Display

Touch the desired the menu item and that sub-display will appear.

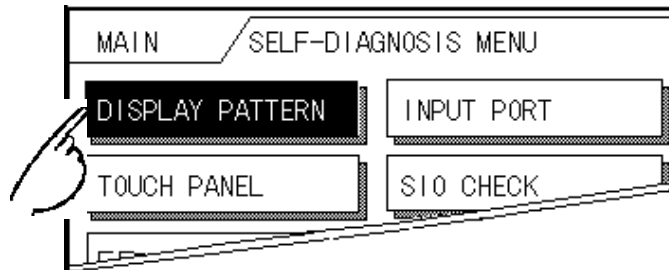

■ [SET], [CANCEL] Keys

After selecting the Self Diagnosis item, the [SET], and [CANCEL] keys may appear at different times at the top of the screen.

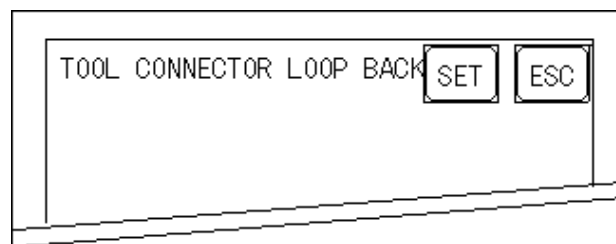

● [SET] Key

When this key is pressed, your selected Self-Diagnosis test begins.

● [CANCEL] Key

When this key is pressed, the selected Self-Diagnosis test is cancelled, and you are returned to the SELF-DIAGNOSIS menu.

Chapter 4 - Installation and Wiring

■ After Check - To Return To SELF-DIAGNOSIS MENU

When OK displays,

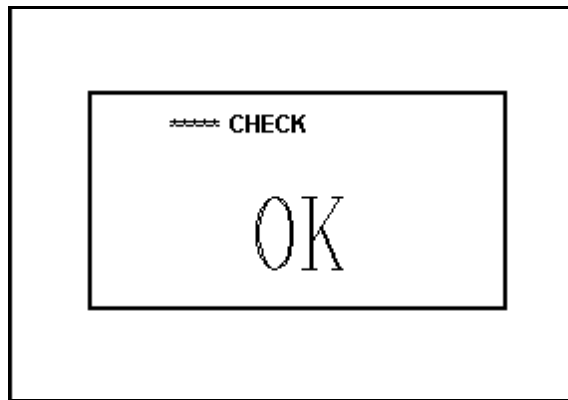

Pressing once anywhere on the display screen returns you to the SELF-DIAGNOSIS MENU.

When an Error Message displays

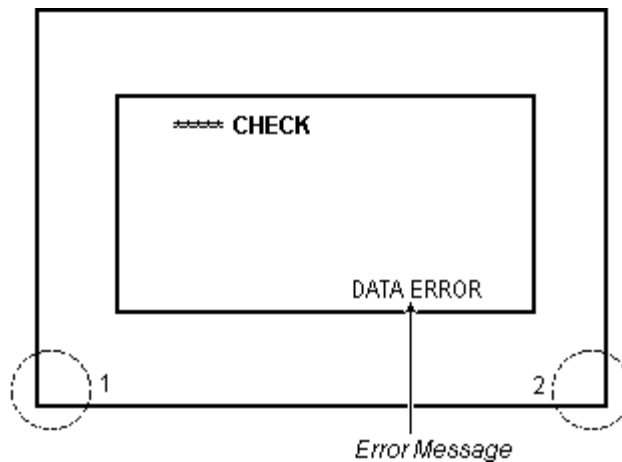

When an error message appears on the display screen, touch the bottom left corner of the panel (1), and then the bottom right corner (2) to return to the SELF-DIAGNOSIS MENU.

■ Return To Main Menu

Touch the MAIN Key in the top right corner of the SELF-DIAGNOSIS menu to return to the MAIN MENU.

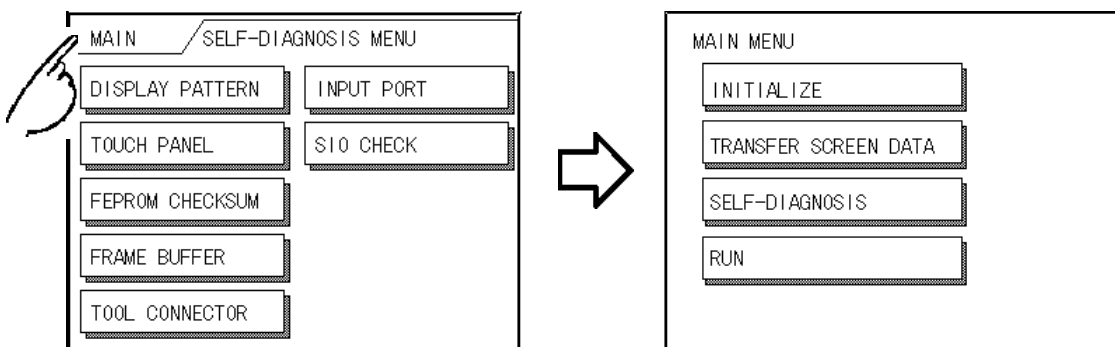

4.5 Transferring Screen Data

This section describes the process required to transfer screen data to the GP, and to receive data from the GP.

Connect the Data Transfer cable to the GP's tool connector, located on the side face of the GP, and to the PC's serial port.

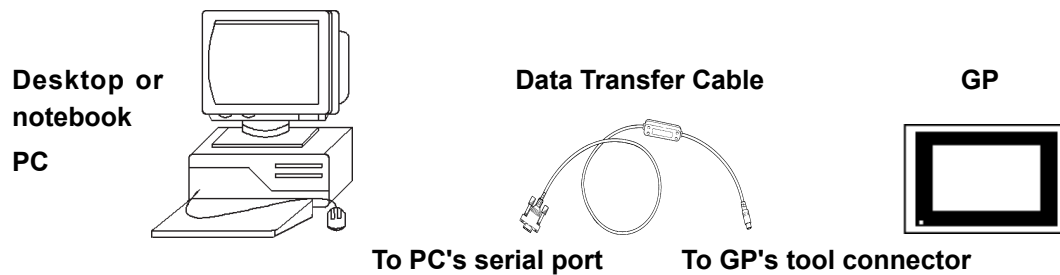

GP-377 unit (Side view)

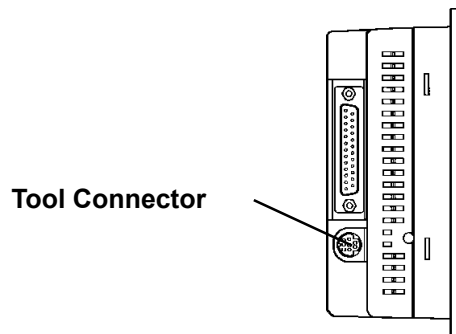

When sending the Project file to the GP, the Data Transfer cable (GPW-CB02 - sold separately) is needed.

Also, please note that an I/F conversion adaptor is not included with the GP. If this adaptor is necessary, it can be purchased at a computer supply store.



When using a serial mouse, be sure to use a different serial port for the data transfer cable.

Chapter 4 - Installation and Wiring

Also, please remember that OFFLINE mode is unavailable in a completely new GP until the necessary Screen Data has been transferred from the screen editor software.

Therefore, be sure the GP's power cord is plugged in and no images are displayed on the GP screen. While screen data is being sent from your PC to the GP, the necessary System Data will be sent together with it.

▼**Reference**▲ *GP-PRO/PBIII for Windows Operation Manual (included with the screen creation software)*

■ To send screen data to a GP that is currently in OFFLINE mode:

- 1) From the OFFLINE mode's MAIN MENU, touch the TRANSFER SCREEN DATA item on the screen to enter the TRANSFER SCREEN DATA mode. This will allow the GP to receive data.

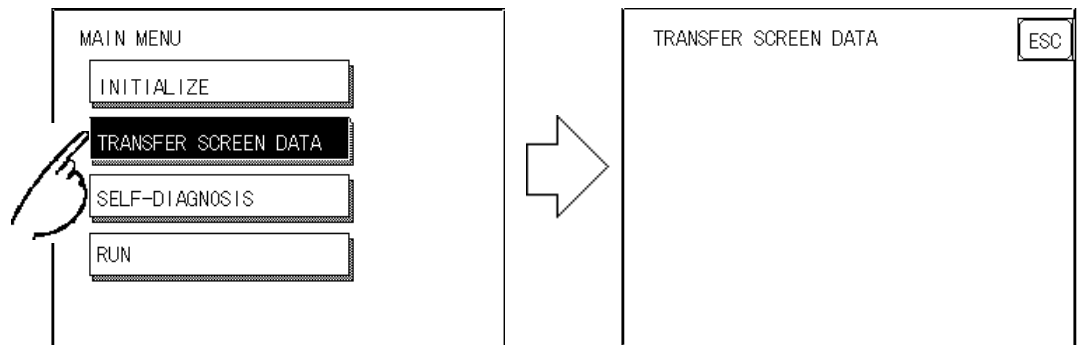

- 2) While data is being transferred, the messages "SETUP Transfer" and "TRANSFERRING/PLEASE WAIT" will display. When data transfer is completed, these messages will be cleared. If desired, use the GP's Editor Software to stop the transfer.

If the Setup^{*1} is performed, the screen will return to the OFFLINE mode's MAIN MENU when data transfer is completed, if the Setup is not performed, the GP will go ONLINE mode and the screen designated in the "INITIALIZE / INITIALIZE SCREEN" setting will display.



When you transfer the information contained in the GP-PRO/PBIII for Windows 's GP System settings to the GP, all OFFLINE MODE [INITIALIZE] setting data in the unit will be lost.

**1 Setup means to download the GP's system program and a PLC protocol driver from the screen editor software, in order to run the GP in a desired environment.*

Memo

Chapter

5 Initializing the GP

1. Initialization Screen
2. Initialization Items
3. SYSTEM ENVIRONMENT SETUP
4. SET UP I/O
5. PLC SETUP
6. INITIALIZE INTERNAL MEMORY
7. SET UP TIME
8. SET UP SCREEN
9. FONT SETTING

5.1 Initialization Screen

Occasionally, you may want to change your GP's general operation settings. The settings used for this are found in the INITIALIZE option in the GP OFFLINE mode's MAIN MENU.

This chapter explains each of the OFFLINE mode's INITIALIZE items. However, there are 2 types of INITIALIZE settings, those for the **1:1** connection and those for the **n:1** (multi-link) connection*¹.

The **n:1** mark appears on original menu items concerned only with the n:1 multi-link connection. If there is no mark, the menu item is common to both 1:1 and n:1 connections.

1:1 Processing where a single (1) GP is connected with a single (1) PLC.

n:1 Processing where multiple GPs are connected with a single PLC. The GPs successively pass a *PLC Access Token* (exclusive PLC interaction key) among themselves to designate which unit can communicate with the PLC.



Note:

If you transfer your screen design software's System file *², the GP operates using that data. If the GP System file has been correctly setup and transferred, the INITIALIZE settings become unnecessary. For more information about GP System files

Reference *Operation Manual, 1.1.2 "Screen Types" (included with the screen creation software)*

*1 PLC's that support the n:1 (multi-link) connection are limited.

Reference PLC Connection Manual (included with the screen creation software)

*2 Refer to GP screen creation software's "SYSTEM SETTINGS" area.

5.2 Initialization Items

The contents of the Initialize setup items listed below are explained in this Chapter. To learn about screen operations and numeric input.

Reference Chapter 4, "OFFLINE Mode"

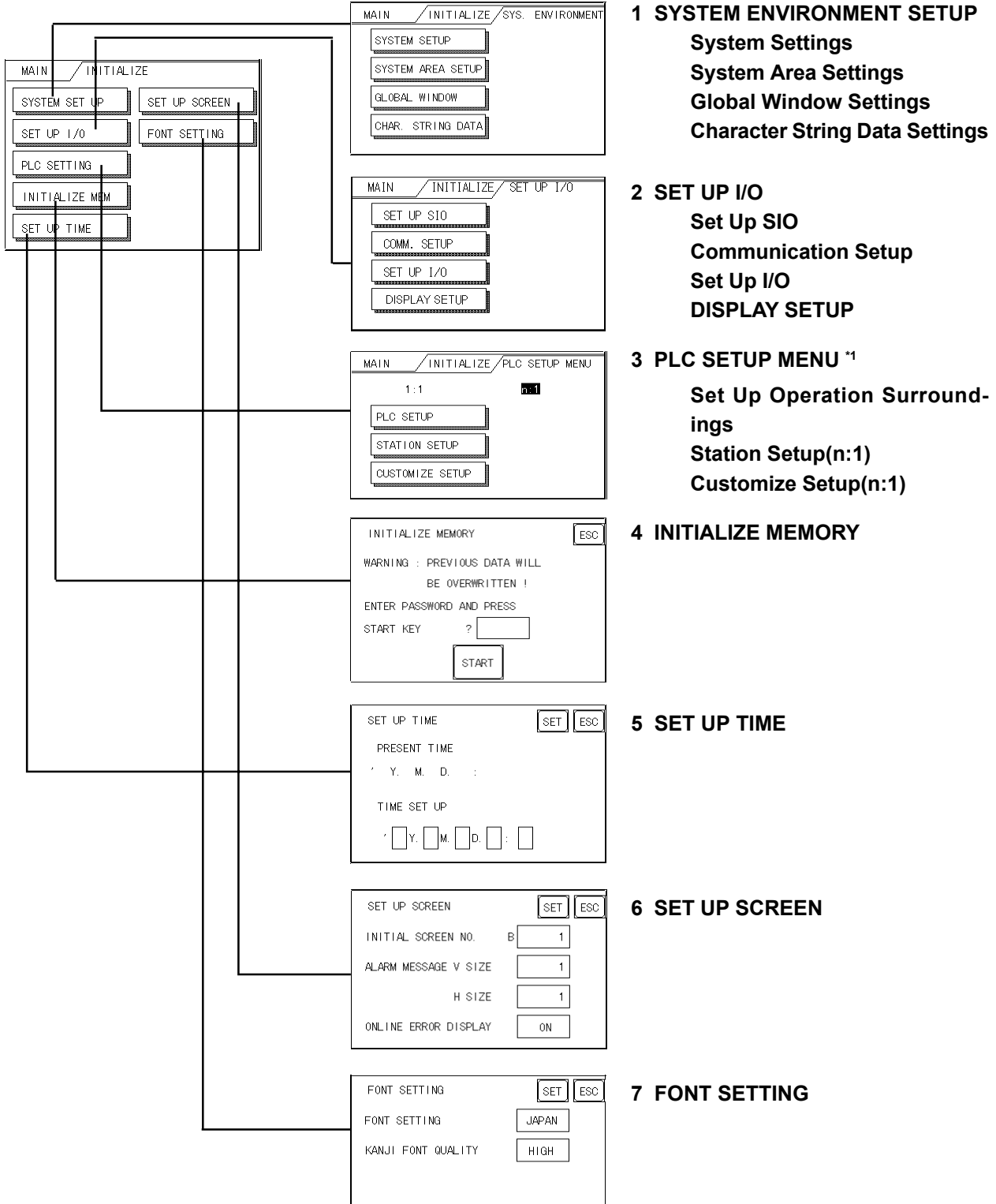

*1 Note that, depending on the PLC type selected, the screens that appear in your GP's screen editor software will vary.

5.3 SYSTEM ENVIRONMENT SETUP

GP environment adjustments are made here. The SYSTEM ENVIRONMENT SETUP includes the SYSTEM SETUP, SYSTEM DATA AREA, GLOBAL WINDOW SETUP, and CHARACTER STRING DATA SETUP.

5.3.1 SYSTEM SETUP

SYSTEM SET UP		SET	ESC
STANDBY MODE TIME [MIN]	<input type="text" value="0"/>		
START TIME [SEC]	<input type="text" value="0"/>		
TOUCH BUZZER SOUND	<input type="text" value="ON"/>		
PASSWORD SET UP	<input type="text" value="0"/>		
DATA TYPE OF SCREEN NO	<input type="text" value="B I N"/>		

STAND-BY MODE TIME (0-255)

To protect the GP display screen, the GP is equipped with a screen saver function that automatically turns the unit's backlight(s) OFF when no operations have occurred for a period of time. A "0" entered in this field causes a normal display, i.e. the screen is cleared after the GP's standard default time elapses.

When SYSTEM DATA AREA's (**Reference** GP-PRO/PBIII for Windows PLC Connection Manual (included with the screen creation software) SCREEN DISPLAY OFF*1 data is **0000h**, and the following operations are *not* performed on the screen for the User's designated period of time, the GP's current display data is cleared.

- Change Screen
- Touch Screen
- Alarm Display

START TIME (0-255)

This setup determines the start-up time of the GP. Use this setup to adjust the power up sequence so that the GP starts up after the PLC.

TOUCH BUZZER SOUND

Setup whether or not the GP beeps when pressed.

PASSWORD SETUP(0-9999)

The password setting is used when changing to the Initialize Memory or Initialize (OFFLINE mode) Screens. The password (*number*) ensures protection of the GP settings as OFFLINE mode will not be entered inadvertently. Enter the optional number of your choice. If you do not wish to use this setup, enter the default **0**.

*1 When using the Direct Access or the Memory Link formats, the object address becomes +9 or +12, respectively. (Only when all items are set within the System Data Area.)

Reference GP-PRO/PBIII for Windows PLC Connection Manual (included with

Chapter 5 - Initializing the GP

DATA TYPE OF SCREEN NO.

This setup controls whether BIN or BCD format numbers are used when making screen changes. Screen numbers 1~8999 are available when set up in binary format; screen numbers 1~1999 are available when set up in BCD format.

5.3.2 SYSTEM AREA SETUP

Here you can designate the settings for the System Data Area. The System Data Area is allocated in the PLC's internal memory, and is used for controlling the GP. Devices that can be set in this area will differ depending on the PLC type.

When using the Memory Link format, this setting is unnecessary.

Reference *PLC Connection Manual (included with the screen creation software)*

Press the item, and when the item is highlighted, it has been selected.

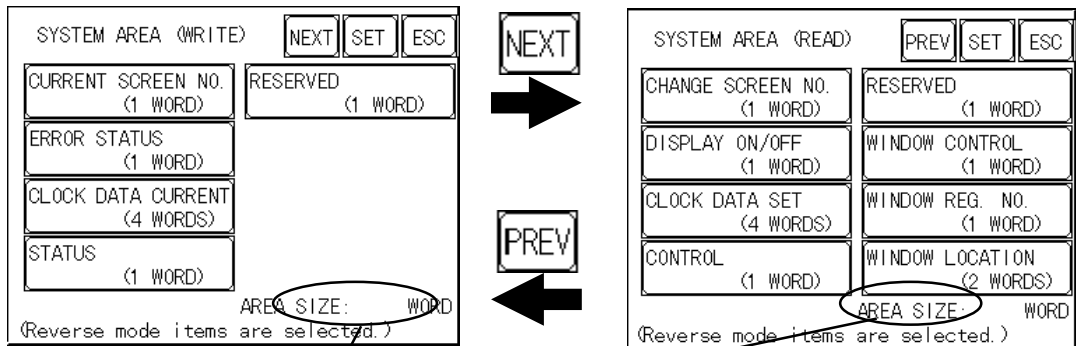

◆ System Area Size

This field displays the total number of words used for the items selected from the SYSTEM AREA SETUP (**Write** and **Read**).

When you press the Confirm key, the SYSTEM AREA CONTENTS screen appears to confirm the selected items.



Note:

- The setup shown is enabled only when using the Direct Access format.
- The selected System Area items, as displayed on the screen, become the System Data Area.

Chapter 5 - Initializing the GP

When these five items, "Current Screen Number", "Error Status", "Clock Data (Current)", "Change Screen Number", and "Display ON/Off", have been selected, word addresses are assigned to each item, in order, as shown here.

SYSTEM AREA CONTENTS		SET	ESC
WORD			
+0	CURRENT SCREEN NO.	+10	
+1	ERROR STATUS	+11	
+2	CLOCK DATA CURRENT	+12	
+3	CLOCK DATA CURRENT	+13	
+4	CLOCK DATA CURRENT	+14	
+5	CLOCK DATA CURRENT	+15	
+6	CHANGE SCREEN NO.	+16	
+7	DISPLAY ON/OFF	+17	
+8		+18	
+9		+19	

The Device Address set up for the SET UP OPERATION SURROUNDINGS screen's System Data Start Device/Start Address is "+0".

For example, if the System Area Start Address is D00200, and the Change Screen Number is designated, since the Change Screen No's address is +6, its word address will be $D00200+6=D00206$. For System Data Start Device and Start Address settings, refer to 5.5.1 SET UP OPERATION SURROUNDINGS (1:1/N:1)

5.3.3 GLOBAL WINDOW SETUP

The GP unit can display one *Global Window* and two *Local Windows* at any one time. The Global Window is common to all the display screens. The Local Window displays exclusively on the corresponding base screen. The GLOBAL WINDOW SETUP is described here.

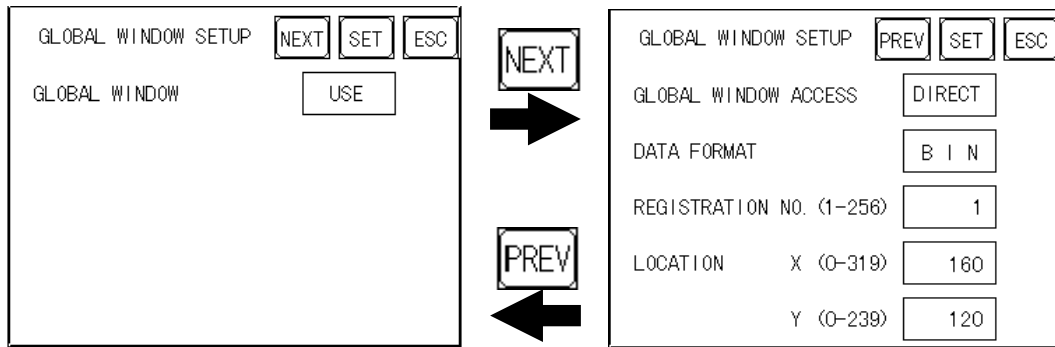

GLOBAL WINDOW

There are two options here: **Use** and **Do Not Use**. If you select **Do Not Use**, ignore the items described below. Selecting **Use** enables these options.

GLOBAL WINDOW ACCESS

Use this feature to designate whether a value used is DIRECT or INDIRECT, i.e. the REGISTRATION NO. and the LOCATION values. When set as Direct, the REGISTRATION NO. and LOCATION selections are fixed to the values entered here. When set to Indirect, the WINDOW REG. NO.'s word address, as prepared in the System Area, is a variable. This means it can have the REGISTRATION NO. *written* to it and, as a result, multiple window screens can be used as Global windows. You can use this method to adjust the Global window position by writing the X,Y coordinates to the SYSTEM AREA's LOCATION word addresses.

DATA FORMAT

Setup whether the REGISTRATION NO. and the LOCATION values are BIN or BCD values. This field is related only to indirect values.

REGISTRATION NO. (1-256)

Enter the Window Screen Number used by the Global Window. This field is enabled only when GLOBAL WINDOW ACCESS is set to direct.

Window Location (X and Y coordinates)

Enter the value used for the (Global WINDOW) LOCATION. This field is enabled only when GLOBAL WINDOW ACCESS is set to direct. This value designates the top-left corner of the screen registered in GLOBAL WINDOW SETUP. If you install the GP vertically however, this value will designate the bottom-left corner's coordinate.

5.3.4 CHARACTER STRING DATA SETUP

Character String Data ordering varies from manufacturer to manufacturer. Setup the Character String Data order here to match the corresponding PLC.

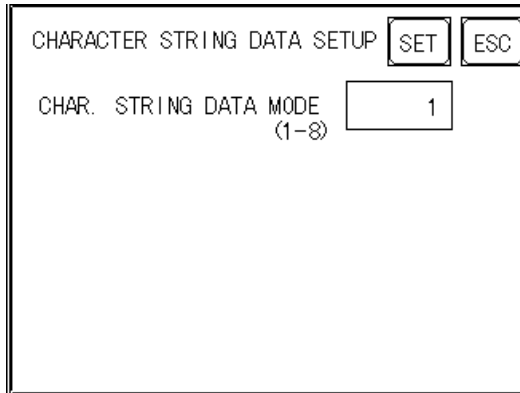

Setup the CHARACTER STRING DATA MODE to match the PLC type. Device type and Tag settings are unavailable.

■ CHARACTER STRING DATA MODE

Find the data storage order for your PLC in the table, down below, and setup the CHARACTER STRING DATA MODE.

- (I) Data Device Storage Order
- (II) Internal Word Byte LH/HL Storage Order
- (III) Internal Double-word Word LH/HL Storage Order

CHARACTER STRING DATA MODE List

(I) Data Device Storage Order	(II) Internal Word, Byte LH/HL Storage Order	(III) Double-word Internal Word LH/HL Storage Order	Character String Data Mode
Storage from Initial data	LH order	LH order	4
		HL order	2
	HL order	LH order	5
		HL order	1
Storage from End data	LH order	LH order	6
		HL order	7
	HL order	LH order	8
		HL order	3

Chapter 5 - Initializing the GP

I) Data Device Storage Order

E.g. Characters A B C D E F G H
 1 2 3 4

• Storage from Start Data

1	D0100
2	D0101
3	D0102
4	D0103

• Storage from End Data

4	D0100
3	D0101
2	D0102
1	D0103

II) Word Byte LH/HL Order

E.g. Characters A B C D
 1 2 3 4

• 16 bit Device LH Order

2	1	D0100
4	3	D0101

• 16 bit Device HL Order

1	2	D0100
3	4	D0101

• 32 bit Device LH Order

2	1	4	3	D0100
---	---	---	---	-------

• 32 bit Device HL Order

1	2	3	4	D0100
---	---	---	---	-------

III) Double-word Word LH/HL Order

E.g. Characters "A B C D E F G H I J"
 1 2 3 4 5

• 16 bit Device LH Order

2	D0100
1	D0101
4	D0102
3	D0103
5	D0104

• 16 bit Device HL Order

1	D0100
2	D0101
3	D0102
4	D0103
5	D0104

E.g. Characters "A B C D E F G H I J K L M N O P Q R S T"
 1 2 3 4 5 6 7 8 9 10

• 32 bit Device LH Order

2	1	D0100
4	3	D0101
6	5	D0102
8	7	D0103
10	9	D0104

• 32 bit Device HL Order

1	2	D0100
3	4	D0101
5	6	D0102
7	8	D0103
9	10	D0104

Relationship between K-tag Write Character Value and PLC Device

• 16 bit Devices

GP stores the character string from the start, as groups of 2, into 1 PLC Device. When there are nine characters, they are arranged as shown below.

1 2 3 4 5 6 7 8 9 Null
 └─┘ └─┘ └─┘ └─┘ └─┘



Note:

When the characters do not divide into 2 evenly, NULL is added at the end.

• 32 bit Devices

GP stores the character string from the start, as groups of 4, into 1 PLC Device. When there are nine characters, they are arranged as shown below.

1 2 3 4 5 6 7 8 9 Null
 └─┘ └─┘ └─┘



Note:

When the characters do not divide into 4 evenly, NULL is added at the end.

5.4 SET UP I/O

This section describes the communication setup with the host PLC and the setup for any peripheral equipment. The SET UP I/O menu includes the SET UP SIO, COMMUNICATION SETUP and SET UP I/O menus.

5.4.1 SET UP SIO

This menu runs the settings related to PLC communication. Be sure to match the settings listed below with the SIO setup on the PLC host.

Reference *GP-PRO/PBIII for Windows PLC Connection Manual (included with screen creation software)*

SET UP SIO	SET	ESC
COMMUNICATION RATE	19200	
DATA LENGTH	7/2	
PARITY	EVEN	
CONTROL	ER-CNTRL	
COMMUNICATION INTERFACE	RS232C	

COMMUNICATION RATE

The COMMUNICATION RATE (baud rate) is the data communication speed, measured in bits per second (bps), between the GP and PLC. Match the COMMUNICATION RATE values in both the PLC and GP. Depending on the rate selected, certain PLCs may not be able to be used.

Reference *GP-PRO/PBIII for Windows PLC Connection Manual (included with screen creation software)*

DATA LENGTH

For data communications, the DATA LENGTH must be set up as 7-bit or 8-bit data, and set up also the STOP BIT as either a 1-bit or 2-bit value.

PARITY

Set up whether no parity check, or an odd or even number parity check will take place during communication.

CONTROL

Data flow CONTROL prevents the overflow of data sent back and forth. Select either X-CNTRL or ER-CONTRL.

COMMUNICATION INTERFACE

Select one of the following options for the communication format: RS-232C, RS-422 (4 line), or RS-422 (2 line).



When using an RS422 cable and the Memory Link format, be sure to select the 4-line option.

Reference *GP-PRO/PBIII for Windows PLC Connection Manual (included with screen creation software)*

Chapter 5 - Installation and Wiring

5.4.2 COMMUNICATION SETUP

COMMUNICATION SETUP	SET	ESC
RECEIVE TIMEOUT (1-127)	10	SEC
RETRY COUNT (0-255)	2	

RECEIVE TIMEOUT

Sets the value used for the data reception timeout (PLC - GP).

If the cable is not connected, data communication will Timeout in one second, regardless of this setting's value. The default is "10" seconds.



Note:

If you transfer screens when a PLC communication error has occurred and the error is not yet cleared, and the RECEIVE TIMEOUT value is set to 30 seconds or more, an error message may appear on your personal computer.

RETRY COUNT

Designates how many times the GP tries to send data to the PLC when a PLC communication error occurs. An Error Message will appear on the GP after the GP tries to send data to the PLC the number of times set by this option. The default is "2".

5.4.3 SET UP TOUCH PANEL

Touch operation and Force Reset setup, and Display Device adjustments are made here. There may be differences on these settings depending of the GP type.

GP-377L Setup Screen

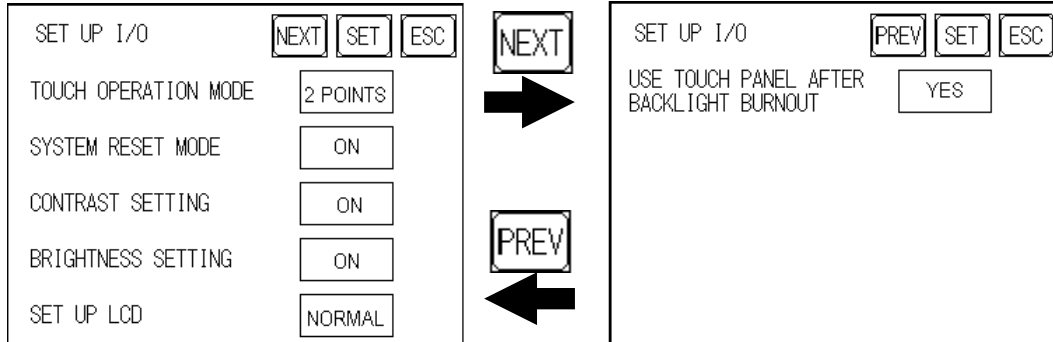

GP-377S Setup Screen

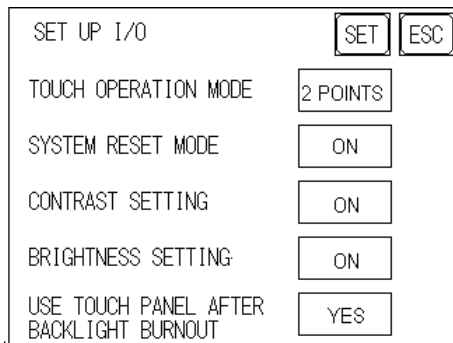

TOUCH OPERATION MODE

Designates either One Point, Two Point or No Slide. When No Slide is selected, dragging one's finger across the touch screen will elicit no screen response, and only individually selected points will register.

SYSTEM RESET MODE

Designates whether or not a SYSTEM RESET operation is performed.

◆ Steps to run SYSTEM RESET

While holding down the bottom right corner (1) of the screen, press the upper right corner (2). At the same time, press the bottom left corner (3) to enter the FORCE RESET Operation. To activate Reset, press the **RESET** button, to transfer to OFFLINE Mode, press **OFFLINE**.

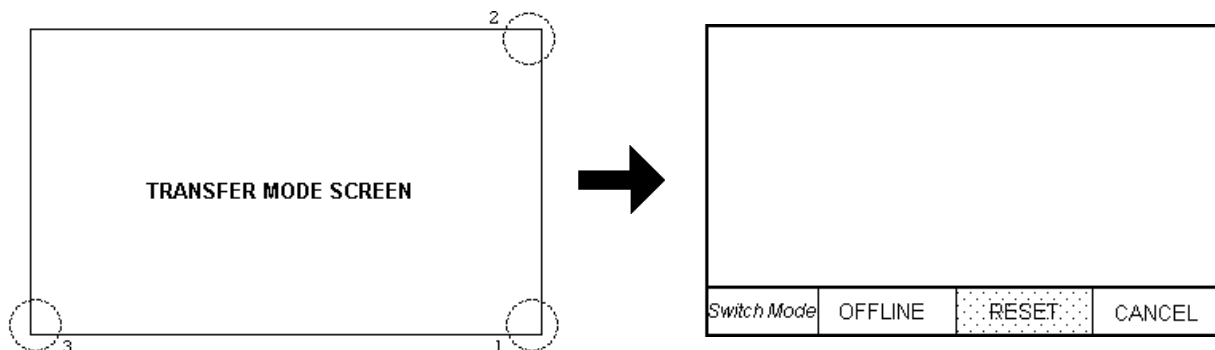

Chapter 5 - Installation and Wiring



FORCE RESET can occur during either RUN mode or OFFLINE mode.



- The SYSTEM RESET mode cannot be entered while the GP is starting up.
- Entering SYSTEM RESET is possible even when RUN operations (PLC \leftrightarrow GP communication) are not being performed.

CONTRAST SETTING

When CONTRAST SETTING is set to “ON”, you can adjust the contrast simply by touching the GP’s screen. If you wish to change to contrast adjustment mode, touch the screen’s top-right corner (see position 1 in the picture below), and then touch also the top-left corner (see position 2.) while touching the top-right corner. When the screen “B” appears, touch the brightness level you wish to select and the screen’s contrast will change.

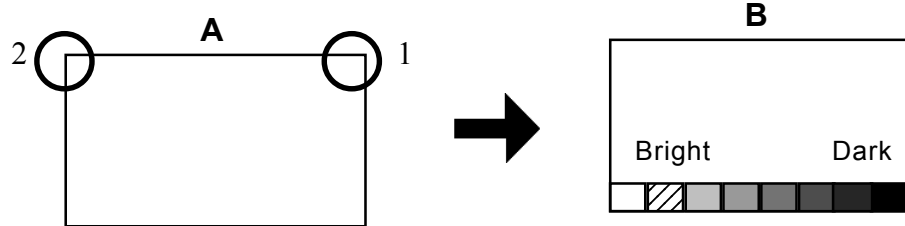

- The pictures shown here are for the GP-377S unit. “Bright” and “Dark” positions are reversed on the GP-377L unit.
- To end CONTRAST SETTING mode, press anywhere outside the bottom of the screen.
- CONTRAST SETTING mode cannot be entered while waiting for GP to start up.
- CONTRAST SETTING can be made even during RUN mode (PLC \leftrightarrow GP communication).

BRIGHTNESS SETTING

When set to ON, BRIGHTNESS SETTING can be performed via touch input. Press the bottom left corner (2) of the screen while holding down the bottom right corner (1) to enter BRIGHTNESS SETTING mode. Touch the left-side of the bar to brighten the display; touch the right-side of the bar to dim the display. This unit has four levels of adjustment.

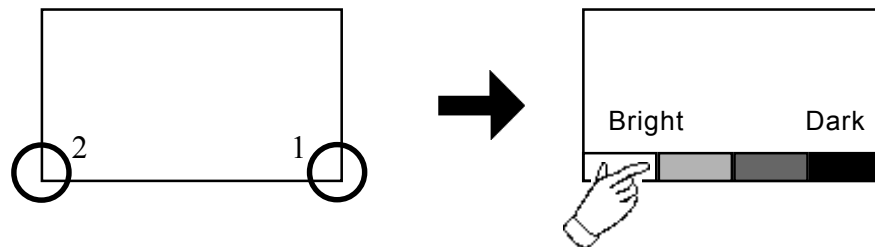

- The pictures shown here are for the GP-377S unit. “Bright” and “Dark” positions are reversed on the GP-377L unit.
- To end BRIGHTNESS SETTING mode, press anywhere outside the bottom of the screen.
- BRIGHTNESS SETTING mode cannot be entered while waiting for GP to start up.
- BRIGHTNESS SETTING can be made even during RUN mode (PLC \leftrightarrow GP communication).

SET UP LCD (GP-377L only)

To reverse the screen display colors, touch SET UP LCD on the SET UP I/O screen to change the setting from “NORMAL” to “REVERSE”, and then touch the “SET” key. The display color will be reversed and the previous screen will re-appear.

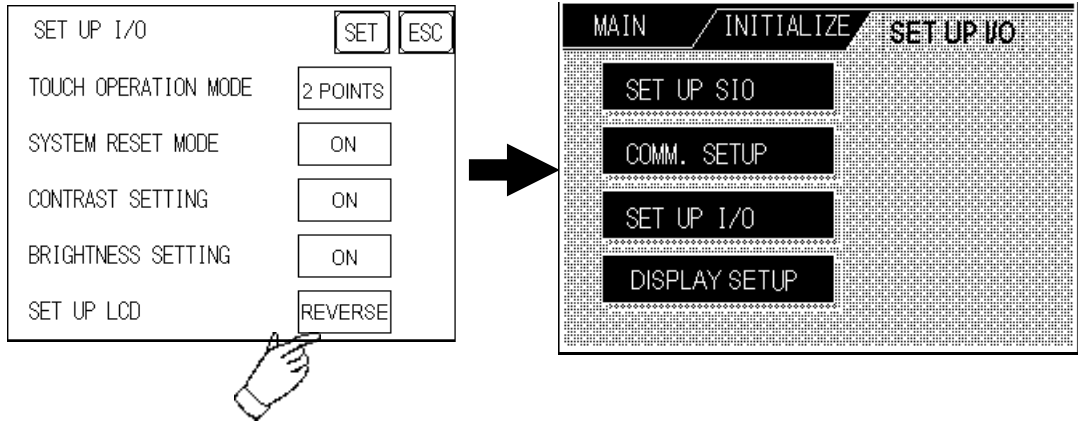

USE TOUCH PANEL AFTER BACKLIGHT BURNOUT

This option designates whether touch-operation is disabled or not when the backlight burns out.

If this selection is set to [OFF], touch-operation will be disabled when the backlight burns out, which prevents the GP from sending input signals to the PLC.



Note:

- When the backlight burns out, the Status LED's orange light turns ON, and the System Data Area's "Status" bit 10*1 will turn ON.
- If the [SYSTEM RESET] option is set to [ON], only "System Reset" can still be performed by touch-operation in case of backlight burnout.
- If the backlight burns out when the GP is OFFLINE, touch-panel operation is enabled, regardless of these settings.



Important

Normally, the unit detects backlight burnout by monitoring the current flow, however, the unit may fail to detect this condition depending on the problem type the backlight has.

*1 Bit +6 when using the Direct Access method, and bit +11 when using the Memory Link method, will turn ON.

▼ **Reference** ▼ GP-PRO/PBIII for Windows PLC Connection Manual (included with screen creation software)

Chapter 5 - Installation and Wiring

5.4.4 DISPLAY SETUP

The GP's screen may flicker, or there may be shadows appearing on extended display lines on the LCD surface. In the case where the GP's ambient temperature becomes high, and its current brightness level is set to low, this effect may be more pronounced. This phenomenon is however, a common attribute of LCDs and is not a defect. To solve this, use this setting for adjusting the GP's brightness.

When Using GP-377L

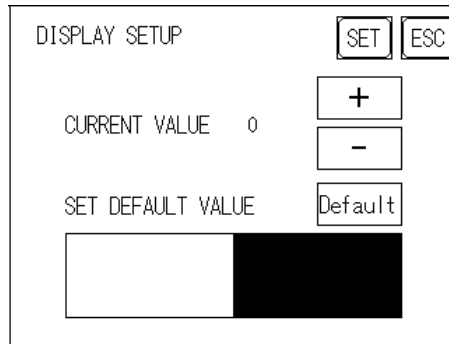

When Using GP-377S

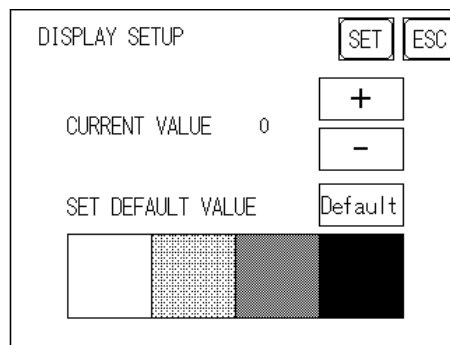

Current Value

To solve the above problem, touch “+” or “-“ to adjust the brightness. You can check the actual brightness in the preview field at the bottom of the screen. From the default value of “0” there are 18 “+” levels and 2 “-“ levels available.

Set Default Value

If you touch “Default”, the setting returns to “0”.

5.5 PLC SETUP

Setup the System Area and the Unit number in this screen. Because 1:1 and n:1 GP connections utilize different settings, confirm your connection's needs before using any settings. The following assumes that the Direct Access format is used.



- **The screens may differ depending on the PLC type you selected in the screen creation software.**
Reference *GP-PRO/PBIII for Windows PLC Connection Manual (included with screen creation software)*
- **When the GP-PRO/PBIII for Windows Ver 3.0 "Simulation" feature is used, the OPERATION SURROUNDINGS menu cannot be entered.**

5.5.1 SET UP OPERATION SURROUNDINGS(1:1/n:1)

Enter the PLC System Data Area and the Unit Number settings here. Same options are available for both 1:1 Connection and n:1 (Multi-link) Connection. For 1:n (Multi-link) Connection, System Data Area settings must be setup for each GP connected.

Reference *GP-PRO/PBIII for Windows PLC Connection Manual (included with screen creation software)*

SET UP OPERATION SURROUNDINGS		SET	ESC
SYSTEM AREA START DEV	<input type="text"/>		
START ADR	<input type="text"/>		
UNIT No.	<input type="text"/>		
SYSTEM AREA READ SIZE	<input type="text"/>		
RESET GP ON WRITE ERROR	<input type="text"/>		

SYSTEM AREA START (DEV/ ADR)

Setup the System Data Area's Start Address. Device addresses which can be allocated will differ depending on the PLC type.

Reference *GP-PRO/PBIII for Windows PLC Connection Manual (included with screen creation software)*

UNIT NO.

Set up the PLC UNIT number here. Make sure it matches the one set up in the PLC.

SYSTEM AREA READ SIZE (0-256)

When using a Block Display Trend Graph, setup the Reading Area Size (in word units) to match the Trend Graph's data size. Setup when you wish to allocate the Reading Area in the PLC Data Register (D), or Data Memory (DM).



If you are not using the Reading Area, leave the 0 default values intact. This will allow you to perform high speed data communication.

Chapter 5 - Installation and Wiring

RESET GP ON WRITE ERROR

Designates the mode which enables you to cancel the error from the error display when the Write error occurs.

5.5.2 STATION SETUP(n:1)

The STATION SETUP, necessary for the n:1 (Multi-link) setup, checks whether correct communications run with the connected GP System configuration.

STATION SETUP	SET	ESC
NETWORK INFORMATION DEV	D	
INFORMATION ADR	1	
STATION No. (0-15)	0	

NETWORK INFORMATION (DEV/ADR)

In the n:1 (multi-link) connection, the Network Information uses 2 words in its correspondences. These two (2) words consist of a Connection List and a Validation List (described later in this section). These areas are allocated in the PLC's Data Register (D) or Data Memory (DM). Addresses which can be allocated will differ depending on the PLC type.

Reference *GP-PRO/PBIII for Windows PLC Connection Manual* (included with screen creation software)

PLC Data Register

+0	CONNECTION LIST	PLC-->GP
+1	VALIDATION LIST	GP-->PLC



In the NETWORK INFORMATION ADR, setup the same address to all the GP's connected to the same link unit. Furthermore, when there are 2 ports in the connected link unit, do not make them the same address.

◆ Connection List

The word address for the Connection List sets up the number of GP's connected to the PLC, which must be registered beforehand on the PLC side. When these GP's are connected to the PLC, the corresponding PLC bit numbers for the particular GP Stations (see below) turn ON.



When the GP is connected to the PLC, and the option of GP only correspondence ends and OFFLINE mode is entered, the GP Station Number then turns the corresponding PLC bit OFF.

Bit 15														Bit 0																	
15	14	13	12	11	10	9	8	7	6	5	4	3	2	1	0	15	14	13	12	11	10	9	8	7	6	5	4	3	2	1	0
unit	unit	unit	unit	unit	unit	unit	unit	unit	unit	unit	unit	unit	unit	unit	unit	unit	unit	unit	unit	unit	unit	unit	unit	unit	unit	unit	unit	unit	unit		

Chapter 5 - Installation and Wiring

For example, when these 4 GP units—bit 0, bit 2, bit 3, bit 5—are connected, 002D (h) is written here.

Connection List

0	0	0	0	0	0	0	0	0	0	0	1	0	1	1	0	1
---	---	---	---	---	---	---	---	---	---	---	---	---	---	---	---	---

 002D (h)



- **Be certain to setup this data before running.**
- **Turn all bits not related to the GP OFF.**

◆ Validation List

This area responds to the correspondence from each connected GP. In the Validation List, when the same bit numbers as the Connection List turn ON, the correspondence is accepted. The Station Numbers of the communicating GPs turn their corresponding PLC bit number ON.

Bit 15								Bit 0							
15	14	13	12	11	10	9	8	7	6	5	4	3	2	1	0
unit	unit	unit	unit	unit	unit	unit	unit	unit	unit	unit	unit	unit	unit	unit	unit

If the correspondence between the GP and PLC is correct, the same value as in the Connection List is written to the Validation List.

For example, the value 002D (h) in the Connection List, setup as the 0 bit, 2 bit, 3 bit, and 5 bit, writes to the Validation List.

Connection List

0	0	0	0	0	0	0	0	0	0	0	1	0	1	1	0	1
---	---	---	---	---	---	---	---	---	---	---	---	---	---	---	---	---

 002D (h)

Validation List

0	0	0	0	0	0	0	0	0	0	0	1	0	1	1	0	1
---	---	---	---	---	---	---	---	---	---	---	---	---	---	---	---	---

 002D (h)



- **When the Connection List and Validation List do not match, a COMMUNICATION ERROR occurs. Check the setup again.**
- **When changing the connection, first turn all the bits OFF.**

STATION NO. (0-15)

This is the setup for the GP Station Number mentioned above. The setup range is from 0 to 15, and the only other restriction is the GP STATION NO. must be unique in the system. If STATION NO.'s are repeated, a COMMUNICATION ERROR occurs.



The STATION NO. is the number allocated to the particular GP unit. This number is not related to the Link Unit Machine number.

Chapter 5 - Installation and Wiring

5.5.3 CUSTOMIZE SETUP (n:1)

The Customize function modifies the n:1 (multi-link) connection's communication method to make it more effective. To run communication efficiently, the user should first determine whether they wish to have Operation or Display priority set for the GP. Based on this, the communication response speed can be upgraded. (However, this also depends on the screen information displayed.)

CUSTOMIZE SETUP	SET	ESC
PLC PRIORITY	OPE.	
GP TOUCH MONOPOLIZE	OFF	
MONOPOLIZE TIME (0-2550s)	0	*10s

PLC PRIORITY

According to how the GP is used, select either Operation priority (OPE.) or Display priority.

Operation

Setup the GP to this option when using the GP mainly as an operation panel. As a result, the GP will command better touch panel numeric input and switch response times.

Leaving the GP in this mode does not drastically influence the touch panel operation response time of other GPs. The screen display renewal cycle, however, will slow.

Display

Setup the GP to this option when using the GP mainly as a monitor screen. The GP will command a higher display speed as a result; however, the response time for the touch panel's operations will slow.



- In a standard network setup, use the same setup for all connected GP's.
- To increase the display speed, be sure the addresses used are consecutive addresses. When bit addresses are used, use consecutive to the word units.

Speed Difference between Display Priority and Operation Priority

When using the Mitsubishi Electric Corp. A3A PLC, with consecutive addresses (80 words not included in the System Area), the difference in reading speed is as shown in the following graphs.

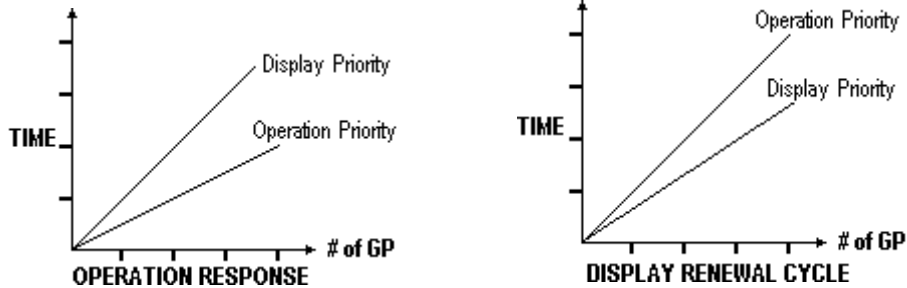

GP TOUCH MONOPOLIZE

The monopolizing of touch panel use can be set ON or OFF. When you want to use the PLC exclusively with a Momentary operation setup on the touch panel, turn GP TOUCH MONOPOLIZE ON.

When this setup is ON, the touch panel uses the PLC exclusively whenever the momentary operation setup on the panel is pressed. In this way, you can use the inching operation with a momentary switch. When you stop pressing the panel, exclusive use ends.

Reference *GP-PRO/PBIII for Windows PLC Connection Manual (included with screen creation software)*

MONOPOLIZE TIME (0-2550S)

This field controls the length of time for the monopolize process when no other touch panel operations are performed. The Monopolize process begins when the System Data Area's 7th bit of word address LS14 turns ON, and ends either when the bit turns OFF, or when the time set here elapses.



- **Pressing the touch panel in the middle of the monopolize process interrupts the MONOPOLIZE TIME function, and ends exclusive use.**
- **When MONOPOLIZE TIME is set to 0, the monopolize function does not end automatically.**

For further information about the contents of System Data Area LS6 (status) and LS14 (control) **Reference** *GP-PRO/PBIII for Windows PLC Connection Manual (included with screen creation software)*

5.6 INITIALIZE INTERNAL MEMORY

This command erases all the GP screen data and initializes the GP's SRAM.



- **You cannot cancel the Initialization procedure after pressing the Start key.**
- **All backed up data in SRAM is lost.**
- **Initialization does not erase the SYSTEM SET UP, the SIO protocol, or the internal clock settings.**

```
INITIALIZE MEMORY [ESC]
WARNING : PREVIOUS DATA WILL
           BE OVERWRITTEN !
ENTER PASSWORD AND PRESS
START KEY   ? [ ]
           [START]
```

To initialize the GP internal memory, enter the common password **1101**, or the password entered in the SYSTEM SET UP screen.

Reference Chapter 4.3, "INITIALIZE-Standard Operation"



Note: The time required for Initialization is between 10 and 20 seconds.

5.7 SET UP TIME

```
SET UP TIME [SET] [ESC]
PRESENT TIME
' Y. M. D. :
TIME SET UP
' [ ] Y. [ ] M. [ ] D. [ ] : [ ]
```

Sets the GP's internal clock.

SET UP TIME

Enter date and time corrections to the date and time displayed in the PRESENT TIME.



Note: The GP's internal clock has a slight error. At normal operating temperatures and conditions, with the GP operating from its lithium battery, the degree of error is 65 seconds per month. Variations in operating conditions and battery life can cause this error to vary from +65 to -350 seconds per month. For systems where this degree of error will be a problem, the user should be sure to monitor this error and make adjustments when required.

5.8 SET UP SCREEN

This screen is used to enter the number for the initial screen displayed after powering up, the character size when in RUN mode, and other general screen items.

SET UP SCREEN		SET	ESC
INITIAL SCREEN NO.	B	1	
ALARM MESSAGE V SIZE		1	
H SIZE		1	
ONLINE ERROR DISPLAY		ON	

INITIAL SCREEN NO.

Set up the screen file number that will display first upon powering up. If the BIN option for DATA TYPE OF SCREEN NO in SYSTEM SET UP had been selected, enter a number from 1 to 8999. Or, if BCD was the option set up, then input a number from 1 to 1999.

ALARM MESSAGE

Set up the character size of the ALARM MESSAGE when the Alarm Bulletin is activated.

<When using single-byte characters>

1	2	4
V size=1; H size=1 16×8 pixels	V size=2; H size=2 32×16 pixels	V size=4; H size=4 64×32 pixels

<When using double-byte characters>

V size=1; H size=1 16×16 pixels	V size=2; H size=2 32×32 pixels	V size=4; H size=4 64×64 pixels
------------------------------------	------------------------------------	------------------------------------

ONLINE ERROR DISPLAY

Set up whether or not error messages display during RUN mode.

5.9 FONT SETTING

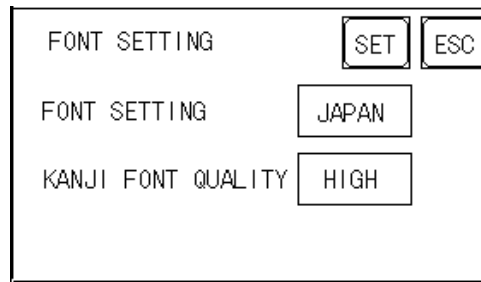

FONT SETTING

Select the character font that displays during RUN mode. Available selections are [EUROPE], [JAPAN], [KOREA], [CHINESE] and [TAIWANESE].

KANJI FONT QUALITY

◆ When [FONT SETTING] is set to [JAPAN]

Single-byte characters will remain 8x16-dot characters when they are enlarged.

Double-byte characters are displayed as:

[Standard] Here, characters are displayed as 16x16-dots. When enlarged, this font will remain a 16x16-dot character. (Compatible with GP-*30 series units.)

[HIGH] When enlarged to double-size, Level 1 JIS Kanji Code characters are displayed as 32x32-dot characters. Level 2 JIS Kanji Code characters remain 16x16-dot characters. (Compatible with GP-*50 series and GP-70 series units.)

[1,2] When enlarged to Double-byte size, both Level 1 and Level 2 JIS Kanji Code characters are displayed as 32x32-dot characters.

◆ When [FONT SETTING] is set to any other type (i.e. CHINESE, I-ASCII, KOREA or TAIWAN)

[Standard] When enlarged, single-byte characters will remain 8x16-dot characters, and double-byte characters will remain 16x16-dot characters. (Compatible with GP-*30 series units.)

[HIGH] Single-byte characters (ASCII codes 21h to 7Dh) except < ' > and < ~ > will display as high quality characters.

- 16x16-dot characters will display using Japanese font *1, 16x16-dot characters.

- 32x32-dot characters can only be displayed as Japanese font, 32x32-dot characters.

When enlarged, double-byte characters remain 16x16-dot characters.

[1,2] Single-byte characters (ASCII codes 21h to 7Dh) except < ' > and < ~ > will display as high quality characters using Japanese fonts.

- 16x16-dot characters will display as Japanese font 16x16-dot characters.

- 32x32-dot characters will display as Japanese font 32x32-dot characters.

When enlarged to double-size (32x32-dot) or larger, double-byte characters (KOREA, TAIWAN, CHINESE) will display as 32x32-dot characters.

*1 "Japanese font" here means the 2 types (16x16-dot font and 32x32-dot font) of fonts used in the "JAPAN" setting.

Memo

Chapter

6 GP RUN Mode and Errors

1. GP RUN Mode
2. Troubleshooting
3. SELF-DIAGNOSIS
4. Error Messages

This chapter describes both the GP RUN mode and GP problem solving processes.

6.1 GP RUN Mode

There are two ways of entering the GP's RUN mode; first, immediately after plugging in the unit's power cord, and the other, from the GP's OFFLINE mode.

6.1.1 After Powering Up the GP

First, connect the GP's power cable. After the unit has powered up, the START TIME value, set up in INITIALIZE area's SYSTEM SET UP feature, determines how long the display shown below is shown. The screen designated in the INITIALIZE area's SET UP SCREEN feature will then be shown and the GP will start communicating with the PLC. If, however, a screen has not been designated in the INITIALIZE area's SET UP SCREEN feature, or if the screen itself does not exist, then this display will remain.

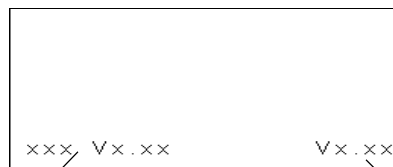

Protocol Name

System Version

6.1.2 Via OFFLINE Mode

Touch the MAIN MENU's RUN selection to start your downloaded "project". The INITIALIZE area's SET UP SCREEN feature designates the first screen that appears in RUN mode, and, after this screen appears, communication with the PLC begins. If, however, the designated initial screen has not been created, or does not exist, the above display will remain.

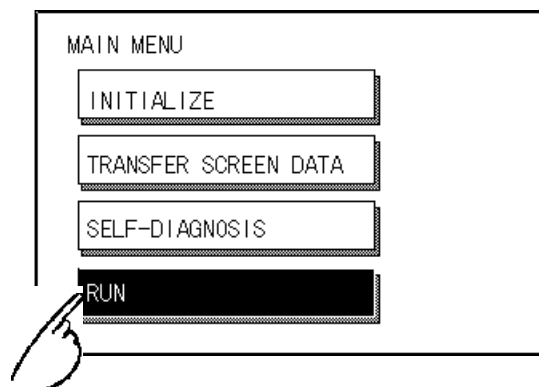

Chapter 6 - GP RUN Mode and Errors

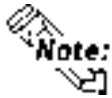

To enter OFFLINE Mode, simply touch the top left corner of the GP's screen within 10 seconds after connecting the GP's power cord.

E.g. After powering up the GP, the initial screen that appears is equipped with a built-in (invisible) switch in the top left corner. Touch this switch within 10 seconds to change the GP from RUN to OFFLINE mode.

(Note that the example below uses a pre-made screen with a "MENU" button in the top left corner. This screen will not appear unless designated to.)

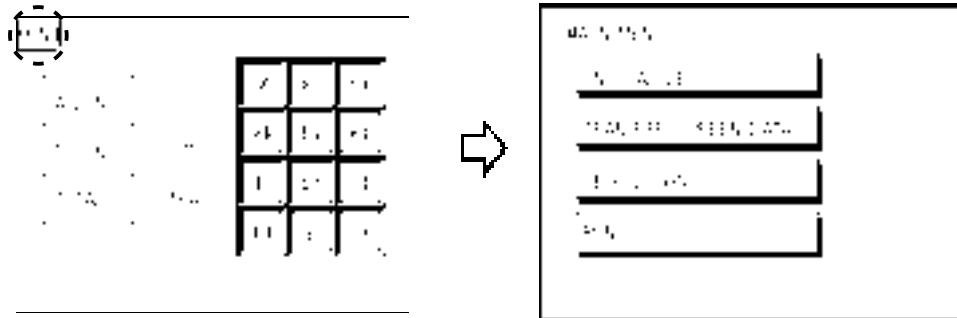

6.2 Troubleshooting

This section describes how to find and resolve problems that may occur on the GP. If there is a problem on the PLC side, refer to the corresponding PLC manual.

6.2.1 Possible Types of Trouble

Followings are some problems that may occur while using this unit.

(A) No Display

The screen will not display even when the unit is powered On. Also, during RUN mode, the screen disappears.

(B) No GP/HOST Communication

The GP unit cannot extract data from the host. An error message may appear on the screen as a result.

Reference *This chapter's "Error Messages"*

(C) Touch Panel Does Not Respond

The touch panel does not react when pressed, or the reaction time is very slow.

(D) OFFLINE displays During RUN Mode

The GP goes to the OFFLINE mode unexpectedly while operating, or the GP automatically goes to the OFFLINE mode when the power is turned ON.

For these first three problems, see the following pages' troubleshooting tables.

For the last problem (D), a SYSTEM ERROR may have developed while displaying the OFFLINE mode screen.

Reference *Chapter 6.4.2 Error Message Details*

Be sure that no object has touched the screen accidentally if the GP goes to the OFFLINE mode without displaying an error message when the power turned ON. If any object may have possibly touched the top left corner of the screen within 10 seconds after the power turned ON, that may cause the GP to go OFFLINE.

6.2.2 Troubleshooting Flow Chart

Follow the flowchart below when the screen does not display when powering up, or the screen turns OFF by itself during RUN mode, to find an appropriate solution.

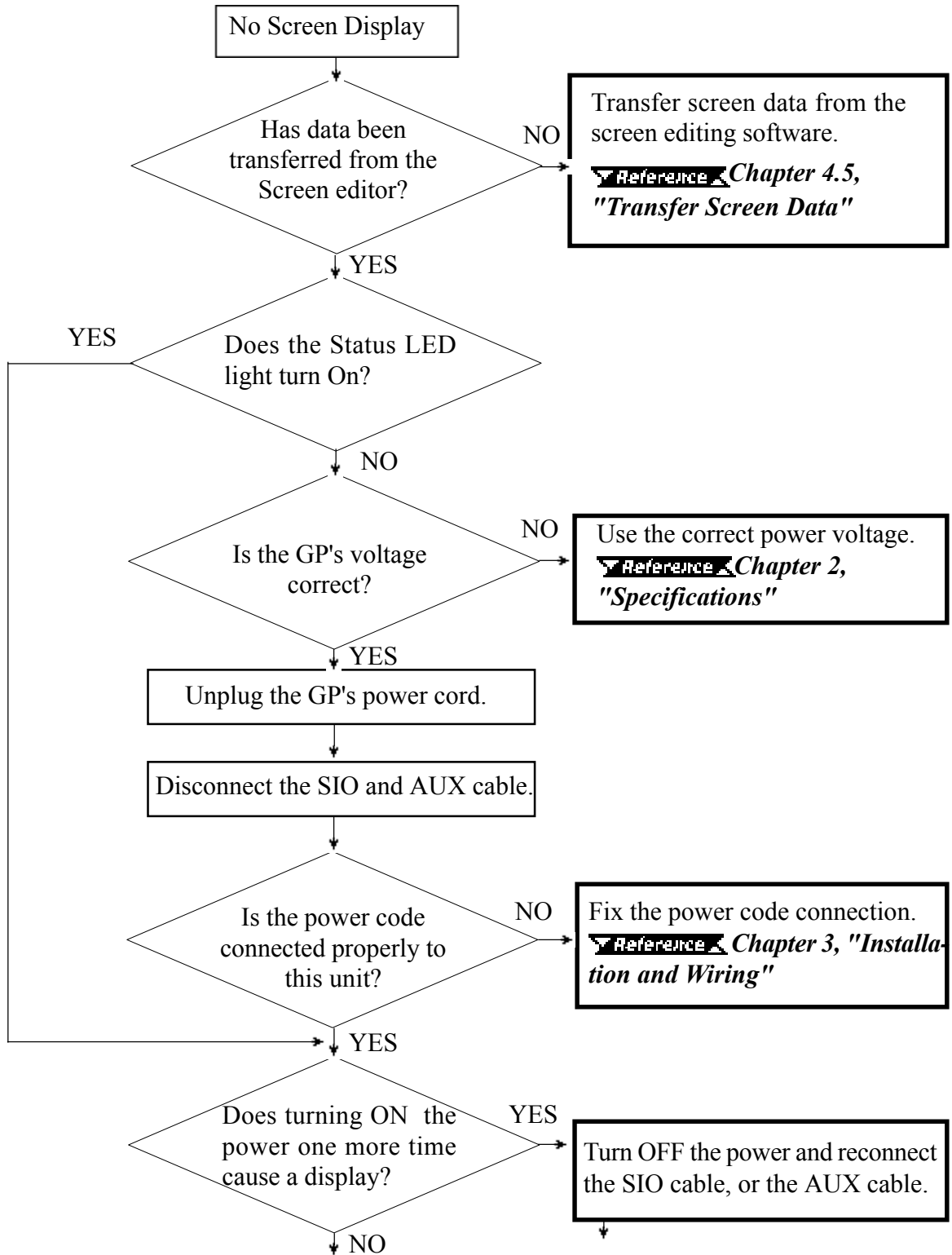

Chapter 6 - GP RUN Mode and Errors

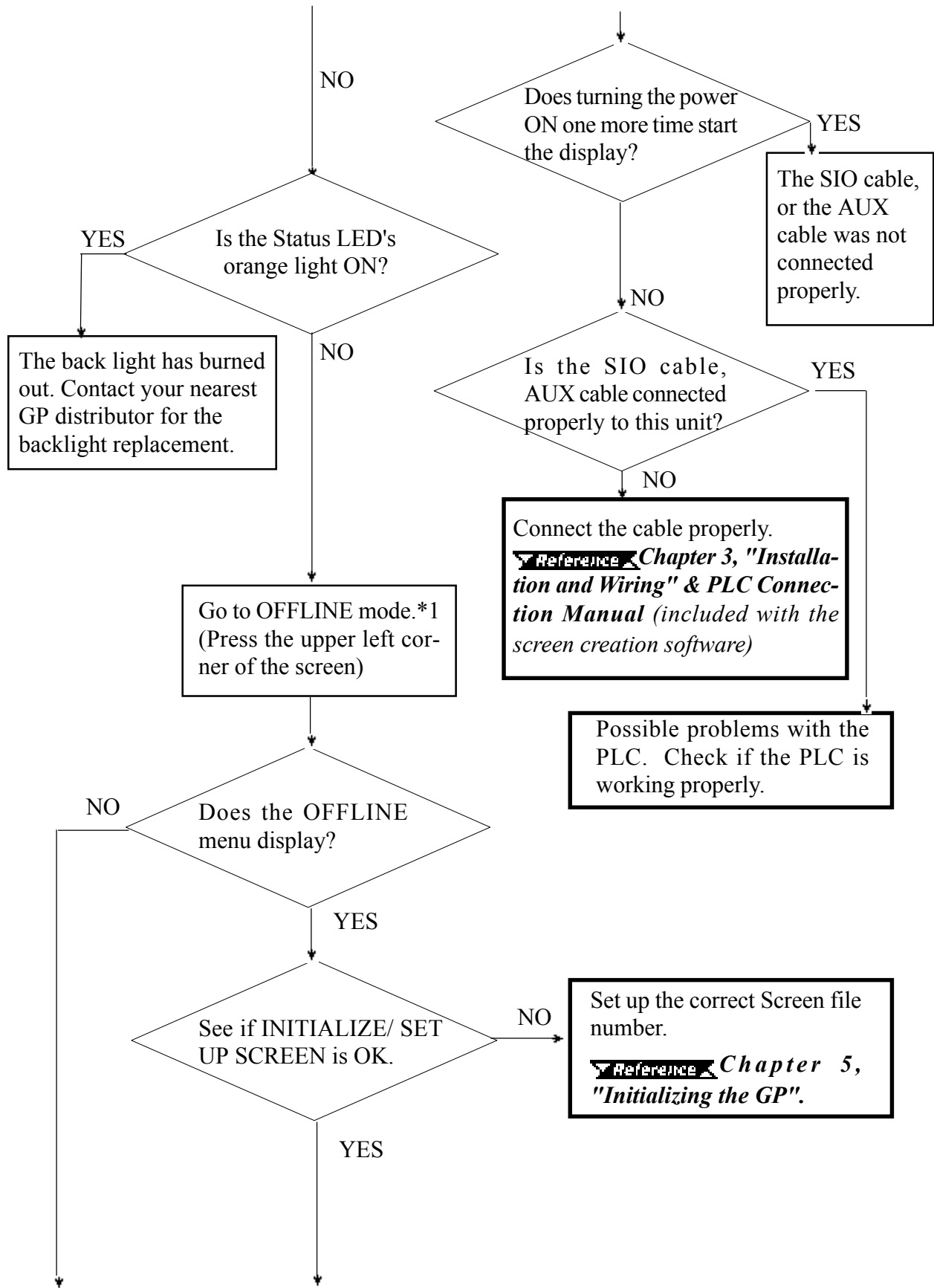

**1 To make the OFFLINE screen appear, turn the power OFF, then ON, and press the upper left corner of the screen within 10 seconds.*

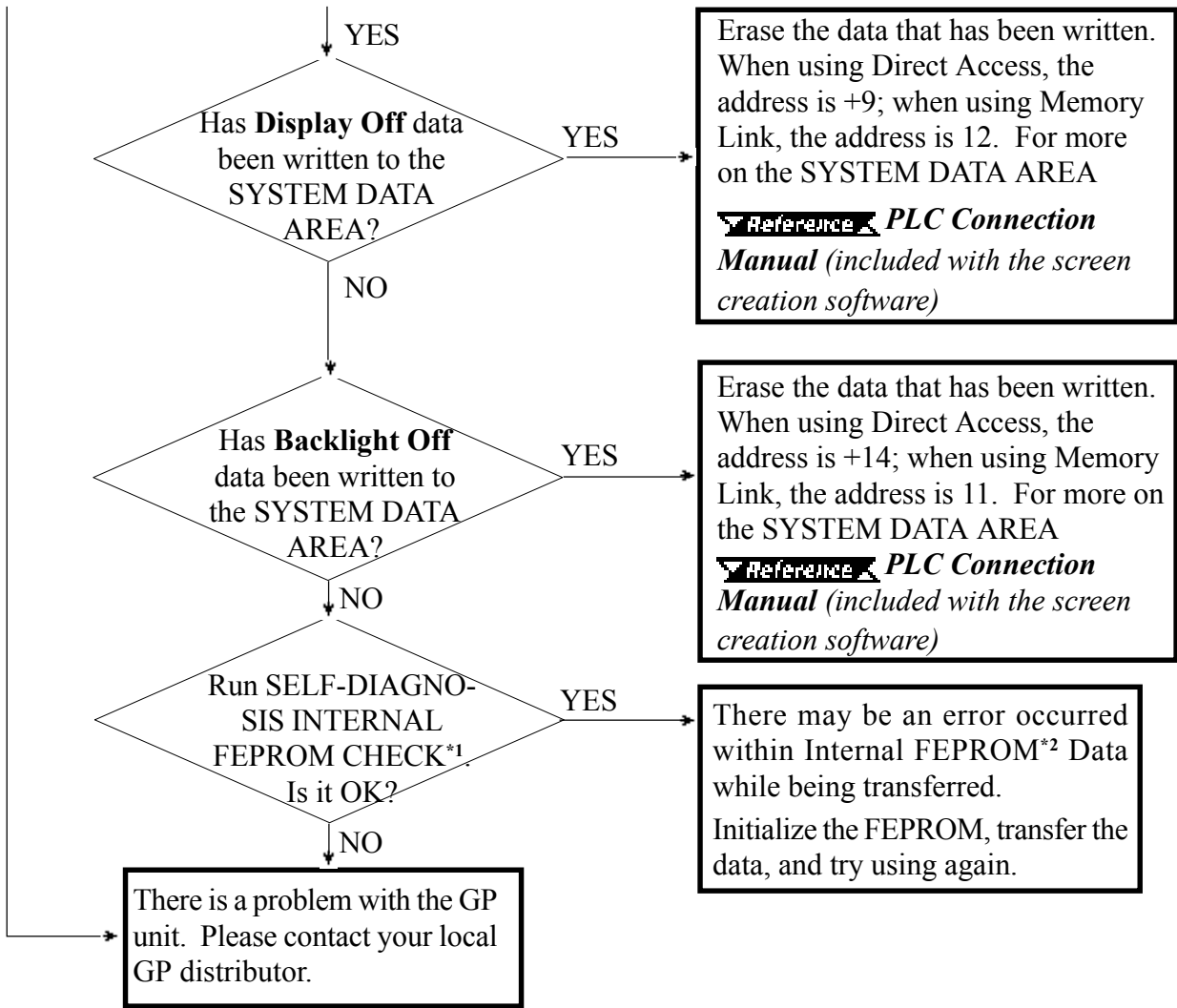

**1 When you run the SELF-DIAGNOSIS area's FEPRM CHECK , all screen data is erased. Therefore, be sure to make a backup of all GP screens prior to performing this check.*

**2 Also known as "FEPRM" (Flash Electronic Erasable Programmable Read Only Memory).*

6.2.3 No GP/Host Communication

When the GP will not communicate with the host PLC, follow the flowchart below to find both the cause of the problem and a suitable response.

Or, if an error message displays on the screen, check the error code (refer to the *Error Messages* section in this chapter) to find the appropriate solution.

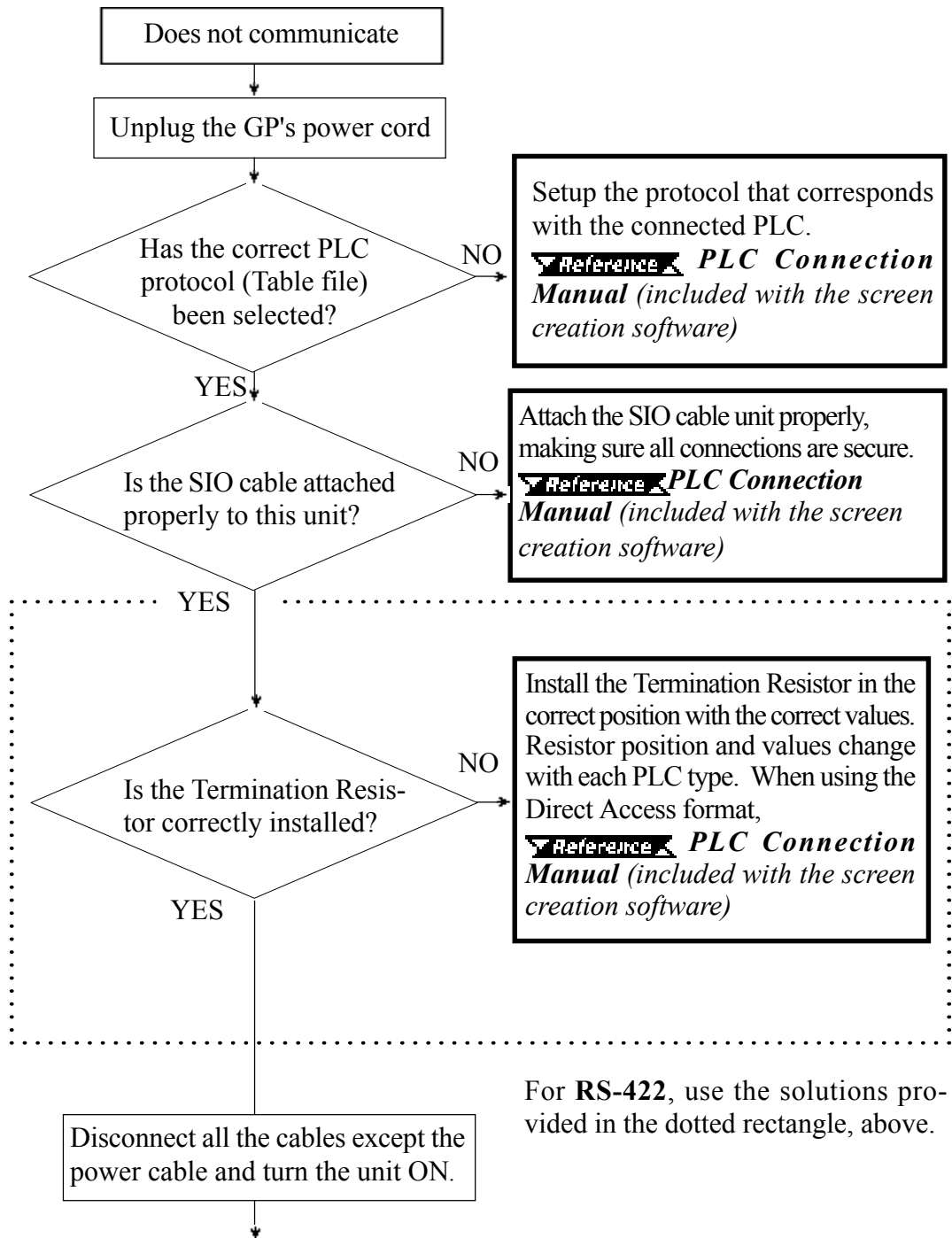

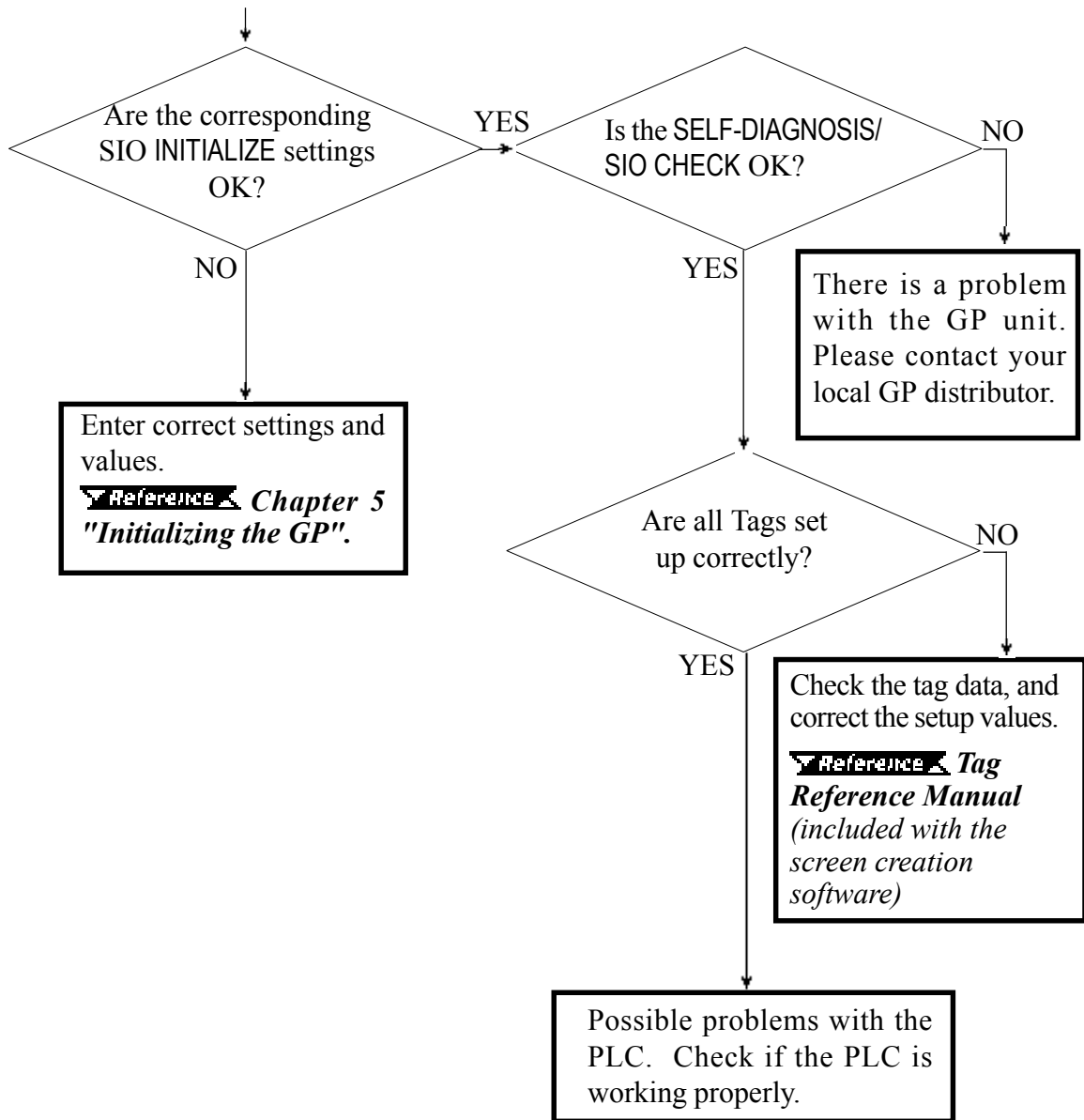

6.2.4 Touch Panel Does Not Respond

When the touch panel does not respond, or its response time is very slow after it is pressed, please use the flowchart below to find the origin of the problem, and the appropriate solution.

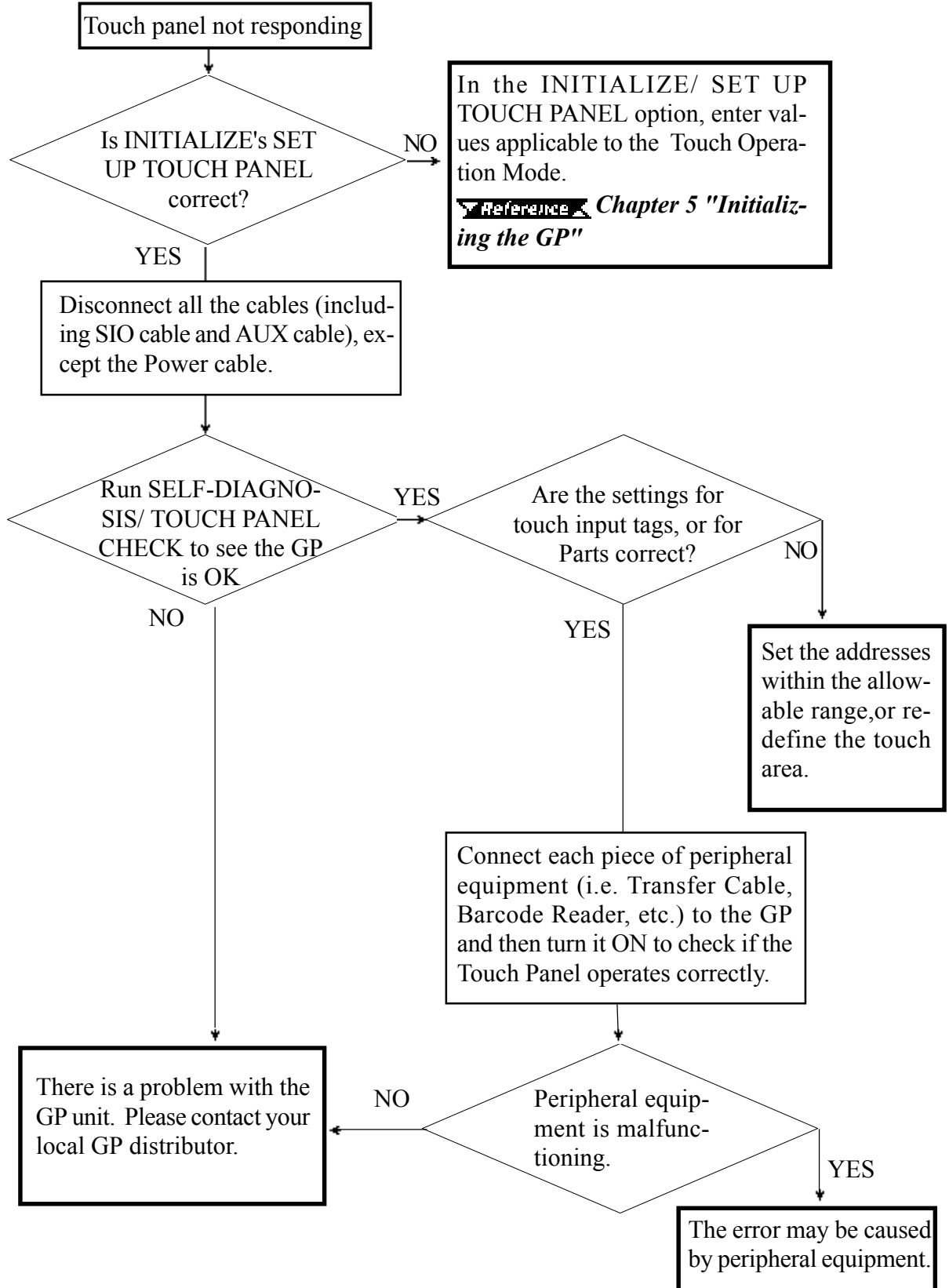

6.3 SELF-DIAGNOSIS

The GP unit is equipped to check its own System and Interface for any problems. Use it to help diagnose any problems.

6.3.1 GP SELF-DIAGNOSIS Item List

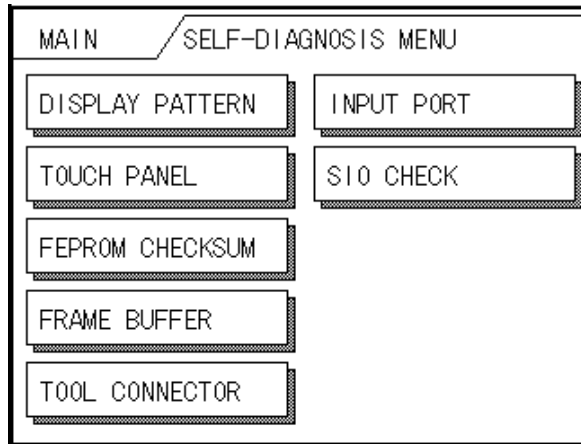

DISPLAY PATTERN

Checks all the figures and tiling patterns.

TOUCH PANEL

Checks each GP touch panel square.

FEPRM CHECKSUM

Checks the System and Protocol of the GP Internal Memory (FEPRM*¹).

FRAME BUFFER

Checks the internal display memory (Frame Buffer).

TOOL CONNECTOR *²

Checks the Tool Connector control lines and send/receive lines.

INPUT PORT

Checks the Input Port (for Digital's maintenance use only).

SIO CHECK *²

Checks the RS-232C and RS-422 send/receive lines.

*¹ Also known as "FEEPROM" (Flash Electronic Erasable Programmable Read Only Memory).

*² This item requires special tools. Please prepare the required tool for the test.

Chapter 6 - GP RUN Mode and Errors

6.3.2 SELF-DIAGNOSIS - Details

This section explains the contents of SELF-DIAGNOSIS. For information on how to operate the Screen, [Reference Chapter 4, "OFFLINE Mode"](#); for information about how to set up the Special Tools, [Reference Chapter 3, "Installation and Wiring"](#).

DISPLAY PATTERN

Used when the buzzer will not sound and when the device contents will not display correctly to check the drawing function. It does this by running checks on the various screen pattern displays (8 screens), the ON/OFF Display, and KANJIROM CHECKSUM. When the ON/OFF Display is checked, the Buzzer ON/OFF check is run simultaneously. If KANJIROM CHECKSUM is normal, **OK** displays; if there is a problem, **NG** displays.

TOUCH PANEL

Touch Panel check. Checks if each touch cell highlights when pressed.

INPUT PORT

Used only for Digital's maintenance.

INTERNAL FEPRM CHECKSUM (System & Protocol)

The Internal FEPRM*¹ System and Protocol check searches for any problems that may arise during operations. When running the check, the screen will change as follows.

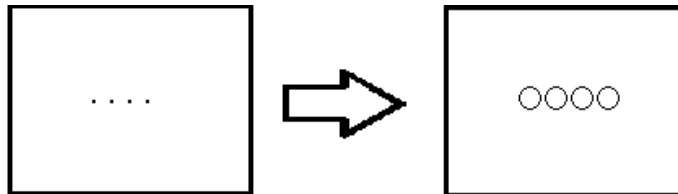

When the FEPRM is normal, **OK** displays; if there is a problem, the screen stops in the middle of operation. This check does not erase the System or Protocol.

FRAME BUFFER

The Frame Buffer (display memory) Check looks for any display problems that may develop. When everything is normal, **OK** displays; when there is a problem, an error message displays.

*1 Also known as "FEEPROM" (Flash Electronic Erasable Programmable Read Only Memory).

Chapter 6 - GP RUN Mode and Errors

TOOL CONNECTOR

Use the Tool Connector Control line and Send/Receive line check when the GP cannot send and receive data from the PC. To run the check, connecting a *Tool Connector Check Loop Back Cable* (Dsub9 pin, pin-side) mounted to the *Downloading Cable* (provided in the software package) is necessary.

When everything is normal, **OK** displays; when there is a problem, an error message displays.

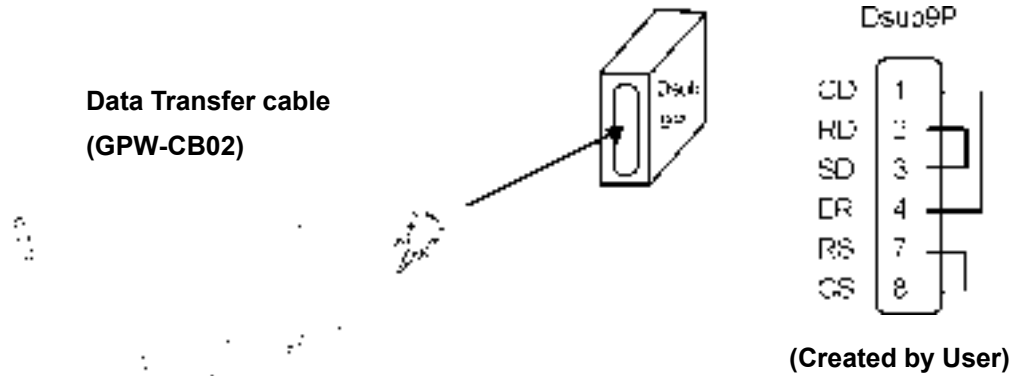

SIO CHECK

Checks the RS-232C and RS-422 SIO lines for areas where communication problems develop. In the menu, select which check to run. To run the check, connecting the SIO cable is necessary. If all is normal, **OK** displays; if there is a problem, an error message appears.

The SIO cable wiring is as shown below. (RS-232C, RS-422 common)

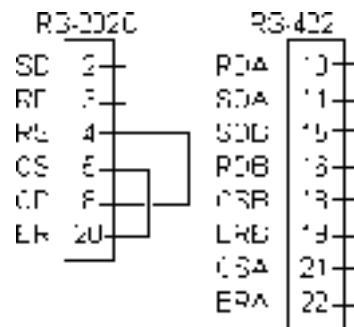



6.4 Error Messages



This section explains the messages that appear when an error has occurred in the GP unit during RUN mode. The problem causing the error message and its related countermeasure are explained in the table below.

After a problem has been solved, unplug the GP's power cord and then reattach it.
(Only the most recent error message will appear on the GP screen)

6.4.1 Error Message List

Error Message	Problem	Countermeasure
SYSTEM ERROR (03 : **)	During screen data transfer, an unrecoverable error occurred.	 6.4.2 Error Message Details
SYSTEM ERROR (** . ** . **)	During screen data transfer, an unrecoverable error occurred.	 6.4.2 Error Message Details
ILLEGAL ADDRESS IN SCREEN DATA	Settings are used that overlap addresses.	Set the addresses correctly after checking the screen data.
UNSUPPORTED TAG IN SCREEN DATA	The GP currently in use does not support the desired Tag.	Set the Tag correctly after checking the screen data.
PLC NOT CONNECTED (02 : FF) and (02 : F7)	The communication cable is not connected correctly.	Re-connect the communication cable correctly.
PLC NOT RESPONDING (02 : FE)	PLC's power is not turned ON.	Turn ON the PLC's power.
	GP unit INITIALIZE settings (Setup I/O, PLC Setting) are incorrect.	Check the INITIALIZE settings and make any necessary corrections.
	The host and GP Powering up sequence was incorrect.	Turn ON the PLC's power and wait for 2-3 seconds, then turn ON the GP's power.
	The communication cable is not connected properly.	Check the communication cable and connect it correctly.
RECEIVE DATA ERROR (02 : FD)	The communication cable was disconnected while the GP was ON.	Turn the GP OFF and then ON again.
	The GP is powered OFF, then ON during communication with PLC.	Turn the GP OFF and then ON again.
	Noise occurred in the communication cable.	Check the communication cable and connect it correctly.
GP STATION NO. DUPLICATION ERROR (02 : F9)	This GP's station number is same as another GP.	Check all GP station numbers, and set them so they are all unique.
	PLC is powered OFF, then ON during communication with GP.	Turn the GP OFF and then ON again.
NETWORK ADDRESS ERROR (02 : F8)	The SIO address used for this GP is different from other GP's. (Only for the Multi-Link connection)	Check all GP's SIO address settings, and correct any that are incorrect.
PLC COM. ERROR (02 : **)	Specific PLC related error, or an error has occurred with the PLC.	 6.4.2 Error Message Details

Chapter 6 - GP RUN Mode and Errors

SCREEN MEMORY DATA IS CORRUPT (nnnn:mmmm)	ScreenData is corrupted: *nnnn indicates the Screen Number that has an error. *mmmm indicates the number of screens that have errors.(Decimal)	Check the screens that have errors, correct all errors, and then transfer the screen data again.
CLOCK SETUP ERROR *1	The backup battery for the internal clock is running low.	 Reference 6.4.2 Error Message Details
SCREEN TRANSFER ERROR	An error occurred in the data transmission from the screen editor to the GPpanel.	Re-transfer the screen data.
SCREEN TAG LIMIT EXCEEDED	Tags are setup beyond the tag limit (max. of 385.)	 Reference 6.4.2 Error Message Details
OBJ. PLC HAS NOT BEEN SETUP (**)	The host PLC set up in the Editor program does not match the PLC in use.	 Reference 6.4.2 Error Message Details

6.4.2 Error Message Details

■ SYSTEM ERRORS

Indicates a fault in the basic operations of the GP.

Following the error message, an error code, as shown below, will appear. Report the error number and details on how the error developed to your local GP distributor.

◆ SYSTEM ERROR (03 : x x)

An unrecoverable error occurred during screen data transfer.

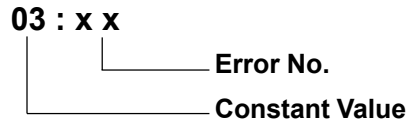

◆ SYSTEM ERROR (x x x : x x x : x x x)

An unrecoverable error occurred during screen data transfer.

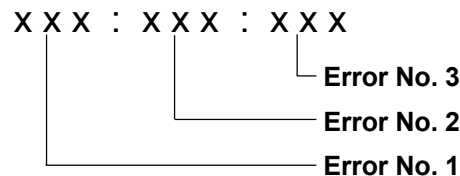

Possible Solutions

- Check if the GP's Power Cord and the Input signal line have been wired separately from each other.
- Check that the FG line has been grounded correctly, according to your country's standards.
- Re-send the screen data from the PC to the GP.
- If other types of communication errors, such as [RECIEVE DATA ERROR], [PLC COM. ERROR], have also occurred, try to correct those problems also.

Reference [6.4.1 Error Message List](#)

If the above mentioned methods do not solve the problem, please contact your local GP distributor.

■ When OFFLINE mode displays during RUN mode

When the GP changes to OFFLINE mode without the user first pressing the screen, there is a possibility that the screen data has been damaged. In this case, after the SYSTEM ERROR displays, the screen automatically reverts to OFFLINE mode after about 10 seconds. Run the INITIALIZE MEMORY command and transfer the GP screen data again from your PC.

In most cases, system errors are related to the problems mentioned below.

Environment Related Problems

If an error occurs which has no apparent connection to the GP's current operation, the error may be due to the condition of GP's operating environment. This can include noise or electrostatic interference in the power code or the communication line. In this case you need to check if the power code and the communication line wiring and FG grounding are correct.

Screen Data or Project Data Related Problems

If an error seems to be caused by a particular GP operation, the error may be related to the screen or project data transferred to the GP. In this case, try sending screen data via the FORCE SYSTEM SETUP feature, which will transfer both the screen data and the project data to the GP.

Reference For details about the FORCE SYSTEM SETUP feature, refer to GP-PRO/PBIII for Windows Ver.3.0 Operation Manual Chapter 11-2-1, Transfer Settings.

GP Unit Related Problems

If disconnecting and then re-connecting the power code corrects an error, the problem may not be related to the GP unit itself. However, to identify if the GP unit has any problems, run the OFFLINE mode's SELF-DIAGNOSIS program.

Peripheral Equipment Related Problems

(When the GP is equipped with a printer I/F)

If an error occurs only during printout, there may be a problem with the printer. Check the printer cable wiring and the FG line as well as the printer itself.

When a communication error occurs continuously

(When using the Direct Access method)

If a communication error occurs continuously, the GP may define the error as a system error. In this case you need to solve the problem causing the original communication error.

Chapter 6 - GP RUN Mode and Errors

■ ILLEGAL ADDRESS IN SCREEN DATA

Caused by an overlap of addresses.

After the error message, error codes, as listed below will appear. If the error cannot be fixed, please report the error code and details on how the error developed to your local GP distributor.

ILLEGAL ADDRESS IN SCREEN AREA (00B:XXX:XXX)

Error
No. 1

Error No. 2
(Refer to Table
below)

Overlapping Addresses

Error 1	Error 2	Meaning
0C1	191	All or part of the T-tag ^{*1} or S-tag address range overlap the addresses of System Data Area.
	192	
	193	
0C2	194	All or part of the System Data Area address, A-tag, or S-tag address range overlap the addresses setup in a T-tag. ^{*1}
	195	
	196	
0C3	197	All or part of a T-tag ^{*1} , S-tag or K-tag address range overlap the address range set in an A-tag (Alarm Message.)
	198	
	199	
0C9	19B	All or part of a T-tag ^{*1} , S-tag or K-tag address range overlap the address range set in an A-tag (Log alarm.)



Note: Overlapping addresses, other than the ones mentioned above, can also cause the Illegal Address message.

E.g. When the starting address of the System Data Area is set to 100, and the tag below is setup:

Tag Name/ Part ID No.	Word Address	Tag Format
N1	99	BCD32

Starting from addresses 99, two(2) words are used, which causes it to overlap address 100.

^{*1} For details about the T-tag (trend graph) and A-tag (alarm messages),

GP-PRO/PBIII for Windows Tag Reference Manual (included with the screen creation software)

■ PLC COM. ERROR

Appears when the address setup for tags exceeds the address range used in the host (PLC.) Check the Error Number that appears and use the following table to solve the problem.

PLC COM. ERROR (02 : x x)

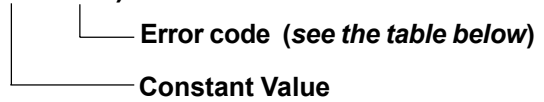

Error #	Problem	Countermeasure
FC	The communication settings for this unit and the host do not match.	Fix the SIO communication settings to match the host.
FB	The address set on a tag, the address used for storing data for Trend graph, or the address set by an alarm message is out of a set range. (address range error) * Memory to Memory Link type. * Siemen's PLC Series.	* When using Memory Link type: Set the addresses within the set range of the System Data Area (0 to 2047), and re-send correct data. * When using a Toyoda Machine Works PLC: Set the addresses within the set range of the devices. * When using a Yaskawa PLC: Set the addresses within the set range of the devices.
FA	Address range error	Set the addresses within the allowable range.
53	When using a Matsushita Electronics PLC, and there are too many screen tags, the PLC will not receive data.	Decrease the number of tags on the screen.
51	The tag addresses, Trend graph data storage address, Alarm message Registry address, do not exist in the PLC's internal memory.	* When using a Fuji Electric PLC: Setup the addresses in a device range that exists.
Others	The Error code for each PLC can be found in the table on the last page of this chapter. Then, look up the Error Number in the indicated PLC manual. Or, report the Error Number to the PLC maker.	



In Hitachi's HIDIC H (HIZAC H) Series, the error code is divided into 2 bytes, whereas the GP Error Number is composed of 1 byte codes.

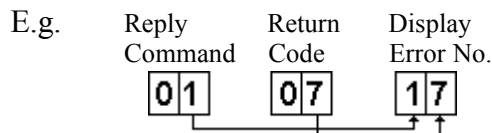

When the Display Error Number is 8*, or 5*, use only the left column as the error number.

Chapter 6 - GP RUN Mode and Errors



- In Toshiba's PROSEC T Series, the Error Code is 4 characters long; on the GP, Error Numbers are changed to and displayed in Hexadecimal.
- With the Allen-Bradley PLC-5 and SLC-500 Series, the EXT/STS error codes have been re-mapped to start at D0 HEX, so they will not conflict with other error codes. When looking up the error number in the PLC manual, subtract D0 h from the GP error code to find its error value.

E.g.	GP Error Code		PLC Error Code
	D1	-->	01
	EA	-->	1A

■ CLOCK SET UP ERROR

This message displays when the backup battery for the internal clock is running low. To reset the error, you need to turn the GP OFF and then ON again. After the GP is turned ON again, the battery has sufficient power to back up data for approximately 24 working hours (approx. 3 working days), and will continue holding a charge for approximately 96 hours (approx. 12 working days). If, however, the error is still not reset after turning the GP OFF and ON, you will need to replace the lithium battery with a new one. If the battery is incorrectly replaced (i.e, its plus and minus sides are reversed,) the battery may explode, therefore, please do not replace the battery yourself. When the battery needs to be replaced, please contact your local GP distributor.

After changing the backup battery, be sure to set the GP's internal clock.

Reference Chapter 5 - Initializing the GP



The lifetime of the backup battery depends on the ambient temperature and the amount of current being charged and used. The table below gives a general indication of how long the battery will last.

Battery Temperature	Between 40°C to 50°C	Between 50°C to 60°C	Over 60°C
Expected Lifetime	Over 10 years	Over 4.1 years	Over 1.5 years

■ SCREEN TAG LIMIT EXCEEDED (max. of 384)

When tags are setup beyond the tag limit, all tags in excess of #384 will be disabled. Plus, when tags involve registered Windows and loaded screens, they are disabled in this order: Window Registry, Load Screen.

Additionally:

1. Disabled registered windows start from the last screen used.
2. Disabled loaded screens start from the last screen used.

To correct this problem, reduce the number of tags to within the allowed limit.

■ OBJ. PLC HAS NOT BEEN SETUP

The host PLC setup in the Editor program (i.e. the .prw file) does not match the PLC in use. Use the Error Code that follows the error message to select the proper PLC type and correct the GP's INITIALIZE setup data so that it matches this.

OBJ. PLC HAS NOT BEEN SETUP (x x)

|
The PLC number (*Hexadecimal*)
written to the GP's System File

Chapter

7 Maintenance

1. Regular Cleaning
2. Periodic Check Points
3. Changing the Backlight

7.1 Regular Cleaning

7.1.1 Cleaning the Display

When the surface or the frame of the display gets dirty, soak a soft cloth in water with a neutral detergent, wring the cloth tightly, and wipe the display.



- Do not use paint thinner, organic solvents, or a strong acid compound to clean the unit.
- Do not use hard or pointed objects to operate the touch-screen panel, since it can damage the panel surface.

7.1.2 Installation Gasket Check/Replacement

The installation gasket protects the GP and improves its water resistance. For instructions on installing the GP's gasket, refer to

Reference Chapter 3 "Installation and Wiring"



A gasket which has been used for a long period of time may have scratches or dirt on it, and could have lost much of its water resistance. Be sure to change the gasket periodically (or when scratches or dirt become visible).

■ Attaching the Installation Gasket

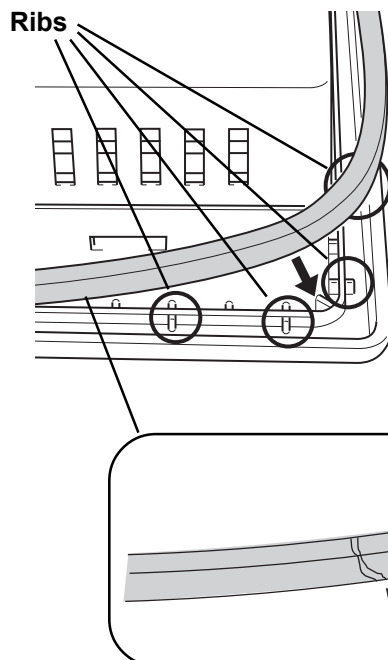

- 1) Each of the GP's corners has 4 ribs that hold the installation gasket in place. Push the gasket into the side of the GP, so that it is held by all 4 ribs.



- **The gasket is flexible, but not elastic, and may tear if stretched too far. Do not stretch the gasket around the ribs, only push.**
- **Be sure the gasket's seam is not inserted into any of the unit's corners, only in the straight sections of the groove. Inserting it into a corner may lead to its eventually tearing.**

Case Cross Section

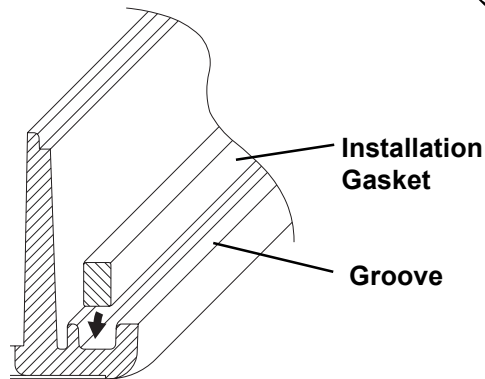

Note: Be sure to insert the gasket into the groove so that the long side is vertical.

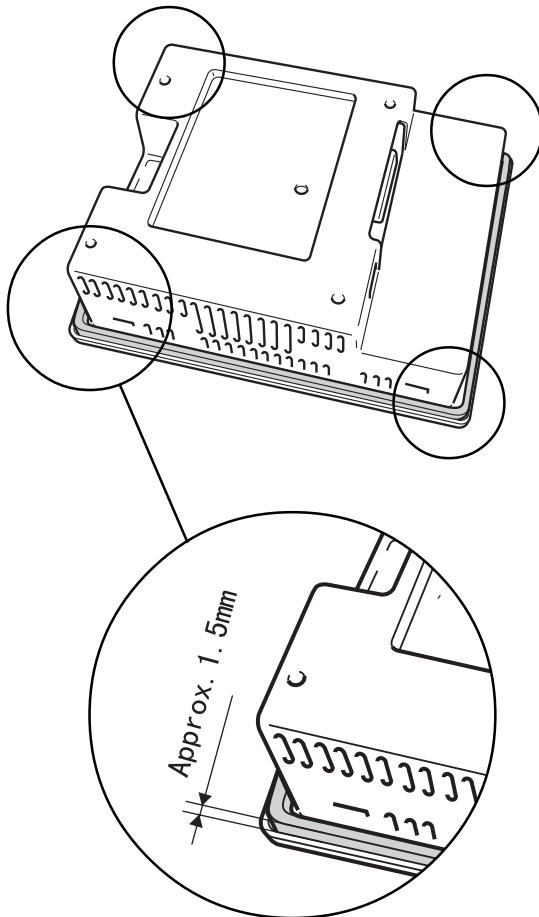

2) Insert the gasket into the GP's three remaining corners, as shown in step 1.



- **The gasket must be inserted correctly into the groove for the GP's moisture resistance to be equivalent to IP65f.**
- **The upper surface of the gasket should extend approximately 1.5mm out from the groove. Be sure to check that the gasket is correctly inserted before installing the GP into a panel.**

7.2 Periodic Check Points

To keep your GP unit in its best condition, please inspect the following points periodically.

GP Operation Environment

- Is the operating temperature within the allowable range (0 °C to 50 °C)?
- Is the operating humidity within the specified range (20% to 85% RH)?
- Is the operating atmosphere free of any corrosive gasses?

Electrical Specifications

- Is the input voltage appropriate (DC24V±15%) ?

Related Items

- Are all power cords and cables connected properly? Have any become loose?
- Are all mounting brackets holding the unit securely?
- Are there many scratches or traces of dirt on the installation gasket?

7.3 Changing the Backlight

When the unit's backlight burns out, the unit's status LED will turn orange. If the OFFLINE menu's "USE TOUCHPANEL AFTER BACKLIGHT BURNSOUT" feature is set to "NO", the GP's touch panel will be disabled*1.

▼Reference▲ 5.4.3 Setup Touchpanel

The GP-377 Series unit uses a CCFL, long-life type backlight. The actual life of the backlight however, will vary depending on the GP's operating conditions, and replacement may be required. The GP-377 Series backlight has a life of 30,000 hours (appr. 3.4 years), when the backlight is lit continuously (time required for brightness to fall to half its normal level).

WARNINGS

- **To prevent an electric shock, be sure the GP's power cord is unplugged from the power outlet prior to changing the backlight.**
- **When the power has just been turned OFF, the unit and backlight are still very hot. Be sure to use gloves to prevent burns.**
- **The backlight is very fragile. Do not touch the glass tube directly or try to remove its power cord. If the glass tube breaks you may be injured.**



Note: Use the following table to check that you have ordered the correct backlight.

GP	Backlight Model
GP377-LG11-24V	GP377L/S-BL00-MS
GP377-LG41-24V	
GP377-SC11-24V	
GP377-SC41-24V	

*1 If "NO" has been selected for the OFFLINE menu's "FORCE RESET" feature, Touch-Panel operation is disabled.

Chapter 7 - Maintenance

Use the following steps to change the Backlight. Be sure to use gloves.

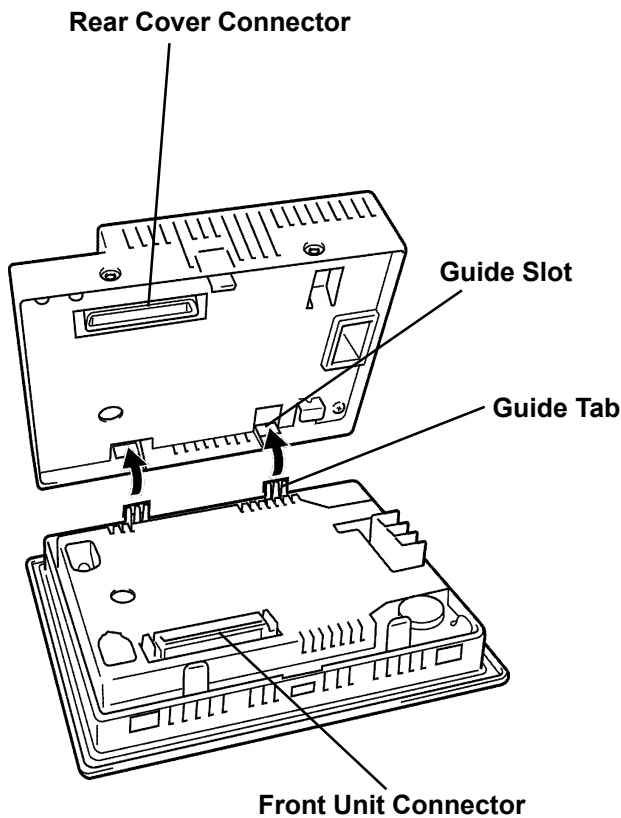
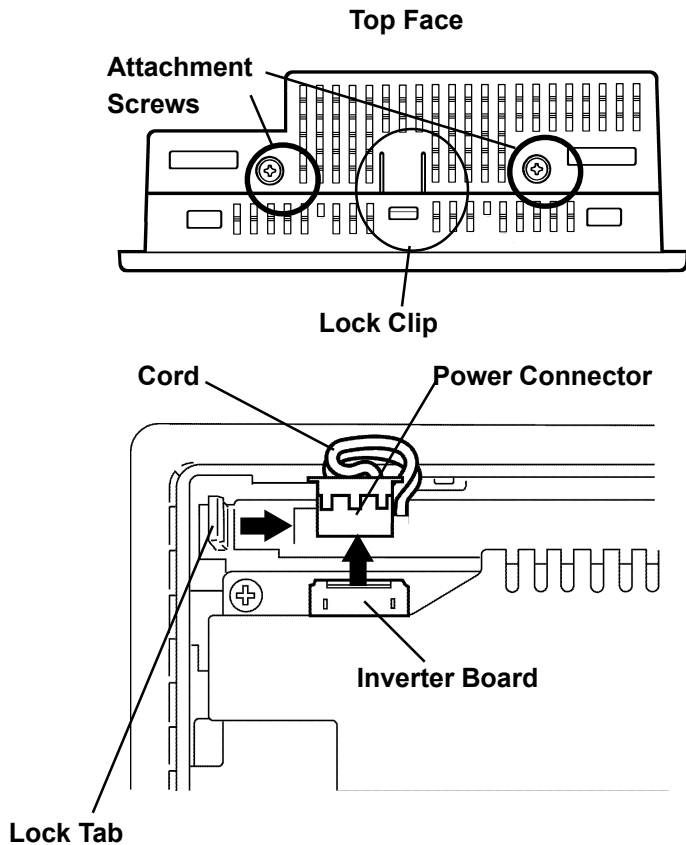

- 1) Unplug the GP's power cord from the power supply. Then, remove the GP's power cord terminals from the power terminal block.
- 2) Unscrew the GP's two (2) top face attachment screws.
- 3) Push down on the Lock Clip and open the GP's rear cover.
- 4) Disconnect the backlight's power connector from the inverter board. Do not try to pull the cord out of the backlight.
- 5) Push the backlight's Lock Tab to the right to free the backlight, then pull it upwards and out of the unit.
- 6) Insert the new backlight and slide it into its slot until the Lock Tab can be clicked into place.
- 7) Attach the new backlight's Power Connector to the inverter board.
- 8) To replace the GP's rear cover, insert the cover's guide tabs into the case's guide slots and close the cover. Be sure that the Rear Cover Connector and the Front Unit Connector are correctly aligned.

Memo

Index

A

ALARM MESSAGE 5-22
 Available Software 1-4

B

BRIGHTNESS SETTING 5-13
 Buzzer Output 2-6

C

Changing the Backlight 7-4
 CHARACTER STRING DATA Mode List 5-7
 CHARACTER STRING DATA SETUP 5-7
 Cleaning the Display 7-1
 CLOCK SET UP ERROR 6-19
 COMMUNICATION INTERFACE 5-10
 COMMUNICATION RATE 5-10
 Connecting the GP's Power Cord 3-4
 CONTRAST SETTING 5-13
 CONTROL 5-10
 Creating installation openings 3-1
 CUSTOMIZE SETUP (n:1) 5-19

D

DATA FORMAT 5-6
 DATA LENGTH 5-10
 DATA TYPE OF SCREEN NO. 5-4
 Display Features 2-3
 Display Panel 2-7
 DISPLAY PATTERN 6-10, 6-11

E

Electrical Specifications 2-1
 Environmental Specifications 2-2
 Error Message Details 6-15
 Error Message List 6-13
 Error Messages 6-13
 Expansion Interface 2-7
 External Dimensions 2-8

F

Features and Performance 2-3

FEPROM CHECKSUM 6-10
 FONT SETTING 5-23
 FRAME BUFFER 6-10, 6-11

G

GLOBAL WINDOW 5-6
 GLOBAL WINDOW ACCESS 5-6
 GLOBAL WINDOW SETUP 5-6
 GP Disposal Precautions vii
 GP SELF-DIAGNOSIS Item List 6-10
 GP Start-up and Maintenance Precautions vii
 GP TOUCH MONOPOLIZE 5-20
 GP's Display Panel ix
 GP-377R Series Models x
 Graphic Panel Dimensions 2-8
 Grounding the GP 3-5

I

ILLEGAL ADDRESS IN SCREEN DATA 6-17
 INITIAL SCREEN NO. 5-22
 Initialization Items 5-2
 Initialization Screen 5-1
 INITIALIZE INTERNAL MEMORY 5-21
 INPUT PORT 6-10, 6-11
 Installation 3-1
 Installation Direction 3-3
 Installation Fasteners 2-9
 Installation Mounting Hole Dimensions 2-9
 Installation Precautions vii
 Interface Specifications 2-5
 IP65f x

K

KANJI FONT QUALITY 5-23

M

Moisture Resistant Gasket Replacement .. 3-1, 7-1
 MONOPOLIZE TIME (0 to 2550s) 5-20

N

NETWORK INFORMATION (DEV/ADR) 5-17
 No Display 6-3
 No GP/HOST Communication 6-3

O

OBJ. PLC HAS NOT BEEN SETUP	6-20
OFFLINE displays During RUN Mode	6-3
ONLINE ERror Display	5-22
Optional Maintenance Items	1-5
Options	1-5
Overlapping Addresses	6-17

P

PLC COM. ERROR	6-18
PARITY	5-10
PASSWORD SETUP(0-9999)	5-3
Periodic Check Points	7-3
Placement of I/O Signal Lines	3-5
PLC PRIORITY	5-19
PLC SETUP	5-16
Possible Types of Trouble	6-3, 6-4, 6-7
Power Input Terminal Block	2-7
Prevent Damage to the GP	viii

R

RECEIVE TIMEOUT	5-11
REGISTRATION NO. (1-256)	5-6
Regular Cleaning	7-1
RESET GP ON WRITE ERROR	5-17
RETRY COUNT	5-11
RUN Mode	6-1

S

SELF-DIAGNOSIS - Details	6-11
Safety Precautions	v, x
Screen Data or Project Data Related Problems ...	6-16
SCREEN TAG LIMIT EXCEEDED(max. of 384) .	6-19
SELF-DIAGNOSIS	6-10
SELF-DIAGNOSIS-tandard Operation	4-6
Serial Interface	1-4, 2-5, 2-7
SET UP I/O	5-10
SET UP SCREEN	5-22
SET UP TIME	5-21
SET UP TOUCH PANEL	5-12, 5-15
SIO CHECK	6-10, 6-12
STAND-BY MODE TIME (0-255)	5-3
START TIME (0-255)	5-3

STATION NO. (0-15)	5-18
Status LED	2-7
Steps to run SYSTEM RESET	5-12
Structural Specifications	2-1
SYSTEM AREA READ SIZE (0-256)	5-16
SYSTEM AREA SETUP	5-4
System Area Size	5-4
SYSTEM AREA START (DEV/ ADR)	5-16
SYSTEM ENVIRONMENT SETUP	5-3
SYSTEM ERROR	6-15
SYSTEM ERROR (03 : x x)	6-15
SYSTEM ERROR (x x x : x x x : x x x)	6-15
SYSTEM RESET MODE	5-12
SYSTEM SETUP	5-3

T

TOOL CONNECTOR.....	6-10, 6-12
Tool Connector	1-4, 2-7, 3-6
TOUCH BUZZER SOUND	5-3
TOUCH OPERATION MODE	5-12
TOUCH PANEL	6-10, 6-11
Touch Panel	2-7
Touch Panel / Clock Accuracy	2-4
Touch Panel Does Not Respond	6-3, 6-9
Transferring Screen Data	4-8
Troubleshooting	6-3
Turning the GP's Power ON	4-1

U

USE TOUCH PANEL AFTER BACKLIGHT BURN- OUT	5-14
--	------

V

Validation List	5-18
-----------------------	------

W

When OFFLINE mode displays during RUN mode	6-16
Wiring Cautions	3-4
Wiring Precautions	vii