

# Preface

Congratulations on purchasing Digital's Pro-face GP-377R Series Graphic Control Panels (hereafter referred to as "the GP").

This GP unit, with its expanded functionality and improved overall performance, is an upgrade of Digital's GP70 series panels. Also, instead of using the optional 2-Port Adapter, the Mitsubishi Electric Corporation's GPP software package and the GP's rear face tool connector can now be used to provide 2-Port feature communication.

Please read this manual carefully as it explains, step by step, how to use the GP correctly and safely.

Also, in this manual's examples, the Mitsubishi MELSEC-AnA Series PLC is used whenever possible, connected in a one-to-one relationship with a GP.

## <Note>

- 1) It is forbidden to copy the contents of this manual, in whole or in part, except for the user's personal use, without the express permission of the Digital Electronics Corporation of Japan.
- 2) The information provided in this manual is subject to change without notice.
- 3) This manual has been written with care and attention to detail; however, should you find any errors or omissions, please contact Digital Electronics and inform them of your findings.
- 4) Please be aware that we are not responsible for any damages resulting from the use of our products, regardless of article 3 above.
- 5) The GP377R-TC41-24V is UL/c-UL(CSA) approved and CE marked unit. However, installing an expansion unit in the GP that is not UL/c-UL(CSA) approved and CE marked will cause the GP377R-TC41-24V to lose its UL/c-UL(CSA) approval and CE marking.

All Company/Manufacturer names used in this manual are the registered trademarks of those companies.

© Copyright 1999, Digital Electronics Corporation

# Table of Contents

Preface .....	i
Table of Contents .....	ii
Essential Safety Precautions .....	v
UL/c-UL(CSA) Approval .....	viii
CE Marking .....	viii
About GP-377R Series Models .....	ix
What is IP65f? .....	ix
Package Contents .....	x
Separately Sold Manual .....	x
Documentation Conventions .....	xi

## Chapter 1 Introduction

1.1 Prior to Operating the GP .....	1-1
1.2 System Design .....	1-2
1.3 Optional Items .....	1-4
1.4 2-Port Feature Overview .....	1-6

## Chapter 2 Specifications

2.1 General Specifications .....	2-1
2.1.1 Electrical .....	2-1
2.1.2 Structural .....	2-1
2.1.3 Environmental .....	2-2
2.2 Performance Specifications .....	2-3
2.2.1 Display Features .....	2-3
2.2.2 Screen Memory .....	2-3
2.2.3 Touch Panel / Clock Accuracy .....	2-4
2.2.4 External Interfaces .....	2-4
2.3 Interface Specifications .....	2-5
2.3.1 Serial Interface .....	2-5
2.4 Names and Functions of GP Parts .....	2-7
2.5 Graphic Panel Dimensions .....	2-8
2.5.1 GP-377R Series - External Dimensions .....	2-8
2.5.2 Installation Fasteners .....	2-9
2.5.3 GP Panel Cut Out Dimensions .....	2-9

## Chapter 3 Installation and Wiring

3.1	Installation .....	3-1
3.1.1	Installation Procedures .....	3-1
3.2	Wiring Cautions .....	3-4
3.2.1	Connecting the GP's Power Cord .....	3-4
3.2.2	Grounding the GP .....	3-5
3.2.3	Placement of I/O Signal Lines .....	3-5
3.3	GP Tool Connector .....	3-6

## Chapter 4 OFFLINE Mode

4.1	Entering OFFLINE Mode .....	4-1
4.1.1	When Turning the GP's Power ON .....	4-1
4.1.2	From Forced Reset .....	4-2
4.2	OFFLINE Mode's Main Menu .....	4-3
4.3	INITIALIZE—Standard Operation .....	4-4
4.4	SELF-DIAGNOSIS—Standard Operation .....	4-6
4.5	Transferring Screen Data .....	4-8

## Chapter 5 Initializing the GP

5.1	Initialization Screen .....	5-1
5.2	Initialization Items .....	5-2
5.3	SYSTEM ENVIRONMENT SETUP .....	5-3
5.3.1	SYSTEM SETUP .....	5-3
5.3.2	SYSTEM AREA SETUP .....	5-4
5.3.3	GLOBAL WINDOW SETUP .....	5-6
5.3.4	CHARACTER STRING DATA SETUP .....	5-7
5.4	SET UP I/O .....	5-10
5.4.1	SET UP SIO .....	5-10
5.4.2	COMMUNICATION SETUP .....	5-11
5.4.3	SET UP TOUCH PANEL .....	5-12
5.5	PLC SETUP .....	5-14
5.5.1	SET UP OPERATION SURROUNDINGS (1:1/n:1) .....	5-14
5.5.2	STATION SETUP (n:1) .....	5-15
5.5.3	CUSTOMIZE SETUP (n:1) .....	5-17
5.6	INITIALIZE INTERNAL MEMORY .....	5-19
5.7	SET UP TIME .....	5-19
5.8	SET UP SCREEN .....	5-20
5.9	FONT SETTING .....	5-21

## Chapter 6 GP RUN Mode and Errors

6.1	GP RUN Mode .....	6-1
6.1.1	After Powering Up the GP .....	6-1
6.1.2	Via OFFLINE Mode .....	6-1
6.2	Troubleshooting .....	6-3
6.2.1	Possible Types of Trouble .....	6-3
6.2.2	Troubleshooting Checklists .....	6-4
6.2.3	No GP/Host Communication .....	6-7
6.2.4	Touch Panel Does Not Respond .....	6-9
6.3	SELF-DIAGNOSIS .....	6-10
6.3.1	GP SELF-DIAGNOSIS Item List .....	6-10
6.3.2	SELF-DIAGNOSIS - Details .....	6-11
6.4	Error Messages .....	6-13
6.4.1	Error Message List .....	6-13
6.4.2	Error Message Details .....	6-15

## Chapter 7 Maintenance

7.1	Regular Cleaning .....	7-1
7.1.1	Cleaning the Display .....	7-1
7.1.2	Moisture Resistant Gasket Replacement .....	7-1
7.2	Periodic Check Points .....	7-2
7.3	Changing the Backlight .....	7-3

## Index

# Essential Safety Precautions

This manual includes procedures that must be followed to operate the GP correctly and safely. Be sure to read this manual and any related materials thoroughly to understand the correct operation and functions of this unit.

## Usage of Icons

To allow you to use the GP correctly, throughout this manual, the following icons are provided next to operations requiring special attention. The operations described with these icons contain essential safety information. The following is an example of these icons and their meanings:



Indicates situations where severe bodily injury, death or major equipment damage can occur.



Indicates situations where slight bodily injury or machine damage can occur.



## Warning

### Design Precautions

- Do not create switches used to control machine safety operation, such as an emergency stop switch, as a GP touch screen icon. Be sure to install these switches as separate hardware switches otherwise bodily injury or damage can occur.
- Please design your system so that the machine will not malfunction due to a communication fault between the GP and its host controller. This is to prevent any possibility of personal injury or material damage.

### Installation Precautions

- High voltage runs through the GP. Except for replacing the backlight, never disassemble the GP, otherwise an electric shock can occur.
- Do not modify the GP unit. Doing so may cause a fire or an electric shock.
- Do not use the GP in an environment where flammable gasses are present, since operating the GP may cause an explosion.

### Wiring Precautions

- Prior to installing the GP or when connecting any cables or lines to it, be sure to confirm that the GP's power cord is not connected to the main power to avoid the possibility of an electric shock.
- Do not use power beyond the GP's specified voltage range. Doing so may cause a fire or an electric shock.

### Start-up and Maintenance Precautions

- The GP uses a lithium battery for backing up its internal clock data. If the battery is incorrectly replaced, the battery may explode. To prevent this, please do not replace the battery yourself. When the battery needs to be replaced, please contact your local GP distributor.



## Caution

### Installation Precautions

- Be sure to use the attachment screws given (included with the GP) to attach an expansion unit to the GP. If the expansion unit is not attached correctly, incorrect GP operation may be caused, or the expansion unit may malfunction or fall off the GP unit.
- Be sure to securely connect all cable connectors to the GP. A loose connection may cause incorrect input or output.

### Wiring Precautions

- Ground the GP's FG line separately from other units' FG lines. Putting these FG lines too close may cause an electric shock or unit malfunction. Be sure to use a grounding resistance of 100Ω or less and a 2mm<sup>2</sup> or thicker wire, or your country's applicable standard.
- When wiring the GP, be sure that the rated voltage and terminal layout are within the designated range. If the voltage supplied differs from the rated voltage, or incorrect wiring or grounding is performed, it may cause a fire or unit malfunction.
- Use only the designated torque to tighten the GP's terminal block screws. If these screws are not tightened firmly, it may cause a short-circuit, fire, or GP malfunction.
- Be careful that metal filings and wiring debris do not fall inside the GP, since they can cause a fire, GP malfunction, or incorrect operation.

### GP Start-up and Maintenance Precautions

- Prior to attaching or removing an expansion unit, be sure that the GP's power cord is not connected. If the attachment or removal of an expansion unit is performed while the GP's power cord is connected, an expansion unit or a GP malfunction may occur.
- The liquid crystal panel contains a powerful irritant and if for any reason the panel is damaged and this liquid contacts any part of your body, be sure to wash that area with running water for 15 minutes. If any of this liquid enters your eye, flush your eye for 15 minutes with running water and contact a physician.

### GP Disposal Precautions

- When this unit is disposed of, it should be processed according to your country's regulations for similar types of industrial waste.

### ■ To Prevent Damage to the GP



- Never strike the touch panel with a hard or heavy object, or push on the touch panel with too much force since it may damage the unit.
- If the GP is used in an environment with temperatures and humidity in excess of the allowed range, the GP may malfunction and/or its useful life may be shortened.
- Avoid restricting the GP's naturally occurring ventilation, or storing or using the GP in an environment that is too hot.
- Do not use this unit in areas where large, sudden temperature changes can occur thereby causing condensation to form inside the unit. This can cause the unit to malfunction.

- Do not allow water, liquids, metal particles, or charged particles to enter inside the GP's chassis, since they can cause either a GP malfunction or an electrical shock.
- Avoid using or storing the GP in direct sunlight, or in excessively dusty or dirty environments.
- Because the GP is a precision instrument, do not store or use the GP where a large shocks or excessive vibration can occur.
- Do not store or use the GP where chemicals (such as organic solvents, etc.) and acids can evaporate, or where chemicals and acids are present in the air.
- Do not use paint thinner or organic solvents to clean the GP.
- Do not store or operate the LCD display in areas receiving direct sunlight, since the sun's strong UV rays may cause the LCD display's quality to deteriorate.
- Storing this unit in areas at a temperature lower than is recommended in this manual's specifications may cause the LCD display's liquid to congeal, which may damage the panel. Conversely, if the storage area's temperature becomes higher than the allowed level, the LCD's liquid will become isotropic, which is irreversible. To avoid problems like these, be sure to store the panel only in areas where temperatures are within those specified in this manual.



**Due to the danger of unforeseen accidents, be sure to back up the GP's screen data regularly.**

### About the GP's Display Panel

- The Display Panel contents, the power voltage and brightness affect the intensity of *Contouring*<sup>\*1</sup>. (i.e, when some parts of the screen are brighter than others, creating a wavelike pattern)
- There are minute grid-points (dark and light) on the Display Panel's surface. This is part of the GP's design and not a defect.
- Shadows may appear at the top of the LCD. This is normal for an LCD display.
- Sometimes the display area may look as if the display colors have changed. This is a common attribute of LCD's and is not a defect.
- Displaying a single image for long periods can cause an afterimage to remain when the display is changed to another screen.

#### To prevent this effect:

- Set the unit to "Stand-by Mode", which automatically turns the screen OFF when there is no input for a specified period of time.

#### **▼Reference▲ 5.3.1 System Setup**

- When a single screen will be constantly displayed, write "FFFFh" to the System Data area's [Screen Display OFF] area<sup>\*2</sup>, which will turn the screen display off.
- Do not display any single screen for a long period of time. Try to always change the screen display periodically.

---

<sup>\*1</sup> Even if the operating voltage is within the specified range, if it becomes too low, the backlight may create contouring.

<sup>\*2</sup> When the Direct Access method is used, the corresponding system data area word address is +9. With the Memory Link method is used, it is address 12. (Assuming the System Data Area's settings are all entered)

**▼Reference▲ PLC Connection Manual (included with screen editor software)**

# UL/c-UL(CSA) Approval

The GP377R-TC41-24V unit is a UL/c-UL listed product. (UL file No.E182139)

## **This unit conforms to the following standards:**

- **UL508**

Industrial Control Equipment

- **UL1604**

For use with Electrical Equipment in Class I and II, Division 2 and Class III Hazardous (Classified) Locations in industrial control applications.

## **CAN/CSA-C22.2, Nos. 142 and 213-M1987**

Standard for Safety of Information Technology Equipment, including Electrical Business Equipment

## **GP377R-TC41-24V (UL Registration Model: 2880037)**

### **<Cautions>**

- The GP must be used as a built-in component of an end-use product.
- This unit should be installed in the front face of a metal panel.
- If this unit is installed so as to cool itself naturally, be sure to install it in a vertical panel. Also, be sure that the GP is mounted at least 100 mm away from any adjacent structures or equipment. If these requirements are not met, the heat generated by the GP's internal components may cause the unit to fail to meet UL/cUL standard requirements.

## **UL1604 Conditions of Acceptability and Handling Cautions:**

1. Power, input and output (I/O) wiring must be in accordance with Class I, Division 2 wiring methods - Article 501- 4(b) of the National Electrical Code, NFPA 70 within the United States, and in accordance with Section 18-52 of the Canadian Electrical Code for units installed within Canada.
2. Suitable for use in Class I, Division 2, Groups A, B, C and D, Hazardous Locations.
3. **WARNING:** Explosion hazard - substitution of components may impair suitability for Class I, Division 2.
4. **WARNING:** Explosion hazard - when in hazardous locations, turn power OFF before replacing or wiring modules.
5. **WARNING:** Explosion hazard - do not disconnect equipment unless power has been switched OFF, or the area is known to be non-hazardous.

# CE Marking

The GP377R-TC41-24V is a CE marked product that conforms to EMC directives EN55011 class A and EN50082-2.

*\* For detailed CE marking information, please contact your local GP distributor.*



## About GP-377R Series Models

The GP-377R Series refers to the following GP model numbers:

Series	Model Name	Model Type	Comments
GP-377R	GP-377RT	GP377R-TC11-24V	Standard unit *1
		GP377R-TC41-24V	UL/c-UL (CSA) approved and CE marked unit

## What is IP65f?

This unit's protection rating of IP65f is actually a composite code, consisting of the internationally recognized British "Ingress Protection" standard (BS EN 60529:1992) - "IP65", and the standard developed by the Japanese Electronics Manufacturer's Association (JEM) - "f". This code is used in this manual to identify a given product's degree of structural resistance to a variety of environmental elements and thus, prevent problems or accidents related to the inappropriate use of a product.

The individual meaning of each character of this code is explained below. This code indicates the degree of ingress protection provided from the front face of the GP, and assumes that the GP is securely mounted into a metal panel.

**IP 6 5 f**  
 (1) (2) (3) (4)

(1) Designates the type of protection provided.

(2) Indicates the degree of protection provided to the human body by the unit, and the degree of protection provided by the unit's front face from particles/dust intrusion into the interior of the unit.

Here, "6" indicates that the unit is completely protected from dust intrusion.

(3) Indicates the degree of protection provided by the unit's front face from water intrusion into the interior of the unit.

Here, "5" indicates that the unit is protected from water intrusion from a direct water jet.

(4) Indicates the degree of protection provided by the unit's front face from oil particle intrusion into the interior of the unit.

Here, "f" indicates that the unit is completely protected from oil intrusion via either oil particles or oil splashes from any direction (to the front panel).

---

\*1 This unit is not UL/c-UL(CSA) approved or CE marked.

# Package Contents

The GP's packing box contains the items listed below. Please check to confirm that all items shown below have been included.

■ **GP Unit**

GP377R-TC11-24V  
GP377R-TC41-24V

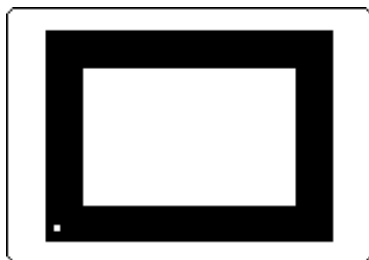

■ **Installation Guide (1)**

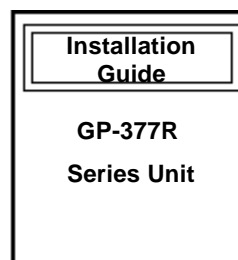

■ **Installation fasteners (4/set)**

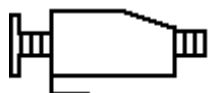

This unit has been carefully packed, with special attention to quality. However, should you find anything damaged or missing, please contact your local GP distributor immediately for prompt service.

# Separately Sold Manual



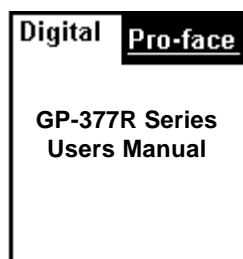

This manual (GP-377R Series Users Manual) is sold separately.

■ **GP-377R Series Users Manual (1)**



# Documentation Conventions

The list below describes the documentation conventions used in this manual.

Symbol	Meaning
	Indicates important information or procedures that <u>must</u> be followed for correct and risk-free software/device operation.
	Indicates procedures that must be followed.
	Indicates actions that must not be performed.
	Provides useful or important supplemental information.
*1	Indicates useful or important supplemental information.
	Refers to useful or important supplemental information
1) , 2)	Indicates steps in a procedure. Be sure to perform these steps in the order given.
GP	Abbreviation for Graphic Panel.
PLC	Abbreviation for Programmable Logic Controller
Screen Editor Software	Abbreviation for the GP-PRO/PBIII for Windows Ver. 4.0 ML software.

*Memo*



# Chapter 1 Introduction

1. Prior to Operating the GP
2. System Design
3. Optional Items
4. 2-Port Feature Overview

## 1.1 Prior to Operating the GP

Be sure to follow these steps when creating projects for the GP unit.

- 1 Preparation**

Before using the GP, check that all required hardware is present and read all specification, wiring, and installation information.

**Reference** Chapter 2, "Specifications", and Chapter 3, "Installation and Wiring"
- 2 Screen Design**

Create a sample screen and design a Tag layout, with the Screen layout sheets and Tag lists provided in the Editor software.

**Reference** GP-PRO/PBIII for Windows Operation Manual (included with the screen creation software)
- 3 Select GP and PLC types**

Using the input areas provided, select the GP and the PLC types to be used.

**Reference** GP-PRO/PBIII for Windows Operation Manual (included with the screen creation software)
- 4 Create Screen/ Run Screen Setup**

Setup the screen and tags in your screen editing software according to your Screen Design.

**Reference** GP-PRO/PBIII for Windows Operation Manual and Tag Reference Manual (included with the screen creation software)
- 5 Transfer Screen Data**

Transfer the data from the Screen editor software on your PC to the GP unit using the Downloading Cable.

**Reference** GP-PRO/PBIII for Windows Operation Manual (included with the screen creation software)
- 6 GP/Host Connection**

Set up the GP so that it can receive data from the Host (PLC).

**Reference** Chapter 4-3, "Initialize", and PLC Connection Manual
- 7 Operate the GP**

Link the GP with the host (PLC) using the appropriate connection cable (different cables may be necessary for different hosts), and then run the unit.

**Reference** GP-PRO/PBIII for Windows PLC Connection Manual (included with the screen creation software)

# 1.2 System Design

The diagrams on the following pages illustrate the peripheral equipment available for the GP unit.

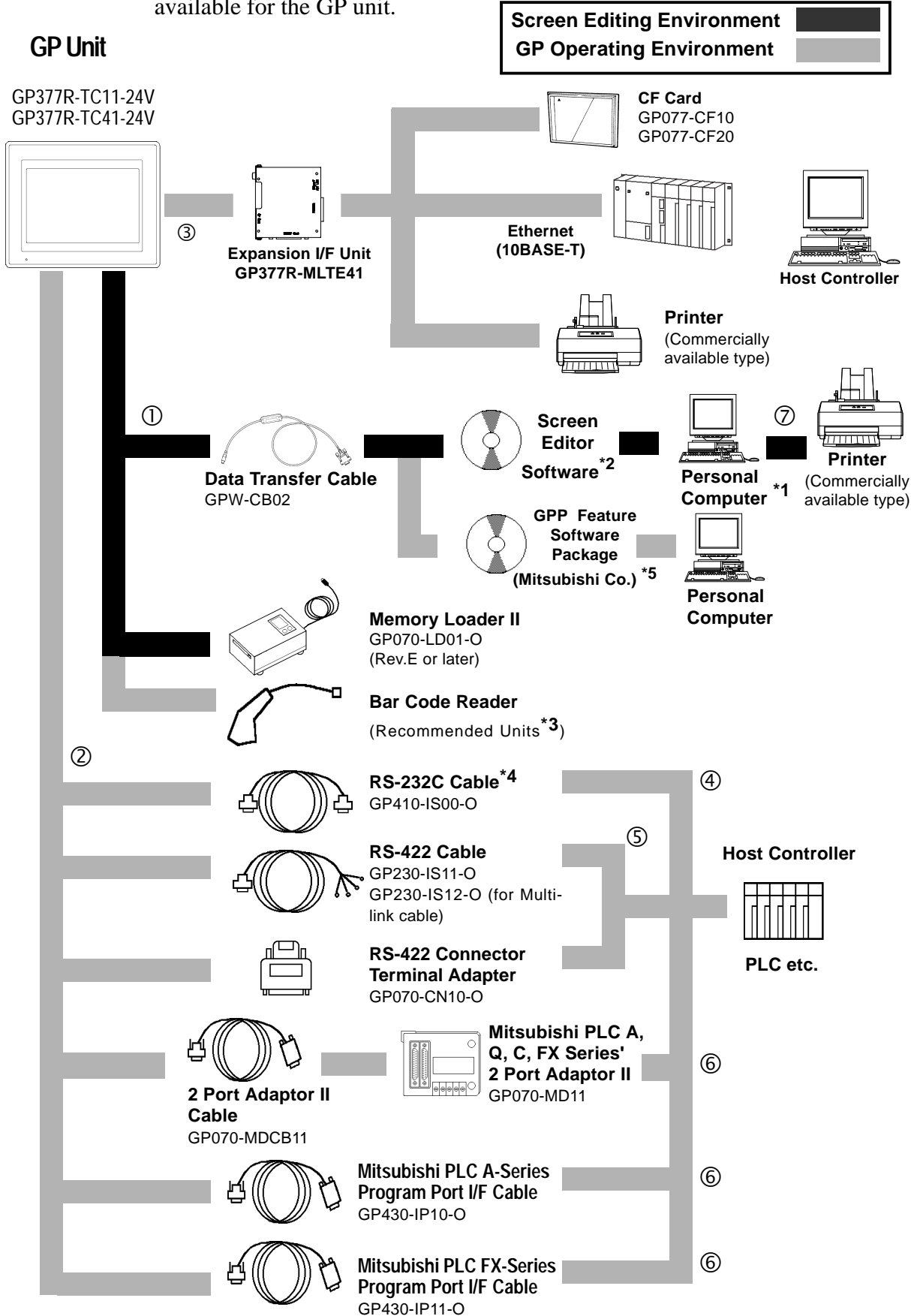

# Chapter 1 - Introduction

## GP Interfaces

- ① Tool Connector
- ② Serial Interface
- ③ Expansion I/F (GP rear face connector)

## PLC Interfaces

- ④ RS-232C Port
- ⑤ RS-422 Port
- ⑥ Programming Port

## Personal Computer Interface

- ⑦ Printer Interface

\*1 For range of compatible PCs, refer to the following manual.

**Reference** *GP-PRO/PBIII for Windows Operation Manual (included with the screen creation software)*

\*2 GP-PRO/PBIII for Windows Ver. 4.0 or later.

\*3 Recommended Bar Code Reader Units:

<b>Aimex Corporation</b>	<b>OPT Electronics</b>			<b>Tohken</b>	
BR-331 PC2 (Pen type)	Reading Width	Touch Scanner Type	Keyboard Connection Type	Reading Width	Touch Scanner Type
	60mm	OPT-1125-WL 98	OPT-1125-WD 98	65mm	TCD-5510M
	80mm	OPT-5125-WL 98	OPT-5125-WD 98	82mm	TCD-5510L
	100mm	LT-2125-WL 98	LT-2125-WD 98	105mm	TCD-5510W

\*4 Certain types and models of PLCs cannot be connected.

**Reference** *GP-PRO/PBIII for Windows PLC Connection Manual (included with the screen creation software)*

\*5 For corresponding PLCs and software,

**Reference** *GP-PRO/PBIII for Windows PLC Connection Manual (included with the screen creation software)*

## 1.3 Optional Items

All optional equipment listed below is produced by the Digital Electronics Co.

### ■ Screen Editor Software

Product Name	Model No.	Description
GP-PRO/PBIII for Windows Ver.4.0 or later	GPW-PB01M-V40 <CD-ROM>	Software to be used to create the GP's screen data using a personal computer.

### ■ Tool Connector

Product Name	Model No.	Description
Screen data transfer cable set	GPW-CB02	Connects the GP to a personal computer. Transfers screen data and user program(s).
Memory Loader II	GP070-LD01-O	Copies data (system and screen data) from the GP to GP. <b>Rev. E or later</b>

### ■ Serial Interfaces

Product Name	Model No.	Description
RS-232C cable *3	GP410-IS00-O	Interface cable between the host (PLC) and GP.
RS-422 cable *3	GP230-IS11-O GP230-IS12-O(for Multi-link)	
RS-422 cable Connector terminal block conversion adapter	GP070-CN10-O	Conversion adapter to convert serial data to RS-422 format.
2 Port Adapter II	GP070-MD-11	Interface unit that allows use of both GP and Mitsubishi A,Q, C and FX series equipment in the same location.
2 Port Adapter II Cable	GP070-MDCB11	Connects the GP to 2 Port Adapter II.
Mitsubishi A Series Programming Port I/F cable	GP430-IP10-O	Connects directly to Mitsubishi's PLC I/F Programming Console. Simultaneous use of program console, however, is not possible.
Mitsubishi FX Series Programming Port I/F cable	GP430-IP11-O	

\*1 For detailed information about range of connectable PLCs.

**Reference** *GP-PRO/PBIII for Windows PLC Connection Manual (included with the screen creation software)*





# Chapter 1 - Introduction

## ■ Expansion Unit Installation Slot Options



Product Name	Model No.	Description
Multi Unit E	GP377R-MLTE11	This Ethernet interface unit allows the GP to save data to a CF Card, or produce printer output.

## ■ Screen Protection Options

Product Name	Model No.	Description
<b>Screen Protection Sheet</b> 	Soft type: GP370-COVER-20P Hard type: GP370-DF10-0	Disposable protective and dirt-resistant sheet for the GP's screen. The GP's touch panel can be used with this cover sheet attached.
<b>Screen Protection Cover</b> 	GP370-DC11	A silicon gum cover which protects GP's screen from condensation and chemicals.

## ■ Maintenance Options

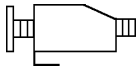
These optional items were included in either the GP itself or in its packing box. These items are sold separately as optional maintenance items.

Product Name	Model No.	Description
<b>Installation Fastener</b> 	GP070-AT00-MS	Fasteners to attach the GP to a panel.
<b>Moisture Resistant Gasket</b> 	GP370-WP10-MS	Provides a moisture resistant seal when installing the GP. Same as the seal included in the GP's original equipment package.

# 1.4 2-Port Feature Overview

You can now use Mitsubishi's GPP software (ladder programming software) on your PC while you connect the Mitsubishi PLC to the GP and the GP to your PC. You can send ladder logic data to and from the PLC, via the GP's Internal 2 port-feature. With the GP377 Series unit, you can use the 2-Port feature by simply connecting the GP and your PC via the data transfer cable (GPW-CB02) without using the external 2-Port Adapter.

For information about PLC types and GP compatibility with GP-377 Series units, refer to **Reference** *GP-PRO/PBIII for Windows PLC Connection Manual* (included with the GP screen creation software)

### ■ When Using GP-377 Series unit's Internal 2-Port feature \*1

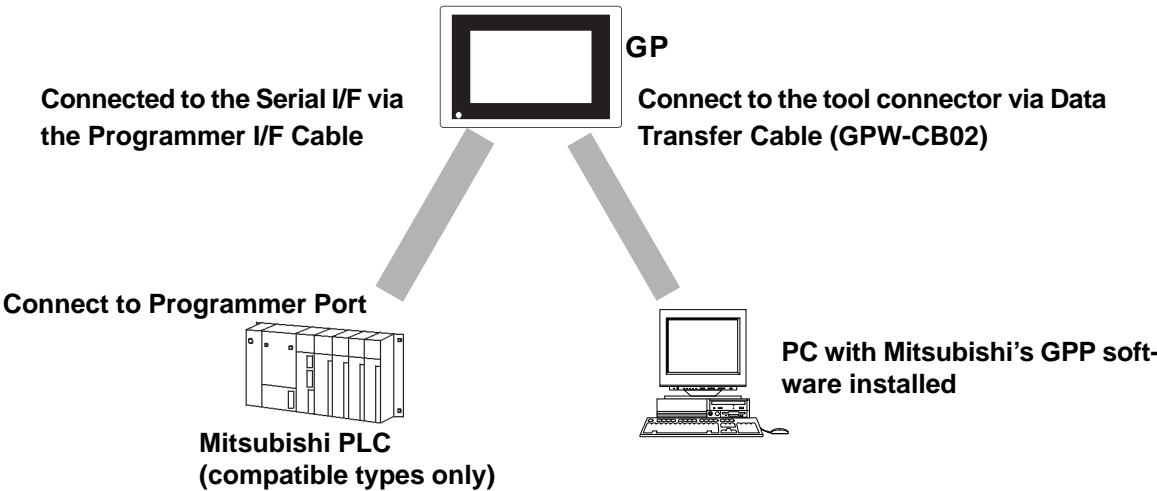

### ■ When Using the External 2-Port Adapter \*2

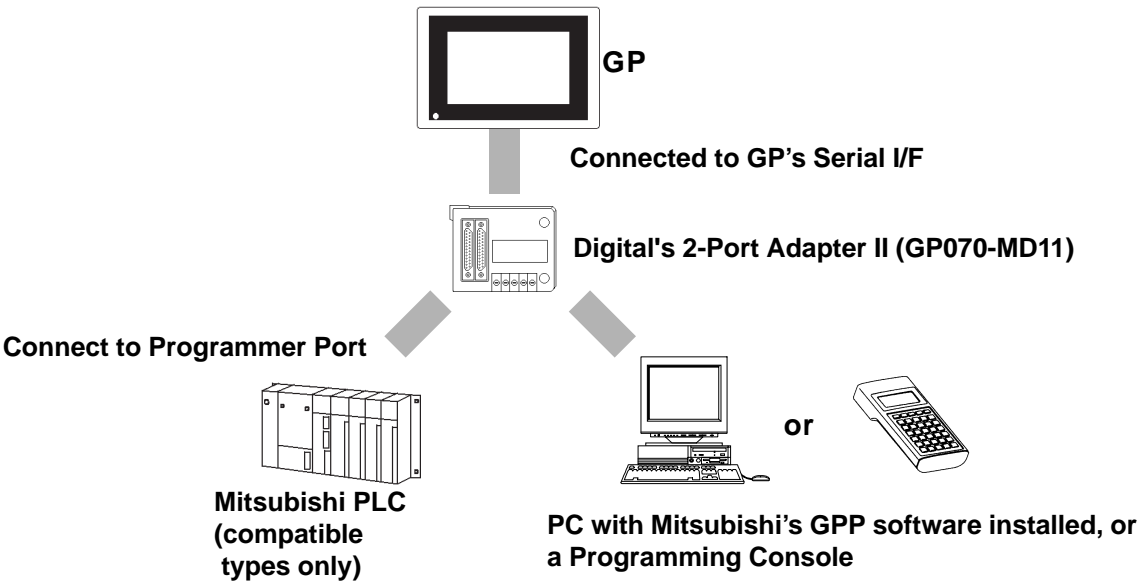

\*1 The Device Monitor feature can also be used at the same time. For details about the device monitor function, refer to **Reference** *GP-PRO/PBIII for Windows PLC Connection Manual* (included with the GP screen creation software)

\*2 GP-377 Series units can also use the 2-Port Adapter II.

### ■ Internal 2-Port Feature Usage Notes

- To use the Internal 2-Port feature, you will need to adjust your GP's settings. For information about these settings, refer to **▼Reference▲ GP-PRO/PBIII for Windows PLC Connection Manual** (included with the GP Screen creation software)
- This feature can be used only while the GP is in ONLINE mode.
- Since the internal 2-Port feature uses the GP's single tool connector, you will not be able to use equipment which requires the tool connector (i.e. a Barcode Reader, Optional Items, etc.)
- If you transfer screen data while the GP is in ONLINE mode, the screen will not change to the data transfer screen automatically. Thus, you will need to change the screen manually to the OFFLINE mode's [Main Menu/Transfer] screen. **▼Reference▲ 4.5 Transferring Screen Data**
- Peripheral equipment which cannot be connected to the GP's tool connector (such as a Programming Console) is not compatible with the GP's Internal 2-Port feature. To use this type of equipment, you will need to use the external 2-Port Adapter II.



# Chapter 2 Specifications

1. General Specifications
2. Performance Specifications
3. Interface Specifications
4. Names and Functions of GP Parts
5. Graphic Panel Dimensions

## 2.1 General Specifications

### 2.1.1 Electrical

Rated Power Supply	DC 24V $\pm$ 15%
Power Consumption	20W or less (Typ: 13W)
Allowable Pause Duration	2ms or less
Voltage Endurance	AC1000V - 10mA 1minute (between charging and FG terminals)
Insulation Resistance	DC500V - greater than 10M $\Omega$ (between charging and FG terminals)

### 2.1.2 Structural

External Dimensions (mm)	170.5mm (W) x 138mm (H) x 57mm (D) (Main unit only)
Weight	950g or less (Main unit only)
Cooling Method	Natural air circulation

### 2.1.3 Environmental Specifications

<b>Ambient Operating Temperature</b>	0 °C to 40 °C
<b>Ambient Storage Temperature</b>	-10°C to 60 °C
<b>Operating Humidity</b>	20%RH to 85%RH (non-condensation)
<b>Vibration Endurance</b>	10Hz to 25Hz applied in X, Y, and Z directions for 30 minutes each - 19.6m/s <sup>2</sup>
<b>Noise Immunity (via noise simulator)</b>	Noise voltage: 1000 Vp-p Pulse length: 1µs Arise time: 1 ns
<b>Electrostatic Discharge immunity</b>	TC11: 4kv (meets IEC 61000-4-2) TC41: 6kv (meets EN 61000-4-2)
<b>Operating Atmosphere</b>	Must be free of corrosive gasses
<b>Grounding</b> *1	100Ω or less grounding resistance
<b>Dust</b>	Under 0.1mg/m <sup>3</sup> (Non-conductive levels)
<b>Rating</b> *2 (When the unit is built into front face of flat panel)	Equivalent to JEM1030 IP65f and NEMA #250 TYPE4X12

\*1 Use your country's applicable standard.

\*2 The front face of the GP unit, installed in a solid panel, has been tested using conditions equivalent to the standards shown in the specification. Even though the GP unit's level of resistance is equivalent to these standards, oils that should have no effect on the GP can possibly harm the unit. This can occur in areas where either vaporized oils are present, or where low viscosity cutting oils are allowed to adhere to the unit for long periods of time. If the GP's front face protection sheet becomes peeled off, these conditions can lead to the ingress of oil into the GP and separate protection measures are suggested. Also, if non-approved oils are present, it may cause deformation or corrosion of the front panel's plastic cover. Therefore, prior to installing the GP be sure to confirm the type of conditions that will be present in the GP's operating environment.

If the installation gasket is used for a long period of time, or if the unit and its gasket are removed from the panel, the original level of the protection cannot be guaranteed. To maintain the original protection level, you need to replace the installation gasket regularly.

## 2.2 Features and Performance

### 2.2.1 Display Features

<b>Display Medium</b>	TFT type color LCD
<b>Display Color</b>	64 colors (RGB-4 levels)
<b>Backlight</b>	CCFL (lifespan = more than 50,000 hours, when continuously lit)
<b>Resolution</b>	320 x 240pixels
<b>Display Area</b>	115.2mm (W) x 86.4mm (H)
<b>Brightness</b>	4 levels (via touch panel)
<b>Character Sets</b>	ANK : 158 types, Kanji : 6962 types (including 607 non-kanji characters) Korean, Chinese, Taiwanese, ASCII fonts are available
<b>No. of characters displayed</b>	With 8 x 8 dot font: 40 Char. per row, 30 rows
	With 8 x 16 dot font: 40 Char. per row, 15 rows
	With 16 x 16 dot font: 20 Char. per row, 15 rows
	With 32 x 32 dot font: 10 Char. per row, 7 rows
<b>Character Size <sup>*1</sup></b>	Both height and width can be expanded 1, 2, 4, or 8 times. Single byte characters larger than 2 times size (32 x 32) can be displayed in a high quality font.

*\*1 The font quality available will depend on the language and size selected.*

**Reference** 5.9 Font Settings

### 2.2.2 Screen Memory

<b>Application</b>	FLASH EPROM 2M bytes (approx. 640 screens assuming 3.2K bytes/screen)
<b>Data Backup</b>	SRAM 96K bytes Backup Memory uses lithium batteries. *1

*\*1 Lithium batteries' lifespan is:*

*10 years when the battery's ambient temperature is under 40 °C*

*4.1years when the battery's ambient temperature is under 50 °C*

*1.5 years when the battery's ambient temperature is under 60 °C*

*When used for backup:*

*Approximately 60 days, with a fully charged battery*

*Approximately 6 days, with a half-charged battery*

### 2.2.3 Touch Panel / Clock Accuracy

<b>Touch Panel</b>	16 x 12 keys/ screen (1 or 2 point touch)
<b>Clock Accuracy</b>	± 65 seconds/ month (at room temperature)



The GP's internal clock has a slight error. At normal operating temperatures and conditions, with the GP operating from its lithium battery, the degree of error is 65 seconds per month. Variations in operating conditions and battery life can cause this error to vary from +90 to -380 seconds per month. For systems where this degree of error will be a problem, the user should be sure to monitor this error and make adjustments when required.

### 2.2.4 External Interfaces

<b>Serial Interface</b>	Asynchronous Transmission Method: RS232C/RS422 Data Length: 7 or 8 bits Stop Bit: 1 or 2 bits Parity: None, Odd or Even Data Transmission Speed: 2400 to 115.2kbps
<b>Tool Connector</b>	Synchronous TTL level nonprocedure command I/F <During screen file development> Used for transferring data to and from the GP application software and the GP. Used for data transfer with the 2-Port feature. <During Operation> Used as a bar code reader's interface



## 2.3 Interface Specifications

### 2.3.1 Serial Interface

Pin Connection	Pin #	Signal Name	Condition
	1	FG	Frame ground
	2	SD	Send data (RS-232C)
	3	RD	Receive data (RS-232C)
	4	RS	Request send (RS-232C)
	5	CS	Clear send (RS-232C)
	6	NC	No connection
	7	SG	Signal ground
	8	CD	Carrier detect (RS-232C)
	9	TRMX	Termination (RS-422)
	10	RDA	Receive data A (RS-422)
	11	SDA	Send data A (RS-422)
	12	RESERVE	Reserved
	13	RESERVE	Reserved
	14	VCC	5V±5% output 0.25A
	15	SDB	Send data B (RS-422)
	16	RDB	Receive data B (RS-422)
	17	NC	No connection
	18	CSB	Clear send B (RS-422)
	19	ERB	Enable receive B (RS-422)
	20	ER	Enable receive (RS-232C)
	21	CSA	Clear send A (RS-422)
	22	ERA	Enable receive A (RS-422)
	23	BUZZ GND	External buzzer ground
	24	NC	No connection
	25	BUZZ OUT	External buzzer output

*Recommended Connector:* Dsub25pin plug XM2A-2501 <made by OMRON >

*Recommended Cover :* Dsub25pin cover XM2S-2511 <made by OMRON >

*Jack Screws:* XM2Z-0071 <made by OMRON>



**Note:** • Use rough metric type M2.6x0.45 p threads used to secure the cable's set screws.

*Recommended Cable:* CO-MA-VV-SB5P x28AWG <made by HITACHI Cable Ltd.>

- To confirm your GPC's connection specifications  
Reference *GPC Connection Manual (included with the screen creation software)*

## Chapter 2 - Specifications



*When creating your own cable, follow the instructions listed below:*

**For RS-422** (The following pairs of pin #'s must be connected to each other)

..... #18 (CSB) <—> #19 (ERB)

..... #21 (CSA) <—> #22 (ERA)

- When connecting the RS-422 cable and the #9 (TRMX) and #10 (RDA) points, a termination resistance of 100Ω is added between RDA and RDB.
- When making a cable for the Memory Link format, be sure to use a 4-line System.

**For RS-232C**

- Do not use the following pins: 9 (TRMX), 10 (RDA), 11 (SDA), 15 (SDB), 16 (RDB), 18 (CSB), 19 (ERB), 21 (CSA), 22 (ERA).

### <Buzzer Output>

#23 (BUZZ GND) and #25 (BUZZ OUT) are used for Buzzer Output.

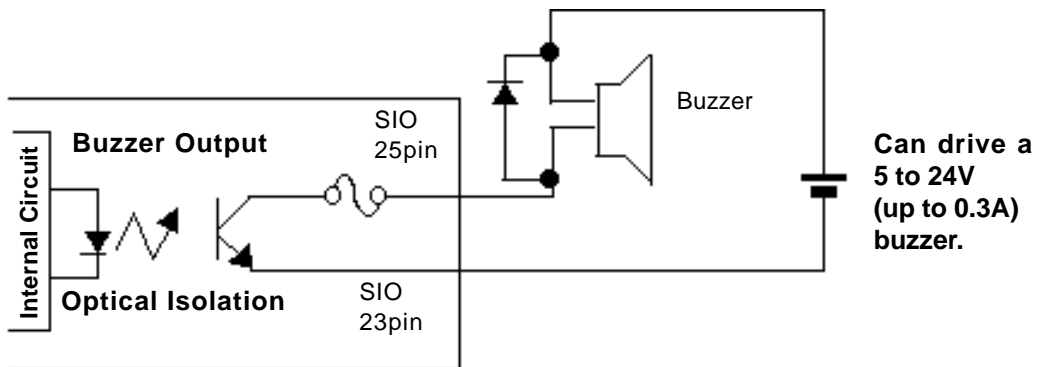

GP-377R unit (inside)



**Be sure to connect this unit's SG/GND (#7) terminal to the other unit's SG terminal. If necessary, you may also need to connect the FG terminal to the other unit's FG terminal depending on the type of the other unit you use.**



**This unit's RS485(RS422) port is not isolated, therefore, it is important that you connect the SG/GND (Signal Ground) terminals. If this is not done, the RS485(RS422) circuit may be damaged.**



*The DC5V output of #14 pin (VCC) is not protected. Be sure to use only the rated current.*

**2.4 Names and Functions of GP Parts**

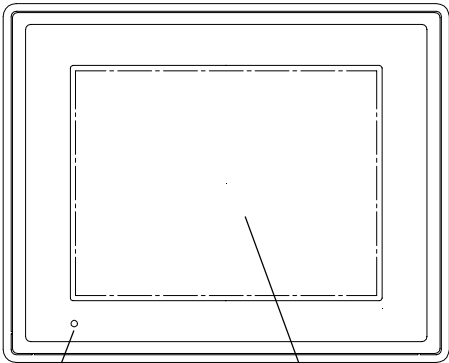

C A,B

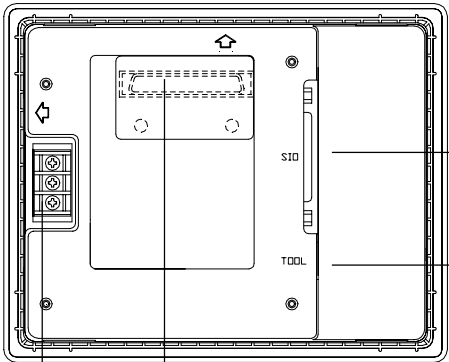

D E

F G

**A: Display Panel**

The GP monitor screen displays the screen setup and corresponding Host (PLC) data.

GP377RT TFT type Color LCD

**B: Touch Panel**

Performs any screen change operations and sends data to the Host (PLC).

**C: Status LED**

Lights according to operation status.

LED	GP Status
OFF	Power OFF
Green	Normal operation
Orange	Backlight failure

**D: Power Input Terminal Block**

The input and ground terminals for the power cable.

**E: Expansion Interface**

Used for expansion boards.

**F: Serial Interface**

Used for the RS-232C and RS-422 (Serial) cables. Is connected to the Host (PLC).

**G: Tool Connector**

The Data Transfer cable, Bar Code Reader or Memory Loader can be connected here.

# 2.5 Graphic Panel Dimensions

## 2.5.1 GP-377R Series - External Dimensions



**Note:** For detailed dimension information, please contact your local GP distributor.

Unit: mm

**Top View**

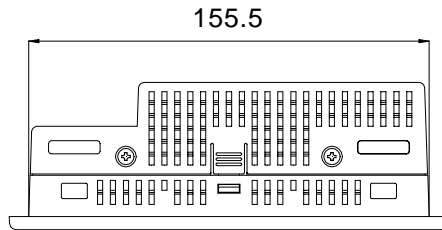

**Front View**

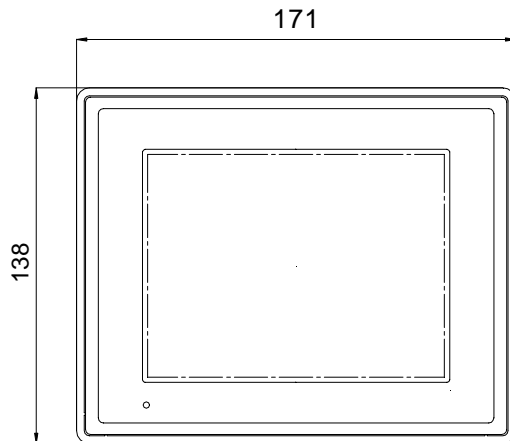

**Side View**

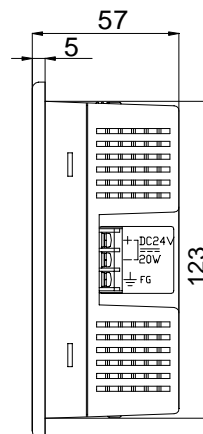

**Rear View**

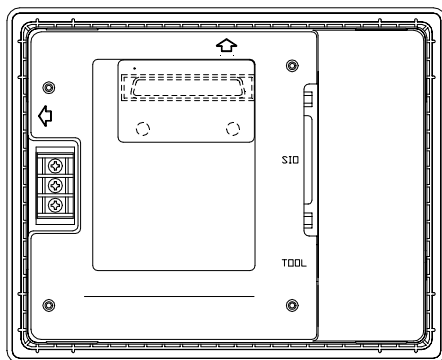

**2.5.2 Installation Fasteners**

Unit: mm

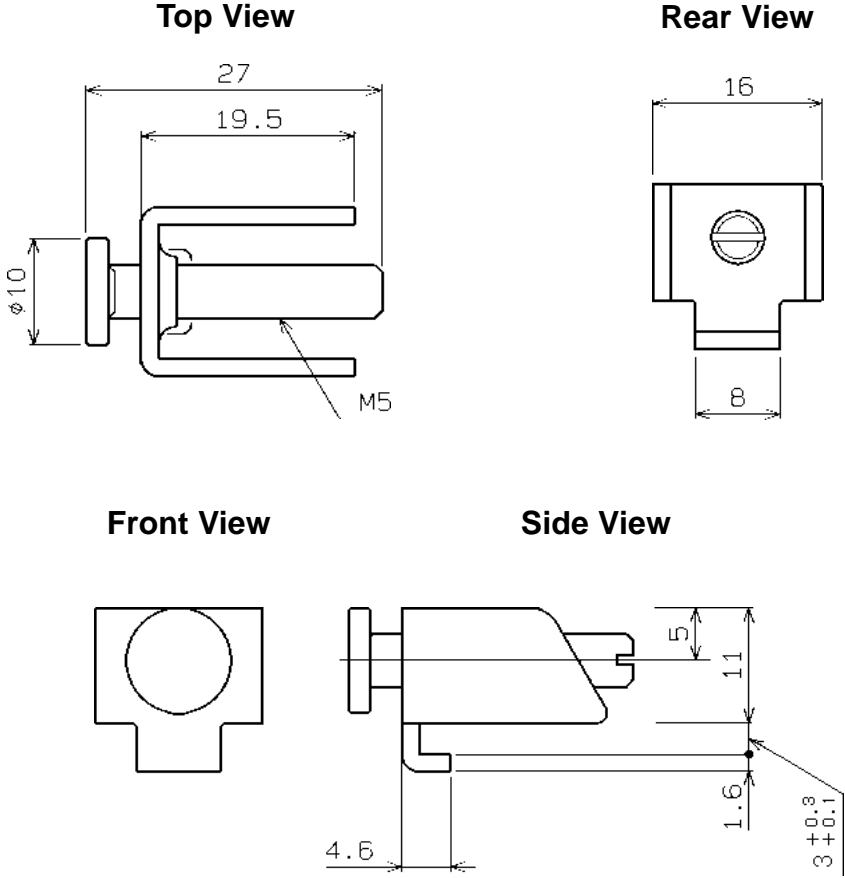

**2.5.3 GP Panel Cut Out Dimensions**

Unit: mm

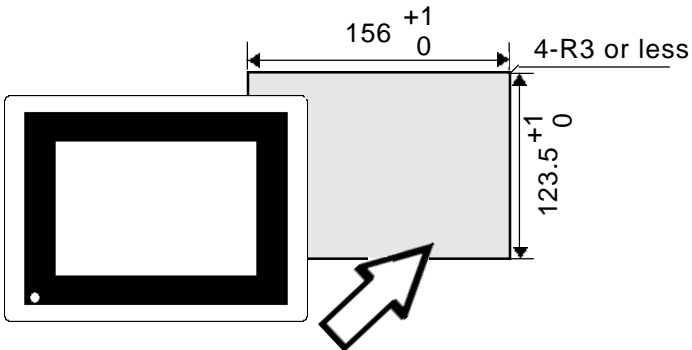

# *MEMO*

# Chapter 3 Installation and Wiring

1. Installation
2. Wiring Cautions
3. GP Tool Connector

## 3.1 Installation

### 3.1.1 Installation Procedures

When installing the GP panel, be sure to follow the steps listed below.



**Before installing the GP into a cabinet or panel, check that the moisture resistant gasket is securely attached to the unit.**

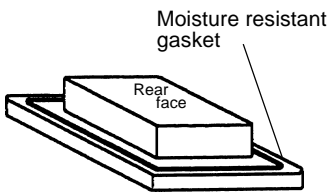

It is strongly recommended that you use the gasket since it absorbs vibration in addition to repelling water.

Place the GP on a level surface with the display panel facing downward. Check that the GP's moisture resistant gasket is seated securely into the gasket's groove, which runs around the perimeter of the panel's frame. For details about installing the gasket, refer to

**Reference** 7.1.2 *Moisture Resistant Gasket Replacement*

#### ■ Creating a Panel Cut Out

Create the correct sized opening required to install the GP, using the installation dimensions given.

**Reference** 2.5.3 *“GP Panel Cut Out Dimensions”*

The moisture resistant gasket, installation brackets and attachment screws are all required when installing the GP.

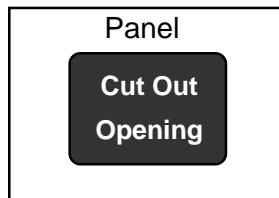

- It is important that the panel or cabinet's surface is flat, in good condition and has no jagged edges.
- Panel thickness should be from 1.6mm to 5.0mm.

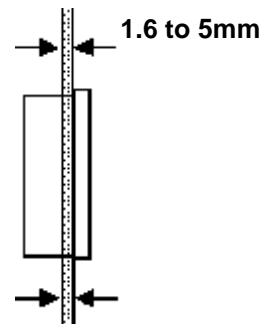

## Chapter 3 - Installation and Wiring



- For easier maintenance and operation, plus better ventilation, mount the GP unit at least 100 mm away from adjacent structures and other equipment.

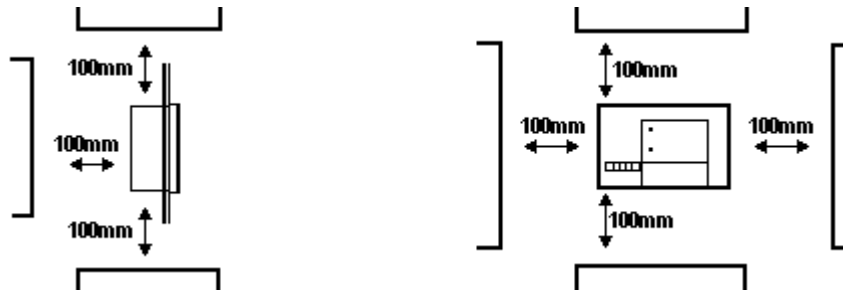

- Be sure that the ambient operation temperature is 0 °C to 40 °C, and the ambient humidity is 20%RH to 85%RH.
- Be sure that heat from surrounding equipment does not cause the GP to exceed its standard operating temperature.
- When installing the GP unit in a slanted panel, the panel face should not incline more than 30°.

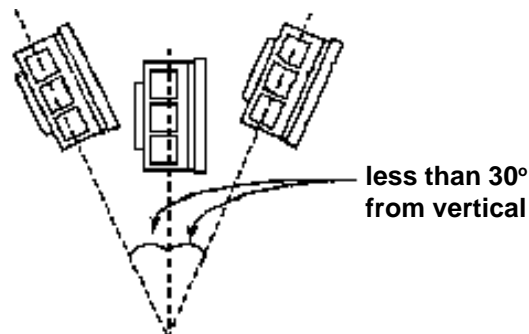

- When installing the GP unit in a slanted panel, and the panel face inclines more than 30°, the ambient temperature must not exceed 40 °C. You may need to use forced air cooling (fan, A/C) to ensure the ambient operating temperature is 40 °C or below.
- When installing the GP vertically, orient the unit so that the Power Terminal Block is vertical, not horizontal.



## ■ Installation Direction

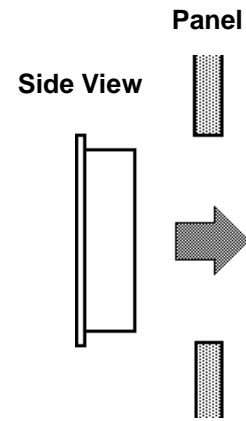
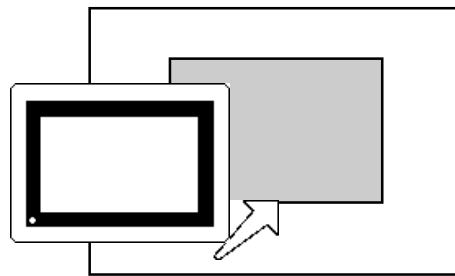

## ■ Securing the Installation Fasteners

- ① There are four (4) insertion slots on the top and bottom of the GP, where the metal installation fasteners hook on.

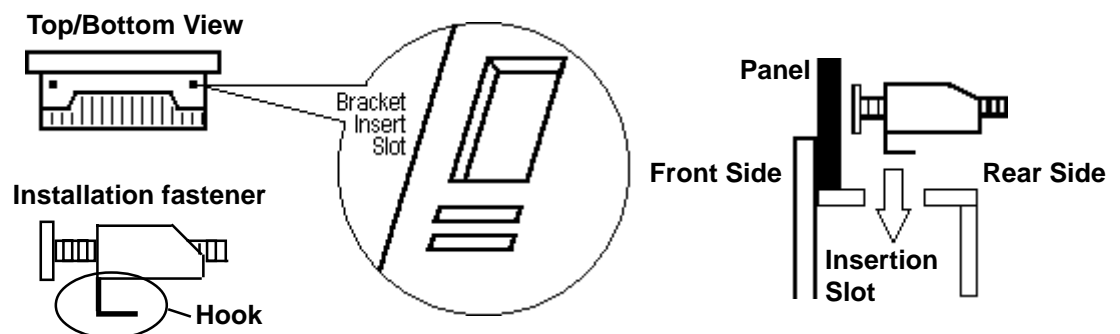

- ② Insert each of the fasteners into its slot as shown below. Be sure to pull the fastener back until it is flush with the rear of the attachment hole.

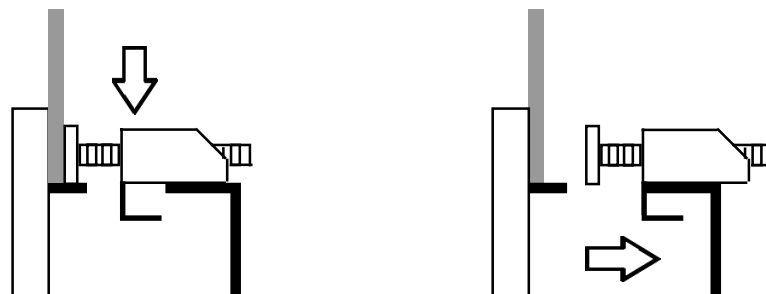

- ③ Use a screw driver to tighten the attachment screws and secure the GP unit in place.

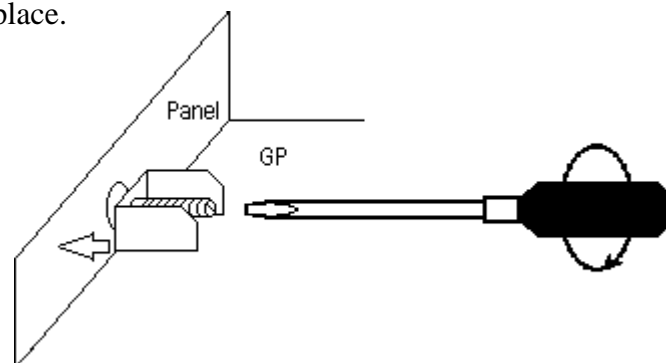

- A torque of only 0.5 to 0.6 N•m is required to tighten an attachment screw. Be careful not to use too much force, since it may damage the GP unit.

## 3.2 Wiring Cautions

### 3.2.1 Connecting the GP's Power Cord



## Warning

- To avoid electric shocks, be sure the Power Cord is unplugged from the power outlet when connecting the power terminals to the GP unit.
- GP-377R Series units accept DC 24V power input only. Using an incorrect power supply will result in damage to both the power supply and the GP.
- Re-attach the GP Terminal Strip's clear plastic cover after completing wiring. If the Cover is not installed, it may cause an electric shock.



• *When the FG terminal is connected, be sure the wire is grounded. Not grounding the GP unit will result in excessive noise.*



• Wherever possible, use thick wires (max 2mm<sup>2</sup>) for power terminals, and twist the exposed wire ends when connecting the Ring Terminals.

• Please use the following size Ring Terminals.

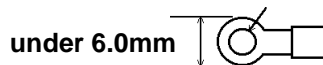

• To prevent the Ring Terminals from causing a short when the terminal block attachment screws are loosened, be sure to use sleeve-type Ring Terminals.

- ◆ Connect the GP Power Supply Terminals as follows:
  - 1) Be sure that the GP's Power Cord is not plugged in to the power supply.
  - 2) Remove the GP Terminal Strip's clear plastic cover.
  - 3) Remove the screws from the 3 middle terminals, position the Ring Terminals as shown above and re-attach the screws. (Check each wire to make sure the connections are correct)
  - 4) Re-attach the GP Terminal Strip's clear plastic cover.



• A torque of only 0.5 to 0.6 N•m is required to tighten an attachment screw.

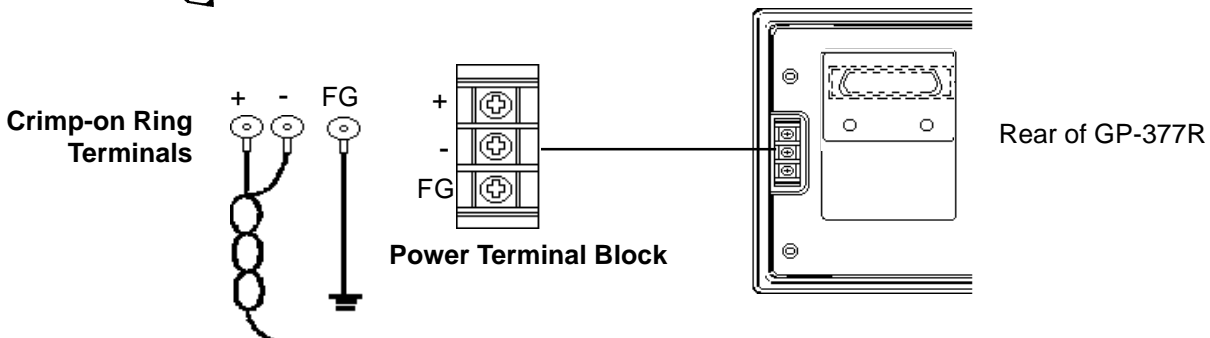

### 3.2.2 Grounding the GP



## Caution

Do not use common grounding, since it may lead to an accident or machine malfunction.

(a) Exclusive grounding (BEST) \*1

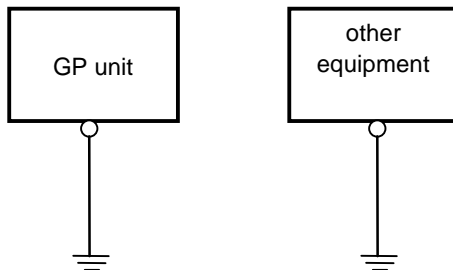

(b) Common grounding (OK) \*1

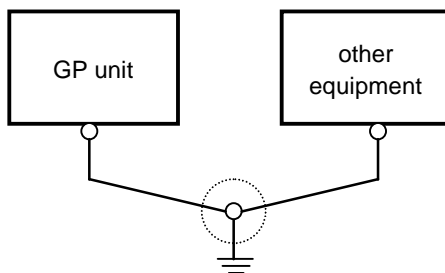

(c) Common grounding (Not OK)

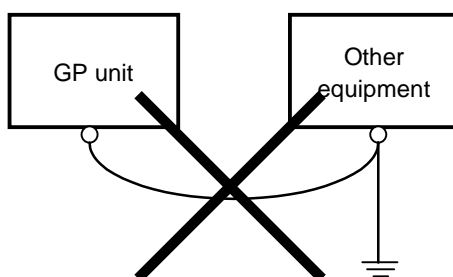

- Connect the FG terminal found at the back of the unit to an exclusive ground. [diagram (a)].



- **Check that the grounding resistance is less than 100Ω.**
- **FG and SG terminals are internally connected in the GP.**
- **The grounding wire should have a cross sectional area greater than 2mm<sup>2</sup>. Set the connection point as close to the GP unit, and make the wire as short, as possible. When using a long grounding wire, replace the thin wire with a thicker wire placed in a duct.**
- If exclusive grounding is not possible, use a common connection point. [diagram (b)]
- **Note:** If the equipment does not function properly when grounded, disconnect the ground wire from the FG terminal.

### 3.2.3 Placement of I/O Signal Lines

- Input and output signal lines must be separated from the power control cables for operating circuits.
- If this is not possible, use a shielded cable and connect the shield to the GP's frame.

\*1 Use a grounding resistance of less than 100Ω and a 2mm<sup>2</sup> or greater thickness wire, or your country's applicable standard. For details, contact your local GP distributor.

### 3.3 GP Tool Connector

The GP's Data Transfer Cable, Memory Loader, or the Bar Code Reader can be attached to the GP's side face Tool Connector.

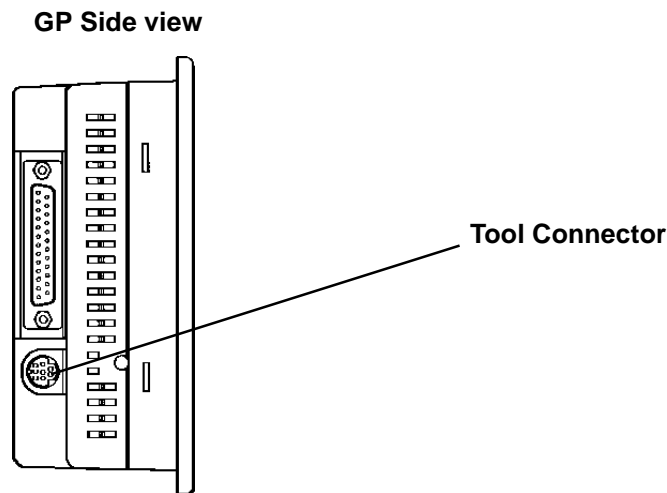

- **Before unplugging any connector(s) from the GP, be sure the GP's power cord is unplugged from the main power supply.**
- **Do not connect or disconnect any equipment to or from the GP's Tool Connector while the GP's Power cord is connected.**
- **When the Bar Code Reader uses a separate power supply:**
  - **Turn the Bar Code Reader ON before turning the GP ON.**
  - **Turn the GP OFF before turning the Bar Code Reader OFF.**

# Chapter 4 OFFLINE Mode

- 1. Entering OFFLINE Mode
- 2. OFFLINE Mode's Main Menu
- 3. INITIALIZE—Standard Operation
- 4. SELF-DIAGNOSIS—Standard Operation
- 5. Transferring Screen Data

OFFLINE Mode provides access to the Initialize, Self-Diagnosis, and other features built into the GP. You will need to change the GP to OFFLINE mode before you can use any of these features.



**OFFLINE mode is unavailable in a completely new GP until the necessary Screen Data has been transferred from the screen editor software. Be sure the GP's power cord is plugged in and no images are displayed on the GP screen. When data is transferred from your PC to the GP, the necessary System Data will be sent.**

**Reference** For information about transferring data to the GP, refer to *GP-PRO/PBIII for Windows Operation Manual (included with the screen creation software)*

## 4.1 Entering OFFLINE Mode

To INITIALIZE the setup or run SELF-DIAGNOSIS in the GP unit, transferring to the OFFLINE mode becomes necessary. There are two ways to enter OFFLINE mode. First, immediately after plugging in the GP's power cord, and second, by using the Force Reset feature.

### 4.1.1 When Turning the GP's Power ON

Touch the upper left-hand corner of the GP screen within 10 seconds of plugging in the GP's power cord.

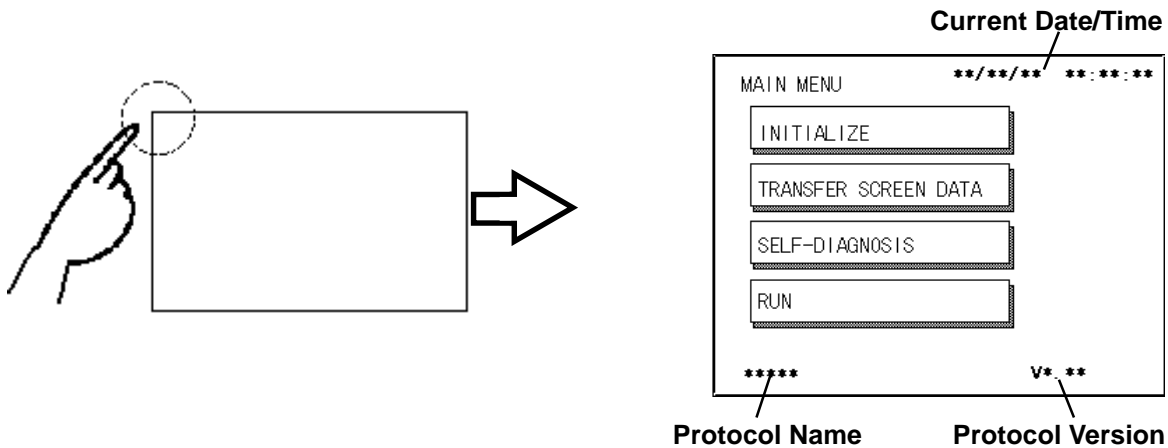

**4.1.2 From Forced Reset**

From the Forced Reset screen, touch the OFFLINE button and the Main Menu will appear.

*For instructions on how to enter the Forced Reset Screen*

**Reference** 5.4.3 "Set Up Touch Panel; FORCE RESET"

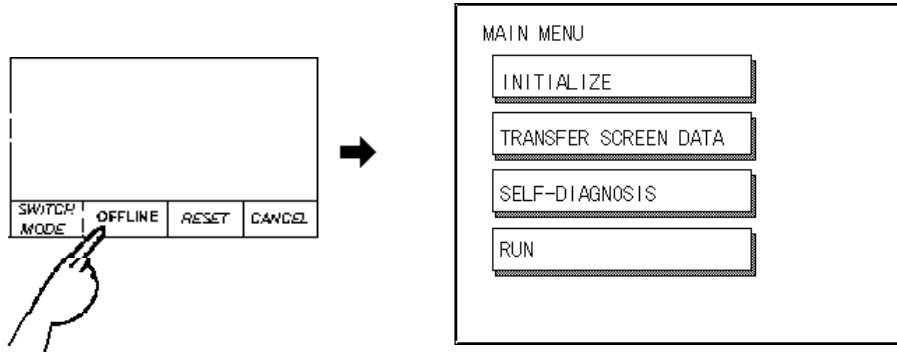

**Note:** When the GP unit has the Device Monitor function, the following display will appear.

**Reference** GP-PRO/PBIII for Windows PLC Connection Manual (included with the screen creation software), Appendix 3 - Device Monitor

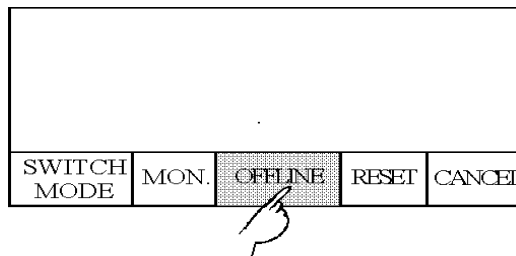

If a Password has been set in INITIALIZE/ SET UP SYSTEM, before entering the OFFLINE mode, the following screen appears. Enter the password, then touch *Set* to enter OFFLINE mode.

**Reference** For more information about Passwords, Chapter 5.3.1, "SYSTEM SETUP" and Chapter 4.3, "Initialize-Standard Operation"

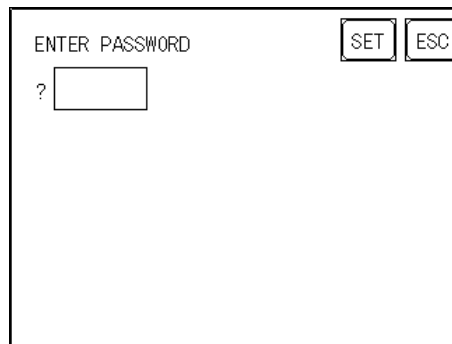

## 4.2 OFFLINE Mode's Main Menu

Each menu item shown below has different settings that must be set to match the corresponding PLC in order for the GP to communicate properly. Entering OFFLINE mode calls up the following screen.

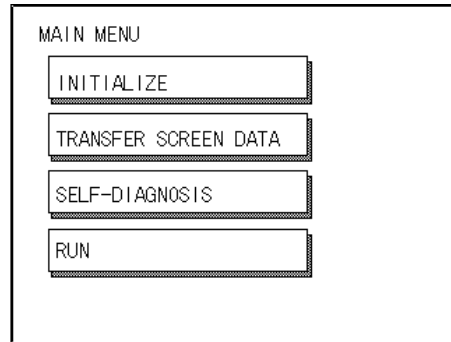

Select the desired menu item by touching the corresponding item bar on the screen selection.

Each Main Menu item is used as follows.

### INITIALIZE

The setup items listed in this menu are necessary to run the GP unit.

### TRANSFER SCREEN DATA

Select to transfer screen data to and from the screen editing software.

### SELF-DIAGNOSIS

Checks to see if there are any problems with the GP System or Interface (I/F).

### RUN

Starts GP operation.

**▼Reference▲** For more information about *INITIALIZE*, refer to Chapter 5, "Initialize"; for more information about *TRANSFER SCREEN DATA*, refer to *GP-PRO/PBIII for Windows Operation Manual* (included with the screen creation software); for more information about *SELF-DIAGNOSIS* and *RUN*, refer to Chapter 6, "GP Run Mode and Errors".

## 4.3 INITIALIZE—Standard Operation

### ■ Selecting A Menu

Touch the menu item, or input field to select it.

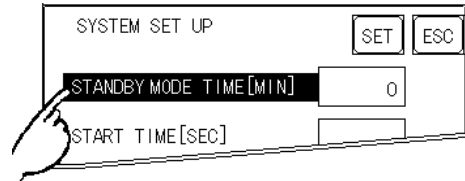
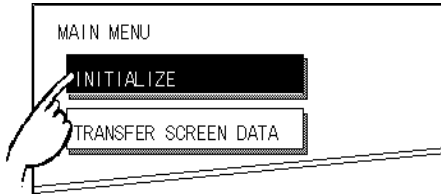

### ■ Entering Numbers

After selecting an input field by touching it, use the numeric touch keys located at the bottom of the screen to enter numeric values. After inputting each value, touch the [SET] key to define the value.

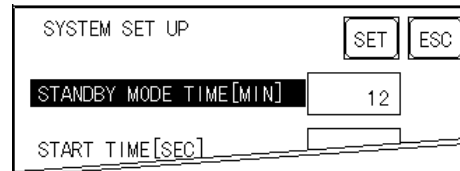
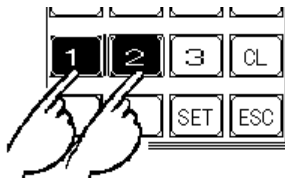

### ■ Selecting Setup Conditions

After selecting a menu item and entering that area, touch the option you would like to setup. The selected item becomes highlighted. In this example, the TOUCH BUZZER SOUND has been set Off.

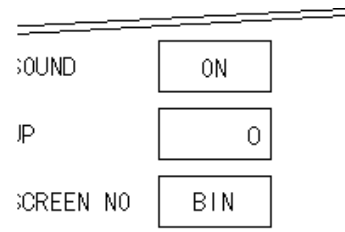
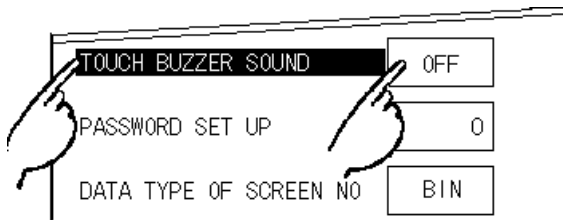



### ■ After All Setting Data is Entered

Touch the top-right [SET] button.

If you wish to exit the screen without saving the changes, touch the CANCEL button.

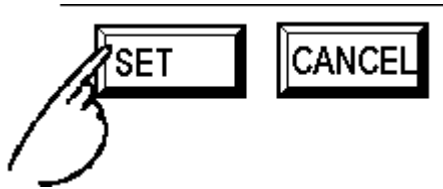

- Press the [SET] key to write the Setup conditions onto the Internal FEPR0M, which may take some time, causing a delay in returning to the previous screen. Therefore, do not touch the screen until the previous menu display returns.
- Press the [SET] key to *write* the Setup conditions onto the Internal FEPR0M, and Press the [CANCEL] key to *not write* the Setup conditions onto the Internal FEPR0M and return to the previous menu.

### ■ Return To Previous Screen

Touch the title of the screen you would like to return to.

E.g. To return to the MAIN MENU from the SYS.ENVIRONMENT screen, simply touch the MAIN MENU title.

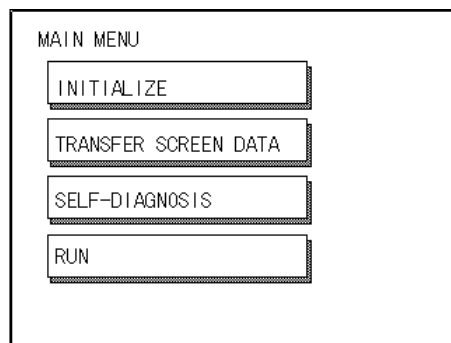
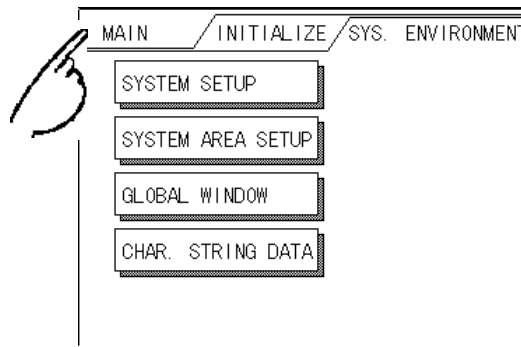

## 4.4 SELF-DIAGNOSIS—Standard Operation

### ■ Selecting a Sub-Display

Touch the desired the menu item and that sub-display will appear.

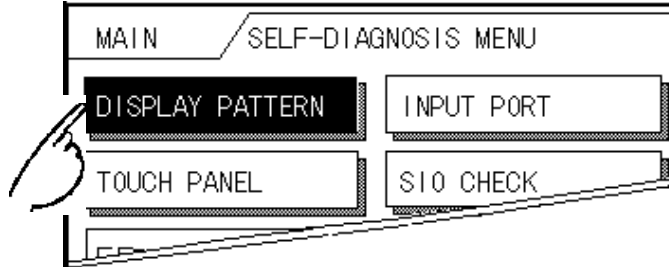

### ■ [SET], [CANCEL] Keys

After selecting the Self Diagnosis item, the [SET], and [CANCEL] keys may appear at different times at the top of the screen.

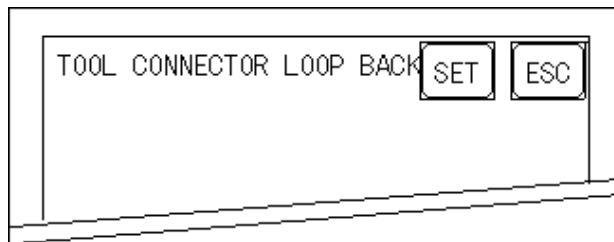

### ◆ [SET] Key

When this key is pressed, your selected Self-Diagnosis test begins.

### ◆ [CANCEL] Key

When this key is pressed, the selected Self-Diagnosis test is cancelled, and you are returned to the SELF-DIAGNOSIS menu.

■ **After Check—To Return To SELF-DIAGNOSIS MENU**

When OK displays,

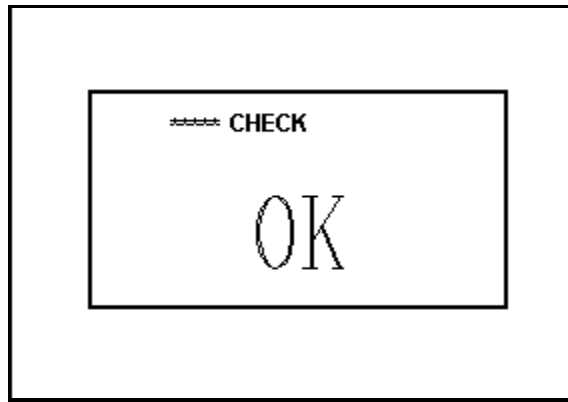

Pressing once anywhere on the display screen returns you to the SELF-DIAGNOSIS MENU.

When an Error Message displays

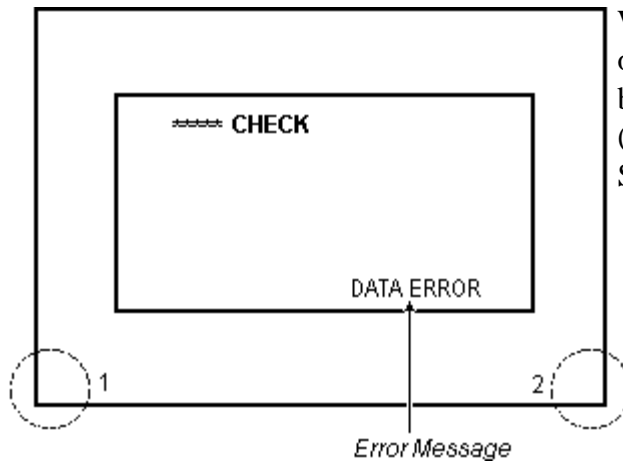

When an error message appears on the display screen, touch the bottom two corners of the panel (1, 2) to return to the SELF-DIAGNOSIS MENU.

■ **Return To Main Menu**

Touch the MAIN Key in the top right corner of the SELF-DIAGNOSIS menu to return to the MAIN MENU.

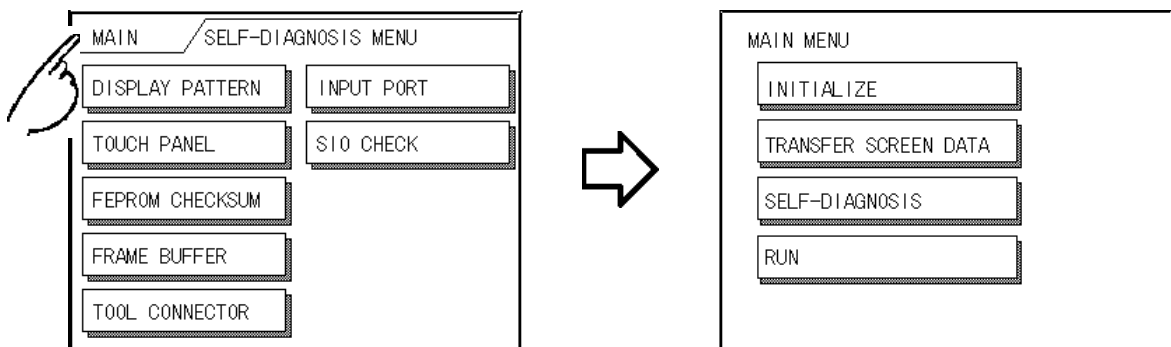

## 4.5 Transferring Screen Data

This section describes the process required to transfer screen data to the GP, and to receive data from the GP.

Connect the Data Transfer cable to the GP's tool connector, located on the side face of the GP, and to the PC's serial port.

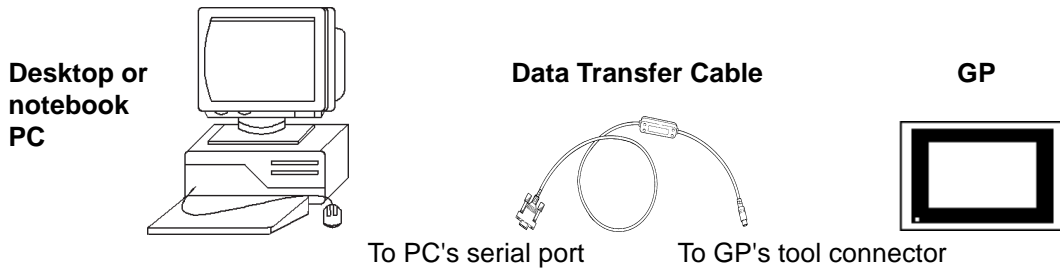

GP-377R unit (Side view)

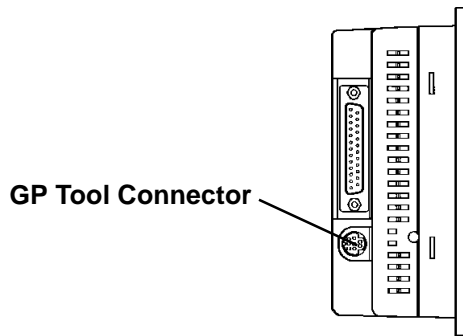

- **When sending the Project file to the GP, the separately sold GP transfer cable (GPW-CB02 \*1 ) is needed. Please note that I/F conversion adaptor is not included for the PC. Digitan asks that the customer prepares this item, which can be found in most computer supply stores.**



- **When using a serial mouse, besure to use a different serial port for the data transfer cable.**

---

\*1 GPW-CB-SET cable can also be used.

Also, please remember that OFFLINE mode is unavailable in a completely new GP until the necessary Screen Data has been transferred from the screen editor software.

Therefore, be sure the GP's power cord is plugged in and no images are displayed on the GP screen. While screen data is being sent from your PC to the GP, the necessary System Data will be sent together with it.

**▼Reference▼** *GP-PRO/PBIII for Windows Operation Manual (included with the screen creation software)*

■ **To send screen data to a GP that is currently in OFFLINE mode:**

**1) From the OFFLINE mode's MAIN MENU, touch the TRANSFER SCREEN DATA item on the screen to enter the TRANSFER SCREEN DATA mode. This will allow the GP to receive data.**

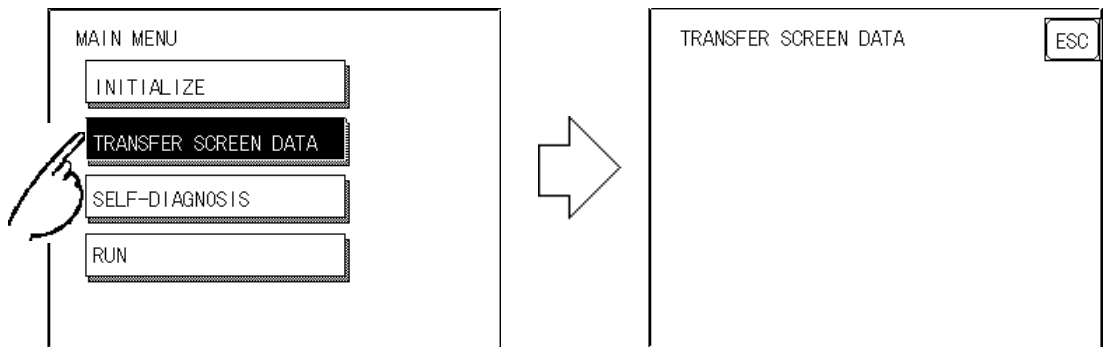

**2) While data is being transferred, the messages “SETUP Transfer” and “TRANSFERRING/PLEASE WAIT “ will display. When data transfer is completed, these messages will be cleared. If desired, use the GP’s Editor Software to stop the transfer.**

**If the Setup<sup>\*1</sup> is performed, the screen will return to the OFFLINE mode's MAIN MENU when data transfer is completed, if the Setup is not performed, the GP will go ONLINE mode and the screen designated in the “INITIALIZE / INITIALIZE SCREEN“ setting will display.**



**When you transfer the information contained in the GP-PRO/PBIII for Windows 's GP System settings to the GP, all OFFLINE MODE [ INITIALIZE ] setting data in the unit will be lost.**

---

**\*1** Setup means to download the GP's system program and a PLC protocol driver from the screen editor software, in order to run the GP in a desired environment.

*MEMO*

# Chapter 5 Initializing the GP

1. Initialization Screen
2. Initialization Items
3. SYSTEM ENVIRONMENT SETUP
4. SET UP I/O
5. PLC SETUP
6. INITIALIZE INTERNAL MEMORY
7. SET UP TIME
8. SET UP SCREEN
9. FONT SETTING

## 5.1 Initialization Screen

Occasionally, you may want to change one or more of the GP unit's general operation settings. These settings are listed under the INITIALIZE option in the GP's MAIN MENU.

This chapter explains each of the OFFLINE mode's INITIALIZE items. However, there are 2 types of INITIALIZE settings, those for the **1:1** connection and those for the **n:1** (multi-link) connection\*<sup>1</sup>.

The **n:1** mark appears on original menu items concerned only with the n:1 multi-link connection. If there is no mark, the menu item is common to both 1:1 and n:1 connections.

**1:1** Processing where a single (1) GP is connected with a single (1) PLC.

**n:1** Processing where multiple GP's are connected with a single PLC. The GPs successively pass a *PLC Access Token* (exclusive PLC interaction key) among themselves to designate which will communicate with the PLC.



**Note:**

If you transfer your screen design software's System file \*<sup>2</sup>, the GP operates using that data. If the GP System file has been correctly setup and transferred, the INITIALIZE settings become unnecessary. For more information about GP System files

**Reference** *Operation Manual (included with the screen creation software), 1.1.2 "Screen Types"*

---

\*<sup>1</sup> PLC's that support the n:1 (multi-link) connection are limited.

**Reference** *PLC Connection Manual (included with the screen creation software)*

\*<sup>2</sup> Refers to GP screen creation software's "SYSTEM SETTINGS" area.

## 5.2 Initialization Items

The contents of the Initialize setup items listed below are explained in this Chapter. To learn about screen operations and numeric input.

Chapter 4, "OFFLINE Mode"

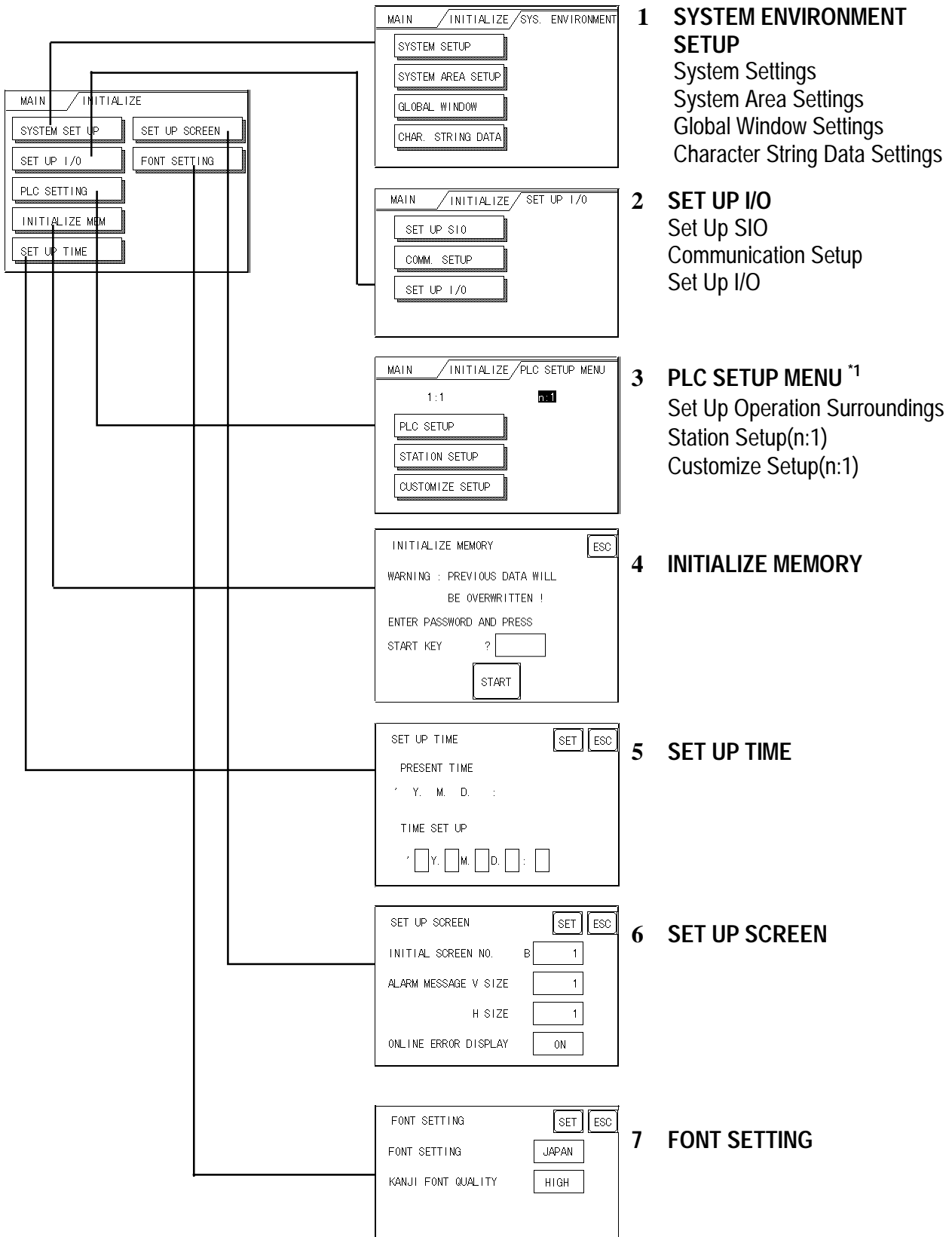

\*1 Note that, depending on the PLC type selected, the screens that appear in your GP's screen creation software will vary.



## 5.3 SYSTEM ENVIRONMENT SETUP

GP environment adjustments are made here. The SYSTEM ENVIRONMENT SETUP includes the SYSTEM SETUP, SYSTEM DATA AREA, GLOBAL WINDOW SETUP, and CHARACTER STRING DATA SETUP.

### 5.3.1 SYSTEM SETUP

SYSTEM SET UP	SET	ESC
STANDBY MODE TIME[MIN]	0	
START TIME[SEC]	0	
TOUCH BUZZER SOUND	ON	
PASSWORD SET UP	0	
DATA TYPE OF SCREEN NO	B I N	

#### STAND-BY MODE TIME (0-255)

To protect the GP display screen, the GP is equipped with a screen saver function that automatically erases the screen when no GP operations have occurred for a period of time. A "0" entered in this field causes a normal display, i.e. the screen is cleared after the GP's standard default time elapses. When SYSTEM DATA AREA's ( **Reference** *GP-PRO/PBIII for Windows PLC Connection Manual (included with the screen creation software)* ) SCREEN DISPLAY OFF\*<sup>1</sup> data is **0000h**, and the following operations are *not* performed on the screen for the User's designated period of time, the GP's current display data is cleared.

- Change Screen
- Touch Screen
- Alarm Display

#### START TIME (0-255)

This setup determines the start-up time of the GP. Use this setup to adjust the power up sequence so that the GP starts up after the PLC.

#### TOUCH BUZZER SOUND

Setup whether or not the GP beeps when pressed.

#### PASSWORD SETUP(0-9999)

The password setting is used when changing to the Initialize Memory or Initialize (OFFLINE mode) Screens. The password (*number*) ensures protection of the GP settings as OFFLINE mode will not be entered inadvertently. Enter the optional number of your choice. If you do not wish to use this setup, enter the default **0**.

\*1 When using the Direct Access or the Memory Link formats, the object address becomes +9 or +12, respectively.

**Reference** *GP-PRO/PBIII for Windows PLC Connection Manual (included with the screen creation software)*

## DATA TYPE OF SCREEN NO.

This setup controls whether BIN or BCD format numbers are used when making screen changes. Screen numbers 1~8999 are available when set up in binary format; screen numbers 1~1999 are available when set up in BCD format.

### 5.3.2 SYSTEM AREA SETUP

SYSTEM AREA SETUP is necessary for the PLC to control its GP-related data, and prepares the PLC internal Data Memory (DM) and Data Register (D)\*1. Use this setup to prepare the desired SYSTEM DATA AREA items.

**When using the Memory Link format, this setting is unnecessary.**

**Reference** *PLC Connection Manual (included with the screen creation software)*

Press the item, and when the item is highlighted, it has been selected.

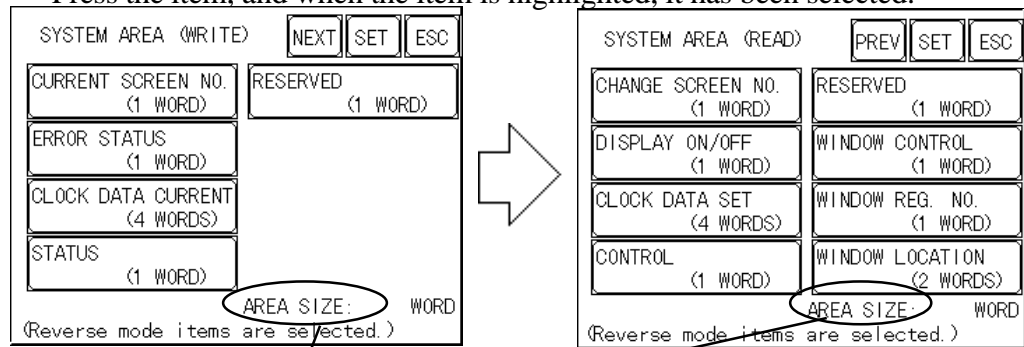

#### ◆ System Area Size

This field displays the total number of words used for the items selected from the SYSTEM AREA SETUP (**Write** and **Read**).

When you press the Confirm key, the SYSTEM AREA CONTENTS screen appears to confirm the selected items



- The setup shown is enabled only when using the Direct Access format.
- The selected System Area items, as displayed on the screen, become the System Data Area.

\*1 Data Memory (DM) refers to OMRON Co.'s PLC ; Data Register (D) refers to Mitsubishi Electric Co.'s PLC.

## Chapter 5 - Initializing the GP

When these five items, "Current Screen Number", "Error Status", "Clock Data (Current)", "Change Screen Number", and "Display ON/Off", have been selected, word addresses are assigned to each item, in order, as shown here.

SYSTEM AREA CONTENTS		SET	ESC
WORD		WORD	
+0	CURRENT SCREEN NO.	+10	
+1	ERROR STATUS	+11	
+2	CLOCK DATA CURRENT	+12	
+3	CLOCK DATA CURRENT	+13	
+4	CLOCK DATA CURRENT	+14	
+5	CLOCK DATA CURRENT	+15	
+6	CHANGE SCREEN NO.	+16	
+7	DISPLAY ON/OFF	+17	
+8		+18	
+9		+19	

The System DataArea selection process follows this formula [System Data Start Address + n]. For example, if the System Area Start Address was D00200, and the *Change Screen Number* option had been selected—if you refer to the System Area Contents screen displayed above—because *Change Screen No's* address is +6, its word address would be  $D00200+6=D00206$ .

**Reference** For information about how to use the System Start Address and Start Address, **5.5.1 Set Up Operation Surroundings**

**5.3.3 GLOBAL WINDOW SETUP**

The GP unit can display one *Global Window* and two *Local Windows* at any one time. The Global Window is common to all the display screens. The Local Window displays exclusively on the corresponding base screen. The GLOBAL WINDOW SETUP is described here.

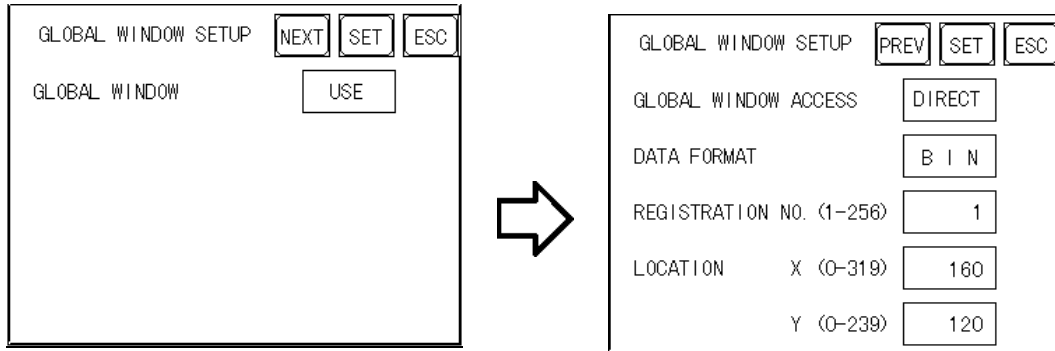

**GLOBAL WINDOW**

There are two options here: **Use** and **Do Not Use**. If you select **Do Not Use**, ignore the items described below. Selecting **Use** enables these options.

**GLOBAL WINDOW ACCESS**

Use this feature to designate whether a value used is **DIRECT** or **INDIRECT**, i.e. the **REGISTRATION NO.** and the **LOCATION** values. When set as **Direct**, the **REGISTRATION NO.** and **LOCATION** selections are fixed to the values entered here. When set to **Indirect**, the **WINDOW REG. NO.**'s word address, as prepared in the **System Area**, is a variable. This means it can have the **REGISTRATION NO.** *written* to it and, as a result, multiple window screens can be used as **Global windows**. You can use this method to adjust the **Global window** position by writing the **X, Y** coordinates to the **SYSTEM AREA**'s **LOCATION** word addresses.

**DATA FORMAT**

Setup whether the **REGISTRATION NO.** and the **LOCATION** values are **BIN** or **BCD** values. This field is related only to indirect values.

**REGISTRATION NO. (1-256)**

Enter the **Window Screen Number** used by the **Global Window**. This field is enabled only when **GLOBAL WINDOW ACCESS** is set to **direct**.

**WINDOW LOCATION**

Enter the value used for the (**Global WINDOW**) **LOCATION**. This field is enabled only when **GLOBAL WINDOW ACCESS** is set to **direct**.

**5.3.4 CHARACTER STRING DATA SETUP**

Character String Data ordering varies from manufacturer to manufacturer. Setup the Character String Data order here to match the corresponding PLC.

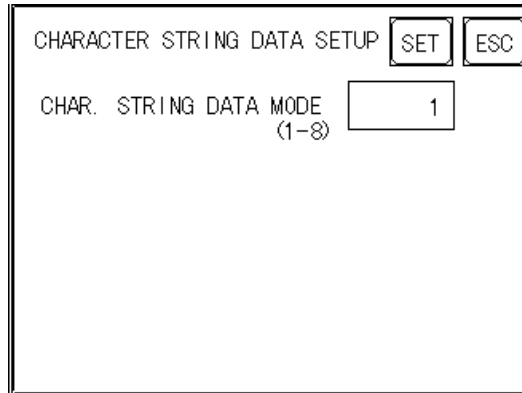

**Setup the CHARACTER STRING DATA MODE to match the PLC type. Device type and Tag settings are unavailable.**

Find the data storage order for your PLC in the table, down below, and setup the CHARACTER STRING DATA MODE.

- (I) Data Device Storage Order
- (II) Internal Word Byte LH/HL Storage Order
- (III) Internal Double-word Word LH/HL Storage Order

**CHARACTER STRING DATA MODE List**

(I) Data Device Storage Order	(II) Internal Word, Byte LH/HL Storage Order	(III) Double-word Internal Word LH/HL Storage Order	Character String Data Mode
Storage from Initial data	LH order	LH order	4
		HL order	2
	HL order	LH order	5
		HL order	1
Storage from End data	LH order	LH order	6
		HL order	7
	HL order	LH order	8
		HL order	3

# Chapter 5 - Initializing the GP

## I) Data Device Storage Order

E.g. Characters    A B C D E F G H  
                           └─┘ └─┘ └─┘ └─┘  
                           ①  ②  ③  ④

• Storage from Start Data



• Storage from End Data



## II) Word Byte LH/HL Order

E.g. Characters    A B C D  
                           ①②③④

• 16 bit Device LH Order

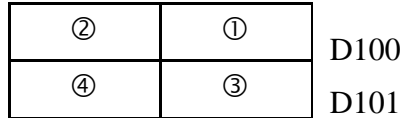

• 16 bit Device HL Order

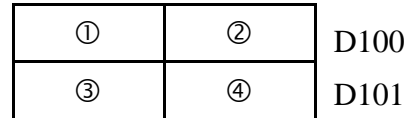

• 32 bit Device LH Order

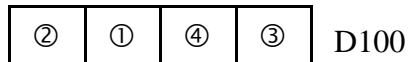

• 32 bit Device HL Order

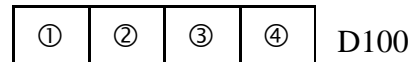

**III) Double-word Word LH/HL Order**

E.g. Characters "A B C D E F G H I J"  
 ① ② ③ ④ ⑤

• 16 bit Device LH Order

②	D100
①	D101
④	D102
③	D103
⑤	D104

• 16 bit Device HL Order

①	D100
②	D101
③	D102
④	D103
⑤	D104

E.g. Characters "A B C D E F G H I J K L M N O P Q R S T"  
 ① ② ③ ④ ⑤ ⑥ ⑦ ⑧ ⑨ ⑩

• 32 bit Device LH Order

②	①	D100
④	③	D101
⑥	⑤	D102
⑧	⑦	D103
⑩	⑨	D104

• 32 bit Device HL Order

①	②	D100
③	④	D101
⑤	⑥	D102
⑦	⑧	D103
⑨	⑩	D104



**Note:** Relationship between K-tag Write Character Value and PLC Device

• 16 bit Devices

GP stores the character string from the start, as groups of 2, into 1 PLC Device. When there are nine characters, they are arranged as shown below.

1 2 3 4 5 6 7 8 9 Null



**Note:** When the characters do not divide into 2 evenly, NULL is added at the end.

• 32 bit Devices

GP stores the character string from the start, as groups of 4, into 1 PLC Device. When there are nine characters, they are arranged as shown below.

1 2 3 4 5 6 7 8 9 Null



**Note:** When the characters do not divide into 4 evenly, NULL is added at the end.

## 5.4 SET UP I/O

This section describes the communication setup with the host PLC and the setup for any peripheral equipment. The SET UP I/O menu includes the SET UP SIO, COMMUNICATION SETUP and SET UP I/O menus.

### 5.4.1 SET UP SIO

This menu runs the settings related to PLC communication. Be sure to match the settings listed below with the SIO setup on the PLC host.

**Reference** *GP-PRO/PBIII for Windows PLC Connection Manual (included with screen creation software)*

SET UP SIO	SET	ESC
COMMUNICATION RATE	19200	
DATA LENGTH	7/2	
PARITY	EVEN	
CONTROL	ER-CNTRL	
COMMUNICATION INTERFACE	RS232C	

#### COMMUNICATION RATE

The COMMUNICATION RATE (baud rate) is the data communication speed, measured in bits per second (bps), between the GP and PLC. Match the COMMUNICATION RATE values in both the PLC and GP. Depending on the rate selected, certain PLCs may not be able to be used.

**Reference** *GP-PRO/PBIII for Windows PLC Connection Manual (included with screen creation software)*

#### DATA LENGTH

For data communications, the DATA LENGTH must be set up as 7-bit or 8-bit data, and set up also the STOP BIT as either a 1-bit or 2-bit value.

#### PARITY

Set up whether no parity check, or an odd or even number parity check will take place during communication.

#### CONTROL

Data flow CONTROL prevents the overflow of data sent back and forth. Select either X-CNTRL or ER-CONTRL.

#### COMMUNICATION INTERFACE

Select one of the following options for the communication format: RS-232C, RS-422 (4 line), or RS-422 (2 line).



**When using an RS422 cable and the Memory Link format, be sure to select the 4-line option.**

**Reference** *GP-PRO/PBIII for Windows PLC Connection Manual (included with screen creation software)*



## 5.4.2 COMMUNICATION SETUP

COMMUNICATION SETUP	SET	ESC
RECEIVE TIMEOUT (1-127)	10	SEC
RETRY COUNT (0-255)	2	

### RECEIVE TIMEOUT

Sets the value used for the data reception timeout (PLC - GP).

If the cable is not connected, data communication will Timeout in one second, regardless of this setting's value. The default is "10" seconds.



- **If you transfer screens when a PLC communication error has occurred and the error is not yet cleared, and the RECEIVE TIMEOUT value is set to 30 seconds or more, an error message may appear on your personal computer.**

### RETRY COUNT

Designates how many times the GP tries to send data to the PLC when a PLC communication error occurs. An Error Message will appear on the GP after the GP tries to send data to the PLC the number of times set by this option. The default is "2".

## 5.4.3 SET UP TOUCH PANEL

Touch operation and Force Reset setup, and Display Device adjustments are made here.

SET UP 1/0	SET	ESC
TOUCH OPERATION MODE	2 POINTS	
SYSTEM RESET MODE	ON	
CONTRAST SETTING	ON	
BRIGHTNESS SETTING	ON	
USE TOUCH PANEL AFTER BACKLIGHT BURNOUT	YES	

### TOUCH OPERATION MODE

Designates either One Point, Two Point or No Slide. When No Slide is selected, dragging one's finger across the touch screen will elicit no screen response, and only individually selected points will register.

### SYSTEM RESET MODE

Designates whether or not a SYSTEM RESET operation is performed.

#### ◆Steps to run SYSTEM RESET

While holding down the bottom right corner (1) of the screen, press the upper right corner (2). At the same time, press the bottom left corner (3) to enter the FORCE RESET Operation. To activate Reset, press the **RESET** button, to transfer to OFFLINE Mode, press **OFFLINE**.

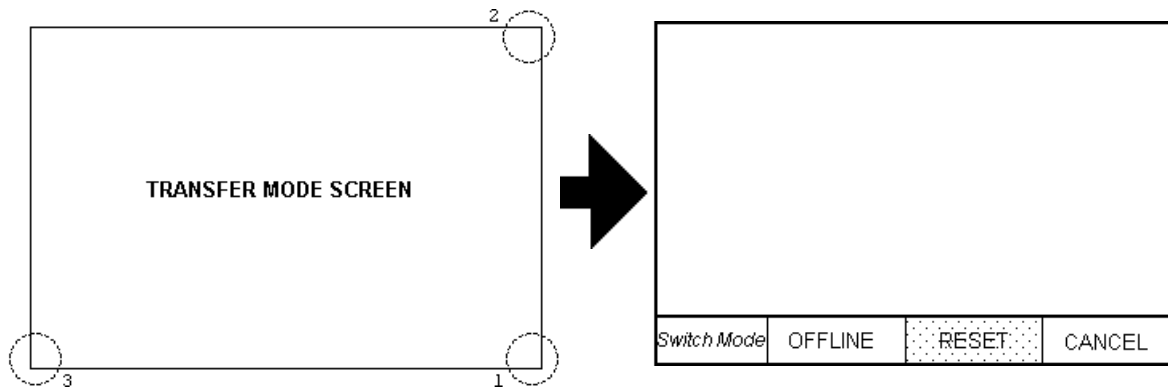

- **FORCE RESET can occur during either RUN mode or OFFLINE mode.**



- **The SYSTEM RESET mode cannot be entered while the GP is starting up.**
- **Entering SYSTEM RESET is possible even when RUN operations (PLC <—>GP communication) are not being performed.**

### CONTRAST SETTING

This option is not available with the GP-377RT.

### BRIGHTNESS SETTING

When set to ON, BRIGHTNESS SETTING can be performed via touch input.

Press the bottom left corner (2) of the screen while holding down the bottom right corner (1) to enter BRIGHTNESS SETTING mode. Touch the left-side of the bar to brighten the display; touch the right-side of the bar to dim the display. This unit has four levels of adjustment.

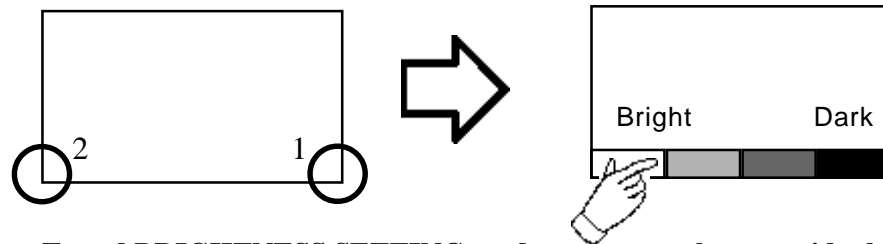

- To end BRIGHTNESS SETTING mode, press anywhere outside the bottom of the screen.
- BRIGHTNESS SETTING mode cannot be entered while waiting for GP to start up.
- BRIGHTNESS SETTING can be made even during RUN mode (PLC $\longleftrightarrow$ GP communication).

### USE TOUCH PANEL AFTER BACKLIGHT BURNOUT

This option designates whether touch-operation is disabled or not when the backlight burns out.

If this selection is set to [OFF], touch-operation will be disabled when the backlight burns out, which can prevent accidental incorrect use of the GP unit.



- When the backlight burns out, the Status LED's orange light turns ON, and the System Data Area's "Status" bit 10<sup>\*1</sup> will turn ON.
- If the [SYSTEM RESET] option is set to [ON], only "System Reset" can still be performed by touch-operation in case of backlight burnout.
- If the backlight burns out when the GP is OFFLINE, touch-panel operation is enabled, regardless of these settings.



**Normally, the GP monitors the status of its backlights by observing their power consumption, however, there may be cases where a GP malfunction causes a backlight burn-out not to be detected.**

\*1 Bit +6 when using the Direct Access method, and bit +11 when using the Memory Link method, will turn ON.

**Reference**  $\triangleleft$  GP-PRO/PBIII for Windows PLC Connection Manual (included with screen creation software)

## 5.5 PLC SETUP

Setup the System Area and the Unit number in this screen. Because 1:1 and n:1 GP connections utilize different settings, confirm your connection's needs before using any settings. The following assumes that the Direct Access format is used.



- The screens may differ depending on the PLC type you selected in the screen creation software.

▼ **Reference** ▲ *GP-PRO/PBIII for Windows PLC Connection Manual (included with screen creation software)*

- When the GP-PRO/PBIII for Windows "Simulation" feature is used, the OPERATION SURROUNDINGS menu cannot be entered.

### 5.5.1 SET UP OPERATION SURROUNDINGS (1:1/n:1)

Enter the PLC System Data Area and the Unit Number settings here. Same options are available for both 1:1 Connection and n:1 (Multi-link) Connection.

For 1:n (Multi-link) Connection, System Data Area settings must be setup for each GP connected.

▼ **Reference** ▲ *GP-PRO/PBIII for Windows PLC Connection Manual (included with screen creation software)*

SET UP OPERATION SURROUNDINGS		SET	ESC
SYSTEM AREA START DEV	<input type="text"/>		
START ADR	<input type="text"/>		
UNIT No.	<input type="text"/>		
SYSTEM AREA READ SIZE	<input type="text"/>		
RESET GP ON WRITE ERROR	<input type="text"/>		

#### SYSTEM AREA START (DEV/ ADR)

Setup the PLC's Data Register (D), Data Memory (DM), etc. allotted by the SYSTEM AREA START DEV, START ADR.

▼ **Reference** ▲ *GP-PRO/PBIII for Windows PLC Connection Manual (included with screen creation software)*

#### UNIT NO.

Set up the PLC UNIT number here. Make sure it matches the one set up in the PLC.

#### SYSTEM AREA READ SIZE (0-256)

When using a Block Display Trend Graph, setup the Reading Area Size (in word units) to match the Trend Graph's data size. Setup when you wish to allocate the Reading Area in the PLC Data Register (D), or Data Memory (DM).



**If you are not using the Reading Area, leave the 0 default values intact. This will allow you to perform high speed data communication.**

## RESET GP ON WRITE ERROR

Designates the mode which enables you to cancel the error from the error display when the Write error occurs.

### 5.5.2 STATION SETUP (n:1)

The STATION SETUP, necessary for the n:1 (Multi-link) setup, checks whether correct communications run with the connected GP System configuration.

STATION SETUP	SET	ESC
NETWORK INFORMATION DEV	D	
INFORMATION ADR	1	
STATION No. (0-15)	0	

#### NETWORK INFORMATION (DEV/ADR)

In the n:1 (multi-link) connection, the Network Information uses 2 words in its correspondences. These two (2) words consist of a Connection List and a Validation List (described later in this section). These areas are allocated in the PLC's Data Register (D) or Data Memory (DM). Select the Device No in the , then enter the address No.

**Reference** *GP-PRO/PBIII for Windows PLC Connection Manual (included with screen creation software)*

PLC Data Register		
+0	CONNECTION LIST	PLC-->GP
+1	VALIDATION LIST	GP-->PLC



**Important**

**In the NETWORK INFORMATION ADR, setup the same address to all the GP's connected to the same link unit. Furthermore, when there are 2 ports in the connected link unit, do not make them the same address.**

#### ◆ Connection List

The word address for the Connection List sets up the number of GP's connected to the PLC, which must be registered beforehand on the PLC side. When these GP's are connected to the PLC, the corresponding PLC bit numbers for the particular GP Stations (see below) turn ON.



**Note:**

**When the GP is connected to the PLC, and the option of GP only correspondence ends and OFFLINE mode is entered, the GP Station Number then turns the corresponding PLC bit OFF.**

Bit 15

Bit 0

15	14	13	12	11	10	9	8	7	6	5	4	3	2	1	0
unit	unit	unit	unit	unit	unit	unit	unit	unit	unit	unit	unit	unit	unit	unit	unit

## Chapter 5 - Initializing the GP

For example, when these 4 GP units—bit 0, bit 2, bit 3, bit 5—are connected, 002D (h) is written here.

Connection List 

0	0	0	0	0	0	0	0	0	0	0	1	0	1	1	0	1
---	---	---	---	---	---	---	---	---	---	---	---	---	---	---	---	---

 002D (h)



- **Be certain to setup this data before running.**
- **Turn all bits not related to the GP OFF.**

### ◆ Validation List

This area responds to the correspondence from each connected GP. In the Validation List, when the same bit numbers as the Connection List turn ON, the correspondence is accepted. The Station Numbers of the communicating GPs turn their corresponding PLC bit number ON.

Bit 15 Bit 0

15	14	13	12	11	10	9	8	7	6	5	4	3	2	1	0
unit	unit	unit	unit	unit	unit	unit	unit	unit	unit	unit	unit	unit	unit	unit	unit

If the correspondence between the GP and PLC is correct, the same value as in the Connection List is written to the Validation List.

For example, the value 002D (h) in the Connection List, setup as the 0 bit, 2 bit, 3 bit, and 5 bit, writes to the Validation List.

Connection List 

0	0	0	0	0	0	0	0	0	0	0	1	0	1	1	0	1
---	---	---	---	---	---	---	---	---	---	---	---	---	---	---	---	---

 002D (h)

Validation List 

0	0	0	0	0	0	0	0	0	0	0	1	0	1	1	0	1
---	---	---	---	---	---	---	---	---	---	---	---	---	---	---	---	---

 002D (h)



- **When the Connection List and Validation List do not match, a COMMUNICATION ERROR occurs. Check the setup again.**
- **When changing the connection, first turn all the bits OFF.**

### STATION NO. (0-15)

This is the setup for the GP Station Number mentioned above. The setup range is from 0 to 15, and the only other restriction is the GP STATION NO. must be unique in the system. If STATION NO.'s are repeated, a COMMUNICATION ERROR occurs.



- **The STATION NO. is the number allocated to the particular GP unit. This number is not related to the Link Unit Machine number.**

### 5.5.3 CUSTOMIZE SETUP (n:1)

The Customize function modifies the n:1 (multi-link) connection's communication method to make it more effective. To run communication efficiently, the user should first determine whether they wish to have Operation or Display priority set for the GP. Based on this, the communication response speed can be upgraded. (However, this also depends on the screen information displayed.)

CUSTOMIZE SETUP	SET	ESC
PLC PRIORITY	OPE.	
GP TOUCH MONOPOLIZE	OFF	
MONOPOLIZE TIME (0-2550s)	0	*10s

#### PLC PRIORITY

According to how the GP is used, select either Operation priority (OPE.) or Display priority.

- Operation

Setup the GP to this option when using the GP mainly as an operation panel. As a result, the GP will command better touch panel numeric input and switch response times.

Leaving the GP in this mode does not drastically influence the touch panel operation response time of other GPs. The screen display renewal cycle, however, will slow.

- Display

Setup the GP to this option when using the GP mainly as a monitor screen. The GP will command a higher display speed as a result; however, the response time for the touch panel's operations will slow.



- **In a standard network setup, use the same setup for all connected GP's.**
- **To increase the display speed, be sure the addresses used are consecutive addresses. When bit addresses are used, use consecutive to the word units.**

## Chapter 5 - Initializing the GP

### • Speed Difference between Display Priority and Operation Priority

When using the Mitsubishi Electric Corp. A3A PLC, with a scan time of 20ms with consecutive addresses (80 words not included in the System Area), the difference in reading speed is as shown in the following graphs.

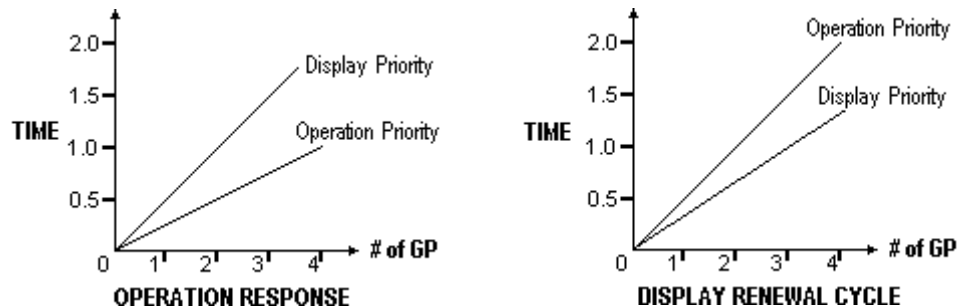

### GP TOUCH MONOPOLIZE

The monopolizing of touch panel use can be set ON or OFF. When you want to use the PLC exclusively with a Momentary operation setup on the touch panel, turn GP TOUCH MONOPOLIZE ON.

When this setup is ON, the touch panel uses the PLC exclusively whenever the momentary operation setup on the panel is pressed. In this way, you can use the inching operation with a momentary switch. When you stop pressing the panel, exclusive use ends.

▼ **Reference** ▲ *GP-PRO/PBIII for Windows PLC Connection Manual (included with screen creation software)*

### MONOPOLIZE TIME (0 to 2550s)

This field controls the length of time for the monopolize process when no other touch panel operations are performed. The Monopolize process begins when the System Data Area's 7th bit of word address LS14 turns ON, and ends either when the bit turns OFF, or when the time set here elapses.



- **Pressing the touch panel in the middle of the monopolize process interrupts the MONOPOLIZE TIME function, and ends exclusive use.**
- **When MONOPOLIZE TIME is set to 0, the monopolize function does not end automatically.**

For further information about the contents of System Data Area LS6 (status) and LS14 (control) ▼ **Reference** ▲ *GP-PRO/PBIII for Windows PLC Connection Manual (included with screen creation software)*



## 5.6 INITIALIZE INTERNAL MEMORY

This command erases all the GP screen data and initializes the GP's SRAM.



- **You cannot cancel the Initialization procedure after pressing the Start key.**
- **All backed up data in SRAM is lost.**
- **Initialization does not erase the SYSTEM SET UP, the SIO protocol, or the internal clock settings.**

To initialize the GP internal memory, enter the common password **1101**, or the password entered in the SYSTEM SET UP screen.



**Reference** Chapter 4.3, "INITIALIZE-Standard Operation"

- The time required for Initialization is between 10 and 20 seconds.

## 5.7 SET UP TIME

Sets the GP's internal clock.

### SET UP TIME

Enter date and time corrections to the date and time displayed in the PRESENT TIME.



The GP's internal clock has a slight error. At normal operating temperatures and conditions, with the GP operating from its lithium battery, the degree of error is 65 seconds per month. Variations in operating conditions and battery life can cause this error to vary from +65 to -350 seconds per month. For systems where this degree of error will be a problem, the user should be sure to monitor this error and make adjustments when required.

## 5.8 SET UP SCREEN

The initial screen display upon powering up, the character size when in RUN mode, and other general screen items are setup here.

SET UP SCREEN		SET	ESC
INITIAL SCREEN NO.	B	1	
ALARM MESSAGE V SIZE		1	
H SIZE		1	
ONLINE ERROR DISPLAY		ON	

### INITIAL SCREEN NO.

Set up the screen file number that will display first upon powering up. If the BIN option for DATA TYPE OF SCREEN NO in SYSTEM SET UP had been selected, enter a number from 1 to 8999. Or, if BCD was the option set up, then input a number from 1 to 1999.

### ALARM MESSAGE

Set up the character size of the ALARM MESSAGE when the Alarm Bulletin is activated.

#### <When using syngle-byte characters>

1	2	4
V size=1; H size=1 16×8 pixels	V size=2; H size=2 32×16 pixels	V size=4; H size=4 64×32 pixels

#### <When using double-byte characters>

V size=1; H size=1 16×16 pixels	V size=2; H size=2 32×32 pixels	V size=4; H size=4 64×64 pixels
------------------------------------	------------------------------------	------------------------------------

### ONLINE ERROR DISPLAY

Set up whether or not error messages display during RUN mode.

## 5.9 FONT SETTING

FONT SETTING	SET	ESC
FONT SETTING	JAPAN	
KANJI FONT QUALITY	HIGH	

### FONT SETTING

Select the character font that displays during RUN mode. Available selections are [EUROPE], [JAPAN], [KOREA], [CHINESE] and [TAIWAN-ESE].

### KANJI FONT QUALITY

◆When [FONT SETTING] is set to [JAPAN]

Full sized characters:

[STANDARD] : Full sized 16-dot characters display. When enlarged, this font will remain a 16-dot character. (Compatible with GP-\*30 series units.)

[HIGH]: Any character which is Level 1 JIS Kanji Code standard larger than 2 x 2 will display as a 32-dot character. Level 2 JIS Kanji Code standard characters, no matter what the current font setting is, will always display using 16 dots.(Compatible with GP-\*50 and GP-\*70 series units.)

[1,2]: Level 1 or 2 JIS Kanji Code standard characters that are larger than 2 x 2, will display as 32-dot characters.

◆When [FONT SETTING] is set to any other type

A full sized character (except Alphabets) is displayed with 16-dot font, even when it is displayed with an enlarged size. Half sized characters are displayed as:

[STANDARD]: 16x8-dot characters display. When enlarged, this font will stay as 16x8-dot character. (Compatible with GP-\*30 series units.)

[HIGH]: Alphabets and numerals (exceptions not included) will display as high quality font-character.

[1,2]: Alphabets and numerals (exceptions not included) will display as high quality font-character.

The [HIGH] selection is factory set.

*MEMO*

# Chapter 6 GP RUN Mode and Errors

1. GP RUN Mode
2. Troubleshooting
3. SELF-DIAGNOSIS
4. Error Messages

This chapter describes both the GP RUN mode and GP problem solving processes.

## 6.1 GP RUN Mode

There are two ways of entering the GP's RUN mode; first, immediately after plugging in the unit's power cord, and the other, from the GP's OFFLINE mode.

### 6.1.1 After Powering Up the GP

First, connect the GP's power cable. After the unit has powered up, the START TIME value, set up in INITIALIZE area's SYSTEM SET UP feature, determines how long the display shown below is shown. The screen designated in the INITIALIZE area's SET UP SCREEN feature will then be shown and the GP will start communicating with the PLC. If, however, a screen has not been designated in the INITIALIZE area's SET UP SCREEN feature, or if the screen itself does not exist, then this display will remain.

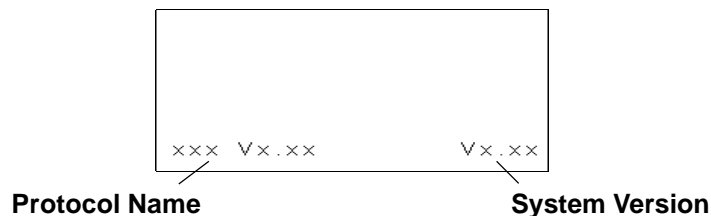

### 6.1.2 Via OFFLINE Mode

Touch the MAIN MENU's RUN selection to start your downloaded "project". The INITIALIZE area's SET UP SCREEN feature designates the first screen that appears in RUN mode, and, after this screen appears, communication with the PLC begins. If, however, the designated initial screen has not been created, or does not exist, the above display will remain.

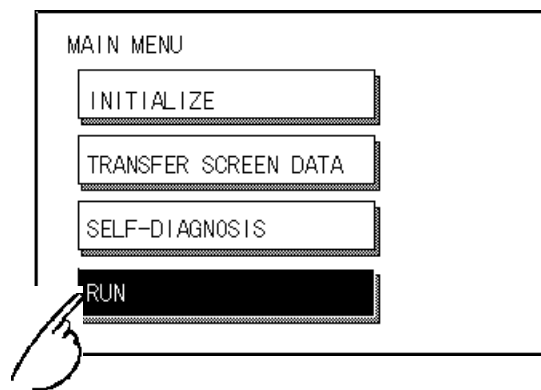

## Chapter 6 - GP RUN and Errors

- To enter OFFLINE Mode, simply touch the top left corner of the GP's screen within 10 seconds after connecting the GP's power cord.

E.g. After powering up the GP, the initial screen that appears is equipped with a built-in (invisible) switch in the top left corner. Touch this switch within 10 seconds to change the GP from RUN to OFFLINE mode.

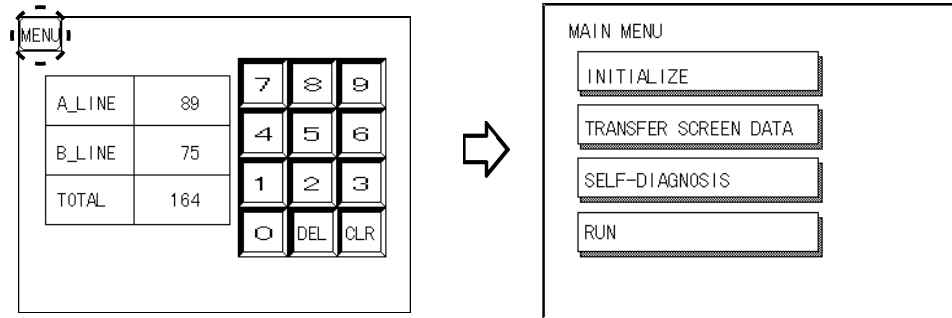

## 6.2 Troubleshooting

This section describes how to find and resolve problems that may occur on the GP. If there is a problem on the PLC side, refer to the corresponding PLC manual.

### 6.2.1 Possible Types of Trouble

Followings are some problems that may occur while using this unit.

#### **(A) No Display**

The screen will not display even when the unit is powered On. Also, during RUN mode, the screen disappears.

#### **(B) No GP/HOST Communication**

The GP unit cannot extract data from the host. An error message may appear on the screen as a result.

**▼Reference▲** *This chapter's "Error Messages"*

#### **(C) Touch Panel Does Not Respond**

The touch panel does not react when pressed, or the reaction time is very slow.

#### **(D) OFFLINE displays During RUN Mode**

The GP goes to the OFFLINE mode unexpectedly while operating, or the GP automatically goes to the OFFLINE mode when the power is turned ON.

For these first three problems, see the following pages' troubleshooting tables.

For the last problem (D), a SYSTEM ERROR may have developed while displaying the OFFLINE mode screen.

**▼Reference▲** **Chapter 6.4.2 Error Message Details**

Be sure that no object has touched the screen accidentally if the GP goes to the OFFLINE mode without displaying an error message when the power turned ON. If any object may have possibly touched the top left corner of the screen within 10 seconds after the power turned ON, that may cause the GP to go OFFLINE.

## 6.2.2 Troubleshooting Checklists

Follow the flowchart below when the screen does not display when powering up, or the screen turns OFF by itself during RUN mode, to find an appropriate solution.

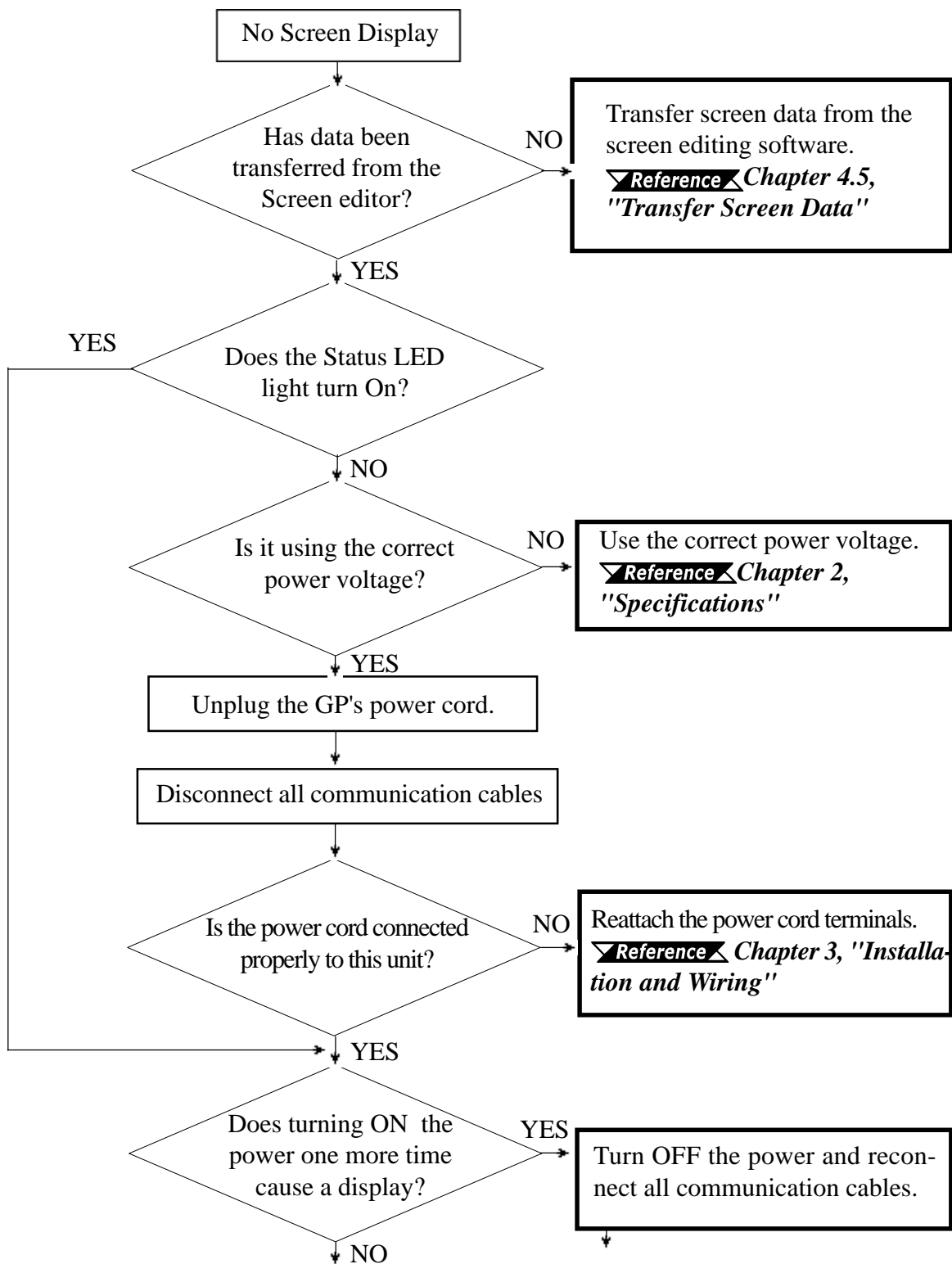



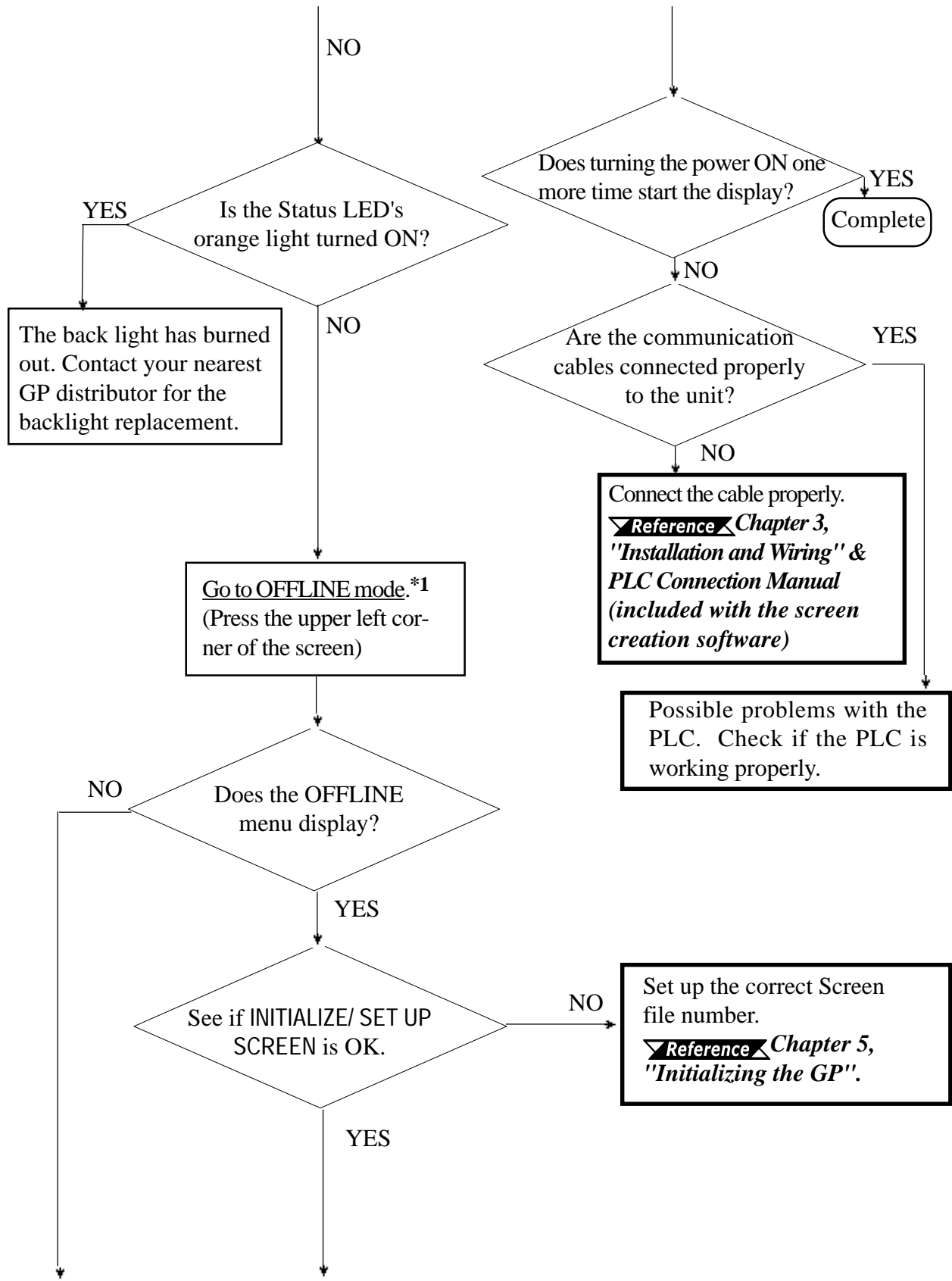

\*1 To make the OFFLINE screen appear, turn the power OFF, then ON, and press the upper left corner of the screen within 10 seconds.

## Chapter 6 - GP RUN and Errors

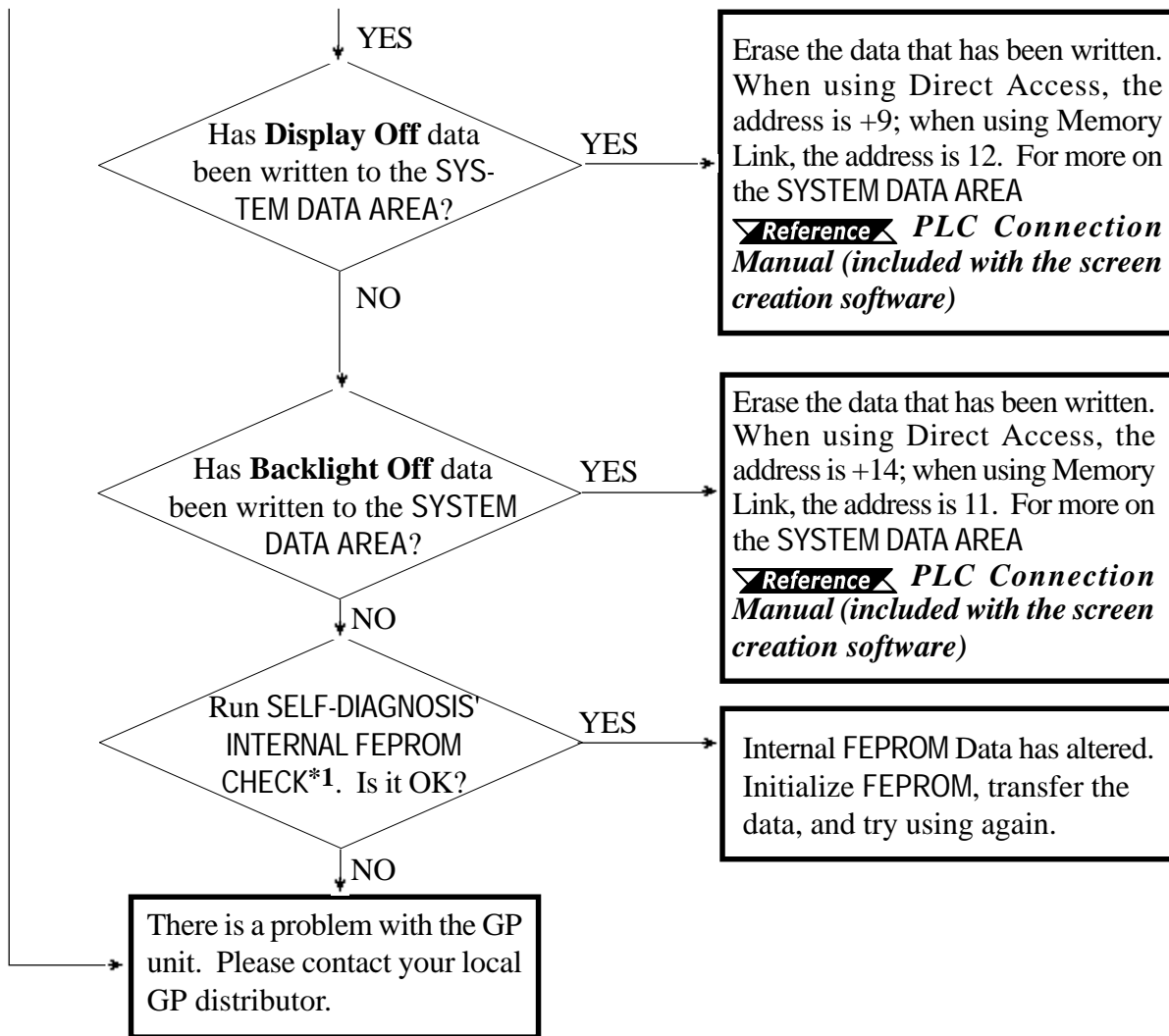

*\*1 When you run the FEPROM CHECK in SELF-DIAGNOSIS, all the screen data gets erased. Be sure to make a backup of all the screens.*

**6.2.3 No GP/Host Communication**

When the GP will not communicate with the host PLC, follow the flowchart below to find both the cause of the problem and a suitable response.

Or, if an error message displays on the screen, check the error code (refer to the *Error Messages* section in this chapter) to find the appropriate solution.

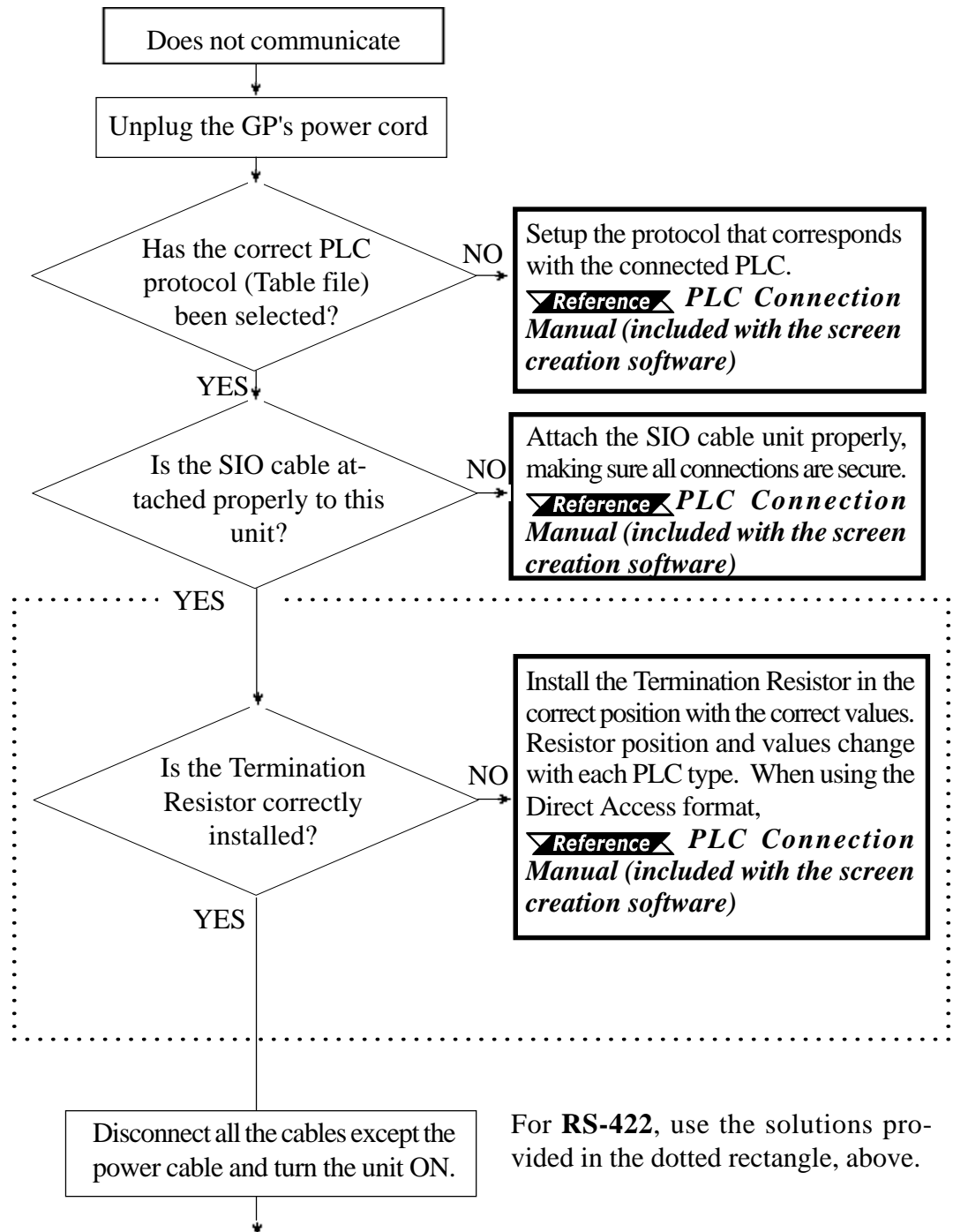

## Chapter 6 - GP RUN and Errors

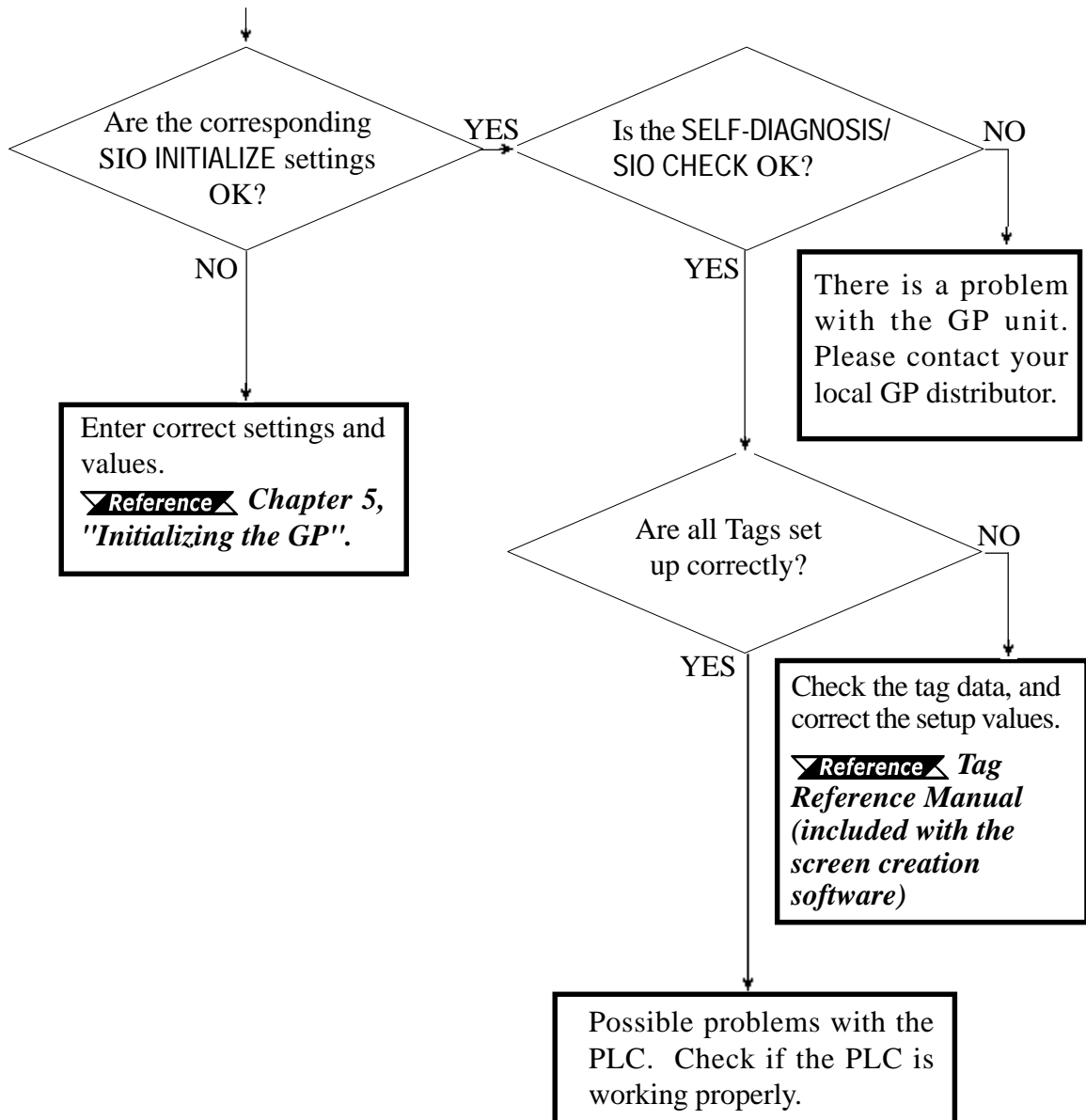

**6.2.4 Touch Panel Does Not Respond**

When the touch panel does not respond, or its response time is very slow after it is pressed, please use the flowchart below to find the origin of the problem, and the appropriate solution.

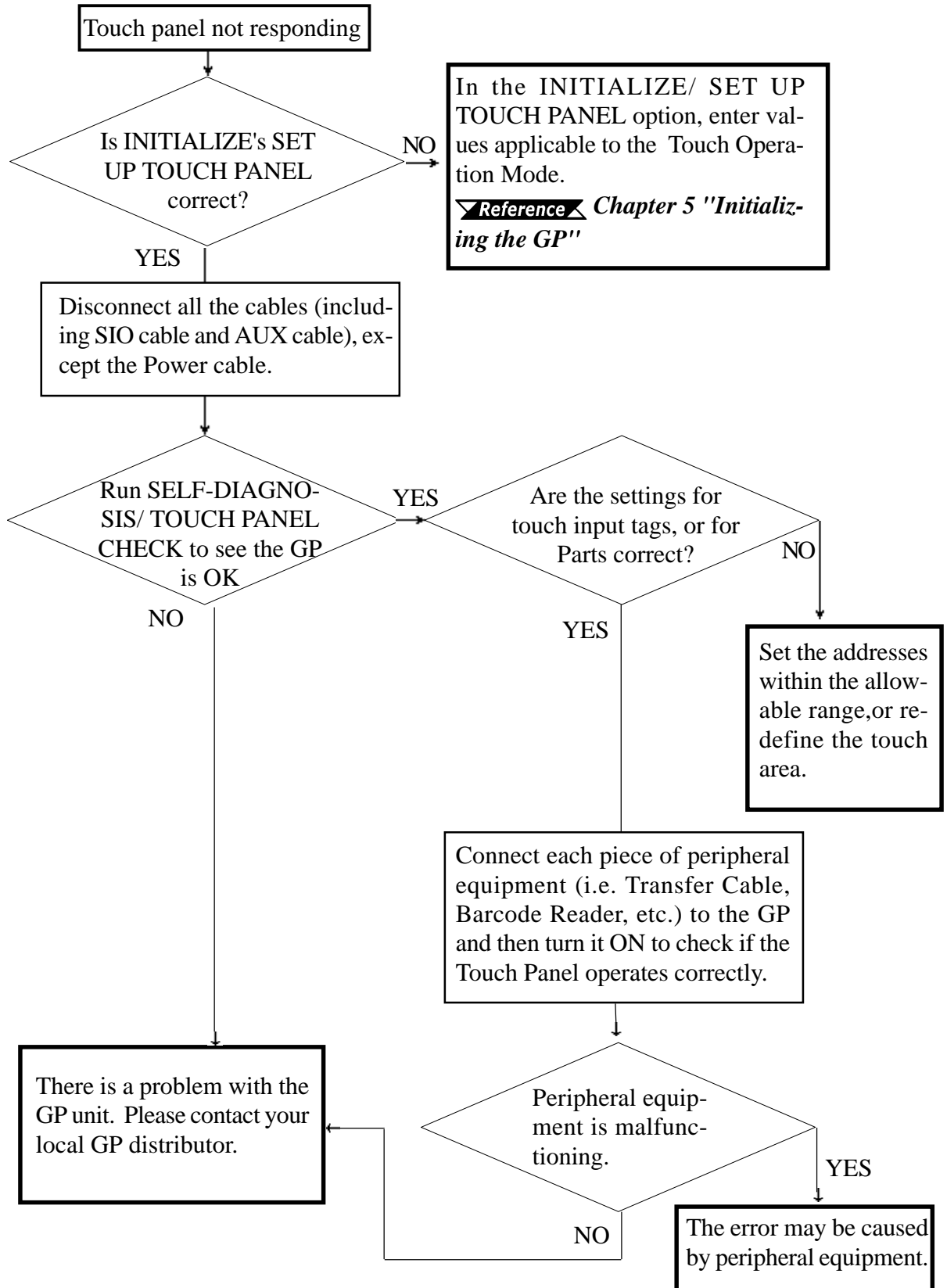

### 6.3 SELF-DIAGNOSIS

The GP unit is equipped to check its own System and Interface for any problems. Use it to help diagnose any problems.

#### 6.3.1 GP SELF-DIAGNOSIS Item List

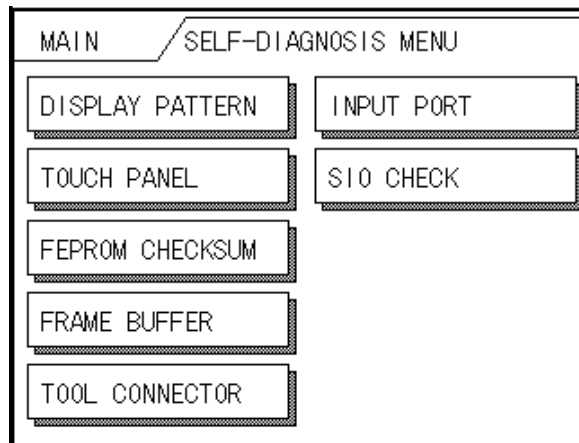

##### DISPLAY PATTERN

Checks all the figures and tiling patterns.

##### TOUCH PANEL

Checks each GP touch panel square.

##### FEPROM CHECKSUM

Checks the System and Protocol of the GP Internal Memory (FEPROM).

##### FRAME BUFFER

Checks the internal display memory (Frame Buffer).

##### TOOL CONNECTOR <sup>\*1</sup>

Checks the Tool Connector control lines and send/receive lines.

##### INPUT PORT

Checks the Input Port (for Digital's maintenance use only).

##### SIO CHECK <sup>\*1</sup>

Checks the RS-232C and RS-422 send/receive lines.

---

*\*1 This item requires special tools. Please prepare the required tool for the test.*

### 6.3.2 SELF-DIAGNOSIS - Details

This section explains the contents of SELF-DIAGNOSIS. For information on how to operate the Screen, [Reference Chapter 4, "OFFLINE Mode"](#); for information about how to set up the Special Tools, [Reference Chapter 3, "Installation and Wiring"](#).

#### DISPLAY PATTERN

Used when the buzzer will not sound and when the device contents will not display correctly to check the drawing function. It does this by running checks on the various screen pattern displays (8 screens), the ON/OFF Display, and KANJIROM CHECKSUM. When the ON/OFF Display is checked, the Buzzer ON/OFF check is run simultaneously. If KANJIROM CHECKSUM is normal, **OK** displays; if there is a problem, **NG** displays.

#### TOUCH PANEL

Touch Panel check. Checks if each touch cell highlights when pressed.

#### INPUT PORT

Used only for Digital's maintenance.

#### INTERNAL FEPRM CHECKSUM (System & Protocol)

The Internal FEPRM System and Protocol check searches for any problems that may arise during operations. When running the check, the screen will change as follows.

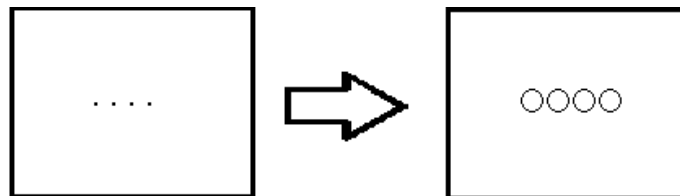

When the FEPRM is normal, **OK** displays; if there is a problem, the screen stops in the middle of operation. This check does not erase the System or Protocol.

#### FRAME BUFFER

The Frame Buffer (display memory) Check looks for any display problems that may develop. When everything is normal, **OK** displays; when there is a problem, an error message displays.

## Chapter 6 - GP RUN and Errors

### TOOL CONNECTOR

Use the Tool Connector Control line and Send/Receive line check when the GP cannot send and receive data from the PC. To run the check, connecting a *Tool Connector Check Loop Back Cable* (Dsub9 pin, pin-side) mounted to the *Downloading Cable* (provided in the software package) is necessary.

When everything is normal, **OK** displays; when there is a problem, an error message displays.

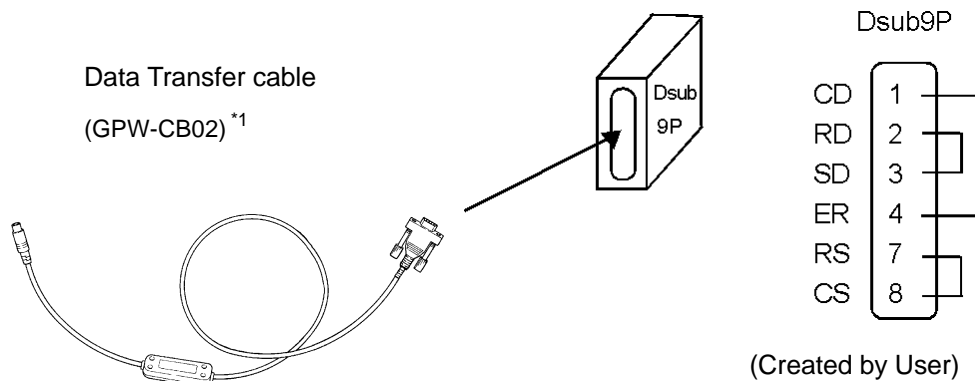

### SIO CHECK

Checks the RS-232C and RS-422 SIO lines for areas where communication problems develop. In the menu, select which check to run. To run the check, connecting the SIO cable is necessary. If all is normal, **OK** displays; if there is a problem, an error message appears.

The SIO cable wiring is as shown below. (RS-232C, RS-422 common)

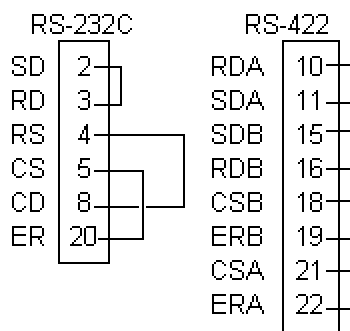



## 6.4 Error Messages

This section explains the messages that appear when an error has occurred in the GP unit during RUN mode. The problem causing the error message and its related countermeasure are explained in the table below.

After a problem has been solved, unplug the GP's power cord and then reattach it. (*Only the latest error message will appear on the GP screen*)

### 6.4.1 Error Message List

Error Message	Problem	Countermeasure
<b>SYSTEM ERROR (03 : **)</b>	During screen data transfer, an unrecoverable error occurred.	<b>Reference</b> 6.4.2 Error Message Details
<b>SYSTEM ERROR (** : ** . **)</b>	During screen data transfer, an unrecoverable error occurred.	<b>Reference</b> 6.4.2 Error Message Details
<b>ILLEGAL ADDRESS IN SCREEN DATA</b>	Settings are used that overlap addresses.	Set the addresses correctly after checking the screen data.
<b>UNSUPPORTED TAG IN SCREEN DATA</b>	The GP currently in use does not support the desired Tag.	Set the Tag correctly after checking the screen data.
<b>PLC NOT CONNECTED (02 : FF) and (02 : F7)</b>	The communication cable is not connected correctly.	Re-connect the communication cable correctly.
<b>PLC NOT RESPONDING (02 : FE)</b>	PLC's power is not turned ON.	Turn ON the PLC's power.
	GP unit INITIALIZE settings (Setup I/O, PLC Setting) are incorrect.	Check the INITIALIZE settings and make any necessary corrections.
	The host and GP Powering up sequence was incorrect.	Turn ON the PLC's power and wait for 2-3 seconds, then turn ON the GP's power.
	The communication cable is not connected properly.	Check the communication cable and connect it correctly.
<b>RECEIVE DATA ERROR (02 : FD)</b>	The communication cable was disconnected while the GP was ON.	Turn the GP OFF and then ON again.
	The GP is powered OFF, then ON during communication with PLC.	Turn the GP OFF and then ON again.
	Noise occurred in the communication cable.	Check the communication cable and connect it correctly.
<b>GP STATION NO. DUPLICATION ERROR (02 : F9)</b>	This GP's station number is same as another GP.	Check all GP station numbers, and set them so they are all unique.
	PLC is powered OFF, then ON during communication with GP.	Turn the GP OFF and then ON again.
<b>NETWORK ADDRESS ERROR (02 : F8)</b>	The SIO address used for this GP is different from other GP's. (Only for the Multi-Link connection)	Check all GP's SIO address settings, and correct any that are incorrect.
<b>PLC COM. ERROR (02 : **)</b>	Specific PLC related error, or an error has occurred with the PLC.	<b>Reference</b> 6.4.2 Error Message Details

## Chapter 6 - GP RUN and Errors

<b>SCREEN MEMORY DATA IS CORRUPT (nnnn:mmmm)</b>	ScreenData is corrupted: *nnnn indicates the Screen Number that has an error. *mmmm indicates the number of screens that have errors.(Decimal)	Check the screens that have errors, correct all errors, and then transfer the screen data again.
<b>CLOCK SETUP ERROR *1</b>	The backup battery for the internal clock is running low.	<b>Reference</b> 6.4.2 Error Message Details
<b>SCREEN TRANSFER ERROR</b>	An error occurred in the data transmission from the screen editor to the GPpanel.	Re-transfer the screen data.
<b>SCREEN TAG LIMIT EXCEEDED</b>	Tags are setup beyond the tag limit (max. of 385.)	<b>Reference</b> 6.4.2 Error Message Details
<b>OBJ. PLC HAS NOT BEEN SETUP (**)</b>	The host PLC set up in the Editor program does not match the PLC in use.	<b>Reference</b> 6.4.2 Error Message Details

## 6.4.2 Error Message Details

### ■ SYSTEM ERROR

Indicates a fault in the basic operations of the GP.

Following the error message, an error code, as shown below, will appear.

Report the error number and details on how the error developed to your local GP distributor.

### ◆ SYSTEM ERROR ( 03 : x x )

An unrecoverable error occurred during screen data transfer.

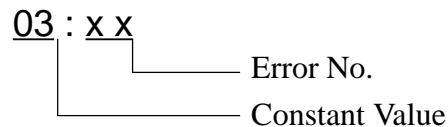

### ◆ SYSTEM ERROR ( x x x : x x x : x x x )

An unrecoverable error occurred during screen data transfer.

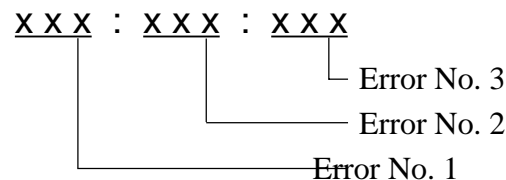

### Possible Solutions

- Check if the GP's Power Cord and the Input signal line have been wired separately from each other.
- Check that the FG line has been grounded correctly, according to your country's standards.
- Re-send the screen data from the PC to the GP.
- If other types of communication errors, such as [RECIEVE DATA ERROR], [PLC COM. ERROR], have also occurred, try to correct those problems also.

### ▼ **Reference** ▲ 6.4.1 Error Message List

If the abovementioned methods do not solve the problem, please contact your local GP distributor.

### ◆ **When OFFLINE mode displays during RUN mode**

When the GP changes to OFFLINE mode without the user first pressing the screen, there is a possibility that the screen data has been damaged. In this case, after the SYSTEM ERROR displays, the screen automatically reverts to OFFLINE mode after about 10 seconds. Run the INITIALIZE MEMORY command and transfer the GP screen data again from your PC.

In most cases, system errors are related to the problems mentioned below.

#### • **Environment Related Problems**

If an error occurs which has no apparent connection to the GP's current operation, the error may be due to the condition of GP's operating environment. This can include noise or electrostatic interference in the power code or the communication line. In this case you need to check if the power code and the communication line wiring and FG grounding are correct.

#### • **Screen Data or Project Data Related Problems**

If an error seems to be caused by a particular GP operation, the error may be related to the screen or project data transferred to the GP. In this case, try sending screen data via the FORCE SYSTEM SETUP feature, which will transfer both the screen data and the project data to the GP.

**Reference** *For details about the FORCE SYSTEM SETUP feature, refer to GP-PRO/PBIII for Windows Ver.3.0 Operation Manual Chapter 11-2-1, Transfer Settings.*

#### • **GP Unit Related Problems**

If disconnecting and then re-connecting the power code corrects an error, the problem may not be related to the GP unit itself. However, to identify if the GP unit has any problems, run the OFFLINE mode's SELF-DIAGNOSIS program.

#### • **Peripheral Equipment Related Problems (When the GP is equipped with a printer I/F)**

If an error occurs only during printout, there may be a problem with the printer. Check the printer cable wiring and the FG line as well as the printer itself.

#### • **When a communication error occurs continuously (When using the Direct Access method)**

If a communication error occurs continuously, the GP may define the error as a system error. In this case you need to solve the problem causing the original communication error.

## ■ ILLEGAL ADDRESS IN SCREEN DATA

Caused by an overlap of addresses.

After the error message, error codes, as listed below will appear. If the error cannot be fixed, please report the error code and details on how the error developed to your local GP distributor.

### ILLEGAL ADDRESS IN SCREEN AREA (00B:XXX:XXX)

Error No. 1  
Error No. 2  
(Refer to Table below)

#### Overlapping Addresses

Error 1	Error 2	Meaning
0C1	191	All or part of the T-tag <sup>*1</sup> or S-tag address range overlap the addresses of System Data Area.
	192	
	193	
0C2	194	All or part of the System Data Area address, A-tag, or S-tag address range overlap the addresses setup in a T-tag. <sup>*1</sup>
	195	
	196	
0C3	197	All or part of a T-tag <sup>*1</sup> , S-tag or K-tag address range overlap the address range set in an A-tag (Alarm Message.)
	198	
	199	
0C9	19B	All or part of a T-tag <sup>*1</sup> , S-tag or K-tag address range overlap the address range set in an A-tag (Log alarm.)



**Note:** Overlapping addresses, other than the ones mentioned above, can also cause the Illegal Address message.

E.g. When the starting address of the System Data Area is set to 100, and the tag below is setup:

Tag Name/ Part ID No.	Word Address	Tag Format
N1	99	BCD32

Starting from addresses 99, two(2) words are used, which causes it to overlap address 100.

<sup>\*1</sup> For details about the T-tag (trend graph) and A-tag (alarm messages),

**Reference** *GP-PRO/PBIII for Windows Tag Reference Manual (included with the screen creation software)*

## Chapter 6 - GP RUN and Errors

### ■ PLC COM. ERROR

Appears when the address setup for tags exceeds the address range used in the host (PLC.) Check the Error Number that appears and use the following table to solve the problem.

PLC COM. ERROR ( 02 : x x )

— Error code (see the table below)

— Constant Value

Error #	Problem	Countermeasure
FC	The communication settings for this unit and the host do not match.	Fix the SIO communication settings to match the host.
FB	The address set on a tag, the address used for storing data for Trend graph, or the address set by an alarm message is out of a set range. (address range error) * Memory to Memory Link type. * Siemen's PLC Series.	* When using Memory Link type: Set the addresses within the set range of the System Data Area (0 to 2047), and re-send correct data.  * When using a Toyoda Machine Works PLC: Set the addresses within the set range of the devices.  * When using a Yaskawa PLC: Set the addresses within the set range of the devices.
FA	Address range error	Set the addresses within the allowable range.
53	When using a Matsushita Electronics PLC, and there are too many screen tags, the PLC will not receive data.	Decrease the number of tags on the screen.
51	The tag addresses, Trend graph data storage address, Alarm message Registry address, do not exist in the PLC's internal memory.	* When using a Fuji Electric PLC: Setup the addresses in a device range that exists.
Others	The Error code for each PLC can be found in the table on the last page of this chapter. Then, look up the Error Number in the indicated PLC manual. Or, report the Error Number to the PLC maker.	



- In Hitachi's HIDIC H (HIZAC H) Series, the error code is divided into 2 bytes, whereas the GP Error Number is composed of 1 byte codes.

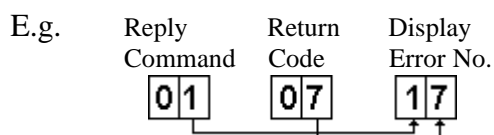

When the Display Error Number is 8\*, or 5\*, use only the left column as the error number.



- In Toshiba's PROSEC T Series, the Error Code is 4 characters long; on the GP, Error Numbers are changed to and displayed in Hexadecimal.
- With the Allen-Bradley PLC-5 and SLC-500 Series, the EXT/STS error codes have been re-mapped to start at D0 HEX, so they will not conflict with other error codes. When looking up the error number in the PLC manual, subtract D0 h from the GP error code to find its error value.

E.g.	<u>GP Error Code</u>	—>	<u>PLC Error Code</u>
	D1		01
	EA		1A

## ■ CLOCK SET UP ERROR \*1

This message displays when the backup battery for the internal clock is running low. If the battery is incorrectly replaced (i.e, its plus and minus sides are reversed,) the battery may explode. Therefore, please do not replace the battery yourself. When the battery needs to be replaced, please contact your local GP distributor.

After changing the backup battery, be sure to set the GP's internal clock.

### **Reference** Chapter 5 - Initializing the GP



The lifetime of the backup battery depends on the ambient temperature and the amount of current being charged and used. The table below gives a general indication of how long the battery will last.

Battery Temperature	Between 40°C to 50°C	Between 50°C to 60°C	Over 60°C
Expected Lifetime	Over 10 years	Over 4.1 years	Over 1.5 years

#### \*1 CLOCK SETUP ERROR

*This error message will appear when the GP's internal backup battery (used for both the internal clock and the backup SRAM when the GP's power cord is not connected) becomes weak and can no longer preserve data.*

*The battery's strength is only checked when the GP is started up, and this error can only be cleared by turning the GP OFF, then ON again.*

*After the GP is turned On again, the battery has sufficient power to back up data for approximately 24 working hours (approx. 3 working days), and will hold it remaining charge for approximately 96 hours (approx. 12 working days).*

## Chapter 6 - GP RUN and Errors

### ■ SCREEN TAG LIMIT EXCEEDED (max. of 384)

When tags are setup beyond the tag limit, all tags in excess of #384 will be disabled. Plus, when tags involve registered Windows and loaded screens, they are disabled in this order: Window Registry, Load Screen.

Additionally:

1. Disabled registered windows start from the last screen used.
2. Disabled loaded screens start from the last screen used.

To correct this problem, reduce the number of tags to within the allowed limit.

### ■ OBJ. PLC HAS NOT BEEN SETUP

The host PLC setup in the Editor program (i.e. the .prw file) does not match the PLC in use. Use the Error Code that follows the error message to select the proper PLC type and correct the GP's INITIALIZE setup data so that it matches this.

OBJ. PLC HAS NOT BEEN SETUP ( XX )

The PLC number (*Hexadecimal*)  
written to the GP's System File



# Chapter 7 Maintenance

1. Regular Cleaning
2. Periodic Check Points
3. Changing the Backlight

## 7.1 Regular Cleaning

### 7.1.1 Cleaning the Display

When the surface or the frame of the display gets dirty, soak a soft cloth in water with a neutral detergent, wring the cloth tightly, and wipe the display.



- Do not use paint thinner, organic solvents, or a strong acid compound to clean the unit.
- Do not use hard or pointed objects to operate the touch-screen panel, since it can damage the panel surface.

### 7.1.2 Moisture Resistant Gasket Replacement

The moisture resistant gasket protects the GP and improves its water resistance.



***A gasket which has been used for a long period of time may have scratches or dirt on it, and could have lost much of its water resistance. Be sure to change the gasket periodically (or when scratches or dirt become visible).***

#### ■ Attaching the Moisture Resistant Gasket

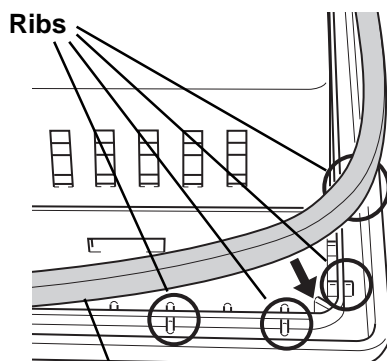

1) Each of the GP's corners has 4 ribs that hold the moisture resistant gasket in place. Push the gasket into the side of the GP, so that it is held by all 4 ribs.



- ***The gasket is flexible, but not elastic, and may tear if stretched too far. Do not stretch the gasket around the ribs, only push.***
- ***Be sure the gasket's seam is not inserted into any of the unit's corners, only in the straight sections of the groove. Inserting it into a corner may lead to its eventually tearing.***

Cross Section View

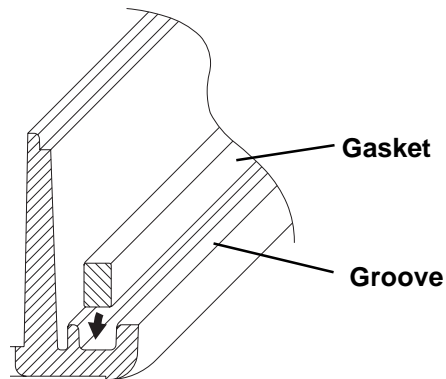

Be sure to insert the packing into the groove so that the long side is vertical.

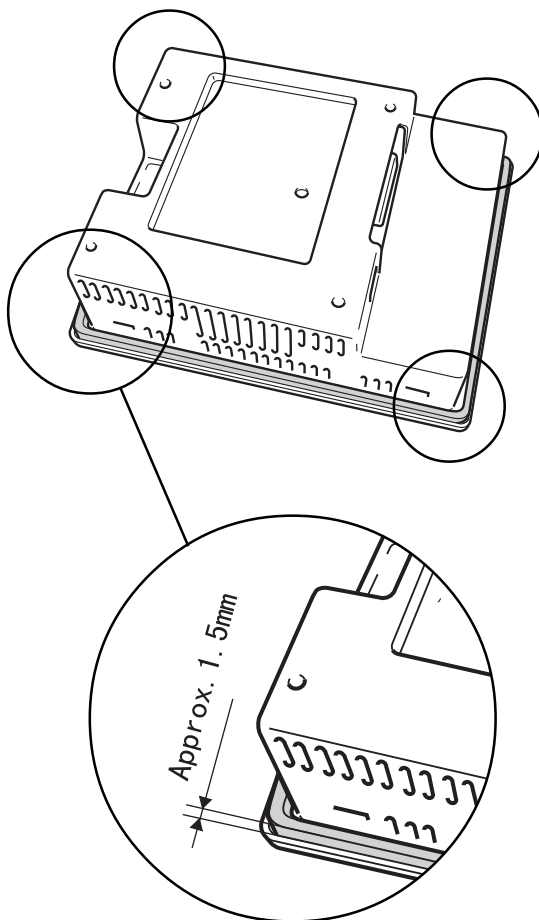

2) Insert the gasket into the GP's three remaining corners, as shown in step 1.



- **The gasket must be inserted correctly into the groove for the GP's moisture resistance to be equivalent to IP65f.**
- **The upper surface of the packing should protrude approximately 1.5mm out from the groove. Be sure to check that the packing is correctly inserted before installing the GP into a panel.**

## 7.2 Periodic Check Points

To keep your GP unit in its best condition, please inspect the following points periodically.

### **GP Operation Environment**

- Is the operating temperature within the allowable range (0 °C to 40 °C)?
- Is the operating humidity within the specified range (20% RH to 85% RH)?
- Is the operating atmosphere free of any corrosive gasses?

### **Electrical Specifications**

- Is the input voltage appropriate (DC24V±15%) ?

### **Related Items**

- Are all cables connected properly? Are they loose?
- Are all mounting brackets holding the unit securely?
- Are there many scratches or traces of dirt on the moisture resistant gasket?

## 7.3 Changing the Backlight

GP377RT series unit backlights are not user replaceable.

When the backlight burns out, the GP's Status LED (orange lamp) turns ON, and if the "OFFLINE" menu's [USE TOUCH PANEL AFTER BACK-LIGHT BURNOUT] selection is set to [NO], touch-operation is disabled except "Force Reset".\*1

**▼Reference▲** Chapter 5.4.3 "SET UP TOUCH PANEL"

The GP-377R series backlight uses CFL, and is a long-life type, however the actual life of the backlight unit will vary depending on the GP's operating conditions.

50,000 hour life (appr. 5.7 years) ----- When continuously lit.

In case you need to replace the backlight, contact your nearest GP distributor.

---

\*1 If "OFFLINE" menu's [FORCE RESET] selection is set to [OFF], the "Force Reset" operation will also be disabled.

**▼Reference▲** Chapter 5.4.3 "SET UP TOUCH PANEL"

# Index

- A**
- ALARM MESSAGE ..... 5-20
  - Available Software ..... 1-4
- B**
- BRIGHTNESS SETTING ..... 5-13
  - Buzzer Output ..... 2-6
- C**
- Caution ..... vi
  - Changing the Backlight ..... 7-3
  - CHARACTER STRING DATA Mode List ..... 5-7
  - CHARACTER STRING DATA SETUP ..... 5-7
  - Cleaning the Display ..... 7-1
  - CLOCK SET UP ERROR ..... 6-19
  - COMMUNICATION INTERFACE ..... 5-10
  - COMMUNICATION RATE ..... 5-10
  - COMMUNICATION SETUP ..... 5-11
  - Connecting the GP's Power Cord ..... 3-4
  - Connection List ..... 5-15
  - CONTRAST SETTING ..... 5-13
  - CONTROL ..... 5-10
  - Creating installation openings ..... 3-1
  - CUSTOMIZE SETUP (n:1) ..... 5-16
- D**
- DATA FORMAT ..... 5-6
  - DATA LENGTH ..... 5-10
  - DATA TYPE OF SCREEN NO. .... 5-4
  - Display Features ..... 2-3
  - Display Panel ..... 2-7
  - DISPLAY PATTERN ..... 6-10, 6-11
- E**
- Electrical Specifications ..... 2-1
  - Entering OFFLINE Mode ..... 4-1
  - Environment Related Problems ..... 6-16
  - Environmental Specifications ..... 2-2
  - Error Message Details ..... 6-15
  - Error Message List ..... 6-13
  - Error Messages ..... 6-13
  - Expansion Interface ..... 2-7
  - External Dimensions ..... 2-8
  - External Interfaces ..... 2-4
- F**
- Features and Performance ..... 2-3
  - FEPROM CHECKSUM ..... 6-10
  - FONT SETTING ..... 5-21
  - FRAME BUFFER ..... 6-10, 6-11
  - From Forced Reset ..... 4-2
- G**
- GLOBAL WINDOW ..... 5-6
  - GLOBAL WINDOW ACCESS ..... 5-6
  - GLOBAL WINDOW SETUP ..... 5-6
  - GP Disposal Precautions ..... vi
  - GP SELF-DIAGNOSIS Item List ..... 6-10
  - GP Start-up and Maintenance Precautions ..... vi
  - GP TOUCH MONOPOLIZE ..... 5-18
  - GP Unit Related Problems ..... 6-16
  - GP's Display Panel ..... vii
  - GP-377R Series Models ..... viii
  - Graphic Panel Dimensions ..... 2-8
  - Grounding the GP ..... 3-5
- I**
- ILLEGAL ADDRESS IN SCREEN DATA ..... 6-17
  - INITIAL SCREEN NO. .... 5-20
  - Initialization Items ..... 5-2
  - Initialization Screen ..... 5-1
  - INITIALIZE INTERNAL MEMORY ..... 5-19
  - INITIALIZE-tandard Operation ..... 4-4
  - Initializing the GP ..... 5-1
  - INPUT PORT ..... 6-10, 6-11
  - Installation ..... 3-1
  - Installation Direction ..... 3-3
  - Installation Fasteners ..... 2-8
  - Installation Mounting Hole Dimensions ..... 2-9
  - Installation Precautions ..... vi
  - Interface Specifications ..... 2-5
  - INTERNAL FEPROM CHECKSUM ..... 6-11
  - IP65f ..... ix

# Index

## K

KANJI FONT QUALITY ..... 5-21

## M

Maintenance ..... 7-1

Moisture Resistant Gasket Replacement ..... 7-1

MONOPOLIZE TIME (0 to 2550s) ..... 5-18

## N

Names and Functions of GP Parts ..... 2-7

NETWORK INFORMATION (DEV/ADR) ..... 5-15

No Display ..... 6-3

No GP/HOST Communication ..... 6-3

No GP/Host Communication ..... 6-7

## O

OBJ. PLC HAS NOT BEEN SETUP ..... 6-20

OFFLINE displays During RUN Mode ..... 6-3

OFFLINE Mode ..... 4-1

OFFLINE Mode's Main Menu ..... 4-3

ONLINE ERror Display ..... 5-20

Optional Equipment ..... 1-4

Optional Maintenance Items ..... 1-5

Options ..... 1-5

Overlapping Addresses ..... 6-17

## P

PLC COM. ERROR ..... 6-18

Package Contents ..... ix

PARITY ..... 5-10

PASSWORD SETUP(0-9999) ..... 5-3

Periodic Check Points ..... 7-2

Peripheral Equipment Related Problems ..... 6-16

Placement of I/O Signal Lines ..... 3-5

PLC PRIORITY ..... 5-17

PLC SETUP ..... 5-14

Possible Types of Trouble ..... 6-3

Power Input Terminal Block ..... 2-7

Preface ..... i

Prevent Damage to the GP ..... vi

Prior to operating the GP ..... 1-1

## R

RECEIVE TIMEOUT ..... 5-11

REGISTRATION NO. (1-256) ..... 5-6

Regular Cleaning ..... 7-1

RESET GP ON WRITE ERROR ..... 5-15

RETRY COUNT ..... 5-11

RUN Mode ..... 6-1

RUN Mode and Errors ..... 6-1

## S

SELF-DIAGNOSIS - Details ..... 6-11

Safety Precautions ..... v

Screen Data or Project Data Related Problems .. 6-16

Screen Memory ..... 2-3

SCREEN TAG LIMIT EXCEEDED ..... 6-20

Securing the Installaiton Fasteners ..... 3-3

SELF-DIAGNOSIS ..... 6-10

SELF-DIAGNOSIS-tandard Operation ..... 4-6

Separately Sold Manual ..... ix

Serial Interface ..... 1-4, 2-5, 2-7

SET UP I/O ..... 5-10

SET UP OPERATION SURROUNDINGS ..... 5-14

SET UP SCREEN ..... 5-20

SET UP TIME ..... 5-19

SET UP TOUCH PANEL ..... 5-12

SIO CHECK ..... 6-10, 6-12

Specifications ..... 2-1

STAND-BY MODE TIME (0-255) ..... 5-3

START TIME (0-255) ..... 5-3

STATION NO. (0-15) ..... 5-16

STATION SETUP (n:1) ..... 5-15

Status LED ..... 2-7

Steps to run SYSTEM RESET ..... 5-12

Structural Specifications ..... 2-1

Symbol Information ..... x

SYSTEM AREA READ SIZE (0-256) ..... 5-14

SYSTEM AREA SETUP ..... 5-4

System Area Size ..... 5-4

SYSTEM AREA START (DEV/ ADR) ..... 5-14

System Design ..... 1-2

SYSTEM ENVIRONMENT SETUP ..... 5-3

SYSTEM ERROR ..... 6-15

SYSTEM ERROR ( 03 : x x ) ..... 6-15

SYSTEM ERROR ( x x x : x x x : x x x ) ..... 6-15

SYSTEM RESET MODE ..... 5-12

SYSTEM SETUP ..... 5-3

**T**

TOOL CONNECTOR ..... 6-10, 6-12  
 Tool Connector ..... 1-4, 2-7, 3-6  
 TOUCH BUZZER SOUND ..... 5-3  
 TOUCH OPERATION MODE ..... 5-12  
 TOUCH PANEL ..... 6-10, 6-11  
 Touch Panel ..... 2-7  
 Touch Panel / Clock Accuracy ..... 2-4  
 Touch Panel Does Not Respond ..... 6-3, 6-9  
 Transferring Screen Data ..... 4-8  
 Troubleshooting ..... 6-3  
 Troubleshooting Checklists ..... 6-4  
 Turning the GP's Power ON ..... 4-1

**U**

UNIT NO. .... 5-14  
 USE TOUCH PANEL AFTER BACKLIGHT BURNOUT ..... 5-13

**V**

Validation List ..... 5-16

**W**

Warning ..... v  
 When a communication error occurs continuously .... 6-16  
 When OFFLINE mode displays during RUN mode .. 6-16  
 WINDOW LOCATION ..... 5-6  
 Wiring Cautions ..... 3-4  
 Wiring Precautions ..... vi

*MEMO*

