

PS-3710A Series  
Hardware Manual

# Preface

Thank you for purchasing Pro-face's PS-3710A Series (Hereafter referred to as the "PS-A unit").

Before operating your PS-A unit, be sure to read this manual to familiarize yourself with the PS-A unit's operation procedures and features.

## NOTICE

1. Copying this manual's contents, either in whole or in part, is prohibited without the express permission of Digital Electronics Corporation, Japan.
2. The information contained in this manual is subject to change without notice.
3. If you should you find any errors or omissions in this document, please contact Digital Electronics Corporation to report your findings.
4. Regardless of Clause 3 above, Digital Electronics Corporation shall not be held responsible for any damages, losses or third-party damages resulting from the use of this product.

© 2007 Copyright Digital Electronics Corporation. All rights reserved.





Product names used in this manual are the trademarks / registered trademarks of their respective owners.

## Essential Safety Precautions

All safety-related procedures stated in this document must be followed to operate the PS-A correctly and safely. Be sure to read this and any related documents thoroughly to understand the correct operation and functions of the PS-A unit.

### Safety Icons

Throughout this manual, these icons provide essential safety information for PS-A operation procedures requiring special attention. These icons indicate the following levels of danger:





 <b>WARNING</b>	Indicates situations where severe bodily injury, death or major equipment damage can occur.
 <b>CAUTION</b>	Indicates situations where slight bodily injury or minor equipment damage can occur.
	Indicates actions or procedures that should NOT be performed.
	Indicates actions or procedures that MUST be performed to ensure correct unit operation.

---

## WARNING

---

### System Design

-  Do not create PS-A touch panel switches that could possibly endanger the safety of personnel or equipment.  
A malfunction of the PS-A unit, its I/O unit(s), cable(s), or other related equipment can cause unexpected output signals, leading to a serious accident. Be sure to design all important machine operation switches so they are operated via a separate control system, and not via the PS-A.
-  Do not create PS-A touch panel switches to control machine safety operations, such as an emergency stop switch. Install these switches as separate hardware switches, otherwise severe bodily injury or equipment damage can occur.
-  Be sure to design your system so that a communication fault between the PS-A and its host controller will not cause equipment to malfunction. This is to prevent any possibility of bodily injury or equipment damage.
-  Do not use the PS-A as a warning device for critical alarms that can cause serious operator injury, machine damage or can halt system operation. Critical alarm indicators and their control/activator units must be designed using stand-alone hardware and/or mechanical interlocks.

- ⊘ Do not use the PS-A with aircraft control devices, aerospace equipment, central trunk data transmission (communication) devices, nuclear power control devices, or medical life support equipment, due to these devices' inherent requirements of extremely high levels of safety and reliability.
- ⚠ Be sure to design your system so that a communication fault between the PS-A and its host controller will not cause equipment to malfunction. This is to prevent any possibility of bodily injury or equipment damage.
- ⊘ After the PS-A unit's backlight burns out the touch panel is still active, unlike the PS-A unit's "Standby Mode". If the operator fails to notice that the backlight is burned out and touches the panel, a potentially dangerous machine operation error can occur. Therefore, do not create PS-A unit touch panel switches that may cause injury and/or equipment damage. If your PS-A unit's backlight suddenly turns OFF, use the following steps to determine if the backlight is actually burned out.
  - 1) If the PS-A unit's "Backlight Control" is not set and the screen has gone blank, your backlight is burned out.
  - 2) If the PS-A unit's "Backlight Control" is set to Standby Mode and the screen has gone blank, and touching the screen or performing another input operation does not cause the display to reappear, your backlight is burned out.

## Handling

- ⊘ Do not disassemble or modify the PS-A unit. Doing so may cause a fire or an electric shock.
- ⊘ Do not operate the PS-A in an environment where flammable gases are present, since it may cause an explosion.

## Wiring

- ⚠ To prevent electrical shock or equipment damage, unplug the PS-A unit's power cord from the power supply prior to installing or wiring the PS-A.
- ⊘ Do not use the voltage not specified in the manual. Doing so may cause a fire or an electric shock.

## Maintenance

- ⊘ Do not connect or disconnect Host and PS-A unit communication cables while the PS-A is turned ON.
- ⊘ The PS-A uses a lithium battery for backing up its internal clock data and the battery may explode if it is replaced incorrectly. When replacement is required, use a Pro-face-designated replacement product. SEE "4.6 Replacing the Internal Battery" (page 4-10)

---



## CAUTION

---

### Installation

-  Be sure all cable connectors are securely attached to the PS-A unit. A loose connection may cause incorrect input or output signals.

### Wiring

-  Be sure to ground the PS-A unit's FG wire separately from other equipment FG lines. Also, be sure to use a grounding resistance of  $100\Omega$  or less and a  $2\text{mm}^2$  [0.0062inch<sup>2</sup>] or thicker wire, or your country's applicable standard. Otherwise, electric shock or malfunctions may result.
-  Be sure to use only the designated torque to tighten the PS-A unit's terminal block screws. If these screws are not tightened firmly, it may cause a short-circuit, fire or incorrect unit operation.
-  Be sure that metal particles and wiring debris do not fall inside the PS-A unit. They can cause a fire, malfunction or incorrect unit operation.





### Maintenance

-  Do not reset or turn the PS-A OFF, or insert or remove the CF Card while the PS-A unit's CF Card or hard disk is being accessed. Otherwise, CF Card and the hard disk internal data may be damaged or lost.

### Unit Disposal

-  When the product is disposed of, it should be done so according to your country's regulations for similar types of industrial waste.

### General Safety Precautions

-  Do not press on the PS-A unit's display with excessive force or with a hard object, since it can damage the display. Also, do not press on the touch panel with a pointed object, such as the tip of a mechanical pencil or a screwdriver, since doing so can damage the touch panel.
-  Do not install the PS-A where the ambient temperature exceeds the specified range. Doing so may cause a unit malfunction.
-  To prevent abnormally high temperatures from occurring inside the PS-A, do not restrict or block the PS-A unit's rear-face ventilation slots.
-  Do not operate the PS-A in areas where large, sudden temperature changes can occur. These changes can cause condensation to form inside the PS-A, possibly causing it to malfunction.
-  Do not allow water, liquids or metal fragments to enter inside the PS-A unit's case, since they can cause either a malfunction or an electric shock. The allowable pollution degree is 2.

- ⊘ Do not operate or store the PS-A in locations where it can be exposed to direct sunlight, high temperatures, excessive dust, moisture or vibration.
- ⊘ Do not operate or store the PS-A where chemicals evaporate, or where chemicals are present in the air.  
Corrosive chemicals: Acids, alkalines, liquids containing salt  
Flammable chemicals: Organic Solvents
- ⊘ Do not use paint thinner or organic solvents to remove dirt or oil from the PS-A unit's surface. Instead, use a soft cloth moistened with a diluted neutral detergent.
- ⊘ Do not use or store the PS-A in areas with direct sunlight, since the sun's ultraviolet rays may cause the LCD's quality to deteriorate.
- ⚠ Do not store the PS-A in an area where the temperature is lower than that recommended in the PS-A unit's specifications. Doing so may cause the LCD display's liquid to congeal, which can damage the LCD.  
  
Also, if the storage area's temperature becomes higher than the specified level, the LCD's liquid may become isotropic, causing irreversible damage to the LCD. Therefore, only store the PS-A in areas where temperatures are within the PS-A unit's specifications.
- ⚠ After turning OFF the PS-A, be sure to wait a few seconds before turning it ON again. The PS-A may not operate correctly if it is restarted too quickly.
- ⚠ Due to the possibility of unexpected accidents, be sure to back up the PS-A unit's data regularly.



## LCD Panel Usage Precautions

- The LCD panel's liquid contains an irritant. If the panel is damaged and any of this liquid contacts your skin, immediately rinse the area with running water for at least 15 minutes. If the liquid gets in your eyes, immediately rinse your eyes with running water for at least 15 minutes and consult a doctor.
- The PS-A unit's LCD screen may flicker or show unevenness in the brightness of certain images or at some contrast settings. This is an LCD characteristics and not a product defect.
- There's an individual difference in brightness and tone of LCD screen. Please be aware of this difference before using the lined-up plural units.
- Some of PS-A unit's LCD screens may contain black and white colored pixels. This is an LCD characteristic and not a product defect.
- Extended shadows, or "Crosstalk" may appear on the sides of screen images. This is an LCD characteristic and not a product defect.
- The color displayed on the PS-A unit's LCD screen may appear different when seen from outside the specified viewing angle. This is an LCD characteristic and not a product defect.
- When the same image is displayed on the PS-A unit's screen for a long period, an afterimage may appear when the image is changed. If this happens, turn off the PS-A, wait 10 seconds and then restart the unit. This is an LCD characteristic and not a product defect.

- To prevent an afterimage:
  - \* Set the PS-A unit's display OFF feature when you plan to display the same screen image for a long period of time.
  - \* Change the screen image periodically and try to not display the same image for a long period of time.



## Information Symbols

This manual uses the following icons:

	Indicates a warning or a product limitation. Be sure to follow the instructions given with this icon to ensure the safe operation of the PS-A.
*	Indicates useful or important supplemental information.
	Contains additional or useful information.
	Indicates pages containing related information.

# Package Contents

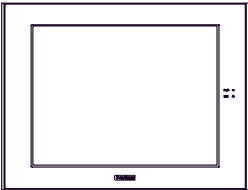
The following items are included in the PS-A unit's package. Before using the PS-A, please check that all items listed here are present.

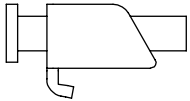
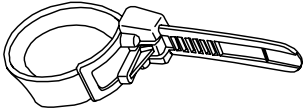
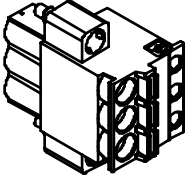
<p>PS-A Unit: 1</p> 	<ul style="list-style-type: none"><li>• Installation Guide</li><li>• Warning/Caution Information (1)</li></ul>	<p>Installation Gasket: 1 (Attached to the PS-A unit)</p> 	<p>Installation Fasteners: 4 per set x2</p> 
<p>USB Cable Clamp: (2ports) 2</p> 			
<p>Power Connector: 1</p> 			

**IMPORTANT**

- Be careful when installing the PS-A not to damage the built-in HDD.

This unit has been carefully packed, with special attention to quality. However, should you find anything damaged or missing, please contact your local PS-A distributor immediately.



## UL/CSA Approval

The following units are UL/CSA listed products. (UL File No.E220851, CSA File No.219866)

Product Model No.	UL/CSA Registration Model No.
PS3710A-T41-PA1	3580301-02

This product conforms to the following standards:

- UL508 Industrial Control Equipment
- CSA-C22.2, No.142-M1987 Standard for Process Control Equipment

### <Cautions>

Be aware of the following items when building the PS-A into an end-use product:

- The PS-A unit's rear face is not approved as an enclosure. When building the PS-A unit into an end-use product, be sure to use an enclosure that satisfies standards as the end-use product's overall enclosure.
- The PS-A unit must be used indoors only.
- Install and operate the PS-A with its front panel facing outwards.
- If the PS-A is mounted so as to cool itself naturally, be sure to install it in a vertical panel. Also, it's recommended that the PS-A should be mounted at least 50 mm away from any other adjacent structures or machine parts. The temperature must be checked on the final product in which the PS-A is installed.
- For use on a flat surface of a Type 4X (Indoor Use Only) and/or 12 Type Enclosure.

## CE Marking

PS3710A-T41-PA1 units are CE marked, EMC directives and Low Voltage Directive compliant products.

They comply with EN55011 Class A, EN61000-6-2 and EN60950-1.

## FCC Statement

United States FCC Part 15, Subpart B, Class A EMI Compliance Statement:

**NOTE:** This equipment has been tested and found to comply with the limits for a Class A digital device, pursuant to part 15 of the FCC Rules. These limits are designed to provide reasonable protection against harmful interference when the equipment is operated in a commercial environment. This equipment generates, uses, and can radiate radio frequency energy and, if not installed and used in accordance with the instruction manual, may cause harmful interference to radio communications. Operation of this equipment in a residential area is likely to cause harmful interference in which case the user will be required to correct the interference at his or her own expense.

# Contents

Preface .....	1
Essential Safety Precautions.....	2
Information Symbols.....	6
Package Contents .....	7
UL/CSA Approval .....	8
CE Marking.....	8
FCC Statement.....	8
Contents .....	9

## Chapter 1 Overview

1.1 System Design.....	1-2
1.1.1 PS-3710A Series .....	1-2
1.2 Accessories .....	1-3
1.2.1 Option Items .....	1-3
1.2.2 Maintenance Items .....	1-3
1.3 Part Names and Functions .....	1-4
1.3.1 PS-3710A Series (PS3710A-T41-PA1).....	1-4
1.4 Prior to Operating the PS-A Unit.....	1-7
1.4.1 Power Supply.....	1-7

## Chapter 2 Specifications

2.1 PS-3710A Series (PS3710A-T41-PA1).....	2-2
2.1.1 General Specifications .....	2-2
2.1.2 Performance Specifications .....	2-5
2.1.3 Interface Specifications.....	2-7
2.1.4 Dimensions .....	2-16

## Chapter 3 Installation and Wiring

3.1 Installation • Uninstallation.....	3-2
3.1.1 Installation.....	3-2
3.2 Peripheral Devices Installation.....	3-6
3.2.1 Removal/Attachment the Rear Cover .....	3-7
3.2.2 PS-A Internal View.....	3-7
3.2.3 Main Memory Installation .....	3-8
3.2.4 Expansion Board (PCI) Installation .....	3-8
3.2.5 PCMCIA Unit Installation .....	3-10
3.2.6 HDD Unit Installation.....	3-12

3.2.7 CF Card Insertion/Removal .....	3-13
3.2.8 USB Cable Clamp Attachment/Removal .....	3-15
3.3 Wiring Precautions.....	3-17
3.3.1 Connecting the Power Cord.....	3-17
3.3.2 Connecting the Power Supply.....	3-19
3.3.3 Grounding .....	3-20
3.3.4 I/O Signal Line Placement .....	3-20

## Chapter 4 Maintenance

4.1 Cleaning the Display.....	4-2
4.2 Cleaning the Fan Filter .....	4-2
4.3 Periodic Check Points.....	4-3
4.4 Replacing the Installation Gasket .....	4-4
4.5 Replacing the Backlight .....	4-6
4.5.1 PS-3710A Series .....	4-7
4.6 Replacing the Internal Battery .....	4-10

# 1 | Overview

1. System Design
2. Accessories
3. Part Names and Functions

This chapter describes peripheral devices that can be connected to PS-A Series units along with the name and functions of each part.

# 1.1 System Design

## 1.1.1 PS-3710A Series

The following diagram illustrates the standard range of items that can be connected to PS3710A-T41-PA1.

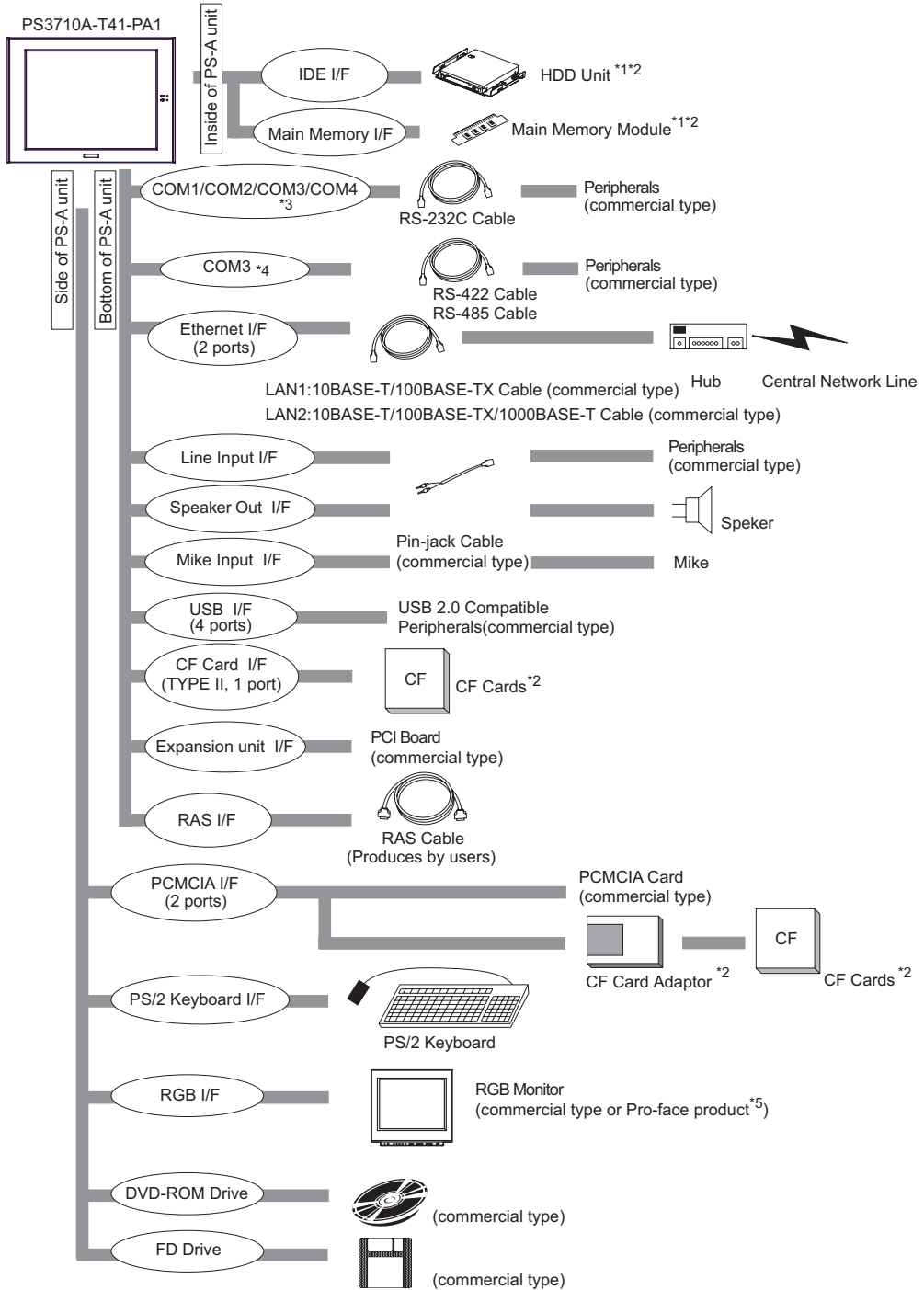

\*1 Built-in accessory only  
 \*2 Digital Electronics Corporation's optional devices and commercial products.  
 Please refer to 1.2 Accessories.  
 \*3 When setting RS-232C mode for COM3.  
 \*4 When setting RS-422 or RS-485 mode for COM3.  
 \*5 RGB monitor is one of the accessories of FP Series manufactured by Pro-face.

## 1.2 Accessories

All accessories listed here are produced by Digital Electronics Corporation.

### 1.2.1 Option Items

Product Name	Model No.	Description
DIM module	PSA-DDR512	Memory module 512M Bytes
	PSA-DDR1G	Memory module 1G Bytes
Hard Disk Unit	PS365XA-HD40	HDD Unit mounted is a Type 2.5" PATA Hard Disk (40G Bytes minimum without OS)
CF Card	CA3-CFCALL/128MB-0	Type 1 128M Bytes
	CA3-CFCALL/256MB-0	Type 1 256M Bytes
	CA3-CFCALL/512MB-0	Type 1 512M Bytes
	CA6-CFCALL/1GB-01	Type 1 1G Bytes
CF Card Adaptor	GP077-CFAD10	CF Card Adaptor for a PCMCIA interface

### 1.2.2 Maintenance Items

Product Name	Model No.	Description
Installation Fastener	CA3-ATFALL-01	Used to install the PS-A into a solid panel (4 pieces per 2 sets).
Installation Gasket	CA3-WPG15-01-PA1	Provides dust and moisture resistance when PS-A is installed into a solid panel.
Replacement Backlight	CA3-BLU15-01	Backlight for replacement
Protective panel sheet	CA3-DFS15-01	Disposable sheet that protects the PS-A unit's screen and prevents from dust. (5 sheets/set) (Hard type)

### 1.3 Part Names and Functions

#### 1.3.1 PS-3710A Series (PS3710A-T41-PA1)

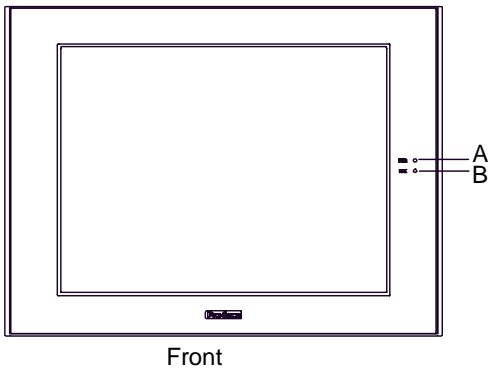

**A: Power LED / RAS Status Lamp (POWER)**

LED	PS-A Status
Green (lit)	Normal Operation (power is on)
Green (blinking)	Soft OFF state
Orange (lit)	System Monitor Error Touch Panel Self Test Error
Orange/Red (blinking)	Backlight burnout is detected
Not lit	Power is OFF

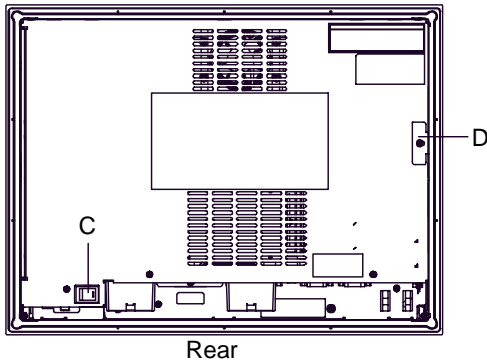

**B: IDE Access Lamp**

LED	PS-A Status
Green (lit)	Currently using IDE I/F

**C: Power Switch**

**D: Expansion Board Support**

**E: FDD Drive**

**F: DVD-ROM Drive**

**G: PCMCIA Interface (PCMCIA)**

2 ports. PCMCIA Type II, Type III can be available.

Corresponding to CARD BUS (Excluding VIDEO

ZOOM, SOUND functions)

**H: Analog RGB Interface**

A mini Dsub 15 pin (plug) is used to connect a RGB monitor on the market or FP Series unit manufactured by Pro-face.

**I: PS/2 Keyboard Interface (KEYBOARD)**

A mini DIN 6 pin (socket) is used.

**J: Rear Cover**

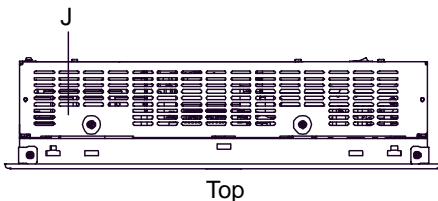
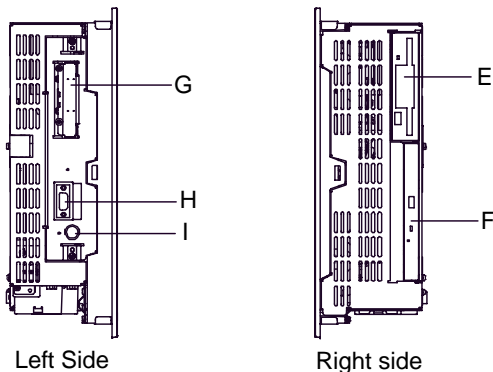

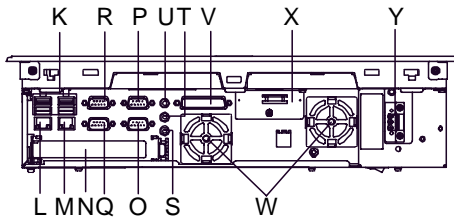

Bottom

**K: USB Interface (USB)**

4 ports. Complies with USB 2.0.

Uses a "TYPE-A" connector.

Power supply voltage	5V DC $\pm 5\%$
Output current	500mA (max.)
The maximum communication distance	5m

**L: Ethernet Interface (LAN1)**

10BASE-T/100BASE-TX Auto Changeover.

This interface uses an RJ-45 type modular jack connector (8 pins).

**M: Ethernet Interface (LAN2)**

10BASE-T/100BASE-TX/1000BASE-T Auto Changeover. This interface uses an RJ-45 type modular jack connector (8 pins).

**N: Expansion unit Interface**

1 port. Used to attach the PCI Unit.

**O: Serial Interface (COM1)**

Dsub 9-pin plug type. RS-232C, RI/+5V Changeover.

**P: Serial Interface (COM2)**

Dsub 9-pin plug type.  
RS-232C, RI/+5V Changeover.

**Q: Serial Interface (COM3)**

Dsub 9-pin plug type.  
RS-232C, RS-422, RS-485 Changeover.

**R: Serial Interface (COM4)**

Dsub 9-pin plug type. RS-232C.  
Changes the Touch Panel communication method.  
(Serial <---> USB)

**S: Line Input Interface (LINE IN)**

1 port. (standard type AUDIO jack)

**T: Speaker Output Interface (SPEAKER OUT)**

1 port. (standard type AUDIO jack)

**U: Mike Input Interface (MIC IN)**

1 port. (standard type AUDIO jack)



**V: RAS Interface (RAS)**

D-sub 25-pin plug type.

**W: Cooling FAN**

**X: CF Card Interface Cover**

CF card interface is under the cover. CF card (Type I / II-compliant) is available. IDE-type connection. <sup>\*1</sup>

**Y: Power Connector**

**IMPORTANT**

- When attaching peripheral units to the PS-A, be sure the PS-A's power cord is disconnected from the main power supply.

\*1 Since an IDE-type connection is used, the unit is not hot-swappable. When inserting/removing the CF card, be sure that power is turned OFF.

## 1.4 Prior to Operating the PS-A Unit

### 1.4.1 Power Supply

About states of PS-A's power supply, there are three kinds of states, which are No Energization, Active State (Normal), and Soft OFF State<sup>\*1</sup>. Each state is outlined in the following.

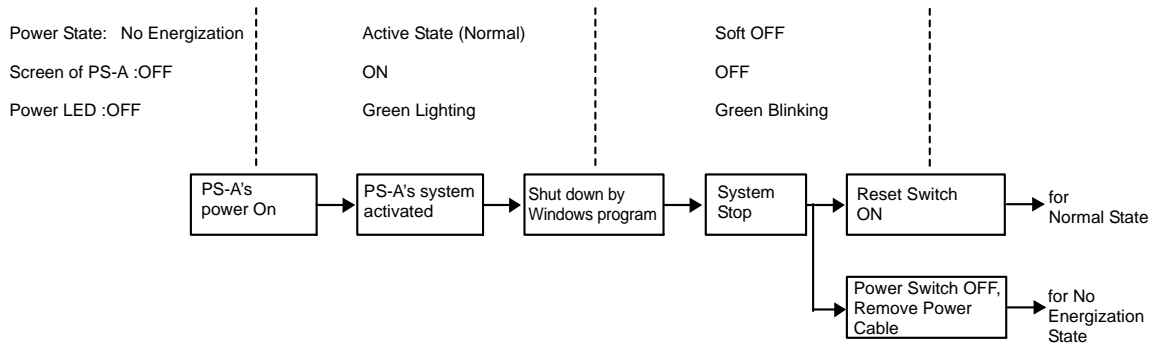

\*1 The Soft OFF refers to the state that Windows<sup>®</sup> has been shut down and the power is provided only for the electric circuit to boot system. This Soft OFF State is different from what is System Standby set by Windows<sup>®</sup>.



# 2 | Specifications

## 1. PS-3710A Series (PS3710A-T41-PA1)

This chapter describes the general, functional and interface specifications of the PS-A as well as its part names and dimensions.

## 2.1 PS-3710A Series (PS3710A-T41-PA1)

### 2.1.1 General Specifications

#### ■ Electrical Specifications

Power Supply	Input Voltage	AC100/240V
	Rated Voltage	AC85 to 265V
	Rated Frequency	50/60Hz
	Allowable Voltage Drop	1 cycle or less (Voltage drop interval must be 1s or more.)
	Power Consumption	150VA or less
Voltage Endurance		AC1500V 20mA for 1minute (between charging and FG terminals)
Insulation Resistance		DC500V 10MΩ(min.) (between charging and FG terminals)

#### ■ Environmental Specifications

Physical	Surrounding Air Temperature	0 to 50°C: without HDD 5 to 50°C: with HDD
	Storage Temperature	-20 to +60°C
	Ambient Humidity	10 to 90%RH (Not condensing, wet bulb temperature: 29°C or less.)
	Storage Humidity	10 to 90%RH (Not condensing, wet bulb temperature: 29°C or less.)
	Dust	Free of dust
	Pollution Degree	For use in Pollution Degree 2 environment
	Corrosive gas	Free of corrosive gases
	Atmosphere (Using height)	800 to 1114hPa (-300 to 2,000 meters above sea-level and below)
Mechanical	Vibration Resistance	<without HDD> IEC61131-2 compliant 5 to 9Hz single-amplitude 3.5mm 9 to 150Hz constant-accelerated velocity 9.8m/s <sup>2</sup> X, Y, Z directions for 10 cycle (100 minute) <with HDD> 4.9m/s <sup>2</sup> (10 to 25Hz X,Y,Z directions for 30 minute)
Electrical	Noise Immunity	Noise Voltage: 1500V <sub>P-P</sub> Pulse Duration: 50ns, 500ns, 1μs Rise Time: 1ns (via noise simulator)
	Electrostatic Discharge Immunity	6kV (complies with EN 61000-4-2 Level 3)
Noise Immunity (Fast Transient Burst Noise)		Power supply line: 2kV (IEC61000-4-4) COM port: 1kV (IEC61000-4-4)

**IMPORTANT**

- When using any of the PS-A's optional devices, be sure to check that device's specifications for any special conditions or cautions that may apply to its use.
- Be aware that not only does the Hard Disk have a fixed lifetime, but that accidents can always occur. Therefore, be sure to back up your Hard Disk's data regularly, or prepare another Hard Disk unit that can be used for backup.
- The Hard Disk lifetime given here may be reduced due to unforeseen environmental factors, however, generally speaking, the disk should last for 20,000 hours (of operation) or approximately 5 years, whichever comes first at an operating temperature of 20°C and 333 hours of operation per month. (HDD access frequency of 20% or less)
- Using the Hard Disk in an environment that is excessively hot and/or humid will shorten the disk's usage lifetime. A wet bulb temperature of 29°C or less is recommended. This is equivalent to the following data.

Temperature	Humidity
at 35°C	no higher than 64% RH
at 40°C	no higher than 44% RH

- In order to extend the lifetime of the hard disk, Pro-face recommends you set the Windows® 2000's [Control panel]-[Power Options]-[Turn off hard disks] selection or the Windows® XP's [Control panel]-[Performance and Maintenance]-[Power Management option]-[Turn off hard disks] selection to turn the hard disk off when the unit is not being operated. A setting of 5 minutes is recommended.

■ Structural Specifications

Installation	Grounding	Grounding resistance of 100Ω 2mm <sup>2</sup> or thicker wire, or your country's applicable standard. (Same for FG and SG terminals)
	Structure*1	Rating: Equivalent to IP65f NEMA #250 TYPE 4X/12 (When installing Panels.) Feature size: All-in-one Installation configuration: Panel embedding
	Cooling Method	Forced cooling by unit fan and CPU fan
	Weight	Approx. 8.0kg [17.6lb] max. (unit only)
	External Dimensions	W410mm [16.14in] X H309mm [12.17in] X D100mm [3.94in]
	Panel Cut Dimensions	W386.1mm [15.20in] X H284.5mm [11.20in]*2 Panel thickness: 1.6 [0.06in] to 10.0mm [0.39in]

\*1 The front face of the PS-A unit, installed in a solid panel, has been tested using conditions equivalent to the standards shown in the specification. Even though the PS-A unit's level of resistance is equivalent to these standards, oils that should have no effect on the PS-A can possibly harm the unit. This can occur in areas where either vaporized oils are present, or where low viscosity cutting oils are allowed to adhere to the unit for long periods of time. If the PS-A's front face protection sheet becomes peeled off, these conditions can lead to the ingress of oil into the PS-A and separate protection measures are suggested.

Also, if non-approved oils are present, it may cause deformation or corrosion of the front panel's plastic cover. Therefore, prior to installing the PS-A be sure to confirm the type of conditions that will be present in the PS-A's operating environment.

If the installation gasket is used for a long period of time, or if the unit and its gasket are removed from the panel, the original level of the protection cannot be guaranteed. To maintain the original protection level, be sure to replace the installation gasket regularly.

\*2 As for dimensional tolerance everything +1/-0mm and R in angle are below R3.

## 2.1.2 Performance Specifications

## ■ Performance Specifications

CPU		Intel® Pentium® M 1.6GHz (Banias)			
L2 Cache Memory		1M Bytes (Built in the CPU)			
Main Memory		2Slots (Max.2GB) SO-DIMM socket 256MB to 1GB (PC2700)			
BIOS		FirstBIOS Embedded Pro (Phoenix Technologies Co.)			
Graphics		XGA (1024 x 768 dots)			
Video Memory		Max.64MB (When using Windows®) UMA Type			
Touch Panel	Type	Resistive Film (Analog)			
	Resolution	1024 x 1024			
	Service Life	1,000,000 times or more, Sweeping 100,000 times or more			
	Interface	COM4	<Switching via hardware> Use the touch panel communication switch to select whether to use the serial communication (COM4) interface or the USB communication interface. *1 (SEE →) ■ Serial Interface (COM1, COM2, COM3, COM4) (page 2-7) ◆ Switches		
	USB	<Switching via Software> When installing the mouse emulator V2 (PL-TD000), select whether to use the serial communication (COM4) interface or the USB communication interface.			
Interface	Serial (RS-232C)	COM1	D-sub 9 pin (plug) (RI/+5V switch possible.)		
		COM2	D-sub 9 pin (plug) (RI/+5V switch possible.)		
		COM3	D-sub 9 pin (plug) (RS-422/RS-485 switch possible.)		
		COM4	D-sub 9 pin (plug)		
	RAS	D-Sub 25 pin (plug) For further details of the RAS function, refer to the "PS-3710A Series Reference Manual".			
	PS/2 Keyboard	PS/2 Interface (mini DIN 6 pin, socket) Side Access, 1 port			
	Analog RGB	A mini Dsub 15 pin (plug) is used to connect a RGB monitor on the market or FP Series unit manufactured by Pro-face.			
	Disk	IDE I/F*2	Master	2.5inch HDD I/F	
			Slave	CF Card I/F	
	USB	USB 2.0 compatible rear 4 ports			
	LAN	Rear 2 ports. This interface uses an RJ-45 type modular jack connector (8 pins). LAN1:auto change to 10BASE-T/100BASE-TX LAN2:auto change to 10BASE-T/100BASE-TX/1000BASE-T			
	PCMCIA	Side 2 ports. PCMCIA Type II, Type III can be available. Corresponding to CARD BUS (Excluding VIDEO ZOOM, SOUND functions)			
Sound	LINE IN, SPEAKER OUT, MIC IN Rear 3 ports (A standard type AUDIO jack is used.)				
PCI	Rev.2.2 compatible PCI I/F (5V) 1 Port				
Floppy Disk Drive	Side Access, For 2-mode 3.5 inch floppy disk drive				
DVD-ROM Drive*3	Side Access, DVD-ROM Drive (connected to IDE Secondary)				
Clock Accuracy*4	±180 sec. /month (fudge factor by the situation temperature and power-off)				



- \*1 If "Serial" is selected, COM4 cannot be used.
- \*2 To change the Master/Slave setting of Primary IDE I/F, set Serial Mode Select switch #9 pin on the circuit board to the desired position.

**SEE →** ◆ *Switches (page 2-10)*

- \*3 Available only for reading CD/DVD-ROM and DVD-VIDEO.
- \*4 The clock, RTC, built-in the PS-A has fudge error. The range if the error will be between +300 and -300 sec. / month, depending on the PS-A's conditions such as life-time usage or temperature difference. If you use the PS-A in a system that takes this error seriously, adjust the clock in regular intervals.

■ Display Functions

Display Type	TFT Color LCD (15 inch)
Pixel Density	1024 x 768 pixels
Dot Pitch	0.297 x 0.297mm
Effective Display Area	304.1 x 228.1mm
Display Colors	260,000 Colors
Backlight's Life Span	CFL (Replaceable) More than 50,000 hours or more of continuous operation
Touch Panel Brightness Adjustment	4 Levels (Adjusted via Windows® Control Panel)
Contrast Control	Not Possible
View Angles	Horizontal Direction: 120 degrees, Vertical Direction: 100 degrees (Contrast ratio: CR is 10 or greater, or TYP value)
Display Service Life	50,000hrs. (at 25°C and 65%RH (humidity))
Backlight Service Life	50,000hrs. or more (at ambient temperature 25°C and continuous operation - period until backlight brightness decreases to 50% or backlight starts to flicker)

■ Expansion Slots

Slot Type	PCI 2.2(5V)			
Board Size	240 x 106.68mm			
Power Supply Capacity	DC5V	DC12V	DC-12V	DC3.3V
Power Consumption	1.5A	0.5A	0.1A	0.5A

### 2.1.3 Interface Specifications

This section describes the specifications of each interface of the PS-3710A Series unit.

#### IMPORTANT

- This PS-A unit's serial port is not isolated. When the host (PLC) unit is also not isolated, and to reduce the risk of damaging the RS-232C/RS-422/RS-485 circuit, be sure to connect the #5 SG (Signal Ground) terminal.

#### ■ Serial Interface (COM1,COM2,COM3,COM4)

Interfit Bracket	#4-40 (Inch screw thread)
------------------	---------------------------

#### ◆ COM1,COM2,COM4

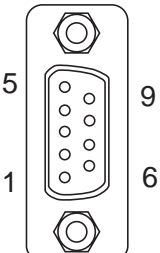
Pin Arrangement	Pin No.	RS-232C		
		Signal Name	Direction	Meaning
 (PS-A side)	1	CD	Input	Carrier Detect
	2	RD(RXD)	Input	Receive Data
	3	SD(TXD)	Output	Send Data
	4	ER(DTR)	Output	Data Terminal Ready
	5	GND	-	Signal Ground
	6	DR(DSR)	Input	Data Set Ready
	7	RS(RTS)	Output	Request to Send
	8	CS(CTS)	Input	Clear to Send
	9	CI(RI)/+5V*1	Input / Output	Called status display / +5V Output (Switching available) (Fixed "RI" for COM4)
	FG	FG	-	Frame Ground (Common with SG)

\*1 To change the RI/+5V setting of #9 pin, open the PS-A unit's rear cover and set slide switch to the desired position.

Please refer to ◆ Switches (page 2-10) for details.

◆ COM3

COM3 can be changed to either RS-232C, RS-422 or RS-485. (The factory setting is RS-232C.) To change this setting, open the PS-A unit's rear cover and set slide switch on the circuit board to the desired position.

**SEE →** ◆ Switches (page 2-10)

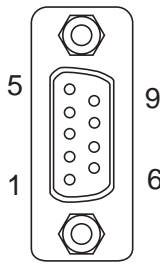
Pin Arrangement	Pin No.	RS-232C		
		Signal Name	Direction	Meaning
 <p>(PS-A side)</p>	1	CD	Input	Carrier Detect
	2	RD(RXD)	Input	Receive Data
	3	SD(TXD)	Output	Send Data
	4	ER(DTR)	Output	Data Terminal Ready
	5	GND	-	Signal Ground
	6	DR(DSR)	Input	Data Set Ready
	7	RS(RTS)	Output	Request to Send
	8	CS(CTS)	Input	Clear to Send
	9	CI(RI)	Input	Called status display
	FG	FG	-	Frame Ground (Common with SG)

Pin No.	RS-422		
	Signal Name	Direction	Meaning
1	RDA	Input	Receive Data A (+)
2	RDB	Input	Receive Data B (-)
3	SDA	Output	Send Data A (+)
4	NC	-	No Connection
5	GND	-	Signal Ground
6	NC	-	No Connection
7	SDB	Output	Send Data B (-)
8	NC	-	No Connection
9	NC	-	No Connection
FG	FG	-	Frame Ground (Common with SG)

Pin No.	RS-485		
	Signal Name	Direction	Meaning
1	DATA +	Input / Output	Send/Receive Data (+)
2	DATA -	Input / Output	Send/Receive Data (+)
3	NC	-	No Connection
4	NC	-	No Connection
5	GND	-	Signal Ground
6	NC	-	No Connection
7	NC	-	No Connection
8	NC	-	No Connection
9	NC	-	No Connection
FG	FG	-	Frame Ground (Common with SG)

**IMPORTANT**

- Do not connect any pins to COM3 [NC].
- Be sure to connect pin number 5 (GND) of COM1, COM2, COM3, and COM4 (RS-232C) to the host unit's Signal Ground terminal.
- Be sure to confirm what settings will be used by the other device and set the slide switches accordingly. Failure to do so can result in a unit malfunction or damage.
- Whenever changing the PS-A switches, be sure to first turn the PS-A's power supply OFF. Failure to do so can cause a PS-A malfunction.
- Connect the FG terminal line to the shell.
- FG and SG terminals are internally connected in the PS-A. When connecting to another device, be sure not to create an SG shorting loop in your system.

◆ Switches

The following switch settings corresponding to each Serial Interface need to be signified. To set the switches which are on the PS-A's circuit board, remove the PS-A's Rear Cover. Please refer to 3.2.1Removal/ Attachment the Rear Cover (page 3-7). The switches are located as follows;

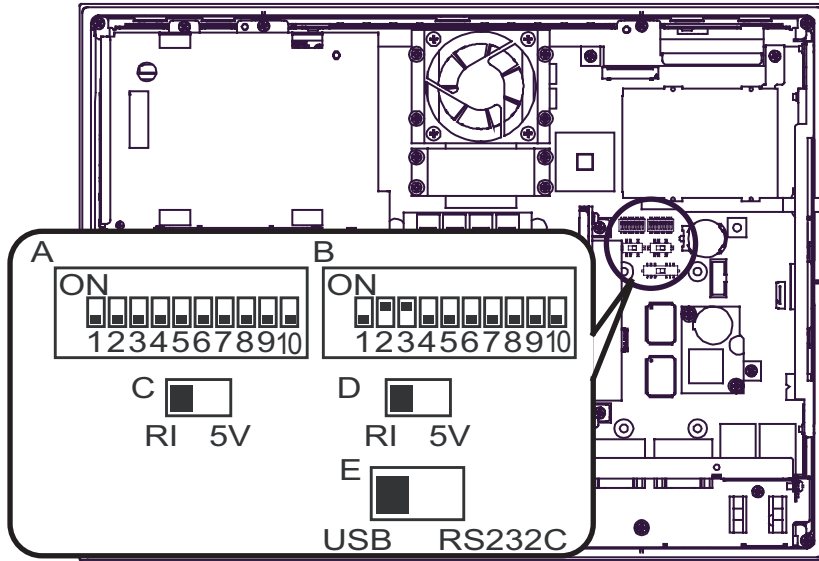

Inside of the rear

Switch Location	Switch Name	Compatible I/F	Factory Settings	Description
A	Serial Mode Select SW	COM3	All OFF (RS-232C)	10-point dip switch. Designates COM3 communication settings. For Serial Mode Select SW details, see Table (2).
B	System Set SW	-	See Table (1)	10-point dip switch. For System Set SW and the factory settings details, see Table (1).
C	RI/+5V Changeover SW	COM1	RI	Changes # 9 pin (RI <---> +5V).
D	RI/+5V Changeover SW	COM2	RI	Changes # 9 pin (RI <---> +5V).
E	Touch Panel's Communication Changeover SW	COM4 USB	USB	Changes the Touch Panel communication method. (Serial <---> USB) (If "Serial" is selected, COM4 cannot be used.)

Switch No.	Description	ON	OFF	Factory Settings	Notes
1	Cancellation function of pushing two points on the touch panel*1.	Enabled	Disabled	OFF	The middle point is not considered to be touched when the SW is ON. It is considered to be touched when the SW is OFF.
2	Changes PIO/DMA of CF card.	PIO+DMA	PIO	ON	
3	Changes PIO/DMA of CF card.	PIO+DMA	PIO	ON	
4	Used for the system.	Reserved	Reserved	OFF	
5	Able to change a Master/Slave setting for CF card slot.	Master	Slave	OFF	
6	Used for the system.	Reserved	Reserved	OFF	
7	Used for the system.	Reserved	Reserved	OFF	
8	Used for the system.	Reserved	Reserved	OFF	
9	Implements the logical inversion operation for RAS output.	Normal Close	Normal Open	OFF	RAS output is a CLOSE state when the SW and the system is ON. When the SW is OFF, it is the opposite. The RAS Output keeps Normal OPEN when the Soft OFF*2 state occurs or the power turns OFF.
10	Used for the system.	Reserved	Reserved	OFF	

Table 1) System Set Switches

- \*1 When two points are pushed, it is considered that middle point between the two points is touched according to the nature of the analog resistive touch panel.
- When the switch, etc. is set on the middle point, it will be enabled and may operate.
- To prevent such a switch from malfunction in case of pushing two points, turn ON the SW No. 1 in advance, then the middle point will be disabled to be touched.
- \*2 The Soft OFF refers to the state that Windows® has been shut down and the power is provided only for the electric circuit to boot system. This Soft OFF State is different from what is System Standby set by Windows®.

Switch Number	Description	ON	OFF	RS-232C	RS-422	RS-485
1	Used by the system.	No Connection	No Connection	OFF* <sup>1</sup>	OFF* <sup>1</sup>	OFF* <sup>1</sup>
2	Changes COM3's communication method	RS-422 / RS-485	RS-232C	OFF	ON	ON
3	Changes COM3's communication method	RS-422 / RS-485	RS-232C	OFF	ON	ON
4	Changes TX data's output mode	TX data output is controlled via the RTS signal.	TX data output is NOT controlled via the RTS signal. (normally output)	OFF	ON/OFF	ON/OFF* <sup>3</sup>
5	Switches the TX termination resistance ON/OFF	Inserts termination resistance of 220Ω between TXA and TXB.	No termination	OFF	ON	ON/OFF * <sup>2</sup>
6	Switches the RX termination resistance ON/OFF	Inserts termination resistance of 220Ω between RXA and RXB.	No termination	OFF	ON	ON/OFF* <sup>2</sup>
7	Switches the shorting of TXA and RXA ON or OFF	Shorts TXA and RXA (RS-485 mode)	No shorting (RS-422 mode)	OFF	OFF	ON
8	Switches the shorting of TXB and RXB ON or OFF	Shorts TXB and RXB (RS-485 mode)	No shorting (RS-422 mode)	OFF	OFF	ON
9	RTS Automatic control mode	The data is automatically controlled via the RTS signal.	The data is not automatically controlled via the RTS signal.	OFF	OFF	ON/OFF* <sup>3</sup>
10	(enabled only when RS-485 mode)					ON/OFF* <sup>3</sup>

Table2) Serial Mode Select Switches

- \*1 Be sure to keep the settings, "OFF".
- \*2 If you use the termination resistance, base your settings on the connection specifications.
- \*3 To control TX output driver via RTS automatically, set ON. Be sure to set SW No.4 OFF.  
To control TX output driver via RTS signal, set OFF. Be sure to set SW No.4 ON.

Serial Mode Select Switches (SW4 to SW10) operate as shown in the circuit diagram below.

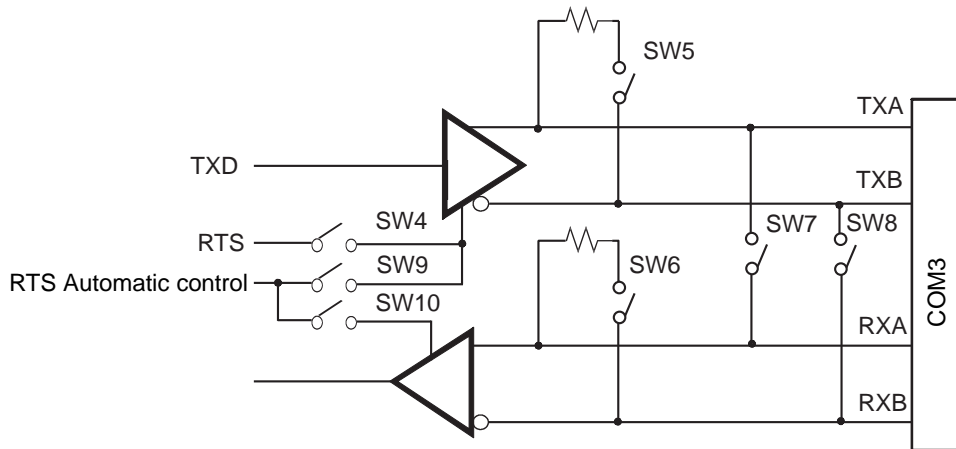



■ RAS Interface

**IMPORTANT**

- Be sure to use only the rated voltage level when using the No. 2, 15 [+5V] and No.3 [+12V] for external power output. Failure to do so can lead to a unit malfunction or accident.

Interfit Bracket	#4-40 (Inch screw thread)
------------------	---------------------------

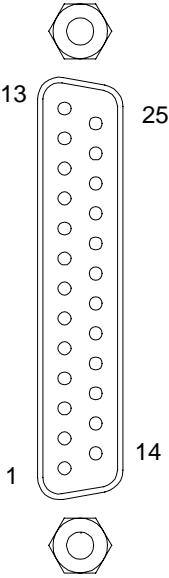
Pin Arrangement	Pin No.	Signal Name	Meaning
 <p>(PS-A side)</p>	1	GND	Ground
	2	+5V	Output Current:100mA or less (with a total of 2 pin and 15 pin) Output Voltage:5V±5%
	3	+12V	Output Current:100mA or less Output Voltage:12V±5%
	4	NC	-
	5	RST(+)	Reset in (+)
	6	DIN0(+)	Data in 0 (+)
	7	DOUT2(-) (UPS Shutdown(-))	Data out 2 (-) (UPS Shutdown (-))
	8	DOUT2(+) (UPS Shutdown(+))	Data out2(+) (UPS Shutdown (+))
	9	DOUT0(-)	Data out 0 (-)
	10	DOUT0(+)	Data out 0 (+)
	11	RST(-)	Reset in (-)
	12	DIN0(-)	Data in 0 (-)
	13	DIN1(+)	Data in 1 (+)
	14	GND	Ground
	15	+5V	Output Current:100mA or less (with a total of 2 pin and 15 pin) Output Voltage:5V±5%
	16	DIN2(+)	Data in2(+)
	17	DIN2(-)	Data in2(-)
	18	DIN3(+)	Data in3(+)
	19	DOUT1(-)	Data out1(-)
	20	DOUT1(+)	Data out1(+)
	21	DOUT3(-)	Data out3(-)
	22	DOUT3(+)	Data out3(+)
	23	DIN3(-)	Data in3(-)
	24	DIN1(-)	Data in1(-)
	25	NC	-

## ◆ Input (DIN 0 to 3, RST)

INPUT VOLTAGE RANGE	DC12 to 24V
INPUT CURRENT	10mA or less
INNER RESISTOR	3.6k $\Omega$ 1/10W
INSULATION	500V or more
SINK SOURCE INPUT	Correspondence

## ◆ Output (DOUT 0 to 3)

OUTPUT VOLTAGE RANGE	DC24V
OUTPUT CURRENT	120mA or less
INSULATION	500V or more
PROTECTION DIODE	Equipped

**NOTE**

- For further details of the RAS function such as the circuit diagram, refer to the “PS-3710A Series Reference Manual”.

## ■ Analog RGB Interface

Mini Dsub 15pin male. As an Analog RGB cable, commercial type or the one manufactured by Pro-face is available to use.

Interfit Bracket

#4-40 (Inch screw thread)

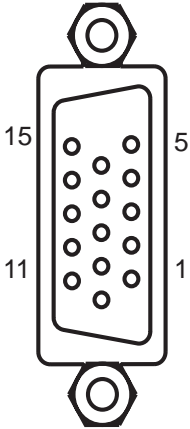
Pin Arrangement	Pin No.	Signal Name	Meaning
	1	Analog R	R signal input
	2	Analog G	G signal input
	3	Analog B	B signal input
	4	Digital grounding	Digital signal GND
	5	Digital grounding	Digital signal GND
	6	Return R	R signal GND
	7	Return G	G signal GND
	8	Return B	B signal GND
	9	Reserved	NC (spare for input)
	10	Reserved	NC (spare for input)
	11	Reserved	NC (spare for input)
	12	DDC DATA	DDC Data
	13	H. SYNC	Horizontal synchronous signal input
	14	V. SYNC	Vertical synchronous signal input
	15	DDC CLOCK	DDC Clock

### 2.1.4 Dimensions

The following dimensions apply to PS-3710A Series.

#### ■ Installation Fasteners Attached Dimensions

Unit: mm[in.]

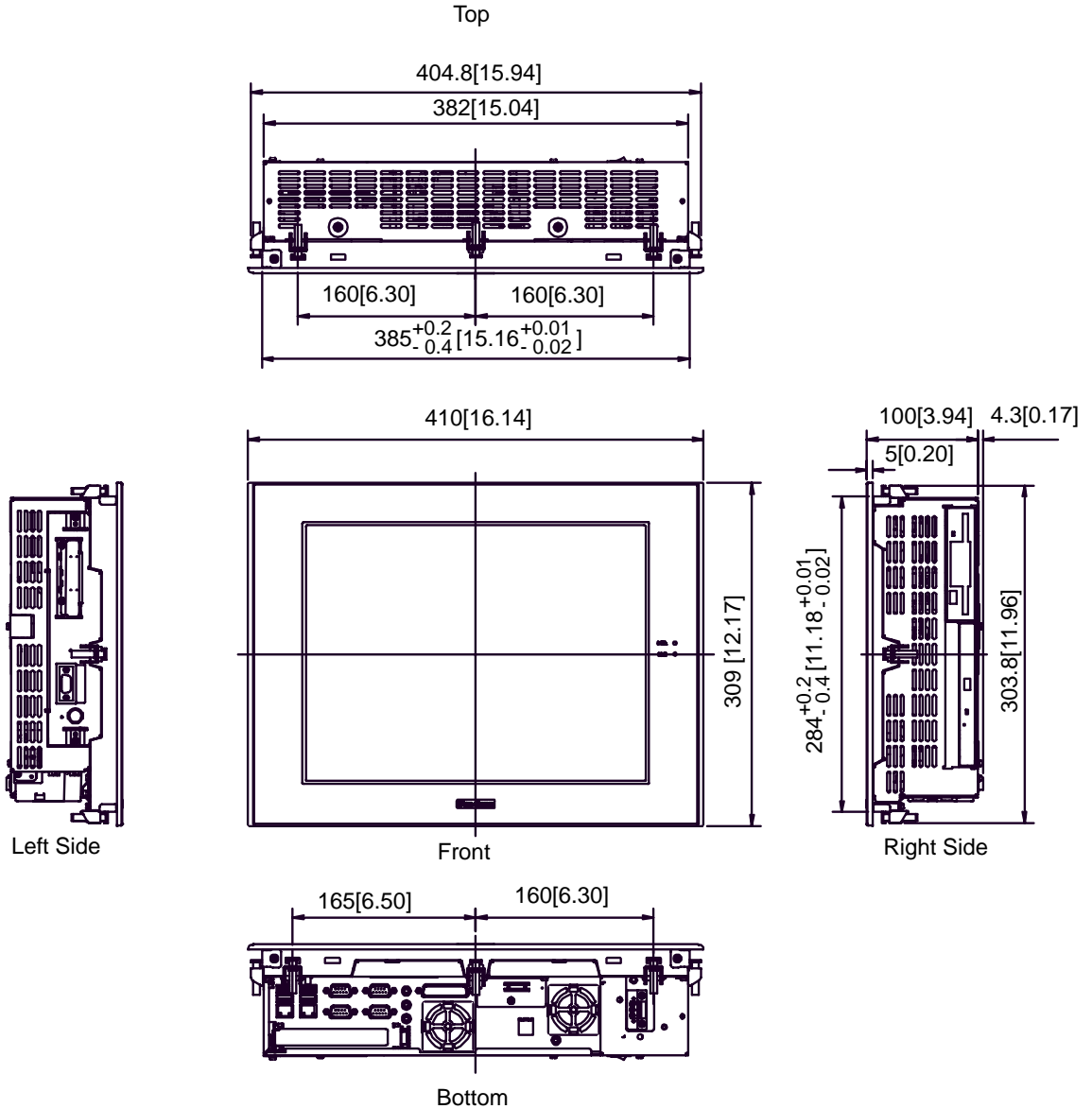

## ■ Cable Attached Dimensions

Unit: mm[in.]

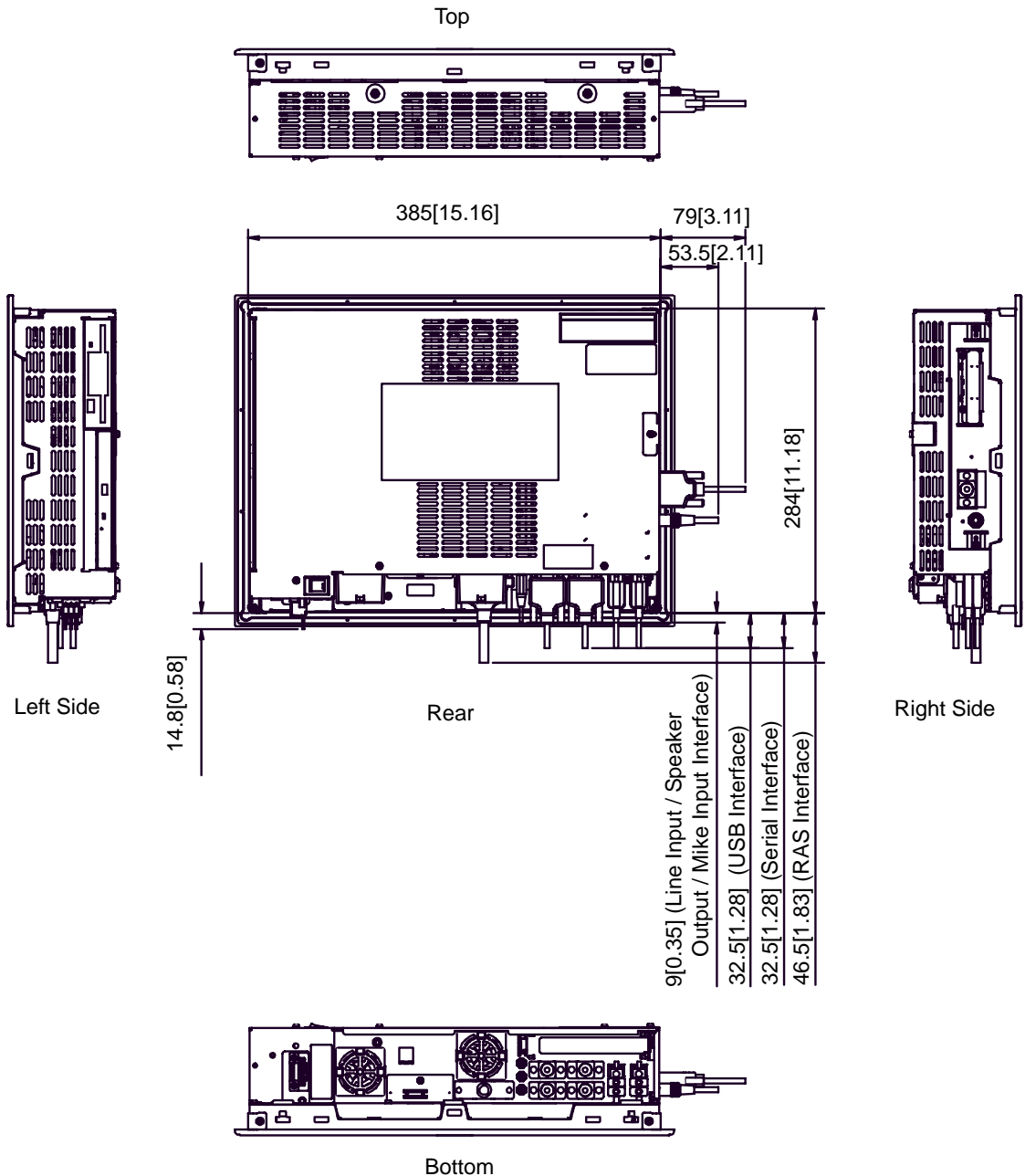

### IMPORTANT

- All the above values are designed in case of cable bending. The dimensions given here are representative values depending on the type of connection cable used. Therefore, they are all intended for reference only.

### ■ Panel Cut Dimensions

Unit: mm[in.]

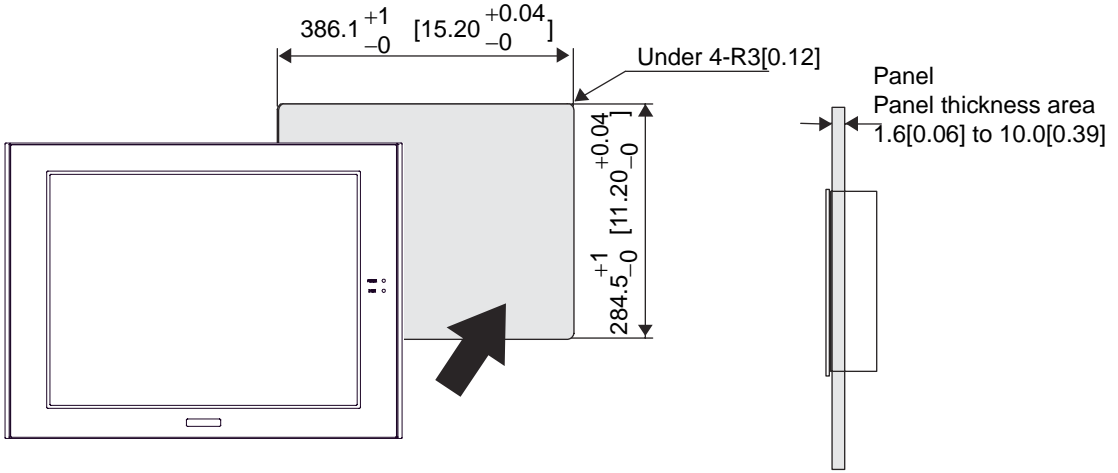

### ■ Installation Fasteners

Unit: mm[in.]

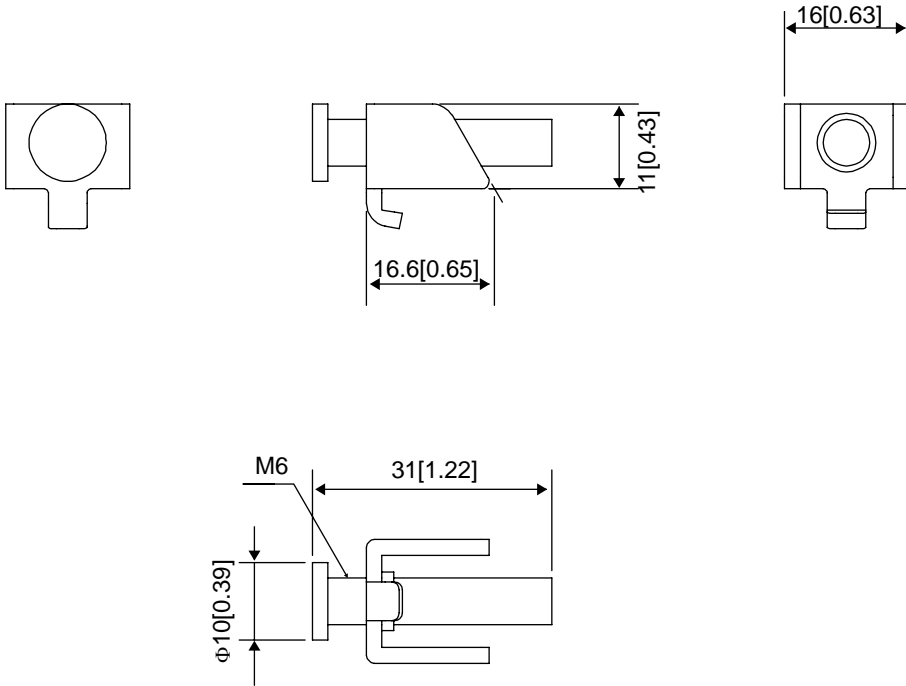

# 3



# Installation and Wiring

1. Installation • Uninstallation
2. Peripheral Devices Installation
3. Wiring Precautions

### 3.1 Installation • Uninstallation

#### 3.1.1 Installation

This section describes the procedures and precautions for installing the PS-A units.

##### ■ Check the Installation Gasket's Seating

It is strongly recommended that you use the installation gasket, since it absorbs vibration in addition to repelling water.

For the procedure for attaching the installation gasket, refer to “4.4 Replacing the Installation Gasket”.

**SEE →** 4.4 Replacing the Installation Gasket (page 4-4)

##### **IMPORTANT**

- Before installing the PS-A into a cabinet or panel, check that the installation gasket is securely attached to the unit.
- A gasket which has been used for a long period of time may have scratches or dirt on it, and could have lost much of its dust and drip resistance. Be sure to change the gasket periodically (or when scratches or dirt become visible).

##### ■ Creating a Panel Cut

Create the correct sized opening required to install the PS-A, using the installation dimensions given.

Determine the panel thickness according to the panel thickness range with due consideration of panel strength.

**SEE →** PS-3710A Series

■ Panel Cut Dimensions (page 2-18)

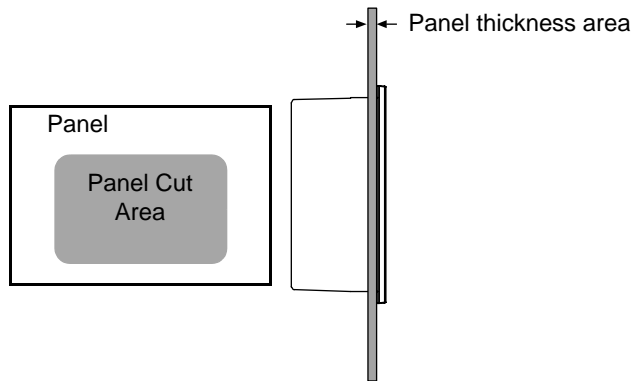

##### **NOTE**

- Check that the installation panel or cabinet's surface is flat, in good condition and has no jagged edges. Also, if desired, metal reinforcing strips can be attached to the inside of the panel, near the Panel Cut, to increase the panel's strength.

■ Installation Requirements

- For easier maintenance, operation, and improved ventilation, be sure to install the PS-A at least 50 mm [1.97 in.] away from adjacent structures and other equipment.

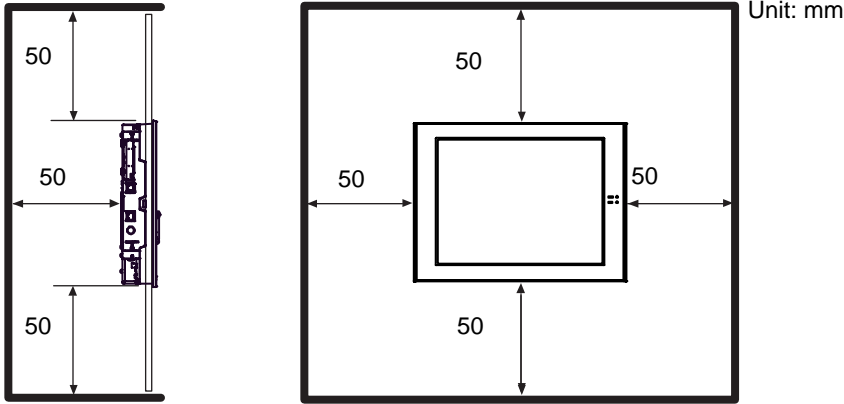

- Be sure that the ambient operation temperature and the ambient humidity are within their designated ranges. When installing the PS-A on the panel of a cabinet or enclosure, “Surrounding air temperature” indicates both the panel face and cabinet or enclosure’s internal temperature.

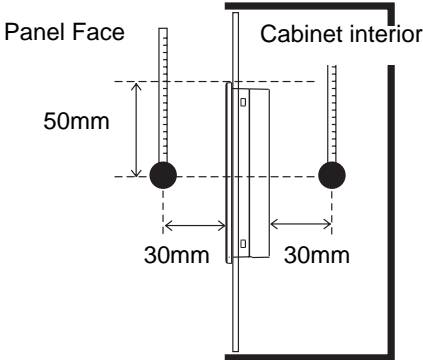

- Be sure that heat from surrounding equipment does not cause the PS-A to exceed its standard operating temperature.
- When installing the PS-A in a slanted panel, the panel face should not incline more than 30°.

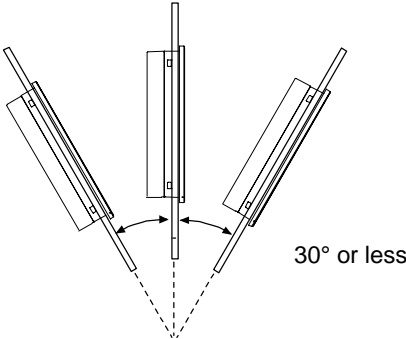



- When installing the PS-A in a slanted panel, and the panel face inclines more than 30°, the surrounding air temperature must not exceed 40°C. You may need to use forced air cooling (fan, A/C) to ensure the surrounding air temperature is 40°C or below.
- The PS-A Series unit does not support longitudinal mounting.

■ Installing the PS-A

- (1) Insert the PS-A into the panel cut, as shown.

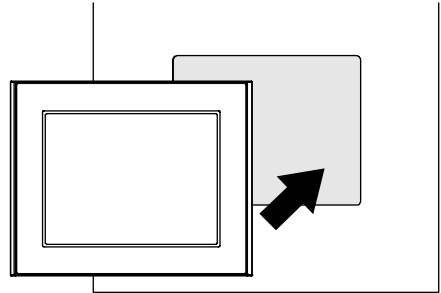

- (2) Insert each fastener's hook into the slot and tighten it with a screwdriver. Insert the installation fasteners securely into the insertion slot recess. There are eight insertion slots.

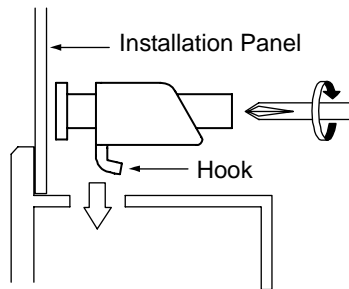
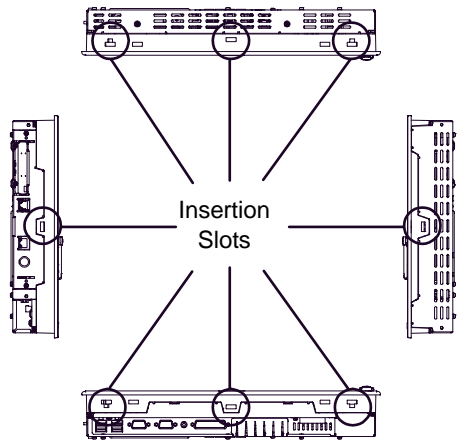

- (3) Insert each of the fasteners, as shown. Be sure to pull the fastener back until it is flush with the rear of the attachment hole.

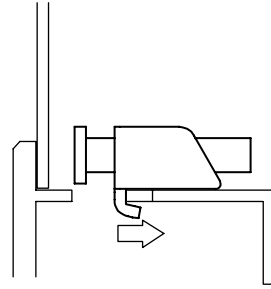

- (4) Use a Phillips screwdriver to tighten each fastener screw and secure the PS-A in place.

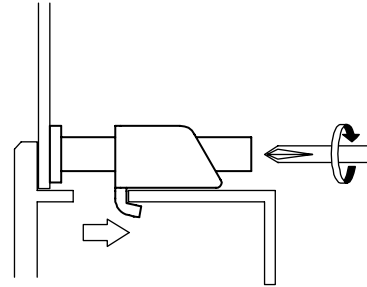
**IMPORTANT**

- Tightening the screws with too much force can damage the PS-A unit's plastic case.
- The torque required to tighten these screws is 0.5 N•m.

## 3.2 Peripheral Devices Installation

A wide variety of optional units, DIM module, CF cards, manufactured by Pro-face and commercial Expansion boards (PCI bus compatible board), PCMCIA (PC cards) can be used with the PS-A.

When installing the optional units, refer to each unit's "Installation Guide".

---

### WARNING

---

-  Be sure to confirm that power is not supplied to the PS-A unit before installing or removing any optional units, DIM module, CF cards, or Expansion boards (PCI boards). Failure to do so can result in an electric shock.

#### **IMPORTANT**

- If the PS-A unit is in the Soft OFF Status, power is supplied to a part of circuits even when no screen is displayed. Be sure to confirm that a power cable is not connected before installing or removing peripheral equipment.
- Use a screwdriver to loosen or tighten the screws. Be sure not to tighten screws too tightly, since it may damage the unit.
- When removing or replacing screws, be careful that they do not fall inside the PS-A unit's chassis.
- When installing the PS-A unit, or when attaching an optional item to the PS-A unit, do not hold the PS-A unit's rear-face fan cover while performing the work. Doing so may damage the fan cover or cause the cover to fall off.

### 3.2.1 Removal/Attachment the Rear Cover

#### **IMPORTANT**

- Use a screwdriver to loosen or tighten the screws. Be sure not to tighten screws too tightly, since it may damage the unit.
- Be careful when removing or inserting any screws that they do not fall inside the PS-A.

#### ■ For PS-3710A Series

Unscrew the five (5) attachment screws used to hold the Rear Cover in place, and remove the Rear Cover. The torque of the rear cover required for these screws is 0.5 to 0.6 N•m.

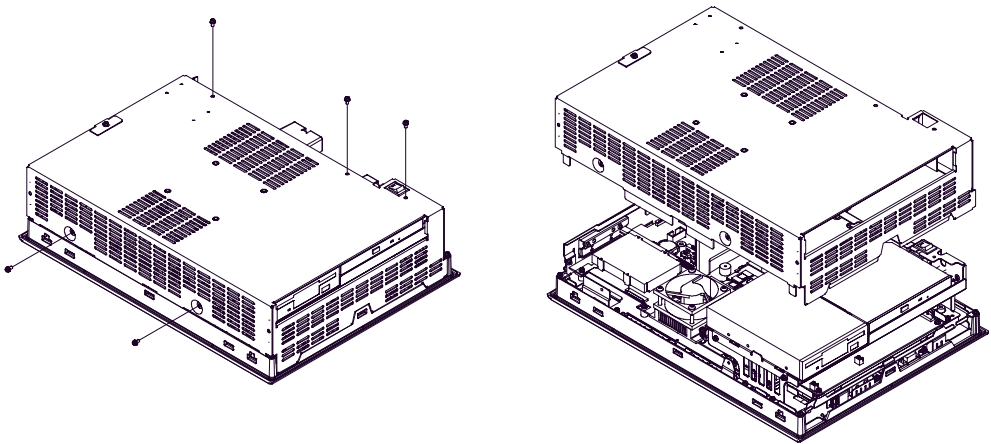

### 3.2.2 PS-A Internal View

#### ■ PS-3710A Series

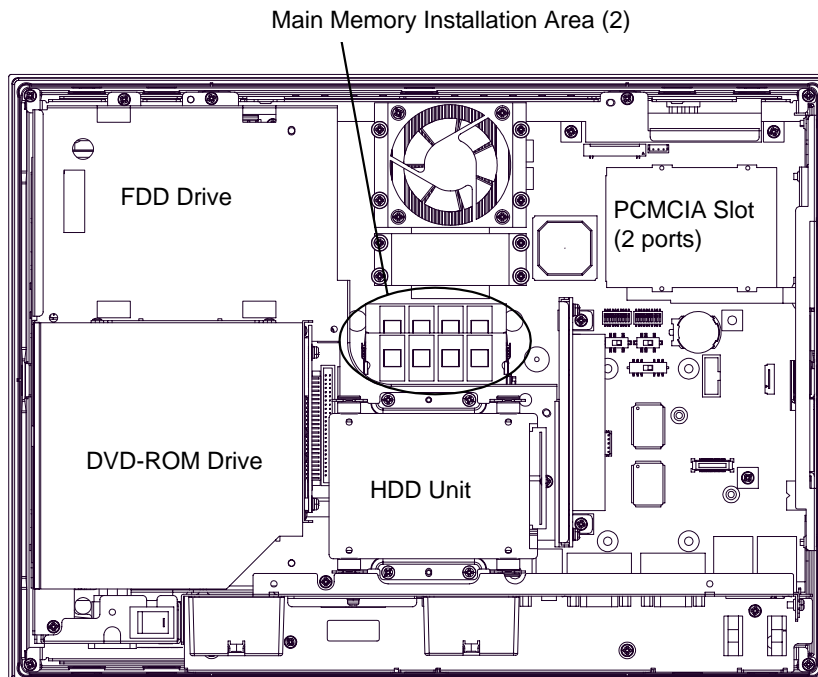

### 3.2.3 Main Memory Installation

- (1) Remove the PS-A unit's rear cover.

**SEE →** 3.2.1 Removal/Attachment the Rear Cover (page 3-7)

- (2) Angle the main memory module down slightly, and push it in until the connector pins mate with the module's pins. Then, lower the module until it is horizontal and insert it completely into the connector. This connector is shown in 3.2.2PS-A Internal View.

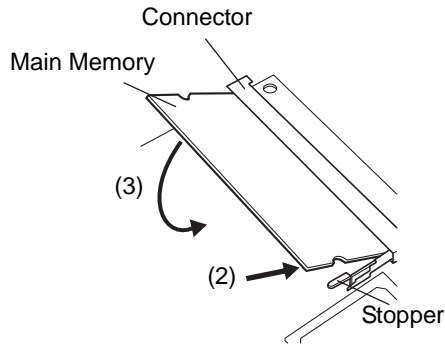

- (3) Push in the main memory module until the stopper snaps into place.

### 3.2.4 Expansion Board (PCI) Installation

**NOTE**

- The Expansion Board (PCI) is corresponding to PS-3710A units.

- (1) Remove the PS-A unit's rear cover.

**SEE →** 3.2.1 Removal/Attachment the Rear Cover (page 3-7)

- (2) Remove the blank panel's screw, and detach the blank panel.

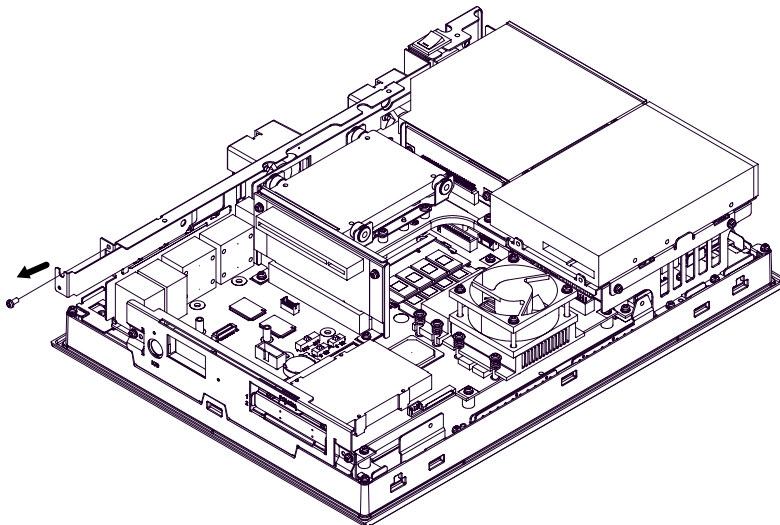

- (3) Insert the expansion board (commercial-type PCI) into the expansion board connector, and secure it in place using the filler panel's screw. The necessary torque is 0.5N•m to 0.6N•m.

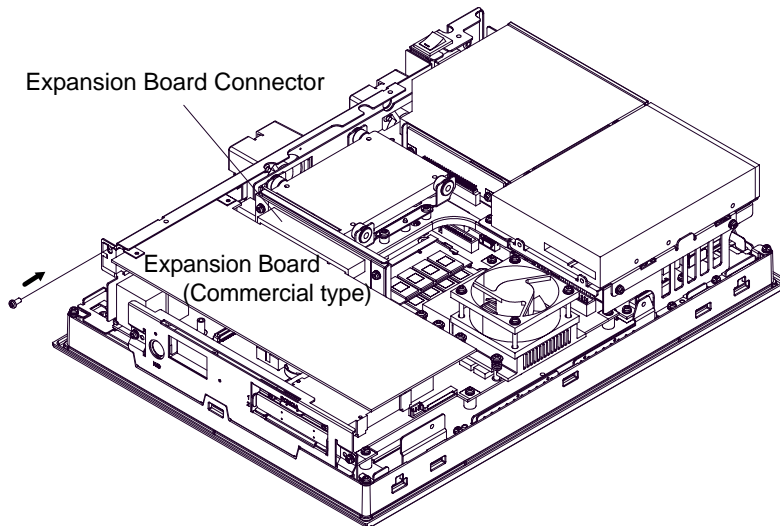
**NOTE**

- The maximum size allowed for an expansion board is 240mm [9.44in.] x 106.68mm [4.2in.]. When using an expansion board of this size, be sure to secure it in place using the expansion board support cover. Before the rear cover is closed, remove the expansion board support cover screw and be sure the expansion board support cover is detached. Next, replace the rear cover, and then secure the expansion board support cover to the rear cover using the expansion board support cover screw. The necessary torque is 0.5N•m to 0.6N•m.

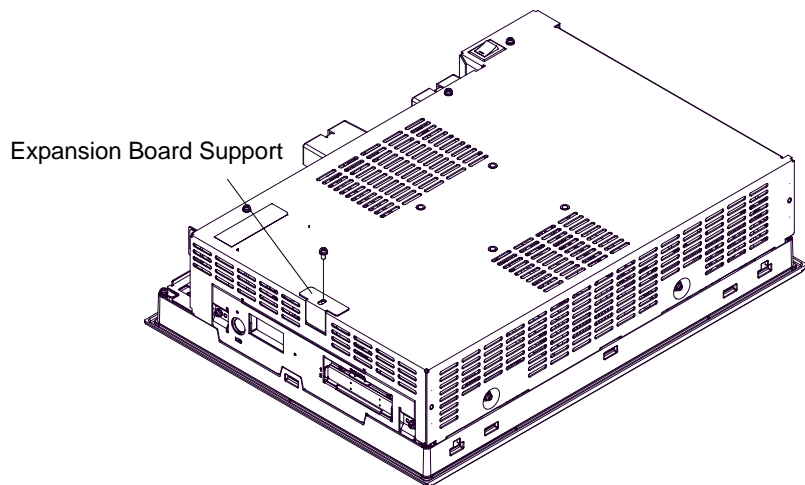

### 3.2.5 PCMCIA Unit Installation

- (1) Remove the PCMCIA slot cover's screws (2).

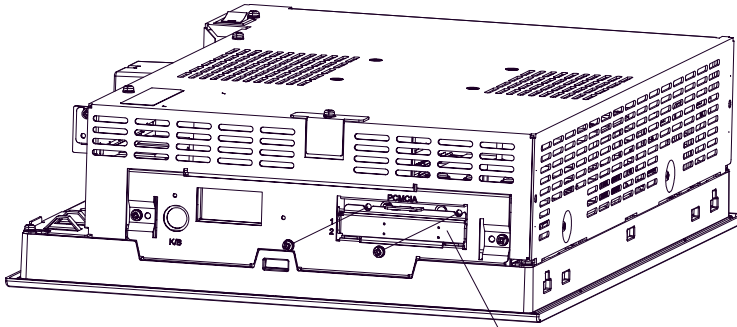

PCMCIA Slot Cover

- (2) [Inserting a commercial-type PC Card]

Insert the commercial-type PC Card into the PCMCIA connector.

**NOTE**

- The PCMCIA slot has 2 connectors. When the PS-A unit is placed as shown below, insert your PC Card with its face up.

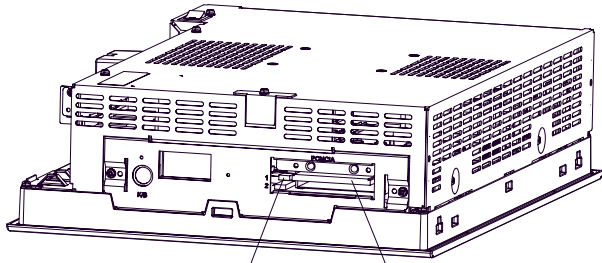

Eject Button

PC Card (commercial)

[Removing the PC Card]

Press the eject button twice to remove the PC Card from the PCMCIA connector.

Pressing the eject button once causes its tip to come out.

Pressing the eject button the second ejects the PC Card from the PCMCIA slot.

- (3) Replace the PCMCIA slot cover removed in (1) and secure it in place using the two PCMCIA slot screws. The necessary torque is 0.5N•m to 0.6N•m.

**IMPORTANT**

- When using a PC Card with a cable attached, Pro-face recommends you use a clamp or other type of device to prevent vibration from possibly dislodging the cable.
- Be sure to stop the PS-A unit PC Card's driver prior to removing the PC Card. A failure to stop this driver may result in damage to either the PC Card, the PC Card's data, or may cause Windows® to hang up. For information on the procedure for stopping the PC Card's driver, please refer to your OS' User Manual.



### 3.2.6 HDD Unit Installation

---

## ⚠ WARNING

---

**!** Shock Danger! Be sure to unplug the PS-A unit from its power supply prior to installing the HDD unit.

**IMPORTANT**

- Since the HDD unit is a precision instrument that has a low resistance to shocks, be sure it is neither hit by nor pressed strongly against another object when installing it.
- Even when the PS-A unit's screen display disappears, the power might be distributed inside (such as the "Standby" status etc.). Be sure to confirm that the power supply switch on the rear side of the PS-A unit is OFF.

■ When attaching the HDD to the PS-3710A

(1) Place the PS-A unit face down and unscrew five (5) attachment screws (See diagram).

**IMPORTANT**

- Be sure to protect the display surface to prevent damage during the operations.

(2) Lift the PS-A unit's Rear Cover off of the PS-A unit.

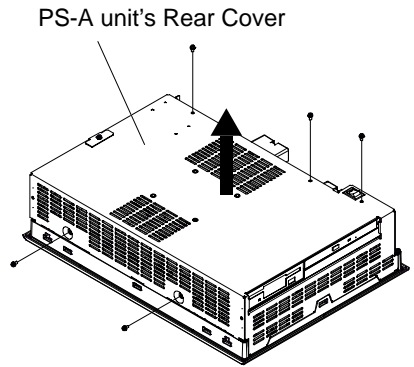

(3) Insert the HDD unit cable connector completely into the IDE I/F. Attach HDD unit using four (4) attachment screws. The torque should be 0.5 to 0.6 N•m.

(4) Replace the PS-A unit's Rear Cover and reattach five (5) attachment screws. The torque should be 0.5 to 0.6 N•m.

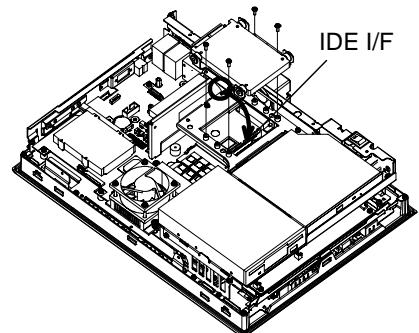







### 3.2.7 CF Card Insertion/Removal

---

## CAUTION

---

-  Prior to inserting or removing a CF Card, be sure to confirm that the PS-A unit is turned OFF. If you do not, CF Card internal data may be damaged or lost or the OS may stop.
-  While a CF Card is being accessed (IDE Access Lamp: Lit in green), NEVER turn OFF or reset the PS-A, or insert or remove the CF Card. If you do not, CF Card internal data may be damaged or lost.
-  Prior to inserting a CF Card, familiarize yourself with the CF Card's front and rear face orientation, as well as the CF Card connector's position. If the CF Card is not correctly positioned when it is inserted into the Multi Unit, the CF Card's internal data, CF Card and the PS-A unit may be damaged or broken.
-  Be sure to use only CF Cards manufactured by the Pro-face. The CF Card's internal data may be damaged when using another manufacturer's CF Card.
-  Once PS-A data is lost, it cannot be recovered. Since accidental data loss can occur at any time, be sure to back up all PS-A screen and CF Card data regularly.
-  Be sure to follow the instructions given below to prevent the CF Card's internal data from being destroyed or a CF Card malfunction from occurring:
  - DO NOT bend the CF Card.
  - DO NOT drop or strike the CF Card against another object.
  - Keep the CF Card dry.
  - DO NOT touch the CF Card connectors.
  - DO NOT disassemble or modify the CF Card.

### ■ When inserting the CF Card

#### ◆ For PS-3710A Series

- (1) Unscrew the CF Card cover's attachment screw (1), and remove the CF Card cover.

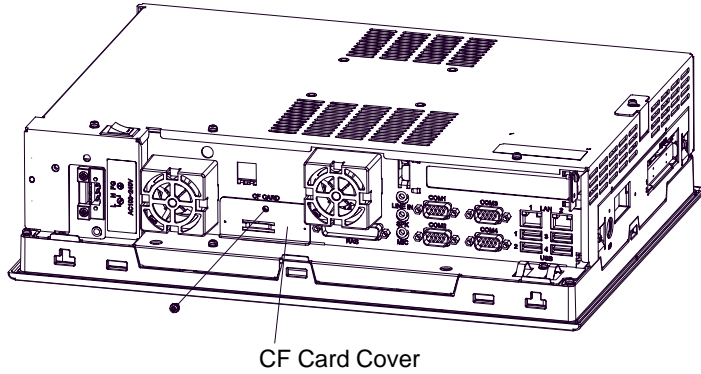

- (2) Insert the CF Card firmly into the CF card slot, and check that the eject button pops out.

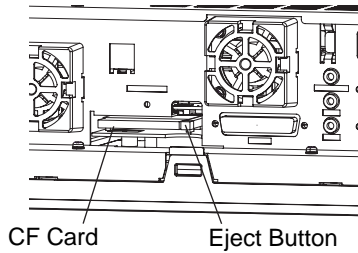

### ■ Removing the CF Card

#### ◆ For PS-3710A Series

- (3) Press the eject button in fully to remove the CF Card from the CF Card slot.
- (4) After inserting/removing the CF card, be sure to replace the CF Card cover and secure it in place using the attachment screw.

**IMPORTANT**

- The necessary torque is 0.5N•m to 0.6N•m.

## ■ Backup of CF Card

The CF Card has a data overwrite limit of approximately 100,000 times. Therefore, be sure to back up all CF card data regularly to another storage media. (100,000 times assumes the overwriting of 500KB of data in DOS format.)

< If your PC is equipped with a PC Card Slot >

- (1) Install the CF card into a CF Card Adapter (GP077-CFAD10) and insert it into a PC card slot of a personal computer.
- (2) Save the data of the CF Card with your personal computer.

<If your PC is NOT equipped with a PC Card slot>

- (1) Use a commercially available PC Card Reader, or a CF Card Reader.

### 3.2.8 USB Cable Clamp Attachment/Removal

This clamp is used to prevent the USB cable connected to the USB Host Interface on the bottom of the PS-A unit from being unplugged due to vibration or other causes.

#### ■ Attachment

- (1) Place the PS-A unit face-down on a flat surface as shown below. Your PS-A unit has four USB connectors.

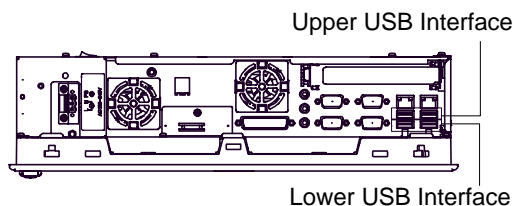

PS-3710A Bottom

#### IMPORTANT

- Be sure to protect the display surface to prevent damage during the operations.

#### NOTE

- When using two or more USB ports, be sure to first connect one USB cable to the lower USB connector, and then connect the second USB cable to the upper USB connector.
- When using only one of the USB ports, be sure to use the lower USB connector. This allows you to securely clamp the USB cable in the cable clamp.

- (2) As shown, insert the USB Cable Clamp's band through the Bridge. Pass the USB cables through the Cable Clamp's band and securely tighten the clamp band around the cables.

**NOTE**

- Be sure the clamp is securely holding the USB cable's plug and collar.
- Be sure the clamp is positioned as shown below, with the clamp pointing upwards - not to the side. This is to keep the clamp from interfering with nearby connectors and their cables.

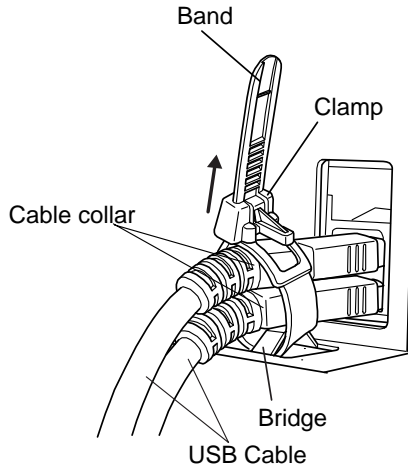

(For PS-3710A)

■ Removing the USB Cable Clamp

- (1) To remove the clamp from the USB cables, push down on the clamp strap's clip to release it while pulling up on the clamp.

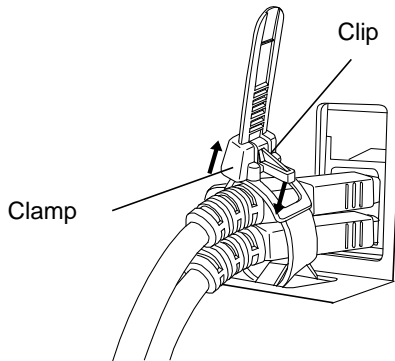

(For PS-3710A)

### 3.3 Wiring Precautions

This section describes the procedures and precautions for wiring power cords.

#### 3.3.1 Connecting the Power Cord

#### ⚠ WARNING

- ⚠ To avoid an electric shock, prior to connecting the PS-A unit's power cord terminals to the power terminal block, confirm that the PS-A unit's power supply is completely turned OFF, via a breaker, or similar unit.
- ⚠ Supplying a power voltage other than that specified will damage the power source and the PS-A unit.
- ⚠ When the FG terminal is connected, be sure the wire is grounded.

#### IMPORTANT

- When the FG terminal is connected, be sure the wire is grounded. Not grounding the PS-A unit will result in excess noise and vibration.
- The SG and FG terminals are connected internally in the PS-A unit.  
When connecting the SG wire to another device, be sure that the design of the system/connection does not produce a shorting loop.

#### ■ For the AC type

#### ⚠ WARNING

- ⚠ The PS-A units is designed to use AC100V to AC240V input. Supplying a power voltage other than that specified will damage the power source and the PS-A unit.

#### Power Cord Specifications

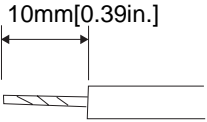
Power Cord Diameter	0.75 to 2.5mm <sup>2</sup> [0.0009 to 0.0097inch <sup>2</sup> ] (18 to 12 AWG)
Conductor Type	Simple or Stranded Wire <sup>*1</sup>
Conductor Length	

<sup>\*1</sup> If the Conductor's end (individual) wires are not twisted correctly, the end wires may either short against each other, or against an electrode.

**IMPORTANT**

- Use copper conductors only.

Wiring

When connecting the power cord, use the following items when performing wiring. (Items are made by Phoenix Contact. \*1)

Recommended Driver	SZS 0.6x3.5 (1205053)
Recommended Pin Terminals	AI 0.75-10GY (3201288) AI 1-10RD (3200182) AI 1.5-10BK (3200195) AI 2.5-12BU (3200962)
Recommended Pin Terminal Crimp Tool	CRIMPFOX ZA3 (1201882)

**NOTE**

- The power connector (plug) is FKC 2.5/3-STF-5.08 made by Phoenix Contact.

\*1 For details, please contact your local Phoenix Contact distributor.

Connecting the Power Cord

- (1) Confirm that the power is not supplied to the PS-A unit.
- (2) Push the Opening button by a small and flat screw driver to open the desired pin hole.
- (3) Insert each pin terminal into its each hole. Release the Opening button to clamp the pin place.

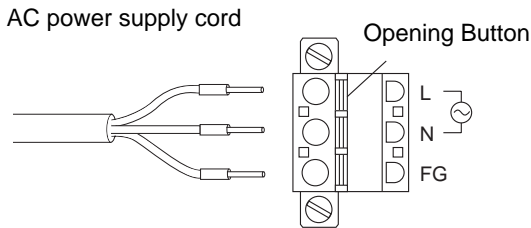

- (4) After inserting all three pins, insert the Power Plug into the Power Connector at PS-A. Fix the plug with two (2) minus screws.

**IMPORTANT**

- Confirm that all wires are connected correctly.
- The torque required to tighten these screws is 0.5 to 0.6N•m.
- To prevent the possibility of a terminal short, use a pin terminal that has an insulating sleeve.

### 3.3.2 Connecting the Power Supply

This section describes the precautions for supplying a power voltage.

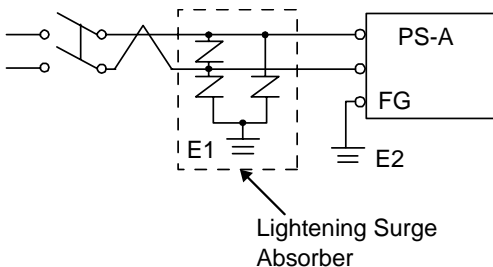
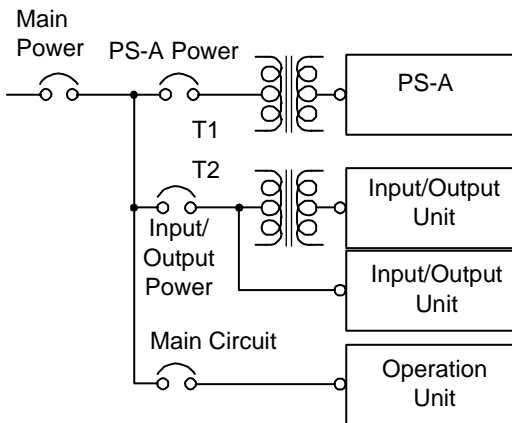
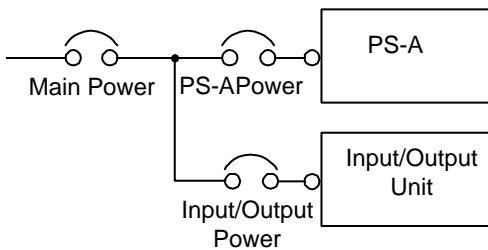
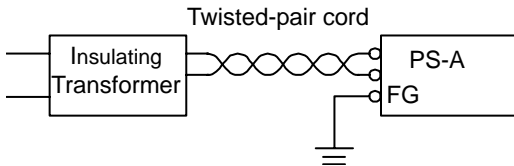
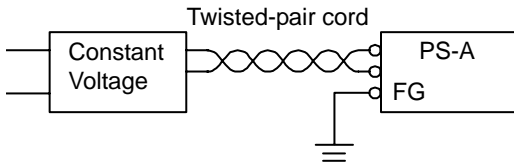

- If the supplied voltage exceeds the PS-A unit's range, connect a constant voltage transformer.

**SEE →** Chapter 2 "Specifications"

- For between the line and ground, select a power supply that is low in noise. If there is an excess amount of noise, connect an insulating transformer.

#### IMPORTANT

- Use constant voltage and insulating transformers with capacities exceeding Power Consumption value.

- When supplying power to the PS-A unit, be sure to separate the input/output and power lines, as shown.
- To increase the noise resistance quality of the power cord, simply twist each power wire before attaching the Ring Terminal.
- The power supply cable must not be bundled or positioned close to main circuit lines (high voltage, high current), or input/output signal lines.
- Connect a lightening surge absorber, as shown in the diagram, to deal with power surges.
- To avoid excess noise, make the power cord as short as possible.

#### IMPORTANT

- Be sure to ground the surge absorber (E1) separately from the PS-A unit (E2).
- Select a surge absorber that has a maximum circuit voltage greater than that of the peak voltage of the power supply.



### 3.3.3 Grounding

This section describes the precautions for grounding the PS-A unit.

## ⚠ CAUTION

❗ Do not use common grounding, since it can lead to an accident or machine breakdown.

#### (a) Exclusive Grounding (BEST)

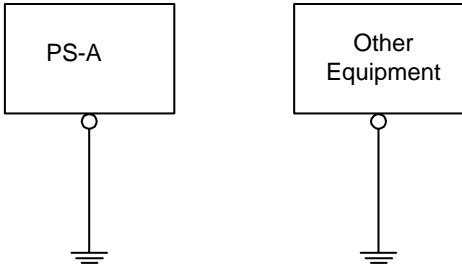

• When supplying power to the PS-A unit, be sure to separate the input/output and power lines, as shown. [diagram (a)]

#### IMPORTANT

- Check that the grounding resistance is 100Ω or less.
- FG and SG terminals are internally connected in the PS-A. When connecting an external device to the PS-A using the SG terminal, be sure to check that no short-circuit loop is created when you setup the system.
- The grounding wire should have a cross sectional area greater than 2mm<sup>2</sup>. Create the grounding point as close to the PS-A unit as possible, and make the wire as short, as possible. When using a long grounding wire, replace the thin wire with a thicker wire, and place it in a duct.

#### (b) Exclusive Grounding (OK)

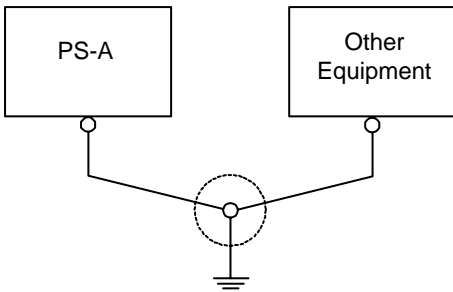

#### (c) Common Grounding (Not OK)

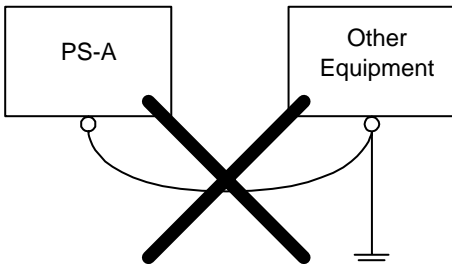

• If exclusive grounding is not possible, use a common grounding point. [diagram (b)] A grounding or equivalent should be used for the grounding point.

#### NOTE

- If the equipment does not function properly when grounded, disconnect the ground wire from the FG terminal.

### 3.3.4 I/O Signal Line Placement

- Input and output signal lines must be separated from the power control cables for operating circuits.
- If this is not possible, use a shielded cable and ground the edge of the shield.

# 4

# Maintenance

1. Cleaning the Display
2. Cleaning the Fan Filter
3. Periodic Check Points
4. Replacing the Installation Gasket
5. Replacing the Backlight
6. Replacing the Internal Battery

This chapter explains cautions and inspection criteria that will ensure trouble-free use of the PS-A.

## 4.1 Cleaning the Display

When the surface or frame of the display become dirty, soak a soft cloth in water with a neutral detergent, wring the cloth tightly, and wipe the display.

**IMPORTANT**

- Do not use paint thinner, organic solvents, or a strong acid compound to clean the unit.
- Do not use hard or pointed objects to operate the touch-screen panel, since it can damage the panel surface.

## 4.2 Cleaning the Fan Filter

Since excessive dirt and dust in the filter of the PS-3710A's electric fan can potentially affect the performance of the unit, regular inspection and cleaning of the filter is strongly recommended.

- (1) Remove the fan cover with pressing in on both fan cover clips.
- (2) Remove the filter from the fan cover.

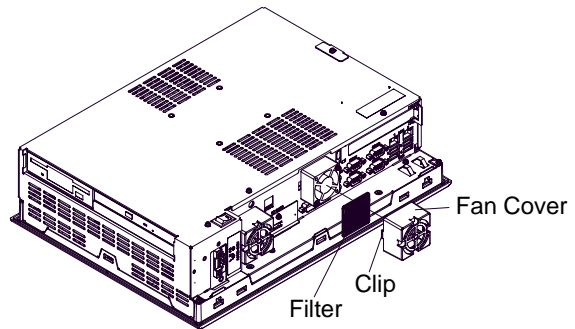

(PS-3710A)

- (3) Clean the filter completely.  
If stubborn dirt or stains are present, wash the filter with a neutral detergent.

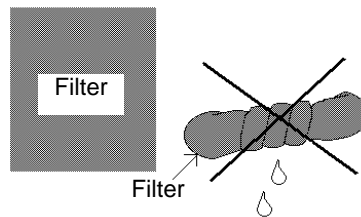

**IMPORTANT**

- Do not wring the filter to dry it.
- When drying the filter, dry it without exposing it to direct sunlight.
- Allow it to air dry completely before reattaching to the PS-A.

- (4) After reattaching the filter to the filter cover, reattach the fan cover with its cover attachment screw.

**IMPORTANT**

- Be sure the fan cover is securely attached to the PS-A unit. This is to ensure the fan cover does not fall off while the PS-A unit is operating.

## 4.3 Periodic Check Points

To keep your PS-A unit in its best condition, please inspect the following points periodically.

### ■ PS-A Operation Environment

Is the operating temperature within the allowable range?

PS-3710A: 0°C to 50°C (without HDD) 5°C to 50°C (with HDD)

Is the operating humidity within the specified range?

PS-3710A: 10 to 90%RH (Not condensing, wet bulb temperature: 29°C or less.)

Is the operating atmosphere free of corrosive gasses?

When using the PS-A unit inside a panel, the ambient environment refers to the interior of the panel.

### ■ Electrical Specifications

Is the input voltage appropriate?

PS-3710A: AC85 to 265V, 50/60Hz

### ■ Related Items

Are all power cords and cables connected properly? Have any become loose?

Are all mounting brackets holding the unit securely?

Are there many scratches or traces of dirt on the installation gasket?

## 4.4 Replacing the Installation Gasket

The installation gasket provides protection against dust and moisture.

**IMPORTANT**

- A gasket which has been used for a long period of time may have scratches or dirt on it, and could have lost much of its water resistance. Be sure to change the gasket at least once a year, or when scratches or dirt become visible.
- The PS-A unit installation gasket's model number is CA3-WPG15-01-PA1.

### ■ Installation Gasket Attachment Procedure

(1) Place the PS-A on a flat, level surface facing the display face downwards.

**IMPORTANT**

- Be sure to protect the display surface to prevent damage during the operations.
- (2) Remove the gasket from the PS-A.
- (3) Attach the new gasket to the PS-A. Be sure to insert the gasket into the PS-A's groove so that the gasket's groove sides are vertical.

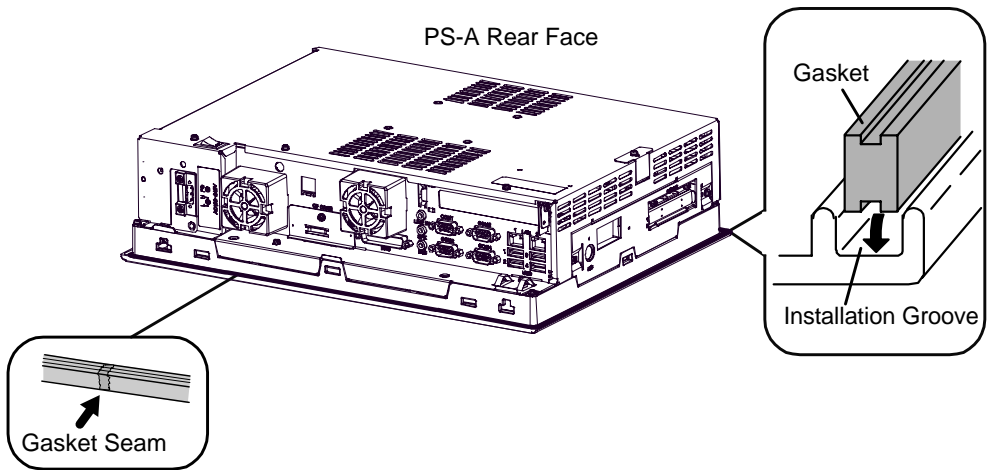

(4) Check that the gasket is attached correctly to the PS-A.

**IMPORTANT**

- The gasket must be inserted correctly into the groove for the PS-A's moisture resistance to be equivalent to IP65f.
- Since the gasket is flexible but not elastic, be careful not to stretch it unnecessarily, as doing so could tear the gasket.
- Be sure the gasket's seam is not inserted into any of the unit's corners, only in the straight sections of the groove. Inserting it into a corner may lead to its eventually tearing.
- To ensure stable resistance against dust and moisture, insert the gasket so that the seam is at the bottom of the PS-A unit.
- The upper surface of the gasket should protrude approximately 2.0 mm out from the groove. Be sure to check that the gasket is correctly inserted before installing the PS-A into a panel.

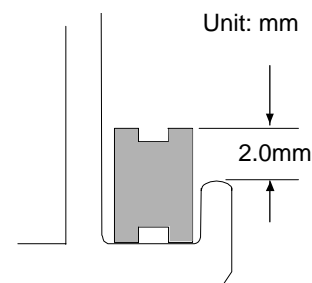

## 4.5 Replacing the Backlight

PS-A units use a CFL, long-life type backlight. The actual life of the backlight however, will vary depending on the PS-A's operating conditions. It is recommended that it be replaced periodically. A PS-A backlight has a life of 50,000 hours (approx. 5.7 years, at 25°C and 24 hour operation), when the backlight is lit continuously (time required for brightness to fall to half its normal level).

### NOTE

- When the LED setting is specified with the RAS control in Control Panel and a backlight burnout is detected, the status LED blinks in orange/red.
- If the backlight or the display unit is damaged, the screen display will go out. Even if the screen goes out, however, there is a possibility that the touch panel is still operating correctly. Therefore, since any type of touch panel contact could have an unexpected or dangerous effect or result, be sure not to touch the screen when this condition occurs.
- A backlight burnout is detected by monitoring the consumed current. Depending on the condition of the backlight, a backlight burnout may not be detected or it may be detected before the backlight burns out completely.

## ⚠ WARNING

### ⚠ [Electric shock]

- Whenever changing the backlight, be sure the PS-A's power cord has been disconnected and that the unit is cooled down.
- When the PS-A's power cord is connected and the PS-A is ON, high voltage runs through the wires in the backlight area, do not touch them!

### ⚠ [Burn]

- When the PS-A's power has just been turned OFF, the backlight area is still very hot! Be sure to wear gloves to prevent being burned.

### ⚠ [Glass]

- The backlight is very fragile. Do not touch the glass tube directly or try to remove its power cord, if the glass tube breaks you may be injured.

### ■ Preparation

Please have the following ready beforehand.

- Replacement backlight (Model:CA3-BLU15-01)
- One pair of clean (preferably new) cotton gloves.
- Phillips screwdriver (no.2)

### 4.5.1 PS-3710A Series

Be sure to wear gloves when exchanging the backlight, and follow the following procedures.

- (1) Turn OFF the power switch of the PS-A and remove the power cable.
- (2) Remove the PS-A unit from the equipment (panel etc.) to which the unit has been incorporated, and place the PS-A unit on a flat, level surface facing the display face downwards.

**IMPORTANT**

- Be sure to perform the backlight changeover on a flat, level surface. This will prevent damage to the PS-A unit and the accidental cutting of any of its power cord.
- Be sure to protect the display surface to prevent damage during the operations.

- (3) Remove the PS-A's rear cover.



3.2.1 Removal/Attachment the Rear Cover (page 3-7)

- (4) Detach the FDD unit cable and power cable from the connector, and remove the two attachment screws to detach the FDD unit.

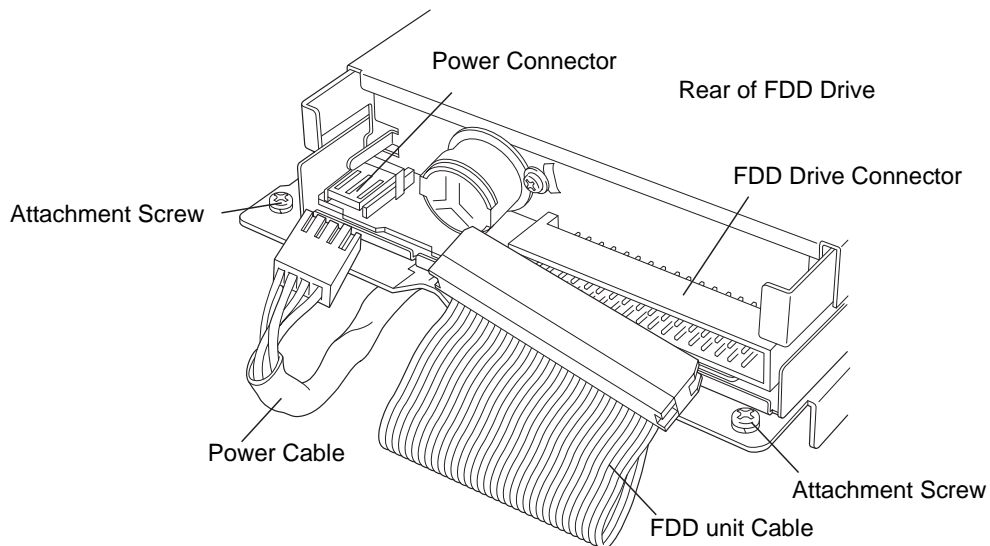



- (5) Insert a screwdriver into the two holes (points) shown below, and remove the backlight attachment screws (1 per hole).

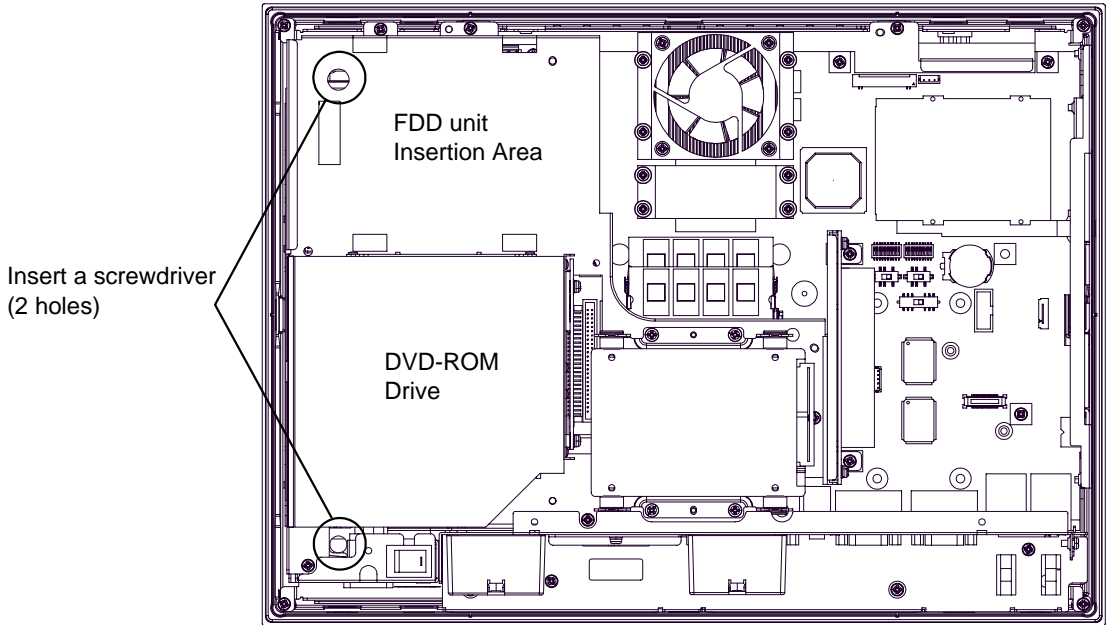

- (6) Remove the cable from the cable clamp, and detach the cable from the backlight connector on the inverter board.

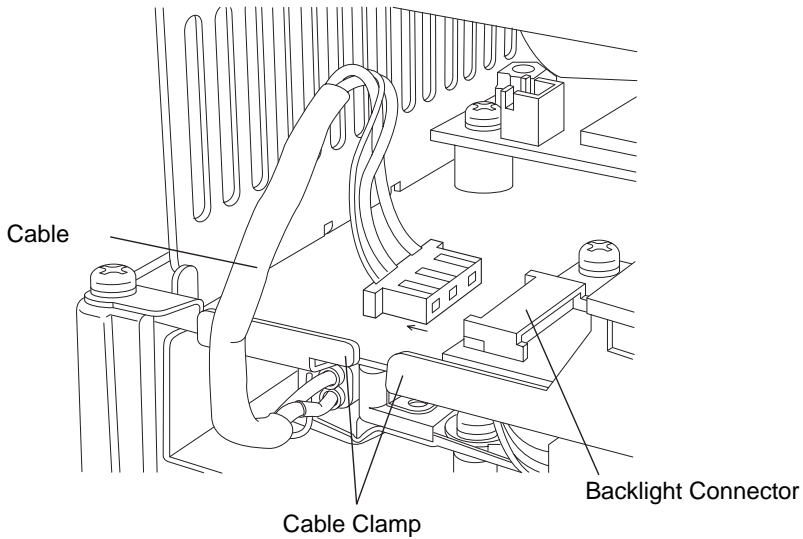

- (7) Pull out the cable in the direction shown by the arrow.

The backlight unit detaches from the backlight unit insertion point.

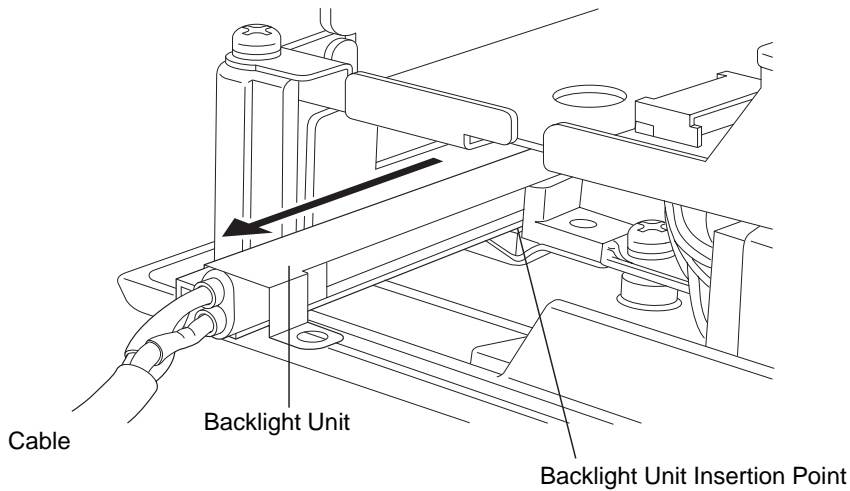

**IMPORTANT**

- The entire backlight unit should be changed, not just the backlight.

- (8) Insert the new backlight unit into the backlight holder.

- (9) Re-attach the cable to the backlight connector, and secure the cable in position using the cable clamp (opposite of step (6)).

**IMPORTANT**

- Be sure the cable is inserted completely into the backlight connector. Failure to do so may cause arcing, which can damage the connector.
- Be sure to always change both of the PS-A backlights at the same time.

- (10) Secure both backlights in place using the backlight screw (opposite of step (5)). The necessary torque is  $0.147\text{N}\cdot\text{m}$  ( $1.5\text{kgf}\cdot\text{cm}$ ).

- (11) Replace the FDD unit in its original position and secure it in place using the two (2) attachment screws. The necessary torque is  $0.5\text{N}\cdot\text{m}$  to  $0.6\text{N}\cdot\text{m}$ . Reconnect the FDD unit cable and power cable (opposite of step (4)).

- (12) Replace the rear cover and secure it in place using the five (5) attachment screws.

**IMPORTANT**

- The cable clamp is used to prevent the cable from being caught inside in the PS-A unit and possibly damaged. Be sure to insert the cable in the cable clamp before replacing the rear cover.

## 4.6 Replacing the Internal Battery

The PS-A unit has an internal battery for backup of internal clock data.

Compatible Battery	Service Life
Lithium Battery CR2032 (Hitachi Maxell, Ltd.)	5 years

**IMPORTANT**

- The expected battery service life is 5 years, however the battery may die before then. It is strongly recommended that you replace the battery regularly.
- When the battery is replaced, a part of the BIOS settings are initialized. Configure the BIOS settings again after replacing the battery.

---

**⚠ CAUTION**

---

- ⚠ There is a danger of explosion if the PS-A unit's battery is incorrectly replaced. This battery should be replaced with equivalent type recommended by Pro-face.
- ⚠ Prior to replacing the battery, be sure to turn OFF the PS-A unit's power.
- ⚠ Be careful not to cause a short circuit.
- ⊘ Do NOT touch any internal parts except the battery and the battery holder.
- ⚠ During the replacement, be extremely careful not to drop the battery onto the PC board inside the PS-A unit. This may cause product failure.
- ⚠ Dispose of used batteries according to the battery manufacturer's instructions.

## ■ Battery Replacement Procedure

The battery is on the PC board inside the PS-A unit. Refer to “3.2.1 Removal/Attachment the Rear Cover (page 3-7)” for how to open the PS-A unit.

- (1) Be sure to confirm that power is not supplied to the PS-A unit and open the unit.

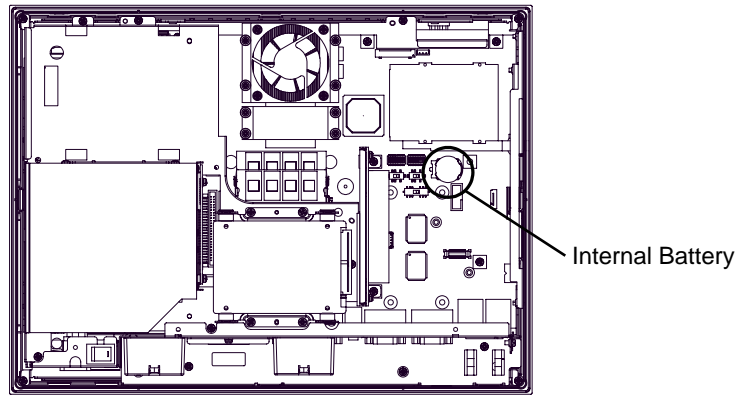

PS-3710A Internal View

- (2) Remove the battery. Push the clip of the battery holder with your finger, the forceps etc. and the battery is pushed up and removed.

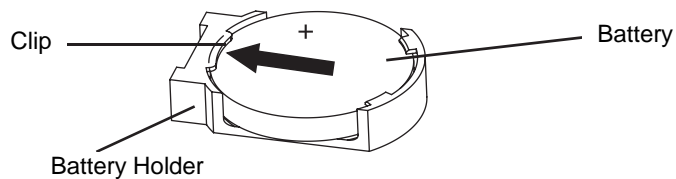

- (3) Insert the new battery. Insert the battery in the side of the clip of the battery holder first with the plus pole (+) facing upward. Push the battery from above until you hear the click to fit it in the battery holder.

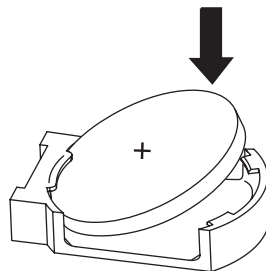

### IMPORTANT

- Be sure the battery's plus(+) and minus(-) sides are correctly oriented.

- (4) Return the PS-A unit to the original condition.

### IMPORTANT

- Be sure to adjust the time of the internal clock after replacing the battery.