



Easy! Smooth!

Replacement Guidebook

LT-3300T → STC-6300TA

The 3rd Edition August 2024

SE01-Guide-LT3300TtoSTC6300TA-EN-03

*Products may be changed or discontinued without notice. Please check our website for the latest information.

Update History

Date	Edition	Updated Slide	Description
2023/07/18	1 st	-	Newly created
2024/03/08	2 nd	19 43,44 49	ATEX/IECEX is supported. Pro-Server EX is supported. One slide is added. "In case of connecting 3 units of TM3 / EX modules with STC6000 Series"
2024/08/23	3 rd	45	Added information of the workarounds for Blink function on STC6000 Series

Legal Information

The Pro-face brand and any trademarks of Schneider Electric SE and its subsidiaries referred to in this guide are the property of Schneider Electric SE or its subsidiaries. All other brands may be trademarks of their respective owners.

This guide and its content are protected under applicable copyright laws and furnished for informational use only. No part of this guide may be reproduced or transmitted in any form or by any means (electronic, mechanical, photocopying, recording, or otherwise), for any purpose, without the prior written permission of Schneider Electric.

Schneider Electric does not grant any right or license for commercial use of the guide or its content, except for a non-exclusive and personal license to consult it on an "as is" basis. Schneider Electric products and equipment should be installed, operated, serviced, and maintained only by qualified personnel.

As standards, specifications, and designs change from time to time, information contained in this guide may be subject to change without notice.

To the extent permitted by applicable law, no responsibility or liability is assumed by Schneider Electric and its subsidiaries for any errors or omissions in the informational content of this material or consequences arising out of or resulting from the use of the information contained herein.

As part of a group of responsible, inclusive companies, we are updating our communications that contain non-inclusive terminology. Until we complete this process, however, our content may still contain standardized industry terms that may be deemed inappropriate by our customers.

Safety Information

Important Information

Read these instructions carefully and look at the equipment to become familiar with the device before trying to install, operate, service, or maintain it. The following special messages may appear throughout this documentation or on the equipment to warn of potential hazards or to call attention to information that clarifies or simplifies a procedure.



The addition of this symbol to a “Danger” or “Warning” safety label indicates that an electrical hazard exists which will result in personal injury if the instructions are not followed.



This is the safety alert symbol. It is used to alert you to potential personal injury hazards. Obey all safety messages that follow this symbol to avoid possible injury or death.

DANGER

DANGER indicates a hazardous situation which, if not avoided, will result in death or serious injury.

CAUTION

CAUTION indicates a hazardous situation which, if not avoided, could result in minor or moderate injury.

WARNING

WARNING indicates a hazardous situation which, if not avoided, could result in death or serious injury.

NOTICE

NOTICE is used to address practices not related to physical injury.

Please Note

Electrical equipment should be installed, operated, serviced, and maintained only by qualified personnel. No responsibility is assumed by Schneider Electric for any consequences arising out of the use of this material.

A qualified person is one who has skills and knowledge related to the construction and operation of electrical equipment and its installation and has received safety training to recognize and avoid the hazards involved.

About this book

Document Scope

This guidebook introduces the procedures to replace a unit from “LT3000 Series” to “STC6000 Series”. The recommended substitute models are as follows.

Model in use			Recommended substitutes	
LT-3300T(5.7”) (Sink)	PFXLT3300TADK (LT3300-T1-D24-K)	→	STC-6300TA(5.7”) (Sink)	PFXSTC6300TADDKE
LT-3300T(5.7”) (Source)	PFXLT3300TADC (LT3300-T1-D24-C)	→	STC-6300TA(5.7”) (Source)	PFXSTC6300TADDCE

Validity Note

This documentation is valid for this product.

The technical characteristics of the device(s) described in the present manual also appear online at www.pro-face.com.

The characteristics that are described in the present document should be the same as those characteristics that appear online. In line with our policy of constant improvement, we may revise content over time to improve clarity and accuracy. If you see a difference between the document and online information, use the online information as your reference.

Registered Trademarks

Product names used in this manual may be the registered trademarks owned by the respective proprietors.

Related Documents

You can download the manuals related to this product, such as the software manual, from our website.

<https://www.proface.com/en/download/search>

Product Related Information

If the equipment is used in a manner not specified by the manufacturer, the protection provided by the equipment may be impaired.

About this book

⚠️⚠️ DANGER

HAZARD OF ELECTRIC SHOCK, EXPLOSION, OR ARC FLASH

- Remove all power from the device before removing any covers or elements of the system, and prior to installing or removing any accessories, hardware, or cables.
- Unplug the power cable from both this product and the power supply prior to installing or removing the product.
- Always use a properly rated voltage sensing device to confirm power is off where and when indicated.
- Replace and secure all covers or elements of the system before applying power to this product.
- Use only the specified voltage when operating this product. This product is designed to use 24 Vdc. Always check whether your device is DC powered before applying power.
- When using this product in Class I, Division 2, Groups A, B, C, and D hazardous locations, install this product in an enclosure that prevents the operator from touching the back of this product without the use of tools.

Failure to follow these instructions will result in death or serious injury.

Critical alarm indicators and system functions require independent and redundant protection hardware and/or mechanical interlocks.

When you cycle power, wait at least 10 seconds after it has been turned off. If this product is restarted too quickly, it may not operate correctly.

In the event the screen cannot be properly read, for example, if the backlight is not functioning, it may be difficult or impossible to identify a function. Functions that may present a hazard if not immediately executed, such as a fuel shut-off, must be provided independently of this product. The machine's control system design must take into account the possibility of the backlight no longer functioning and the operator being unable to control the machine or making mistakes in the control of the machine.

⚠️ WARNING

LOSS OF CONTROL

- The designer of any control scheme must consider the potential failure modes of control paths and, for certain critical control functions, provide a means to achieve a safe state during and after a path failure. Examples of critical control functions are emergency stop and overtravel stop, power outage and restart.
- Separate or redundant control paths must be provided for critical control functions.
- System control paths may include communication links. Consideration must be given to the implications of unanticipated transmission delays or failures of the link.
- Observe all accident prevention regulations and local safety guidelines.
- Each implementation of this product must be individually and thoroughly tested for proper operation before being placed into service.
- The machine control system design must take into account the possibility of the backlight no longer functioning and the operator being unable to control the machine, or making errors in the control of the machine.

Failure to follow these instructions can result in death, serious injury, or equipment damage.

For additional information, refer to NEMA ICS 1.1 (latest edition), "Safety Guidelines for the Application, Installation, and Maintenance of Solid State Control" and to NEMA ICS 7.1 (latest edition), "Safety Standards for Construction and Guide for Selection, Installation and Operation of Adjustable-Speed Drive Systems" or their equivalent governing your particular location.

⚠️ WARNING

UNINTENDED EQUIPMENT OPERATION

- The application of this product requires expertise in the design and programming of control systems. Only persons with such expertise should be allowed to program, install, alter, and apply this product.
- Follow all applicable safety standard, local regulations and directives.

Failure to follow these instructions can result in death, serious injury, or equipment damage.

About this book

⚠ WARNING

UNINTENDED EQUIPMENT OPERATION

- Do not use this product as the only means of control for critical system functions such as motor start/stop or power control.
- Do not use this equipment as the only notification device for critical alarms, such as device overheating or overcurrent.
- Use only the software provided with this product. If you use other software, please confirm the operation and safety before use.

Failure to follow these instructions can result in death, serious injury, or equipment damage.

The following characteristics are specific to the LCD panel and are considered normal behavior:

- LCD screen may show unevenness in the brightness of certain images or may appear different when seen from outside the specified viewing angle. Extended shadows, or crosstalk may also appear on the sides of screen images.
- LCD screen pixels may contain black and white colored spots and color display may seem to have changed.
- When experiencing vibrations within a certain frequency range and vibration acceleration is above what is acceptable, the LCD screen may partially turn white. Once the vibration condition ends, the whitening of the screen is resolved.
- When the same image is displayed on the screen for a long period, an afterimage may appear when the image is changed.
- The panel brightness may decrease when used for a long time in an environment continuously filled with inert gas. To prevent deterioration of panel brightness, regularly ventilate the panel. For more information, please contact customer support.

<https://www.pro-face.com/trans/en/manual/1015.html>

⚠ WARNING

SERIOUS EYE AND SKIN INJURY

The liquid in the LCD panel contains an irritant:

- Avoid direct skin contact with the liquid.
- Wear gloves when you handle a broken or leaking unit.
- Do not use sharp objects or tools in the vicinity of the LCD panel.
- Handle the LCD panel carefully to prevent puncture, bursting, or cracking of the panel material.
- If the panel is damaged and any liquid comes in contact with your skin, immediately rinse the area with running water for at least 15 minutes. If the liquid gets in your eyes, immediately rinse your eyes with running water for at least 15 minutes and consult a doctor.

Failure to follow these instructions can result in death, serious injury, or equipment damage.

NOTICE

REDUCTION OF SERVICE LIFE OF PANEL

Change the screen image periodically and try not to display the same image for a long period of time.

Failure to follow these instructions can result in equipment damage.

Cybersecurity

Cybersecurity Guideline

Use this product inside a secure industrial automation and control system. Total protection of components (equipment/devices), systems, organizations, and networks from cyber attack threats requires multi-layered cyber risk mitigation measures, early detection of incidents, and appropriate response and recovery plans when incidents occur. For more information about cybersecurity, refer to the Pro-face HMI/IPC Cybersecurity Guide.

https://www.proface.com/en/download/manual/cybersecurity_guide

⚠ WARNING

POTENTIAL COMPROMISE OF SYSTEM AVAILABILITY, INTEGRITY, AND CONFIDENTIALITY

- Change default passwords at first use to help prevent unauthorized access to device settings, controls and information.
- Disable unused ports/services and default accounts, where possible, to minimize pathways for malicious attacks.
- Place networked devices behind multiple layers of cyber defenses (such as firewalls, network segmentation, and network intrusion detection and protection).
- Apply the latest updates and hotfixes to your Operating System and software.
- Use cybersecurity best practices (for example: least privilege, separation of duties) to help prevent unauthorized exposure, loss, modification of data and logs, interruption of services, or unintended operation.

Failure to follow these instructions can result in death, serious injury, or equipment damage.

Table of Contents

1

[Summary](#)

2

[Hardware Section](#)

2-1

[Specification Comparison](#)

2-2

[Standards Compatibility](#)

2-3

[Hardware Compatibility](#)

2-4

[Option Compatibility](#)

2-5

[Other Important Notes on Hardware](#)

3

[Software Section](#)

3-1

[Replacement Procedure](#)

3-2

[Software Compatibility](#)

3-3

[Other Important Notes on Software](#)

1. Summary

On replacement from LT-3300T to STC-6300TA, the following points are the main points to note.

- STC-6300TA supports DIO and EX Modules as the same as LT-3300T. The I/O Driver settings on the software are also the same as LT-3300T, so the settings made in LT-3300T project will remain unchanged after converting the project to STC-6300TA.
- The DIO interface specifications of STC-6300TA are the same as LT-3300T. You can use the DIO connector and cable wiring as they are.
- 3 units of EX Modules can be connected directly on LT-3300T, while 2 units directly on STC-6300TA. To use 3 units of EX Modules with STC-6300TA, option modules are needed. For details, please refer to [2-3. Hardware Compatibility – TM3/EX Module Connection](#).
- Display resolution: STC-6300TA has a better resolution. You need to convert resolution by the software to use old project data from LT-3300T.

LT-3300T(5.7")

320 x 240 pixels (QVGA)

STC-6300TA(5.7")

640 x 480 pixels (VGA)

- External dimensions: The panel cut dimensions are the same, but the external dimensions are slightly different. It is necessary to check the dimensions of the HMI installation location.

LT-3300T(5.7")

W167.5 x H135 x D77.6 mm

STC-6300TA(5.7")

W169.5 x H137 x D60 mm



LT-3300T



STC-6300TA

2. Hardware Section

2-1. LT-3300T vs STC-6300TA Specification Comparison -1. Basic Information-

		LT-3300T	STC-6300TA	Points to note when replacing
Display Type		TFT Color LCD	TFT Color LCD	
Display Size		5.7"	5.7"	
Resolution		320 x 240 pixels (QVGA)	640 x 480 pixels (VGA)	Need to change resolution setting by Software
Effective display area (W x H)		70.56 x 52.92 mm	115.2 x 86.4 mm	
Display colors		65,536 colors (no blink) 16,384 colors (with blink)	262,144 colors (no blink)	No blink function
Backlight		White LED (not user replaceable)	White LED (not replaceable)	Backlight is not replaceable.
Backlight service life		50,000 hours or more (before backlight brightness decreases to 50%)	50,000 hours or more (before backlight brightness decreases to 25%)	
Brightness control		8 levels (Adjusted with touch panel or software)	16 levels (Adjusted with touch panel or software)	
Touch panel type		Resistive film (analog, single touch)	Resistive film (analog, single touch)	
Touch panel resolution		1,024 x 1,024	1,024 x 1,024	
Touch panel service life		1 million times or more	1 million times or more	
Application memory *	Screen area	FLASH EPROM 6MB	FLASH EPROM 64MB	Refer to FAQ for the available capacity of each memory.
	Logic Program	FLASH EPROM 132KB (15,000 steps)	FLASH EPROM 132KB (15,000 steps)	
Backup memory *	Screen area	SRAM 128KB	NVRAM 320KB	
	Variable area	SRAM 64KB	NVRAM 64KB	
	Battery (clock data backup)	Rechargeable battery / Secondary battery for clock data backup	Replaceable battery / Primary battery for clock data backup	Battery can be replaced by user.
Rate Input Voltage		DC24V (Input voltage limits: DC19.2~28.8V)	DC24V (Input voltage limits: DC19.2~28.8V)	
IP Rating		IP65f, NEMA#250 TYPE 4X/13	IP65f, UL 50/50E, TYPE 1/4X/12/13	
External Dimensions		W167.5 x H135 x D77.6 mm	W169.5 x H137 x D60 mm	The dimensions are different.
Panel Cut Dimensions		W156 x H123.5 mm	W156 x H123.5 mm	
Power Consumption		18W or less	11.3W or less	

2-1. LT-3300T vs STC-6300TA Specification Comparison -2. Interface-

		LT-3300T	STC-6300TA	Points to note when replacing
Serial I/F	COM1	RS-232C/422/485 (D-Sub 9pin Plug)	RS-232C/422/485 (D-Sub 9pin Plug)	Please check the manual for the communication cable.
	COM2	-	-	
Ethernet I/F		10BASE-T/100BASE-TX (RJ-45) x1	10BASE-T/100BASE-TX (RJ-45) x1	
USB I/F	Type A	USB 1.1 (Type A) x1 -USB transfer cable (CA3-USBCB-01)	USB 2.0 (Type A) x1	No screen data transfer via Type A
	Micro B	-	USB 2.0 (micro-B) x1 -USB transfer cable(PFXZUSCBMB2) or commercial USB micro-B transfer cable	
CF Card I/F		-	-	
CANopen I/F LT-3300T: AUX/Expansion Unit (EXT2)		CANopen Master with CAN Master unit (P/N: CA8-CANLT-01)	CANopen Master Embedded *1	
Expansion Module I/F LT-3300T: EX Module (EXT1)		EX module / TM3 module Up to 3x modules by Direct mounting	TM3 module / EX module Up to 2x modules by Direct mounting 3x modules by Extension mounting *2	TM3 Transmitter / Receiver modules are needed when connecting 3x modules *2
DIO I/F	Digital IN/OUT	DIO 32 points (16x IN / 16x OUT) Sink/Source input: 16 points PFXLT3300TADK (Sink output): 16 points PFXLT3300TADC (Source output): 16 points Connector: 38 pin	DIO 32 points (16x IN / 16x OUT) Sink/Source input: 16 points PFXSTC6300TADDKE (Sink output): 16 points PFXSTC6300TADDCE (source output): 16 points Connector: 38 pin	
	HSC (high speed counter) Max.100kHz	4x Fast IN (among 16 IN)	4x Fast IN (among 16 IN)	
	PTO (pulse train output) Max. 65kHz	4x Fast OUT (among 16 OUT)	4x Fast OUT (among 16 OUT)	

*1: CANopen interface will be supported. Please contact our Customer Service for the latest information.

*2: For Extension mounting, TM3 Transmitter (TM3XTRA1) and Receiver (TM3XREC1) modules are needed.

NOTE: For more details about specification, please refer to [STC6000 Hardware Manual](#).

2-1. LT-3300T vs STC-6300TA Specification Comparison -2. Interface-

Digital Input Specifications

		LT-3300T	STC-6300TA
Input Terminal		IN0...IN15	
Rated Voltage		DC24V	
Maximum Allowable Voltage		DC28.8V	
Input Type		Sink/Source Input	
Rated Current		6.5mA (DC24V) (IN0, IN2, IN4, IN6), 4.1mA (DC24V) (Other input)	2.25mA
Input Resistance		Approx. 3.7kΩ (IN0, IN2, IN4, IN6), Approx. 5.9kΩ (Other input)	10.7kΩ
Input Points		16	
Common Lines		1	
Common Design		16 points/1 common line	
Operation Range	ON voltage	DC19V or more	DC15-28.8V
	OFF voltage	DC5V or less	
	ON current	6.5mA (DC24V) (IN0, IN2, IN4, IN6) 4.1mA (DC24V) (Other input)	2.25 mA
	OFF current	N/A	1.0 mA or less
Filtering	Normal input	0.5 ms x N (N is 0 to 40)	
	High-speed counter (IN0, IN2, IN4, IN6)	N/A	None, 4 μs, or 40 μs
Input Delay Time	OFF to ON	0.5 to 20ms *1	
	ON to OFF	0.5 to 20ms *1	

*1 Digital filter can be set at intervals of 0.5 ms.

		LT-3300T	STC-6300TA
Input Signal Display		No LED indicators	
Status Display		None	
Isolation		Photocoupler Isolation	Digital Isolations
External Connection		38-pin connector (used with Output section)	
External Power Supply		For Signal: DC 24V	
Cable length	Normal input	N/A	Maximum 50 m (164 ft)
	High-speed counter/Pulse catch input (IN0, IN2, IN4, IN6)	N/A	Maximum 10 m (33 ft)

2-1. LT-3300T vs STC-6300TA Specification Comparison -2. Interface-

Digital Output Specifications

		LT-3300T		STC-6300TA	
Output Terminal		OUT0 to OUT3	OUT4 to OUT15	OUT0 to OUT3	OUT4 to OUT15
Rated Voltage		DC24V			
Rated Voltage Range		DC20.4V to DC28.8V			
Output Type		LT3300-T1-D24-K: Sink LT3300-T1-D24-C: Source		PFXSTC6300TADDKE: Sink PFXSTC6300TADDCE: Source	
Maximum Load Current		0.2A/point, 1.6A/common		0.3 A/1-point, 3.2 A/1 common	
Minimum Load Current		1mA	1mA (Pulse/PWM output unavailable)	1mA	1mA (Pulse/PWM output unavailable)
Output Voltage Drop		DC 0.5V or less		DC 1.5V or less	
Output Delay Time	OFF to ON (with output at DC24V, 200mA)	5µs or less	0.5ms or less	5µs or less	50 µs or less
	ON to OFF (with output at DC24V, 200mA)	5µs or less	0.5ms or less	5µs or less	50 µs or less
Voltage Leakage (when OFF)		0.1mA or less			
Clamp Voltage		39V ± 1V		N/A	
Type of Output		Transistor Output			
Common Lines		2			
Common Design		8 points/1 common line x 2			
External Connection		38-pin connector (also used for Input)			
Output Protection Type		Output is unprotected			

		LT-3300T	STC-6300TA
Internal Fuse		3.5A, 125V Chip fuse x 2 (not replaceable)	Don't have fuse inside (Chip have over current protection function)
Surge Control Circuit		Zener diode	TVS (Transient Voltage Suppressors)
Output Points		16	
Output Signal Display		No LED indicators	
Status Display		None	
Isolation Method		Photocoupler isolation	Digital Isolations
External Power Supply		For Signal: DC24V	
Cable Length	Normal output	N/A	Maximum 150 m (492 ft)
	Pulse/PWM output	N/A	Maximum 5 m (16 ft)

2-1. LT-3300T vs STC-6300TA Specification Comparison -2. Interface-

High-Speed Counter

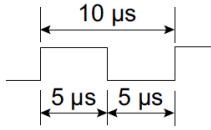
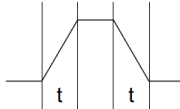
	LT-3300T / STC-6300TA	
Input	DC24V Open Collector	
	Single Phase (4 points)	2 Phase (1 or 2 points)
Input Points	CT0 (IN0) CT1 (IN2) CT2 (IN4) CT3 (IN6)	CT0 (IN0), CT1 (IN2) (used as pair) CT0: A Phase, CT1: B Phase CT2 (IN4), CT3 (IN6) (used as pair) CT2: A Phase, CT3: B Phase
Minimum Pulse Width (Pulse Input)		
Count Speed (Rise, Fall time)	 <p>$t = 1 \mu\text{s}$ or less (100 kpps)</p>	
Phase	1 Phase	90 degree phase differential 2-phase signal 1 phase + directional signal
High Speed Count Frequency	100Kpps	50Kpps
Count Edge Designation	Available	Not available
Count Register	32 Bit UP/DOWN Counter	
Count Mode Change	Set through software	
Upper/Lower Limit Change	Not Available	
Preload – Prestrobe	Available	
Marker Input (Counter Value Clear)	None	IN3, IN7

Pulse Catch Input

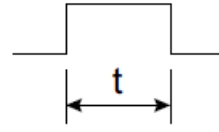
	LT-3300T / STC-6300TA
Input	DC24V Open Collector
Input Points	IN0, IN2, IN4, IN6
Minimum Pulse Width (Pulse Input)	Input signal ON width  $t = 5 \mu\text{s}$ or more

NOTE: DIO standard input/output can be used as a high-speed counter, or a pulse catch input. The setup is done by the GP-Pro EX.

2-1. LT-3300T vs STC-6300TA Specification Comparison -2. Interface-

Pulse Output

	LT-3300T	STC-6300TA
Output Points	4 points	
Output Method	PLS0 to PLS3 (OUT0 to OUT3) set with software	
Load Voltage	DV24V	
Maximum Load Current	N/A	50 mA/1-point
Minimum Load Current	1mA	
Maximum Output Frequency	Up to 65kHz / 1-point (set with software)	
Pulse acceleration/ Deceleration speed	Available	
ON Duty	50% ±10% (at 65 kHz)*1	

*1: ON Duty error (10%) will be reduced if the Output frequency is low.

PWM Output

	LT-3300T	STC-6300TA
Output Points	4 points	
Output Method	PWM0 to PWM3 (OUT0 to OUT3) set with software	
Load Voltage	DV24V	
Maximum Load Current	N/A	50 mA/1-point
Minimum Load Current	1mA	
Maximum Output Frequency	Up to 65kHz / 1-point (set with software)	
ON Duty	19 to 81% (at 65kHz)*2	

*2: ON Duty (effective range) will be widened if the output frequency is low.

Note: DIO standard output can be used as a pulse or PWM output. For setup information, refer to [GP-Pro EX V4.0 Reference Manual](#).

2-1. LT-3300T vs STC-6300TA Specification Comparison -2. Interface-

DIO Interface

38 pin connector
(P/N: PFXZC7CNXY321*)

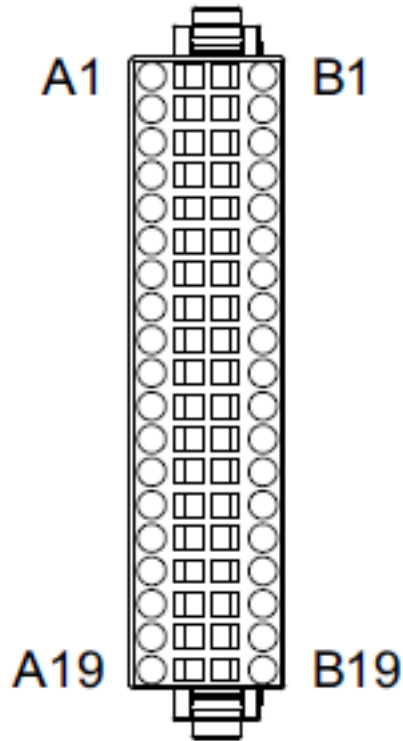

STC-6300TA connector pin definition (Same as LT-3300T)

Pin No.	Signal name	Pin No.	Signal name
A1	IN1	B1	IN0 (CT0) ^{*1}
A2	IN3	B2	IN2 (CT1) ^{*1}
A3	IN5	B3	IN4 (CT2) ^{*1}
A4	IN7	B4	IN6 (CT3) ^{*1}
A5	IN9	B5	IN8
A6	IN11	B6	IN10
A7	IN13	B7	IN12
A8	IN15	B8	IN14
A9	NC	B9	COM
A10	Sink: NC Source: +24 Vdc	B10	Sink: +24 Vdc Source: +24 Vdc
A11	Sink: 0 Vdc Source: NC	B11	Sink: 0 Vdc Source: 0 Vdc
A12	OUT1 (PLS1, PWM1) ^{*2}	B12	OUT0 (PLS0, PWM0) ^{*2}
A13	OUT3 (PLS3, PWM3) ^{*2}	B13	OUT2 (PLS2, PWM2) ^{*2}
A14	OUT5	B14	OUT4
A15	OUT7	B15	OUT6
A16	OUT9	B16	OUT8
A17	OUT11	B17	OUT10
A18	OUT13	B18	OUT12
A19	OUT15	B19	OUT14

*1 Signal names in parentheses () indicate the counter input used.

*2 Signal names in parentheses () indicate the pulse output or PWM output used.

* The same DIO connector PFXZC7CNXY321 (old P/N: CA7-DIOCN5-01) can be used for both LT-3300T and STC-6300TA.

2-2. Standards Compatibility

Certification	LT-3300T	STC-6300TA
CE (EN61000-6-4, EN61000-6-2, EN61131-2)	✓	✓
UKCA	-	✓
UL/cUL	✓ (UL508) (CSA C22.2 No.142)	✓ (UL61010-2-201) (CSA C22.2 No.61010-2-201)
UL/cUL Class 1, Div. 2	✓ (ANSI/ISA12.12.01) (CSA C22.2 No213)	✓ (UL121201) (CSA C22.2 No213)
ATEX (Zones 2/22, equipment category 3 Gas Dust)	-	✓
IECEx (Zones 2/22, equipment category 3 Gas Dust)	-	✓
UKEX	-	Planned *1
KCs	-	Planned *1
NEPSI → CCC-Ex	-	Planned *1
RCM (C-Tick)	-	✓
EAC (GOST-R)	✓	✓
RoHS for EU	✓	✓
RoHS for China	✓	✓
REACH	✓	✓
CCC *apply for CCC exemption	-	-
KC	✓	✓
Marine	-	DNV, ABS, BV, NK, CCS, KR: Planned *1
WEEE	✓	✓

*1: Please contact our Customer Service for the latest information.

2-3. Hardware Compatibility – Interfaces

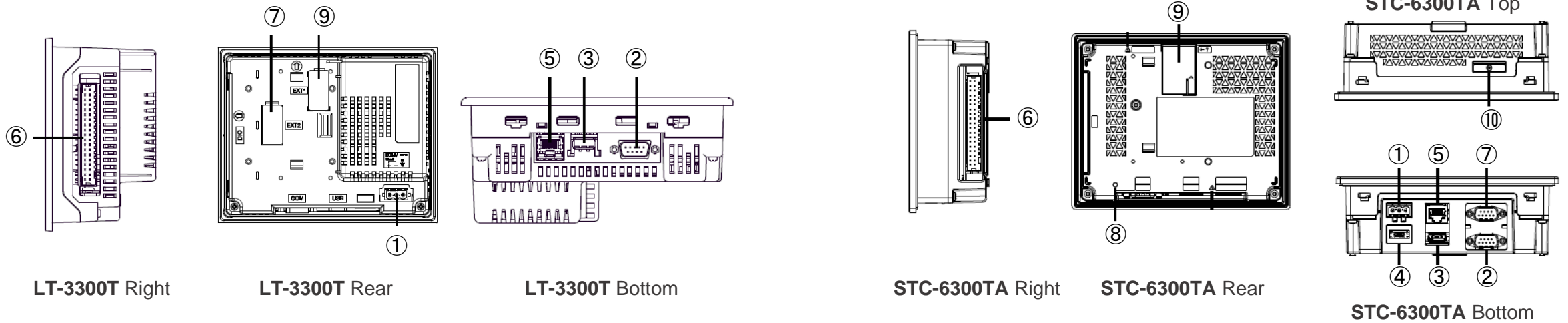

	LT-3300T	STC-6300TA
①	Power Connector (DC)	Power Connector (DC)
②	Serial Interface (COM1)	Serial Interface (COM1)
③	USB (Type A) Interface	USB (Type A) Interface
④	-	USB (micro-B) Interface
⑤	Ethernet Interface	Ethernet Interface
⑥	DIO Interface	DIO Interface
⑦	AUX Unit Interface / Expansion Unit (EXT2) *1	CANopen Interface *2
⑧	-	CANopen LED *2
⑨	EX Module Interface (EXT1) *1	Expansion Module Interface
⑩	-	Battery Slot

*1: EX module and CANopen Master Unit cannot be used at the same time.

*2: CANopen interface and CANopen LED will be supported. Please contact our Customer Service for the latest information.

NOTE: Please check [STC6000 Series Hardware Manual](#) for details such as interface specifications and pin assignments.

2-3. Hardware Compatibility – External Dimensions

LT-3300T	STC-6300TA	Differences from LT-3300T to STC-6300TA
W167.5 x H135 x D77.6 mm	W169.5 x H137 x D60 mm	W: +2.0mm , H: +2.0mm , D: -17.6mm

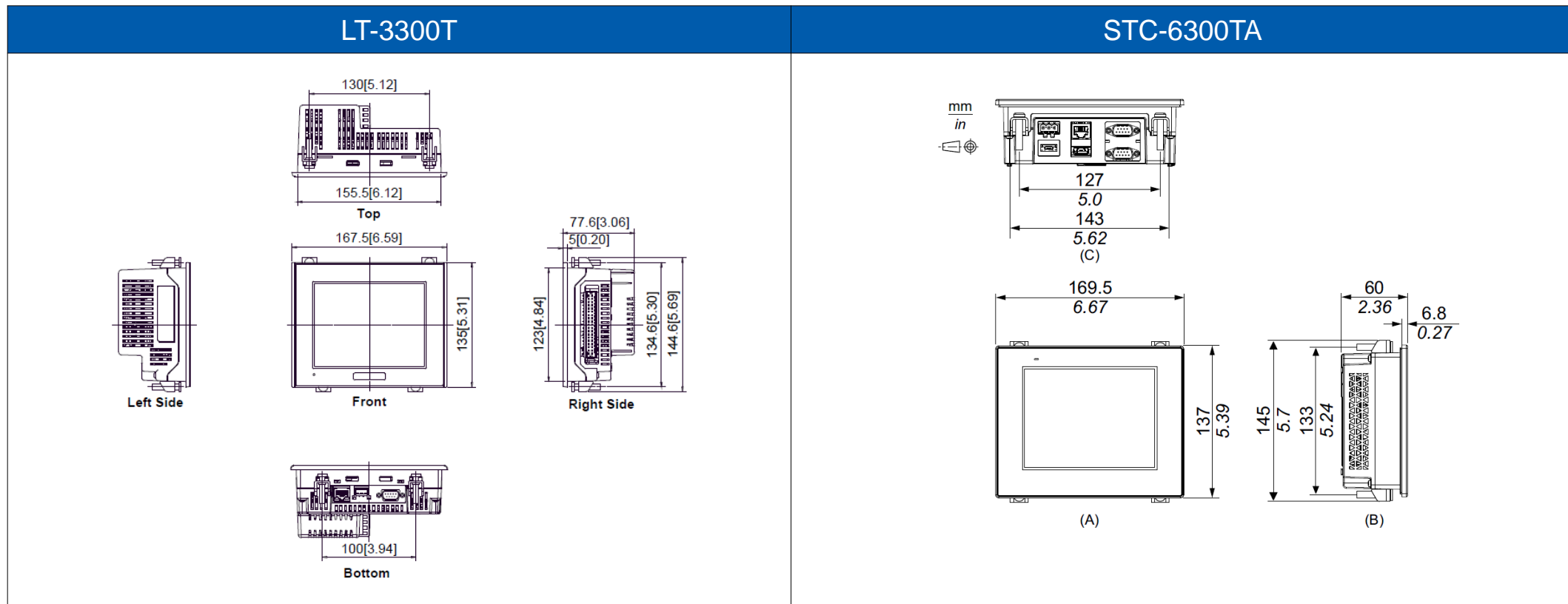

2-3. Hardware Compatibility – Installation Method

Panel cut dimensions and installation method are the same between LT-3300T and STC-6300TA.

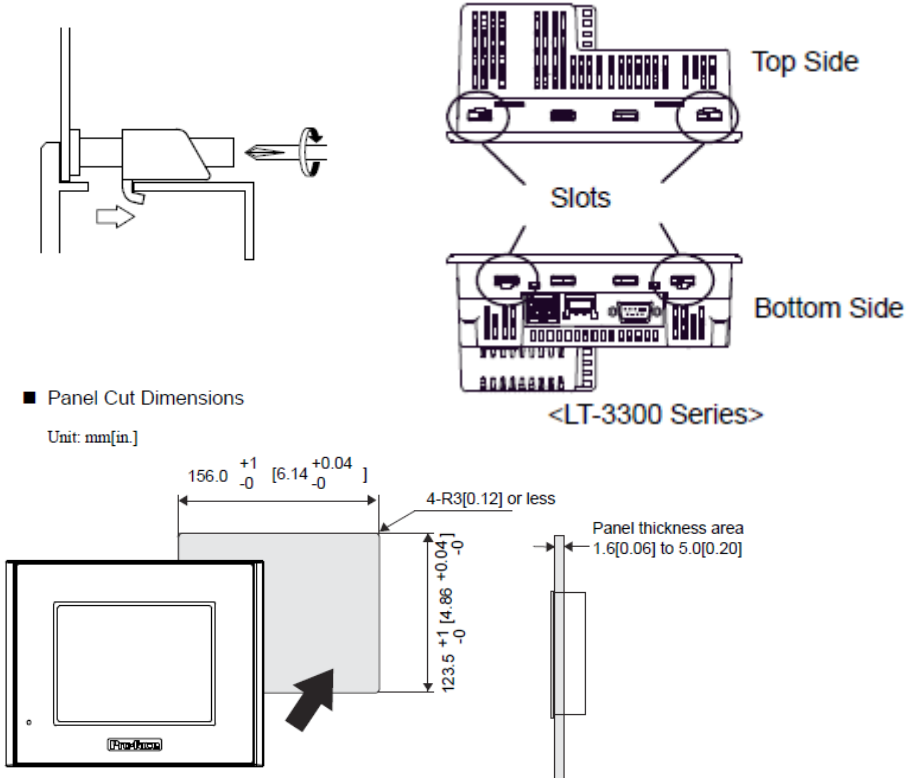
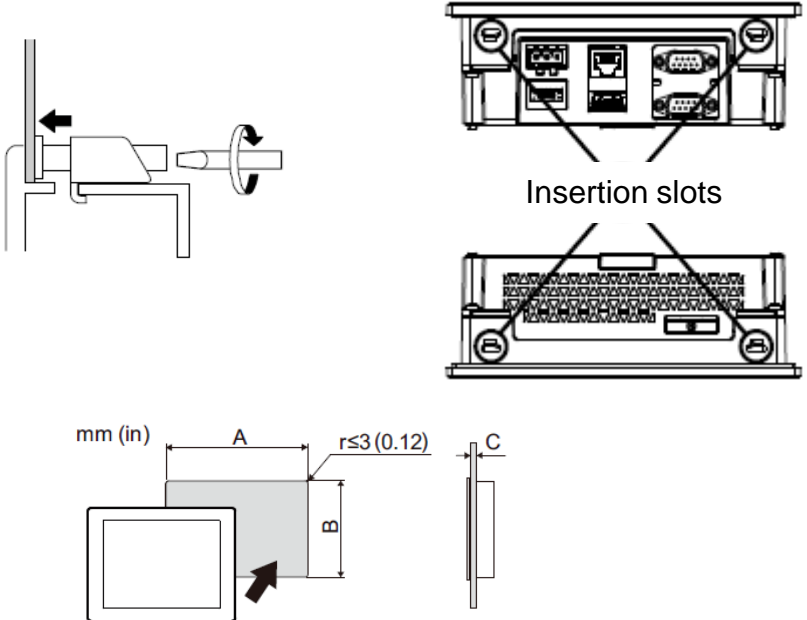
LT-3300T	STC-6300TA												
<p>The product can be installed easily by using a screwdriver.</p>  <p>Top Side</p> <p>Bottom Side</p> <p>Slots</p> <p><LT-3300 Series></p> <p>■ Panel Cut Dimensions</p> <p>Unit: mm[in.]</p> <p>156.0 ⁺¹/₋₀ [6.14 ^{+0.04}/₋₀]</p> <p>4-R3[0.12] or less</p> <p>123.5 ⁺¹/₋₀ [4.86 ^{+0.04}/₋₀]</p> <p>Panel thickness area 1.6[0.06] to 5.0[0.20]</p>	<p>The product can be installed easily by using a screwdriver.</p>  <p>Insertion slots</p> <p>mm (in)</p> <p>A</p> <p>B</p> <p>C</p> <p>$r \leq 3 (0.12)$</p> <table border="1" data-bbox="1350 1120 2076 1249"> <thead> <tr> <th colspan="3">Model name</th> </tr> <tr> <th>A</th> <th>B</th> <th>C</th> </tr> </thead> <tbody> <tr> <td>156 mm (+1/-0 mm)</td> <td>123.5 mm (+1/-0 mm)</td> <td>1.6...5 mm</td> </tr> <tr> <td>(6.14 in [+0.04/-0 in])</td> <td>(4.86 in [+0.04/-0 in])</td> <td>(0.06...0.2 in)</td> </tr> </tbody> </table>	Model name			A	B	C	156 mm (+1/-0 mm)	123.5 mm (+1/-0 mm)	1.6...5 mm	(6.14 in [+0.04/-0 in])	(4.86 in [+0.04/-0 in])	(0.06...0.2 in)
Model name													
A	B	C											
156 mm (+1/-0 mm)	123.5 mm (+1/-0 mm)	1.6...5 mm											
(6.14 in [+0.04/-0 in])	(4.86 in [+0.04/-0 in])	(0.06...0.2 in)											

NOTE: Installation fastener of LT-3300T (P/N: CA3-ATFALL-01) cannot be used for STC-6300TA. For STC-6300TA, please use the fastener of STC6000 Series (P/N: PFXZC3AT1).

NOTE: Please check [STC6000 Hardware Manual](#) for installation requirements and procedure.

2-3. Hardware Compatibility – TM3/EX Module Connection

EXM = EX module

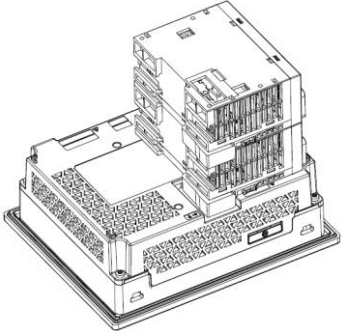
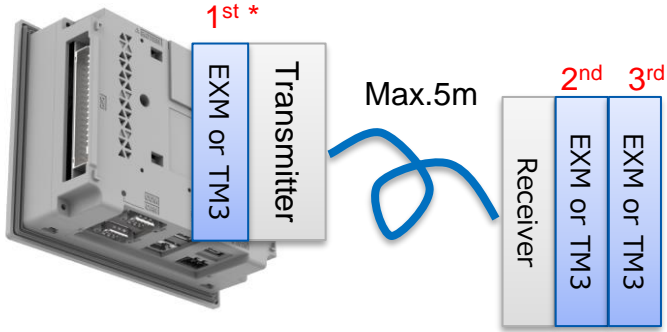
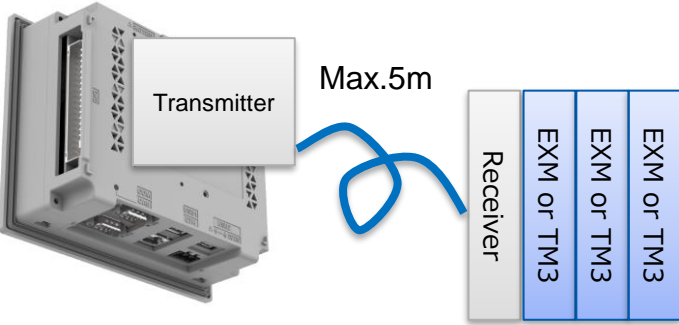
	LT-3300T	STC-6300TA	
Rear (Direct) Mounting	<p>Support up to 3 units of TM3 / EX modules</p> 	<p>Support up to 2 units of TM3 / EX modules</p> 	<p>Able to connect 3 units of TM3 / EX modules with the following options:</p> <ul style="list-style-type: none"> - TM3 Transmitter (P/N: TM3XTRA1) - TM3 Receiver (P/N: TM3XREC1) - Connection cable between transmitter and receiver  <p>*The module by direct mounting is recognized first.</p> <ul style="list-style-type: none"> ▪ When you connect a TM3 module and Transmitter on the rear of STC-6300TA, connect the TM3 module as the 1st module, and connect the Transmitter as the 2nd. ▪ If Direct Mount and Extension Mount are used at the same time, Direct Mount will be recognized first and then Extension Mount. However, there will not be much differences in connection speed.
Extension Mounting		<p>Able to connect 3 units of TM3 / EX modules with the following options:</p> <ul style="list-style-type: none"> - TM3 Transmitter (P/N: TM3XTRA1) - TM3 Receiver (P/N: TM3XREC1) - Connection cable between transmitter and receiver 	

* TM3 module and EX module can be used together.

* To use TM3 Transmitter and Receiver, no setting on Software is required.

NOTE: For TM3/EX module installation, please refer to [Modicon TM3 guidebook for setting up a connection to HMI](#).

2-4. Option compatibility – Serial Interface

- Serial Interface

Product Name	LT-3300T	STC-6300TA	Description	Compatibility
RS-232C Cable (5m)	CA3-CBL232/5M-01	CA3-CBL232/5M-01	Connects a host controller to the GP unit.(RS-232C)	✓
RS-422 Cable (5m)	CA3-CBL422/5M-01	CA3-CBL422/5M-01	CA3-CBL422/5M-01 Connects a host controller to the GP unit. (RS-422 / Socket Type)	✓
RS-422 Cable (5m)	CA3-CBL422-01	CA3-CBL422-01	Connects a host controller to the GP unit. (RS-422 / Plug Type)	✓
RS-422 Terminal Block Conversion Adapter	-	PFXZCBADTM1	Connects output from a serial interface (D-sub 9 pin plug) directly to an RS-422 terminal block.	NEW
RS-232C Isolation Unit	CA3-ISO232-01	CA3-ISO232-01	Connects a host controller to this product and provides isolation (RS-232C and RS-422 are switchable).	✓
COM Port Conversion Adapter	CA3-ADPCOM-01	CA3-ADPCOM-01	Connects optional RS-422 communication items to serial interface.	✓
	-	PFXZC3ADCM1		NEW
Terminal Block Conversion Adapter	CA3-ADPTRM-01	CA3-ADPTRM-01	Connects output from a GP unit's Serial Interface (D-sub 9 pin socket) directly with an RS-422 terminal block.	✓

2-4. Option compatibility – USB (Type A) Interface

- USB (Type A) Interface

Product Name	LT-3300T	STC-6300TA	Description	Compatibility
USB Transfer Cable (2m)	CA3-USBCB-01	-	Cable for transferring screen data between a PC (USB Type A) and the GP unit (USB Type A)	- A to A screen transfer is not available.
USB Cable (5m)	FP-US00	FP-US00	Connects a USB printer (Type B)	✓
USB Front Cable (1m)	CA5-USBEXT-01	CA5-USBEXT-01	Extension cable that attaches USB interface (Type A) to front panel	✓
USB-Serial (RS-232C) Conversion Cable (0.5m)	CA6-USB232-01	CA6-USB232-01	Cable for converting a USB interface into a serial interface (RS-232C)	✓
USB Clamp Type A (1 port)	-	PFXZCBCLUSA1	Clamp to prevent disconnection of USB cable (USB/A, 1 port, 5 clamps/set)	NEW
USB/RS-422/485 Conversion Adapter	-	PFXZCBCBCVUSR41	Adapter for connecting this product (USB Type A) to an external device (RS-422/RS-485)	NEW
EZ Illuminated Switch	-	PFXZCCEUSG1	A unit of 5 illuminated switches with multiple color LED easily connected with this product unit via USB	NEW
EZ Tower Light tube mounting fixing plate	-	PFXZCETWHA1	USB Connection Type Monolithic EZ Tower Light tube mounting with fixing plate 3 tiers, Ø60, lighting and flashing with a buzzer	NEW
EZ Tower Light with base mounting	-	PFXZCETWW1	USB Connection Type Monolithic EZ Tower with base mounting 3 tiers, Ø60, lighting and flashing with a buzzer	NEW
EZ LAN Adapter	-	PFXZCGEUUE1	An adapter to expand an Ethernet port to HMI	NEW

2-4. Option compatibility – USB (micro-B) Interface, Others

- USB (micro-B) Interface

Product Name	LT-3300T	STC-6300TA	Description	Compatibility
USB Transfer Cable	-	PFXZUSCBMB2	Cable for transferring screen data from a PC (USB Type A) to this product (USB micro-B)	NEW
USB (micro-B) Front Cable	-	PFXZCIEXMB2	Extension cable that attaches USB interface (micro-B) to front panel	NEW

- Others

Product Name	LT-3300T	STC-6300TA	Description	Compatibility
Screen Protection Sheet	CA3-DFS6-01	-	Disposable, dirt-resistant sheet for the main unit screen (5 sheets/set) (Hard type)	-
	-	PFXZCBDS61		NEW
UV Protection Sheet	-	PFXZCFUV61	Sheet to protect the display from ultraviolet light (1 sheet)	NEW
Protective Cover	CA4-DCMDL-01	-	The installation of the cover is to protect Display from leaking liquid and raise resistant performance against chemical substance (5 sheets)	-
Environment Cover	-	PFXZCBOP61	Disposable, environmental resistant cover (1 sheet)	NEW

2-4. Option compatibility – Maintenance

- Maintenance Options

Product Name		LT-3300T	STC-6300TA	Description	Compatibility
Installation Fastener		CA3-ATFALL-01	-	Used to install the GP unit into a solid panel (4 pieces/set)	NEW
		-	PFXZC3AT1	Installation fastener (4 pieces/set)	Use the option for STC6000 series.
Installation Gasket	LT-3300T	CA3-WPG6-01	-	Provides dust and moisture resistance when this product is installed into a solid panel (1 piece).	NEW
	STC-6300TA	-	PFXZHWG31		Use the option for STC6000 series.
DIO Connector		CA7-DIOCN5-01	CA7-DIOCN5-01	Connectors for interfacing with external I/O devices (5 pieces/set).	✓
USB Clamp Type A (1 port)		CA7-USBAT6-01	-	Clamp to prevent disconnection of USB cable (USB/A, 1 port, 5 clamps/set)	- This is included in the package of LT-3300T, not included in STC-6300TA.
DC Power Supply Connector		CA5-DCCNM-01	CA5-DCCNM-01	Connector to connect DC power supply cables (5 pieces/set)	✓
EX Module Securing Hook		CA7-FIXEXM-01	-	Hook for securing three EX modules to the LT-3300 Series	-
TM3 Module Securing Hook		-	PFXZHMISH1	TM3 module securing hook (1 piece)	NEW
Panel Cutout Adapter		CA4-ATM5-01	-	Panel cutout adapter for mounting LT-3300 Series in cutout of LT Series.	-
Battery for Data Backup		-	PFXZGEBT1	Primary battery for memory and time data backup (1 piece) For all ST6000 series	NEW

2-4. Option compatibility – Supported EX Modules (End of Sale: March 2023)

Product Name		Model No.	Recommended Substitute TM3 Module name	LT-3300T	STC-6300TA
Standard Input Module	EX module (8-point input module)	EXM-DDI8DT	TM3DI8	✓	✓
	EX module (16-point input module)	EXM-DDI16DT	TM3DI16	✓	✓
Standard Output Module	EX module (8-point relay-output module)	EXM-DRA8RT	TM3DQ8R	✓	✓
	EX module (16-point relay-output module)	EXM-DRA16RT	TM3DQ16R	✓	✓
	EX module (8-point sink-output module)	EXM-DDO8UT	TM3DQ8U	✓	✓
	EX module (8-point source-output module)	EXM-DDO8TT	TM3DQ8T	✓	✓
	EX module (16-point sink-output module)	EXM-DDO16UK	TM3DQ16UK	✓	✓
	EX module (16-point source-output module)	EXM-DDO16TK	TM3DQ16TK	✓	✓
Standard I/O Module	EX module (4-point inputs/4-point relay-output module)	EXM-DMM8DRT	TM3DM8R	✓	✓
	EX module (16-point inputs/8-point relay-output module)	EXM-DMM24DRF *1	TM3DM24R	✓	✓
Analog Input Module	EX module (2-ch analogue-input module)	EXM-AMI2HT	TM3AI2H	✓	✓
	EX module (4-ch Analog input / Temperature input module)	EXM-AMI4LT	TM3TI4	✓	✓
	EX module (8-ch Pt100/Pt1000 input module)	EXM-ARI8LT *1	TM3TI4 (x 2)	✓	✓
Analog Output Module	EX module (1-ch analogue-output module)	EXM-AMO1HT	TM3AQ2	✓	✓
	EX module (2-ch analogue-output module)	EXM-AVO2HT	TM3AQ2	✓	✓
Analog I/O Module	EX module (Thermocouple Pt100 input/1-ch analogue-output module)	EXM-ALM3LT	TM3TM3	✓	✓
	EX module (2-ch analogue-input/1-ch analogue-output module)	EXM-AMM3HT	TM3TM3	✓	✓
	EX module (4-ch analogue-input/2-ch analogue-output module)	EXM-AMM6HT	TM3AM6	✓	✓

*1: As for EXM-DMM24DRF and EXM-ARI8LT, only one EX module can be connected.

2-4. Option compatibility – Supported TM3 Modules

Product Name	Model No.		
	Screw type	Spring type	HE10
8-ch Sink/Source Inputs	TM3DI8	TM3DI8G	-
16-ch Sink/Source Inputs	TM3DI16	TM3DI16G	-
8-ch Relay Outputs	TM3DQ8R	TM3DQ8RG	-
16-ch Relay Outputs	TM3DQ16R	TM3DQ16RG	-
8-ch Transistor Sink Outputs	TM3DQ8U	TM3DQ8UG	-
16-ch Transistor Sink Outputs	-	-	TM3DQ16UK
8-ch Transistor Source Outputs	TM3DQ8T	TM3DQ8TG	-
16-ch Transistor Source Outputs	-	-	TM3DQ16TK
4-ch Sink/Source Inputs, 4-ch Relay Outputs	TM3DM8R	TM3DM8RG	-
16-ch Sink/Source Inputs, 8-ch Relay Output	TM3DM24R *1	TM3DM24RG *1	-
2-ch Voltage/Current Inputs	TM3AI2H	TM3AI2HG	-
2-ch Temperature or Voltage/Current Inputs, 1-ch Voltage/Current Output	TM3TM3	TM3TM3G	-
4-ch Voltage/Current or Temperature Inputs	TM3TI4	TM3TI4G	-
2-ch Voltage/Current Outputs	TM3AQ2	TM3AQ2G	-
4-ch Voltage/Current Inputs, 2-ch Voltage/Current Outputs	TM3AM6	TM3AM6G	-

Product Name	Model No.
Remote transmitter module	TM3XTRA1 *2
Remote receiver module	TM3XREC1 *2

*1: As for TM3DM24R, only one TM module can be connected.

*2: These modules are used for Extension Mounting, to connect more than two TM3 modules. For the connection method, refer to [Modicon TM3 guidebook for setting up a connection to HMI](#).

2-5. Other Important Notes on Hardware – different points from LT-3300T

- About Input Filter Function restrictions
 - In STC6000 Series, input delay time of all terminals are 5 μ s for ON→OFF / 5 μ s for OFF→ ON.

LT-3300T		STC-6300TA
X0, X2, X4, X6 Terminals	X1, X3, X5, X7, X8, X9, X10, X11 Terminals	All Terminals
<p>There is an input delay time of 5 microseconds for ON→OFF and 5 microseconds for OFF→ON. When running sampling every 0.5 milliseconds, 5 microseconds (ON→OFF) + 0.5 milliseconds (Sampling Interval) + 5 microseconds (OFF→ON) = 0.51 milliseconds As a result, 0.51 milliseconds is the limit for the smallest input pulse width.</p>	<p>There is an input delay time of 0.5 milliseconds for ON→OFF and 5 milliseconds for OFF→ON. When running sampling every 0.5 milliseconds 0.5 milliseconds (ON→OFF) + 0.5 milliseconds (Sampling Interval) + 0.5 milliseconds (OFF→ON) = 1.5 milliseconds As a result, 1.5 milliseconds is the limit for the smallest input pulse width.</p>	<p>There is an input delay time of 5 microseconds for ON→OFF and 5 microseconds for OFF→ON. When running sampling every 0.5 milliseconds, 5 microseconds (ON→OFF) + 0.5 milliseconds (Sampling Interval) + 5 microseconds (OFF→ON) = 0.51 milliseconds As a result, 0.51 milliseconds is the limit for the smallest input pulse width.</p>

- About Pulse Output Usage restrictions
 - Pulse output maximum frequency is 65,000Hz in LT-3300T. When combining the number of CH and high-speed counters used, there is a limit to the maximum output frequency. For the detail, refer to GP-Pro EX V4.0 Reference Manual (31.5.14.2 Pulse Output Usage Restrictions).
 - In case of STC6000 Series, there is no such restriction. The pulse output maximum frequency is 65,000Hz in any case.
- High Speed Counter Filter
 - STC6000 Series support “None, 4 μ s and 40 μ s” filter.
 - LT-3300T does not have this feature.
 - For the detail, refer to GP-Pro EX V4.0 Reference Manual (31.5.6.8 Counter Input Filter – High Speed Counter).
- For the detailed information on each setting, please refer to [GP-Pro EX V4.0 Reference Manual](#).

2-5. Other Important Notes on Hardware

- Do not expose the hardware to direct sunlight. Recommend to use the option item “UV Protection Sheet” to protect the display from ultraviolet light.
- This product is not designed for outdoor use. UL certification obtained is for indoor use only.
- Do not turn on the hardware if condensation has occurred inside the device.
- The panel brightness may decrease when used for a long time in an environment continuously filled with inert gas. Please ventilate the control panel periodically.

3. Software Section

3-1. Replacement Procedure – Workflow

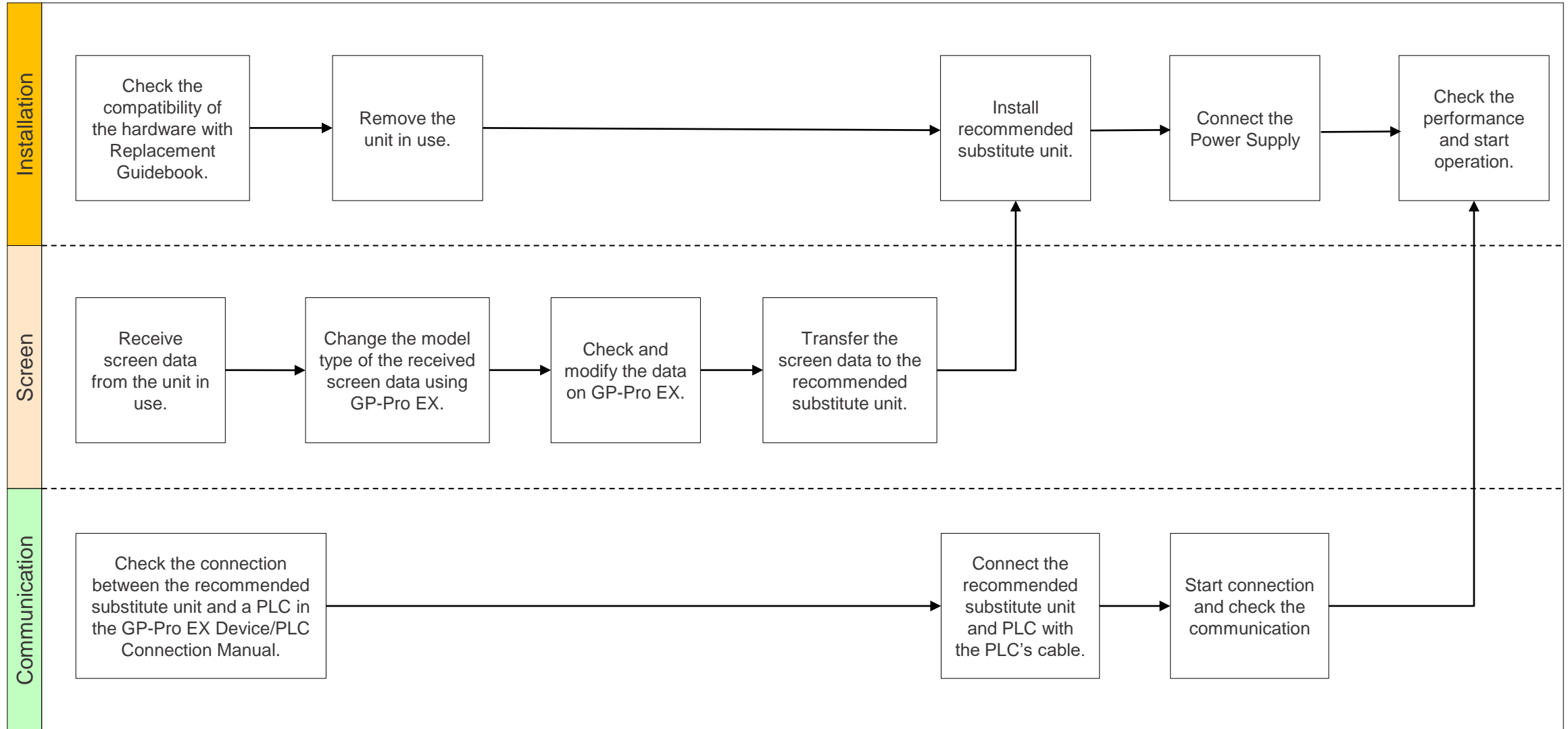

3-1. Replacement Procedure – Preparation

Requirements for receiving screen data from the unit in use *1	PC in which GP-Pro EX Transfer Tool is installed. *2
	Transfer Cable (the followings can be used) USB transfer cable: CA3-USBCB-01 (Type A - Type A) *It's also possible to send/receive a screen via USB storage device or Ethernet.
Requirements for converting screen data of the unit in use and transferring the converted data to Recommended substitute unit	PC with GP-Pro EX installed STC-6300TA supported version: Ver. 4.09.500 or later
	Transfer Cable (the followings can be used) USB transfer cable: PFXZUSCBMB2 (Type A – Type micro-B) or commercially available USB micro-B transfer cable *It's also possible to send/receive a screen via USB storage device or Ethernet.

*1: This step is required if screen data is saved only in the HMI unit, not in any other device.



If you already have the screen data backup, please go to [“3-1. Replacement Procedure – Change model to recommended substitute unit \(GP-Pro EX\)”](#).

*2: Please use the same or later version of the software used when creating screens on the old model. If you don't know the software version, we recommend that you use the latest one. You can download the latest transfer tool from our website.

<https://www.pro-face.com/otasuke/>

3-1. Replacement Procedure – Receive Screen data from the model in use (GP-Pro EX)

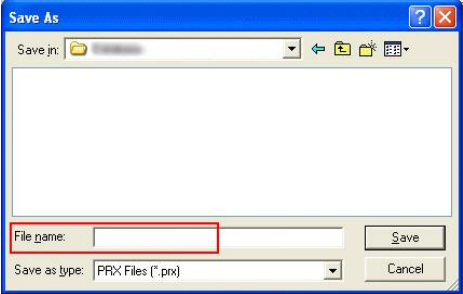
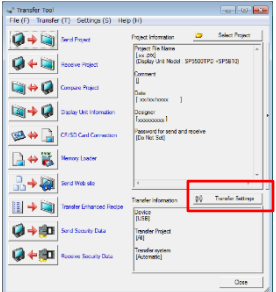
In this section, we will introduce how to receive screen data with a USB transfer cable as an example. If you have the backup of screen data, this step is not necessary. Please go to the next section.

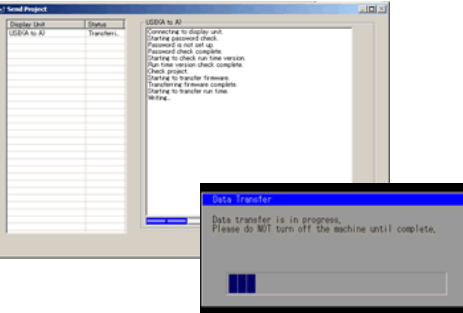
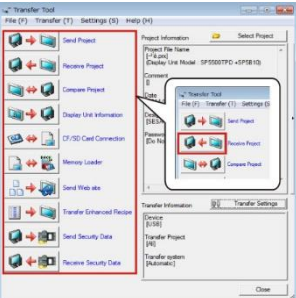
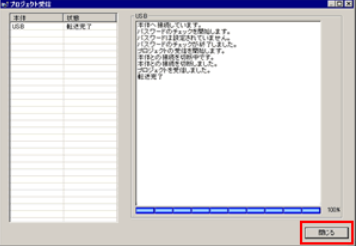
<p>1. Connect your PC and the model in use with a USB transfer cable. If the driver of the cable has not been installed on your PC yet, a dialog box will appear. Please follow the instructions.</p>		<p>5. Click [Receive Project], and the following dialog box will appear. Specify a place to save the received data in and a project file name, and then click [Save] to start transfer.</p>	
<p>2. Start the Transfer Tool of GP-Pro EX.</p>			
<p>3. Make sure that the [Device] in the “Transfer Settings Information” is set to [USB]. If not, click the [Transfer Setting] button to open the “Transfer Setting” dialog box. Select [USB] in the Communication Port Settings field and click [OK].</p>		<p>6. The following dialog box appears during transfer, and you can check the communication status. (The display unit enters the Transferring mode and communication with the device such as a PLC is terminated.)</p>	
<p>4. Start GP-Pro EX Transfer Tool and click the [Receive Project] button.</p>		<p>7. When transfer is completed, the status displayed in the dialog box will change from [Transferring] to [Complete Transfer]. Click [Close] to close the dialog box.</p>	
		<p>8. Close the Transfer Tool.</p>	

3-1. Replacement Procedure – Receive Screen data from the model in use (GP-Pro EX)

NOTES

- The “Hardware Installation” dialog box as shown on the right may appear during installing the USB driver depending on the security level of Windows®. Click [Continue Anyway] to start installing the driver. When installation is completed, click [Finish].

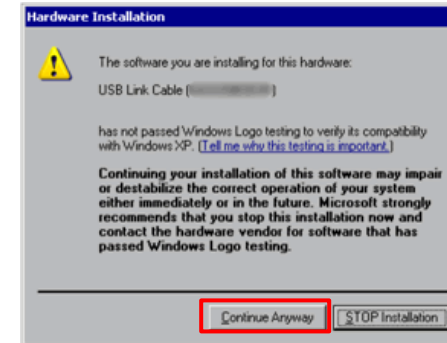

- When the file already exists, a window will appear asking if you want to overwrite the file.

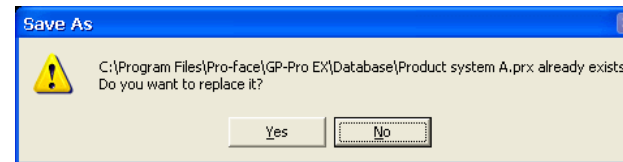

- When receiving a project file that uses SD card/USB memory data such as Recipe Function (CSV data), the following dialog box will appear during the transfer. Please specify where to save the data. Click [OK] to return to the [Receive Project] dialog box and complete the transfer.

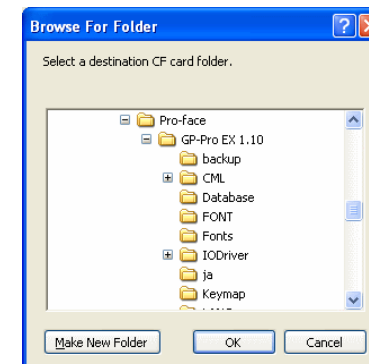

3-1. Replacement Procedure – Change model to recommended substitute unit (GP-Pro EX)

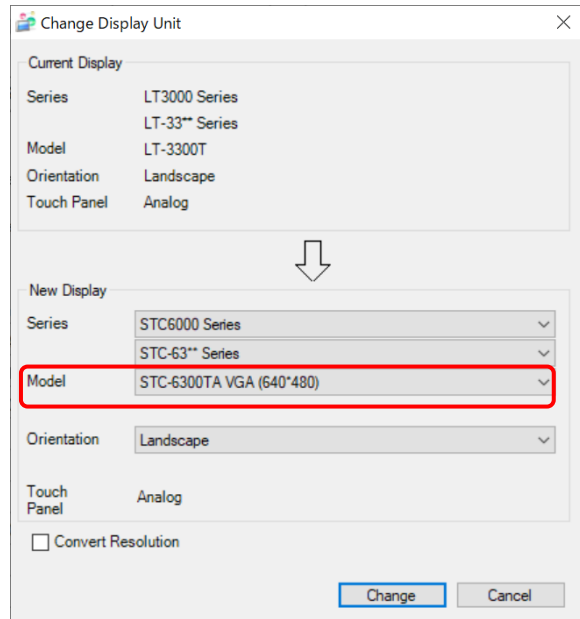

Change the Display unit from LT-3300T to STC-6300TA.

The display can be changed from the menu bar “Project” → “System Settings” → “Display” → “Change Display” in GP-Pro EX.

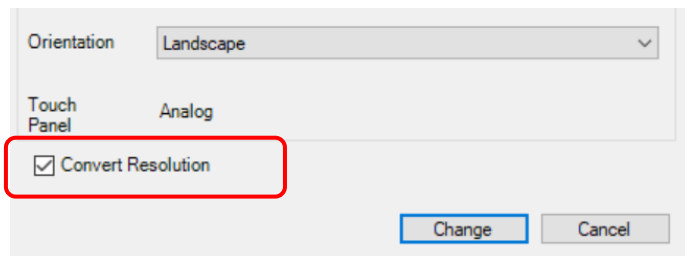

If you check on [Convert Resolution] when changing the Display Unit type (as shown below), you can adjust both size and location of the part and the text relative to the display resolution automatically. But still, you may need to adjust them manually. Please pay attention to the following points.



- A function that requires absolute coordinates. Please adjust the settings manually.
 - **Global window**
 - **Position Animation**
- Due to font size and resolution restrictions, manual changes may be required. Please resize them if needed
 - **Font:** In the case of using Standard font, the size will be smaller. You can improve by using Stroke font or Image font.
 - **Objects**
 - **Parts**
 - **Images**
 - **Alarm parts**
- Position may differ from the original project. Please check the coordinate of the window and adjust if needed.
 - **Window display**

3-1. Replacement Procedure – Transfer screen data to recommended substitute unit (GP-Pro EX)

In this section, we will introduce how to transfer screen data with a USB transfer cable as an example.

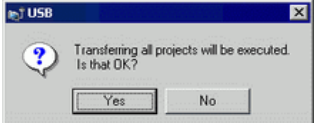
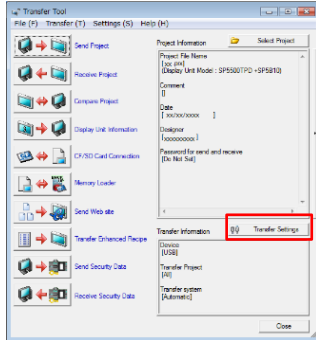
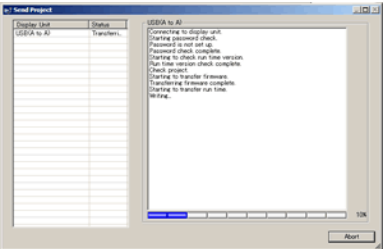
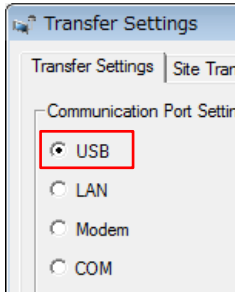
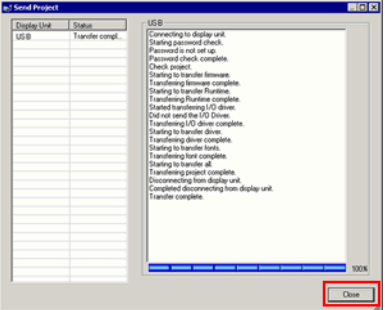
<p>1. Connect your PC and the recommended substitute unit with a USB transfer cable. If the driver of the cable has not been installed on you PC, a dialog box will appear. Please follow the instructions.</p>		<p>5. Click [Send Project]. In the dialog box that appears, set the connection key and click [OK].</p> <p>NOTE: If you forget the connection key, you will not be able to connect to the display unit. For more information about connection key, refer to GP-Pro EX reference manual (34.14.4 How the Connection Key Works).</p>	
<p>2. Turn on the power of Recommended substitute unit. The “Welcome” screen will appear on the display unit. After transferring a project file once, this screen will not appear again.</p>		<p>6. When this dialog box appears, click [Yes]. This dialog box is not displayed when the same project file is sent again.</p>	
<p>3. On the GP-Pro EX's State Toolbar, click the [Transfer Project] icon to open the Transfer Tool. To transfer a different project file, click the [Select Project] button and select a project file.</p>		<p>7. The transfer begins. The following dialog box appears during transfer, and you can check the communication status. (The display unit changes to Transferring mode and communication with the device/PLC is suspended.)</p>	
<p>4. Make sure that the [Device] in the “Transfer Settings Information” is set to [USB]. If not, click the [Transfer Setting] button to open the “Transfer Setting” dialog box. Select [USB] in the Communication Port Settings field and click [OK].</p>		<p>8. When transfer is completed, the state of the dialog box changes from [Transferring] to [Transfer Complete]. Click [Close] to close the dialog box.</p> <p>9. Close the Transfer Tool</p> <p>10. Click the [X] mark on top right of the screen or [Project] → [Exit] to close GP-Pro EX.</p>	

3-2. Software Compatibility – GP-Pro EX Supported Feature Comparison

Specification UP in STC-6300TA

NOT supported in STC-6300TA

GP-Pro EX Feature		LT-3300T	STC-6300TA
Display	Screen Area (Application memory, unit: byte)	6M	64M
	Portrait Installation	✓	✓
	Function Expansion Memory	-	-
	Installing the USB/RS-422/485 Conversion Adapters	-	✓
	MAC Address Display	✓	✓
External Storage	CF Card	-	-
	SD Card	-	-
	CFast Card	-	-
	USB storage	✓	✓
	FTP server	-	✓
System Settings	Drawing in 256 colors	✓	✓
	Reverse Display	-	-
	Color Blink	✓	-
	Synchronize Text Display with Text Table	-	✓
	Time Zone settings	-	-
	Detect Backlight Burnout	✓	-
	Dimmer settings	-	✓
	2-point touch / Multitouch	-	-
	Display the SD/USB Removal Icon	-	✓

3-2. Software Compatibility – GP-Pro EX Supported Feature Comparison

Specification UP in STC-6300TA

NOT supported in STC-6300TA

GP-Pro EX Feature		LT-3300T	STC-6300TA
System Settings	Screen Capture	✓	✓
	SRAM Auto Backup	-	✓USB storage can be used for the models without SD/CF card slots.
	Image Font	-	✓
	Bitmap Font	-	✓
	Standard Font	-	✓
	Port Control	-	✓
Device/PLC Communication	Number of Devices/PLCs that can communicate simultaneously	1 *1	2
	Specify Indirect Device	✓ *2	✓
	Import Device/PLC tags	-	✓
	Ethernet Multilink	-	✓
	Device Monitor	✓	✓
	Ladder Monitor	-	-
Transfer	Network Transfer	✓	✓
	Modem Transfer	✓	-
	SIO Transfer (COM Connection)	✓	-
	Memory loader feature	✓	✓
	CF/SD Card Connection	-	-
	Connection Key	-	✓

*1: GP-Pro EX Ver.3.1 or later is required in order to communicate with devices/PLCs.

*2: Indirect device occupies 1 MB of the Screen Area.

3-2. Software Compatibility – GP-Pro EX Supported Feature Comparison

Specification UP in STC-6300TA

NOT supported in STC-6300TA

GP-Pro EX Feature		LT-3300T	STC-6300TA
Common Settings	Change Backlight Color	-	-
	Clock Update Settings	-	✓
	Start Screen Settings	-	✓
	Date format on CSV file output	-	✓
	Divide destination folders by file numbers	-	✓
	Increase Alarm Type [Extended] settings and Text Table index numbers	-	-
	Alarm Message Multiple Line Display	-	✓
	Attach Data Value to Operation Log	-	✓
	Changing passwords at run time (CSV file)	-	✓
	Changing passwords at run time (password change screen)	-	✓
	Append Date/Time to CSV File Name	-	✓
	Transfer sampling CSV file to FTP	-	✓
	Transferring sampled data to the cloud	-	✓
	Indirectly specify Sampling Frequency and Alarm Settings	-	✓
	Sampling data/Enhanced recipe data format co-exist	-	✓
	Create a recipe (CSV data) index file at runtime	-	✓
	Enhanced Recipes	-	✓
	Extended Script copy file function	-	✓
	Global Trigger	-	✓

3-2. Software Compatibility – GP-Pro EX Supported Feature Comparison

Specification UP in STC-6300TA

NOT supported in STC-6300TA

GP-Pro EX Feature		LT-3300T	STC-6300TA
Common Settings	Movie record/play feature	-	-
	Use Image unit	-	-
	Sound Output Feature	-	-
	AUX	-	-
	Retentive Variables Function	✓	✓
Parts	Selector List	-	✓
	XY Graph (Historical Trend, Data Block Display Graph)	-	-
	Picture Display [CF Image Display] / [SD Image Display] for showing JPEG files	-	✓USB storage can be used for the models without SD/CF card slots.
	Indirectly specify a block of Alarm parts	-	✓
	Special Data Display [File Manager] sort function and default path	-	✓
	Special Data Display [File Manager] copy file to FTP	-	✓
	Message Display's Bulletin Message	-	✓
	Image Sensor Display	-	-
	Animation	-	✓
	Alarm History Message Flow Display	-	✓
	Alarm History / Sampling Data / Enhanced Recipe Data Refine Search / Sort Function	-	-
Alarm Analysis Function	-	-	

3-2. Software Compatibility – GP-Pro EX Supported Feature Comparison

Specification UP in STC-6300TA

NOT supported in STC-6300TA

GP-Pro EX Feature		LT-3300T	STC-6300TA
Logic	Logic Program Operation	✓	✓
	I/O Driver	✓	✓
	Function Block	✓	✓
Network	RPA Function (end of support from Ver.4.09.400)	-	-
	GP-Viewer EX	✓	✓
	Web Server (end of support from Ver.4.09.450)	-	-
	Camera-Viewer EX	-	-
	Pro-face Remote HMI	-	✓
	E-mail	-	✓
	GP Remote Printer Server	✓	✓
	Pro-face Connect (models you can register as SiteManager)	-	✓
	Pro-Server EX	✓	✓ ^{*1}
Input Equipment / Peripheral Equipment (USB Device)	USB Keyboard	✓	✓
	EZ Illuminated Switch	-	✓
	EZ Tower Light	-	✓
	EZ LAN Adapter	-	✓

*1 To use Pro-Server EX on STC-6300TA, GP-Pro EX Ver.4.09.550 or later is required.

3-2. Software Compatibility – Supported Software Version

Software	LT-3300T	STC-6300TA	Compatibility of Project Data
GP-Pro EX	✓ Ver. 3.01.200 or later	✓ Ver. 4.09.500 or later	✓
	https://www.pro-face.com/otasuke/files/manual/gpproex/new/refer/gpproex.htm		
Pro-Server EX	✓ Ver. 1.32 or later	✓ Ver. 1.37.300 or later *1	✓
	https://www.pro-face.com/otasuke/files/manual/soft/server_ex/v1_37/ref/SRPreface.htm		
Pro-face Remote HMI (iOS/Android)	-	✓ Ver. 1.60 or later	NEW
	-	https://www.pro-face.com/otasuke/qa/remotehmi/faq.html	
Pro-face Remote HMI Client for Win	-	✓ Ver. 1.42 or later	NEW
	-	https://www.proface.com/en/product/soft/remotehmi_client/download	
Pro-face Connect	-	✓ Ver. 9.6 or later	NEW
	-	https://www.proface.com/en/product/soft/proface_connect/download	

*1 To use Pro-Server EX on STC-6300TA, GP-Pro EX Ver.4.09.550 or later is required.

3-3. Other Important Notes on Software

- About Blink function
 - STC6000 Series do not support Blink function. Therefore, if you use the blink settings in LT-3300T, the settings will be cancelled after changing the display to STC6000 Series in GP-Pro EX.

LT-3300T

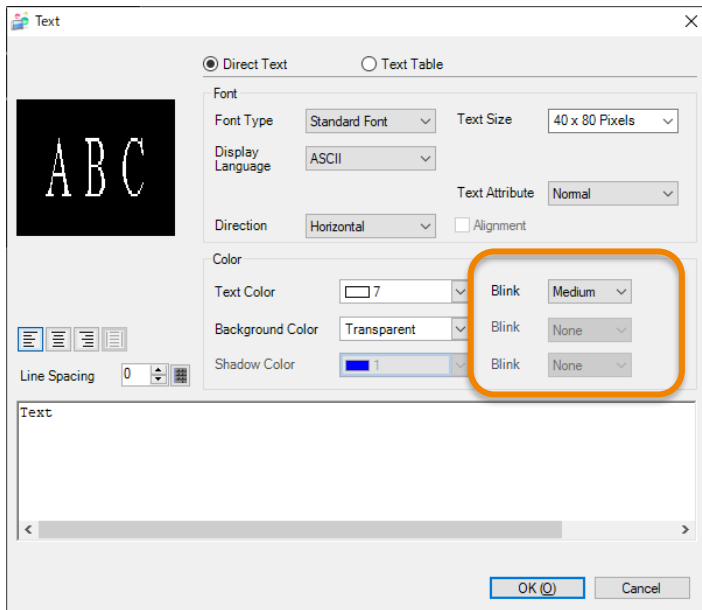

After converting the project to STC6000 Series

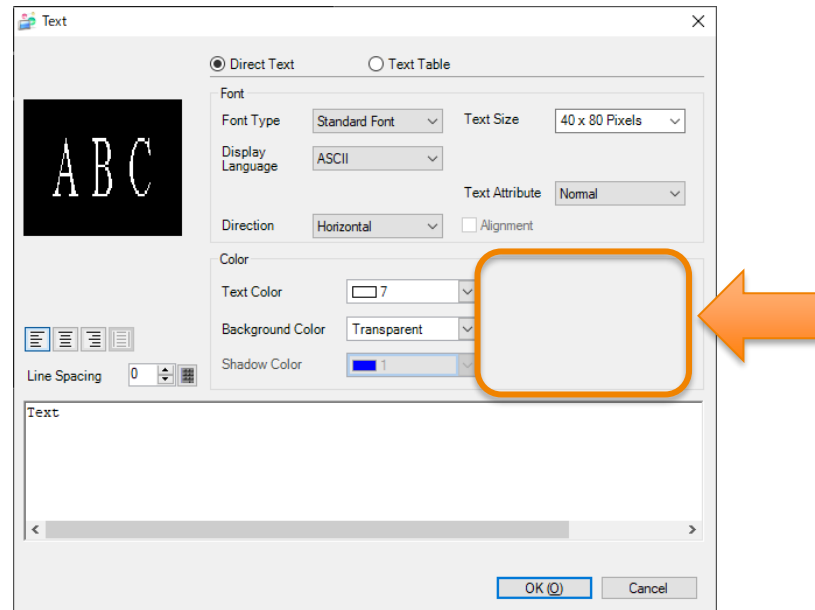

NOTE: We have a workaround to add blink functions to some of the parts/texts on STC6000 display by using the functions of the configuration software, GP-Pro EX. Refer to the following FAQ for the setting procedures.

<https://www.proface.com/en/support/faq/FAQ000268649>

3-3. Other Important Notes on Software – GP-Pro EX setting when using TM3 module

- TM3 Modules can be used as a successor to the EX modules.
- To connect EX modules to LT-3300T, [EXM Driver] is used as an external I/O driver. After converting LT-3300T screen data to STC-6300TA, the external I/O driver will automatically become [EXM Driver]. The I/O driver settings will be retained.
- TM3 module names do not appear in GP-Pro EX, so you need to select the equivalent EX module name instead. For example, to use TM3DI8, please select “EXM-DDI8DT”.

(Example) Display on GP-Pro EX

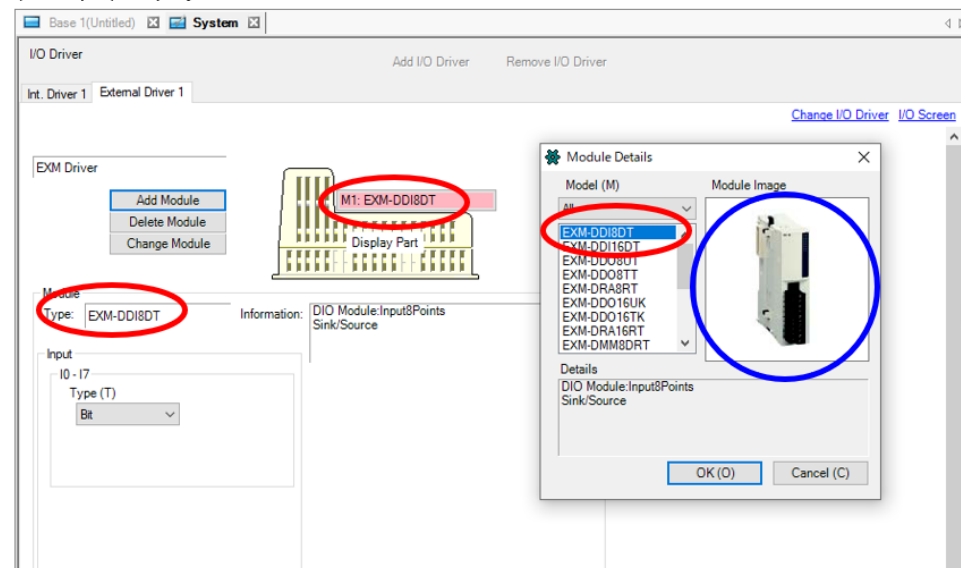

EX module	TM3 module
EXM-DDI8DT	TM3DI8
EXM-DDI16DT	TM3DI16
EXM-DRA8RT	TM3DQ8R
EXM-DRA16RT	TM3DQ16R
EXM-DDO8UT	TM3DQ8U
EXM-DDO16UK	TM3DQ16UK
EXM-DDO8TT	TM3DQ8T
EXM-DDO16TK	TM3DQ16TK
EXM-DMM8DRT	TM3DM8R
EXM-DMM24DRF	TM3DM24R
EXM-AMI2HT	TM3AI2H
EXM-ALM3LT	TM3TM3
EXM-AMM3HT	TM3TM3
EXM-AMO1HT	TM3AQ2
EXM-AMI4LT	TM3TI4
EXM-AVO2HT	TM3AQ2
EXM-AMM6HT	TM3AM6
EXM-ARI8LT *1	TM3TI4 (x 2) *1

*1: please refer to the next page for the GP-Pro EX setting.

- The setup process, error information, and limitations are the same as EX modules. Refer to [GP-Pro EX V4.0 Reference Manual](#) section “31.6 Controlling I/O in LT3000/STC6000 Series and EX Modules”, by replacing “EX module” with “TM3”.

3-3. Other Important Notes on Software – GP-Pro EX setting when using TM3 module

- STC-6300TA supports up to 2 units of TM3/EX module on Rear (Direct) Mounting, but you can select 3 modules in I/O Driver setting as the image below. (There will be no error message displayed.)
- If you use 3 units of TM3/EX modules, use Extension Mounting method by using TM3 Transmitter (P/N: TM3XTRA1) / Receiver (P/N: TM3XREC1) as described in [2-3. Hardware Compatibility – TM3/EX Module Connection](#).
- For these Transmitter and Receiver modules, no setting is required in GP-Pro EX.

< GP-Pro EX screen image >

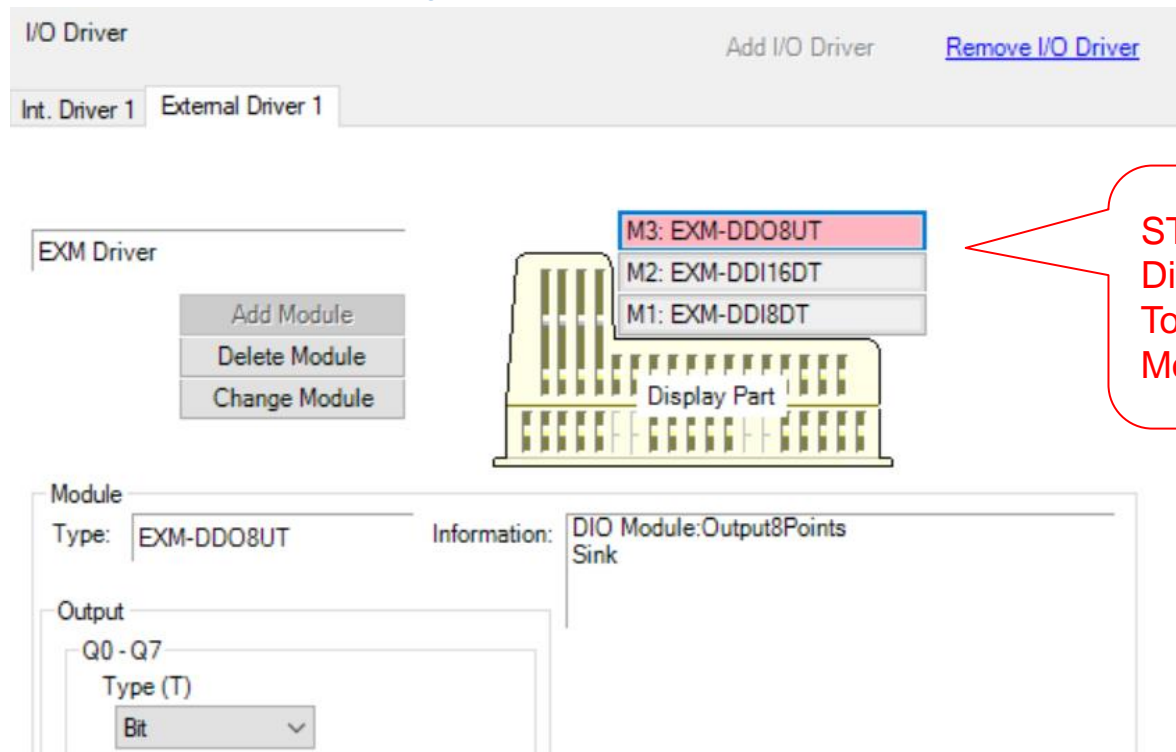

STC-6300TA supports 2 units on Direct mounting, not 3. To use 3 units, use Extension Mounting method.

3-3. Other Important Notes on Software – GP-Pro EX setting when using TM3 module

- EXM-ARI8LT is an 8-channel analog module, while the substitute model TM3TI4 has only 4 channels. Because of it, when 5 or more channels are used for EXM-ARI8LT, it's necessary to connect 2 units of TM3TI4 at the time of replacement.

Description	EX Module	TM3 Module
8-ch Temperature Pt100/ Pt1000 Input Module	EXM-ARI8LT	TM3TI4(G) x 2

In the condition above, EXM-ARI8LT needs to be changed to 2 units of EXM-AMI4LT for the module configuration on GP-Pro EX as shown below.

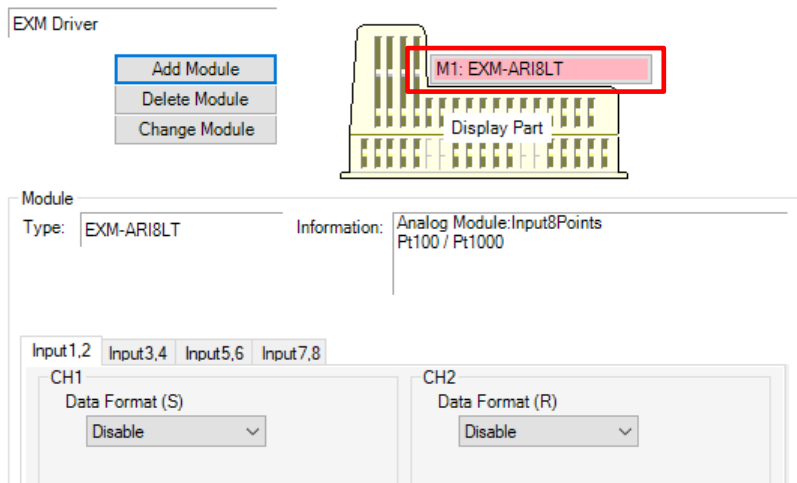

EXM-ARI8LT x1

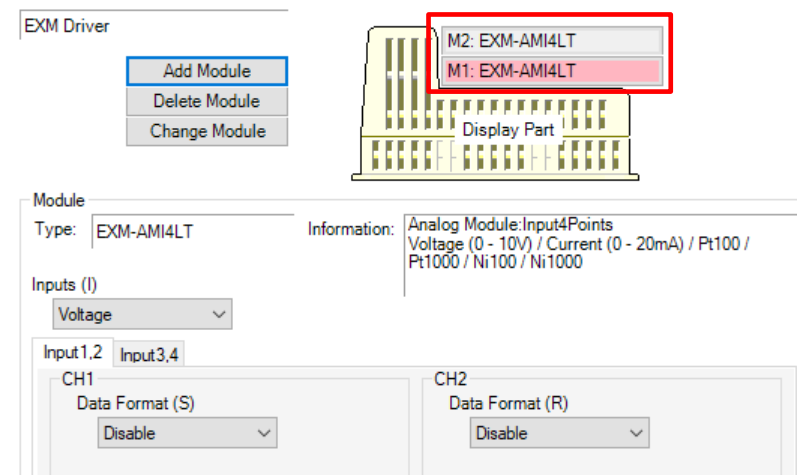
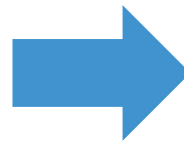

EXM-AMI4LT x2

In case of connecting 3 units of TM3 / EX modules with STC6000 Series

If you connect 3 units of TM3/EX modules on STC-6300TA, Transmitter (TM3XTRA1) and Receiver (TM3XREC1) are required. Please connect with one of the following configurations.

- When mounting Transmitter only on the back of STC6000, you can connect max. 3 units of TM3/EX modules at Receiver side.

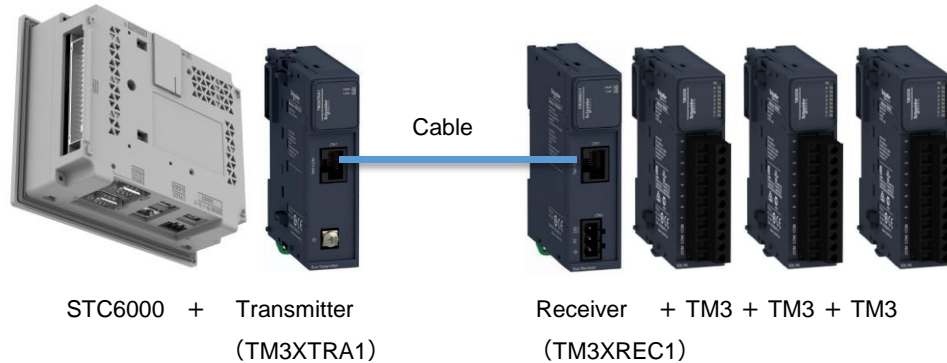

- When mounting one TM3/EX module and Transmitter on the back of STC6000, you can connect max. 2 units of TM3/EX modules at Receiver side.

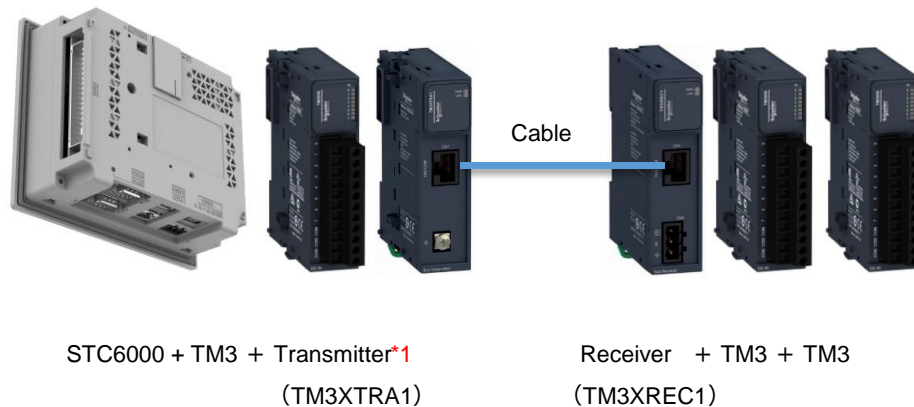

*1 When mounting one TM3 module and one transmitter module on the rear of STC6000 Series, mount TM3 module first, and then mount the transmitter module as a 2nd unit.

NOTE: There's no setting required in Software for Transmitter and Receiver. Only 1 set of Transmitter and Receiver can be connected to 1 unit of STC6000. TM3 modules and EX modules can be used at the same time.

