



Easy! Smooth! Replacement Guidebook

ST-3301T/S/B, ST-3302B → ST6000 Series GP-Pro EX Model (ST-6300TA)

The 2nd Edition August 2024

SE01-Guide-ST330xtoST6300TA-EN-02

*Products may be changed or discontinued without notice. Please check our website for the latest information.

Update History

Date	Edition	Updated Slide	Description
2023/09/08	1 st	-	Newly created
2024/08/23	2 nd	Slide 39	Added information of the workarounds for Blink function on ST6000 Series

Legal Information

The Pro-face brand and any trademarks of Schneider Electric SE and its subsidiaries referred to in this guide are the property of Schneider Electric SE or its subsidiaries. All other brands may be trademarks of their respective owners.

This guide and its content are protected under applicable copyright laws and furnished for informational use only. No part of this guide may be reproduced or transmitted in any form or by any means (electronic, mechanical, photocopying, recording, or otherwise), for any purpose, without the prior written permission of Schneider Electric.

Schneider Electric does not grant any right or license for commercial use of the guide or its content, except for a non-exclusive and personal license to consult it on an "as is" basis. Schneider Electric products and equipment should be installed, operated, serviced, and maintained only by qualified personnel.

As standards, specifications, and designs change from time to time, information contained in this guide may be subject to change without notice.

To the extent permitted by applicable law, no responsibility or liability is assumed by Schneider Electric and its subsidiaries for any errors or omissions in the informational content of this material or consequences arising out of or resulting from the use of the information contained herein.

As part of a group of responsible, inclusive companies, we are updating our communications that contain non-inclusive terminology. Until we complete this process, however, our content may still contain standardized industry terms that may be deemed inappropriate by our customers.

Safety Information

Important Information

Read these instructions carefully and look at the equipment to become familiar with the device before trying to install, operate, service, or maintain it. The following special messages may appear throughout this documentation or on the equipment to warn of potential hazards or to call attention to information that clarifies or simplifies a procedure.



The addition of this symbol to a “Danger” or “Warning” safety label indicates that an electrical hazard exists which will result in personal injury if the instructions are not followed.



This is the safety alert symbol. It is used to alert you to potential personal injury hazards. Obey all safety messages that follow this symbol to avoid possible injury or death.

DANGER

DANGER indicates a hazardous situation which, if not avoided, will result in death or serious injury.

CAUTION

CAUTION indicates a hazardous situation which, if not avoided, could result in minor or moderate injury.

WARNING

WARNING indicates a hazardous situation which, if not avoided, could result in death or serious injury.

NOTICE

NOTICE is used to address practices not related to physical injury.

Please Note

Electrical equipment should be installed, operated, serviced, and maintained only by qualified personnel. No responsibility is assumed by Schneider Electric for any consequences arising out of the use of this material.

A qualified person is one who has skills and knowledge related to the construction and operation of electrical equipment and its installation and has received safety training to recognize and avoid the hazards involved.

About this book

Document Scope

This guidebook introduces the procedures to replace a unit from “GP3000 Series (GP-3300S/L, GP-3301S/L)” to “ST6000 Series GP-Pro EX Model (ST-6300TA)”. The recommended substitute models are as follows.

Model in use			Recommended substitutes	
ST-3301T	AST3301-T1-D24 (PFXST3301TAD)*1	→	ST-6300TA	PFXST6300TADE
ST-3301S	AST3301-S1-D24 (PFXST3301SAD)*1			
ST-3301B	AGP3301-B1-D24 (PFXST3301BAD)*1			
ST-3302B (MPI)	AST3302-B1-D24 (PDXST3302BAD)*1			

*1: End of Sale on September 30, 2013

Validity Note

This documentation is valid for this product.

The technical characteristics of the devices described in the present document also appear online. To access the information online, go to our website.

<https://www.pro-face.com>

The characteristics presented in the present document should be the same as those that appear online. In line with our policy of constant improvement we may revise content over time to improve clarity and accuracy. In the event that you see a difference between the document and online information, use the online information as your reference.

Registered Trademarks

Product names used in this manual may be the registered trademarks owned by the respective proprietors.

About this book

Related Documents

You can download the manuals related to this product, such as the software manual, from our website.

<https://www.proface.com/en/download/search>

Product Related Information

If the equipment is used in a manner not specified by the manufacturer, the protection provided by the equipment may be impaired.

DANGER

HAZARD OF ELECTRIC SHOCK, EXPLOSION, OR ARC FLASH

- Remove all power from the device before removing any covers or elements of the system, and prior to installing or removing any accessories, hardware, or cables.
- Unplug the power cable from both this product and the power supply prior to installing or removing the product.
- Always use a properly rated voltage sensing device to confirm power is off where and when indicated.
- Replace and secure all covers or elements of the system before applying power to this product.
- Use only the specified voltage when operating this product. This product is designed to use 24 Vdc. Always check whether your device is DC powered before applying power.
- When using ST-6•00TA in Class I, Division 2, Groups A, B, C, and D hazardous locations, install this product in an enclosure that prevents the operator from touching the back of this product without the use of tools.

Failure to follow these instructions will result in death or serious injury.

About this book

⚠ DANGER

POTENTIAL FOR EXPLOSION

For ST-6•00WA:

- Do not use this product in hazardous environments.
- Do not connect or disconnect this product unless power has been switched off or the area is known to be non-hazardous.
- Do not attempt to install, operate, modify, maintain, service, or otherwise alter this product except as permitted in this manual.
- Confirm that the USB cable has been attached with the USB cable clamp before using the USB interface.
- Use the USB (micro-B) interface for temporary connection only during maintenance and setup of the device.

Failure to follow these instructions will result in death or serious injury.

For ST-6•00TA installation in hazardous location, refer to [Hazardous Location Installation - For USA and Canada](#).

Critical alarm indicators and system functions require independent and redundant protection hardware and/or mechanical interlocks.

When you cycle power, wait at least 10 seconds after it has been turned off. If this product is restarted too quickly, it may not operate correctly.

In the event the screen cannot be properly read, for example, if the backlight is not functioning, it may be difficult or impossible to identify a function. Functions that may present a hazard if not immediately executed, such as a fuel shut-off, must be provided independently of this product. The machine's control system design must take into account the possibility of the backlight no longer functioning and the operator being unable to control the machine or making mistakes in the control of the machine.

⚠ WARNING

LOSS OF CONTROL

- The designer of any control scheme must consider the potential failure modes of control paths and, for certain critical control functions, provide a means to achieve a safe state during and after a path failure. Examples of critical control functions are emergency stop and overtravel stop, power outage and restart.
- Separate or redundant control paths must be provided for critical control functions.
- System control paths may include communication links. Consideration must be given to the implications of unanticipated transmission delays or failures of the link.
- Observe all accident prevention regulations and local safety guidelines.
- Each implementation of this product must be individually and thoroughly tested for proper operation before being placed into service.
- The machine control system design must take into account the possibility of the backlight no longer functioning and the operator being unable to control the machine, or making errors in the control of the machine.

Failure to follow these instructions can result in death, serious injury, or equipment damage.

For additional information, refer to NEMA ICS 1.1 (latest edition), "Safety Guidelines for the Application, Installation, and Maintenance of Solid State Control" and to NEMA ICS 7.1 (latest edition), "Safety Standards for Construction and Guide for Selection, Installation and Operation of Adjustable-Speed Drive Systems" or their equivalent governing your particular location.

⚠ WARNING

UNINTENDED EQUIPMENT OPERATION

- The application of this product requires expertise in the design and programming of control systems. Only persons with such expertise should be allowed to program, install, alter, and apply this product.
- Follow all applicable safety standard, local regulations and directives.

Failure to follow these instructions can result in death, serious injury, or equipment damage.

About this book

⚠ WARNING

UNINTENDED EQUIPMENT OPERATION

- Do not use this product as the only means of control for critical system functions such as motor start/stop or power control.
- Do not use this equipment as the only notification device for critical alarms, such as device overheating or overcurrent.
- Use only the software provided with this product. If you use other software, please confirm the operation and safety before use.

Failure to follow these instructions can result in death, serious injury, or equipment damage.

The following characteristics are specific to the LCD panel and are considered normal behavior:

- LCD screen may show unevenness in the brightness of certain images or may appear different when seen from outside the specified viewing angle. Extended shadows, or crosstalk may also appear on the sides of screen images.
- LCD screen pixels may contain black and white colored spots and color display may seem to have changed.
- When experiencing vibrations within a certain frequency range and vibration acceleration is above what is acceptable, the LCD screen may partially turn white. Once the vibration condition ends, the whitening of the screen is resolved.
- When the same image is displayed on the screen for a long period, an afterimage may appear when the image is changed.
- The panel brightness may decrease when used for a long time in an environment continuously filled with inert gas. To prevent deterioration of panel brightness, regularly ventilate the panel. For more information, please contact customer support.

<https://www.pro-face.com/trans/en/manual/1015.html>

⚠ WARNING

SERIOUS EYE AND SKIN INJURY

The liquid in the LCD panel contains an irritant:

- Avoid direct skin contact with the liquid.
- Wear gloves when you handle a broken or leaking unit.
- Do not use sharp objects or tools in the vicinity of the LCD panel.
- Handle the LCD panel carefully to prevent puncture, bursting, or cracking of the panel material.
- If the panel is damaged and any liquid comes in contact with your skin, immediately rinse the area with running water for at least 15 minutes. If the liquid gets in your eyes, immediately rinse your eyes with running water for at least 15 minutes and consult a doctor.

Failure to follow these instructions can result in death, serious injury, or equipment damage.

NOTICE

REDUCTION OF SERVICE LIFE OF PANEL

Change the screen image periodically and try not to display the same image for a long period of time.

Failure to follow these instructions can result in equipment damage.

Cybersecurity

Cybersecurity Best Practices

To help keep your Pro-face products secure and protected, we recommend that you implement the cybersecurity best practices.

Following the recommendations may help significantly reduce your company's cybersecurity risk. For the recommendations, refer to the following URL:

<https://www.pro-face.com/trans/en/manual/1087.html>

Hazardous Location Installation - For USA and Canada

General

ST-6•00TA is suitable for use in Class I, Division 2, Groups A, B, C, and D hazardous locations or in non-hazardous locations. Before installing or using this product, confirm that the Hazardous Location certification appears on the product labeling.

NOTE: Some products are not yet rated as suitable for use in hazardous locations. Always use your product in conformance with the product labeling and this manual.

DANGER

HAZARD OF ELECTRIC SHOCK, EXPLOSION, OR ARC FLASH

- Remove all power from the device before removing any covers or elements of the system, and prior to installing or removing any accessories, hardware, or cables.
- Unplug the power cable from both this product and the power supply.
- Always use a properly rated voltage sensing device to confirm power is off where and when indicated.
- Replace and secure all covers or elements of the system before applying power to this product.
- Use only the specified voltage when operating this product. This product is designed to use 24 Vdc. Always check whether your device is DC powered before applying power.

Failure to follow these instructions will result in death or serious injury.

WARNING

EXPLOSION HAZARD

- Do not use this product in hazardous environments or locations other than Class I, Division 2, Groups A, B, C, and D.
- Substitution of any components may impair suitability for Class I, Division 2.
- Always confirm the UL 121201 or CSA C22.2 No.213 hazardous location rating of your device before installing or using it in a hazardous location.
- To apply or remove the supply power from this product installed in a Class I, Division 2 hazardous location, you must either: A) Use a switch located outside the hazardous environment, or B) Use a switch certified for Class I, Division 1 operation inside the hazardous area.
- Do not connect or disconnect equipment unless power has been switched off or the area is known to be non-hazardous. This applies to all connections including power, ground, serial, parallel, and network connections.
- Do not install any components, equipment, or accessories manufactured by us or by OEM unless these have also been qualified as suitable for use in Class I, Division 2, Groups A, B, C, and D locations.
- Never use unshielded/ungrounded cables in hazardous locations.
- Use only non-incendive USB devices.
- Do not attempt to install, operate, modify, maintain, service, or otherwise alter this product except as permitted in this manual. Unpermitted actions may impair the suitability of this product for Class I, Division 2 operation.

Failure to follow these instructions can result in death, serious injury, or equipment damage.

Make sure that this product is properly rated for the location. If the intended location does not presently have a Class, Division and Group rating, then users should consult the appropriate authorities having jurisdiction in order to determine the correct rating for that hazardous location.

Hazardous Location Installation - For USA and Canada

Operation and Maintenance

The systems have been designed for compliance with relevant spark ignition tests.

▲ WARNING

EXPLOSION HAZARD

In addition to the other instructions in this manual, observe the following rules when installing this product in a hazardous location:

- Wire the equipment in accordance with the National Electrical Code article 501.10 (B) for Class I, Division 2 hazardous locations.
- Install this product in an enclosure suitable for the specific application.

Failure to follow these instructions can result in death, serious injury, or equipment damage.

NOTE: IP65F is not part of UL certification.

Table of Contents

1

[Summary](#)

2

[Hardware Section](#)

2-1

[Specification Comparison](#)

2-2

[Standards Compatibility](#)

2-3

[Interface Compatibility](#)

2-4

[Installation Method Compatibility](#)

2-5

[Option Compatibility](#)

2-6

[Other Important Notes on Hardware](#)

3

[Software Section](#)

3-1

[Replacement Procedure](#)

3-2

[Software Compatibility](#)

3-3

[Other Important Notes on Software](#)

1. Summary

The replacement from ST3000 Series (ST-3301T/S/B, ST-3302B) to ST6000 Series GP-Pro EX Model (ST-6300TA) generally keeps compatibility, but the followings are the main points to note.

- Display Type: As the display type of ST-6300TA (that is TFT Color LCD) is different from ST-3301S/B and ST-3302B. As the screen will look different, please check on the actual unit.
- Display resolution: ST-6300TA has a better resolution than ST3000 Series. You need to convert resolution by the software to use old project data. To check the replacement procedure, refer to [3. Software Section](#) in this document.

ST3000 Series (5.7") ST-3301T/S/B, ST-3302B	320 x 240 pixels (QVGA)	ST6000 Series (5.7") ST-6300TA	640 x 480 pixels (VGA)
--	-------------------------	-----------------------------------	------------------------

- External dimensions: The panel cut dimensions are the same, but the external dimensions are different. It is necessary to check the dimensions of the HMI installation location.

ST3000 Series (5.7") ST-3301T/S/B, ST-3302B	W167.5×H135×D59.5mm	ST6000 Series (5.7") ST-6300TA	W169.5 x H137 x D58 mm
--	---------------------	-----------------------------------	------------------------

- Serial Interface: The serial interface specification of ST-6300TA is generally the same as ST3000 Series except for ST-3302B (MPI type). For details, refer to [“2-5: Other Important Notes on Hardware”](#).



2. Hardware Section

2-1. ST-3301T/S/B, ST-3302B vs ST-6300TA Specification Comparison - 1. Basic Information -

		ST-3301T	ST-3301S	ST-3301B	ST-3302B	ST-6300TA	Points to note when replacing
Display type		TFT color LCD	STN Color LCD	Monochrome Blue Mode LCD		TFT color LCD	
Display size		5.7"				5.7"	
Resolution		320 x 240 pixels (QVGA)				640 x 480 pixels (VGA)	Need to change resolution setting by software
Display colors		256 colors (without blink) / 64 colors (with blink)		8 Shades		262,000 colors	
Backlight		CCFL (Not replaceable)				White LED (not replaceable)	
Backlight service life		50,000 hours or more (continuous operation at 25° C before backlight brightness decreases to 50%)	75,000 hours or more (continuous operation at 25° C before backlight brightness decreases to 50%)	58,000 hours or more (continuous operation at 25° C before backlight brightness decreases to 50%)		50,000 hours or more (continuous operation at 25° C before backlight brightness decreases to 25%)	
Panel cut dimensions		W156 x H123.5 mm				W156 x H123.5 mm	
External dimensions		W167.5×H135×D59.5mm				W169.5 x H137 x D58 mm	
Touch panel type		Resistive film (analog, single touch)				Resistive film (analog, single touch)	
Touch panel service life		1 million times or more				1 million times or more	
Memory	Application memory	FLASH EPROM 6MB				FLASH EPROM 64MB	Refer to FAQ for the available capacity of each memory
	Backup memory	SRAM 320KB				NVRAM 320KB	
Battery (clock data backup)		Rechargeable battery / Secondary battery				Replaceable battery / Primary battery	Can be replaced by user
Rated input voltage		DC 24V				DC 24V	
Power Consumption		18W or less				8.9 W	

2-1. ST-3301T/S/B, ST-3302B vs ST-6300TA Specification Comparison - 2. Interface -

		ST-3301T	ST-3301S	ST-3301B	ST-3302B	ST-6300TA	Points to note when replacing
Serial I/F	COM1	RS-232C (D-Sub 9pin Plug)				RS-232C (D-Sub 9pin Plug)	Please refer to 2.5. Other important notes on Hardware in this document.
	COM2	RS-422/485 (D-Sub 9pin Plug) *1			RS-485 (MPI only) (D-Sub 9pin Socket)	RS-422/485 (D-Sub 9pin Plug)	
Ethernet I/F		-				10BASE-T/100BASE-TX (RJ-45) x 1	
CF Card I/F		-				-	
SD Card I/F		-				-	
USB I/F	Type A	USB 1.1 x 1 - USB transfer cable (CA3-USBCB-01)				USB 2.0 x1	No screen data transfer via Type A.
	Type mini-B	-				-	
	Type micro-B	-				USB 2.0 x1 - USB transfer cable (PFXZUSCBMB2) or commercial USB micro-B transfer cable	
Auxiliary I/O I/F		-				-	
Sound Output I/F		-				-	
Expansion Unit I/F		-				-	

*1: RS-485 is compliant with AST-3301S / AST-3301B with revision code "B" or later.

Hardware Manual: [ST6000 Series Hardware Manual](#)

2-2. Standards Compatibility

Certification	ST-3301T/S/B, ST-3302B	ST-6500TA
CE (EN61000-6-4, EN61000-6-2, EN61131-2)	✓	✓
UKCA	-	✓
UL/cUL	✓ (UL508) (CSA C22.2 No.142)	✓ (UL61010-2-201) (CSA C22.2 No.61010-2-201)
UL/cUL Class 1, Div. 2	-	✓ (UL121201) (CSA C22.2 No213)
ATEX (Zones 2/22, equipment category 3 Gas Dust)	-	Planned *1
IECEX (Zones 2/22, equipment category 3 Gas Dust)	-	Planned *1
UKEX	-	Planned *1
KCs	-	Planned *1
NEPSI → CCC-Ex	-	Planned *1
RCM (C-Tick)	-	✓
EAC (GOST-R)	✓	✓
RoHS for EU	✓	✓
RoHS for China	✓	✓
REACH	✓	✓
CCC *apply for CCC exemption	-	-
KC	✓	✓
Marine (DNV, ABS, LR, BV, NK, RINA, CCS)	-	Certified by EU RO MR *2
WEEE	✓	✓

*1: Please contact our Customer Service for the latest information.

*2: EU RO MR (EU Recognized Organization Mutual Recognition) covers ABS, BV, CCS, CRS, DNV, IRS, KR, LR, NK, PRS and RINA.

2-3. Interface Compatibility

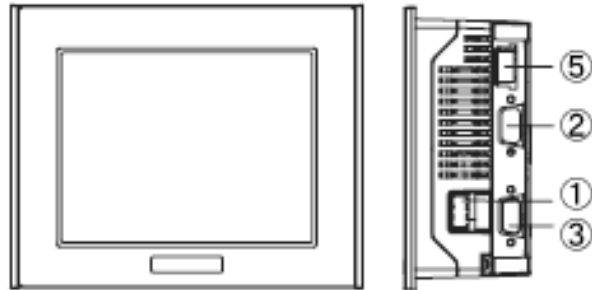

ST-3301T/S/B, ST-3302B

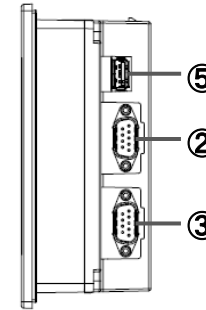

ST-6300TA Right

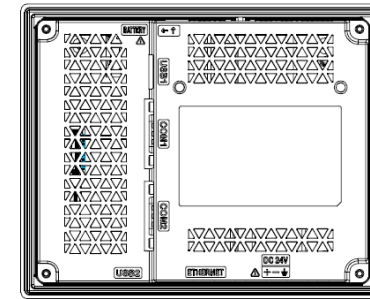

ST-6300TA Rear

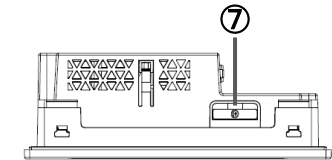

ST-6300TA Top

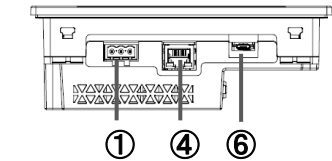

ST-6300TA Bottom

	ST-3301T/S/B, ST-3302B	ST-6300TA
①	Power Connector (DC)	Power Connector (DC)
②	Serial Interface (COM1)	Serial Interface (COM1)
③	Serial Interface (COM 2)	Serial Interface (COM 2)
④	-	Ethernet Interface
⑤	USB (Type A) Interface	USB (Type A) Interface
⑥	-	USB (micro-B) Interface
⑦	-	Battery Slot

NOTE: Please be careful when replacing, as the wiring will change significantly.

Please check [ST6000 Series Hardware Manual](#) for details such as interface specifications and pin assignments.

2-3. Installation Method Compatibility

Panel Cut Dimensions of ST-6300TA are the same as ST-3301T/S/B and ST-3302B.

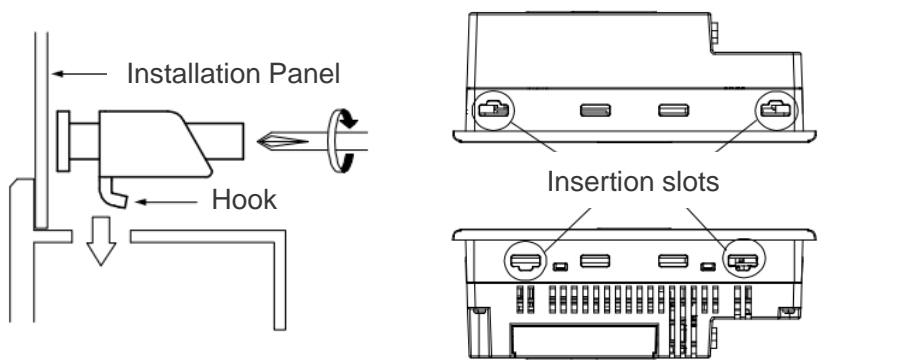
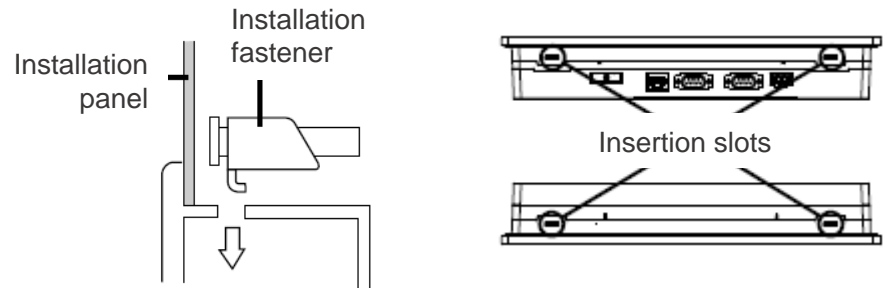
ST-3301T/S/B, ST-3302B	ST-6300TA
<p>Insert the installation fastener hooks into the insertion slots of this product.</p> <p>In a clockwise direction, tighten the installation fastener's screws with a screwdriver. The necessary torque is 0.5 N•m.</p>  <p>■ Panel Cut Dimensions</p> <p>Unit: mm[in.]</p> <p>A: 156 mm (+1/-0 mm) B: 123.5 mm (+1/-0 mm) C: 1.6~5.0 mm</p>	<p>Insert the installation fastener hooks into the insertion slots of this product.</p> <p>In a clockwise direction, tighten the installation fastener's screws with a screwdriver. The necessary torque is 0.5 N•m.</p>  <p>■ Panel Cut Dimensions</p> <p>mm (in)</p> <p>A: 156 mm (+1/-0 mm) B: 123.5 mm (+1/-0 mm) C: 1.6~5.0 mm</p>

NOTE: The installation fasteners for ST3000 Series (P/N: CA3-ATFALL-01) cannot be used for ST-6300TA. Please use the fasteners for ST-6300TA (P/N: PFXZC3AT1). Please check [ST6000 Series Hardware Manual](#) for installation requirements and procedure.

2-4. Option compatibility – Serial Interface

Product Name	ST-3300	ST-6300TA	Description	Compatibility
RS-232C Cable (5m)	CA3-CBL232/5M-01	CA3-CBL232/5M-01	Cable for RS-232C connection between various hosts and this product	✓
RS-422 Cable (5m)	CA3-CBL422/5M-01	CA3-CBL422/5M-01	Cable for RS-422 connection between various hosts and this product (Socket Type)	✓
RS-422 Cable (5m)	CA3-CBL422-01	CA3-CBL422-01	Cable for RS-422 connection between various hosts and this product (Plug Type)	✓
Mitsubishi PLC A-Series Connection Cable (5m)	CA3-CBLA-01	CA3-CBLA-01	Cable for directly connecting an A Series CPU	✓
Mitsubishi PLC Q-Series Connection Cable (5m)	CA3-CBLQ-01	CA3-CBLQ-01	Cable for directly connecting a Q Series CPU	✓
Mitsubishi PLC Q-Series Link Cable (5m)	CA3-CBLLNKM-01	CA3-CBLLNKM-01	Cable for directly connecting a Q Series Link Unit	✓
Mitsubishi PLC FX-Series Connection Cable	CA3-CBLFX/1M-01 (1m) CA3-CBLFX/5M-01 (5m)	CA3-CBLFX/1M-01 (1m) CA3-CBLFX/5M-01 (5m)	Cable for directly connecting an FX Series CPU	✓
Omron PLC SYSMAC Link Cable (5m)	CA3-CBLSYS-01	CA3-CBLSYS-01	Cable for directly connecting a SYSMAC Link Unit	✓
Siemens TTY Converter Cable (5m)	CA6-CBLTTY/5M-01	CA6-CBLTTY/5M-01	Cable for connecting a PLC S5 series to this product	✓
MPI Cable (3.5m)	ST03-A2B-MPI21-PFE CA3-MPI-PG1-PFE CA3-MPI-PGN-PFE	ST03-A2B-MPI21-PFE	Connects a host controller to this product for MPI communication.	✓
Multi-Link Cable (5m)	CA3-CBLMLT-01 * End of sale	CA3-CBLMLT-01 * End of sale	Connects a host controller to this product for multi-link (n:1) communication.	✓
	-	PFXZCBCBML1		NEW

2-4. Option compatibility – Serial Interface

Product Name	ST-3300	ST-6300TA	Description	Compatibility
RS-232C 9-pin/25-pin Conversion Cable (20cm)	CA3-CBLCBT232-01	CA3-CBLCBT232-01	Cable for converting a D-Sub 9-pin plug to a D-Sub 25-pin socket	✓
RS-422C 9-pin/25-pin Conversion Cable (20cm)	CA3-CBLCBT422-01 *End of sale	CA3-CBLCBT422-01 *End of sale	Cable for converting a D-Sub 9-pin plug to a D-Sub 25-pin socket	✓
	-	PFXZCBCBCVR41		NEW
2 Port Adapter Cable (5m)	CA3-MDCB11 *End of sale	CA3-MDCB11 *End of sale	Connects Mitsubishi PLC to this product using 2 port adapter II (RS-422).	✓
Mitsubishi PLC A, QnA, FX Series 2 Port Adapter II	GP070-MD11 *End of sale	GP070-MD11 *End of sale	Allows simultaneous use of this product and a Mitsubishi PLC A, QnA, FX Series peripheral device.	✓
COM Port Conversion Adapter	CA3-ADPCOM-01	CA3-ADPCOM-01	Connects optional RS-422 communication items to serial interface.	✓
RS-422 Terminal Block Conversion Adapter	-	PFXZCBADTM1	Connects output from a serial interface (D-sub 9 pin plug) directly to an RS-422 terminal block.	NEW
Terminal Block Conversion Adapter	CA3-ADPTRM-01	CA3-ADPTRM-01	Connects output from a serial interface (D-sub 9 pin socket) directly to an RS-422 terminal block.	✓
RS-232C Isolation Unit *1	CA3-ISO232-01	CA3-ISO232-01	Connects a host controller to this product and provides isolation (RS-232C and RS-422 are switchable).	✓
Siemens COM Port Conversion Adapter	CA3-ADPSEI-01	-	Connects Siemens PLCs to the AGP. (for RS-485 communication)	-

***1:** You can use RS-232C isolation unit (CA3-ISO232-01) for GP4000 series instead. In this case, select "VCC" from [System Settings] -> [Device/PLC] in the [Project] menu on GP-Pro EX.

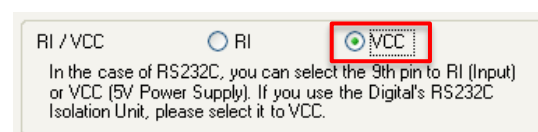

2-4. Option compatibility – USB Interface

Product Name	ST-3300	ST-6300TA	Description	Compatibility
USB Transfer Cable (2m)	CA3-USBCB-01	-	Cable for transferring screen data between a PC (USB Type A) and this product (USB Type A)	- A to A screen transfer is not available.
USB Transfer Cable	-	PFXZUSCBMB2	Cable for transferring screen data from a PC (USB Type A) to this product (USB micro-B)	NEW
USB Cable (5m)	FP-US00	FP-US00	Connects a USB printer (Type B)	✓
USB Front Cable (1m)	CA5-USBEXT-01	CA5-USBEXT-01	Extension cable that attaches USB interface (Type A) to front panel	✓
USB (micro-B) Front Cable	-	PFXZCIEXMB2	Extension cable that attaches USB interface (micro-B) to front panel	NEW
USB Clamp Type A (1 port)	-	PFXZCBCLUSA1	Clamp to prevent disconnection of USB cable (USB/A, 1 port, 5 clamps/set)	NEW
USB-Serial (RS-232C) Conversion Cable (0.5m)	CA6-USB232-01	CA6-USB232-01	Cable for converting a USB interface into a serial interface (RS-232C)	✓
USB/RS-422/485 Conversion Adapter	-	PFXZCBCBCVUSR41	Adapter for connecting this product (USB Type A) to an external device (RS-422/RS-485)	NEW
EZ Tower Light tube mounting fixing plate	-	PFXZCETWHA1	USB Connection Type Monolithic EZ Tower Light tube mounting with fixing plate 3 tiers, Ø60, lighting and flashing with a buzzer	NEW
EZ Tower Light with base mounting	-	PFXZCETWW1	USB Connection Type Monolithic EZ Tower with base mounting 3 tiers, Ø60, lighting and flashing with a buzzer	NEW
EZ Illuminated Switch	-	PFXZCCEUSG1	A unit of 5 illuminated switches with multiple color LED easily connected with this product unit via USB	NEW
EZ Numpad	-	PFXZCCEUKB1 *End of sale	Numpad connected to this product via USB	NEW
EZ Fingerprint Recognition Unit	-	PFXZCCEUSS1 *End of sale	Fingerprint recognition unit connected to this product via USB	NEW
EZ LAN Adapter	-	PFXZCGEUUE1	An adapter to expand an Ethernet port to HMI	NEW

2-4. Option compatibility – Other options, Maintenance options

Product Name		ST-3300	ST-6300TA	Description	Compatibility
Screen Protection Sheet	ST-3300	CA3-DFS6-01	-	Disposable, dirt-resistant sheet for the screen of this product. (5 sheets/set) (Hard type)	NEW Use the option for ST6000 series.
	ST-6300TA	-	PFXZCBDS61		
UV Protection Sheet	ST-3300	CA4-DCMDL-01	-	Sheet to protect the display from ultraviolet light, for 5.7-inch screen (1 sheet).	NEW Use the option for ST6000 series.
	ST-6300TA	-	PFXZCBOP61		

Product Name		ST-3300	ST-6300TA	Description	Compatibility
Installation Fastener	ST-3300	CA3-ATFALL-01	-	Installation fastener (4 pieces/set)	NEW Use the option for ST6000 series.
	ST-6300TA	-	PFXZC3AT1		
Installation Gasket	ST-3300	CA3-WPG6-01	-	Provides dust and moisture resistance when this product is installed into a solid panel (1 piece).	NEW Use the option for ST6000 series.
	ST-6300TA	-	PFXZHWG31		
Connector Cover		CA3-BUSCVR-01	-	Protects this product's rear face connector	-
USB Cable Clamp (1 port)		CA5-USBATM-01	-	USB Cable clamp for 2 port products to prevent disconnection	-
DC Power Supply Connector		CA5-DCCNM-01	CA5-DCCNM-01	Connector to connect DC power supply cables	✓
Battery for Data Backup		-	PFXZGEBT1	Primary battery for memory and time data backup (1 piece)	NEW
Panel Cutout Adapter		CA4-ATM5-01	-	Panel cutout adapter for mounting ST-3300 series in cutout of GP-37W2B	-

2-5. Other Important Notes on Hardware

- About Serial Interface
 - The cable connection of ST-3301T/S/B can be generally used for ST-6300TA, but before ST-6300TA is connected, please check it with “[GP-Pro EX Device/PLC Connection Manual](#)”.
 - When replacing from ST-3302B (MPI type), please note that the Serial Interface specifications (such as pin assignment and the shape of plug/socket) of ST-6300A are different from ST-3302B. For the details, please refer to “[ST6000 Series Hardware Manual](#)”.
 - By using “USB/RS-422/485 Conversion Adapter”, you can use the USB interface of ST-6300TA as RS-422/485 Serial Interface. For the details, refer to “[USB/RS-422/485 Conversion Adapter Installation Guide](#)”. As the connectable devices with USB/RS-422/485 Adapter are limited, please also refer to “[USB/RS-422/485 Conversion Adapter Connection Guide](#)” to see the list of supported drivers.

2-5. Other Important Notes on Hardware

- Do not expose the hardware to direct sunlight. Recommend to use the option item “UV Protection Sheet” to protect the display from ultraviolet light.
- This product is not designed for outdoor use. UL certification obtained is for indoor use only.
- Do not turn on the hardware if condensation has occurred inside the device.
- The panel brightness may decrease when used for a long time in an environment continuously filled with inert gas. Please ventilate the control panel periodically.

3. Software Section

3-1. Replacement Procedure – Workflow

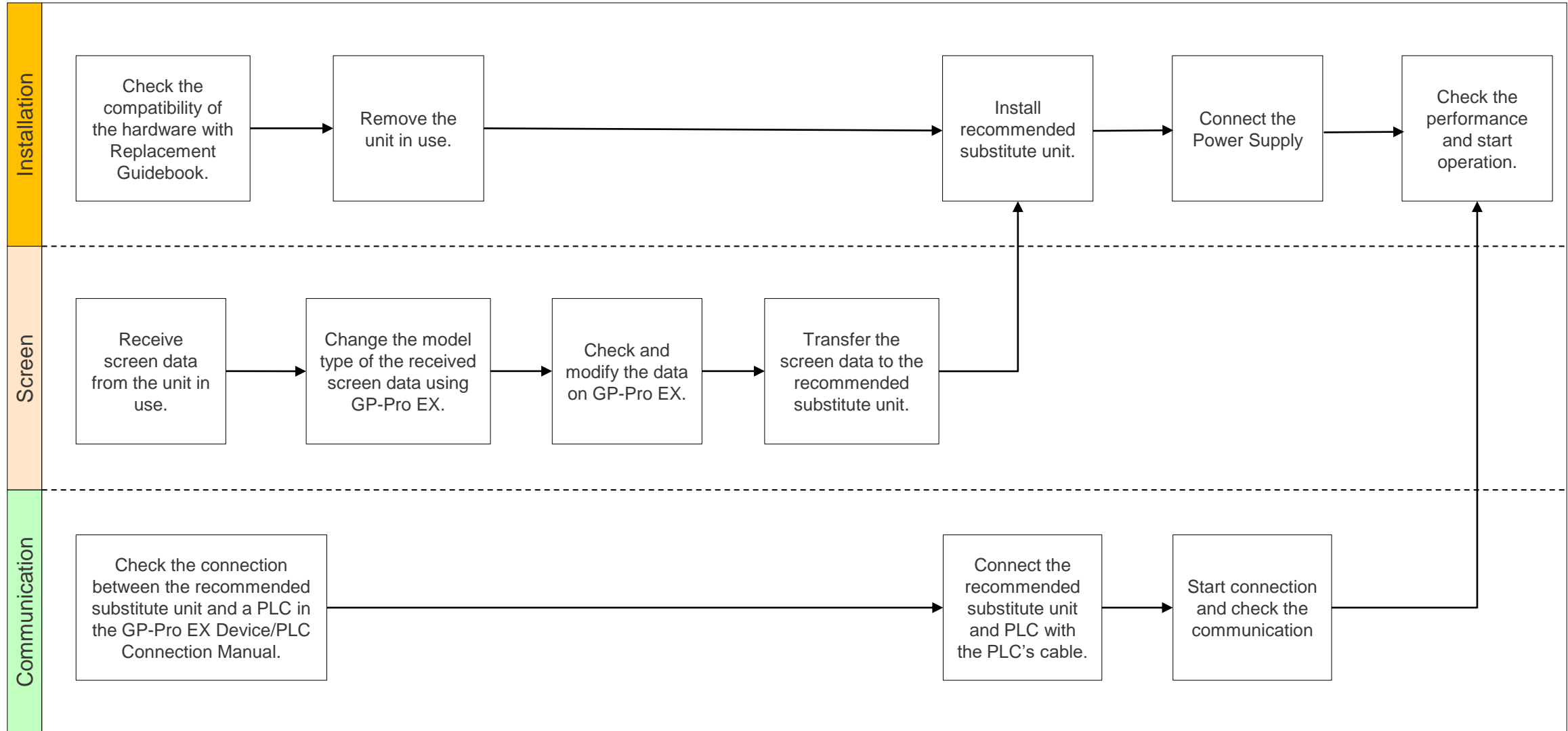

3-1. Replacement Procedure – Preparation

Requirements for receiving screen data from the unit in use *1	PC in which GP-Pro EX Transfer Tool is installed. *2
	Transfer Cable (the followings can be used) USB transfer cable: CA3-USBCB-01 (Type A - Type A) *It's also possible to send/receive a screen via USB storage device.
Requirements for converting screen data of the unit in use and transferring the converted data to Recommended substitute unit	PC with GP-Pro EX installed ST-6300TA supported version: Ver. 4.09.400 or later
	Transfer Cable (the followings can be used) USB transfer cable: PFXZUSCBMB2 (Type A – Type micro-B) or commercially available USB micro-B transfer cable *It's also possible to send/receive a screen via USB storage device or Ethernet.



*1: This step is required if screen data is saved only in the HMI unit, not in any other device.
If you already have the screen data backup, please go to [“3-1. Replacement Procedure – Change model to recommended substitute unit \(GP-Pro EX\)”](#).

*2: Please use the same or later version of the software used when creating screens on the old model. If you don't know the software version, we recommend that you use the latest one. You can download the latest transfer tool from our website.

<https://www.pro-face.com/otasuke/>

3-1. Replacement Procedure – Receive Screen data from the model in use (GP-Pro EX)

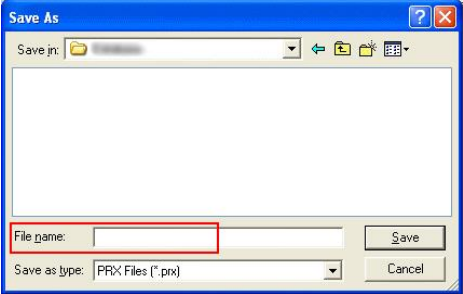
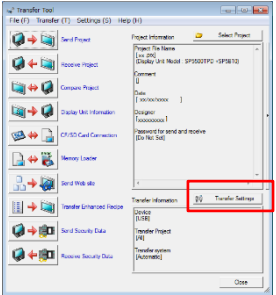
In this section, we will introduce how to receive screen data with a USB transfer cable as an example. If you have the backup of screen data, this step is not necessary. Please go to the next section.

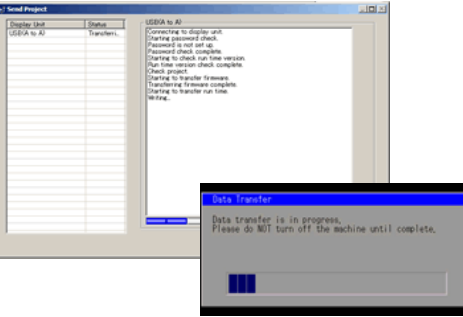
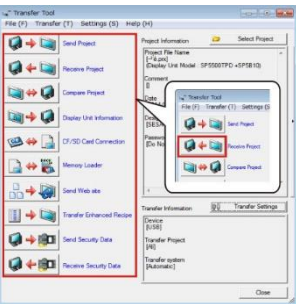
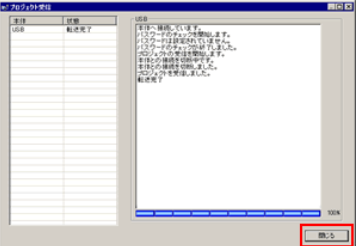
<p>1. Connect your PC and the model in use with a USB transfer cable. If the driver of the cable has not been installed on your PC yet, a dialog box will appear. Please follow the instructions.</p>		<p>5. Click [Receive Project], and the following dialog box will appear. Specify a place to save the received data in and a project file name, and then click [Save] to start transfer.</p>	
<p>2. Start the Transfer Tool of GP-Pro EX.</p>			
<p>3. Make sure that the [Device] in the “Transfer Settings Information” is set to [USB]. If not, click the [Transfer Setting] button to open the “Transfer Setting” dialog box. Select [USB] in the Communication Port Settings field and click [OK].</p>		<p>6. The following dialog box appears during transfer, and you can check the communication status. (The display unit enters the Transferring mode and communication with the device such as a PLC is terminated.)</p>	
<p>4. Start GP-Pro EX Transfer Tool and click the [Receive Project] button.</p>		<p>7. When transfer is completed, the status displayed in the dialog box will change from [Transferring] to [Complete Transfer]. Click [Close] to close the dialog box.</p>	
		<p>8. Close the Transfer Tool.</p>	

3-1. Replacement Procedure – Receive Screen data from the model in use (GP-Pro EX)

NOTES

1. The “Hardware Installation” dialog box as shown on the right may appear during installing the USB driver depending on the security level of Windows®. Click [Continue Anyway] to start installing the driver. When installation is completed, click [Finish].

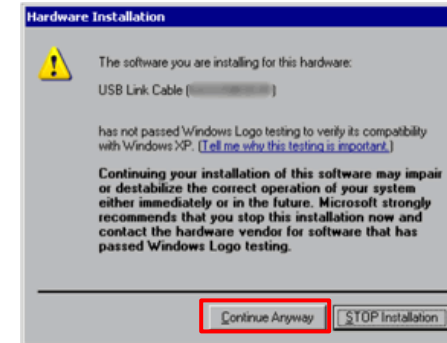

2. When the file already exists, a window will appear asking if you want to overwrite the file.

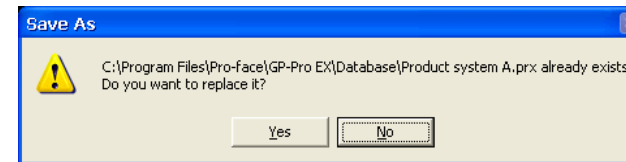

3. When receiving a project file that uses SD card/USB memory data such as Recipe Function (CSV data), the following dialog box will appear during the transfer. Please specify where to save the data. Click [OK] to return to the [Receive Project] dialog box and complete the transfer.



3-1. Replacement Procedure – Change model to recommended substitute unit (GP-Pro EX)

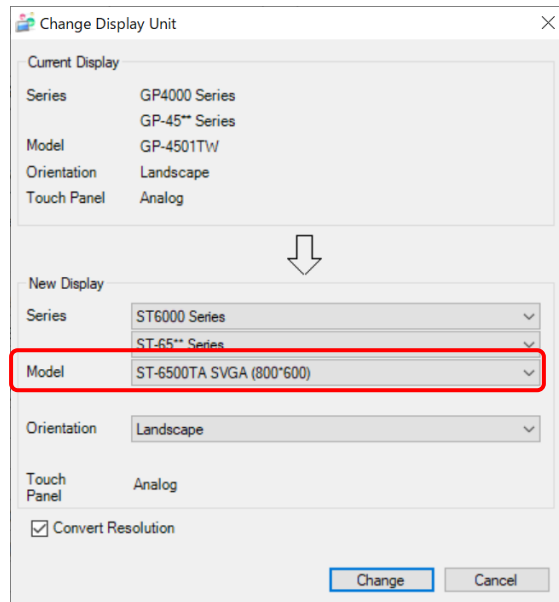

Change the Display unit from ST3000 Series to ST6000 Series.
The display can be changed from the menu bar “Project” → “System Settings” → “Display” → “Change Display” in GP-Pro EX.

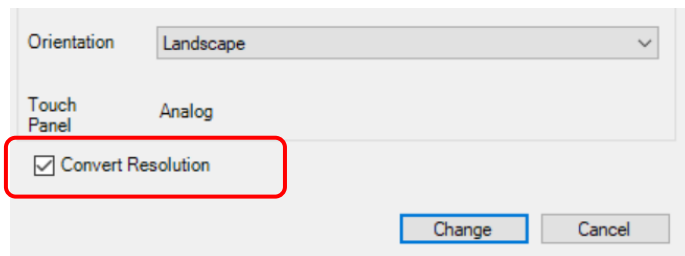

If you check on [Convert Resolution] when changing the Display Unit type (as shown below), you can adjust both size and location of the part and the text relative to the display resolution automatically. But still, you may need to adjust them manually. Please pay attention to the following points.



- A function that requires absolute coordinates. Please adjust the settings manually.
 - **Global window**
 - **Position Animation**
- Due to font size and resolution restrictions, manual changes may be required. Please resize them if needed
 - **Font:** In the case of using Standard font, the size will be smaller. You can improve by using Stroke font or Image font.
 - **Objects**
 - **Parts**
 - **Images**
 - **Alarm parts**
- Position may differ from the original project. Please check the coordinate of the window and adjust if needed.
 - **Window display**

3-1. Replacement Procedure – Transfer screen data to recommended substitute unit (GP-Pro EX)

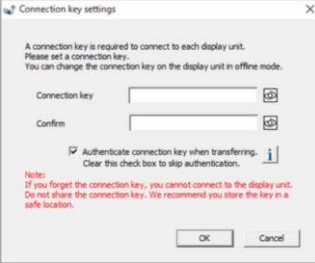
In this section, we will introduce how to transfer screen data with a USB transfer cable as an example.

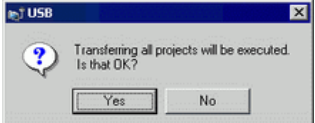
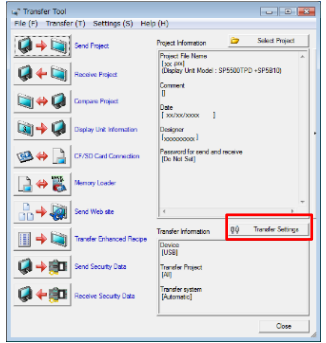
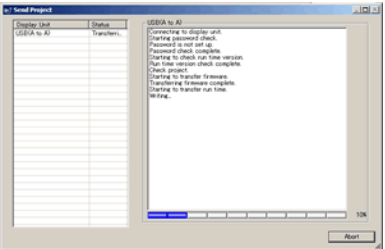
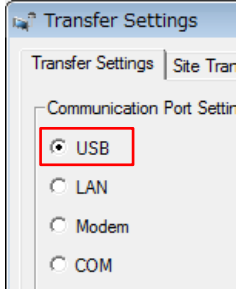
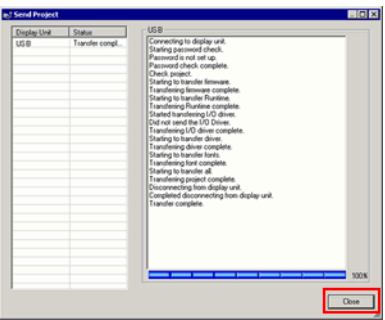
<p>1. Connect your PC and the recommended substitute unit with a USB transfer cable. If the driver of the cable has not been installed on you PC, a dialog box will appear. Please follow the instructions.</p>		<p>5. Click [Send Project]. In the dialog box that appears, set the connection key and click [OK].</p> <p>NOTE: If you forget the connection key, you will not be able to connect to the display unit. For more information about connection key, refer to GP-Pro EX reference manual (34.14.4 How the Connection Key Works).</p>	
<p>2. Turn on the power of Recommended substitute unit. The “Welcome” screen will appear on the display unit. After transferring a project file once, this screen will not appear again.</p>		<p>6. When this dialog box appears, click [Yes]. This dialog box is not displayed when the same project file is sent again.</p>	
<p>3. On the GP-Pro EX's State Toolbar, click the [Transfer Project] icon to open the Transfer Tool. To transfer a different project file, click the [Select Project] button and select a project file.</p>		<p>7. The transfer begins. The following dialog box appears during transfer, and you can check the communication status. (The display unit changes to Transferring mode and communication with the device/PLC is suspended.)</p>	
<p>4. Make sure that the [Device] in the “Transfer Settings Information” is set to [USB]. If not, click the [Transfer Setting] button to open the “Transfer Setting” dialog box. Select [USB] in the Communication Port Settings field and click [OK].</p>		<p>8. When transfer is completed, the state of the dialog box changes from [Transferring] to [Transfer Complete]. Click [Close] to close the dialog box.</p>	
		<p>9. Close the Transfer Tool</p> <p>10. Click the [X] mark on top right of the screen or [Project] → [Exit] to close GP-Pro EX.</p>	

3-2. Software Compatibility – GP-Pro EX Supported Feature Comparison

Specification UP in ST6000

NOT supported in ST6000

GP-Pro EX Feature		AST-3301T/S/B, AST-3302B	ST-6300TA
Display	Screen Area (Application memory, unit: byte)	6M	64M
	Portrait Installation	✓	✓
	Function Expansion Memory	-	-
	Installing the USB/RS-422/485 Conversion Adapters	-	✓
	MAC Address Display	-	✓
External Storage	CF Card	-	-
	SD Card	-	-
	CFast Card	-	-
	USB storage	✓	✓
	FTP server	-	✓
System Settings	Drawing in 256 colors	✓ (AST-3301T/S only)	✓
	Reverse Display	✓ (AST-3301B/3302B only)	-
	Faded Color Blink	✓ (AST-3301T/S only)	-
	Synchronize Text Display with Text Table	✓	✓
	Time Zone settings	-	-
	Detect Backlight Burnout	-	-
	Dimmer settings	-	✓
	2-point touch / Multitouch	-	-
Display the SD/USB Removal Icon	-	✓	

3-2. Software Compatibility – GP-Pro EX Supported Feature Comparison

Specification UP in ST6000

NOT supported in ST6000

GP-Pro EX Feature		AST-3301T/S/B, AST-3302B	ST-6300TA
System Settings	Screen Capture	-	✓
	SRAM Auto Backup	-	✓USB storage can be used for the models without SD/CF card slots. *supported by Ver.4.09.450 or later
	Image Font	✓	✓
	Bitmap Font	✓	✓
	Standard Font	✓	✓
	Port Control	-	✓
Device/PLC Communication *1	Number of Devices/PLCs that can communicate simultaneously	2	2
	Specify Indirect Device	✓*2	✓
	Import Device/PLC tags	-	✓
	Ethernet Multilink	-	✓
	Device Monitor	✓	✓
	Ladder Monitor	-	-
Transfer	Network Transfer	-	✓
	Modem Transfer	✓	-
	SIO Transfer (COM Connection)	✓	-
	Memory loader feature	✓	✓
	CF/SD Card Connection	-	-
	Connection Key	-	✓

*1 Depends on the type of connected PLC/Device.

*2 Indirect device occupies 1 MB of the Screen Area.

3-2. Software Compatibility – GP-Pro EX Supported Feature Comparison

Specification UP in ST6000

NOT supported in ST6000

GP-Pro EX Feature		AST-3301T/S/B, AST-3302B	ST-6300TA
Common Settings	Change Backlight Color	-	-
	Clock Update Settings	-	✓
	Start Screen Settings	-	✓
	Date format on CSV file output	✓	✓
	Divide destination folders by file numbers	✓	✓
	Increase Alarm Type [Extended] settings and Text Table index numbers	-	-
	Alarm Message Multiple Line Display	✓	✓
	Attach Data Value to Operation Log	✓	✓
	Changing passwords at run time (CSV file)	✓	✓
	Changing passwords at run time (password change screen)	-	✓
	Append Date/Time to CSV File Name	-	✓
	Transfer sampling CSV file to FTP	-	✓
	Transferring sampled data to the cloud	-	✓
	Indirectly specify Sampling Frequency and Alarm Settings	✓	✓
	Sampling data/Enhanced recipe data format co-exist	-	✓
	Create a recipe (CSV data) index file at runtime	-	✓
	Enhanced Recipes	-	✓
	Extended Script copy file function	-	✓
Global Trigger	-	✓	

3-2. Software Compatibility – GP-Pro EX Supported Feature Comparison

Specification UP in ST6000

NOT supported in ST6000

GP-Pro EX Feature		AST-3301T/S/B, AST-3302B	ST-6300TA
Common Settings	Movie record/play feature	-	-
	Use Image unit	-	-
	Sound Output Feature	-	-
	AUX	-	-
	Retentive Variables Function	-	✓
Parts	Selector List	✓	✓
	XY Graph (Historical Trend, Data Block Display Graph)	✓	-
	Picture Display [CF Image Display] / [SD Image Display] for showing JPEG files	-	✓USB storage can be used for the models without SD/CF card slots. *supported by Ver.4.09.450 or later
	Indirectly specify a block of Alarm parts	✓	✓
	Special Data Display [File Manager] sort function and default path	✓	✓
	Special Data Display [File Manager] copy file to FTP	-	✓
	Message Display's Bulletin Message	✓	✓
	Image Sensor Display	-	-
	Animation	✓	✓
	Alarm History Message Flow Display	-	✓
	Alarm History / Sampling Data / Enhanced Recipe Data Refine Search / Sort Function	-	-
	Alarm Analysis Function	-	-

3-2. Software Compatibility – GP-Pro EX Supported Feature Comparison

Specification UP in ST6000

NOT supported in ST6000

GP-Pro EX Feature		AST-3301T/S/B, AST-3302B	ST-6300TA
Logic	Logic Program Operation	-	✓
	I/O Driver	-	-
	Function Block	-	✓
Network	RPA Function (end of support from Ver.4.09.400)	-	-
	GP-Viewer EX	-	✓
	Web Server (end of support from Ver.4.09.450)	-	-
	Camera-Viewer EX	-	-
	Pro-face Remote HMI	-	✓
	E-mail	-	✓
	GP Remote Printer Server	-	✓
	Pro-face Connect (models you can register as SiteManager)	-	✓
	Pro-Server EX	-	✓
Input Equipment / Peripheral Equipment (USB Device)	USB Keyboard	✓	✓
	EZ Illuminated Switch	-	✓
	EZ Tower Light	-	✓
	EZ Numpad	-	✓
	EZ Fingerprint Recognition Unit	-	✓
	EZ LAN Adapter	-	✓

3-2. Software Compatibility – Supported Software Version

Specification UP in ST6000

NOT supported in ST6000

Supported Software	AST-3301T/S/B AST-3302B	ST-6300TA	Compatibility of Project Data
GP-Pro EX	✓	✓ Ver. 4.09.400 or later	✓
		https://www.pro-face.com/otasuke/files/manual/gpproex/new/refer/gpproex.htm	
Pro-Server EX	-	✓ Ver. 1.37.200 or later	NEW
		https://www.pro-face.com/otasuke/files/manual/soft/server_ex/v1_37/ref/SRPreface.htm	
Pro-face Remote HMI (iOS/Android)	-	✓ Ver. 1.60 or later	NEW
		https://www.pro-face.com/otasuke/qa/remotehmi/faq.html	
Pro-face Remote HMI Client for Win	-	✓ Ver. 1.42 or later	NEW
		https://www.proface.com/en/product/soft/remotehmi_client/download	
Pro-face Connect	-	✓ Ver. 9.6 or later	NEW
		https://www.proface.com/en/product/soft/proface_connect/download	

3-3. Other Important Notes on Software

- About Blink function
 - ST6000 Series do not support Blink function. Therefore, if you use the blink settings in ST3000 Series, the settings will be cancelled after changing the display to ST6000 Series in GP-Pro EX.

ST3000 Series

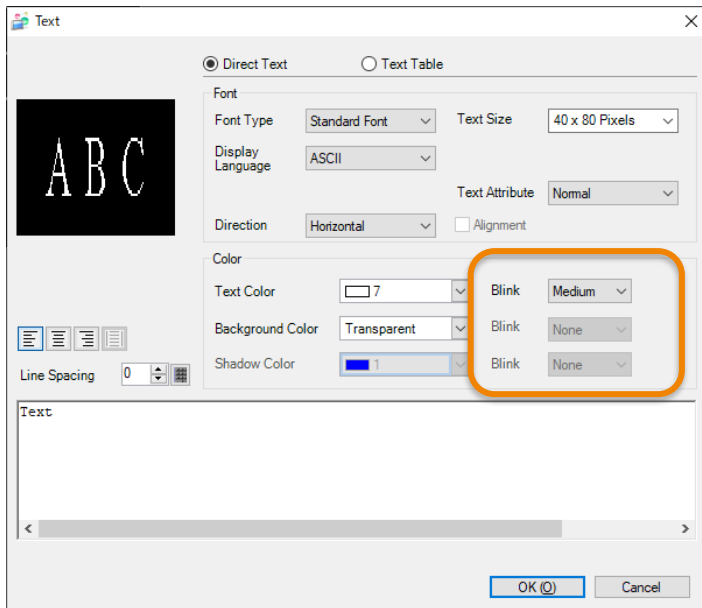

After converting the project to ST6000 Series

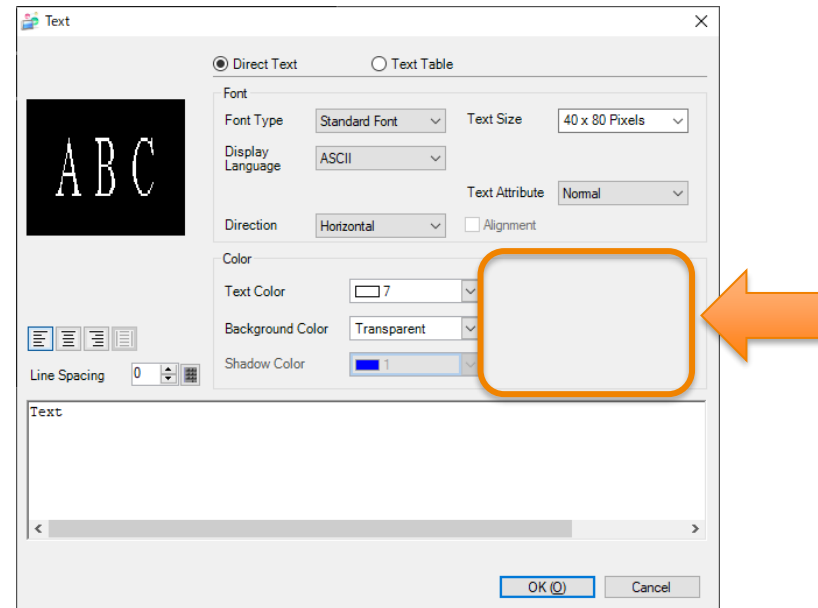

NOTE: We have a workaround to add blink functions to some of the parts/texts on ST6000 display by using the functions of the configuration software, GP-Pro EX. Refer to the following FAQ for the setting procedures.

<https://www.proface.com/en/support/faq/FAQ000268649>

3-3. Other Important Notes on Software

- About Display colors (ST-3301B, ST-3302B only)
 - The display color of ST-3301B and ST-3302B is monochrome. As ST6000 Series do not support monochrome display, if you change the model to ST6000 Series, the display color will be changed to Color display. Therefore, after changing the model, be sure to check the color of the screen data with GP-Pro EX.

