

Pro-face®

Hybrid Terminal Block Hardware Manual

Preface

Thank you for purchasing Pro-face's the Hybrid Terminal Block.

The Hybrid Terminal Block (Hereafter referred to as the "HTB") network interface module with built-in Inputs/Outputs is small in size. Its modularity, by adding I/O expansions, can be used to optimize an application by providing the necessary number of I/Os.

The HTB connects directly to a CANopen field bus.

The HTB accepts up to 7 EX modules.

Before operating your HTB, be sure to read this manual to familiarize yourself with the HTB's operation procedures and features.

NOTICE

1. Copying this manual's contents, either in whole or in part, is prohibited without the express permission of Digital Electronics Corporation, Japan.
2. The information contained in this manual is subject to change without notice.
3. If you should find any errors or omissions in this document, please contact Digital Electronics Corporation to report your findings.
4. Regardless of Clause 3 above, Digital Electronics Corporation shall not be held responsible for any damages, losses or third-party damages resulting from the use of this product.

© 2008 Copyright Digital Electronics Corporation. All rights reserved.





Product names used in this manual are the trademarks / registered trademarks of their respective owners.

Essential Safety Precautions

All safety-related procedures stated in this document must be followed to operate the HTB correctly and safely. Be sure to read this and any related documents thoroughly to understand the correct operation and functions of the HTB.

Safety Icons

Throughout this manual, these icons provide essential safety information for HTB operation procedures requiring special attention. These icons indicate the following levels of danger:

 WARNING	Indicates situations where severe bodily injury, death or major equipment damage can occur.
 CAUTION	Indicates situations where slight bodily injury or minor equipment damage can occur.
	Indicates actions or procedures that should NOT be performed.
	Indicates actions or procedures that MUST be performed to ensure correct unit operation.

WARNING

DANGER OF ELECTRIC SHOCK AND FIRE

 A significant amount of current may be present on each relay output (up to 2A).

There is a risk of current overload resulting in possible shock and/or fire.

- Use appropriately sized cables for the load potential.
- Protect each output with an appropriately sized fuse.

RISK OF UNINTENDED EQUIPMENT OPERATION

Failure to follow this precaution can result in death, serious injury, or equipment damage.

 Do not add or remove an expansion module to or from the system before first removing all power. Adding or removing an expansion module while under power can cause damage to the module and the system resulting in unexpected operation of inputs and outputs. Depending on the I/O configuration, unintended equipment operation can occur.

 Keep adequate spacing around the island for proper ventilation and to maintain an ambient temperature between 0°C (32°F) and 55°C (131°F).

Overheating of HTB and/or the I/O expansion modules can result in unexpected operation of inputs and outputs. Depending on the I/O configuration, unintended equipment operation can occur.

- ⊘ Do not place heat generating devices such as transformers and supply blocks under the island.
Heat generating devices in proximity of HTB and I/O expansion modules could result in elevated temperatures and overheating, and can result in unexpected operation of inputs and outputs. Depending on the I/O configuration, unintended equipment operation can occur.
- ⊘ Do not exceed the 450mA current limit for HTB and its expansion modules. Exceeding these limits can result in interruption of power to the I/O. Depending on I/O configuration, unintended equipment operation may result.
- ⚠ If outputs should fail, outputs may remain on or off. Where personnel and or equipment hazards exist, use an appropriate hard-wired safety system.
- ⚠ When the power supply voltage is outside of the specified voltage range, one or more outputs may not operate as expected. Use an appropriate externally-wired safety system to control and monitor the system voltage and ensure the specified voltage range is maintained.
- ⊘ Turn power off before installing, removing, wiring, or maintaining.
- ⊘ This product is not intended for use in safety critical machine functions. Where personnel and or equipment hazards exist, use appropriate hard-wired safety interlocks.
- ⚠ Do not disassemble, repair, or modify the modules.
- ⊘ This controller is designed for use with in an enclosure.
- ⊘ Install the modules according to the installation instructions on page 3-2.
- ⊘ Use the sensor power supply only for supplying power to sensors connected to the module.
- ⊘ Use an IEC60127-approved fuse on the power line and output circuit to meet voltage and current requirements.



Recommended fuse: Littlefuse® 5x20 mm Slo-Blo® 218 Series.

Unit Disposal

- ⚠ When the product is disposed of, it should be done so according to your country's regulations for similar types of industrial waste.

Information Symbols

This manual uses the following icons:

	Indicates a warning or a product limitation. Be sure to follow the instructions given with this icon to ensure the safe operation of the HTB.
Screen Editor	Indicates the GP-Pro EX software.
PLC	Abbreviation for Programmable Logic Controller.
*	Indicates useful or important supplemental information.
	Contains additional or useful information.
	Indicates pages containing related information.

About the Manuals

For the detailed information on HTB, refer to the following manuals.

- Hybrid Terminal Block Hardware Manual (this manual)
- GP-Pro EX Reference Manual "Controlling External I/O by Using HTB"
- Maintenance/Troubleshooting
- GP3000 Series Hardware Manual
- CANopen Master Unit Hardware Manual
- EX Module Hardware Manual

The manuals can be downloaded from Pro-face Home Page.

URL

<http://www.pro-face.com/otasuke/>

Package Contents

The following items are included in the HTB's package. Before using the HTB, please check that all items listed here are present.

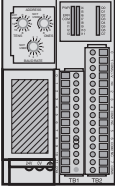
<p>HTB: 1</p> 	<ul style="list-style-type: none">• English and Japanese Installation Guide	<ul style="list-style-type: none">• Connector for Input (1, attached to HTB)• Connector for Output (1, attached to HTB)
---	---	--

This unit has been carefully packed, with special attention to quality. However, should you find anything damaged or missing, please contact your local HTB distributor immediately.

UL/c-UL/CSA Approval

This unit is UL/c-UL/CSA listed product: (UL File No. E210412, CSA File No. 240854)

This product conforms to the following standards:

- UL508

Industrial Control Equipment

- UL1604

Electrical Equipment for Use in Class I and II, Division 2, and Class III Hazardous (classified) Locations

- CSA-C22.2 No.142-M1987

Standard for Process Control Equipment

- CSA-C22.2 No.213-M1987

Non-Incendive Electrical Equipment for Use in Class I, Division 2 Hazardous Locations

Warning - Explosion Hazard - This equipment is suitable for use in Class I, Division 2, Groups A, B, C, D or nonhazardous locations only.

Warning - Explosion Hazard - Substitution of components may impair suitability for Class I, Division 2 compliance.

Warning - Explosion Hazard - Do not disconnect equipment unless power has been switched off or the area is known to be nonhazardous.

CE Marking

This unit is CE marked product that conforms to EMC directives, EN55011 Class A and EN61131-2.

Contents

Preface	1
Essential Safety Precautions.....	2
Information Symbols.....	4
About the Manuals	4
Package Contents	5
UL/c-UL/CSA Approval.....	6
CE Marking.....	6

Chapter 1 Introduction

1.1 About CANopen.....	1-2
1.1.1 Introduction.....	1-2
1.1.2 The CANopen Protocol.....	1-2
1.1.3 CANopen Profiles	1-2
1.1.4 CANopen Features.....	1-3
1.1.5 CANopen Standards.....	1-3
1.2 System Design.....	1-4
1.3 Accessories	1-5
1.3.1 Maintenance Item	1-5
1.4 Part Names and Functions	1-6
1.4.1 Indicator LEDs Details	1-8

Chapter 2 Specifications

2.1 General Specifications	2-2
2.1.1 Electrical Specifications.....	2-2
2.1.2 Environmental Specifications.....	2-2
2.1.3 Structural Specifications	2-2
2.2 Performance Specifications	2-3
2.2.1 Input Specifications	2-3
2.2.2 Output Specifications.....	2-5
2.3 External Dimensions.....	2-7

Chapter 3 Installation and Wiring

3.1 Installation.....	3-2
3.1.1 Installation Requirements	3-3
3.1.2 35 mm [1.38 in.] DIN rail mounting	3-3

- 3.2 Wiring..... 3-5
 - 3.2.1 Wiring Requirements3-6
 - 3.2.2 CANopen wiring.....3-7
 - 3.2.3 Connecting the Power Cord and Input/Output cables3-8
 - 3.2.4 Wiring Precautions.....3-9
 - 3.2.5 Contact Protection Circuit for Relay and Transistor Outputs3-10

1



Introduction

1. About CANopen
2. Introduction
3. Accessories
4. Part Names and Functions

1.1 About CANopen

1.1.1 Introduction

CANopen is an open fieldbus protocol for industrial control systems. It is particularly well suited to real-time control, as it provides an effective, low-cost solution for integrated industrial applications.

1.1.2 The CANopen Protocol

The CANopen protocol was created as a subset of CAL (CAN Application Layer). It is widely utilized to connect industrial components.

The CANopen standards are managed by CiA (CAN in Automation), promoting the adoption of various applications. In Europe, CANopen is now the recognized standard for embedded systems in networks.

1.1.3 CANopen Profiles

■ The communication profile

The CANopen communication profile is specified into four message types by the CiA DS-301.

- Real-time Data (PDO: Process Data Objects)
- Configuration Data (SDO: Service Data Objects)
- Special Function (Time Stamp, Sync Message, Emergency Message)
- Network Administration Messages (Boot-up Message, NMT Message, Error Control)

For the details, please see the GP- Pro EX Reference Manual “Controlling External I/O”

■ The device profile

The most important types of devices used in factory automation are described in the “Device profiles”. They also define device functionalities.

Examples of the standard devices described are:

- digital and analog input/output modules (DSP-401),
- motors (DSP-402),
- measurement device (DSP-404),
- other devices (DSP-4xx).

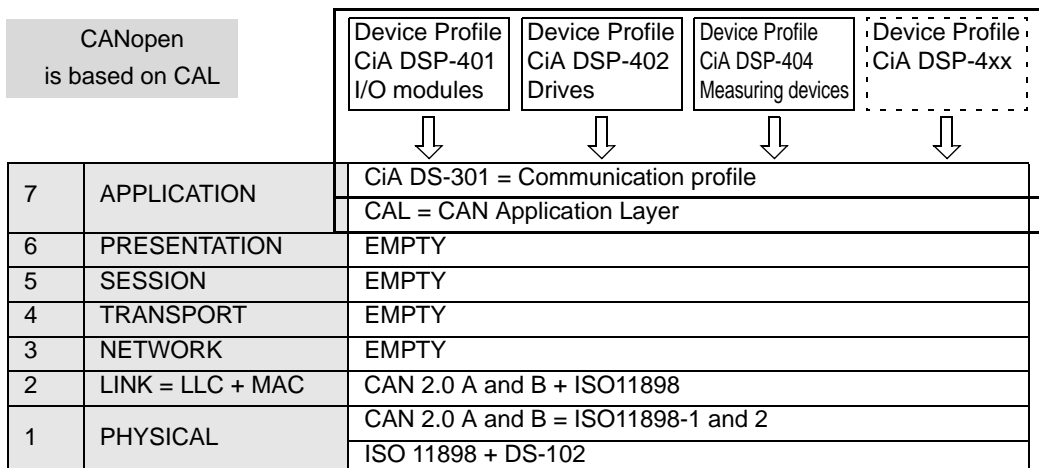

1.1.4 CANopen Features

- open fieldbus (specifications have been released),
- maximum communication speed of 1Mbits/s,
- noise resistance improved by the resend process of the hardware,
- interoperability and interchangeability of devices,
- supported by a large number of international manufacturers (approximately 500 member companies),
- access to all device parameters,
- supports cyclic communication and acyclic communication (event-driven), thereby reducing bus data volume and increasing response speed.

1.1.5 CANopen Standards

CANopen specifications are defined by the CiA group and can be accessed on the group site at <http://www.can-cia.org/>. The sourcecodes for master and slave devices are available from the various suppliers.

1.2 System Design

CANopen master,
GP unit etc.

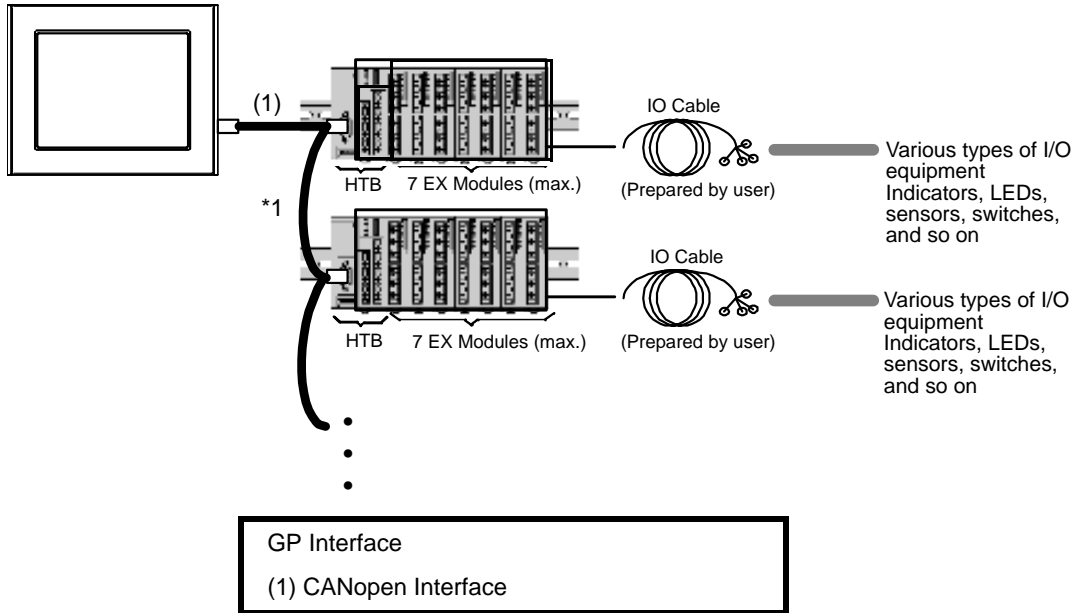

*1 Up to 63 CANopen slaves, Hybrid Terminal Block, can be connected to the CANopen Master, (GP3000 Series CANopen board type or LT3000 Series using CANopen Master Unit) with CANopen transfer cables and connectors shown as follows;

Recommended Cable Connector:

CiA-recommended CANopen (CiA DR-303-1) - compatible DSUB 9-pin connector (DIN41652).

CANopen Recommended Transfer Cable:

CiA-recommended CANopen (CiA DR-303-1) - compatible twisted pair cables with shield.

NOTE

- Please use your own cables or cable connectors with your guarantee.

	Model No.	Manufacturer	Description
Recommended Cable Connector	TSXCANKCDF180T	<Schneider Electric>	Straight connector with terminal selector switch attached.
	TSXCANKCDF90T TSXCANKCDF90TP	<Schneider Electric>	Right-angled connector with terminal selector switch attached. Only for use for GP-3300 Series CANopen board type and LT3000 Series using CANopen Master Unit.
	VS-09-BU-DSUB/CAN	<PHOENIX CONTACT>	Connector with terminal block attached with terminal selector switch attached.
	SUBCON-PLUS-CAN/AX	<PHOENIX CONTACT>	Straight connector with terminal selector switch attached.
	SUBCON-PLUS-CAN/PG SUBCON-PLUS-CAN	<PHOENIX CONTACT>	Right-angled connector with terminal selector switch attached.
CANopen Recommended Transfer Cable	TSX CAN CA50/ TSX CAN CA100	<Schneider Electric>	Cable for CANopen (IEC60332-1) 50 m/100 m
	TSX CAN CB50/ TSX CAN CB100	<Schneider Electric>	UL-authenticated cable for CANopen (IEC60332-2) 50 m/100 m

NOTE

- CANopen communication cables and cable connectors are not supplied with the CANopen Master Unit. Users must prepare cables.

1.3 Accessories

All accessories listed here are produced by Pro-face.

1.3.1 Maintenance Item

Product Name	Model No.	Description
Input/Output Connector	CA7-HTBCNSET-01	Connector attached to the Input/Output terminals. 13-pin connector for input and 16-pin connector for output, both connectors are packed.

1.4 Part Names and Functions

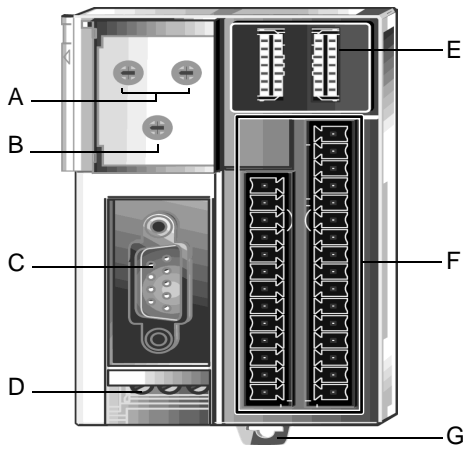

Front

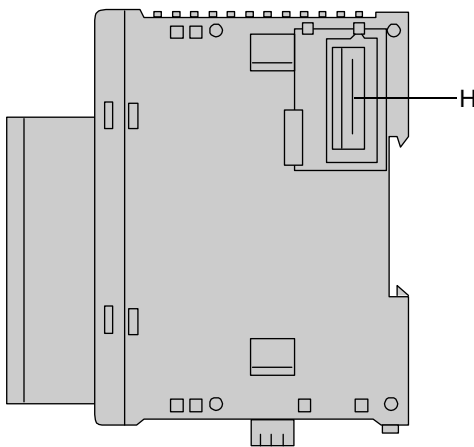

Right side

* The Interface (1) on the Left side of HTB is unable to use.

A: Upper Rotary DIP switch

Define the CANopen node ID (1 to 127). When using GP3000 Series CANopen board type or LT3000 Series using CANopen Master Unit as a master, available range of node ID is 1 to 63. Do not use the same node ID twice in the network.

- Left Rotary DIP switch : Sets tens place with 0 to 12 (decimal number)
- Right Rotary DIP switch : Sets ones place with 0 to 9 (decimal number)

B: Lower Rotary DIP switch

Define the baud rate. Set the baud rate with 0 to 9 (decimal number). Set the baud rates identical to those on the master unit (such as GP3000 Series CANopen board type or LT3000 Series using CANopen Master Unit)

Position (lower encoder rate)	Baud Rate
0	10 kbits/s
1	20 kbits/s
2	50 kbits/s
3	125 kbits/s
4	250 kbits/s
5	500 kbits/s
6	800 kbits/s
7	1 Mbits/s
8	Automatic
9	Default rate (250 kbits/s)

NOTE

- GP3000 Series CANopen board type or LT3000 Series using CANopen Master Unit is corresponding to the baud rate between 50 kbits/s and 1 Mbits/s.
- The value 8 is used to search automatically for the bus transmission speed. The search starts at a value of 1 Mbits/s then progressively lowers over successive searches until communication is established on the bus.
The automatic search only works on an operational CANopen network.

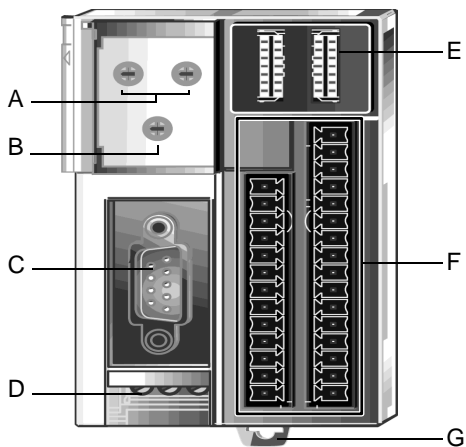

Front

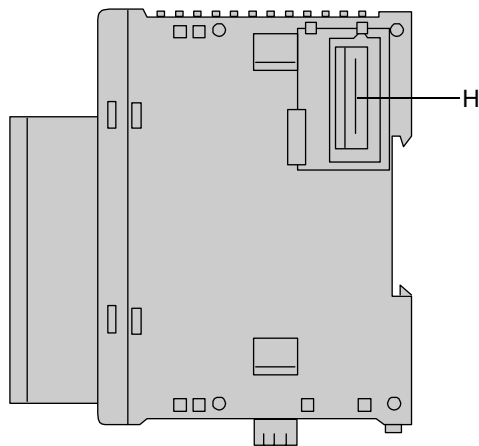

Right side

* The Interface (1) on the Left side of HTB is unable to use.

C: Field bus interface

A 9-pin plug DSUB connector is used to connect the interface module to a CANopen field bus. This bus is not insulated internally.

	Contacts	Signal	Description
	1	–	–
	2	CAN_L	CAN-L bus line
	3	CAN_GND	CAN Ground
	4	–	–
	5	–	–
	6	GND	Ground (Common with CAN_GND)
	7	CAN_H	CAN-H bus line
	8	–	–
	9	–	–
	Shell	FG	Frame Ground

Recommended cable connector:

CiA-recommended CANopen (CiA DR-303-1) - compatible DSUB 9-pin connector (DIN41652).

Recommended network cable:

CiA-recommended CANopen (CiA DR-303-1) - compatible twisted pair cables with shield.

NOTE • Please use your own cables or cable connectors with your guarantee.

D: Electrical supply Interface

Terminal for an external 24 VDC supply of the HTB.

E: Indicator LED

LED	Status
PWR	Indicates the presence of a 24 VDC power supply to HTB.
RUN ERR	2 (RUN) and 3 (ERR) show the data exchange status between the communication units that can transmit data.
I0 - I11 Q0 - Q7	Reflect the I/O status of HTB's integrated I/O.

SEE → 1.4.1 Indicator LEDs Details (p.1-8)

F: In/Output Terminals

Input/Output terminals.

G: Hook

A hook to fix HTB on the DIN rail.

H: Extension Connector

Connects only EX module, up to 7.

1.4.1 Indicator LEDs Details

■ CANopen Communication LEDs

Standard DRP303-3 defines the RUN and ERR LEDs and their different statuses.

LED	Type of flashing	Description
ERR (red)	off	No error.
	random flashing	Automatic search for the bus communication speed.
	flashing: 1 flash	Warning limit reached. An internal error counter in the CAN controller has reached or exceeded the error frame limit threshold number (error frame).
	flashing: 2 flashes	Error control event. Detection of a guard event (NMT-Slave or NMT-master) or a heartbeat event (Heartbeat consumer)
	flashing: 3 flashes	Synchronization error: message not received within the defined period.
	on	Bus OFF. Status of the HTB: Bus OFF.
RUN (green)	random flashing	Automatic search for the bus communication speed.
	continuous flashing	Module status: Pre-operational.
	flashing: 1 flash	Module status: Stopped.
	on	Module status: Operational.

■ I/O status LEDs

Name	LED color	Status	Function
PWR (power)	green	on	Presence of 24 VDC for the HTB
I0 to I11	green	on	Input set to 1
		off	Input set to 0
Q0 to Q7	green	on	Active output
		off	Inactive output

2



Specifications

1. General Specifications
2. Performance Specifications
3. External Dimensions

This chapter describes the general, functional and interface specifications of the HTB as well as its dimensions.

2.1 General Specifications

2.1.1 Electrical Specifications

Power Supply	Input Voltage	DC24V
	Rated Voltage	DC20.4 to 26.4V (including ripple)
	Allowable Voltage Drop	10ms (max.) (DC24V)
	Power Consumption	19W (DC26.4V) (Communication module with (max.) 7 EX modules.)
	In-Rush Current	50A (max.) (DC24V)
Voltage Endurance		AC500V, 1 minute (between power and ground terminals) AC500V, 1 minute (between I/O and ground terminals)
Insulation Resistance		10 MΩ (min.) (DC500V) (between power and ground terminals) 10 MΩ (min.) (DC500V) (between I/O and ground terminals)
Noise resistance IEC 1131-2		DC power terminals: 1kV, 50 ns to 1μs I/O terminals (coupling clamp): 1.5 kV, 50 ns to 1 μs

2.1.2 Environmental Specifications

Physical	Surrounding Air Temperature	0 to 55°C
	Storage Temperature	-25 to +70°C
	Ambient Humidity	30 to 95% RH (Not condensing)
	Storage Humidity	30 to 95% RH (Not condensing)
	Pollution Degree	For use in Pollution Degree 2 environment
	Atmosphere	Free of corrosive gases
	Air Pressure Vibration Resistance (availment altitude)	Operation: from 0 to 2000 m Transport: from 0 to 3000 m
Mechanical	Vibration Resistance	from 10 to 57 Hz amplitude 0.075 mm [0.003 in.], from 57 to 150 Hz acceleration 9.8 m/s ² , 2 hours per axis on each of three mutually perpendicular axes.
	Concussion Resistance	147 m/s ² , 11 ms duration, 3 shocks per axis, on three mutually perpendicular axes (IEC 61131).

2.1.3 Structural Specifications

Installation	Installation Configuration	Attachment via 35mm DIN rail
	Protective structure	IP20
	Cooling Method	Natural air circulation
	Weight Approx.	185g [0.4lb] max. (unit only)

2.2 Performance Specifications

2.2.1 Input Specifications

Input points	12 inputs with common line (source/sink input signal)
Rated input voltage	DC24V
Input voltage range	from DC20.4 to 26.4V
Rated input current	I0, I1, I6, I7: 5mA/input (DC24V) I2 to I5, I8 to I11: 7mA/input (DC24V)
Input impedance	I0, I1, I6, I7: 5.0 k Ω I2 to I5, I8 to I11: 3.4 k Ω
Switching time at high status (ON Time)	I0, I1, I6, I7: 35 μ s + filter value I2 to I5, I8 to I11: 40 μ s + filter value
Switching time at low status (OFF Time)	I0, I1, I6, I7: 45 μ s + filter value I2 to I5, I8 to I11: 150 μ s + filter value
Isolation	Between input terminals: not isolated Internal circuit: photocoupler isolated (isolation protection put to AC500V rms)
Filtering: 3 possibilities • none • 3 ms • 12 ms	I0 to I11
Input type	Type 1 (IEC 61131)
External load for I/O interconnection	Not needed
Signal determination method	Static
Input cable length	3 m [118.11 in.] for compliance with electromagnetic immunity
Connector insertion/removal durability	100 times (min.)

■ Input Operating Range

The input operating range of the Type 1 (IEC 61131-2) input module is shown below.

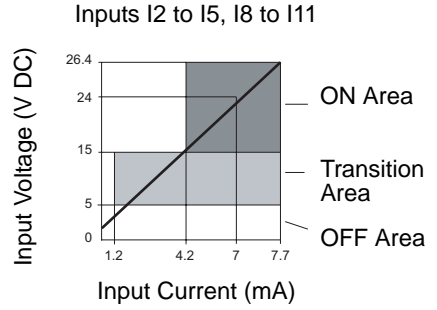
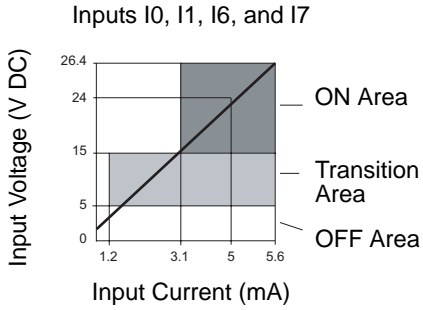

■ Input Internal Circuit

The internal input circuit is described below.

Sink Or Source Input (high speed)

Inputs I0, I1, I6, and I7

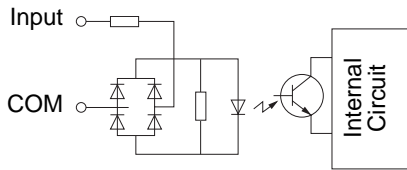

Sink Or Source Input (standard)

Inputs I2 to I5, I8 to I11

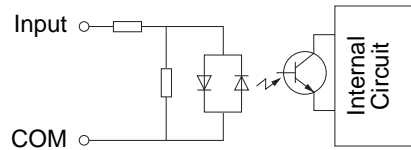

2.2.2 Output Specifications

 **WARNING**

RISK OF UNINTENDED EQUIPMENT OPERATION

-  Do not exceed the recommended temperature / simultaneous I/O usage guidelines. Exceeding the temperature and / or simultaneous I/O in the “on” state can cause overheating of HTB and / or the I/O expansion modules, resulting in unexpected operation of the inputs and outputs. Depending on the I/O configuration, unintended equipment operation can occur.

Failure to follow this instruction can result in death, serious injury or equipment damage.

■ Source Transistor Output Characteristics Q0,Q1

Output type	Source output
Output points per common Line	2
Rated load voltage	DC24 V
Maximum load current	1 A per common line
Operating load voltage range	from DC20.4 to 28.8 V
Voltage drop (on voltage)	DC1 V (max.) (voltage between COM and output terminals when output is on)
Rated load current	0.3 A per output
Inrush current	1 A (max.)
Leakage current	0.1 mA (max.)
Clamping voltage	DC39 V \pm 1 V
Maximum lamp load	8 W
Inductive load	L/R = 10 ms (DC28.8 V, 1 Hz)
External current draw	100 mA (max.), DC24 V (power voltage at the -V terminal)
Isolation	Between output terminal and internal circuit: photocoupler isolated (isolation protection up to AC500 V rms) Between output terminals: not isolated
Average number of connector insertions/removals	100 times (min.)
Output delay - turn on time	5 μ s (max.)
Output delay - turn off time	5 μ s (max.)

Relay Output Specifications Q2 to Q7

Number of outputs	6 relay outputs
Output points per common line - COM1	3 NO contacts
Output points per common line - COM2	2 NO contacts
Output points per common line - COM3	1 NO contact
Maximum load current	2 A per output 8 A per common line
Minimum switching load	0.1 mA/DC0.1 V (reference value)
Initial contact resistance	50 mΩ (max.)
Mechanical life	20,000,000 operations (min.) (rated load 18,000 operations/h)
Dielectric strength	Between output to internal circuit: AC1500 V rms, 1 min Between output to terminals (COMs): AC750 V rms, 1 min
Connector insertion/removal durability	100 times (min.)
Output delay - turn on time	10 ms (max.) (Bounce time not included)
Output delay - turn off time	5 ms (max.) (Bounce time not included)

Output delay and contact

Relay Output Delay

The output delay is illustrated below.

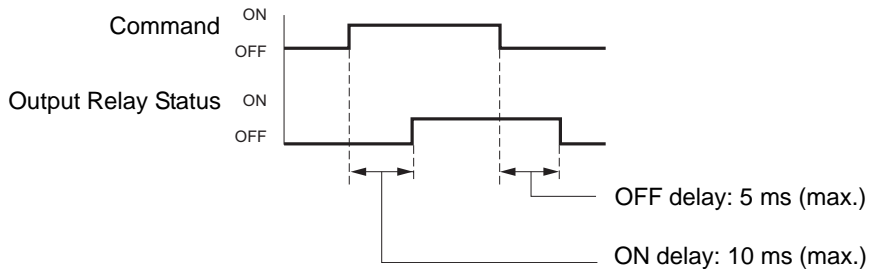

Relay Output Contact

The relay output contact is shown below.

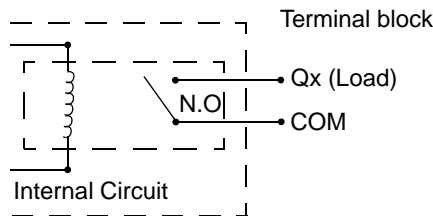

Transistor Source Output Contact

The transistor source output contact is shown below.

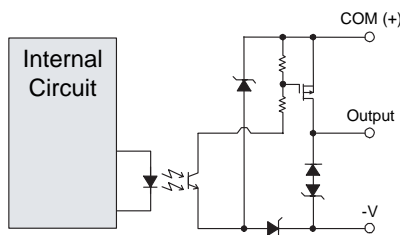

2.3 External Dimensions

Unit: mm[in.]

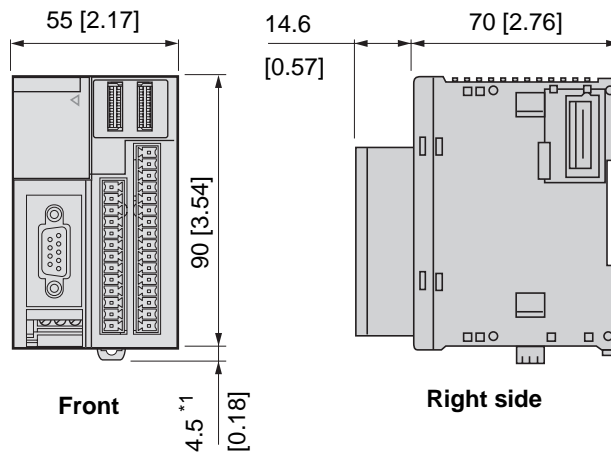

*1 8.5 mm [0.33 in] when the clamp is pulled out.

3



Installation and Wiring

1. Installation
2. Wiring

3.1 Installation

 **WARNING**

RISK OF UNINTENDED EQUIPMENT OPERATION

-  Do not add or remove an expansion module to or from the system before first removing all power. Adding or removing an expansion module while under power can cause damage to the module and the system resulting in unexpected operation of inputs and outputs. Depending on the I/O configuration, unintended equipment operation can occur.

Failure to follow this instruction can result in death, serious injury or equipment damage.

NOTE

- All expansion modules such as EX modules should be installed in the HTB before installing an island on a DIN rail. The island should be removed from a DIN rail before disassembling the different modules.

 **WARNING**

RISK OF UNINTENDED EQUIPMENT OPERATION

-  Keep adequate spacing around the island for proper ventilation and to maintain an ambient temperature between 0°C and 55°C. Overheating of the HTB and/or the I/O expansion modules can result in unexpected operation of inputs and outputs. Depending on the I/O configuration, unintended equipment operation can occur.

Failure to follow this instruction can result in death, serious injury or equipment damage.

 **WARNING**

RISK OF UNINTENDED EQUIPMENT OPERATION

-  Do not place heat generating devices such as transformers and supply blocks under the island.

Heat generating devices in proximity of the HTB and I/O expansion modules could result in elevated temperatures and overheating, and can result in unexpected operation of inputs and outputs. Depending on the I/O configuration, unintended equipment operation can occur.

Failure to follow this instruction can result in death, serious injury or equipment damage.

3.1.1 Installation Requirements

- In order to ensure proper serviceability, operability and airflow, provide space between the HTB and structural objects or other parts as the figure shows.

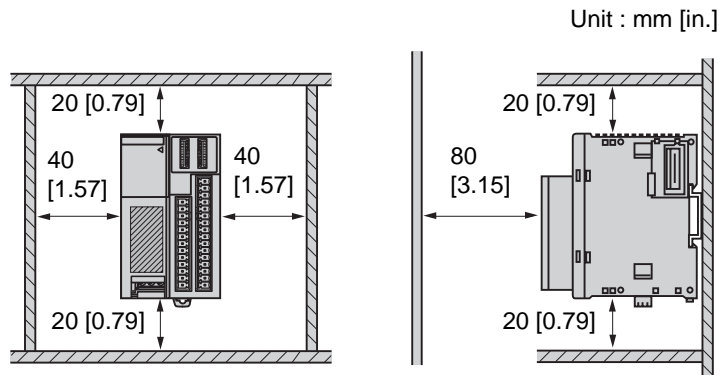

3.1.2 35 mm [1.38 in.] DIN rail mounting

- (1) Put the upper groove of the unit on the upper edge of the DIN rail. Push the lower side of the unit to the lower edge of the DIN rail until it clicks.

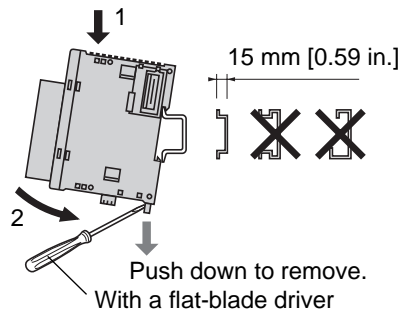

- (2) While pushing down the hook in the direction of the arrow with a flat-blade driver, pull the lower side of the unit and remove the unit from the DIN rail.

IMPORTANT

- Check the vertical direction of the unit. Attach the unit on to the vertical plane properly. Improper mounting of the unit may prevent heat release and proper operation of the unit.
- The unit release hooks are kept open when not used. Make sure that the unit release hooks close properly and the unit is firmly fixed on the DIN rail.

■ Correct Mounting Position

HTB and expansion I/O modules must be mounted horizontally on a vertical plane as shown in the figures below.

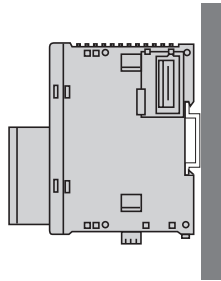

■ Incorrect Mounting Position

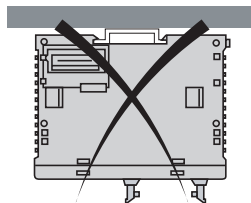
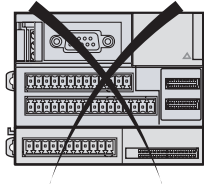
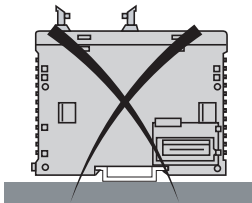

The following diagrams show the incorrect mounting positions for the HTB and expansion modules.



3.2 Wiring

WARNING

DANGER OF ELECTRIC SHOCK

-  Be sure to remove ALL power from ALL devices before connecting or disconnecting inputs or outputs to any terminal or installing or removing any hardware.
-  Make sure you have COMPLETELY powered down ALL devices before connecting or disconnecting the bus or network.

Failure to follow this instruction will result in death, serious injury or equipment damage.





WARNING

RISK OF UNINTENDED EQUIPMENT OPERATION

-  If outputs should fail, outputs may remain on or off. Where personnel and or equipment hazards exist, use an appropriate hard-wired safety system.

Failure to follow this instruction can result in death, serious injury or equipment damage.

WARNING

-  To avoid an electric shock, prior to connecting the HTB's power cord terminals to the power terminal block, confirm that the HTB's power supply is completely turned OFF, via a breaker, or similar unit.
-  Any other power level can damage both the HTB and the power supply.
-  When the FG terminal is connected, be sure the wire is grounded.
-  When turning on the master and slave separately on the CANopen network, the CANopen Slaves (HTB or otherwise) must be turned on first, and then the CANopen master (GP3000 Series CANopen board type or LT3000 Series using CANopen Master Unit) must be turned on last. Not doing so may cause the CANopen network to not operate properly.

3.2.1 Wiring Requirements

■ Power Cord and Input/Output cables Specifications



◆ Power Cord

1 mm² to 1.5mm² (AWG 18 and AWG 16). Use the shortest wire length possible. The grounding wire should be 1.50 mm² (AWG 16).

◆ I/O cables

0.20 mm² to 1.31 mm², (AWG 24 to AWG 16).

(accepts up to two wires fitted with cable ends or tags)

Power supply section	 Ø 3.5 mm [0.14 in.]		N·m	0.6
In/Output terminal connector	 Ø 2.5 mm [0.10 in.]		N·m	0.4

3.2.2 CANopen wiring

The CANopen interface uses DSUB 9-pin plug connector. The plug is assigned with the CAN_H, CAN_L and CAN_GND connections. CAN_H and CAN_L are two physically different bus levels. CAN_GND is the common reference potential.

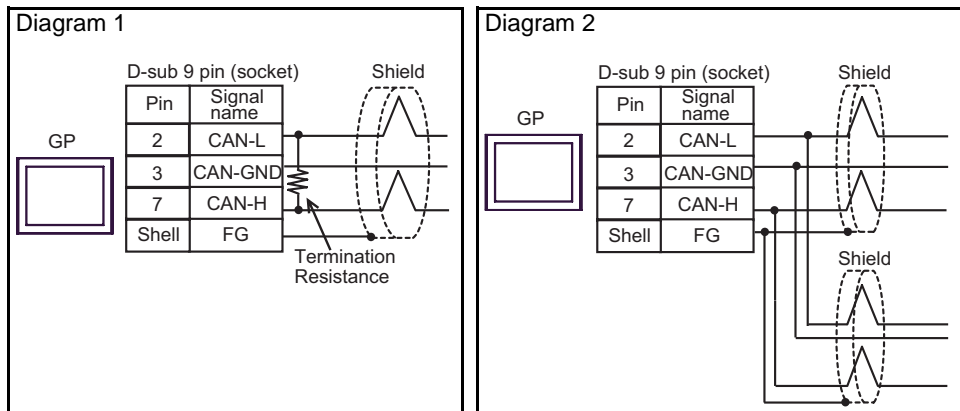
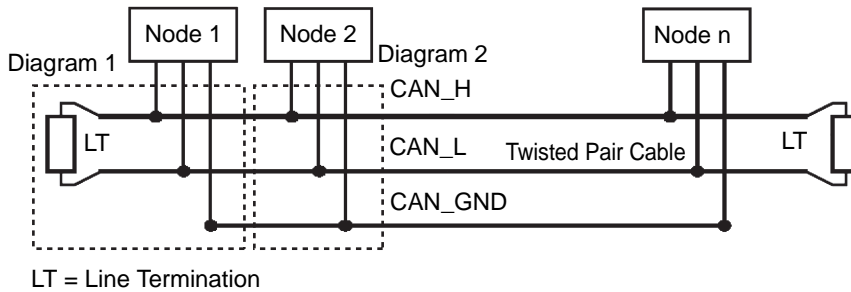

NOTE

- The cable's resistance value should be $70\text{m}\Omega/\text{m}$ or less.
- The above diagrams shows the case used the cable connector "XM2D-0901" by OMRON Co.

■Line termination

To minimize the reflections from the end of the cable, a line termination shall be placed close to the 2 ends of the bus. Connect both ends of the twisted pair cable(CAN_H and CAN_L) to each LT. Use line termination whose resistance value is $120\ \Omega$ (5%, 1/4 W maximum)

3.2.3 Connecting the Power Cord and Input/Output cables

IMPORTANT

- Make sure to remove the connectors from the HTB first, then connect cables to the terminal. Failure to do so may cause an electric shock.
- Be careful when you remove the connectors that are firmly fit.

□ indicates a fuse. L indicates load.

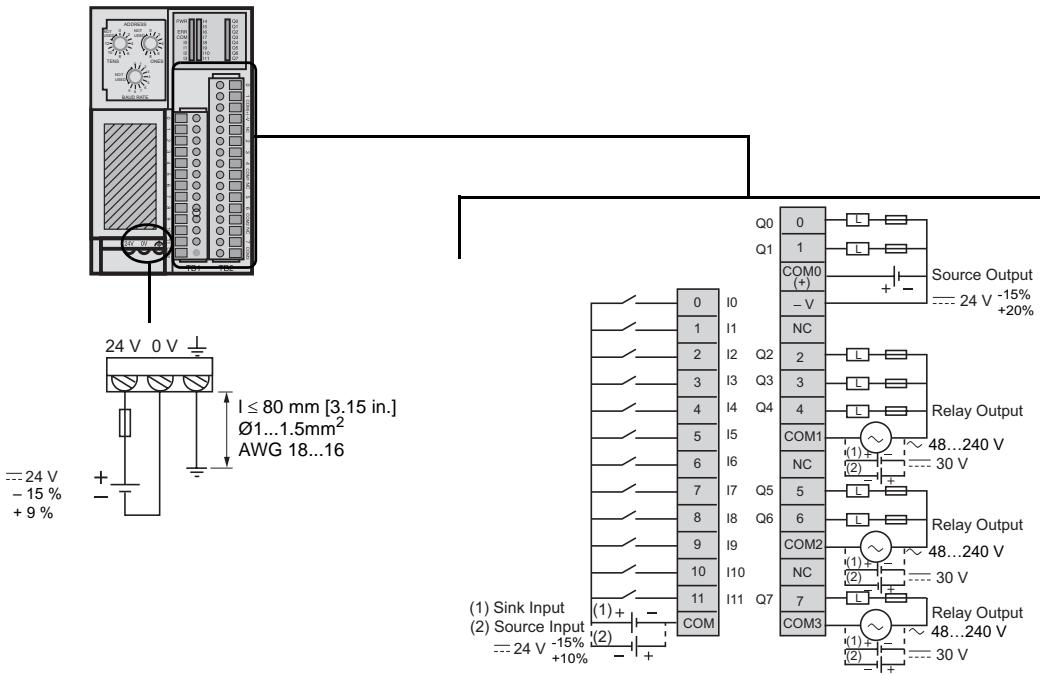

NOTE

- Please install an applicable fuse to prevent an overload in the circuit, if necessary.
- The terminals, such as COM0, and COM1 to 3, are not connected together internally.
- The input/output connector is CA7-HTBCNSET-01 made by Pro-face. 13-pin connector for input and 16-pin connector for output, both connectors are packed.

3.2.4 Wiring Precautions

- Power supply wires routed inside the panel must be kept separate from I/O and communication wiring. Route wiring in separate cable ducting.

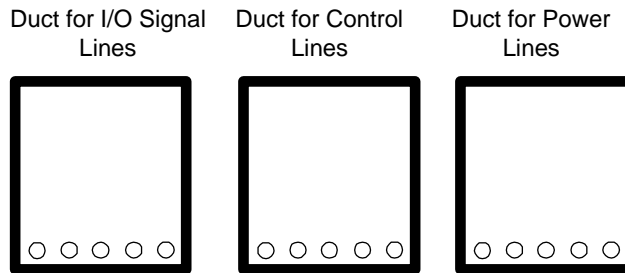

If different wires must be placed in the same duct, separate them with an earthed/grounded divider.

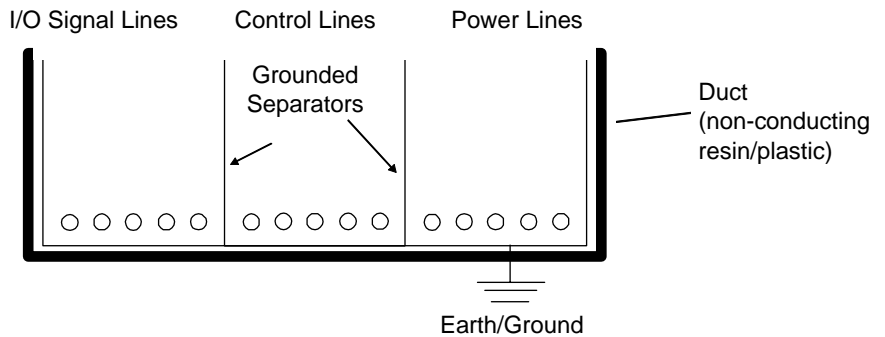

NOTE

- If the lines cannot be separated, use shielded lines and create a ground from the shield line.

IMPORTANT

- Use noise-reducing external wiring methods to increase overall system reliability.
- To prevent power surges or noise interference, use ducts to separate all DC I/O or current circuit wires from communication cables.
- To prevent malfunctions due to noise, communication cables must be wired separately from high-frequency lines and power lines such as high-voltage lines, high-current lines, and inverters.
- Take care when wiring output modules that are designed to work as either source or sink. Incorrect wiring can cause equipment damage.
- Make sure that the operating conditions and environments are within the specification values.
- Use proper wire size to meet voltage and current requirements.
- Fit cable ends to the cables.

3.2.5 Contact Protection Circuit for Relay and Transistor Outputs

Depending on the load, a protection circuit may be needed for relay outputs. Choose a protection circuit, from the following diagrams, according to the power supply.

Connect the protection circuit to the outside of the module for the relay outputs.



RISK OF EQUIPMENT DAMAGE

! Apply circuit protection to all outputs.

Failure to add a protection circuit can result in the malfunction of the output(s) in the case of short circuit or overload condition.

Failure to follow this instruction can result in equipment damage.

Protection Circuit A: this protection circuit can be used when the load impedance is smaller than the RC impedance in an AC load power circuit.

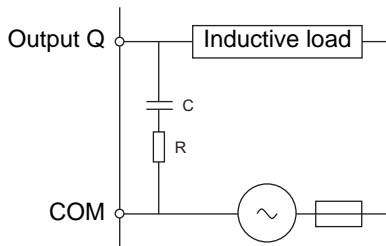

- C represents a value from 0.1 to 1 μF .
- R represents a resistor of approximately the same resistance value as the load.

Protection Circuit B: this protection circuit can be used for both AC and DC load power circuits.

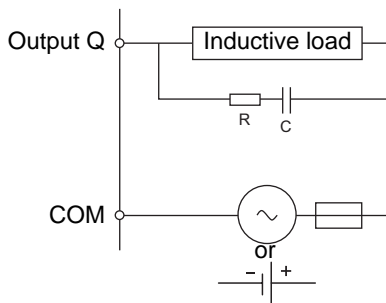

- C represents a value from 0.1 to 1 μF .
- R represents a resistor of approximately the same resistance value as the load.

Protection Circuit C: this protection circuit can be used for DC load power circuits.

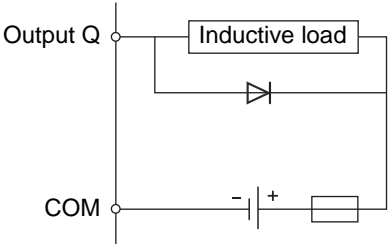

Use a diode with the following ratings:

- Reverse withstand voltage: power voltage of the load circuit x 10.
- Forward current: more than the load current.

Protection Circuit D: this protection circuit can be used for both AC and DC load power circuits.

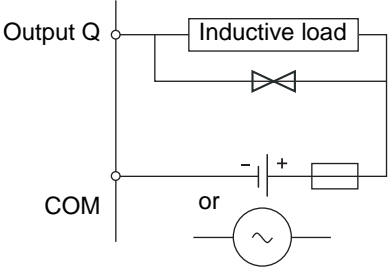

■ Operation of Sink Inputs / Source Outputs

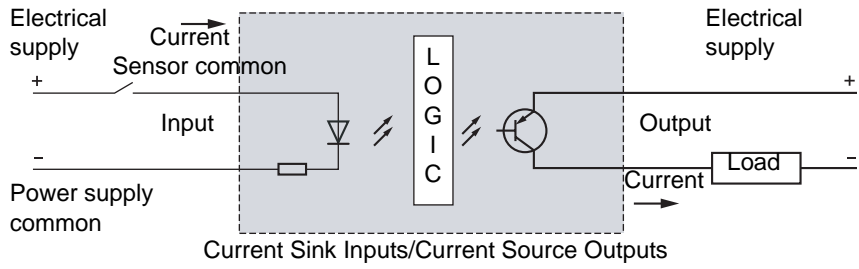

Input side COM field terminal connects to the "-" terminal or common of the field power supply. Output side COM field terminal connects to +24V field power supply.

■ Operation of Source Inputs

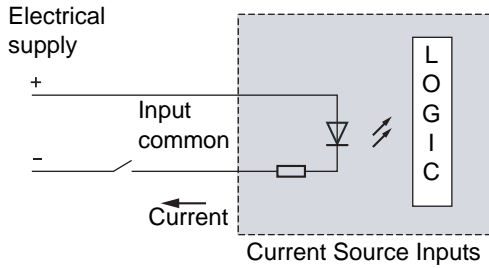

The input side COM field terminal connects to the +24V of the field power supply.