

**Connection Procedure of
SANYO DENKI Servo Amplifier
SANMOTION R and Pro-face display units
supporting CANopen master**

Instruction Manual

Version1.2 (2017.09.15)

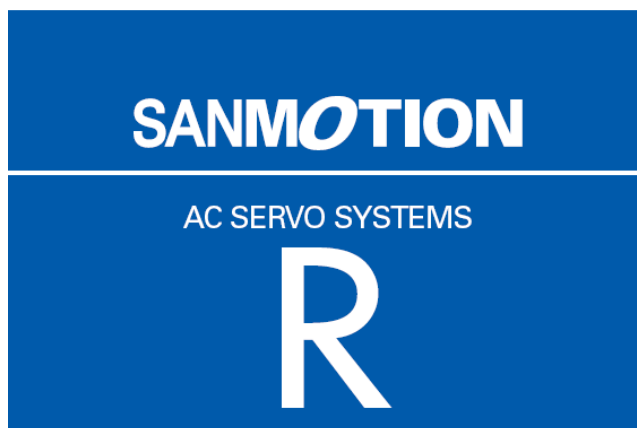

Table of Contents

1	Device in use.....	1
2	Installation of GP-Pro EX version 3.5.....	1
3	Creation of screens/programs.....	1
4	Flow of CANopen setting with the software.....	2
4.1	Displaying the I/O Driver setting screen.....	2
4.2	Importing an EDS file.....	2
4.3	Adding a slave.....	4
4.4	Slave configuration.....	5
4.4.1	PDO: Mapping input and output.....	6
4.4.2	Allocating I/O variables to the I/O tree.....	8
4.5	Master configuration.....	9
4.5.1	Setting a baud rate.....	9
5	Details of settings with the software.....	11
5.1	Catalog manager.....	11
5.1.1	Device operations.....	11
5.1.2	Catalog operations.....	12
5.2	Slave configuration.....	13
5.2.1	Parameters (PDO settings).....	13
5.2.2	Advanced error control.....	16
5.2.3	Advanced object configuration.....	17
5.3	Master configuration.....	18
5.3.1	Network settings.....	18
5.3.2	Error control overview.....	20
5.3.3	Advanced object configuration.....	20
6	PDO protocol, SDO protocol.....	20
6.1	PDO (Process Data Object) protocol.....	20
6.2	SDO (Service Data Object) protocol.....	20
7	I/O driver instructions.....	21
7.1	SDOR, SDOW.....	21
7.2	DGMT, DGSL.....	23
8	Transferring I/O firmware.....	23
9	AGP-3****-CA1M/LT unit.....	24
9.1	Offline menu.....	24
10	Precautions.....	26
11	Installation of SANMOTION R servo amplifier.....	27
11.1	Hardware structure.....	27
11.2	Cabling example.....	28
11.3	Connector pin assignment.....	28
11.4	Status display on front panel of servo amplifier.....	29
11.4.1	7-segment LED.....	29
11.4.2	Red and green LED on CN3.....	30
11.5	Node-ID.....	32
11.6	Bit rate (transmission baud rate) and bus length.....	32
11.7	About EDS file and the revision level of servo amplifier.....	33

1 Device in use

This manual refers to the structure using the following devices and equipments.

- SANYO DENKI servo amplifier SANMOTION R
- Pro-face AGP3400-T1-D24-CA1M
- Pro-face GP-Pro EX version 4.07.200
- Pro-face USB transfer cable CA3-USBCB-01 (for transfer of screen data)

[MEMO]

For the information on display unit models supporting CANopen, see the GP3000 Series Hardware Manual or the LT3000 Series Hardware Manual.

2 Installation of GP-Pro EX version 4.07.200

- 1) Insert the GP-Pro EX installation DVD into the PC, and the SET UP MENU window will appear.
- 2) Select "GP-Pro EX," and the Microsoft .NET Framework 2.0 set up window will appear. Follow the Wizard to install Microsoft .NET Framework 2.0.
- 3) The GP-Pro EX 4.07.200-InstallShield Wizard window will appear. Follow the direction.
 - Enter the Serial Number (11 digits) on the Customer Information window.
 - Enter the Key-Code.
 - Follow the direction of the Wizard to install.

3 Creation of screens/programs

- 1) When you start up GP-Pro EX, the [Welcome to GP-Pro EX] window will appear. Select [New].
- 2) In the [Display Unit] setting screen, set the [Series] to GP-34**Series and the [Model] to AGP-3400T-CA1M.

[MEMO]

If you select the LT3000 series, LT4000 series, or SP5000 series Power Box for the display unit, the [I/O Driver] setting window will be shown next. Please select [CAN open Driver] from the pull-down menu.

- 3) In the [Device/PLC] setting screen, click [New Logic] or [New Screen].
- 4) Create screens and/or a logic program.

4 Flow of CANopen setting with the software

4.1 Displaying the I/O Driver setting screen

- 1) Select the [View] menu -> [Work Space] -> [Project Window].
- 2) In the [Project Window] window, click [I/O Driver] in the Peripheral Settings area, and the [I/O Driver] screen will be shown.

[MEMO]

If you are using the LT3000 series and SP5000 series Power Box, open the [External Driver] tab.

If you are using the LT4000 series, open the [Int.2 Driver] tab.

4.2 Importing an EDS file

This section shows the procedure to import an EDS file of a SANMOTION R slave unit.

- 1) In the [I/O Driver] screen, click [Catalog manager].

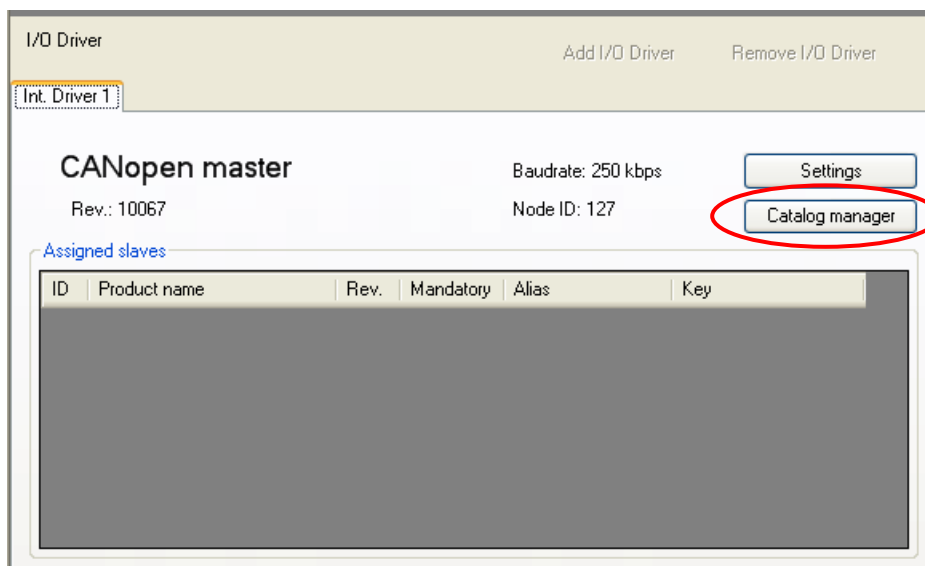

2) Click [Import].

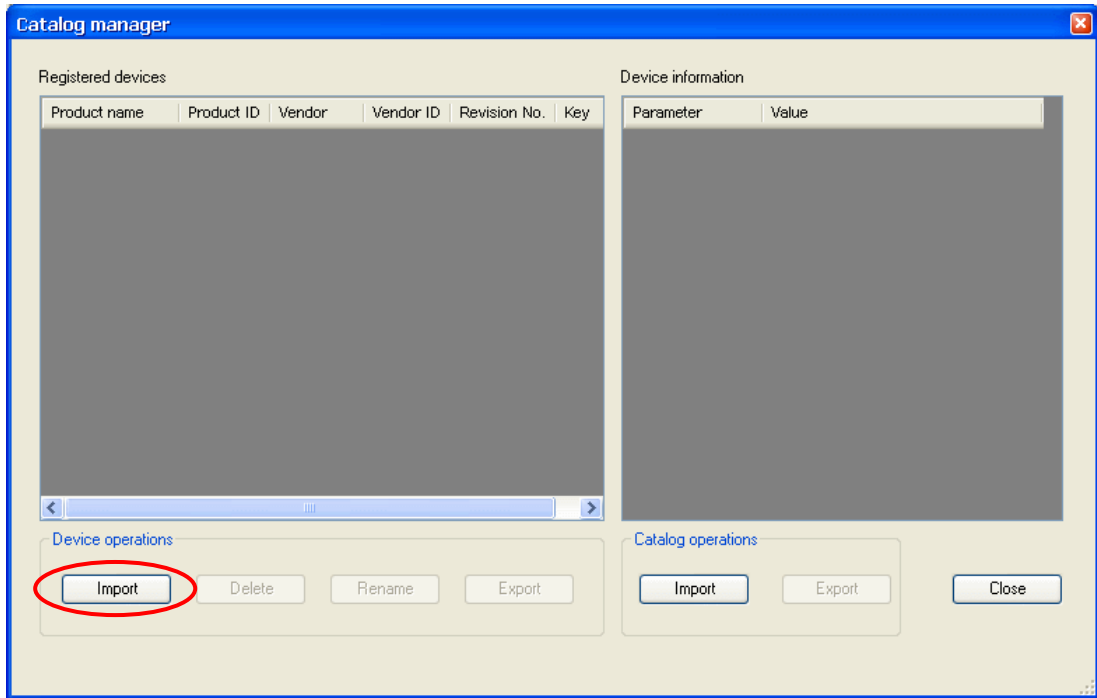

3) The [Open] dialog box will appear. Specify the sanyo_rco.eds file in the save-in location. Click [Open], and the file will be registered into the [Catalog manager].

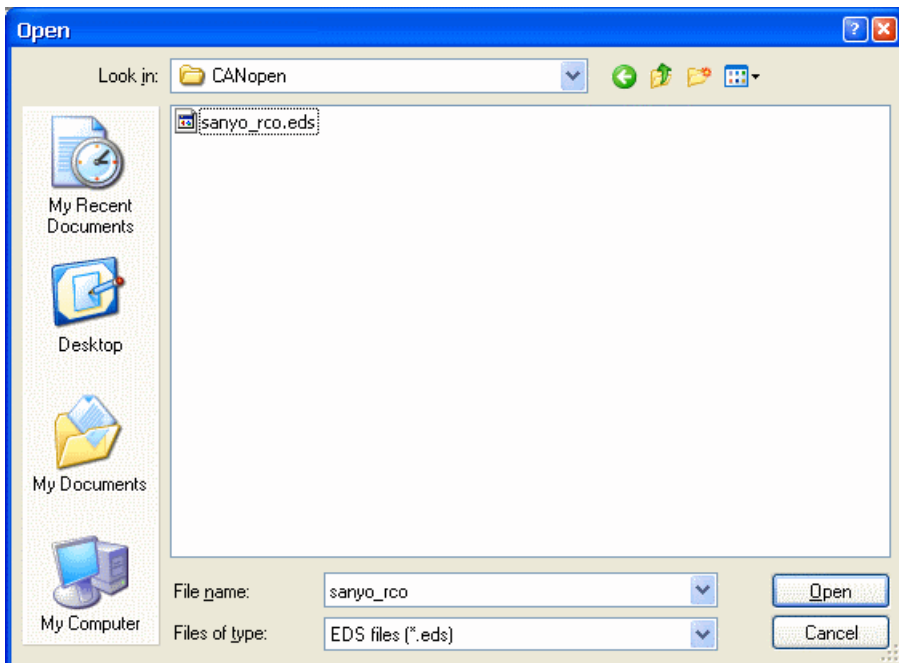

- 4) Click [Close].

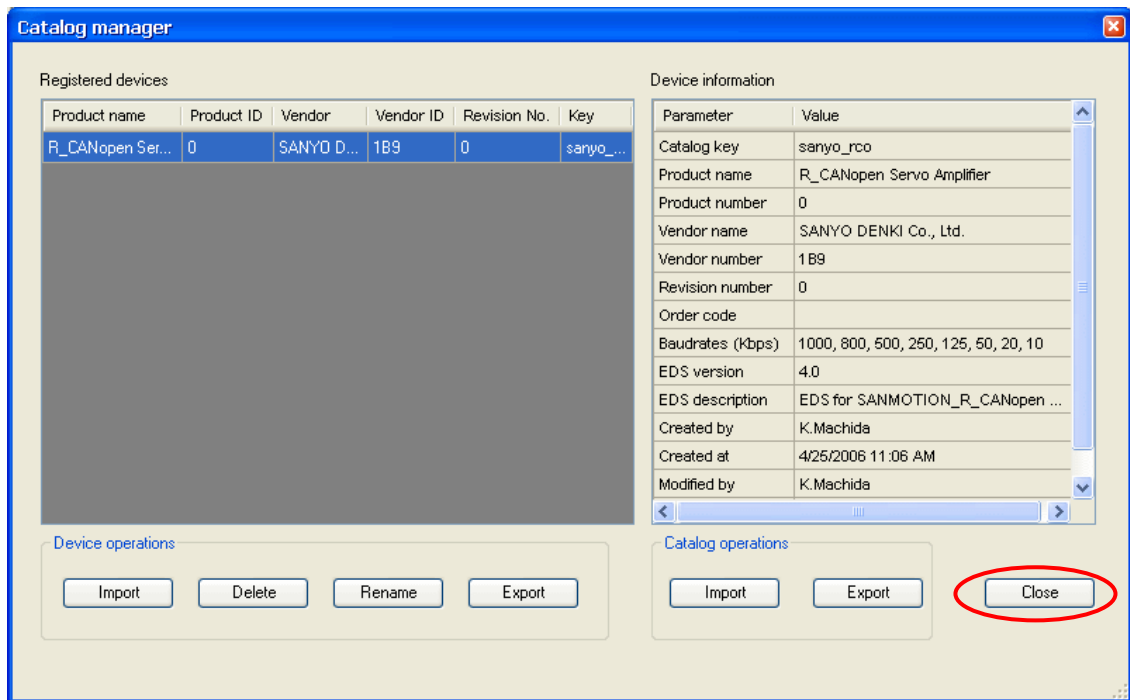

4.3 Adding a slave

- 1) In the [I/O Driver] screen, click [Settings], and the [Network configuration] window will appear.
- 2) Select the item whose Key is sanyo_rco from the [Registered devices] list and click [Add slave], and “R_CANopen Servo Amplifier” will be added in the [Assigned slaves] list.

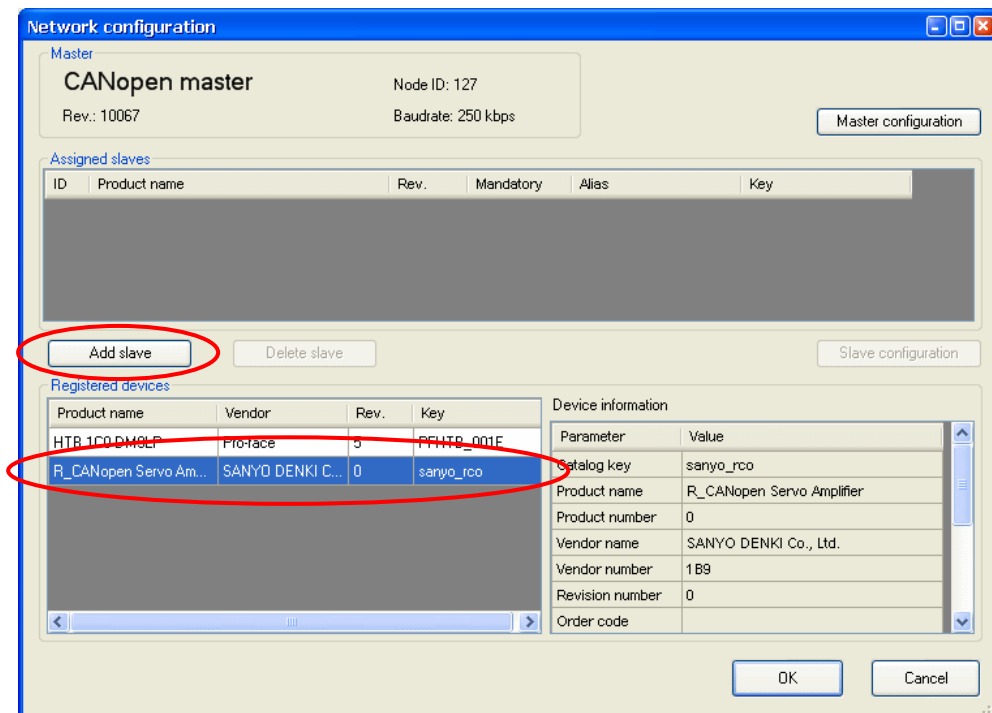

4.4 Slave configuration

- Click [Slave configuration].

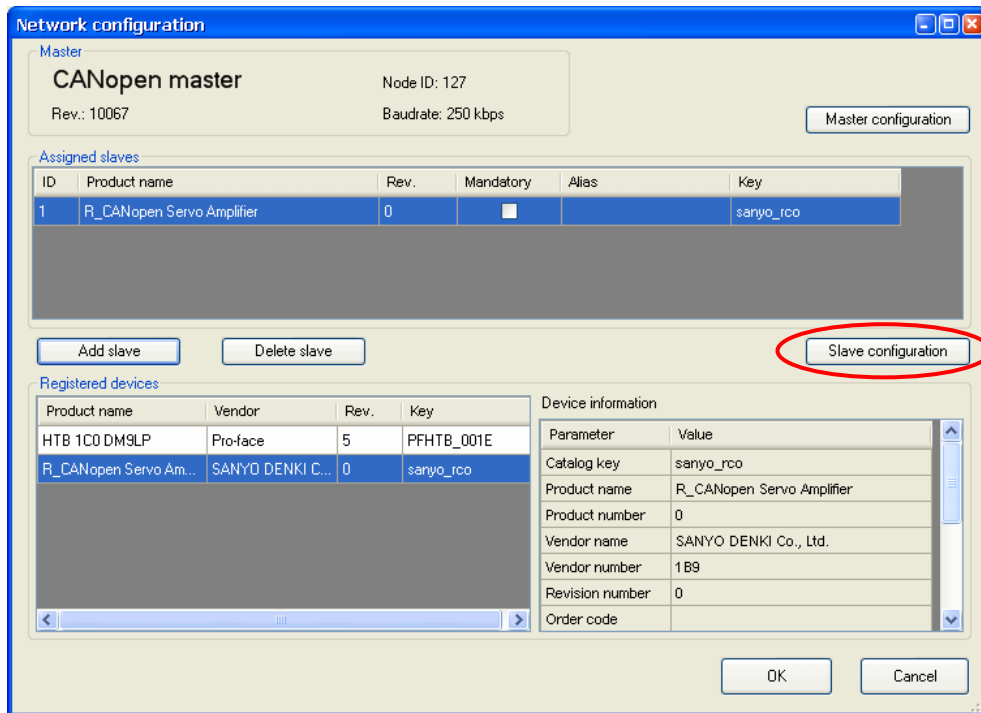

- The [Slave configuration] dialog box will appear.

4.4.1 PDO: Mapping input and output

Set PDOs (Process Data Objects), as continuous communication data.

The following table shows an overview of the object directory as per the CANopen agreement.

Index (hex)	Object
1000-1FFF	Communication Profile Area
2000-5FFF	Manufacturer Specific Profile Area
6000-9FFF	Standardized Device Profile Area
A000-FFFF	Reserved for further use

[MEMO]

For the details of the objects, refer to the SANMOTION R instruction manuals.

- 1) As an example of inputs, select “Index = 0x6064.0” (Position_actual_value) from the list of the [Available objects from device profile] in the [Parameters] tab.
- 2) If you select “TPDO1” in the [Configured objects], the [Map] button will be enabled.

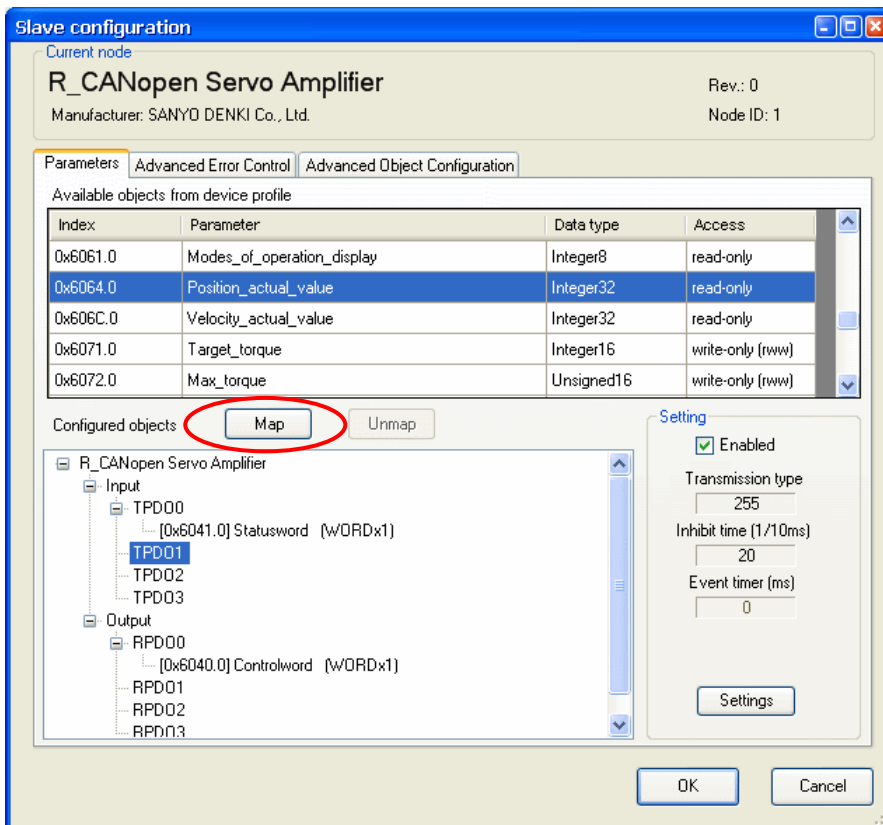

- 3) Click [Map], and “[0x6064.0] Position_actual_value” will be appended under “TPDO1.”
- 4) Set the [Data representation] in the [Setting] area to “Dword.”

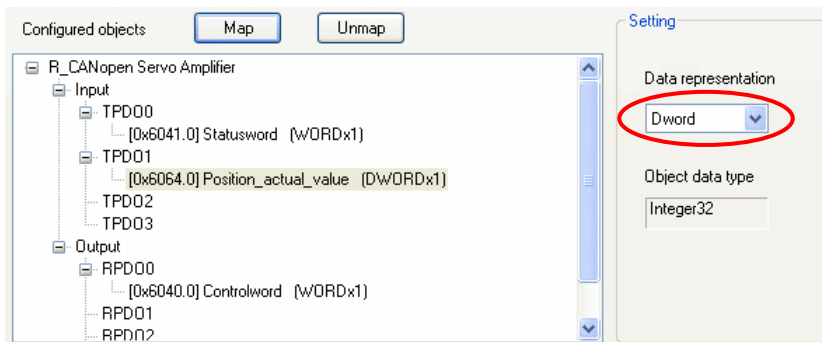

- 5) As an example of outputs, select “Index = 0x607A.0” from the list of the [Available objects from device profile] on the [Parameters] tab.
- 6) Select “RPDO1” in the [Configured objects] and click [Map], and “[0x607A.0] Target_position” will be appended under “RPDO1.”

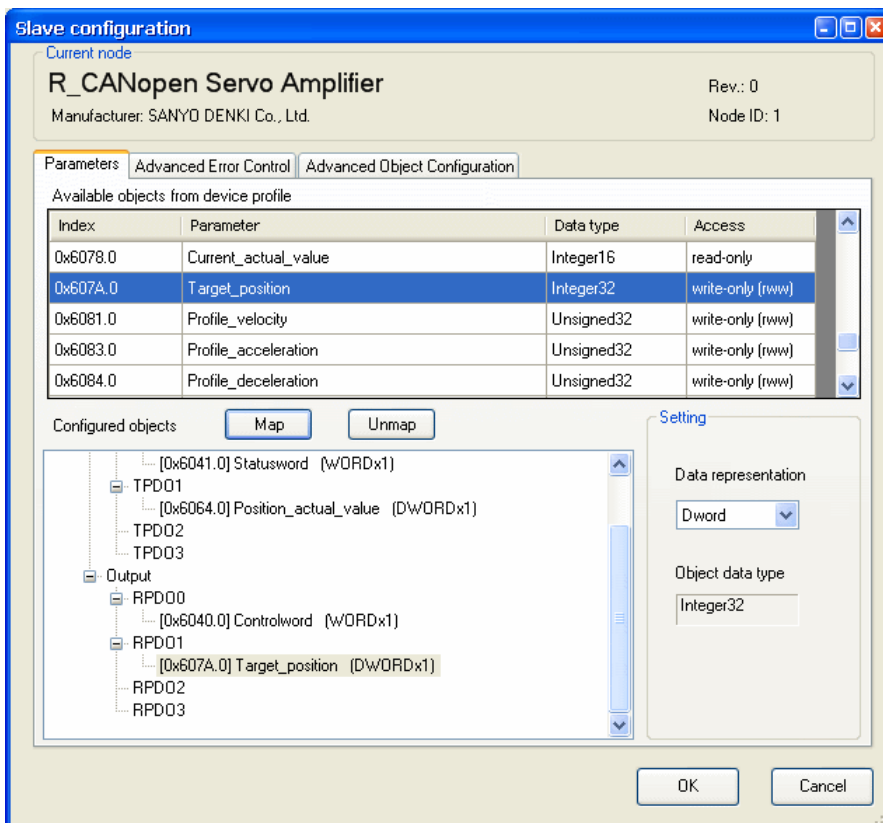

- 7) Set the [Data representation] in the [Setting] area to “Dword” and click [OK]. Then click [OK] in the [Network configuration] window, and it will be closed and the [I/O Driver] screen will be shown.

4.4.2 Allocating I/O variables to the I/O tree

Allocate I/O variables after the PDO settings (mapping).

- 1) Click [I/O Screen] in the [I/O Driver] screen.
- 2) The [R_CANopen Servo Amplifier] tree will be shown. As an example, allocate a variable “ActualPosition” to an item “Position_actual_value” (an object at the actual position), which is under “TPDO1.” To set a variable, double click the corresponding variable field and enter the variable.

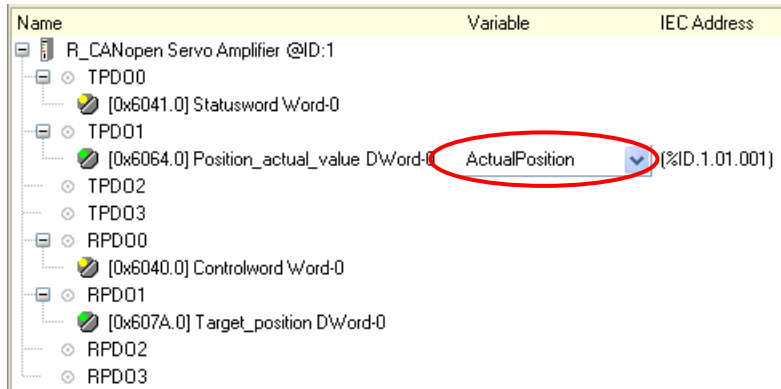

[MEMO]

By pointing the cursor on the red marked area and dragging, you can change the column width.

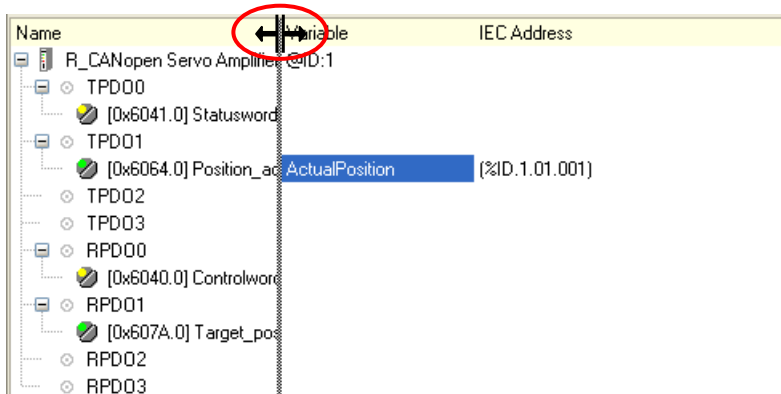

- 3) In the same way, set a variable “TargetPosition” to an item “Target_position” (an object at the target position), which is under “RPDO1.”

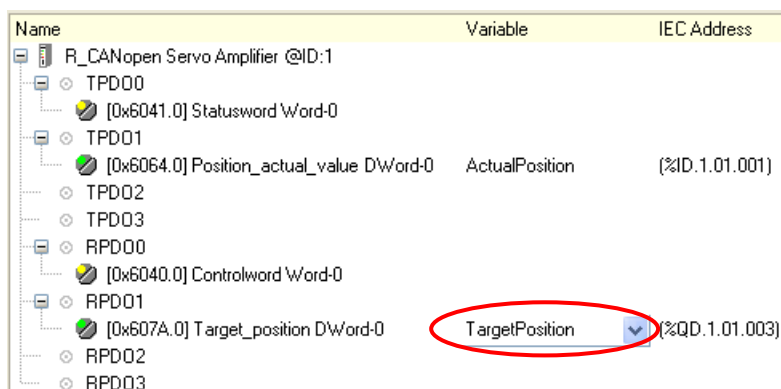

- 4) Click [CANopen Driver] to return to the [I/O Driver] screen.

4.5 Master configuration

- In the [I/O Driver] screen, click [Settings].

4.5.1 Setting a baud rate

In the Master configuration, you can make baud rate settings.

- 1) In the [Network configuration] window, click [Master configuration].

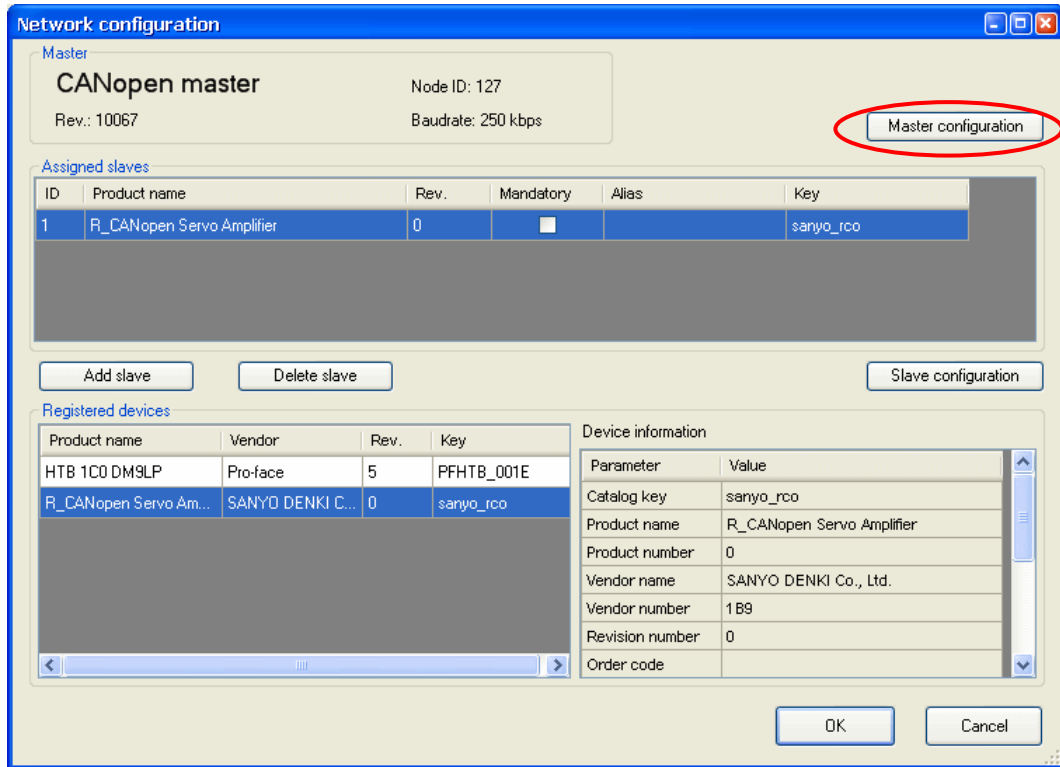

[MEMO]

To set the baud rate on the slave unit, use R-SETUP - Setup Software made by SANYO DENKI.

For the details, refer to the manuals for the servo amplifier.

The factory default of the baud rate on the servo amplifier is 500 kbps.

- 2) In the [Master configuration] dialog box, specify the [Baud rate].

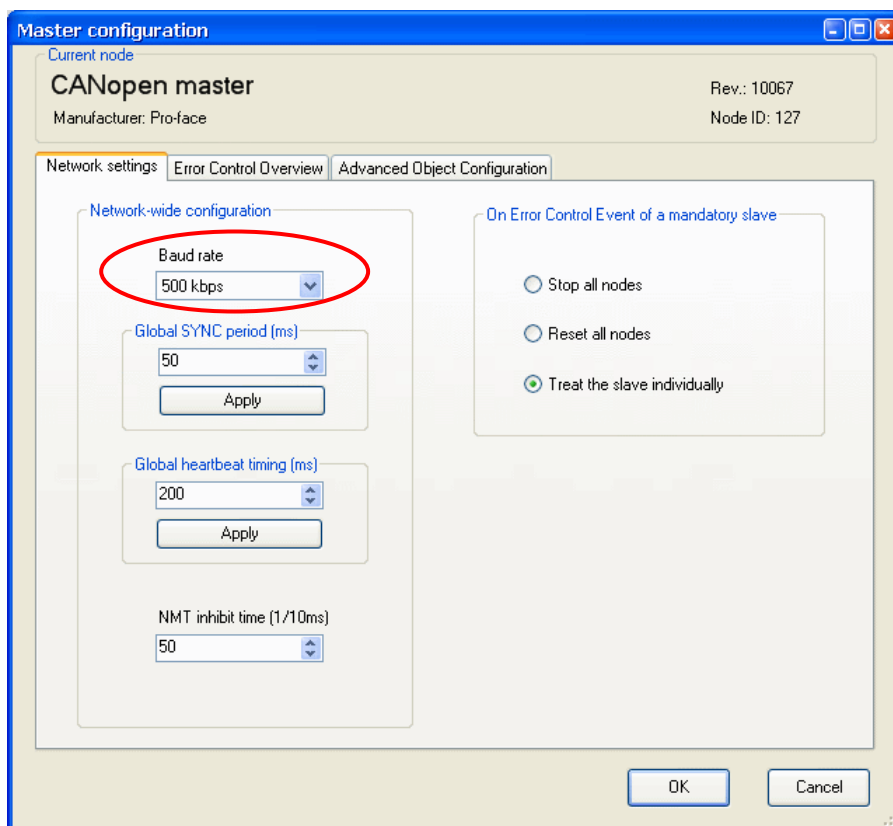

[IMPORTANT]

The baud rate cannot be set to 800 kbps when connecting with SANMOTION R.

If you set it to 800 kbps, a transmission speed error will occur between the SANYO servo amplifier and the Pro-face display unit.

[MEMO]

When LT4000 series is used, the baud rate cannot be set to 500kbps and 1000kbps.

5 Details of settings with the software

5.1 Catalog manager

5.1.1 Device operations

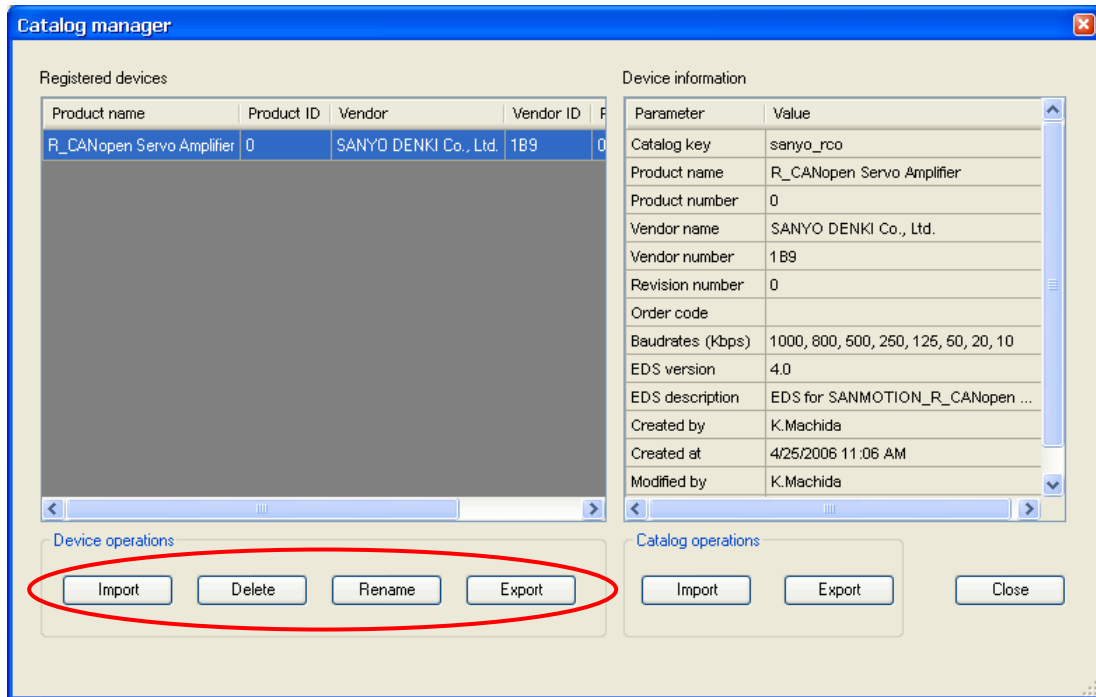

* Import

Imports an EDS (Electronic Data Sheet) file.

The EDS file is registered in the Catalog manager of GP-Pro EX, and the contents in the EDS file is shown in the Catalog manager.

* Delete

Deletes a designated device from the catalog in GP-Pro EX.

* Rename

Allows you to rename the key of a device registered in the catalog.

The name of the key when importing an EDS file is the EDS file name without the extension.

Up to 256 characters.

* Export

Exports contents in a device registered in the catalog as an EDS file.

5.1.2 Catalog operations

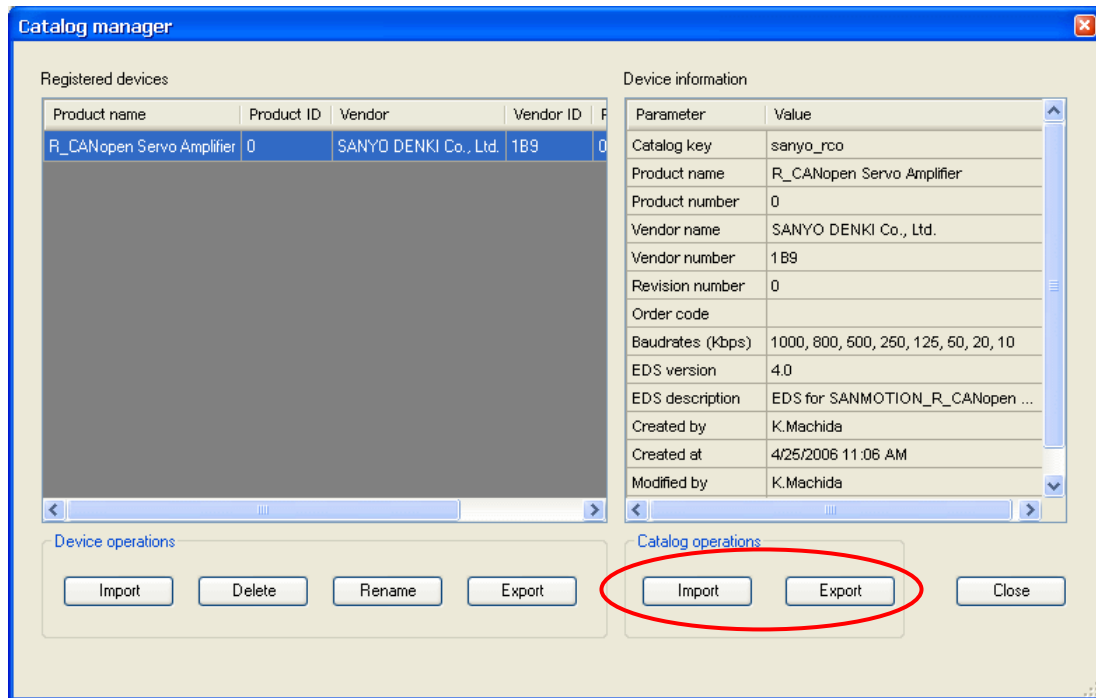

* Export

Exports registered devices into one file (a catalog file; *.cat).

By doing so, it will be easier to make the same environment in another PC.



* Import

Imports a catalog file.

5.2 Slave configuration

5.2.1 Parameters (PDO settings)

Up to 8 bytes (64 bits) of data can be assigned per PDO.

The transmission type can be set by each PDO.

- In the [Network configuration] window, click [Slave configuration]. In the [Slave configuration] dialog box, select “TPDO0” in the [Configured objects] and click [Settings].



The [TPDO configuration] dialog box will appear.

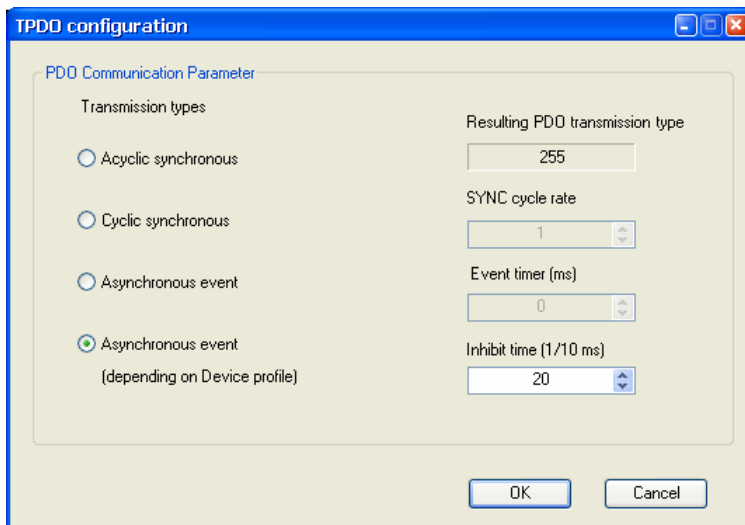

* Asynchronous event

A PDO is received immediately when an event occurs regardless of the SYNC signal.

For 254, this is defined by the manufacturer.

For 255, this is defined in the device profile.

* Acyclic synchronous / Cyclic synchronous

A PDO is sent synchronizing in synchronization with the SYNC signal flowing into the network.

For the cyclic synchronous, whose SYNC cycle rate can be set from 1 to 240, when 1 is set, a PDO is sent for every SYNC object.

When 3 is set, a PDO is sent each time that three SYNC signals flow into the network.

* Event timer, Inhibit time

The Event timer and the Inhibit time can be set when the transmission type is set to Asynchronous event. The Event timer is the setting to send data consistently besides to send it when it changes.

The Inhibit time is the setting to inhibit increase of communication load by continuous data change.

For SANMOTION R Series, the Event timer is not supported and the setup range of the Inhibit time is 2ms to 2000ms.

* Identity settings

The master unit makes identity check between the device information (the contents of the imported EDS file) and the actual slave unit when communication starts.

Items to be checked are as follows.

- Device type
- Vender ID
- Product code
- Revision number

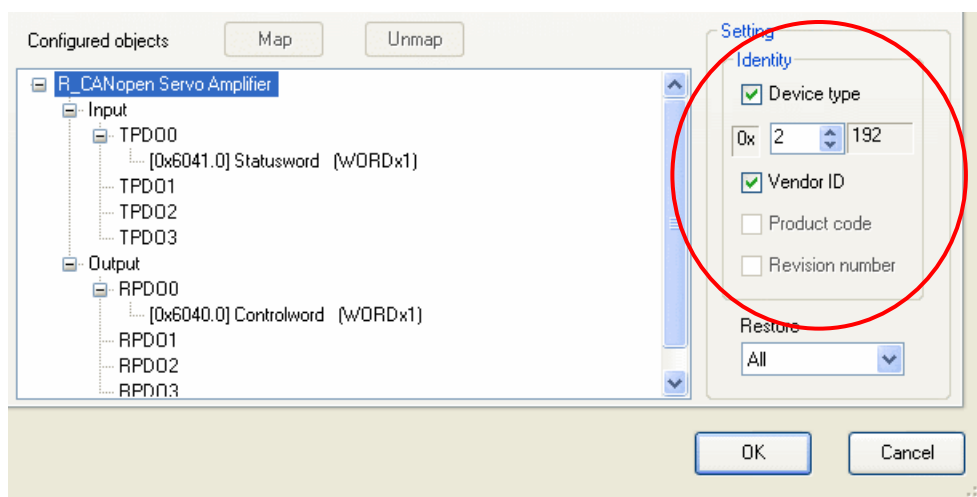

When connecting a SANMOTION R, only the followings can be checked. (Depending on the description of the EDS file)

- Device type
- Vender ID

If the item(s) cannot be identified, an error code “150: Identity error of an optional slave” will be displayed on the GP/LT unit.

* Restore

Set for the master unit whether or not to restore, or write, the parameters of slave units on occasions such as when a communication cable is disconnected and the system is recovered.

If you select “None,” the slave units can operate retaining the outputting signals.

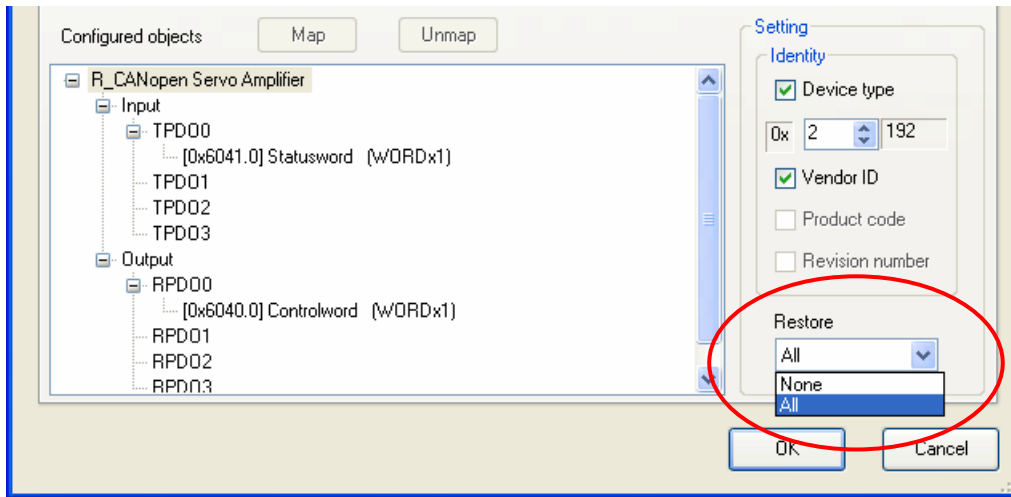

Select from the following two items for the parameter restoration.

- None: Parameters are not restored.
- All (default): All parameters are restored.

5.2.2 Advanced error control

* HeartBeat

Each node (the master and slaves) sends heartbeat messages.

By monitoring (receiving) heartbeat messages, the master can check each node is active.

The producer is the one that sends messages, and the consumer is the one that receives the messages.

Currently, not NodeGuard but HeartBeat is recommended to use.

In the [Network configuration] window, click [Slave configuration] to set the heartbeat in the [Advanced Error Control] tab.

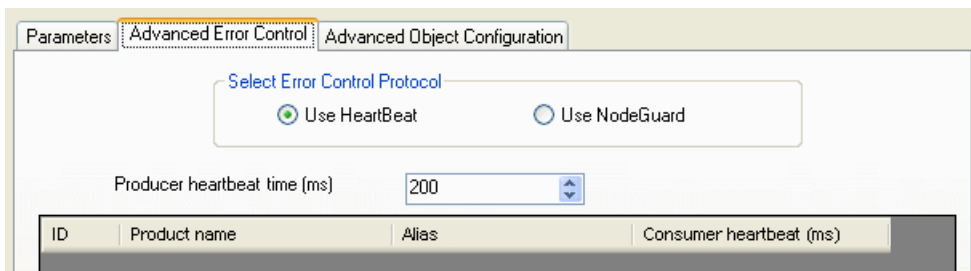

[Remark]

The heartbeat can be set in the Master configuration dialog box normally.

Set the [Global heartbeat timing] on the [Network settings] tab and click [Apply] to apply the setting to all slaves.

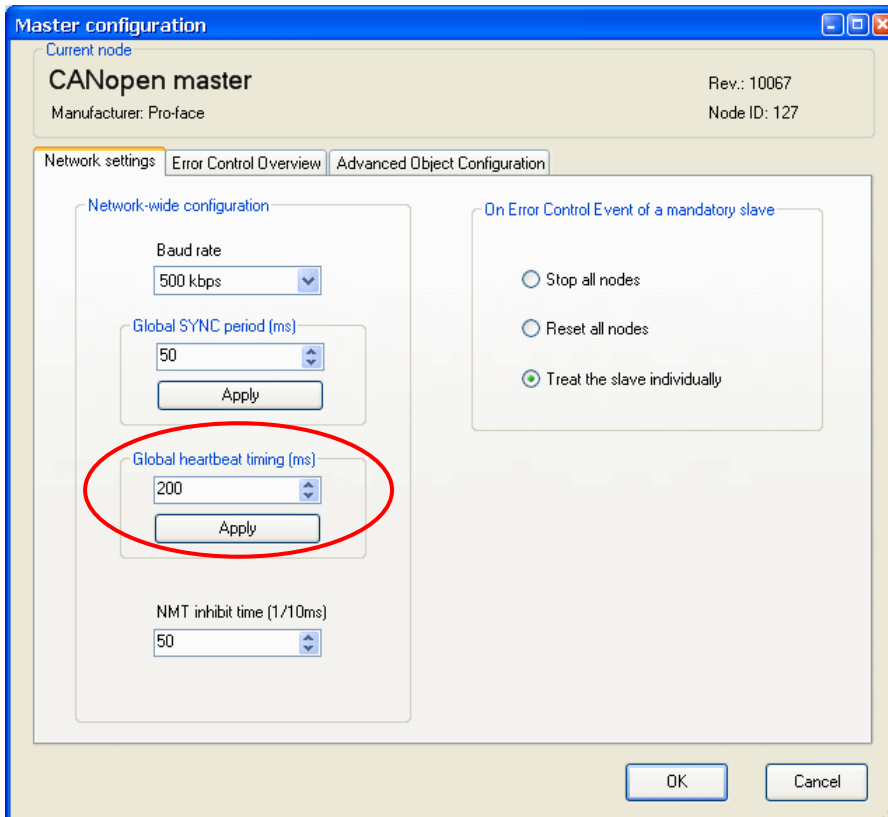

* NodeGuard

The master unit monitors slaves by polling (guarding) for the time of the Guard time multiplied by the Life time factor.

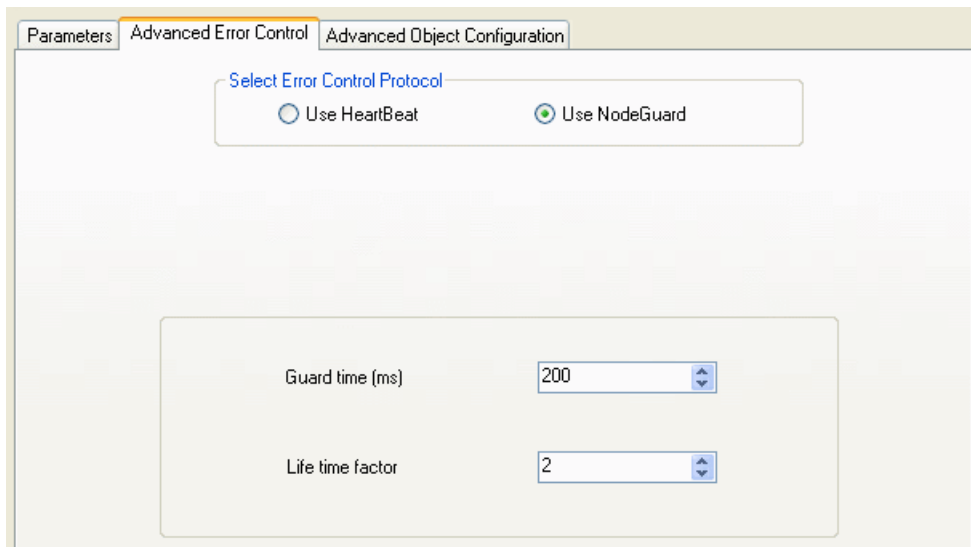

5.2.3 Advanced object configuration

The Advanced Object Configuration tab shows the object list of the slave unit.

The contents of objects vary depending on the type of the slave unit.

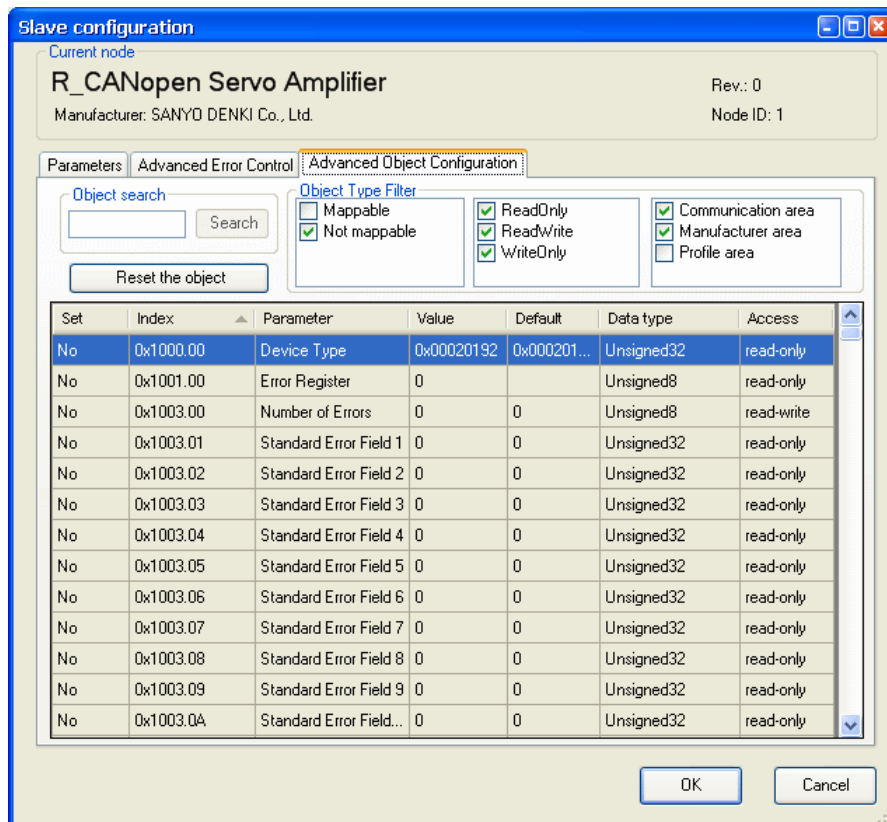

5.3 Master configuration

5.3.1 Network settings

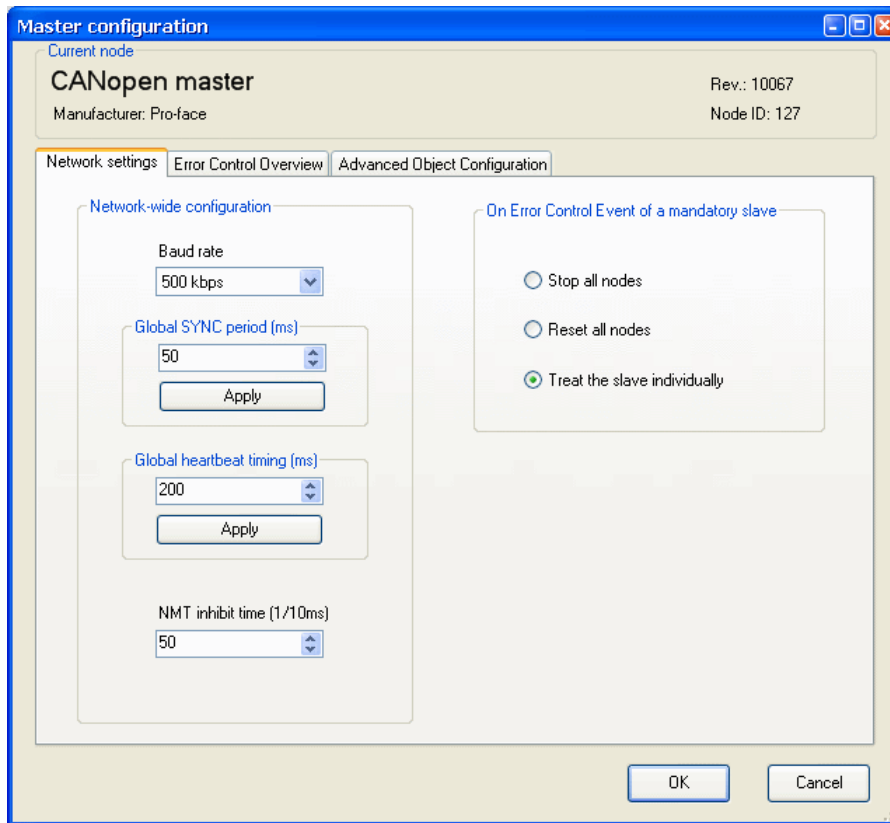

* Baud rate

Select the baud rate of the master unit.

50 kbps to 1000 kbps (default: 250 kbps)

[IMPORTANT]

When LT4000 series is used, the baud rate cannot be set to 500kbps and 1000kbps.

The maximum baud rate that can be used for SANMOTION R Series, therefore, is 250kbps.

* Global SYNC period

Set the send cycle time of SYNC messages.

0 (disabled), 3 to 32767ms (default: 50ms)

For SANMOTION R Series, the setup range of the Global SYNC period (the object 0x1006) on the slave's side is 2ms to 100ms and 0 (disabled) cannot be set.

When the Global SYNC period on the master's side is set, the setup range of the Global SYNC period on the slave's side needs to be considered.

[IMPORTANT]

When using LT4000 series, select [Enabled] or not for sending SYNC messages. When [Enabled] is selected for SYNC transmission, the SYNC messages are sent at the cycle time synchronizing with the scan time of the logic program.

For SANMOTION R Series, make sure that [Enabled] is selected for sending SYNC messages and the scan time of the logic program is within 100ms.

* Global heartbeat timing

To check, or monitor, whether the slave unit is active or not, use the heartbeat or the node guarding.

50 to 21844ms (default: 200ms)

* NMT inhibit time

This is the setting to inhibit the master unit to send NMT messages continuously.

NMT stands for "Network Management."

0 to 3276.7ms (default: 5ms)

* On Error Control Event of a mandatory slave

Select from the following 3.

- Stop all nodes
- Reset all nodes
- Treat the slave individually (default)

If you select [Treat the slave individually], each slave unit sends the reset signal, not the master unit sends the reset signal by broadcast.

5.3.2 Error control overview

The Error Control Overview tab allows you to check the list of the node monitor (Heartbeat / Node guard).

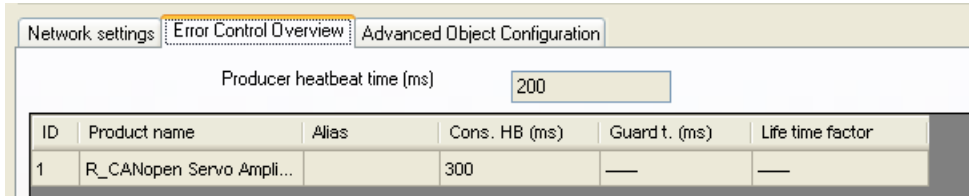

5.3.3 Advanced object configuration

The Advanced Object Configuration tab shows the list of objects of the master unit.

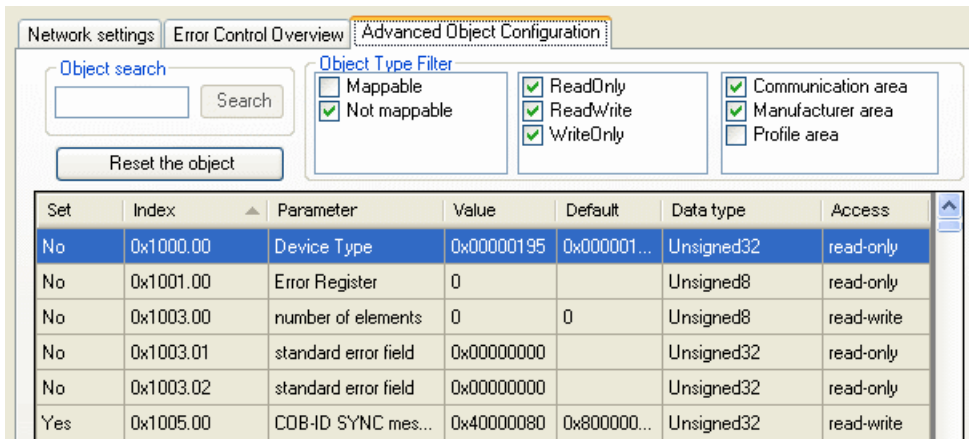

6 PDO protocol, SDO protocol

6.1 PDO (Process Data Object) protocol

The PDO protocol is used for communicating data such as digital inputs and outputs continuously.

6.2 SDO (Service Data Object) protocol

The SDO protocol is used for communicating data not necessary to be sent continuously, such as infrequent changes of setting values.

Data assigned to SDOs are communicated by the SDO instructions (SDOR, SDOW) of the logic program.

7 I/O driver instructions

7.1 SDOR, SDOW

Reads from / writes to objects of the slave unit.

SDOR (SDO Read)

- S1: index number of the object
- S2: sub index number of the object
- S3: node ID
- S4: length (byte number) of the object access
- S5: location to store read data (offset number of #L_IOMasterDrv[])
- D1: error code

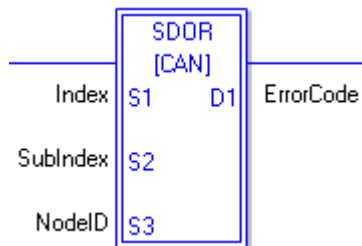

The screenshot shows a dialog box titled "[CAN]SDOR" with a close button in the top right corner. The dialog contains five input fields for S1, S2, S3, S4, and S5, and one input field for D1. Each field has a dropdown arrow. The S1 field is labeled "Index", S2 is "SubIndex", S3 is "NodeID", S4 is "Length", and S5 is "Offset". The D1 field is labeled "Error Code". At the bottom right, there are two buttons: "OK (O)" and "Cancel".

SDOW (SDO Write)

- S1: index number of the object
- S2: sub index number of the object
- S3: node ID
- S4: length (byte number) of the object access
- S5: location to store data to be written (offset number of #L_IOMasterDrv[])
- D1: error code

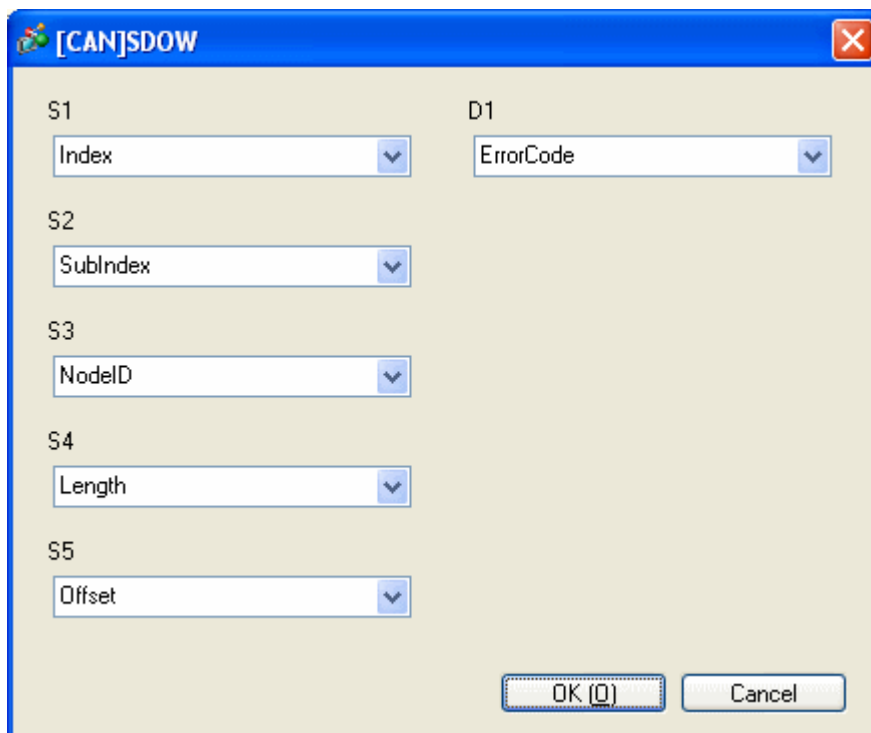
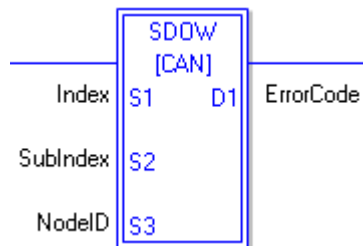

7.2 DGMT, DGSL

Reads the status of the master unit / slave unit.

DGMT (Diagnostic Master)

D1: status information

D2: event information

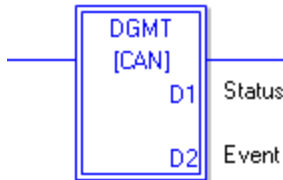

DGSL (Diagnostic Slave)

S1: node ID

D1: slave diagnostic information



8 Transferring I/O firmware

Firmware for the CANopen board is not yet installed in CANopen units for AGP-3****-CA1M/LT by factory default. The firmware is transferred and written when the first screen data transfer.

This I/O firmware is written when the unit is restarted after transferring the project file.

9 AGP-3****-CA1M/LT unit

9.1 Offline menu

In the Offline mode, you can check the communication status when the master unit and the slave unit are connected. To enter the Offline mode, touch either the upper right and lower left corners or the upper left and lower right corners (within 40 pixels of the edges) of the panel in this order within 0.5 second.

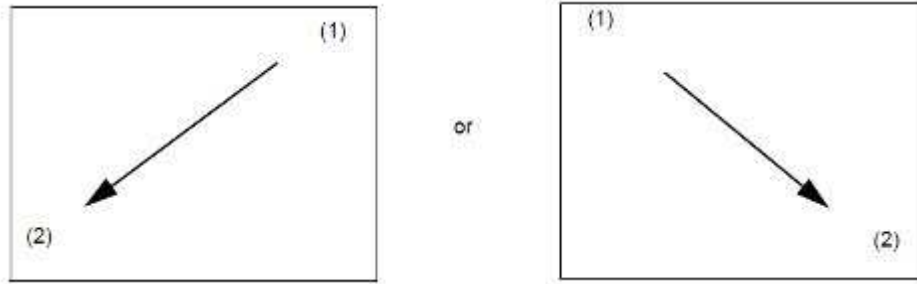

[MEMO]

For the details of the Offline mode, refer to the Maintenance/Troubleshooting manual of GP-Pro EX.



*** Master Diagnostics, Master Configuration & Events**

These menus have the same contents as the DGMT instruction does, which is one of the I/O driver instructions.

The Master Diagnostics screen includes status information and the Master Configuration & Events screen includes event information.

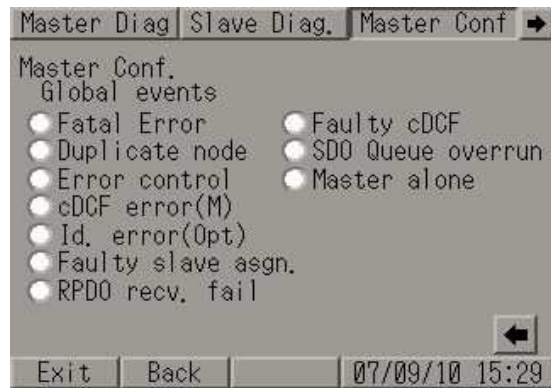
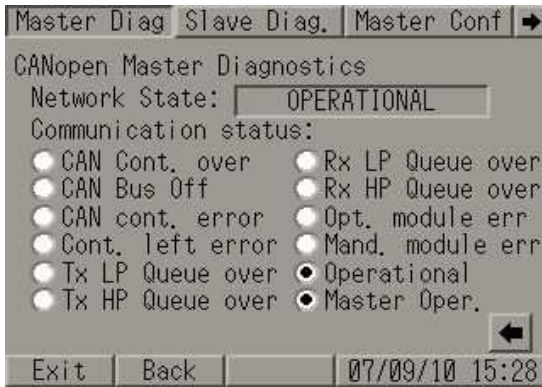

*** Slave Diagnostics**

This menu has the same contents as the DGSL instruction does, which is one of the I/O driver instructions.

You can select the status of the slaves and check nodes in the list.

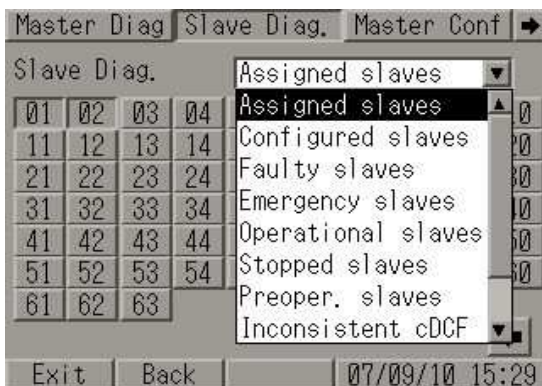

10 Precautions

- The maximum number of objects that can be assigned to each PDO is 4.
This is not because GP-Pro EX has such a restriction, but because it is based on the definition in an EDS file of the SANMOTION R.
Therefore, you cannot assign more than 5 objects even if the data size of one object is less than 8 byte.

11 Installation of SANMOTION R servo amplifier

11.1 Hardware structure

This section introduces the servo amplifier's parts name, referring to RS1□03AL.

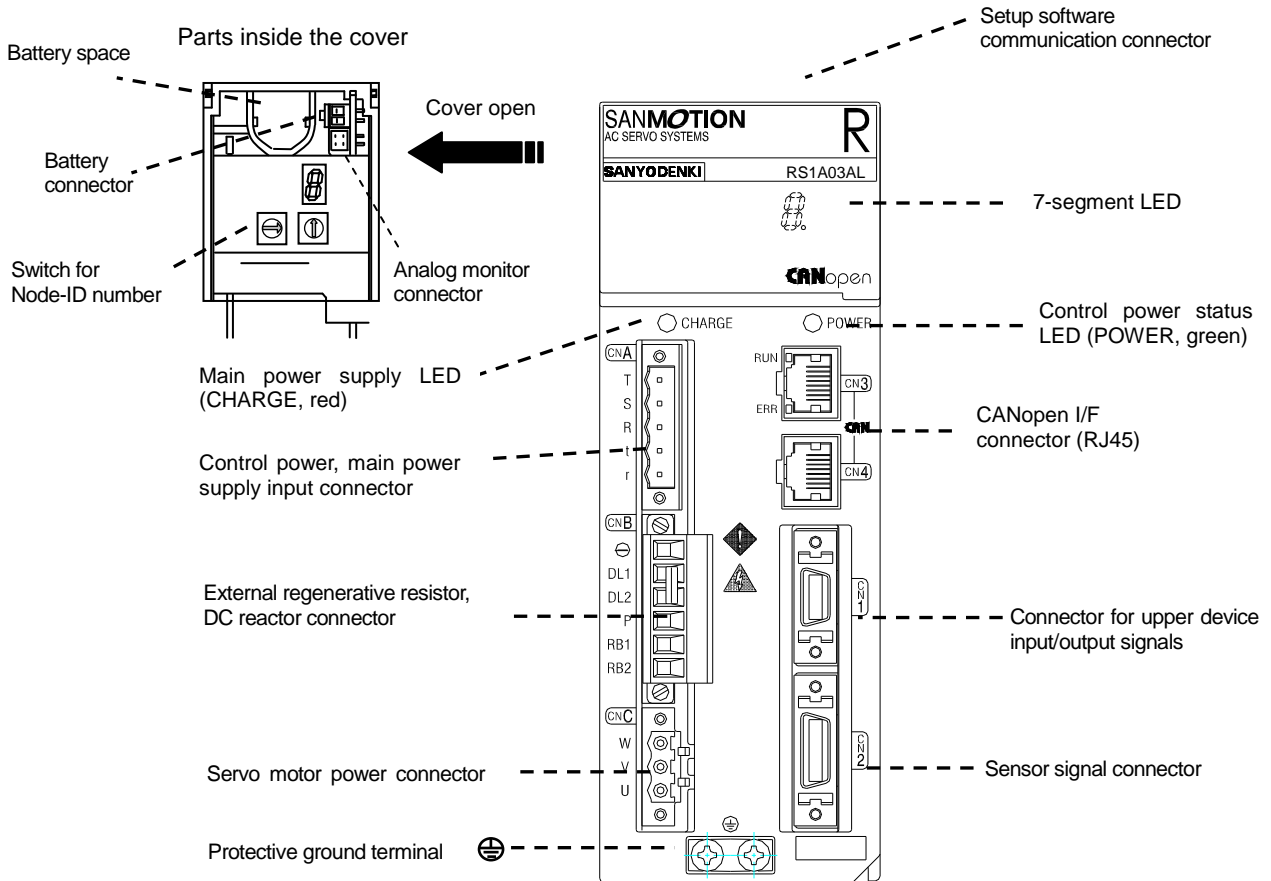

For the information on pin assignment of each connector other than the CANopen interface connector, see SANMOTION R with CANopen Interface Instruction Manual (M0007951.)

For the information on pin assignment of the CANopen interface connector, see the following pages.

11.2 Cabling example

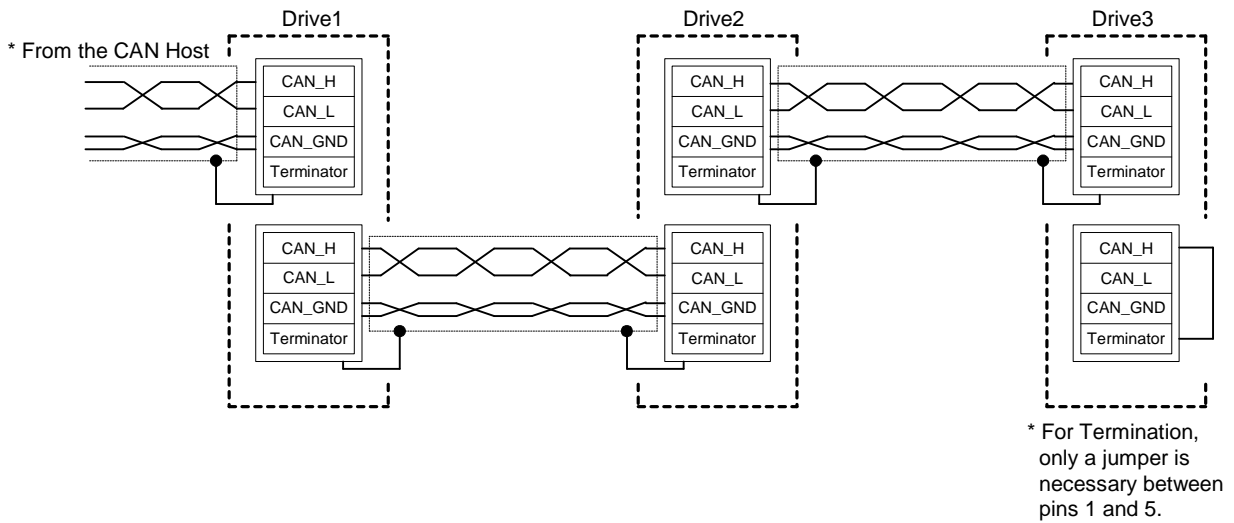

- To avoid malfunction of communication, it is recommended to use shielded cable with two twisted pair.
 - One twisted pair is used for CAN_H (Pin 1) and CAN_L (Pin 2.)
 - Another twisted pair is used for CAN_GND (Pin 3 and Pin 7.)
 - Cable shield has to be connected to metal body plug of RJ-45 type connector.
- The both ends of the CAN cable have to be terminated by a resistor of 120Ω.
 The SANMOTION R CANopen interface amplifier has an internal termination resistor. It is necessary to plug a modular connector with a jumper between Pin 1 and Pin 5 for termination.

11.3 Connector pin assignment

SANMOTION R CANopen interface amplifier has two ports of RJ-45 modular connector for CAN connection. Pin assignment of both connectors is just the same, and it is shown in the following figure.

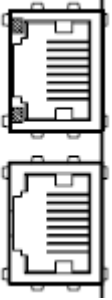
CN3, CN4	Pin No.	Signal Name
	1	CAN_H
	2	CAN_L
	3	CAN_GND
	4	No connection
	5	Terminator
	6	(CAN_SHLD)
	7	CAN_GND
	8	No connection

Note

1. CN3 has two LEDs which show the status of CAN communication. (See Chapter 11.4.2)
2. A termination resistor (120Ω) is integrated in this amplifier that can be connected between CAN_H and CAN_L by plugging a modular connector with a jumper between pins 1 and 5.
3. The CAN_GND pin is connected to amplifier internal signal ground.
4. CAN_SHLD is optional.

11.4 Status display on front panel of servo amplifier

11.4.1 7-segment LED

One digit of 7-segment LED displays following drive states.

- Settled Node-ID for CAN communication
- Servo status
- Alarm codes









11.4.1.1 Settled Node-ID for CAN communication display

Right after the control power is turned ON, timeshared 3-digit of a settled Node-ID for CAN communication is displayed.

The settled node-ID when it displays '1' -> '2' -> '3' is "123" in decimal numbers.

11.4.1.2 Drive status display

After displaying the settled Node-ID, the following display appears if there is no error occurrence.

Servo amplifier status	Display
Control power supply established (NOT RDY) Control power supply has been established, but amplifier (RDY) is OFF because the state of CAN communication has not been raised up to "Ready to switched ON" state	 Flashing
Control power supply established (RDY) Control power supply has been established and amplifier (RDY) is ON	
Main power supply established (NOT RDY) Main power supply is ON or has been established, but amplifier (RDY) is OFF because the state of CAN communication has not been raised up to "Ready to switched ON" state	 Flashing
Main power supply being established Main power supply is ON or has been established, but Operation Preparation Completion signal is OFF	
Main power supply established Main power supply has been established and Operation Preparation Completion signal is ON	
Servo is ON Power has been applied to the motor after servo ON Continuously draws the character "8"	
Over Travel status at Positive rotation Positive rotation is in "Over Travel" status	
Over Travel status at Negative rotation Negative rotation is in "Over Travel" status	

11.4.1.3 Alarm code display

When an alarm occurs, timeshared 2-digit of Alarm Code (R-CANopen amplifier specific)” will be displayed continuously.

For the details of alarm codes, see SANMOTION R with CANopen Interface Instruction Manual (M0007951.)

11.4.2 Red and green LED on CN3

The status of CAN communication can be displayed by following two single LEDs on CN3.

- Red LED: ERR_LED; displays error state of CAN communication
- Green LED: RUN_LED; displays running state of CAN communication

The following table shows how to display the error state by one ERR_LED.

Description of CANopen ERR_LED

Status	ERR LED	Description
No error	Off	The device is in working condition
Warning limit reached	Single flash	At least one of the error counters of the CAN controller has reached or exceeded the warning level (REC ≥ 96 or TEC ≥ 96)
Error control event	Double flash	A guard event or a heartbeat event has occurred
SYNC error	Triple flash	The SYNC message has not been received within the configured communication cycle period time
Bus off	On	The CAN controller has detected the “Bus OFF” status

The following table shows how to display the running state by RUN_LED.

Description of CANopen RUN_LED

Status	RUN LED	Description
PRE-OPERATIONAL	Blinking	The device is in state PRE-OPERATIONAL
STOPPED	Single flash	The device is in state STOPPED
OPERATIONAL	On	The device is in state OPERATIONAL

[NOTE]

The differences between “Blinking,” “Single flash,” “Double flash,” and “Triple flash” are distinguished by flashed rate of each indicator that is shown in the following figure.

Indicator states and flash rates

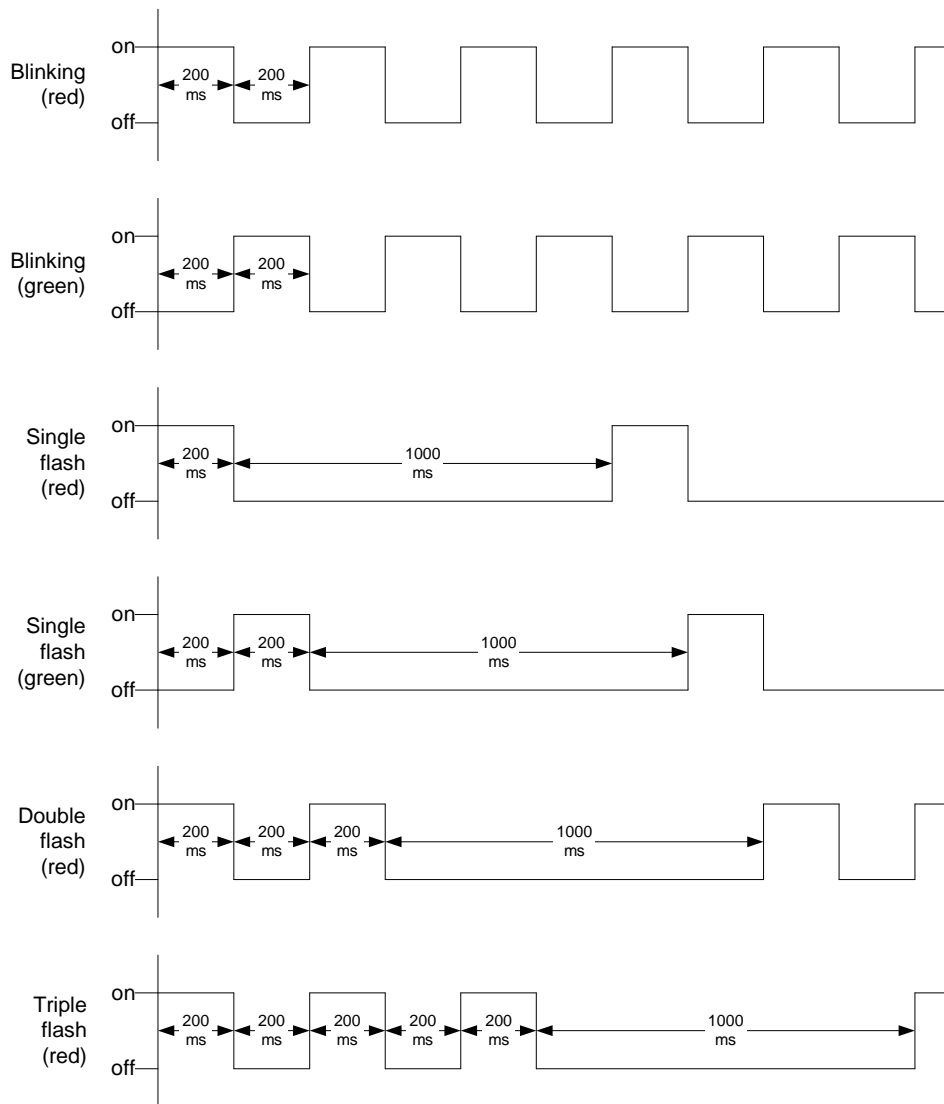

11.5 Node-ID

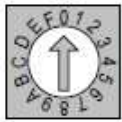

RSW2

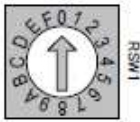

RSW1

Each drive within the CANopen network has to have a unique Node-ID number. Basically, Node-ID of this servo amplifier is decided by two pieces of 16 (0h to Fh) position rotary switch on the front panel of amplifier [from 1 (RSW2: 0h, RSW1: 1h) to 127 (RSW2: 7h, RSW1: Fh)].

If both rotary switches are set to “0h” or “Fh” position, the value that has already been stored in non-volatile memory by using R-SETUP – Setup Software or written via SDO (object index 2250h) becomes effective as Node-ID number.

If the setting of Node-ID is changed while the control power is ON, it is necessary to turn OFF the control power once or execute the “Reset node” command to activate the new set Node-ID number.

11.6 Bit rate (transmission baud rate) and bus length

Bit rate can change via R-SETUP – Setup Software or via SDO (object index 2251h).

Selectable bit rate and maximum bus length depending on the bit rate are shown in the following table.

If the setting of bit rate is changed while the control power is ON, it is necessary to turn OFF the control power once or execute the “Reset node” command to activate the new set bit rate.

Bit rate and bus length

Bit rate	Max. bus length	Bit rate code
1 Mbps	25m	8
800 kbps	50m	7
500 kbps (factory default)	100m	6
250 kbps	250m	5
125 kbps	500m	4
(100 kbps; not supported)	---	3 (cannot be selected)
50 kbps	1000m	2
20 kbps	2500m	1
10 kbps	5000m	0

The bit rate must be the same for all units in one network.

11.7 About EDS file and the revision level of servo amplifier

The revision level of the servo amplifier's communication firmware may change without prior notice. This section explains about the EDS file provided on the homepage, for this case.

Description of EDS file

File name	sanyo_rco.eds
Revision level of amplifier	Rev. E or later
Version of communication firmware	Ver. 000B or later

- Even after change of the revision level of the servo amplifier, the existing functions will not be changed and the EDS file will be still available as before.

How to confirm the revision level of servo amplifier

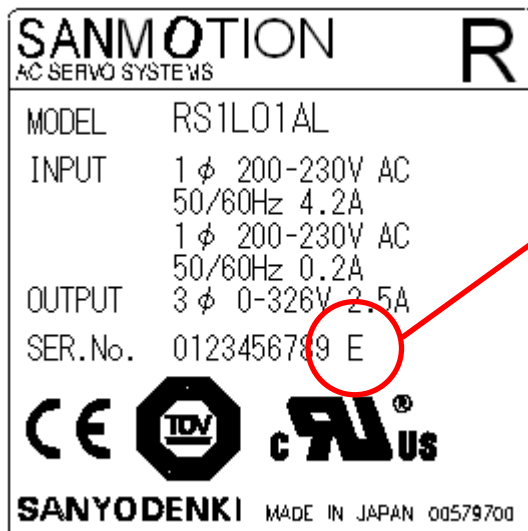

- Find a label on the back of the servo amplifier.
- This letter indicates the revision level of the servo amplifier.

How to confirm the version of communication firmware

- Read out the object 100Ah (software version) via SDO communication.
- “V.**-□□” will be read out in the ASCII code. “□□” indicates the version of the communication firmware. If it is “0B”, it means “Ver. 000B.”